

UGOKI
International



UGOKI INTERNATIONAL

Address: Moh Muhammad Pura
P.O Khas Ugoki, Sialkot-Pakistan
Tel: +92- 523-513380
Whatsapp: +92-337-4950100
E-Mail: info@ugokiintl.com
Web: www.ugokiintl.com

Percussion Hammers & Aesthesiometers



UG-001
TROEMNER
Size: 245 mm

1/2



UG-002
DEJERINE
Size: 200 mm

1/2



UG-003
DEJERINE
With Needle
Size: 210 mm

1/2



UG-004
TAYLOR
Size: 195 mm

1/2

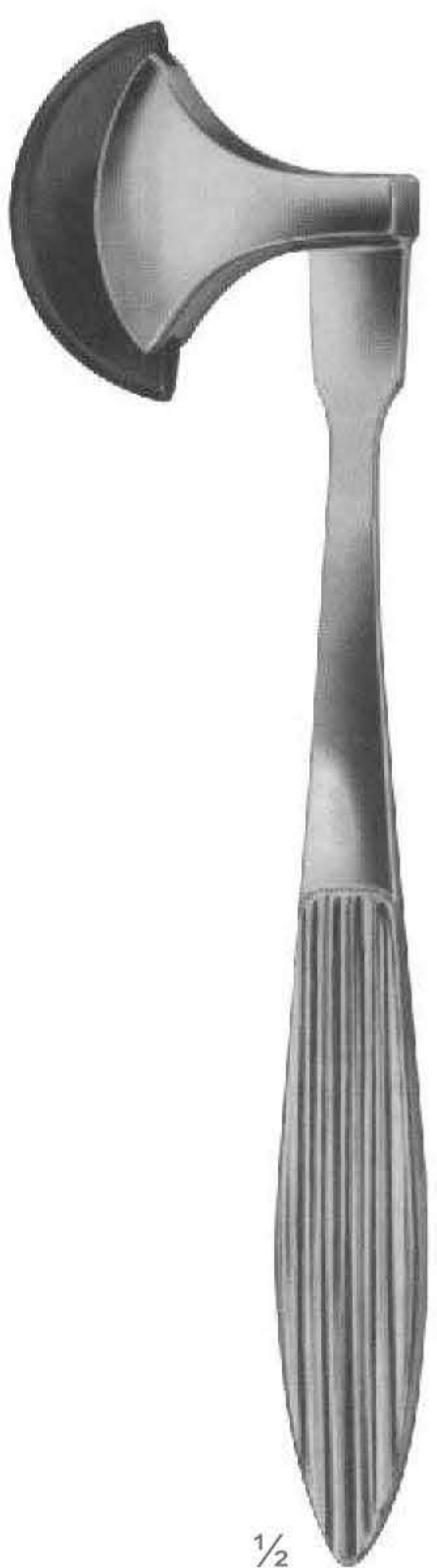

UG-005
BERLINER
Size: 200 mm

1/2

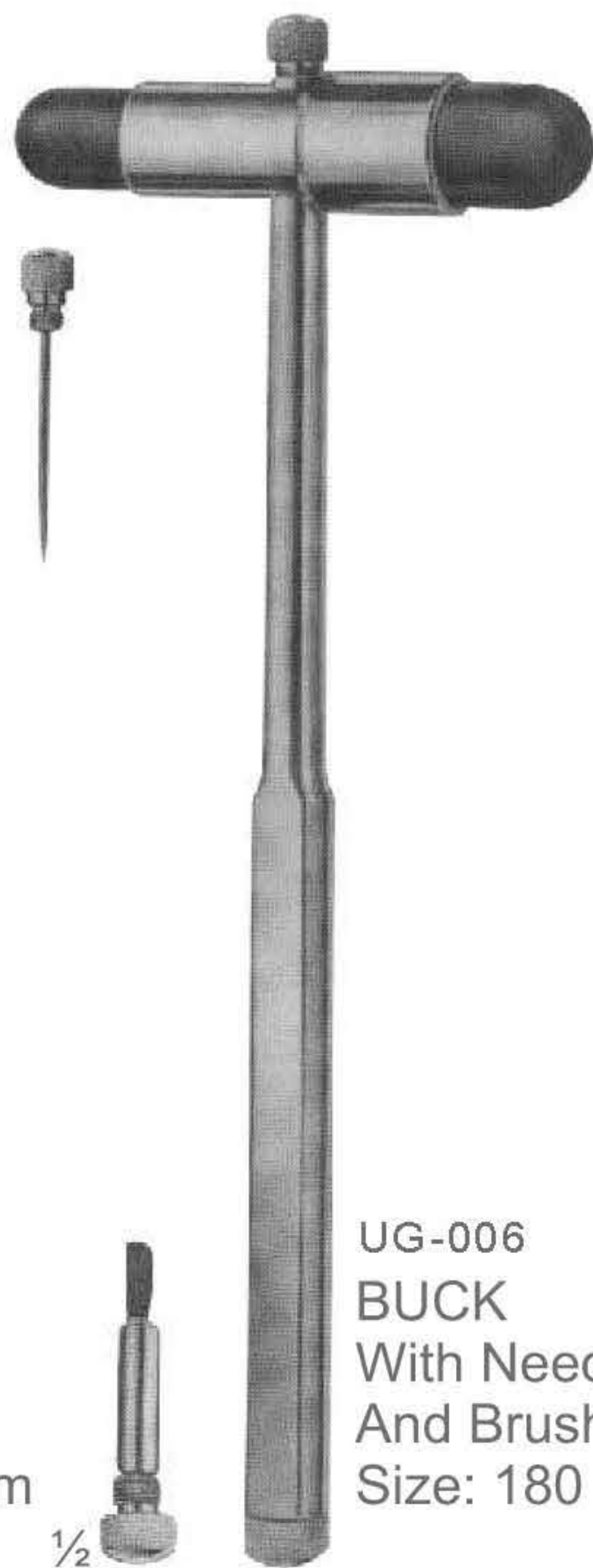

UG-006
BUCK
With Needle
And Brush
Size: 180 mm

1/2

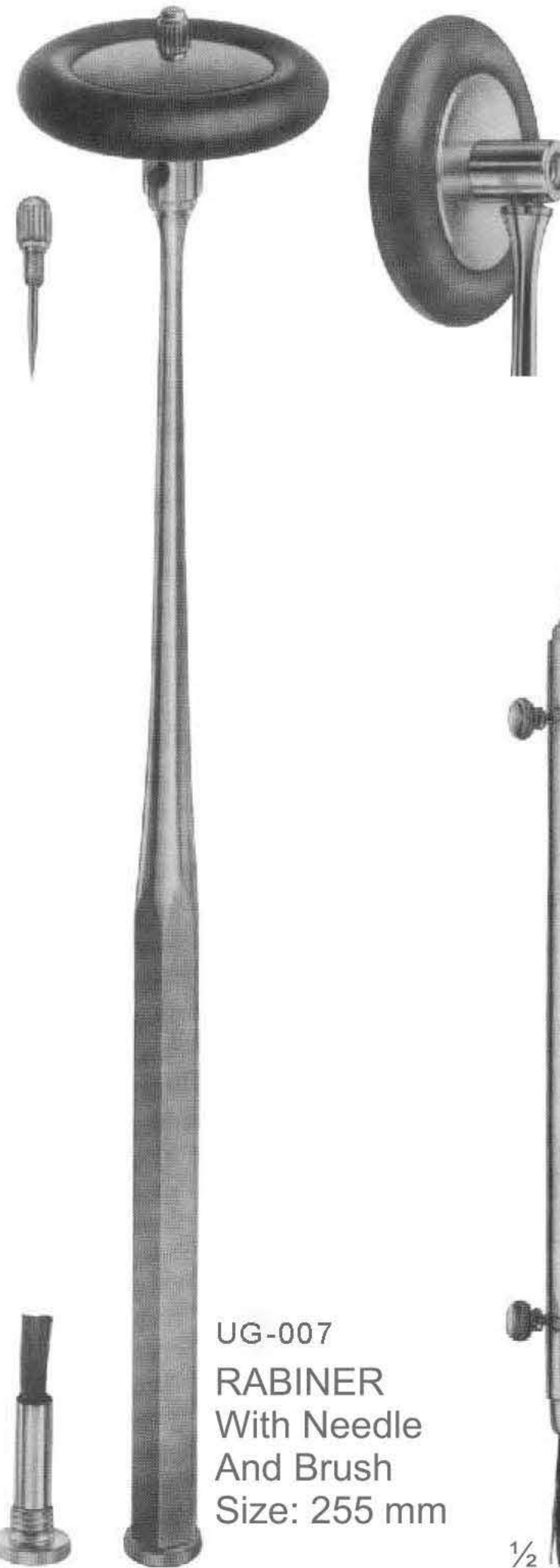

UG-007
RABINER
With Needle
And Brush
Size: 255 mm

1/2



UG-008
ALY
Size: 190 mm

1/2

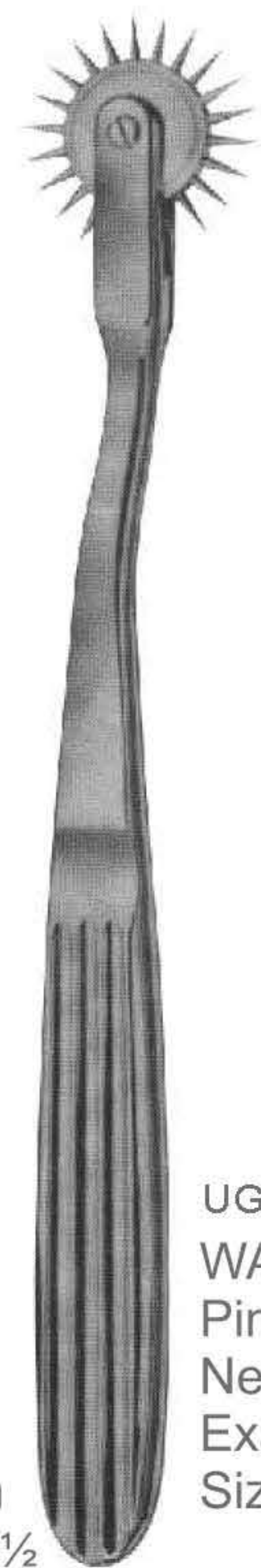

UG-009
WARTENBERG
Pinwheel For
Neurological
Examination
Size: 185 mm

1/2

Stethoscopes

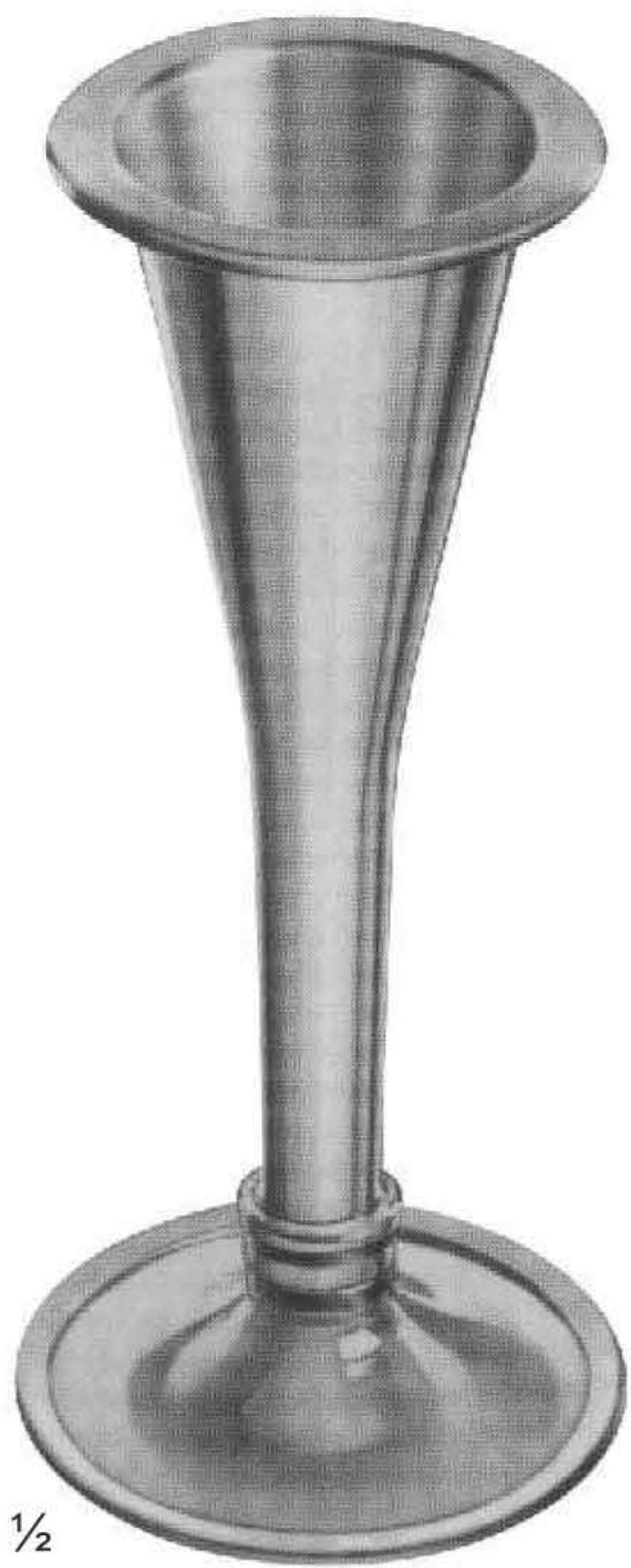

01-110
PINARD (Aluminum)
Size: 155 mm

1/2



01-111
aus Holz (Wooden)
Size: 145 mm

1/2



01-112
BOWLES
Stethoscope
With Diaphragm

1/4

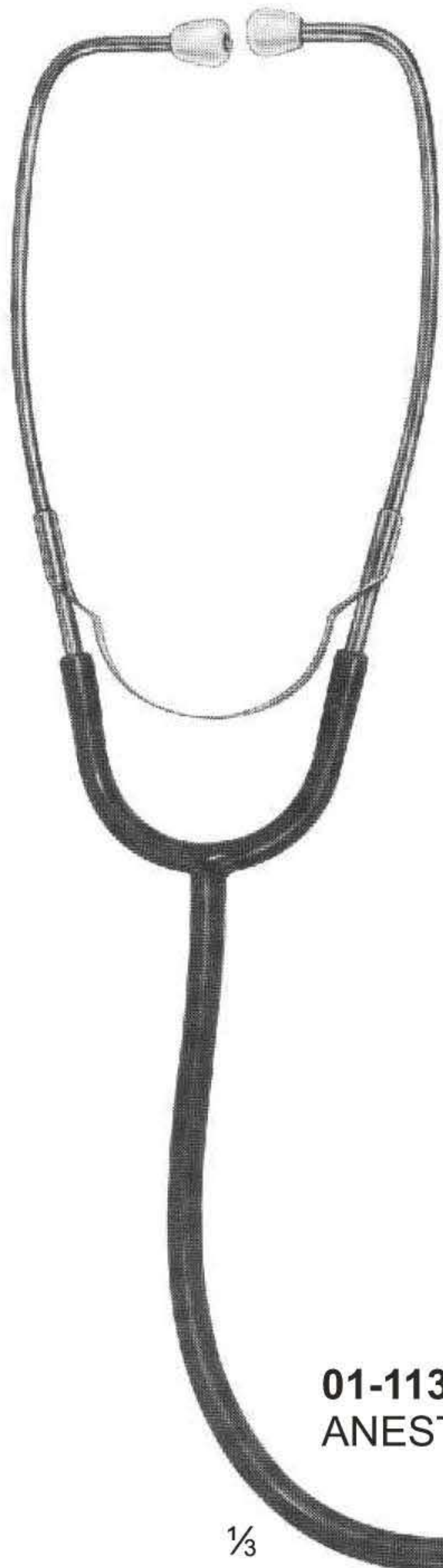

01-113
ANESTOPHON

1/3

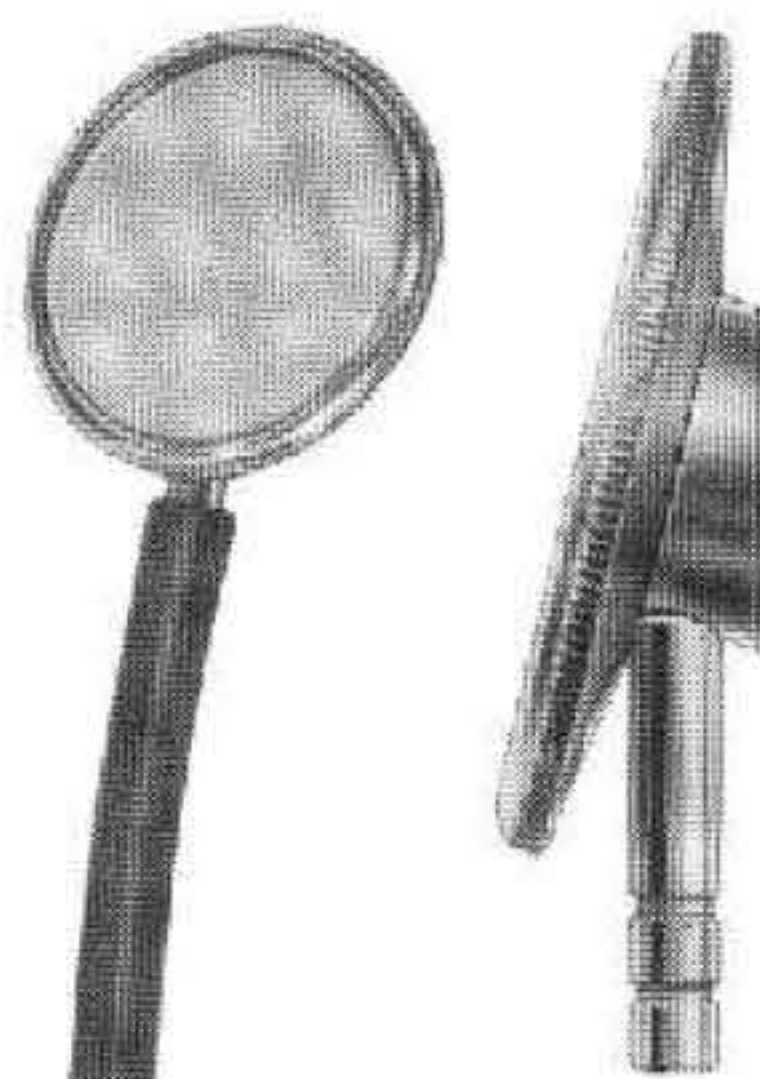

01-114
FORD-BOWLES
Duel Chest Piece
With Two Outlets

1/4



UG-008
BOWLES
Size: With
Needle

1/4

Head Mirrors & Head Bands



UG-009
ZIEGLER \varnothing mm
Head mirror only
with rubber coating

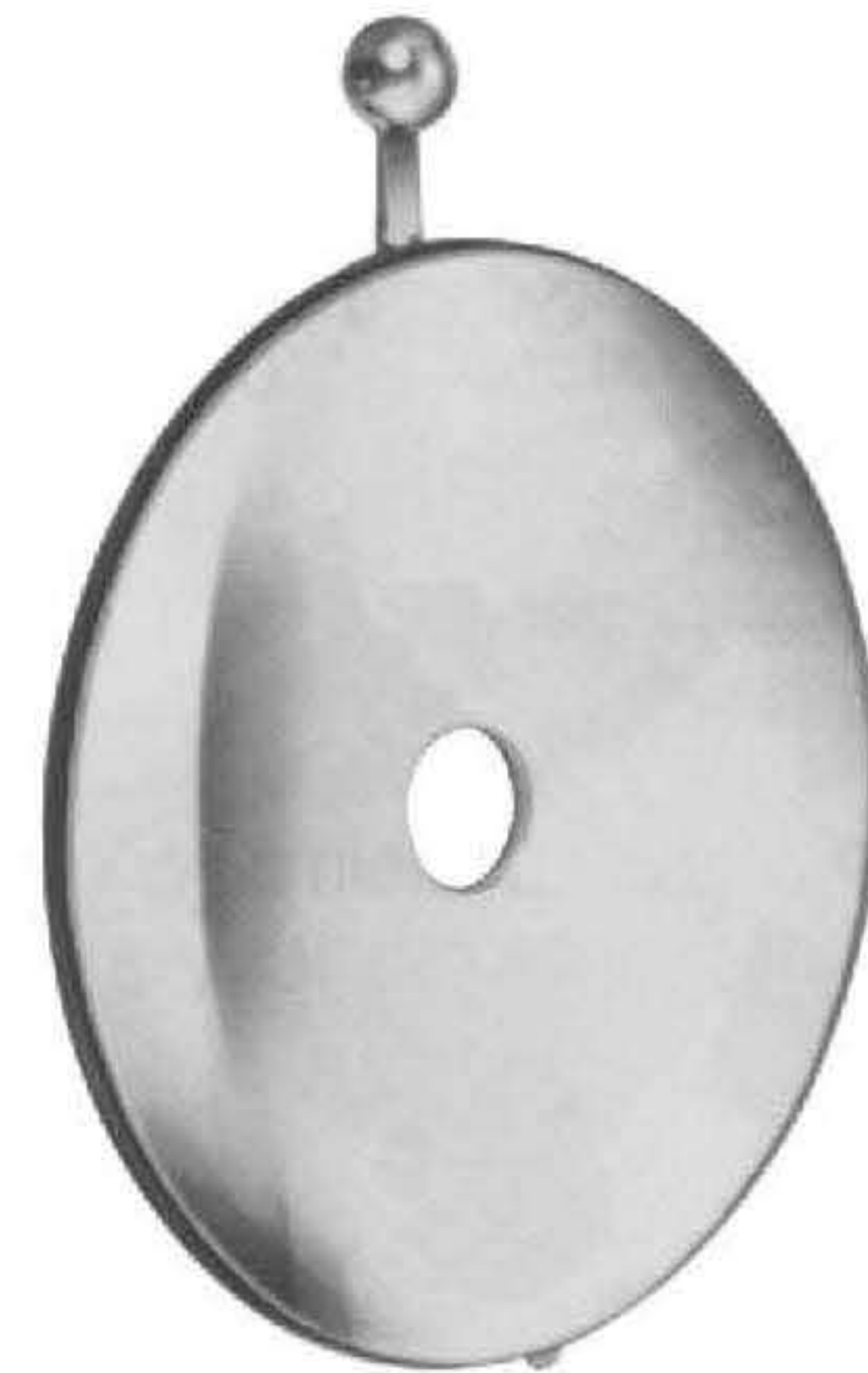

UG-010
ZIEGLER \varnothing mm
Head mirror only
with metal coating



UG-011
ZIEGLER
Head band of plastic black

UG-012
ZIEGLER
Head band of plastic white

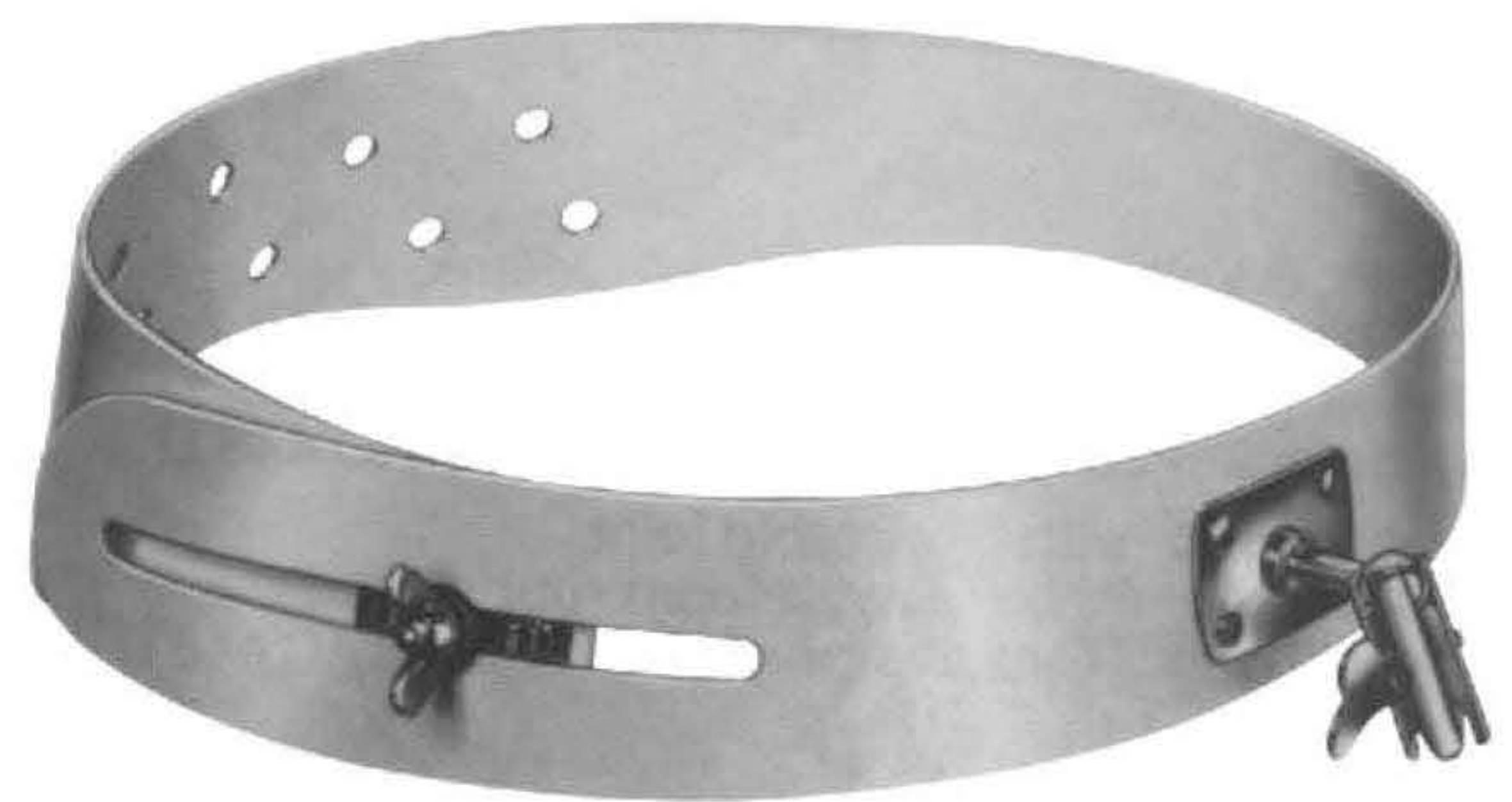

UG-013
MURPHY
Head band of celluloid, white

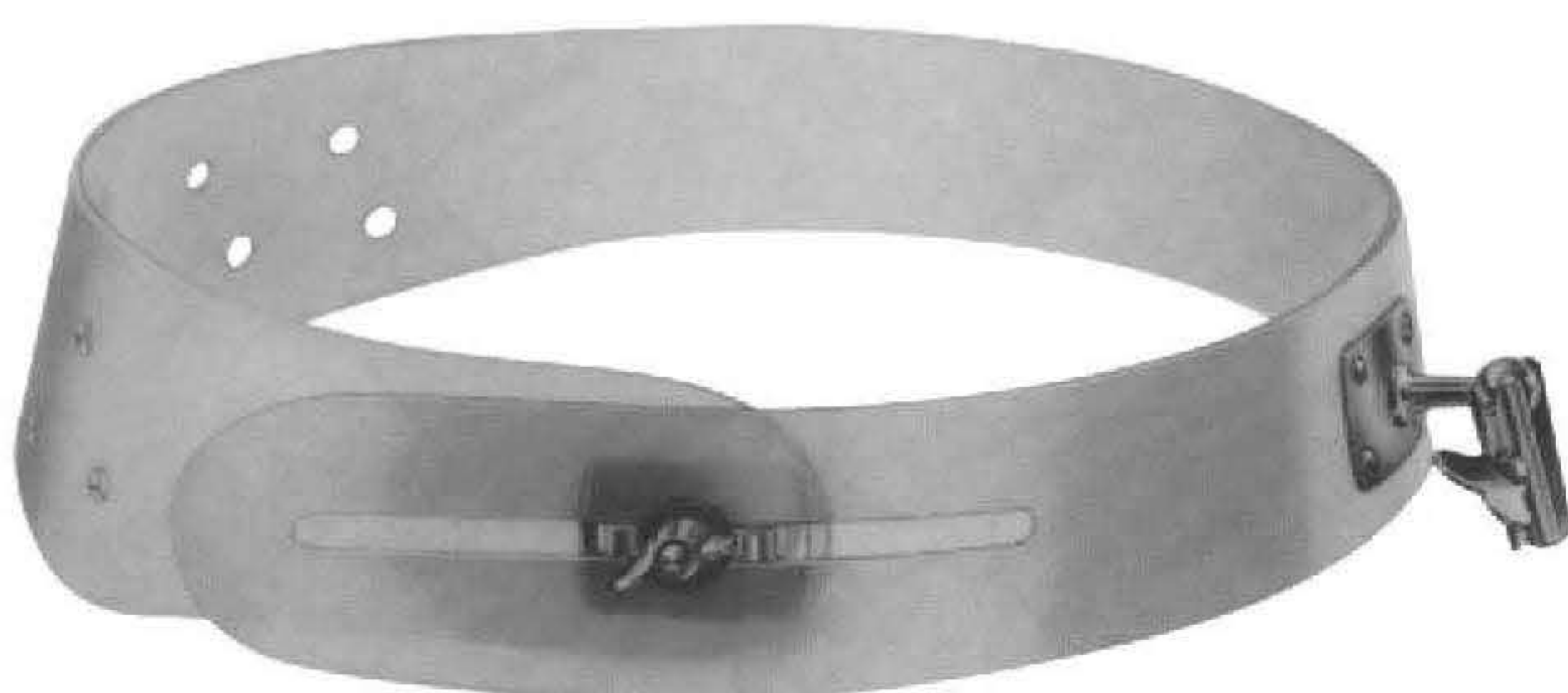

UG-014
Head band of plastic,
white, soft pattern



UG-015
Head mirror with black
plastic head band.

Head Light

UG-016

CLAR

Head light, 6 volt, with adjustable joint,
white celluloid head band,
cord with plugs for transformer

UG-017

White celluloid head band, only, for

UG-018

Spare mirror only, for



UG-019

CLAR

Head light, 6 volt, with adjustable joint,
white celluloid head band, with foam rubber pad
and cord with plugs for transformer

UG-020

White celluloid head band, only, for head light

UG-021

mirror only, for head light

spare foam rubber pad, for head band



UG-023

CLAR

Head light, 6 volt, with adjustable joint,
white plastic head band,
cord with plugs for transformer



Tongue Depressors

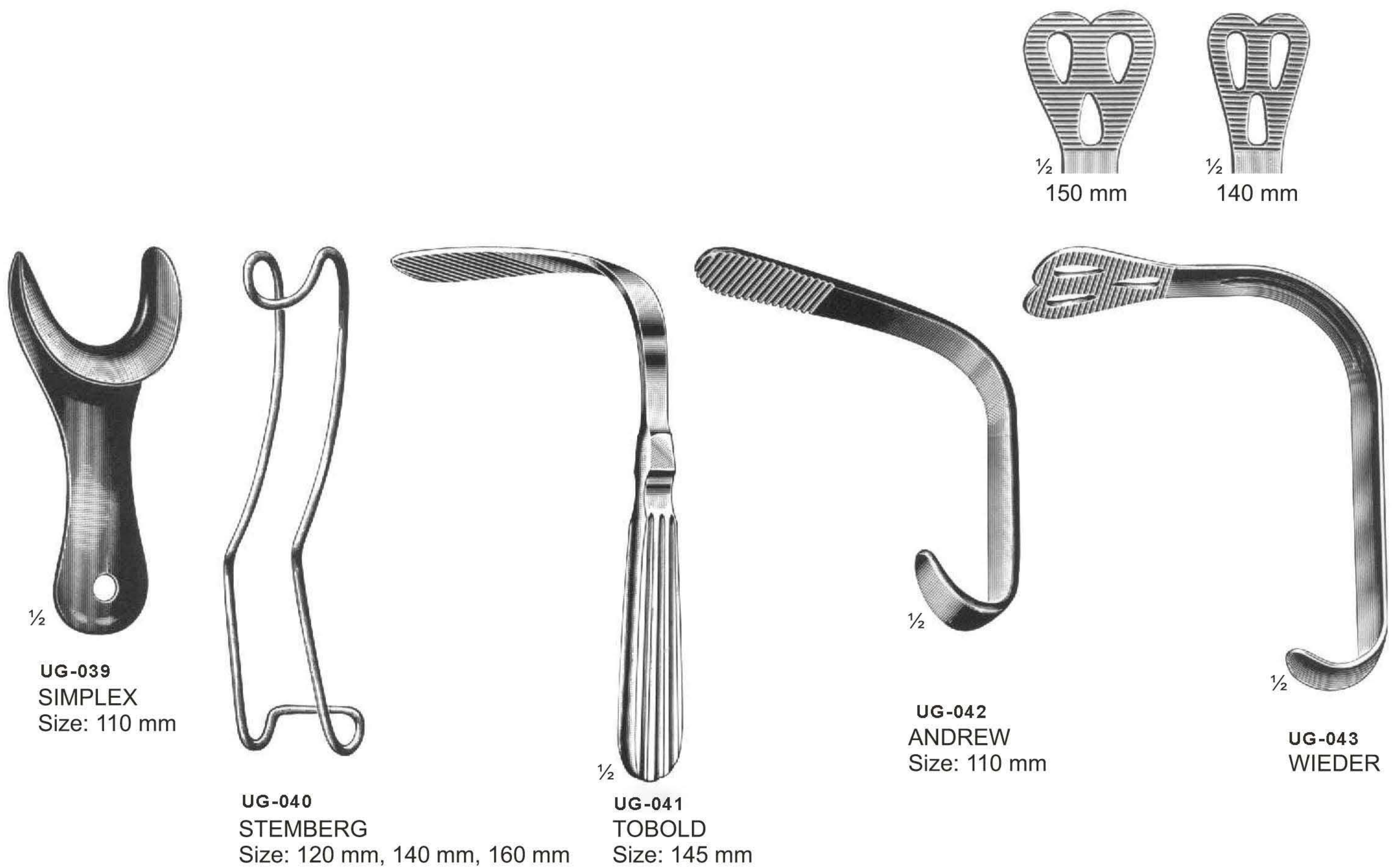
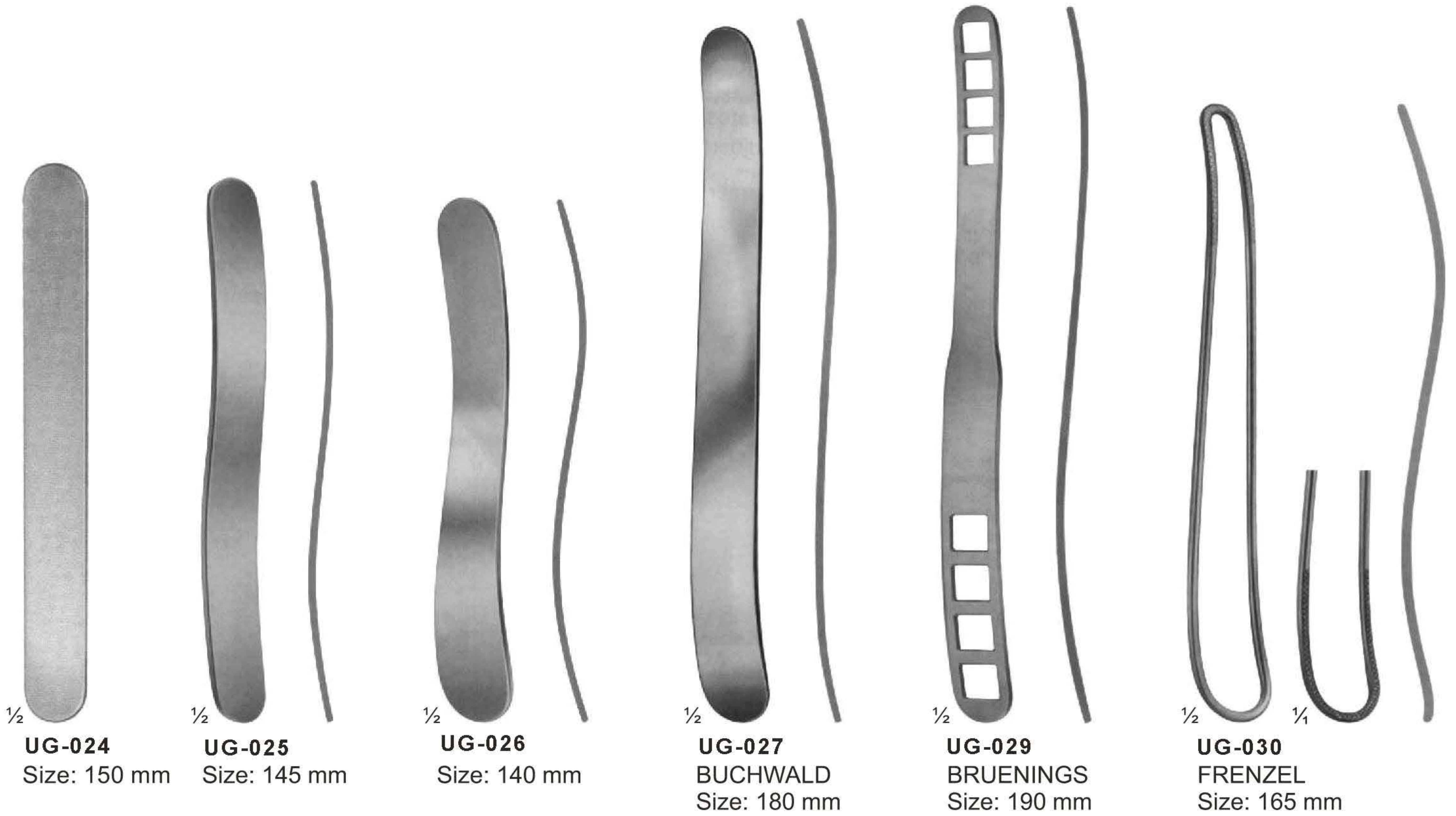

Tongue Depressors



1/2

UG-034
SCHIMMELBUSCH
Ether Mask



1/2

UG-035
HEISTER
Mouth Gag
Size: 130 mm



1/2

UG-037
FERGUSSON-ACKLAND
Mouth Gag
Size: 145 mm



1/2

UG-038
DENHARDT
Mouth Gag With Silicon
Inserts, Interchangeable
Size: 125 mm



1/2

UG-039
ROSER KONIG
Mouth Gag
Size: 160 mm, 185 mm

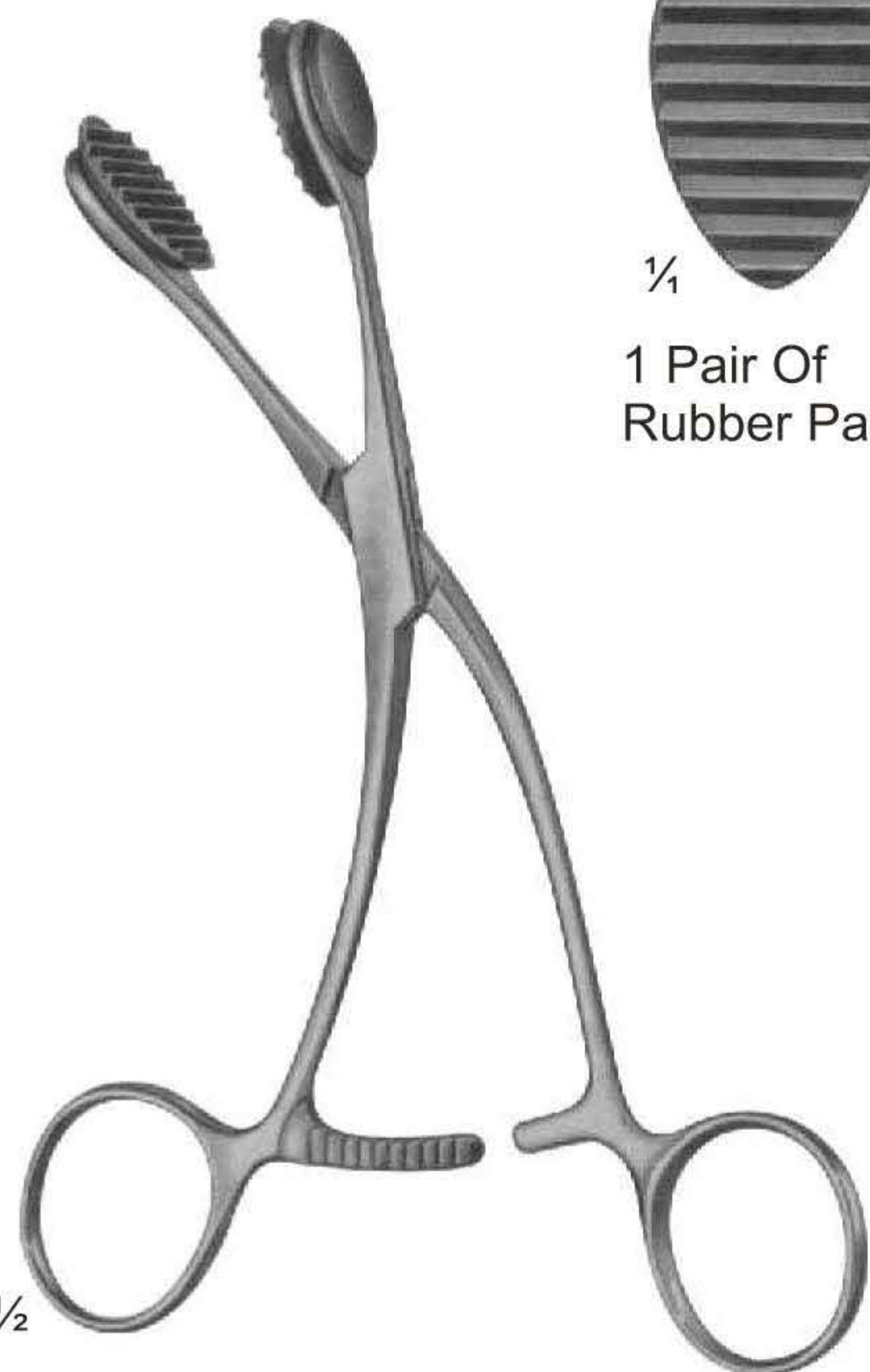

1/2

UG-040
YOUNG
Size: 165 mm



1/4

1 Pair Of
Rubber Pads

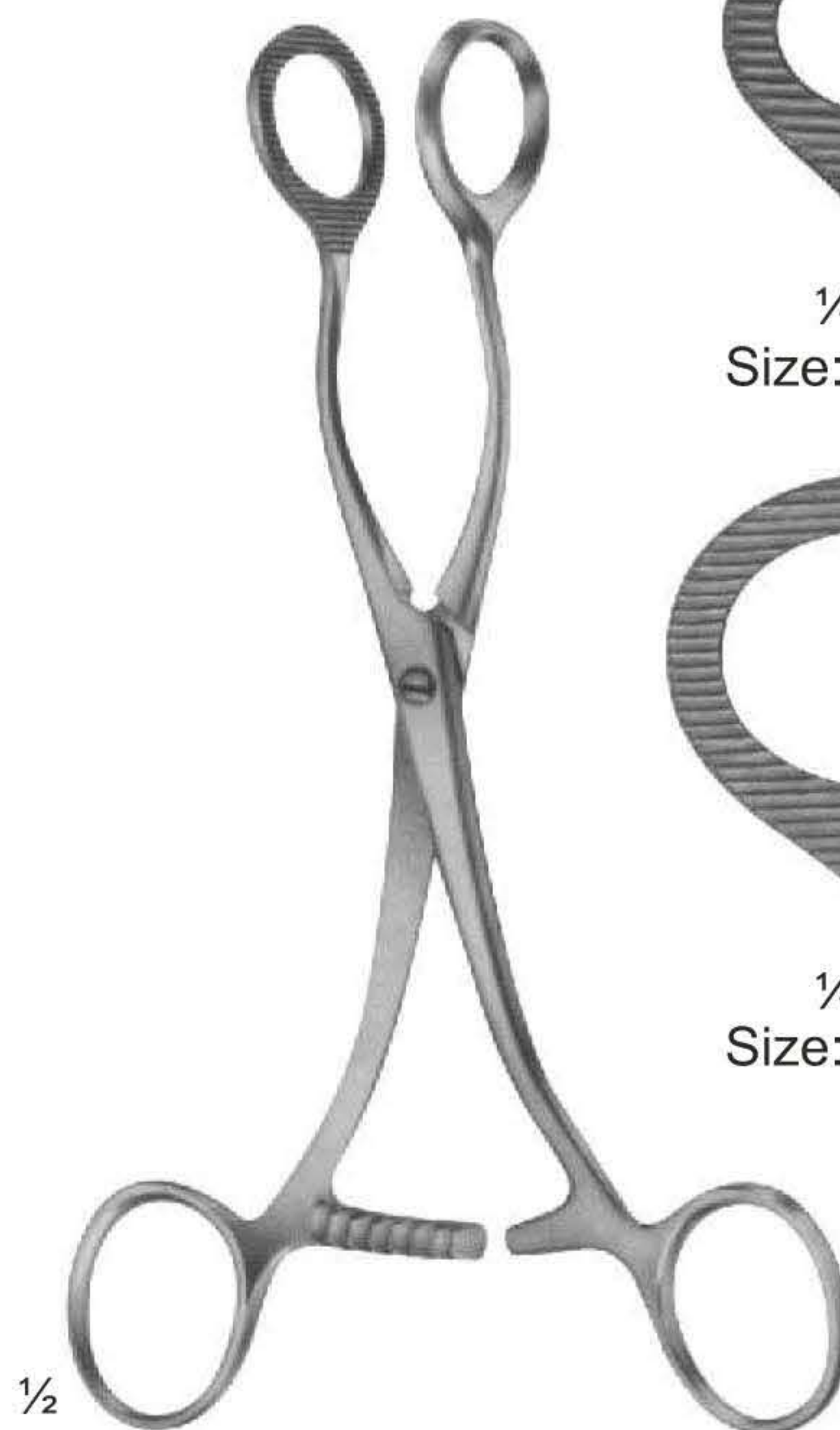

1/2

UG-041
COLLIN
Size: 160 mm, 170 mm



1/4

Size: 160 mm



1/4

Size: 170 mm

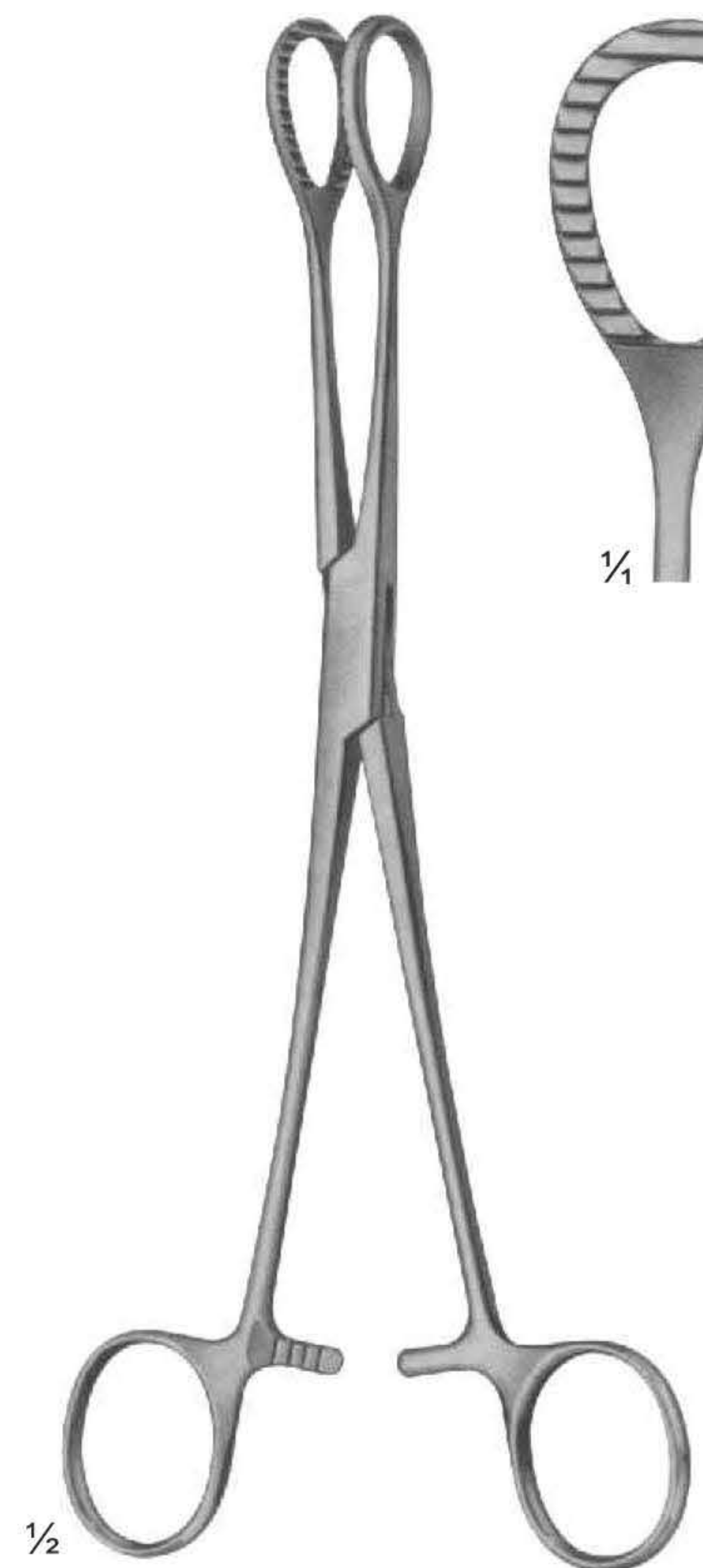

1/2

UG-042
HEYWOOD-SMITH modif.
Size: 215 mm



1/4

Blood Lancets & Laryngeal Mirrors



UG-044
FRANCKE
Automatic Blood Lancet



UG-045
KOLLE
Microscopic Needle Holder
With Plastic Handle
Size: 240 mm

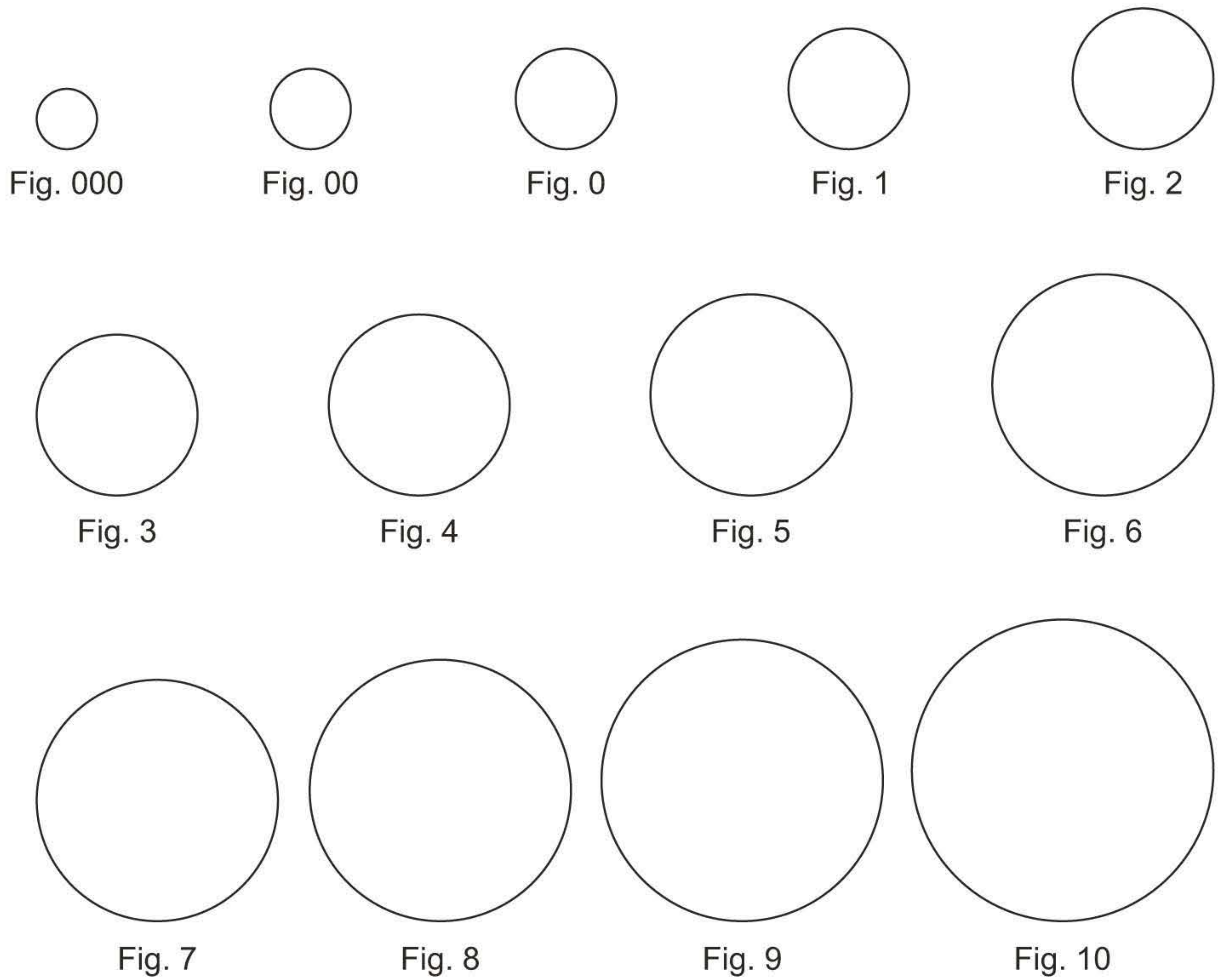

UG-047
Laryngeal Mirrors With
Hexagonal Handle
Size: 180 mm



UG-048
Mirror Handle
Size: 110 mm



UG-049
Mirror Handle
Size: 105 mm



UG-050
MICHEL
Rhinoscopic Mirrors With
Interchangeable Mirror Inserts
Size: 250 mm



UG-058
Spare Mirrors Only
Size: 12 mm



UG-059
Spare Mirrors Only
Size: 14 mm

Diagnostic Sets



UG-078
MAGILL



UG-060
Infants
Size: 150 mm



UG-061
Children
Size: 200 mm



UG-062
Adults
Size: 250 mm



UG-079
Medium battery handle
only, 25 mm diam.



UG-063-A
Spare bulb
2.7 volt, for
otoscopes



UG-063-B
Spare bulb
2.6 volt, for
ophthalmoscopes



UG-080
Otoscope Set, Consists Of
Battery Handle Without Batteries,
3 Ear Specula, 1 Bulb In Velvet Lined Case



UG-081
Diagnostic Set, Otoscope With Three Specula,
Nasal Speculam, Lamp Holder, Two Laryngeal
Mirrors, Tongue Blade Holder

Diagnostic Sets



1/3

UG-082
MILLER
Laryngoscope Set, Consists Of Battery Handle (Without Battery)
With Four Miller Laryngoscope Blades



1/3

UG-083
GUEDEL-NEGUS
Laryngoscope Set, Consists Of Battery Handle (Without Battery)
With Four Miller Laryngoscope Blades

Diagnostic Sets



1/3

UG-084

McIntosh
Laryngoscope Set, Consists Of Battery Handle (Without Battery)
With Three McIntosh Blades, Fig. 1, Fig. 2, Fig. 3

UG-088

McIntosh
Laryngoscope Set, Consists Of Battery Handle (Without Battery)
With Five McIntosh Blades, Fig. 1, Fig. 2, Fig. 3, Fig. 4, Fig. 5

UG-091

FOREGGER
Laryngoscope Set, Consists Of
Battery Handle (Without Battery)
With Three Foregger Blades,
Fig. 1, Fig. 2, Fig. 3,

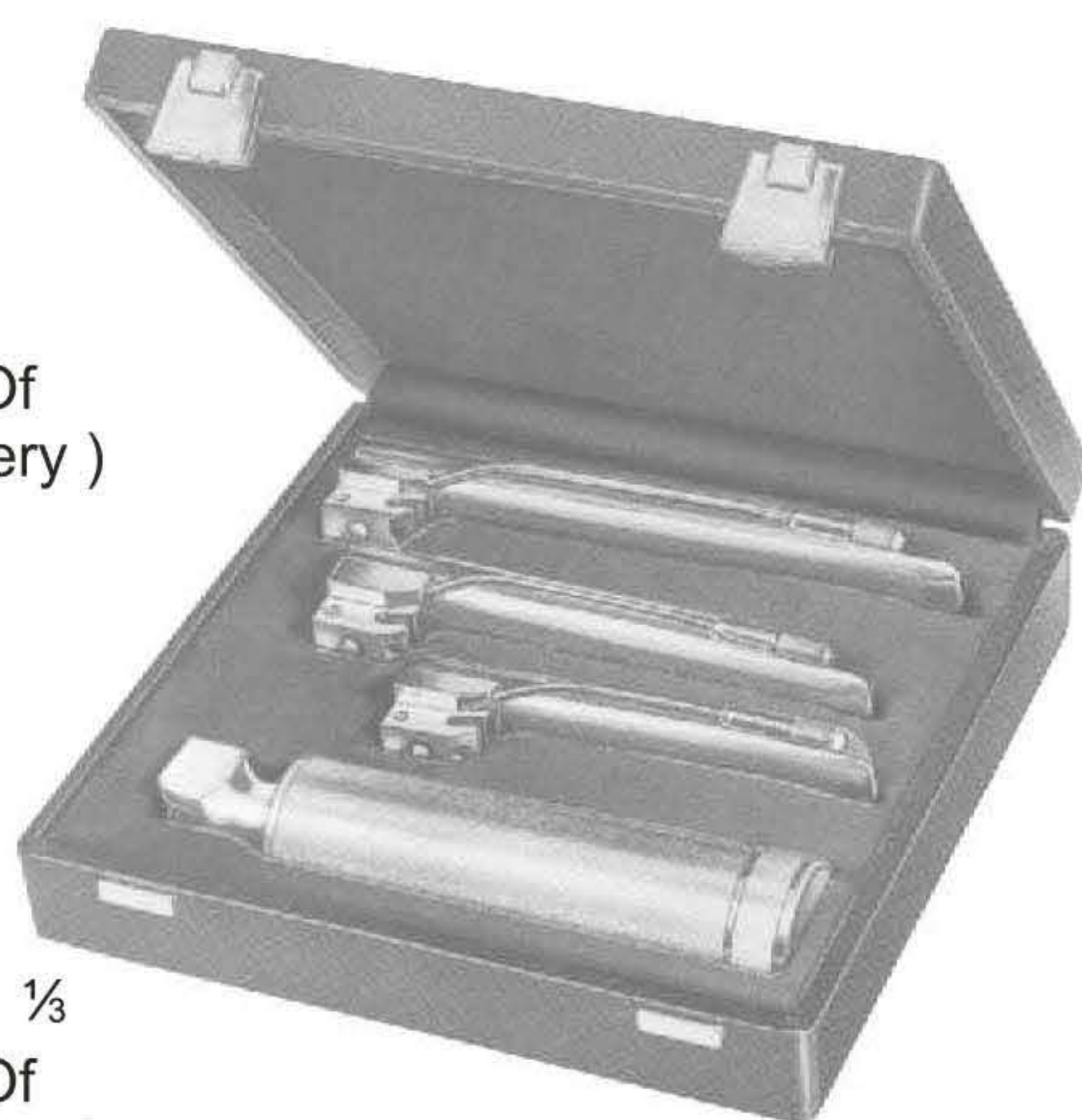

1/3

UG-093

FOREGGER
Laryngoscope Set, Consists Of
Battery Handle (Without Battery)
With Five Foregger Blades,
Fig. 1, Fig. 2, Fig. 3, Fig. 4, Fig. 5



1/2

UG-096
Fiber Optic
Battery Handle

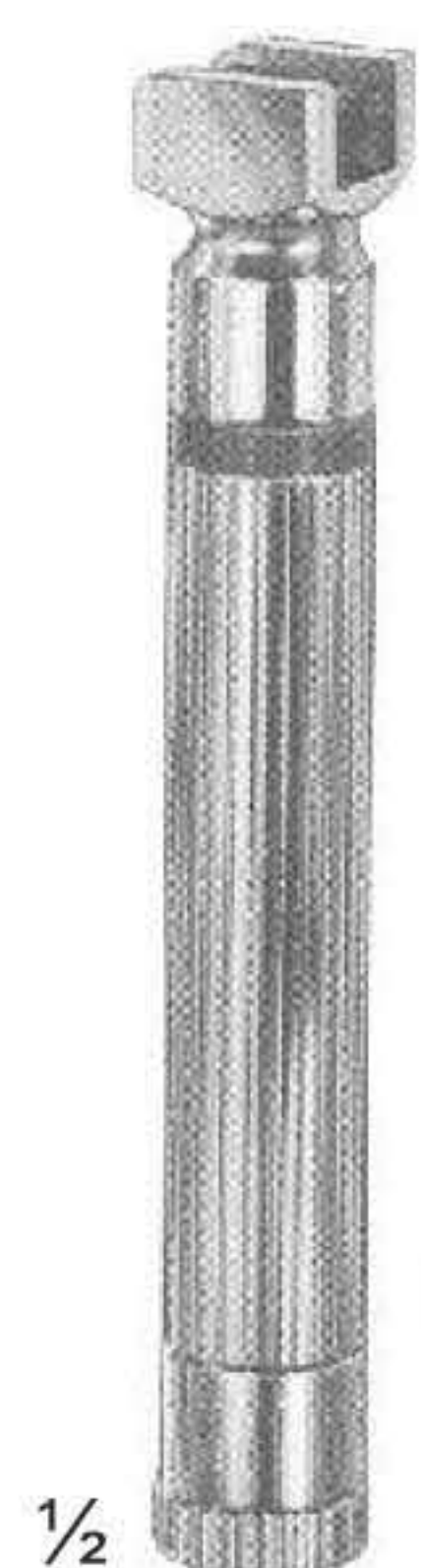

1/2

UG-098
Fiber Optic
Battery Handle

Suture Instruments - Reverdin Needles



UG-339
REVERDIN
140 mm



UG-340
REVERDIN
195 mm



UG-341
REVERDIN
220 mm

Suture Instruments - Ligature Needles

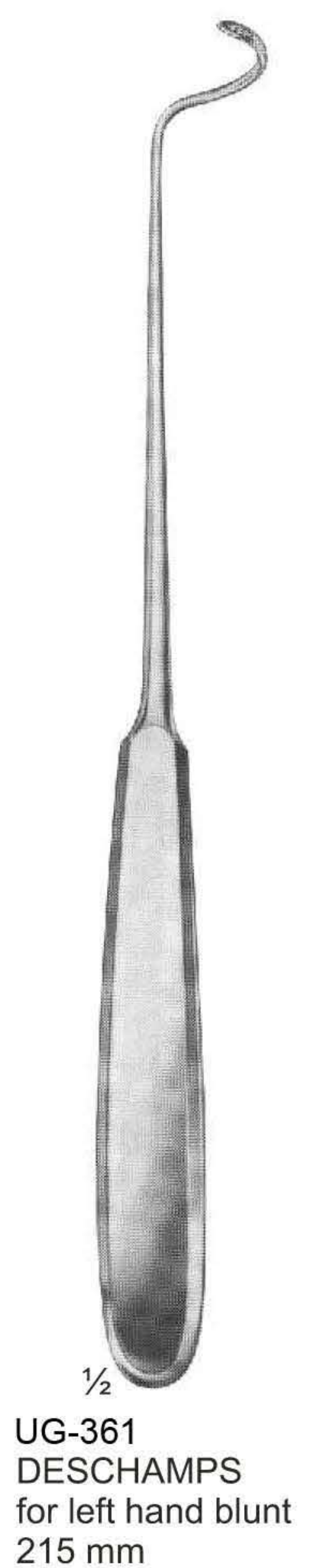
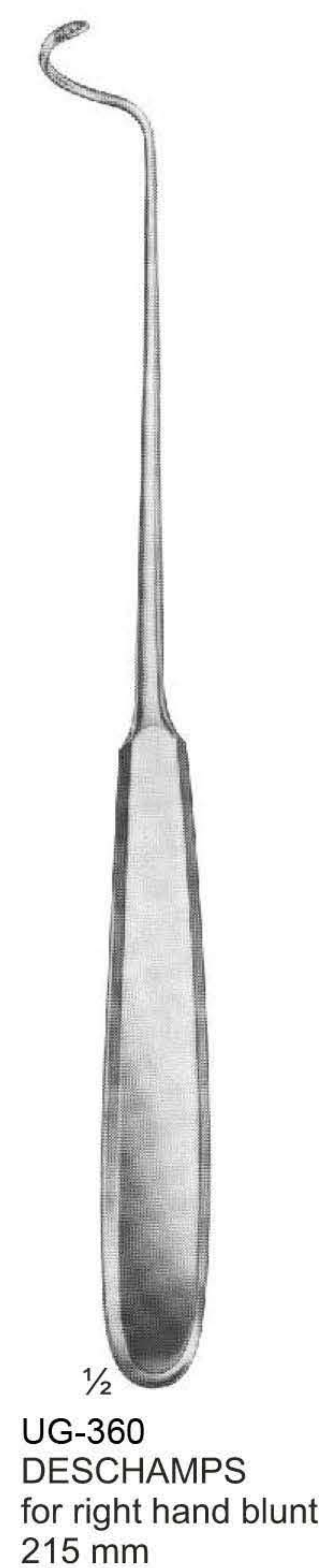
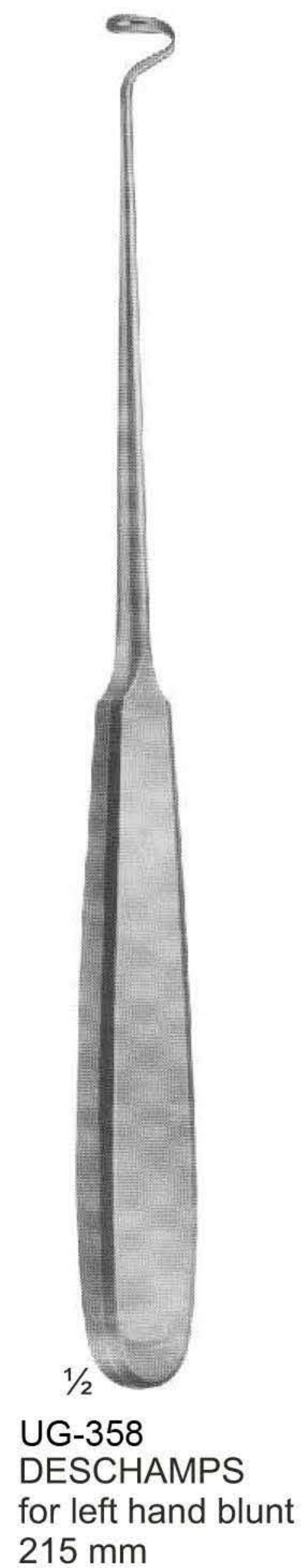
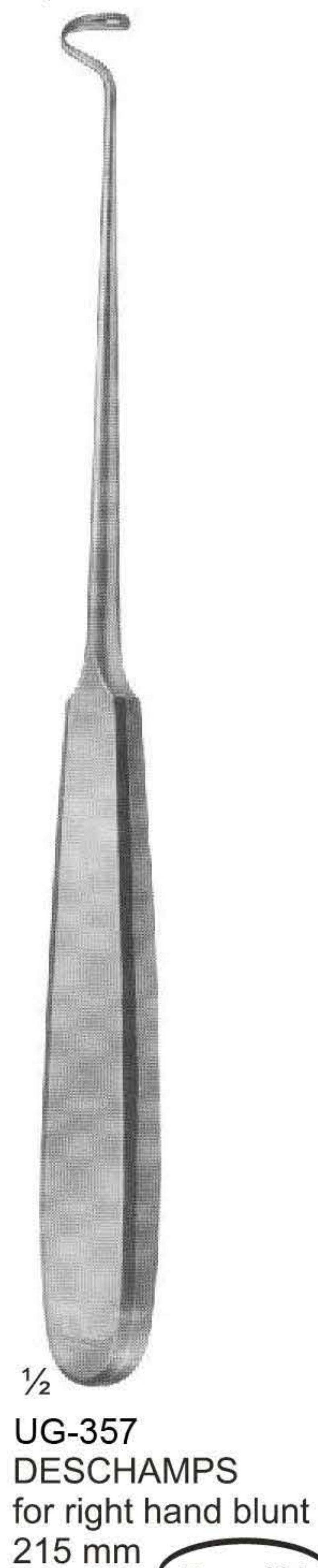
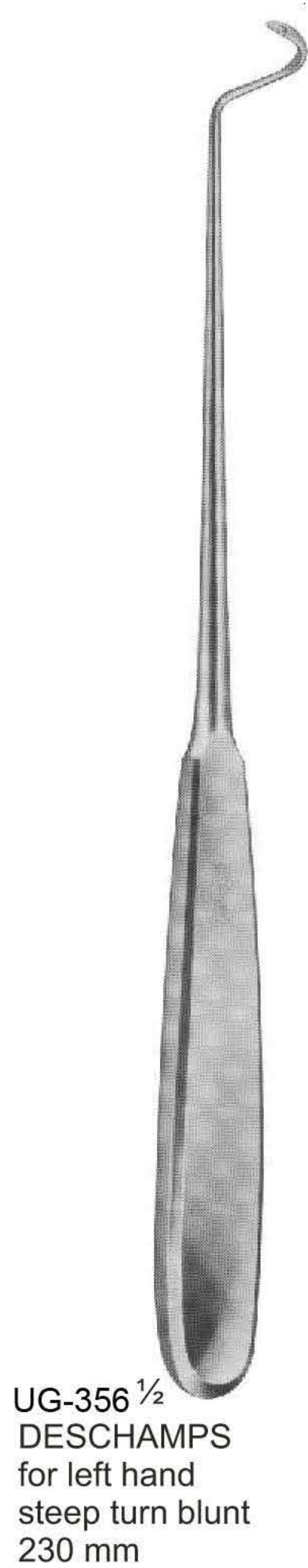
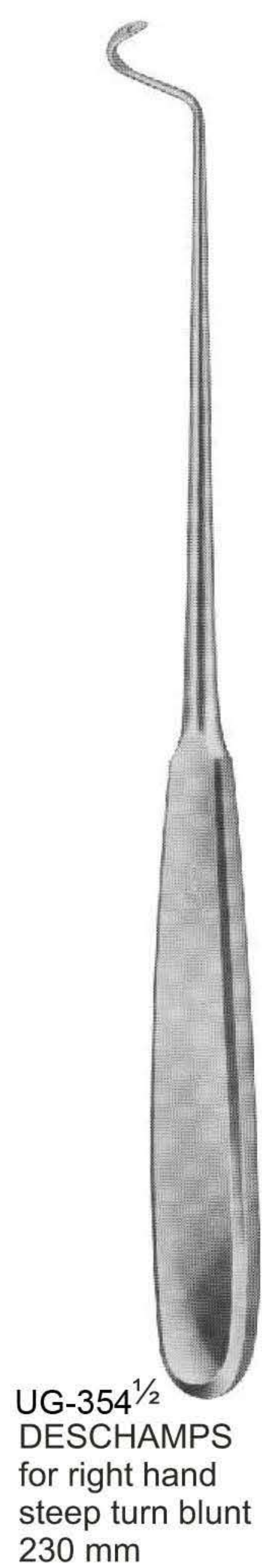
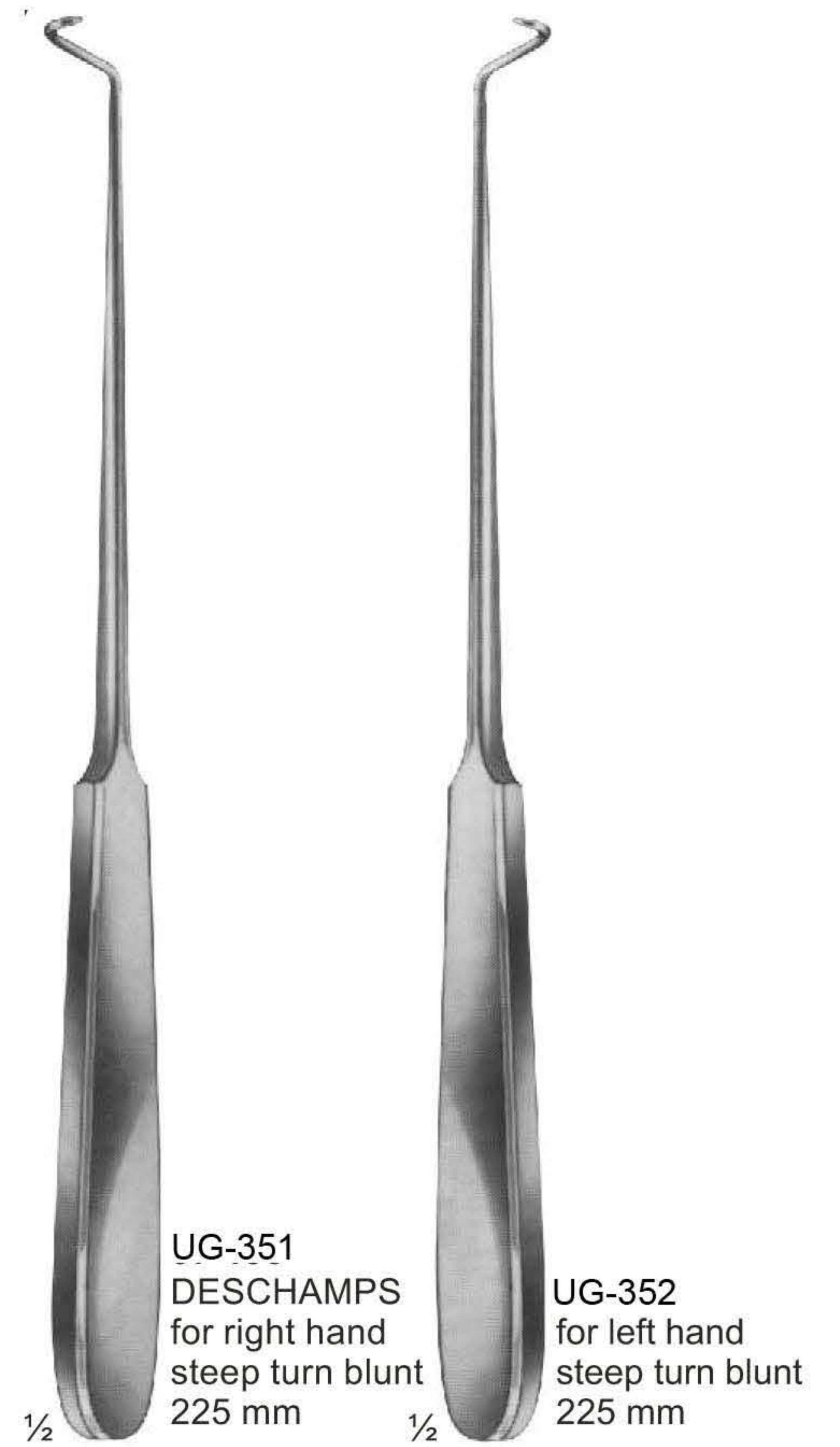
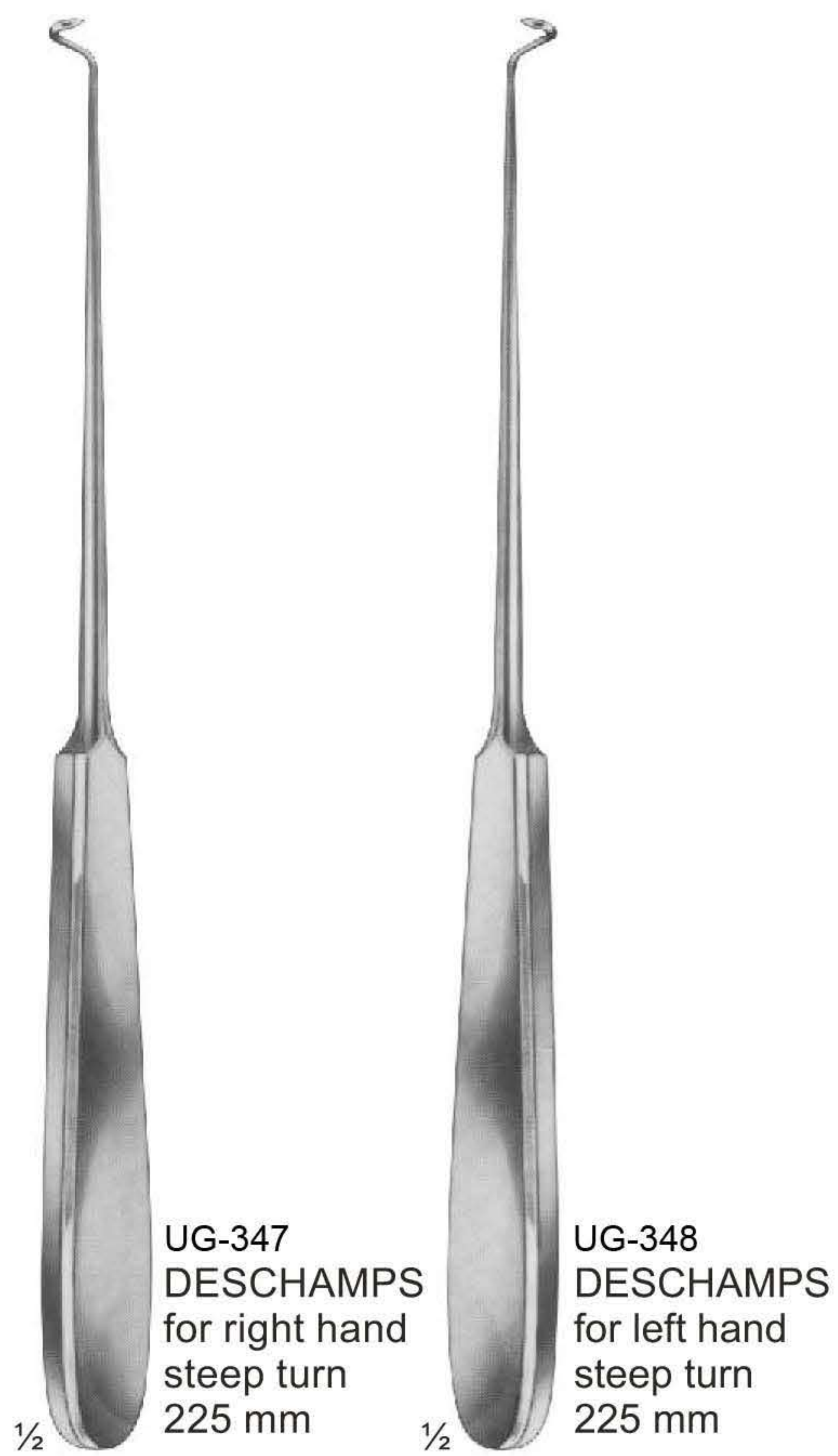

Suture Instruments - Ligature Needles



1/2
UG-368
HURD
for right hand
sharp
210 mm



1/2
UG-371
HURD
for left hand
sharp
210 mm



1/2
UG-372
DESCHAMPS
for right hand
sharp
215 mm



1/2
UG-373
DESCHAMPS
for left hand
sharp
215 mm



1/2
UG-374
JONESCO
Needle for wire suture
185 mm



1/2
UG-375
CLAUS VAN EICKEN
Needle for wire suture
250 mm



1/2
UG-376
150 mm



1/2
UG-377
SYME
170 mm



1/2
UG-378
COOPER
205 mm



1/2
UG-379
KOCHER
205 mm

Ligature Needles



UG-380
BRUNNER
240 mm

UG-381
SCHMIEDEN-DICK
320 mm

UG-382
BRUNNER
Guiding Probes
300 mm

Guiding Probes

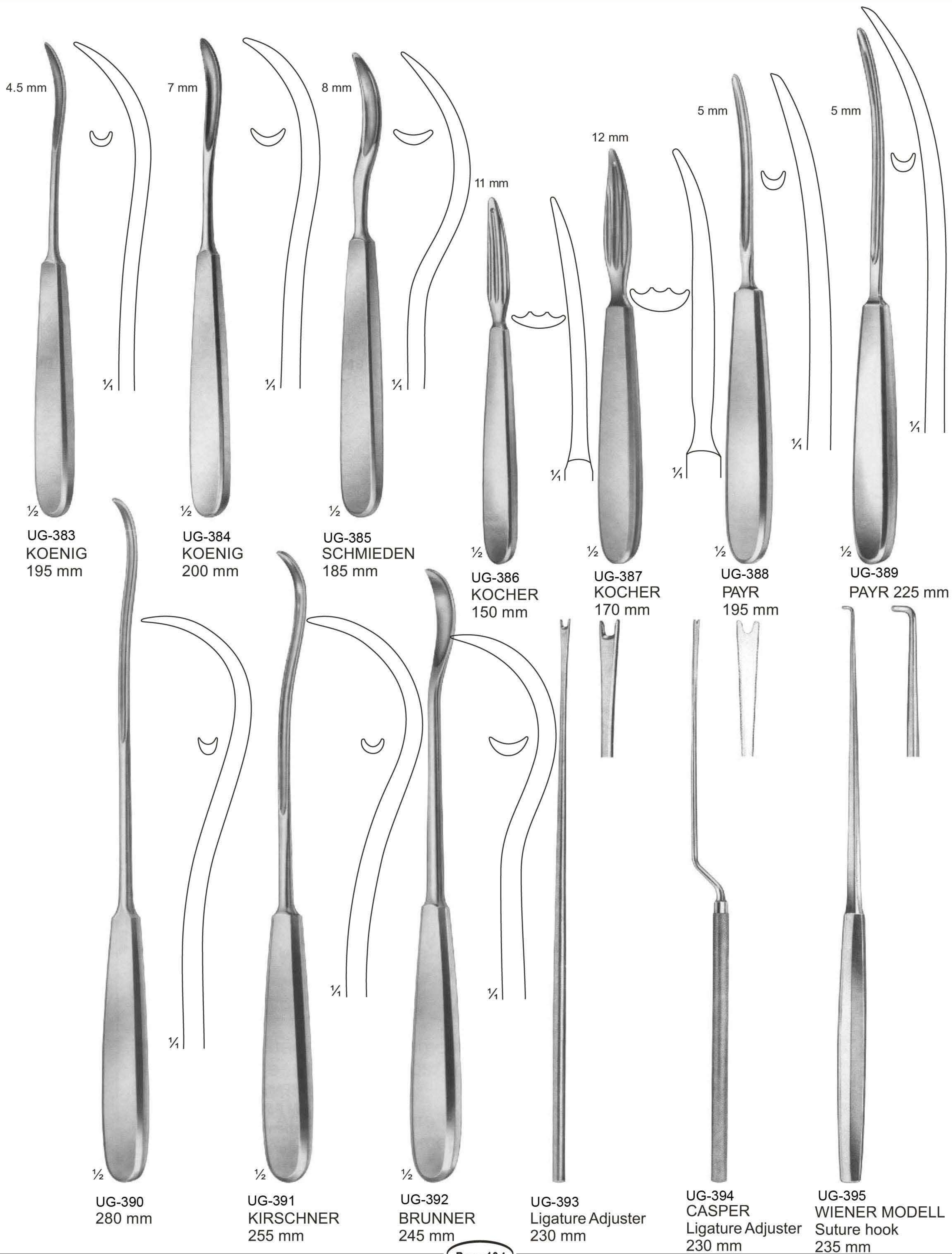

Suture Instruments - Reverdin Needles



UG-339
REVERDIN
140 mm



UG-340
REVERDIN
195 mm



UG-341
REVERDIN
220 mm

Suture Instruments - Ligature Needles

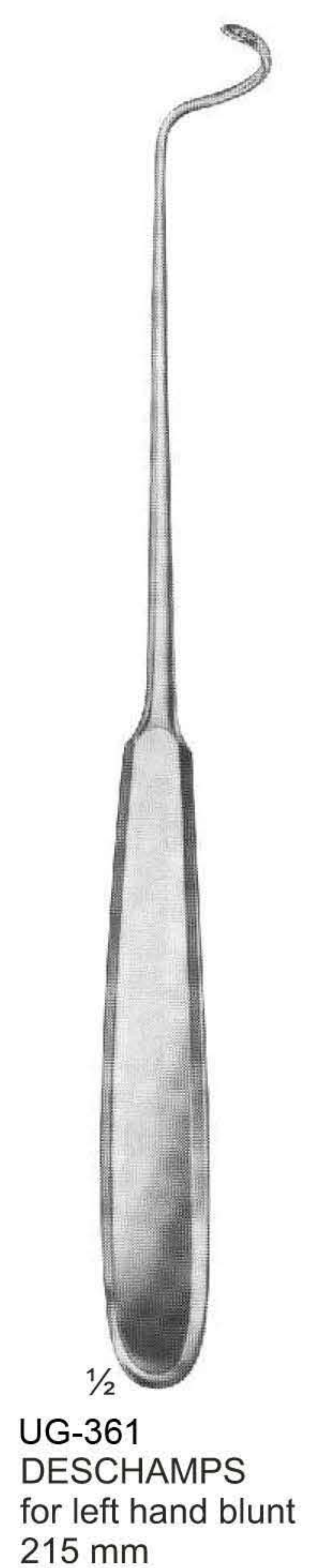
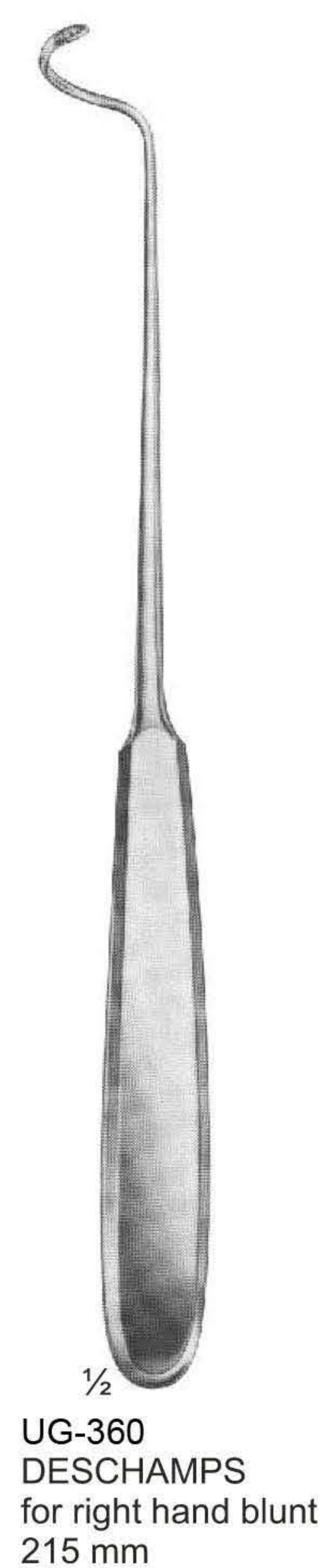
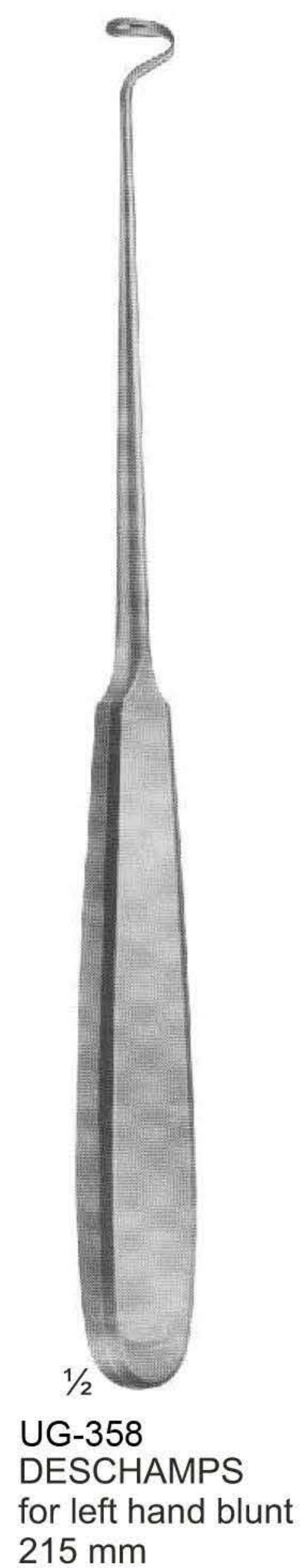
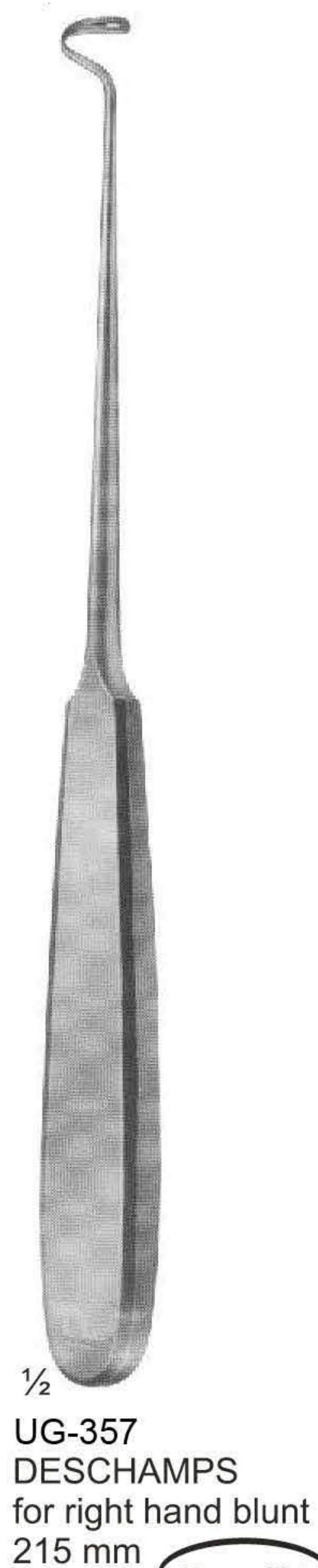
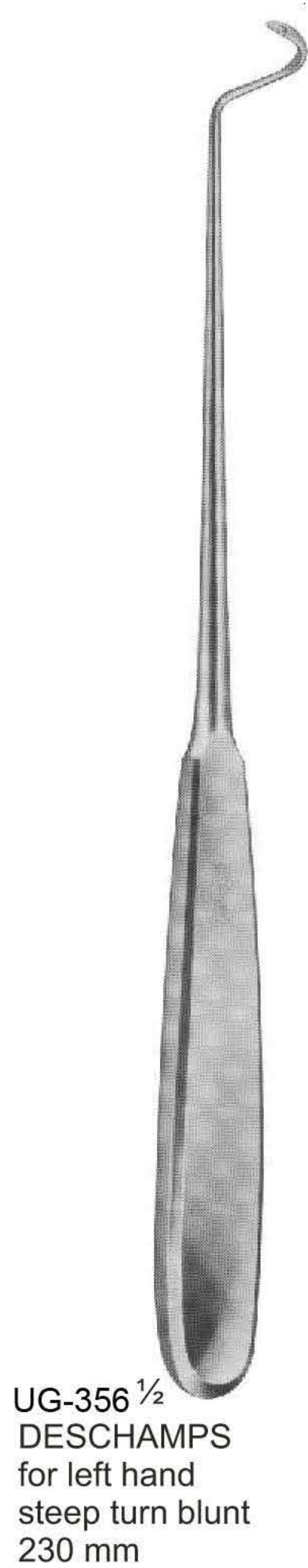
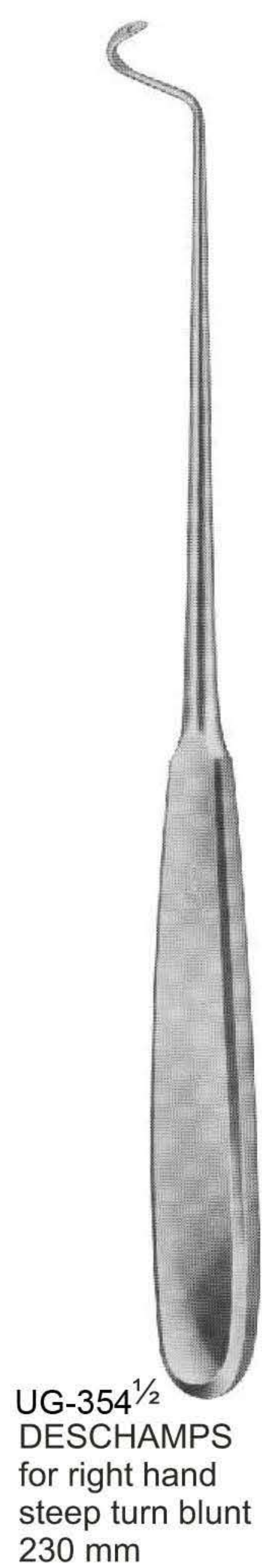
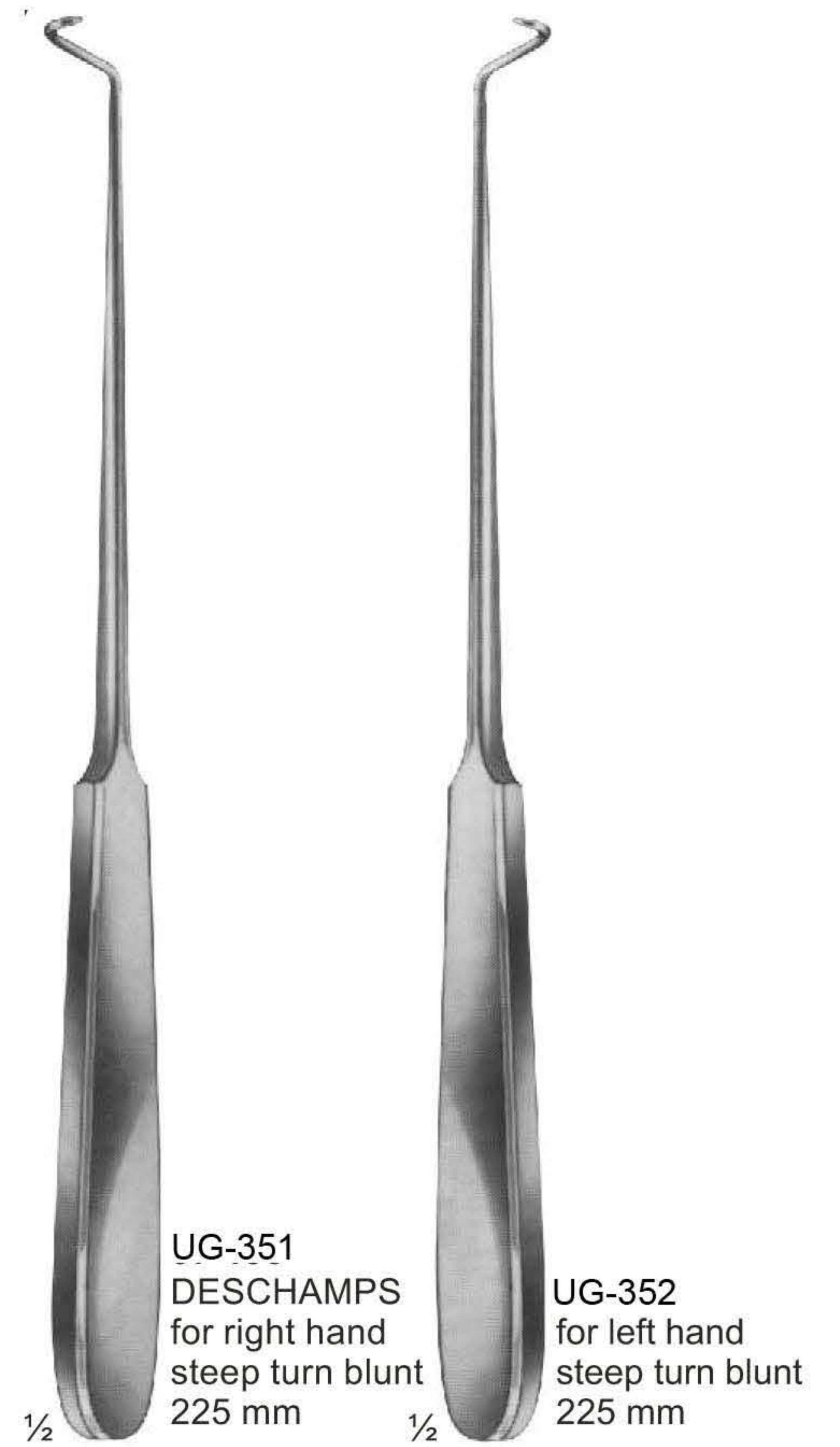
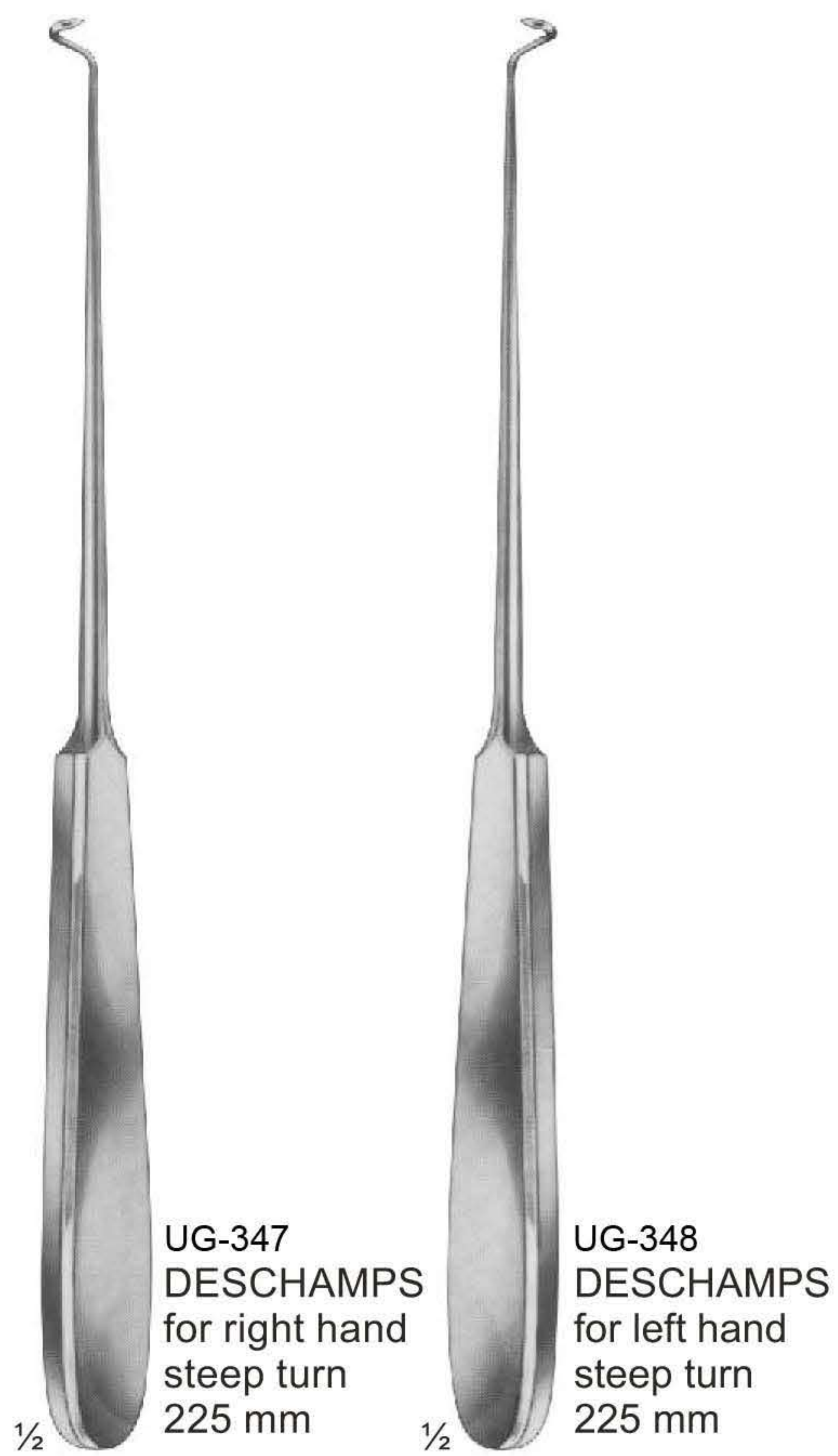

Suture Instruments - Ligature Needles



1/2
UG-368
HURD
for right hand
sharp
210 mm



1/2
UG-371
HURD
for left hand
sharp
210 mm



1/2
UG-372
DESCHAMPS
for right hand
sharp
215 mm



1/2
UG-373
DESCHAMPS
for left hand
sharp
215 mm



1/2
UG-374
JONESCO
Needle for wire suture
185 mm



1/2
UG-375
CLAUS VAN EICKEN
Needle for wire suture
250 mm



1/2
UG-376
150 mm



1/2
UG-377
SYME
170 mm



1/2
UG-378
COOPER
205 mm



1/2
UG-379
KOCHER
205 mm

Probes



UG-408 145 mm
 UG-409 160 mm
 UG-410 200 mm
 Probes with eye



1,5 mm
 UG-411
 Myrtle leaf probe
 145 mm



2,0 mm
 UG-412 130 mm
 UG-413 145 mm
 UG-414 160 mm
 UG-415 180 mm
 UG-416 200 mm



UG-417
 Probes



UG-418 1/2
 Double ended probe,
 malleable, diam. of tips
 3 mm with hole
 190 mm



UG-419
 Double ended probes,
 tin, malleable,
 diam. of tips
 3,5 mm with hole
 250 mm, 300 mm



UG-420
 Double ended probes,
 tin, malleable,
 diam. of tips 4 mm
 400 mm



UG-421 1,5 mm
 UG-422 2,0 mm
 UG-423 2,5 mm
 300 mm

Examination & Measuring Instruments

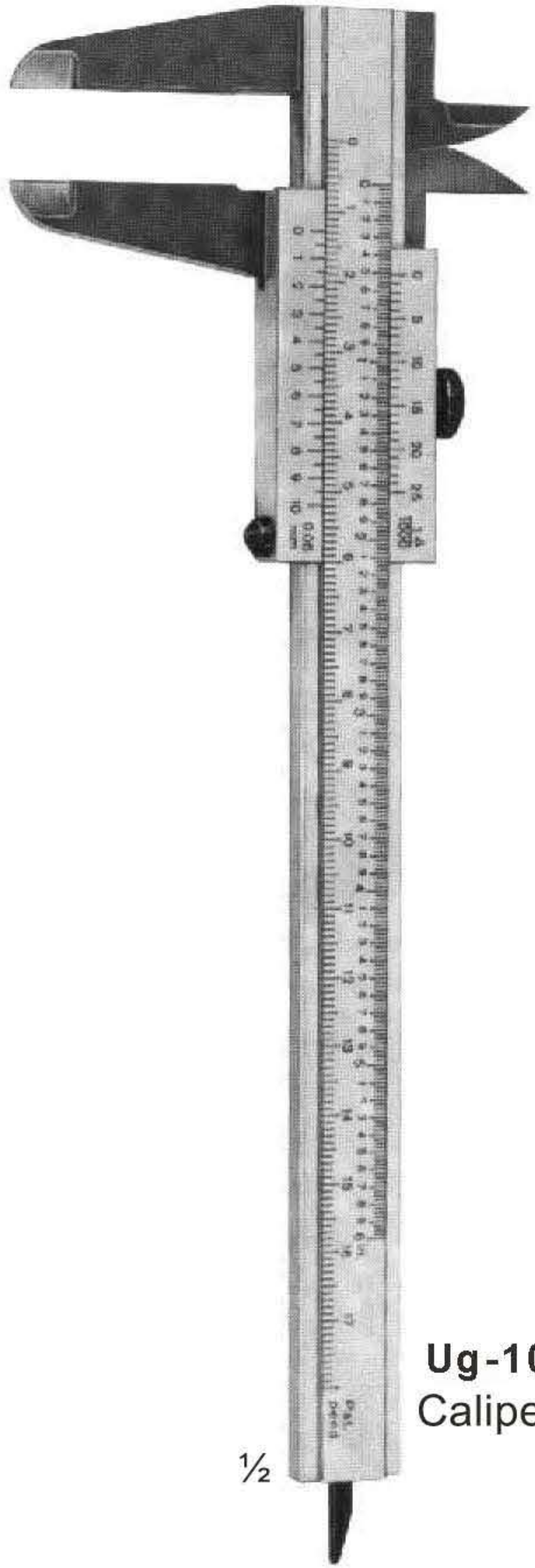

Ug-101
Caliper Of Aluminum

1/2

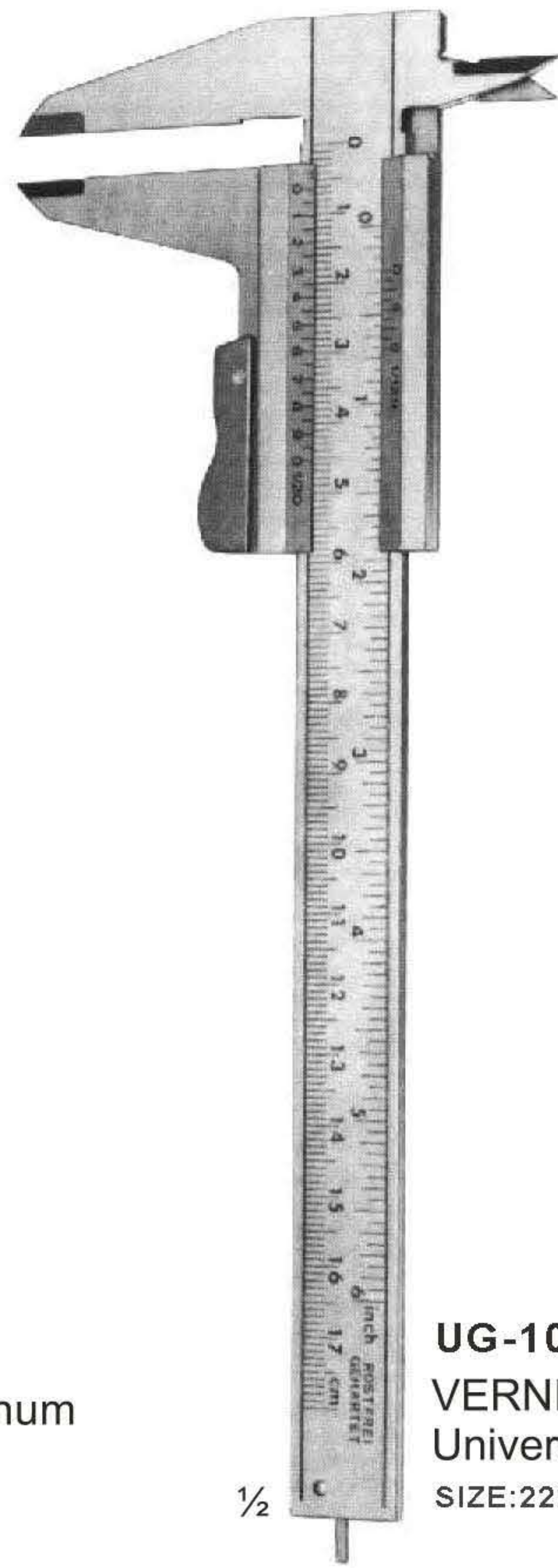

UG-102
VERNIER
Universal Caliper Of Steel
SIZE:222mm

1/2

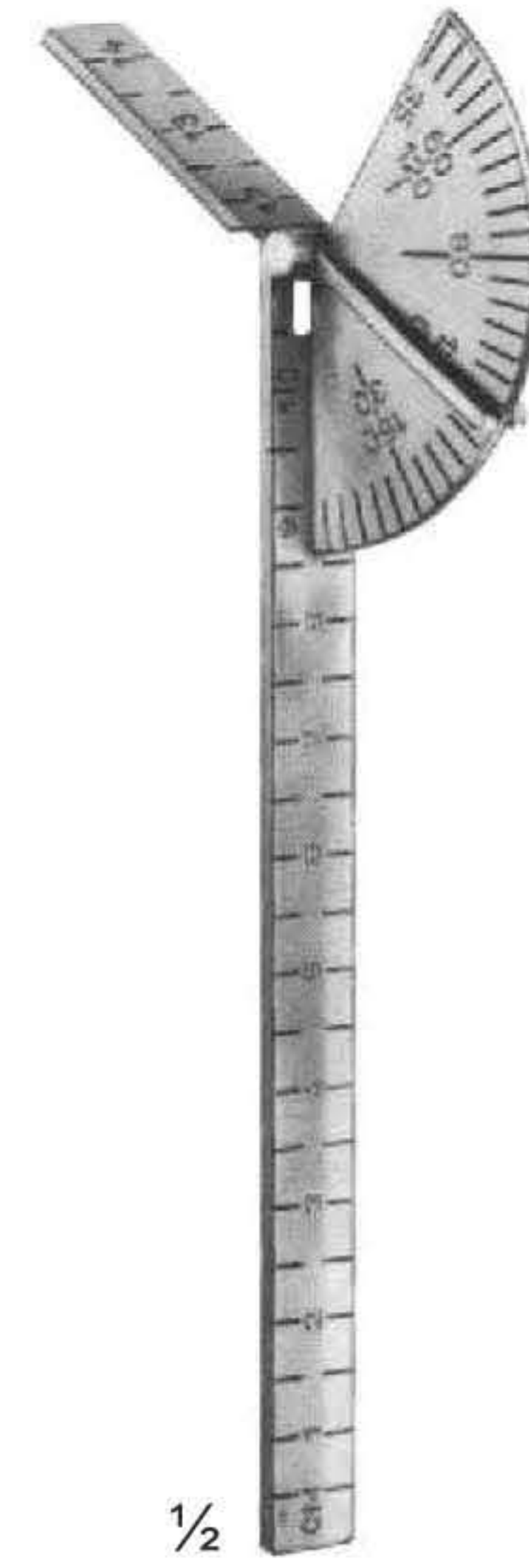

UG-105
CAROLL
SIZE:115mm

1/2

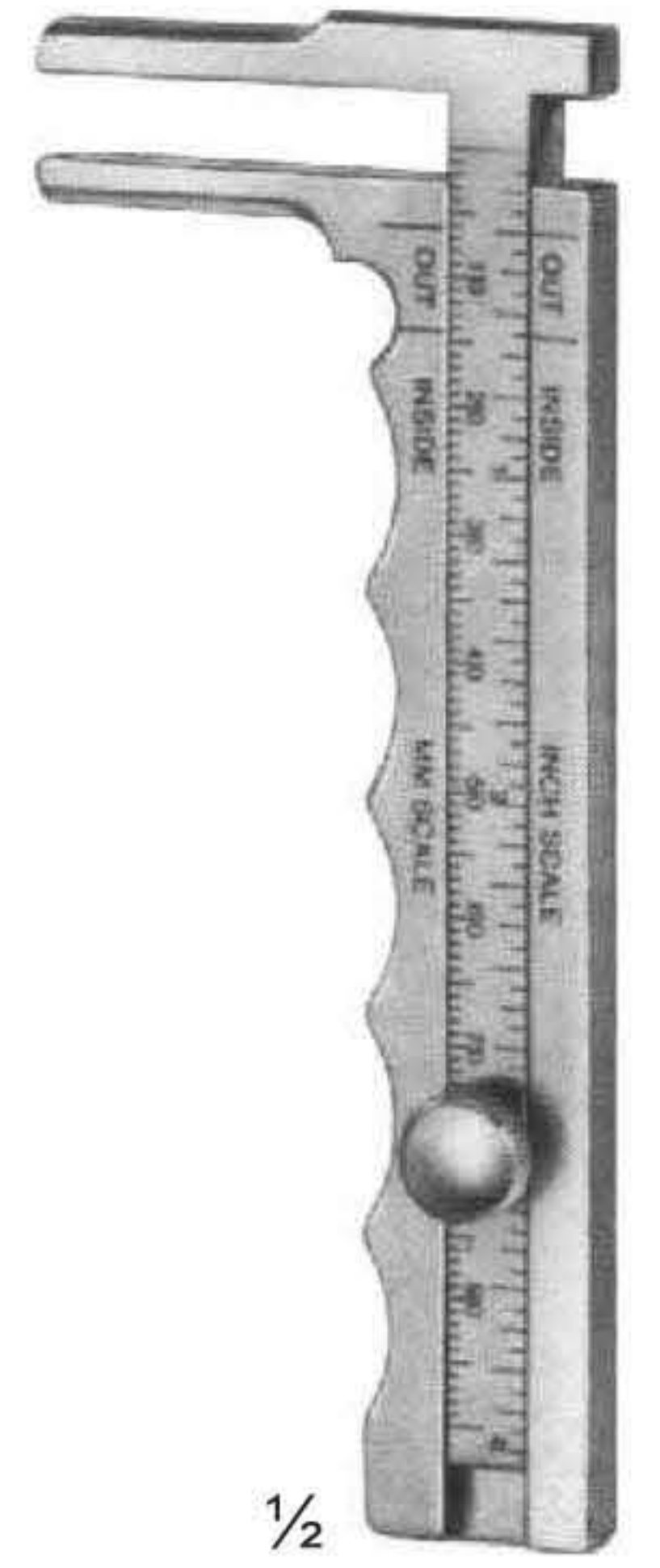

UG-106
TOWNLEY
SIZE:240mm

1/2

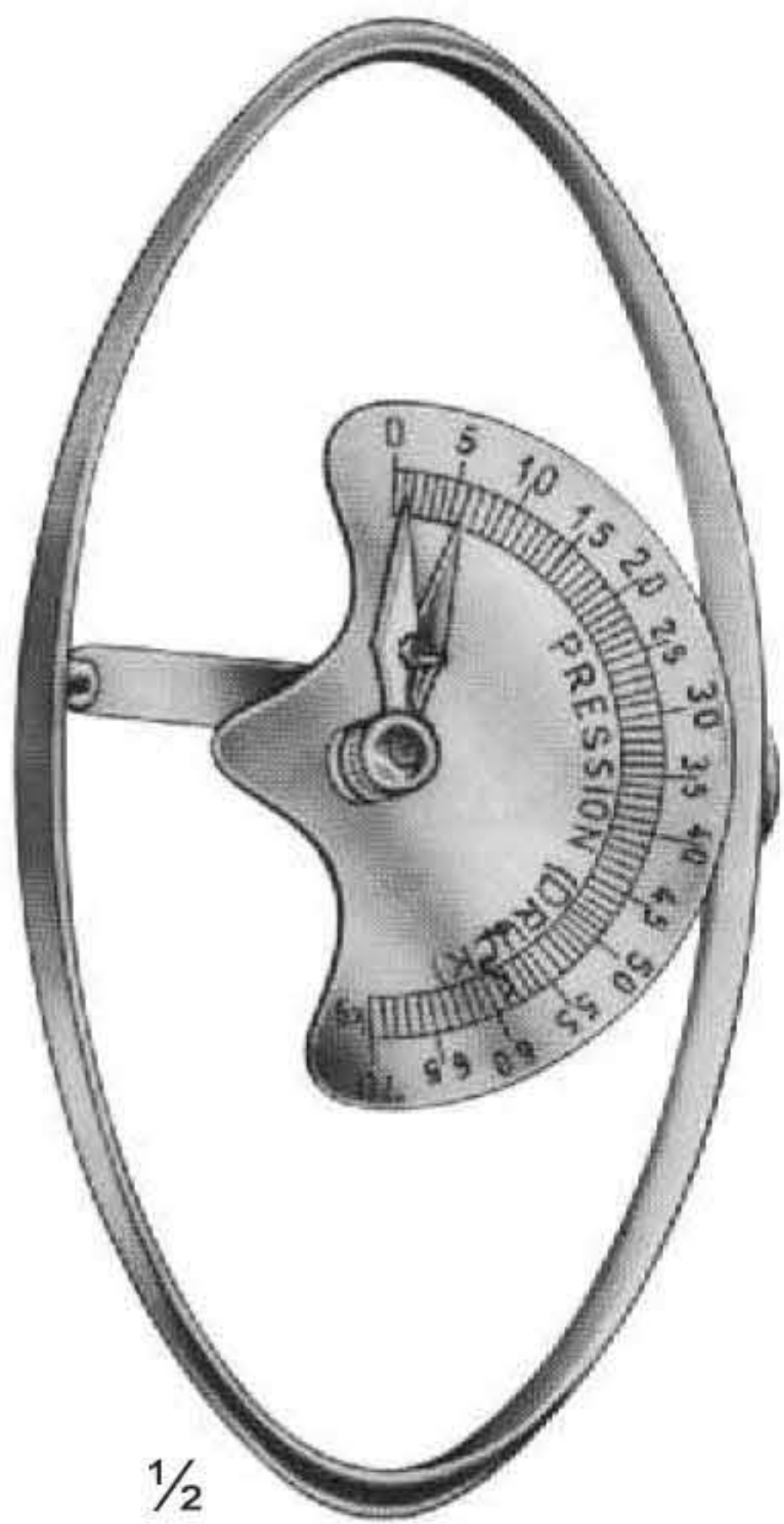

UG-108
COLLIN
Druck Pressure 72 kg
SIZE:145mm

1/2



UG-110
BERTILLON
Caliper For Measuring The Head
SIZE:220mm

1/2



UG-111
CASTROVIEJO
Caliper
SIZE: 145mm

1/4

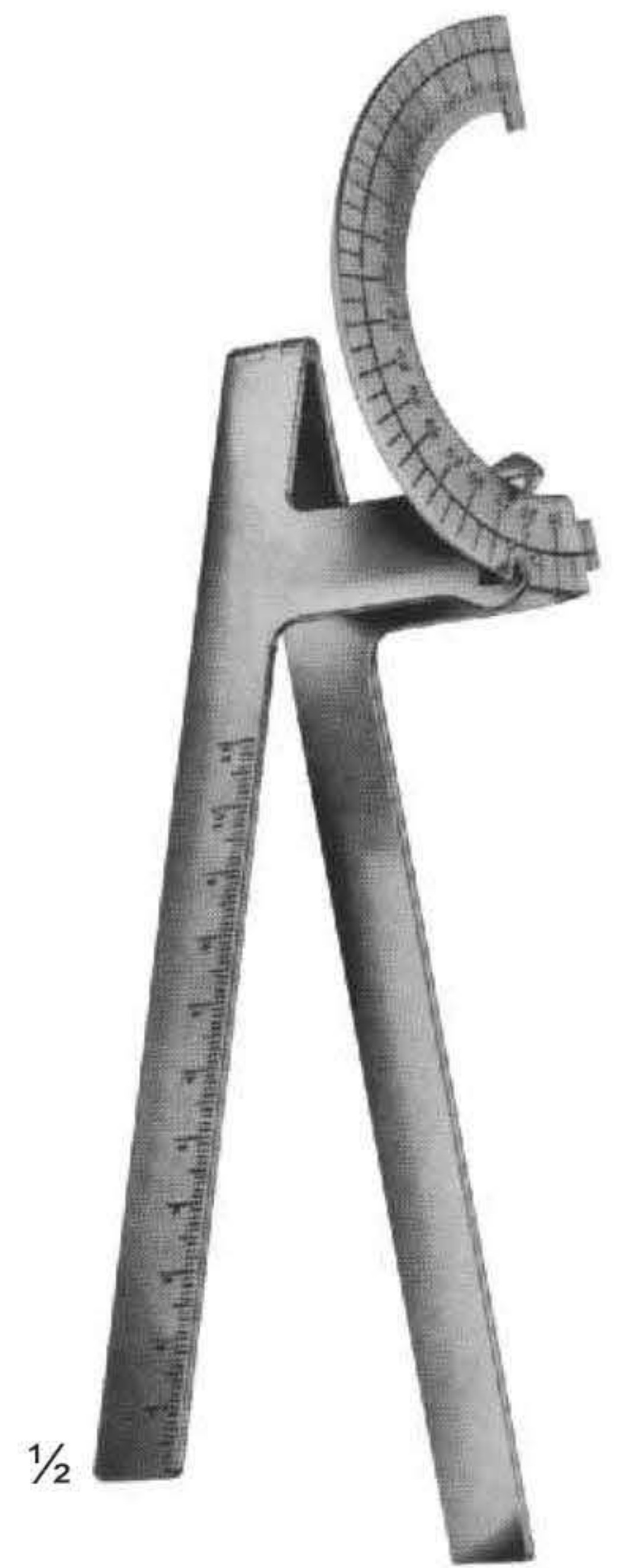

UG-114
MOLTGEN
Goniometer

1/2

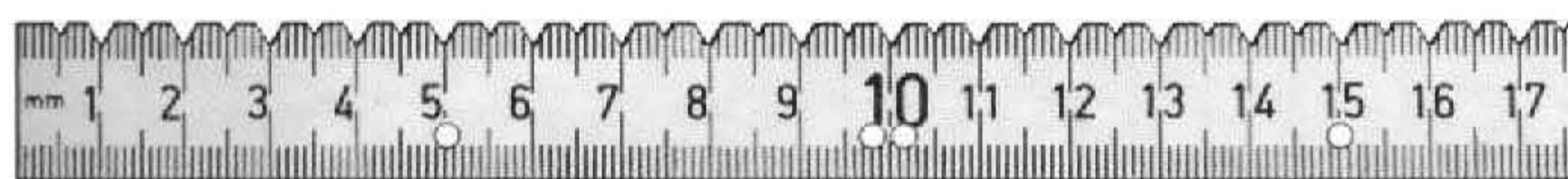

UG-085
Size: 150 mm

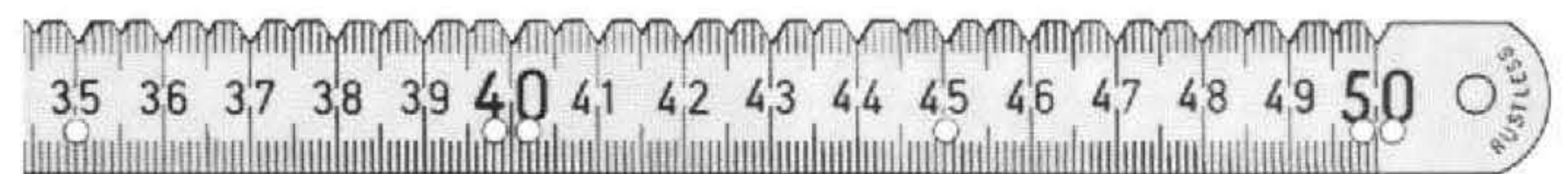

UG-084
Size: 500 mm

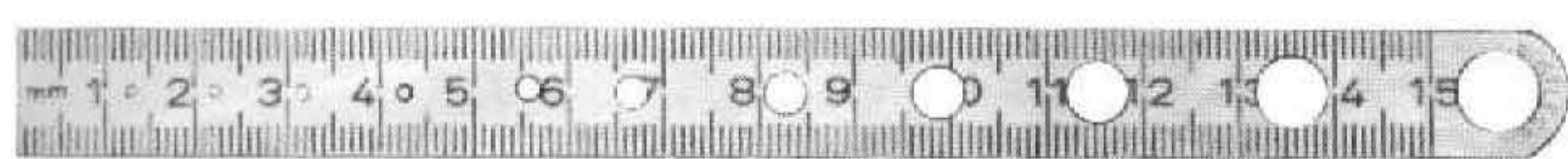

Probes - Spatulas - Cotton Applicators



UG-424
STACKE
100 mm



UG-425
KILLIAN
165 mm



UG-426
160 mm



UG-427
SEIFFERT
180 mm



UG-428
BOWMAN
130 mm



UG-429
SPATULA
145 mm



UG-430
SPATULA
145 mm



UG-431
Modell PICCOLO
Round Serrated
110 mm



UG-432
Modell PICCOLO
Triangular Serrated end
110 mm



UG-434
FARRELL
Round Serrated end
110 mm



UG-435
LATHBURY-FARREL
Triangular Serrated end
110 mm



Cotton Applicators



UG-438
BUCK
Rough, spiral end
120 mm

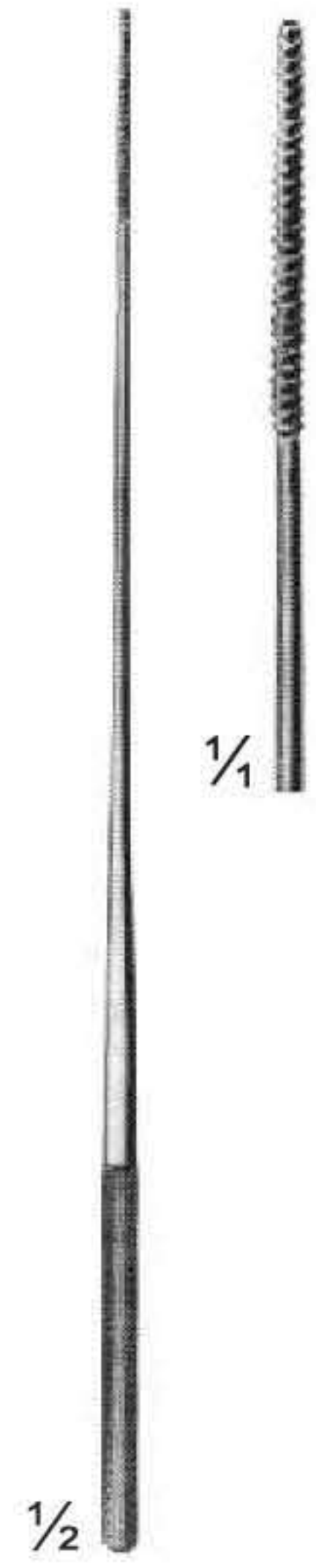

UG-440
Triangular
serrated end
140 mm

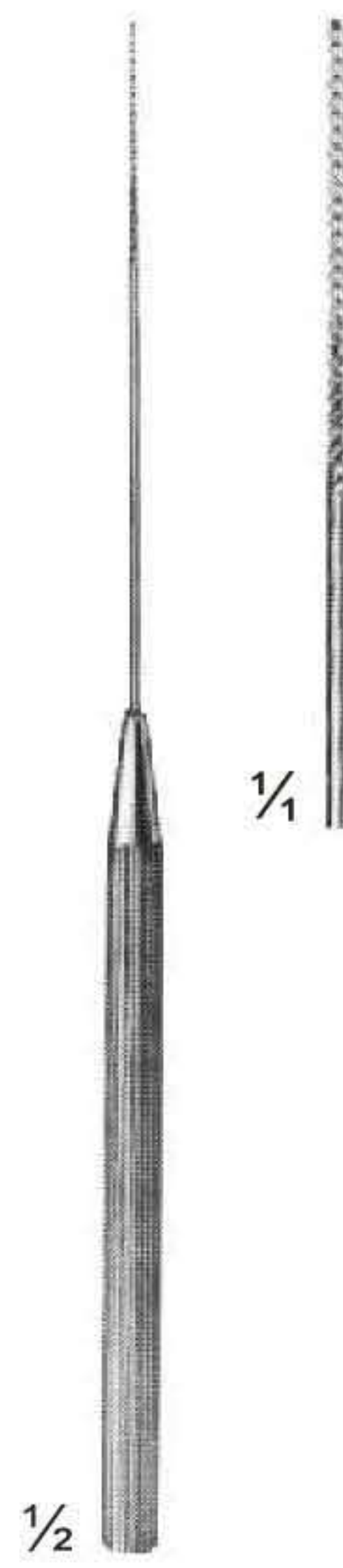

UG-441
Rough, spiral end
140 mm



UG-443
Rough, spiral end
140 mm



UG-444
Rough, spiral end
140 mm



UG-446
FARRELL
Round,
serrated end
140 mm



UG-447
LATHBURY-FARRELL
Triangular,
serrated end
140 mm



UG-3512
FARRELL
Rough,
spiral end
160 mm



UG-3513
LATHBURY-FARRELL
Triangular,
serrated end
160 mm

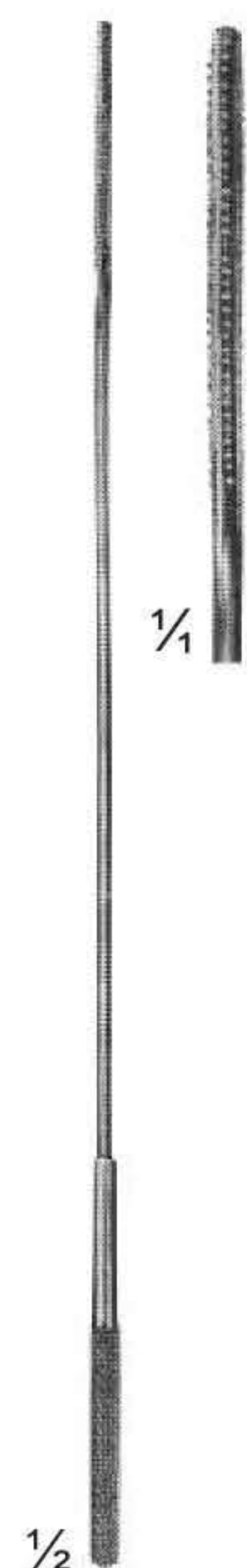

UG-3514
Triangular,
serrated end
160 mm



UG-3515
Rough,
spiral end
180 mm



UG-3516
Rough,
spiral end
180 mm



UG-3517
Rough,
spiral end
270 mm

Clip Applying Forceps - Suture Set



1/2

UG-2029
MICHEL
125 mm



1/2

UG-2030
HEGENBARTH
120 mm



1/2

UG-2032
WACHENFELDT
120 mm



1/2

UG-2033
WACHENFELDT
120 mm



1/2

UG-2034
MICHEL
125 mm



1/2

UG-2036
MICHEL modif.
130 mm



1/2

UG-2037
HEATH
135 mm



1/2

07-289
COLLIN
135 mm

Clip Applying Forceps - Suture Set



UG-2039

Suturing instruments set, in metal case
 consisting of: Scissors, curved, sharp/sharp, 115mm
 25 MICHEL clip, 16 x 3mm
 1 Delicate tissue forceps, 130mm
 1 Scalpel, bellied
 1 MATHIEU needle holder, 140mm
 1 Perforated metal case, stainless
 containing:
 1 Suture needle
 1 item 1 item

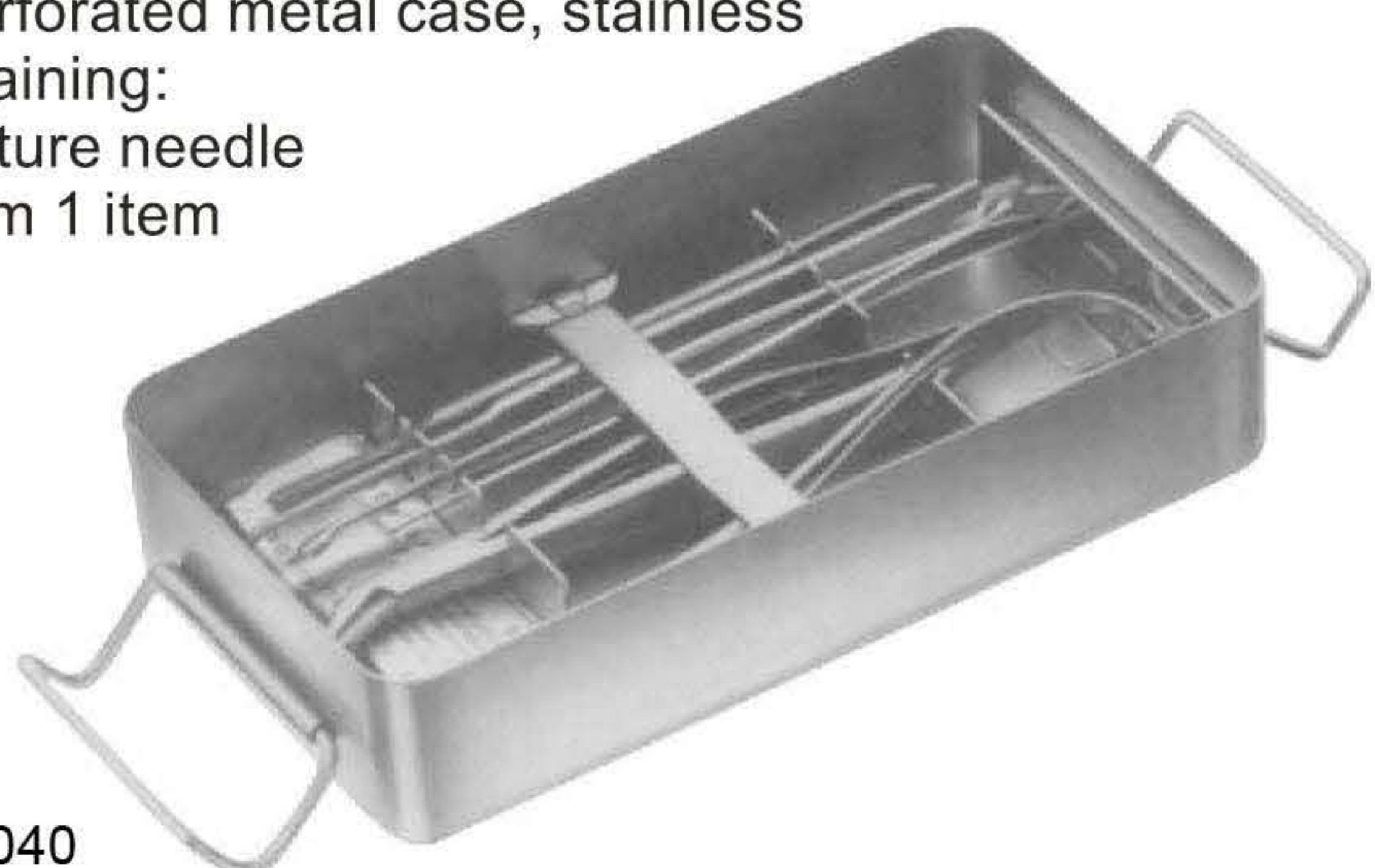

UG-2040

Pocket instrument set, in metal case
 consisting of:

Bottom tray

1 MATHIEU needle holder, 140mm
 1 MICHEL clip forceps, combined
 1 Myrtle leaf probe, 130mm
 1 Sharp double curette
 1 Skin hook
 1 Detachable scalpel handle, no.4
 1 Perforated metal case, containing
 6 Scalpel blades BB 520
 1 Perforated metal case,
 stainless, containing
 1 Suture needle
 1 item
 1 item

Top tray

1 Tissue forceps, 130mm
 1 KOCHER haemostatic forceps, 130mm
 1 Straight surgical scissors, 130mm
 1 Dissecting forceps, 130mm
 1 FEILCHENFELD splinter forceps, 115mm
 25 MICHEL clip, 16 x 3mm
 1 Flacon of suture skin, sterile in alcohol

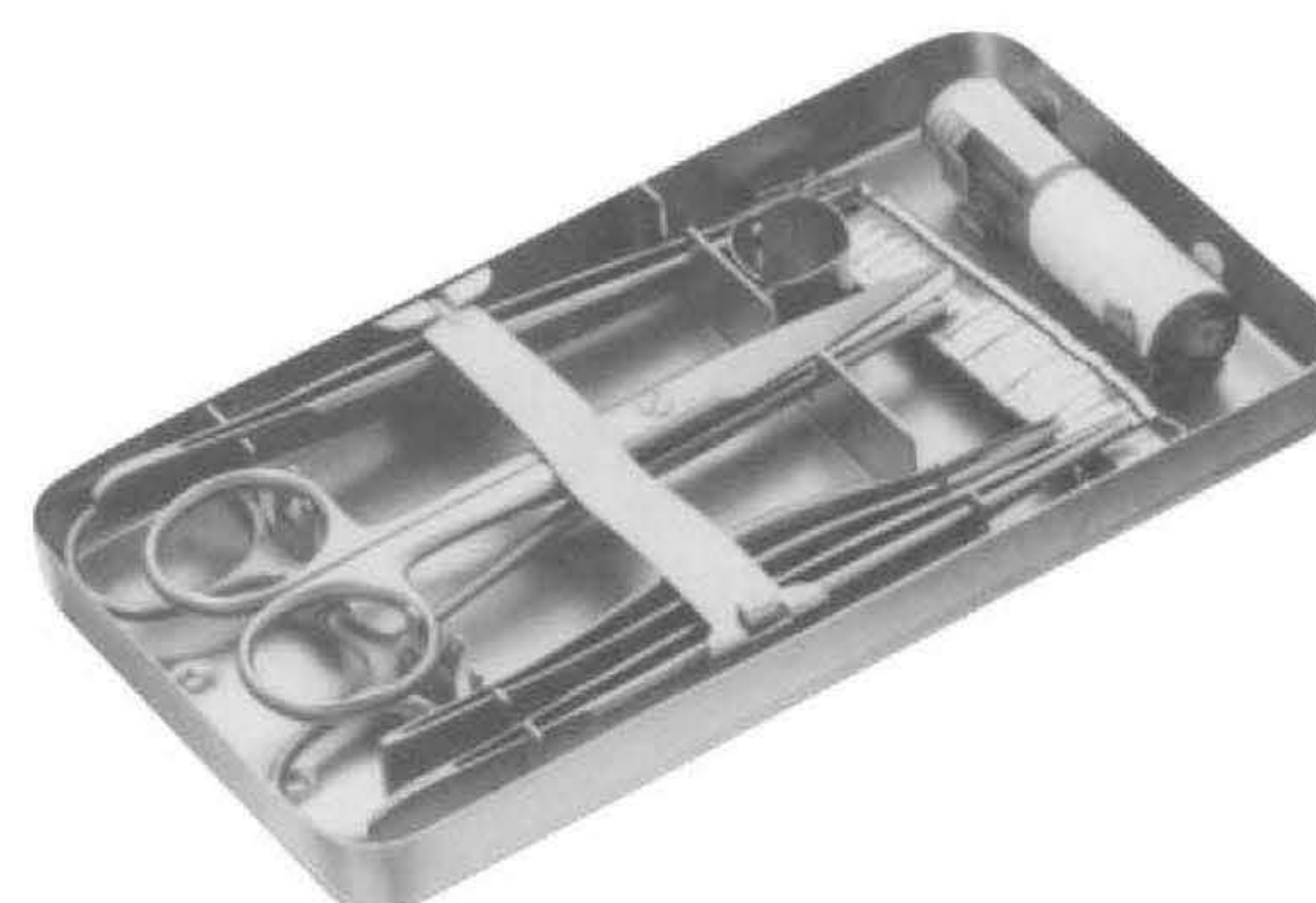

UG-2041

Pocket instrument set, in metal case
 consisting of:

Bottom tray

1 MAYO-HEGER needle holder, 150mm
 1 MICHEL clip forceps, combined
 1 Myrtle leaf probe, 130mm
 1 Sharp double curette
 1 Skin hook
 1 Detachable scalpel handle, no. 4
 1 Perforated metal case, consisting
 6 Scalpel blades BB 520
 1 Perforated metal case, stainless, consisting:
 1 Suture needle
 1 item, & 1 item

Bottom tray

1 Tissue forceps, 130mm
 1 CRILE haemostatic forceps, 140mm
 1 Straight surgical scissors, 130mm
 1 Dissecting forceps, 130mm
 1 FEILCHENFELD splinter forceps, 115mm
 25 MICHEL clip, 16 x 3mm
 1 Flacon of suture silk, sterile in alcohol

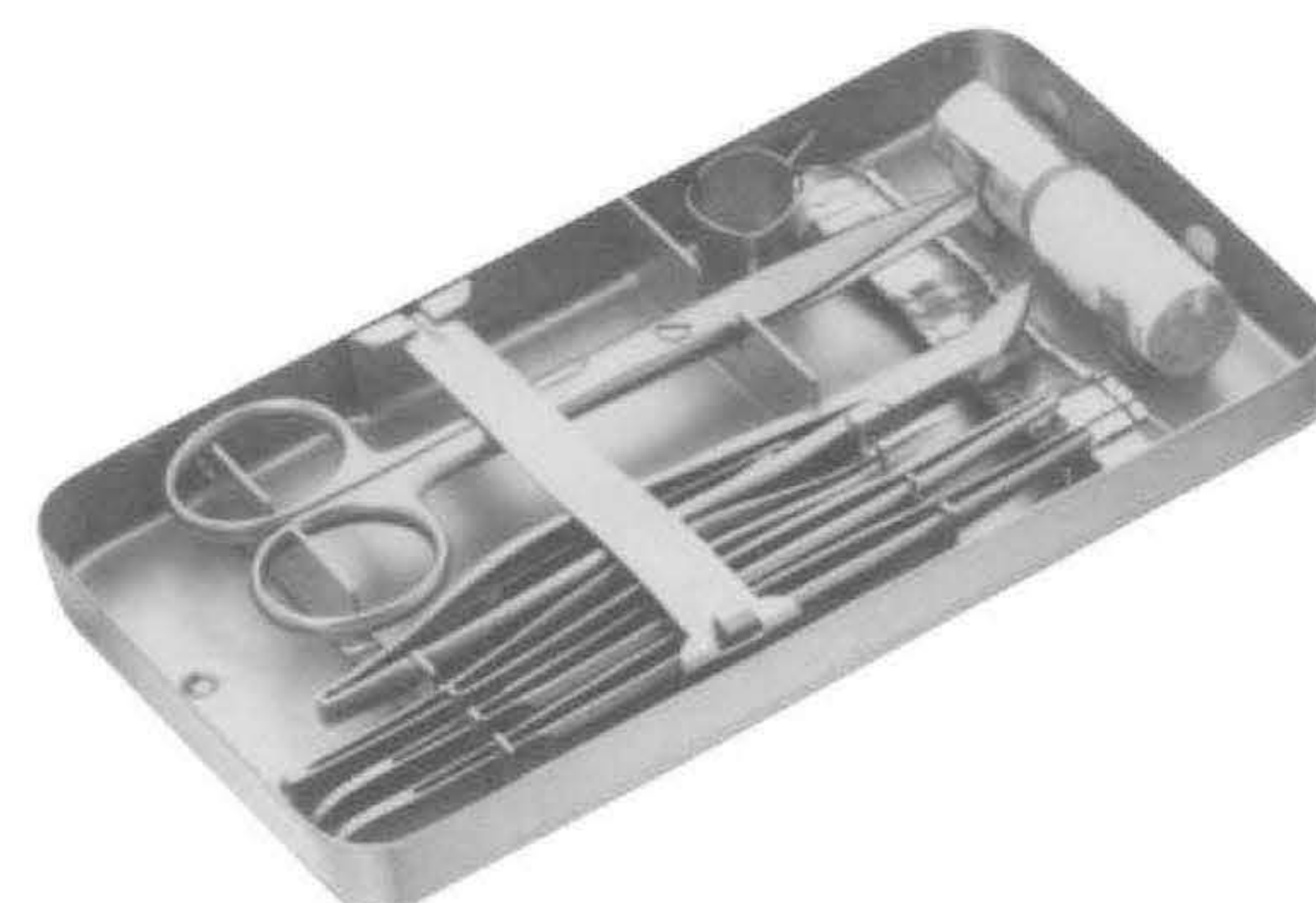

Clip Applying Forceps - Suture Set

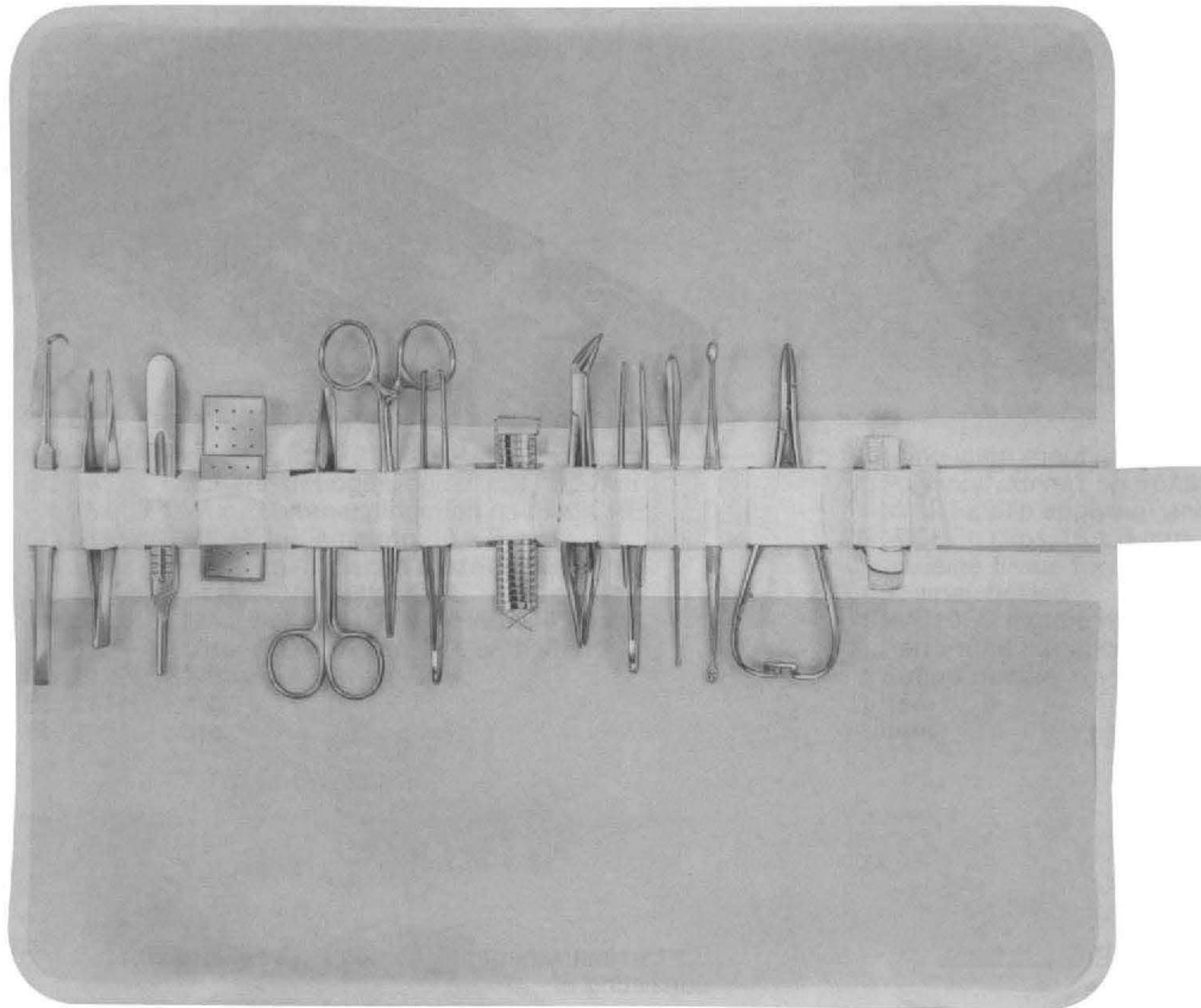

UG-2028
Pocket instrument set in metal case 170 x 90mm
with sterilizable canvas roll
consisting of:
1 Myrtle leaf probe, 130mm
1 Sharp double curette
1 FEILCHENFELD splinter forceps, 115mm
1 Dissecting forceps, 130mm
1 Tissue forceps, 130mm

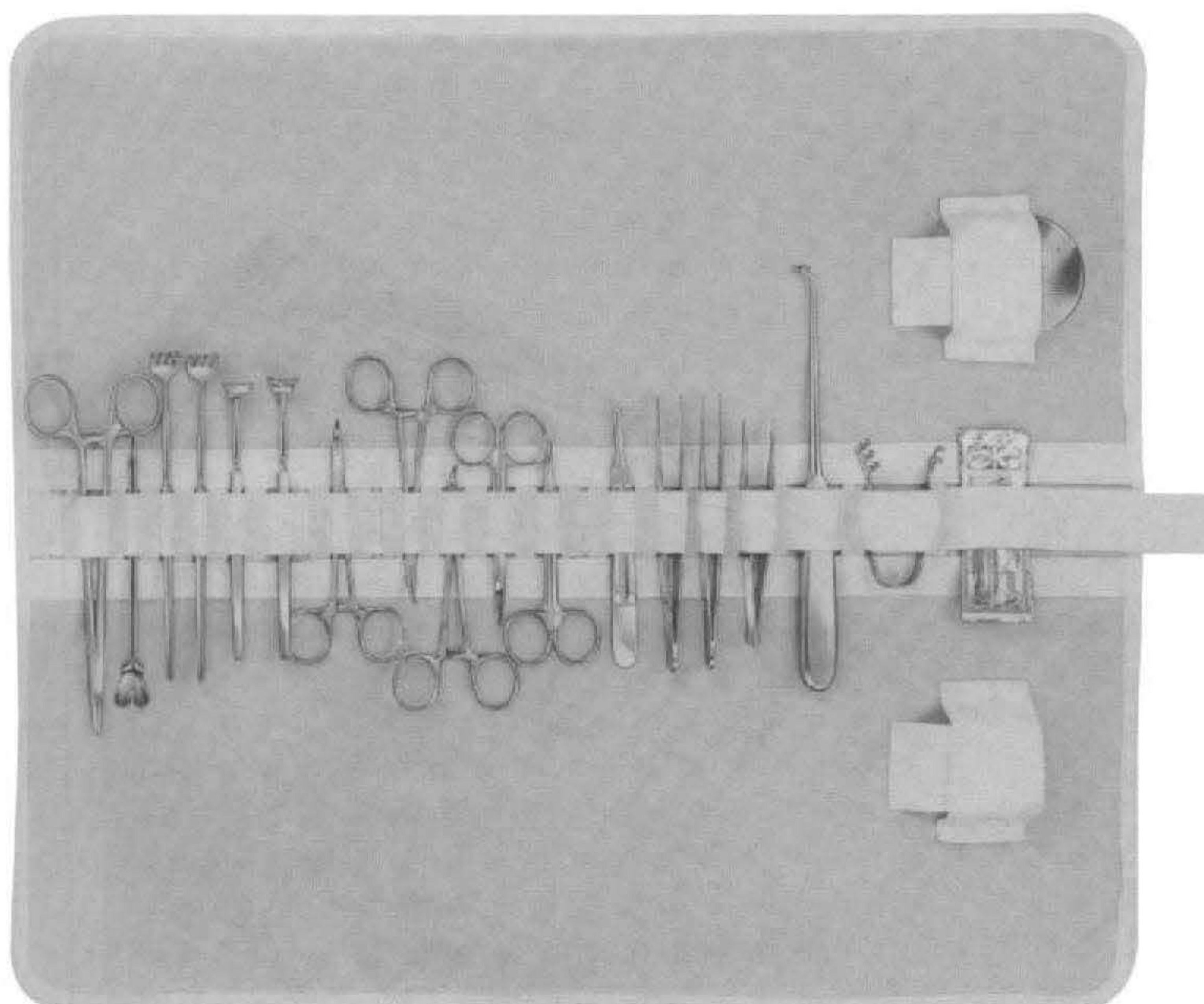

UG-2031
Venae sectio set, in sterilizable canvas roll
consisting of:
1 Tissue forceps, 1 x 2 teeth, 140mm
1 Dissecting forceps, 145mm
1 FEILCHENFELD straight scissors, sharp, 110mm
1 curved scissors, blunt, 115mm
1 HALSTED mosquito forceps, curved on flat,
125mm

Clip Applying Forceps - Suture Set

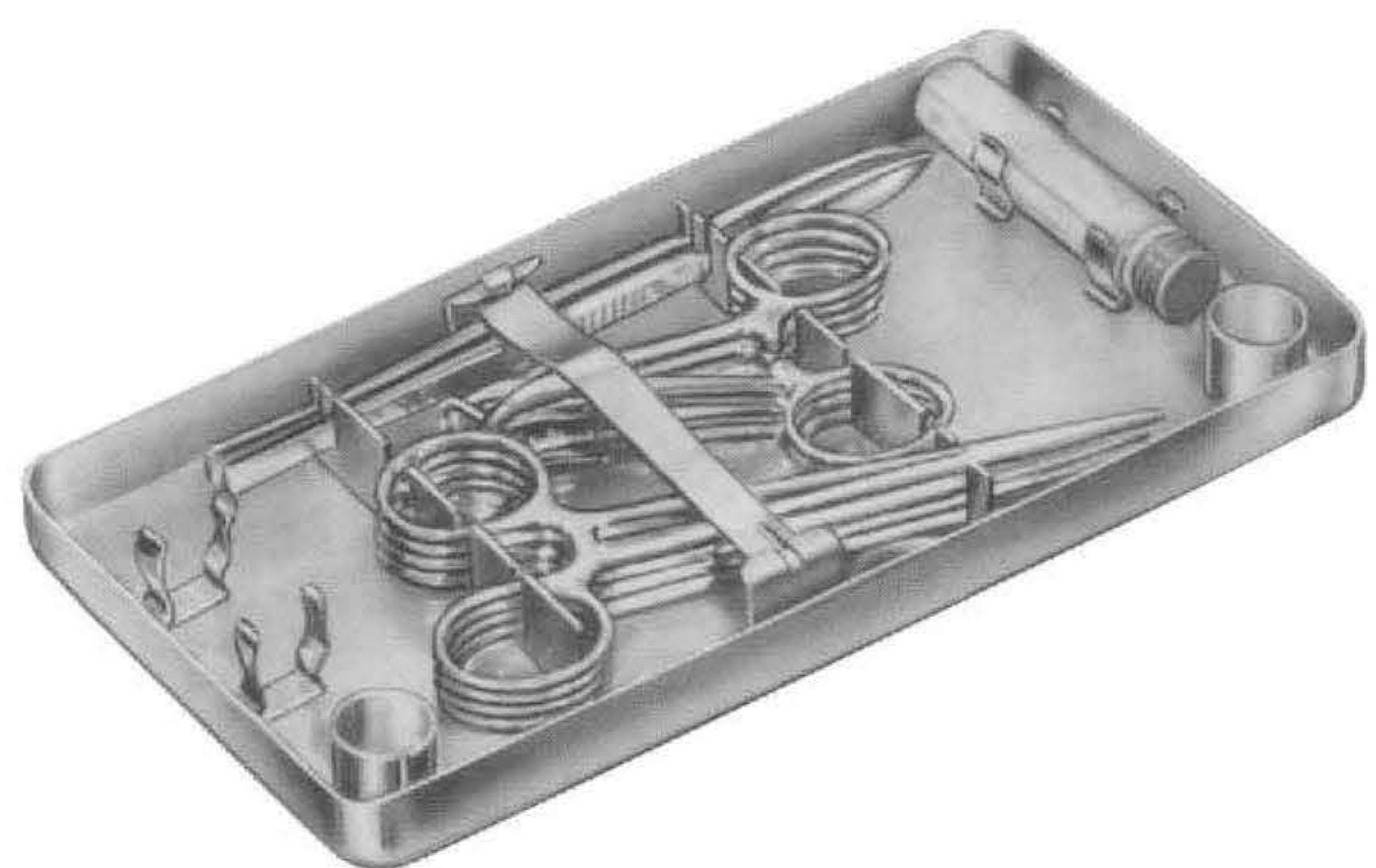
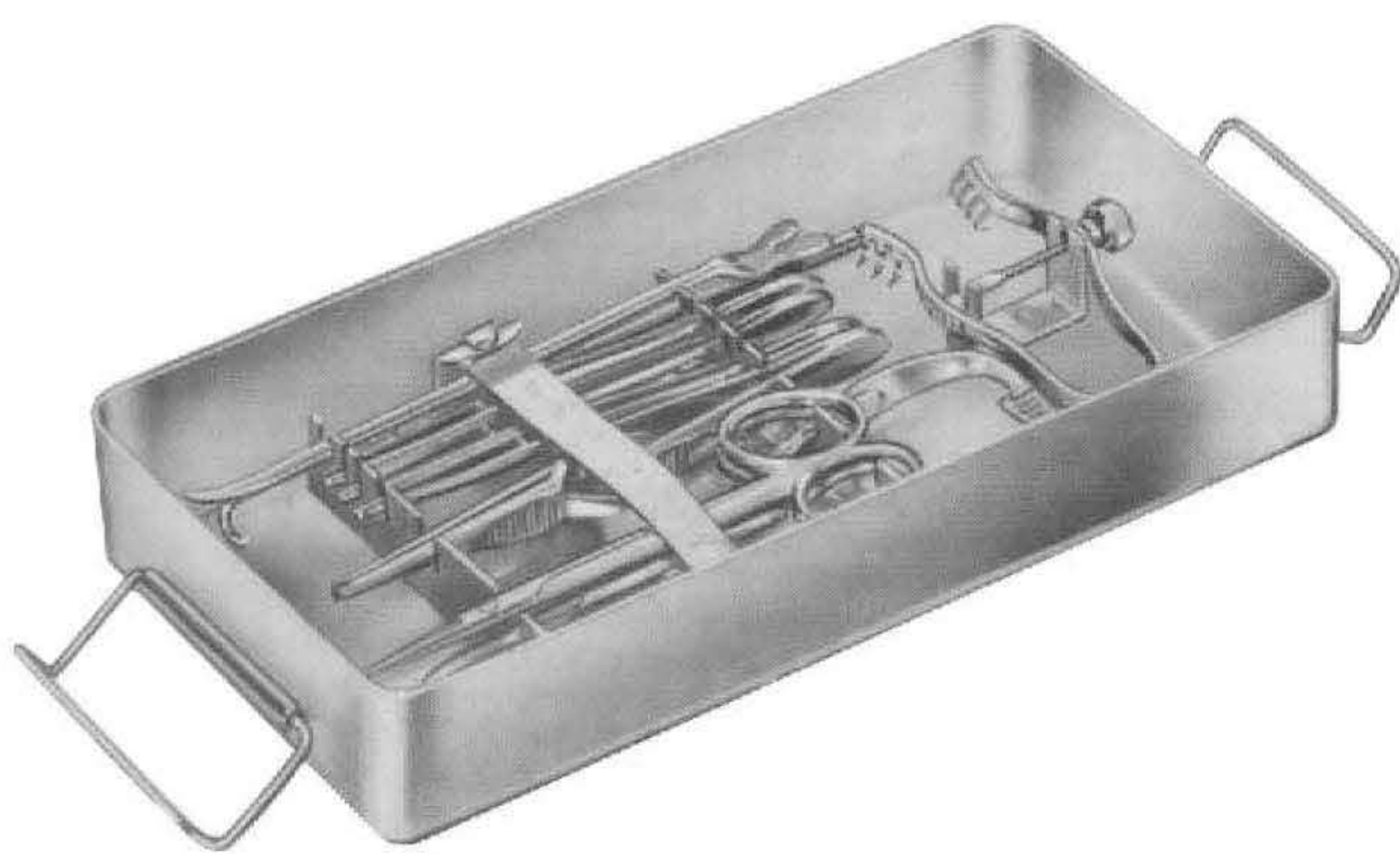

UG-2035

Venae sectio set, in metal case
consisting of:

Bottom tray

- 1 MATHIEU needle holder, fine pattern 140mm
- 1 Ligature needle, fine short pattern
- 1 DOYEN director, curved
- 1 HEGENBARTH clip forceps,
- 1 ELSCHNIG tissue forceps, 1 x 2 teeth fine, 150mm
- 1 Dressing forceps, fine 105mm
- 1 Tissue forceps, 1 x 2 teeth, 110mm
- 1 Vessel scissors, straight, with 1 ball point, 110mm
- 1 Vessel scissors, curved, pointed 105mm
- 1 FINSEN retractor
- 1 Perforated needle case

Top tray

- 1 Scalpel, pointed
- 1 Scalpel, bellied
- 2 HALSTED mosquito forceps, curved, 125mm
- 2 HALSTED mosquito forceps, straight, 1x 2 teeth, 125mm
- 3 BACKHAUS towel forceps, 90mm
- 2 Flacon holder

Nerve - and Vessel Hooks



UG-712
WAGENER
150 mm



UG-713
GRAEFE
140 mm



UG-715
BROM
Vein hook
170 mm

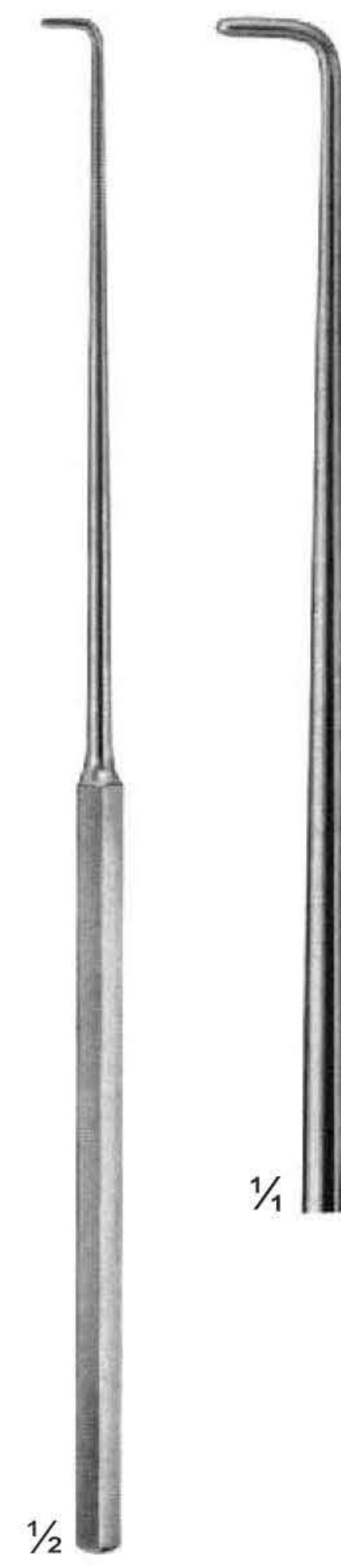

UG-716
CRILE
200 mm



UG-717
CUSHING
190 mm

Nerve - and Vessel Hooks



$\frac{1}{2}$
UG-718
KRAYENBUHL
185 mm



$\frac{1}{2}$
UG-720
CASPAR
245 mm



$\frac{1}{2}$
UG-721
CUSHING
280 mm

Fine Wound Retractors (Dura- and Skin Retractors)



UG-724
GRAEFE
125 mm



UG-727
Sharp
GUTHRIE



UG-728
ROLLET



UG-732
FRAZIER
Dura Retractors
130 mm

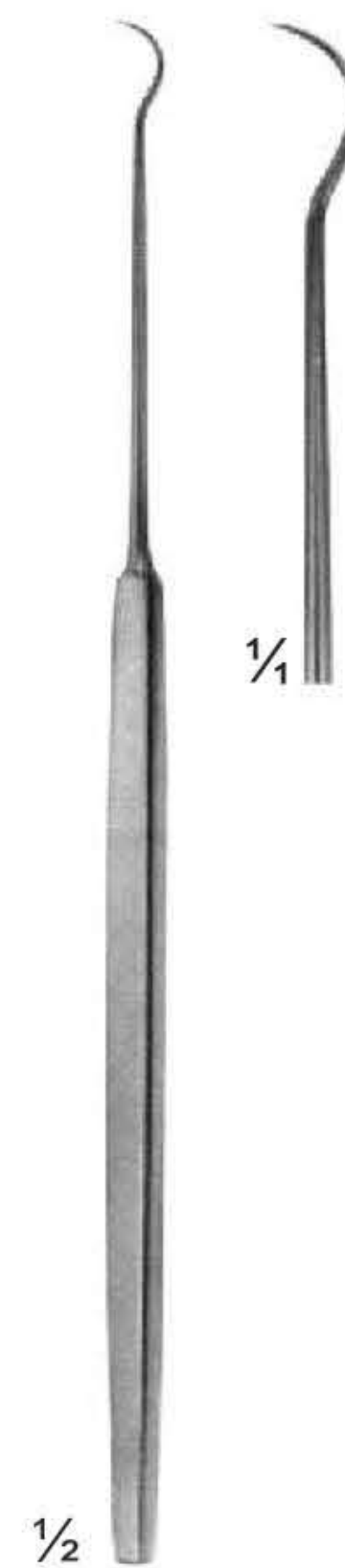

UG-734
TONNIS
Dura Retractors
150 mm



UG-735
KILNER
160 mm

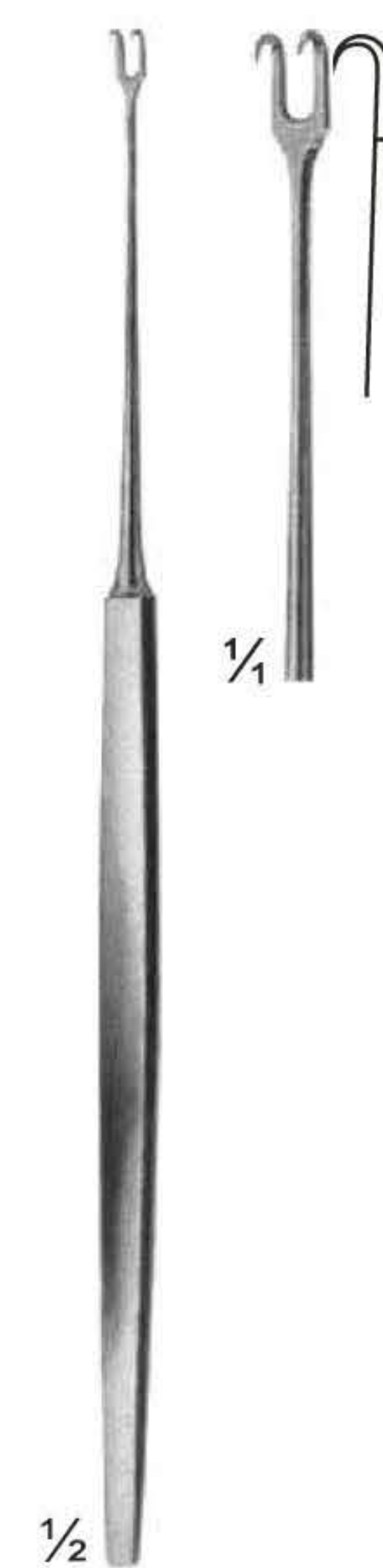

UG-737
FREER
150 mm

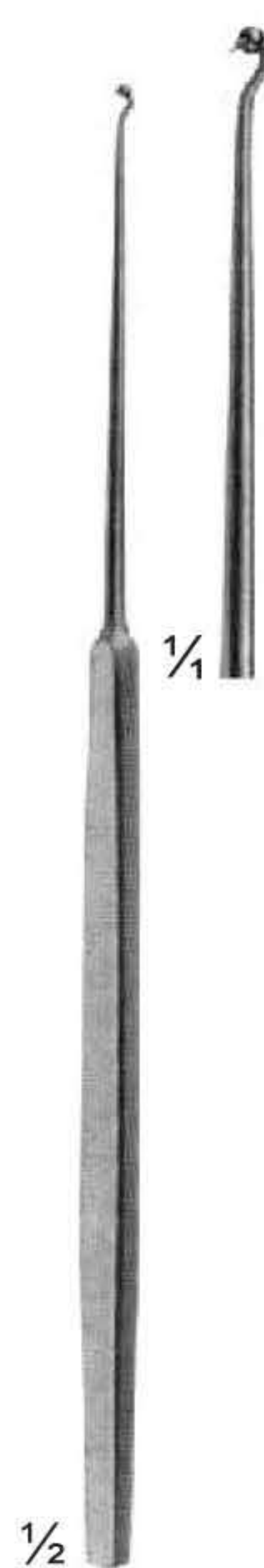

UG-738
MULLER
150 mm

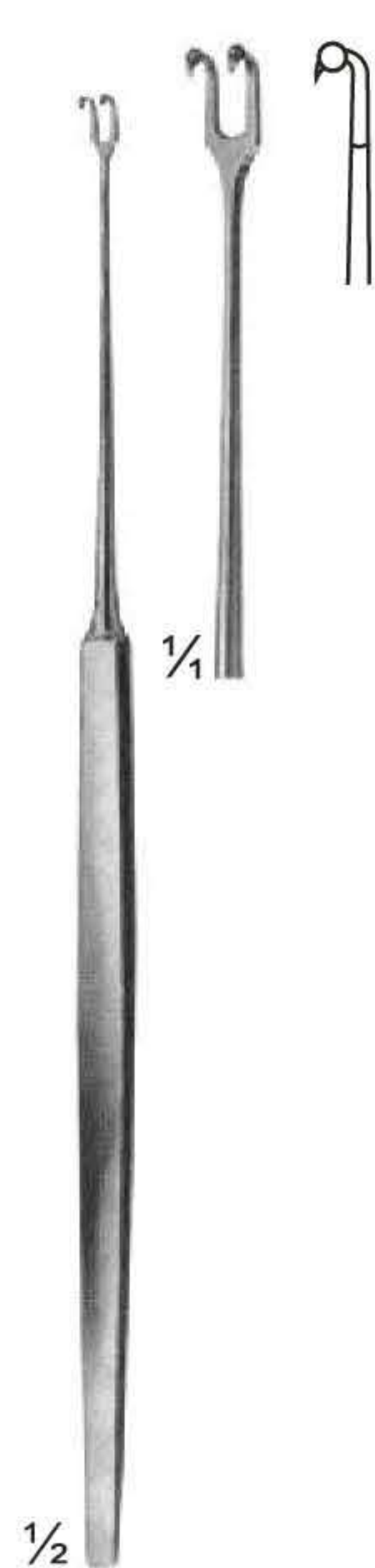

UG-740
MULLER
150 mm

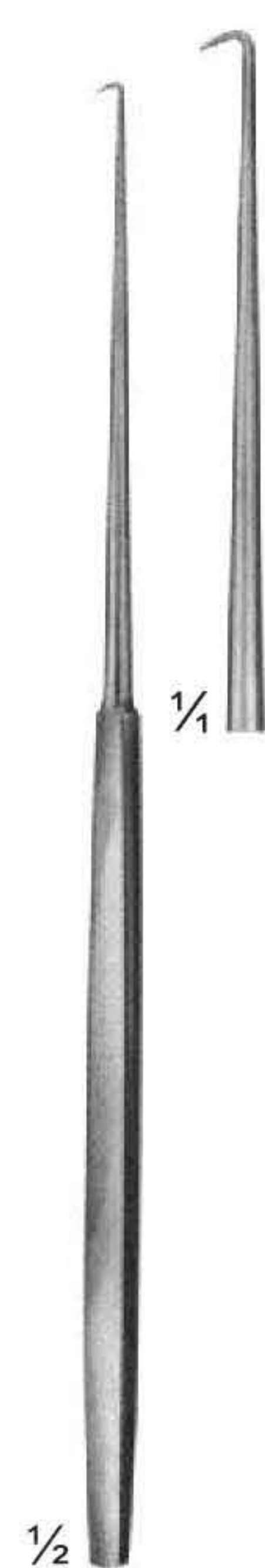

UG-741
COTTLE
160 mm

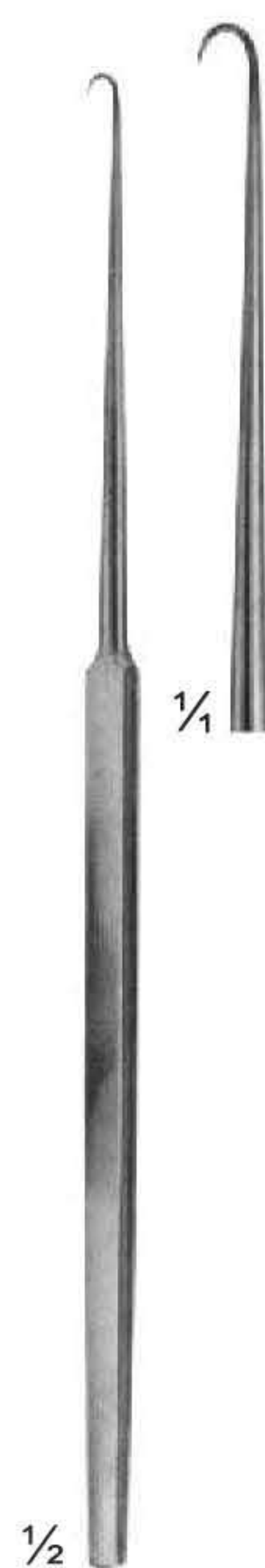

UG-742
COTTLE
160 mm



UG-743
JAEGAR
135 mm



UG-746
JOSEPH
165 mm



UG-749
GILLIES
180 mm

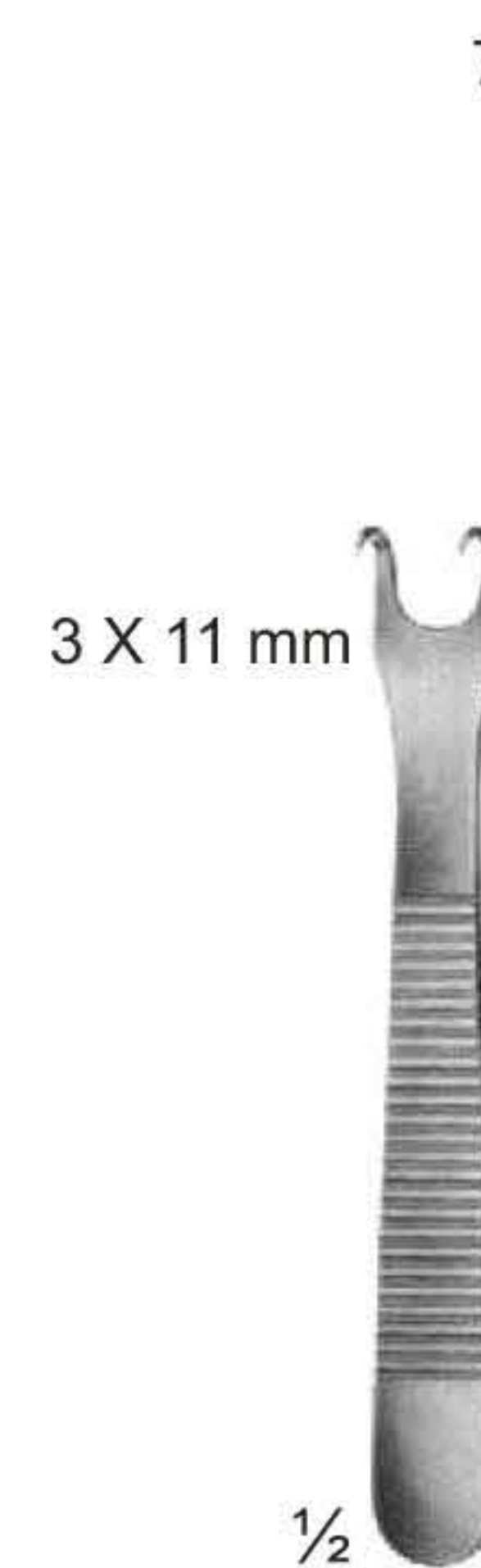

UG-751
KILNER
Sharp
80 mm

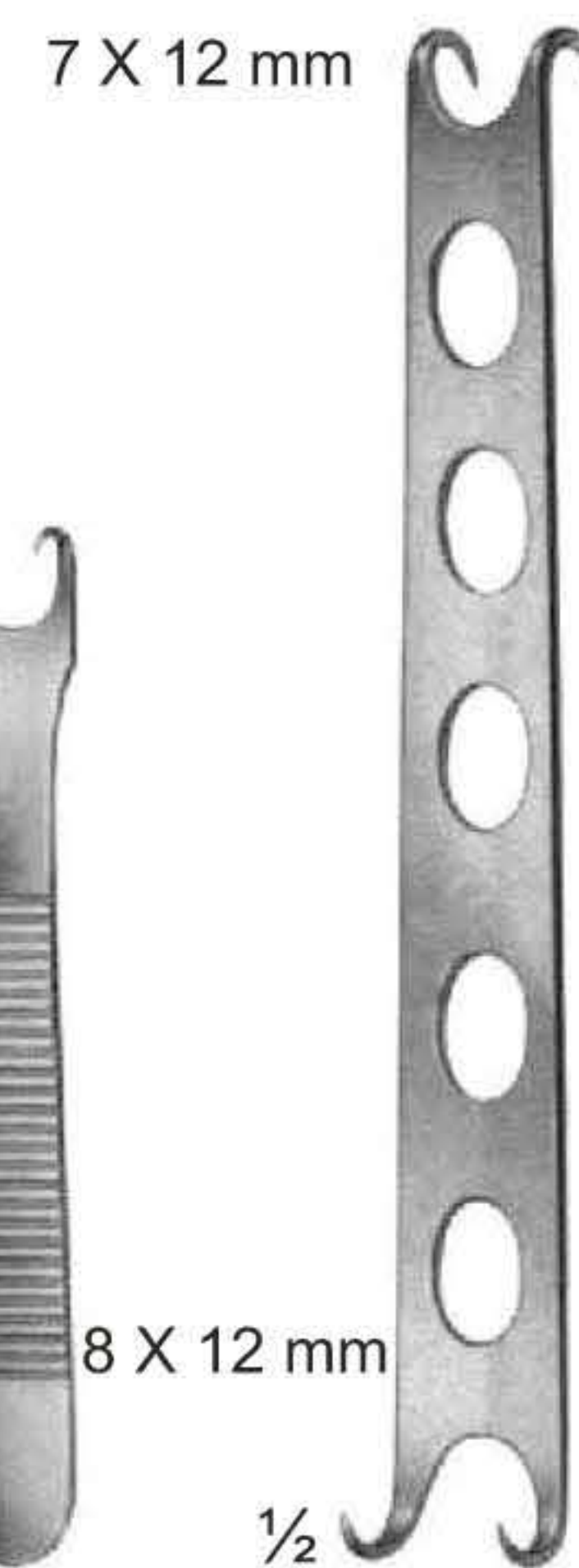

UG-753
CONVERSE
Blunt
120 mm

Wound - Trachea Retractors

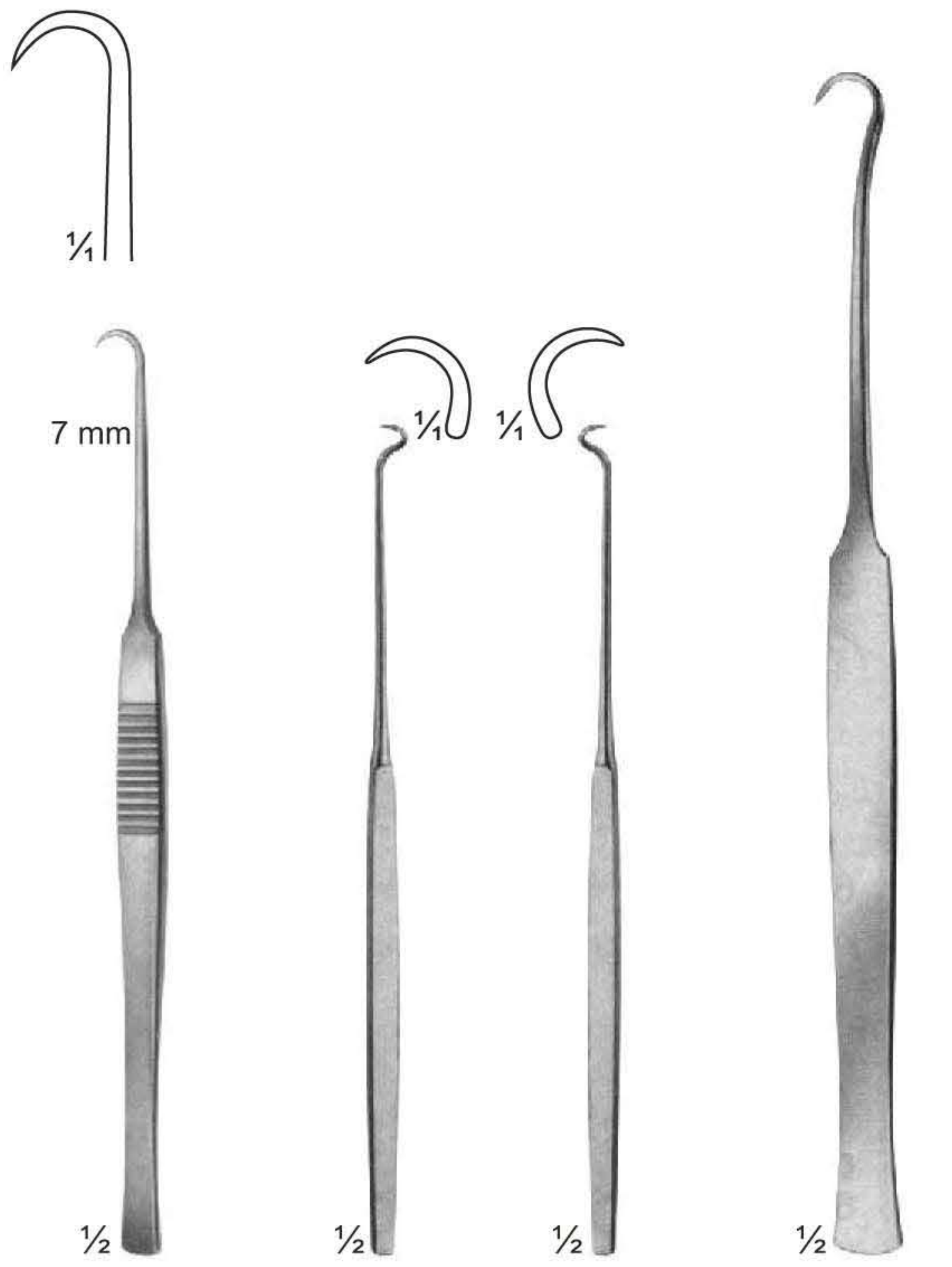

UG-757
BERGMANN
140 mm

UG-758
BOSE
165 mm

UG-760
BOSE
165 mm

UG-763
180 mm

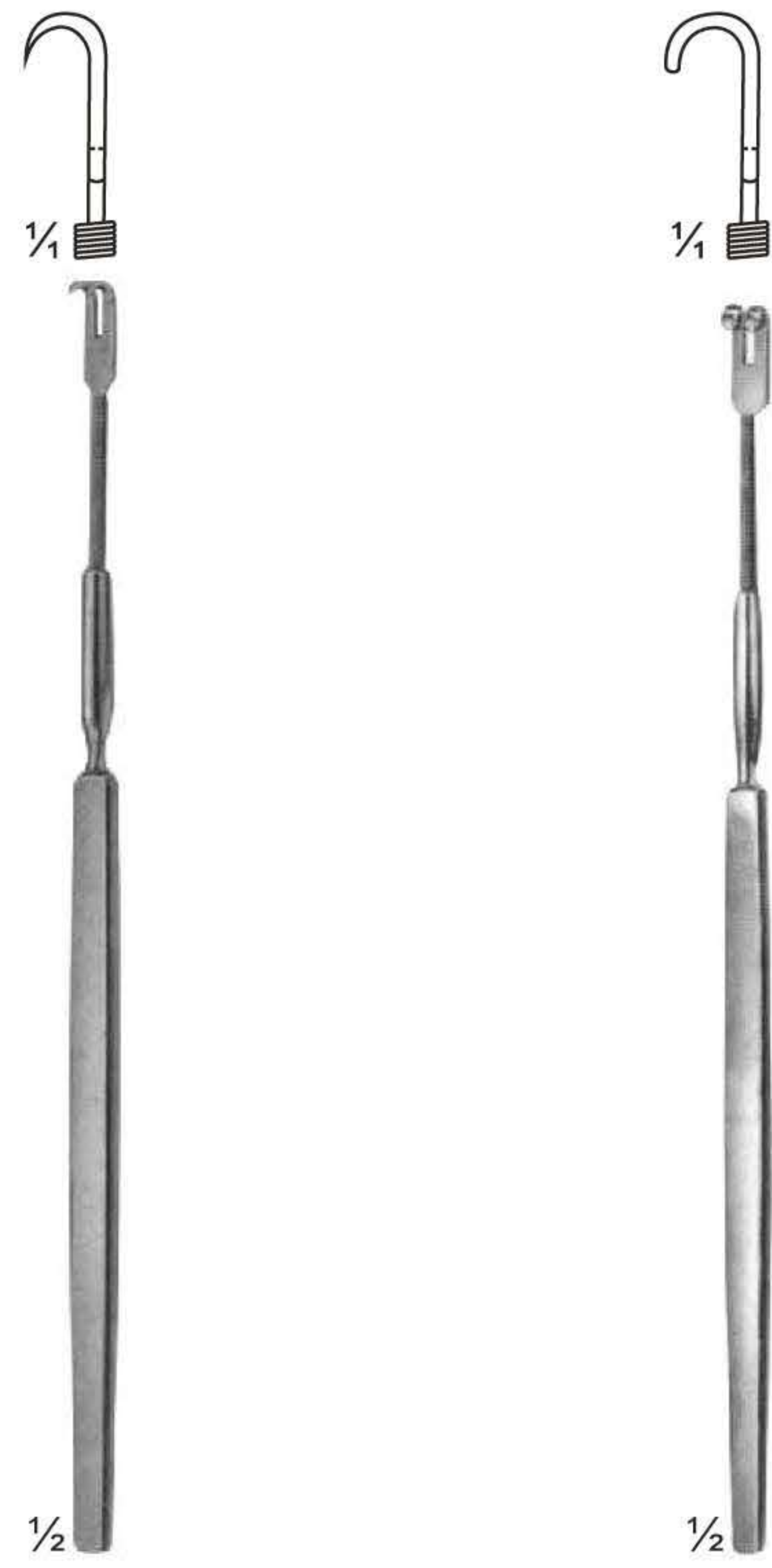

UG-765
Flexible shaft, sharp
155 mm

UG-766
Flexible shaft, blunt
155 mm



UG-768
Large curve,
sharp
165 mm



UG-774
Large curve,
blunt
165 mm



1/2

UG-122
Fig. 1 - 10
SIZE: 100mm

Retractors

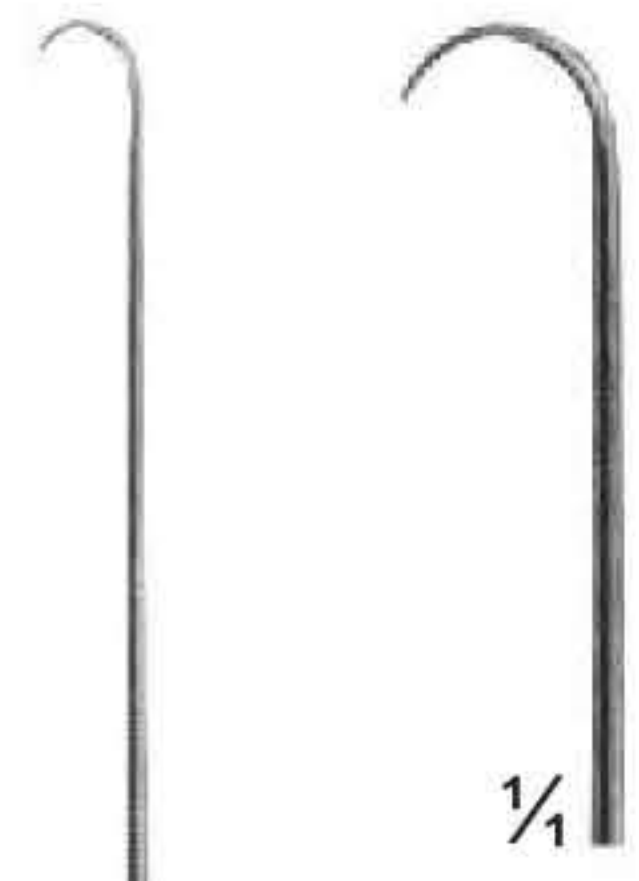

1/2

UG-816
EMMET
Fistula hook
220 mm

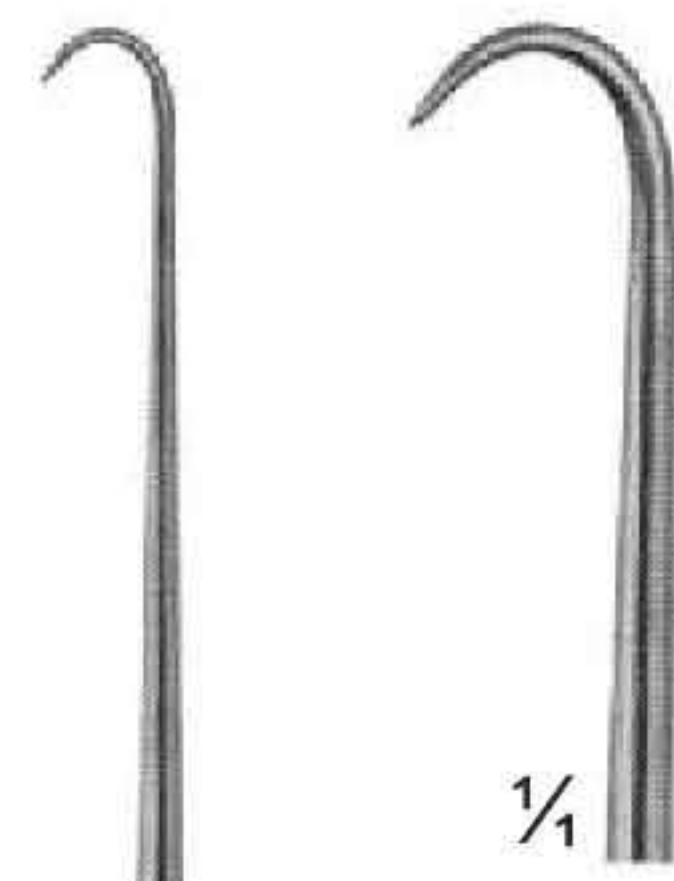

1/2

UG-817
SIMON
Fistula hook
220 mm

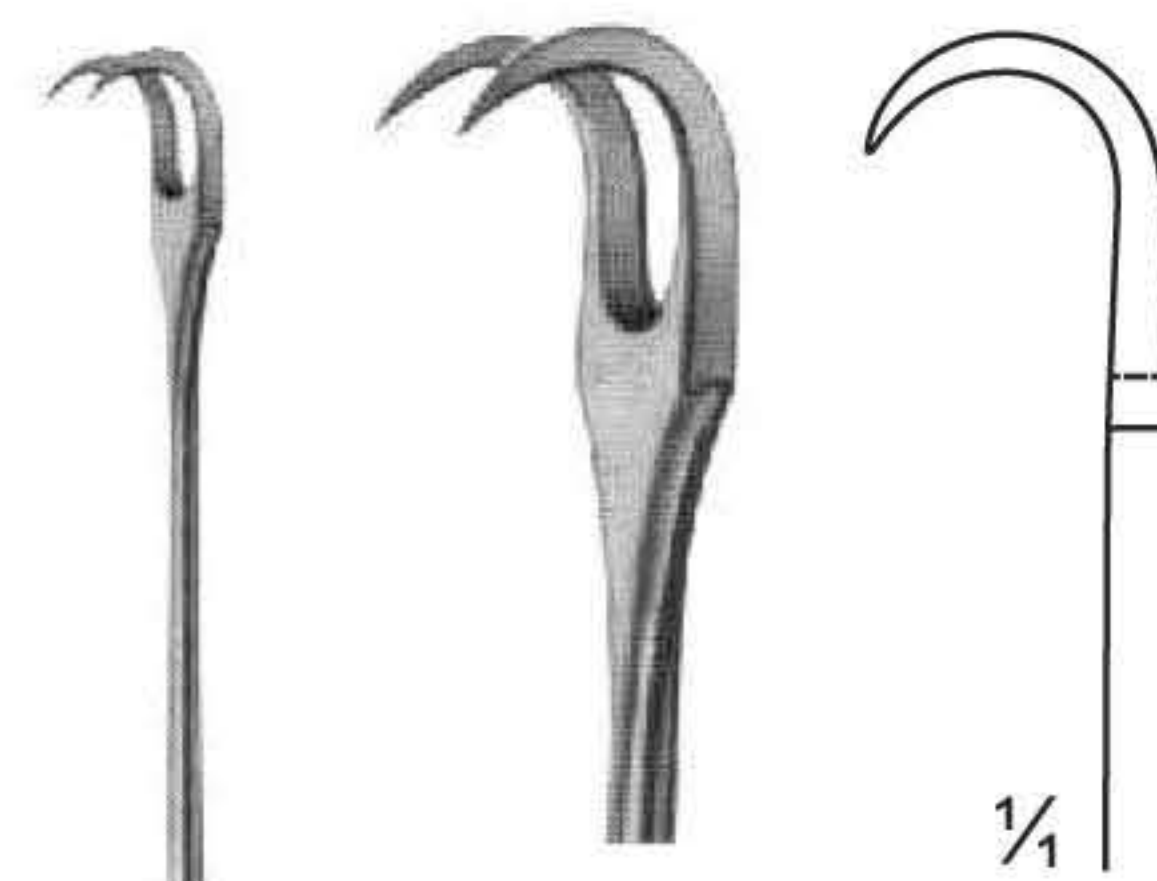

1/2

UG-818
SIMON
Fistula hook
220 mm

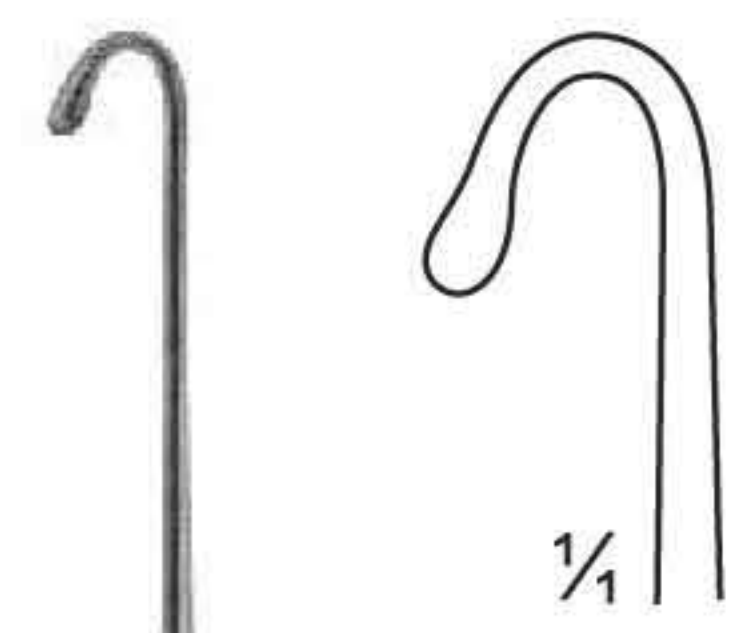

1/2

UG-819
LANGE
Fistula hook
230 mm



1/2

UG-819
Tendon hooks
175 mm

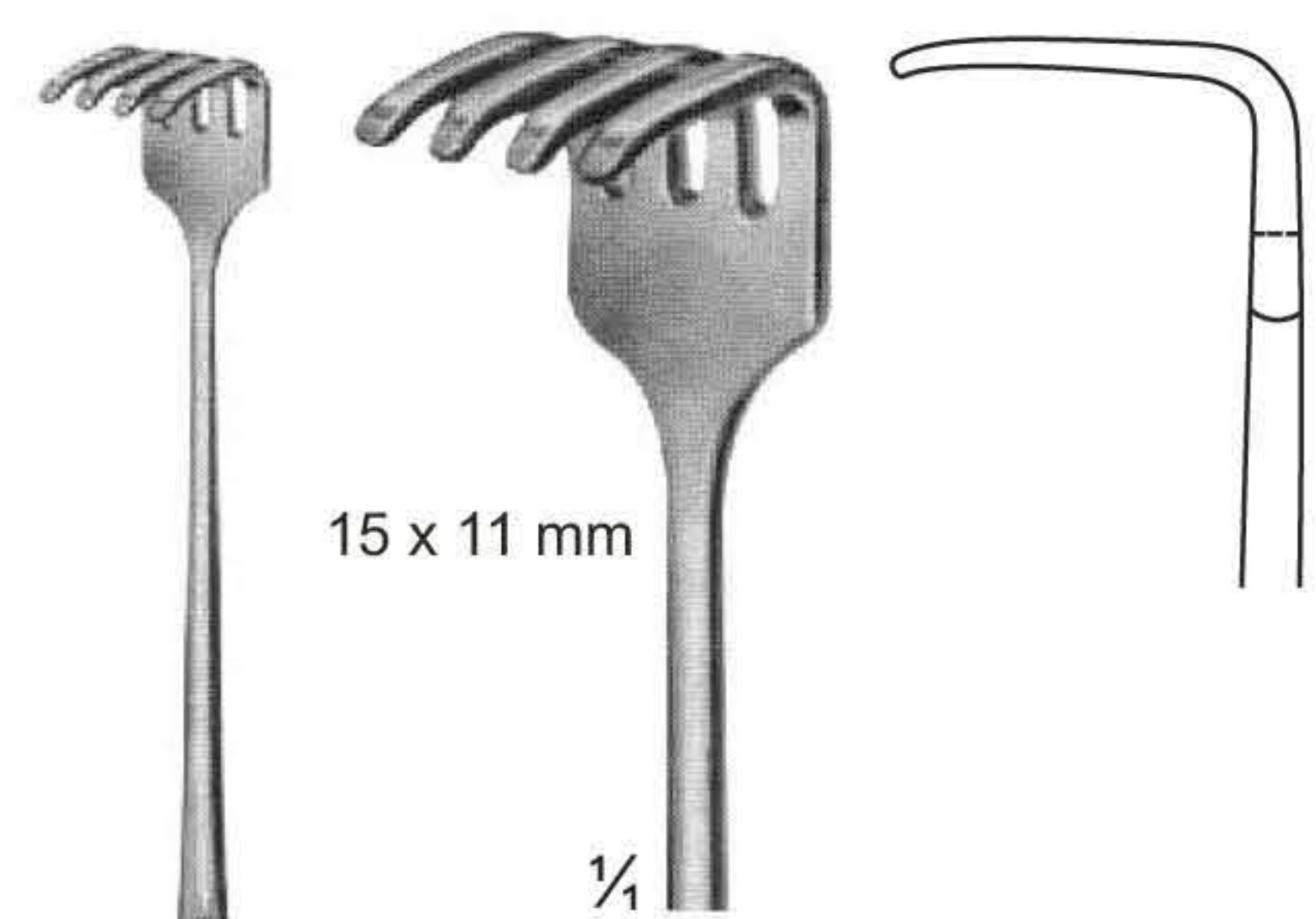

15 x 11 mm

1/4

1/2

UG-821
KLAPP
Tendon hooks
175 mm

Retractors



1/2

08-190
FOMON
145 mm

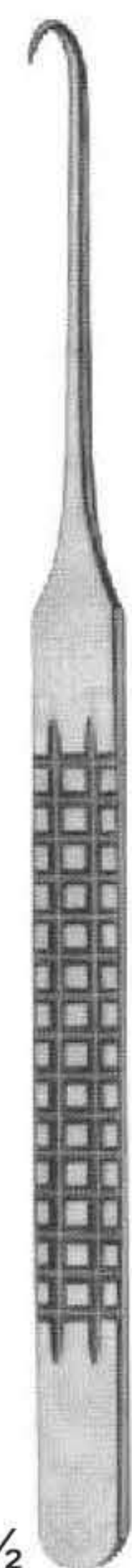

1/2

UG-805
160 mm



1/2

UG-807
LANGENBECK-GREEN
160 mm

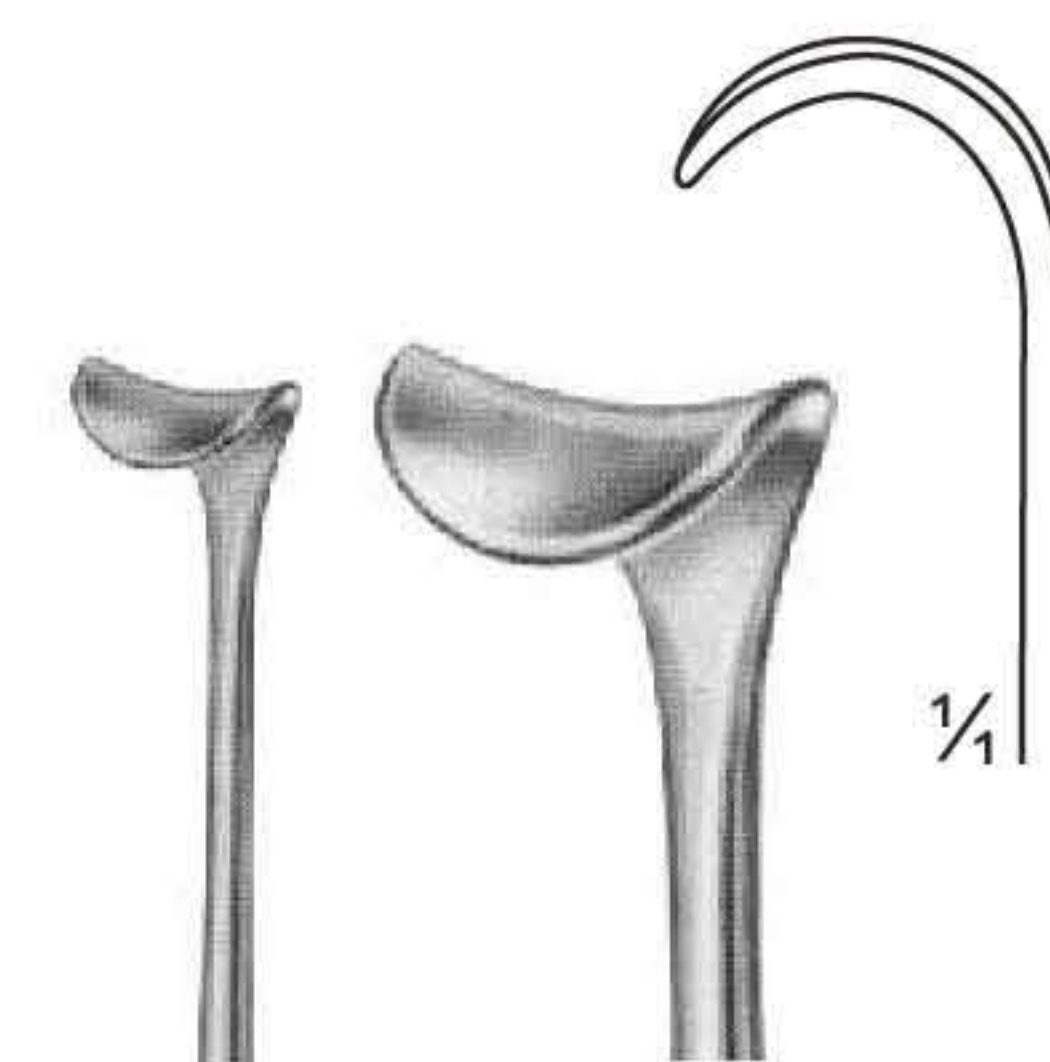

10 x 13 mm

1/2

UG-809
160 mm



1/2

UG-811
MEYERDING
Fig. A - Fig. F
180 mm



08-202

4 x 7 mm

1/2

UG-815
WILLIGER
120 mm

Retractors

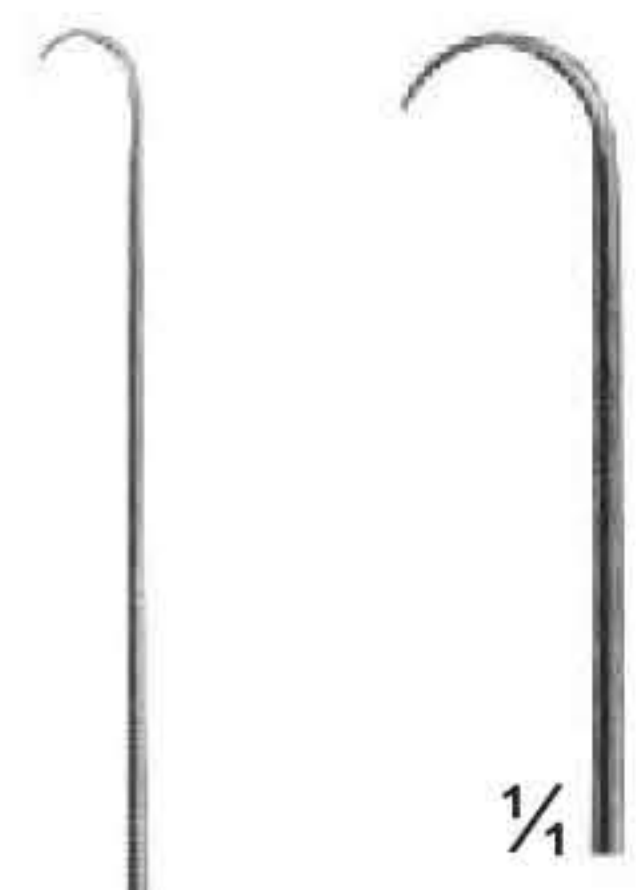

1/2

UG-816
EMMET
Fistula hook
220 mm

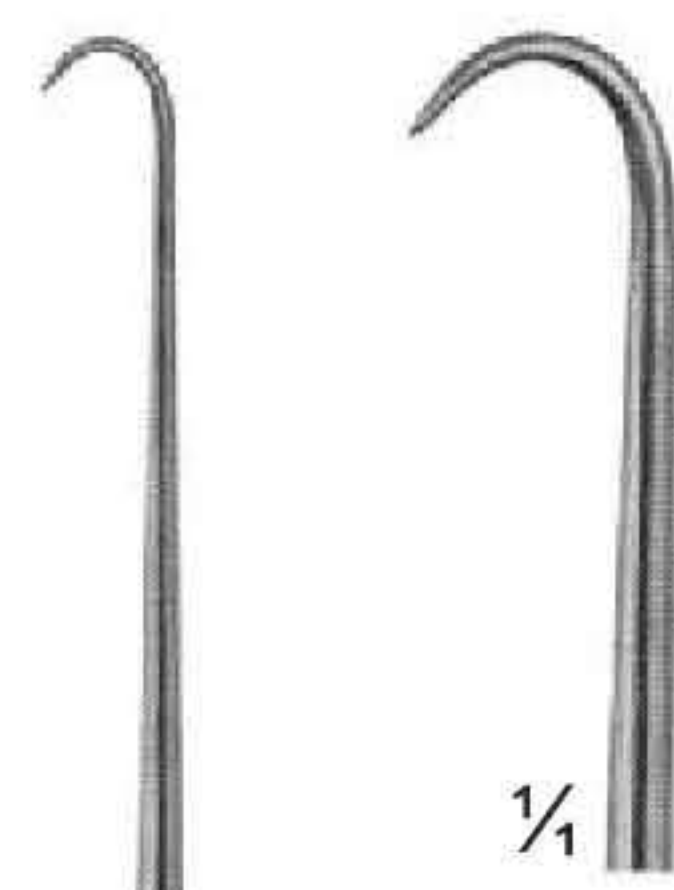

1/2

UG-817
SIMON
Fistula hook
220 mm



1/2

UG-818
SIMON
Fistula hook
220 mm



1/2

UG-819
LANGE
Fistula hook
230 mm



1/2

UG-819
Tendon hooks
175 mm

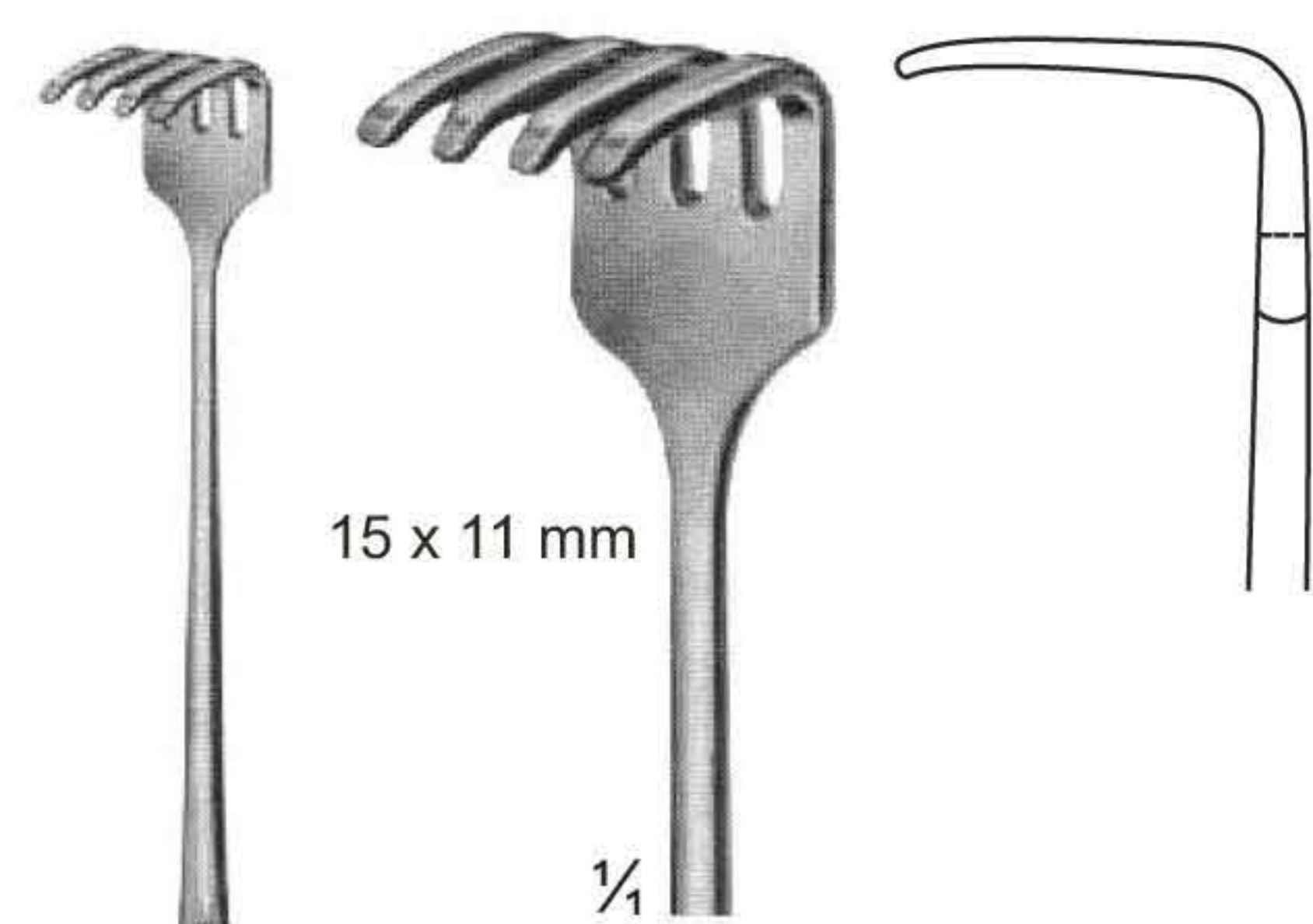

15 x 11 mm

1/4

1/2

UG-821
KLAPP
Tendon hooks
175 mm

Retractors

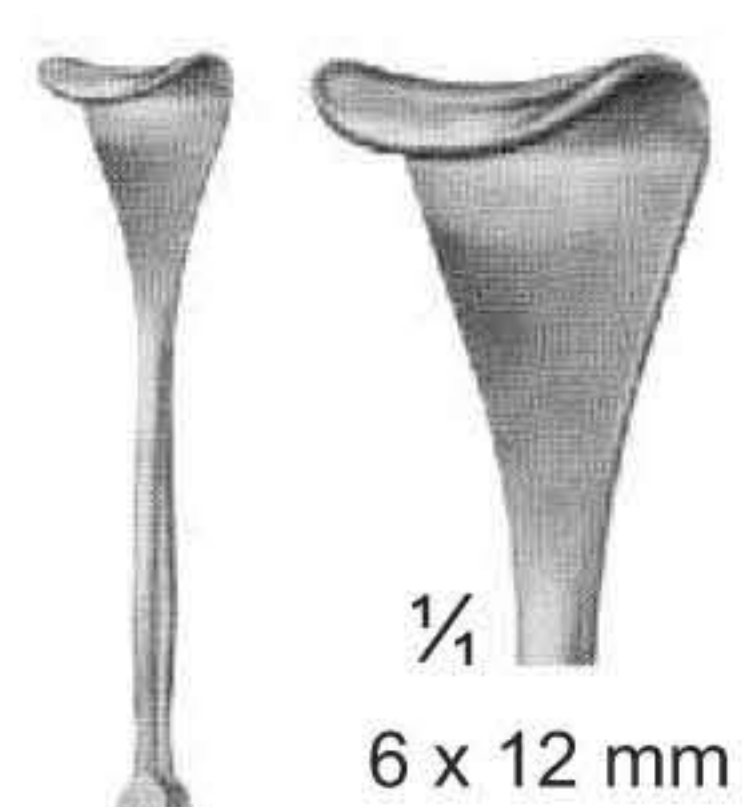

1/2
UG-822
MASING
140 mm

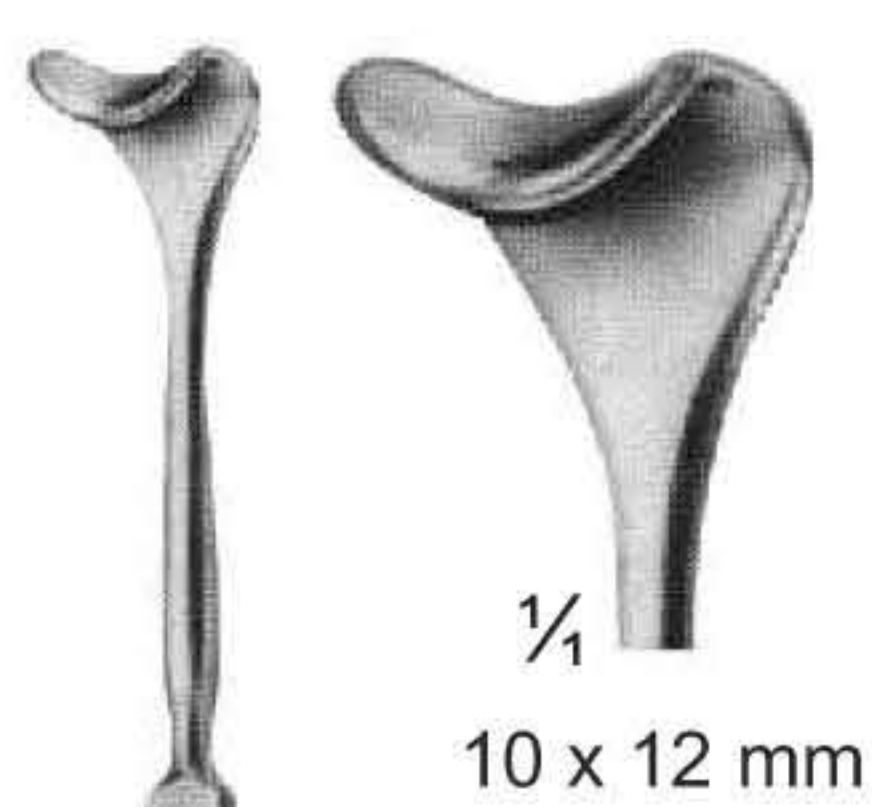

1/2
UG-823
COTTLE
140 mm



1/2
UG-824
DESMARRES
140 mm



1/2
UG-825
KONIG
180 mm

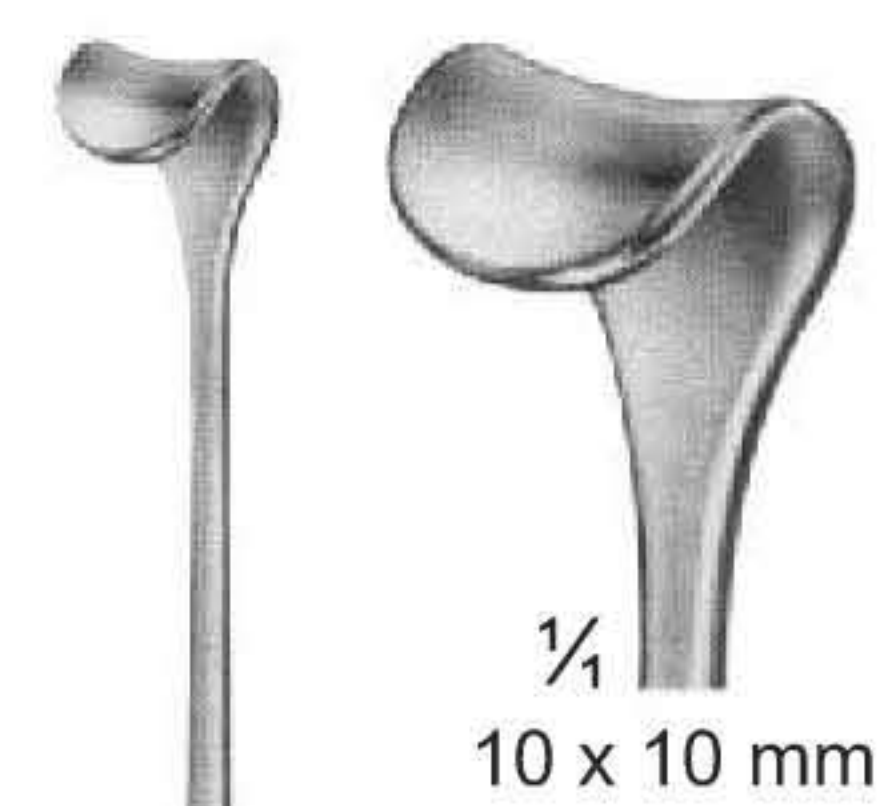

1/2
UG-826
CUSHING-KOCHER
175 mm



1/2
UG-827
KOCHER
205 mm



1/2
UG-828
SCHOENBORN
200 mm



1/2
UG-829
CUSHING
205 mm

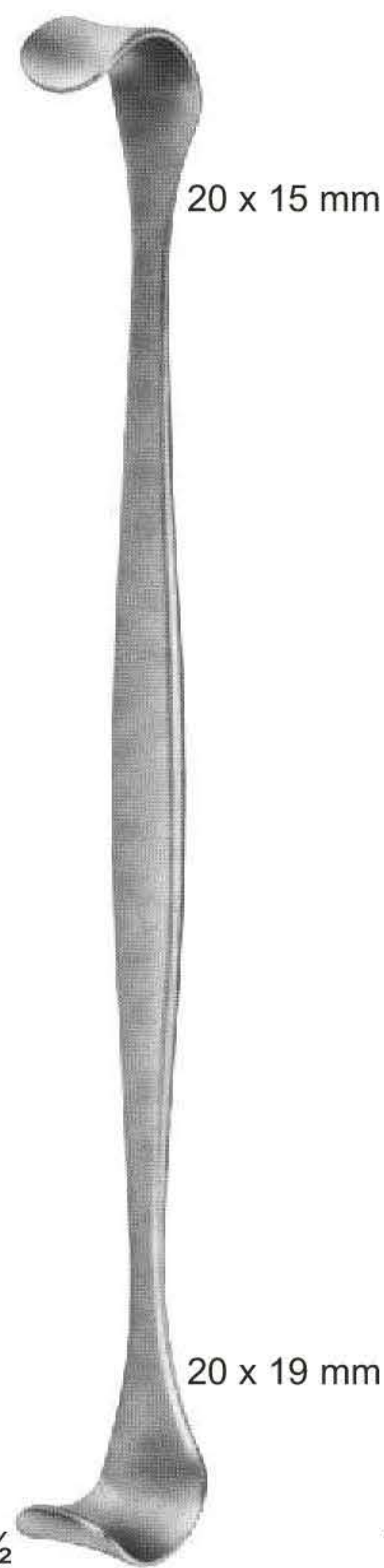

1/2
UG-830
205 mm



1/2
UG-831
CUSHING
250 mm

Retractors

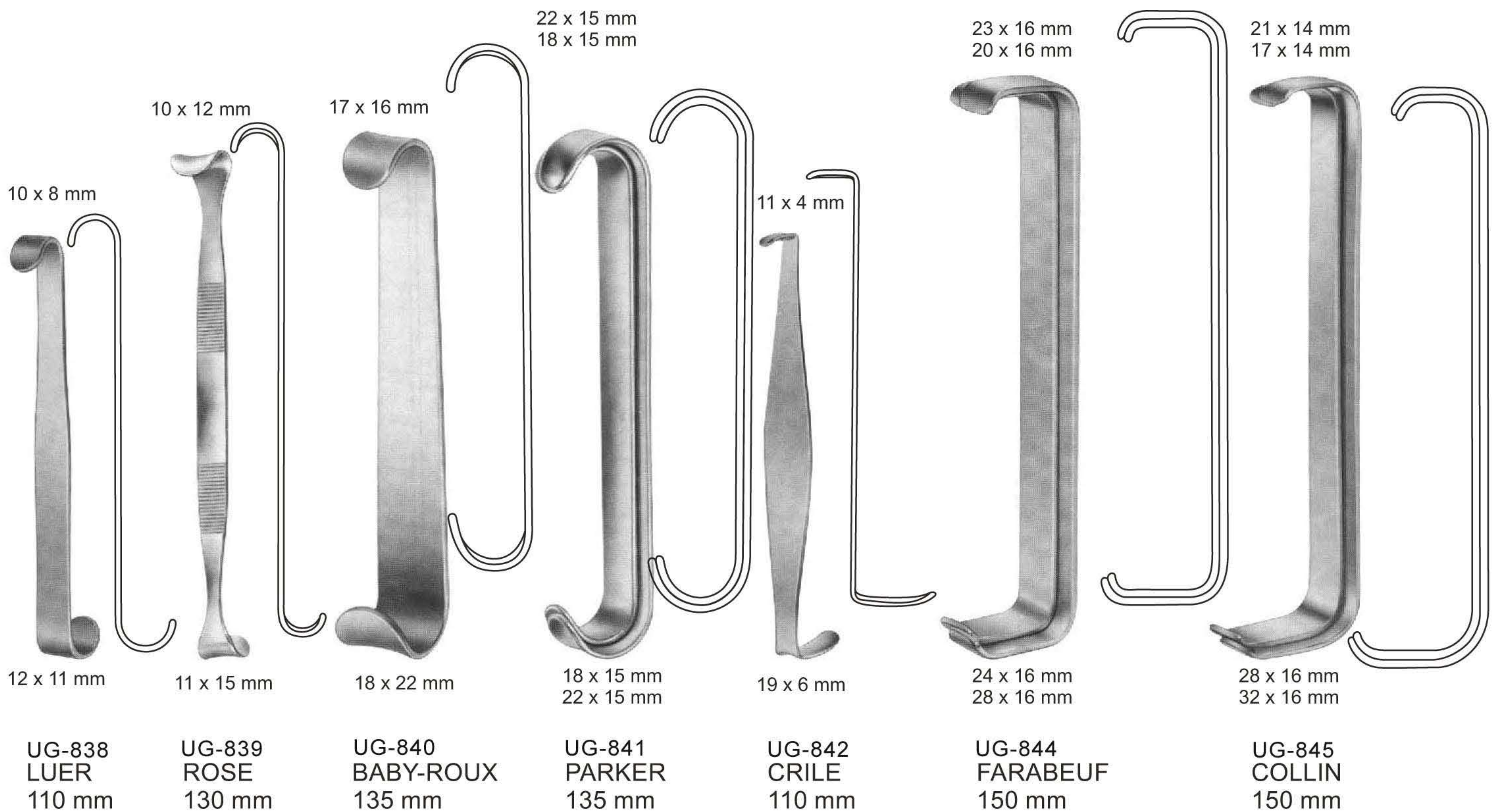

Retractors



UG-848
ROUX
Satz/Set
165 mm



UG-850
ROUX
150 mm

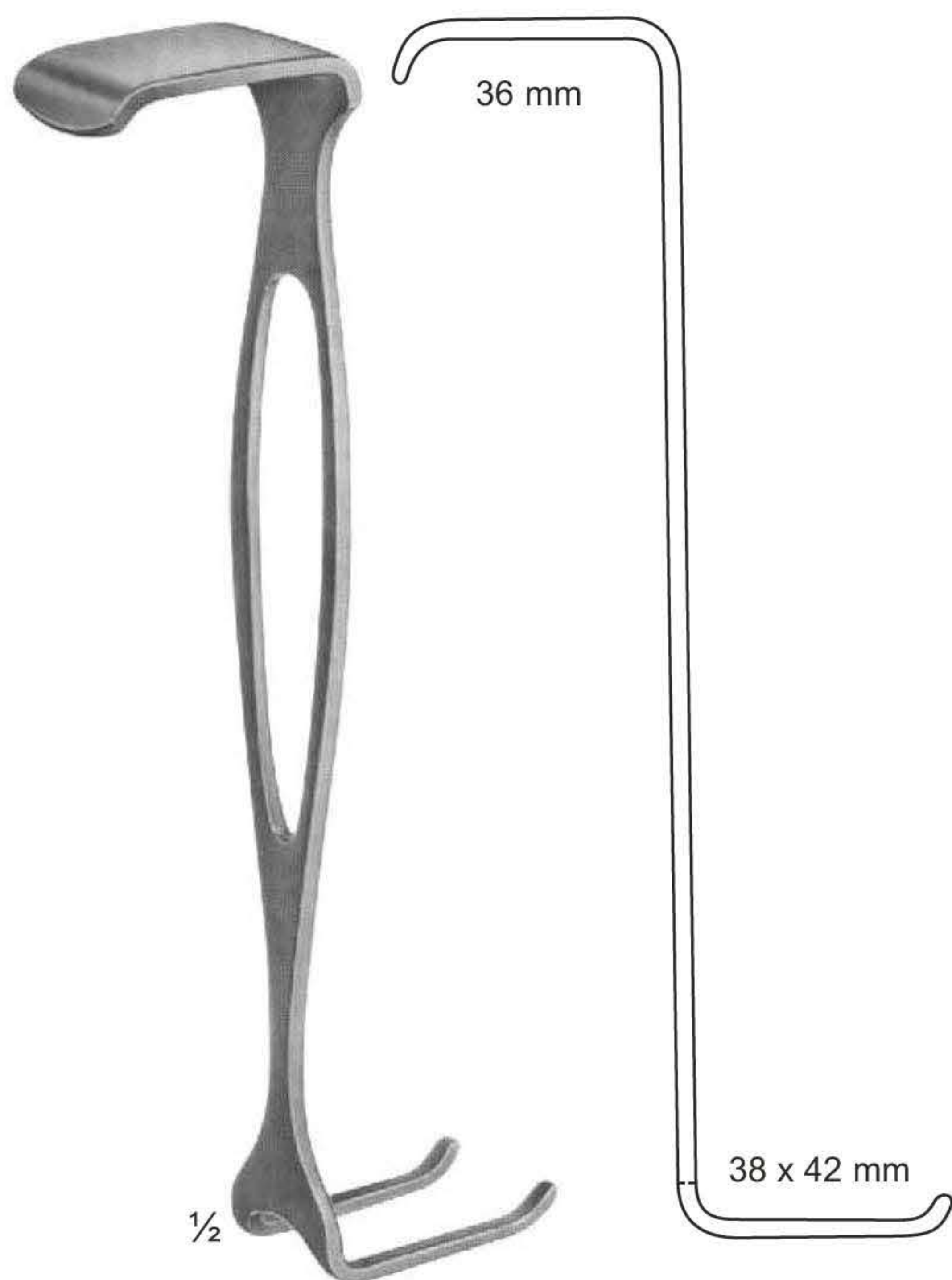

UG-852
CZERNY
175 mm

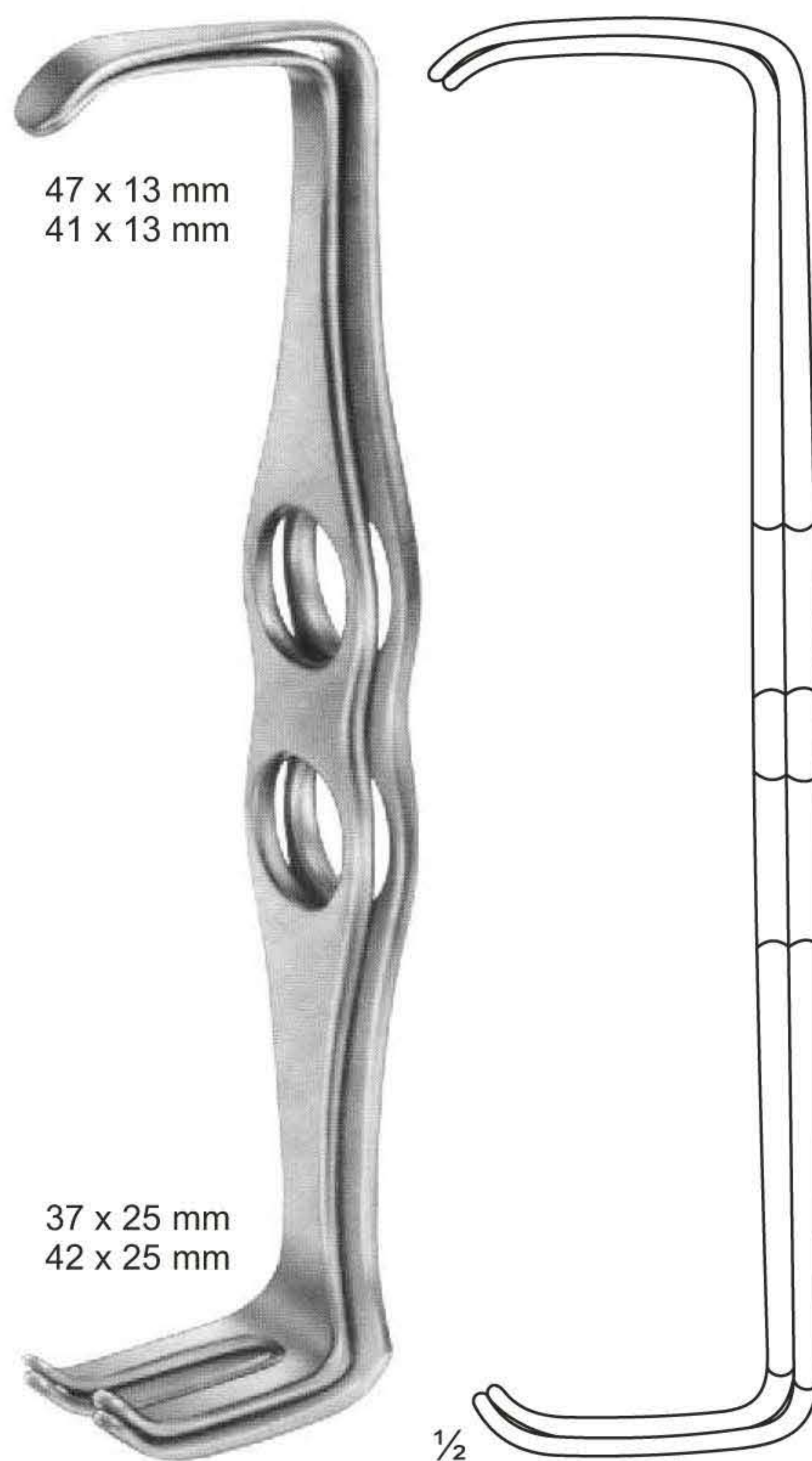

UG-853
MATHIEU
200 mm

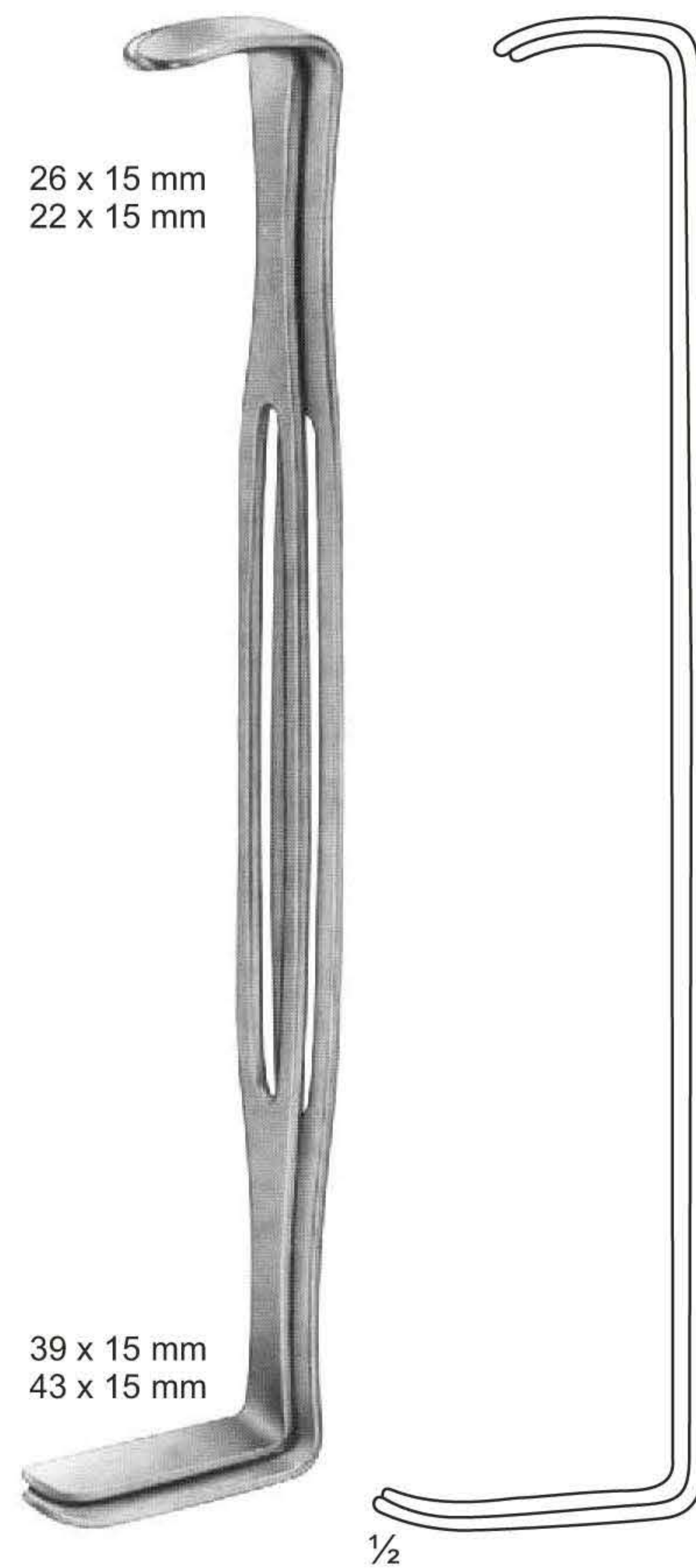

UG-855
US-ARMY
220 mm

Bone Retractors and Retractors



UG-856
KOCHER
Sharp
205 mm



UG-857
KOCHER
Sharp
220 mm

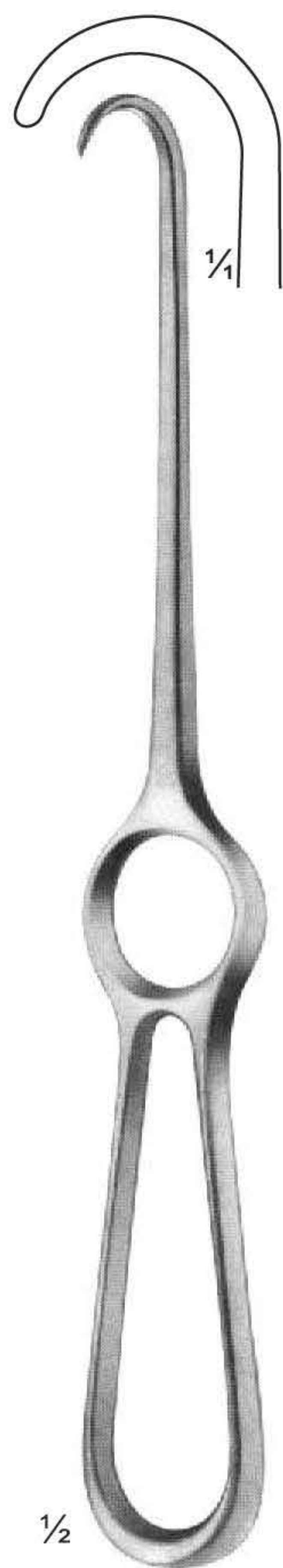

UG-859
KOCHER
Blunt
220 mm



UG-860
VOLKMANN
Sharp
220 mm

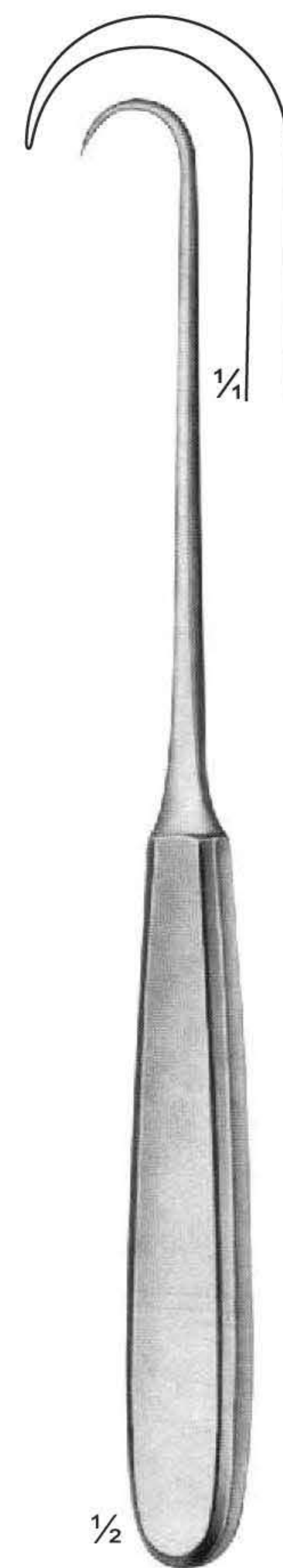

UG-861
VOLKMANN
Sharp
220 mm



UG-862
VOLKMANN
225 mm

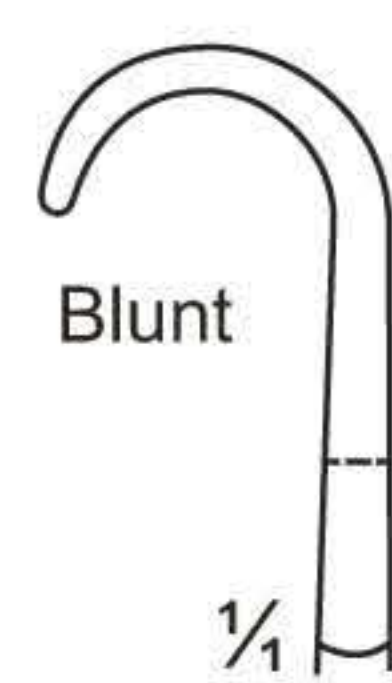
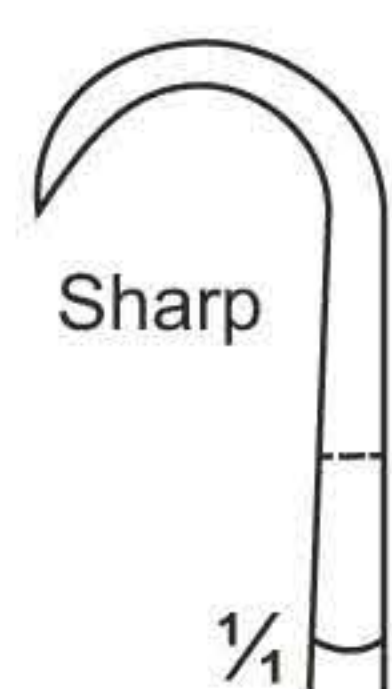

Retractors



UG-865
VOLKMANN
220 mm



UG-868
KOCHER
220 mm

Retractors, Deep form

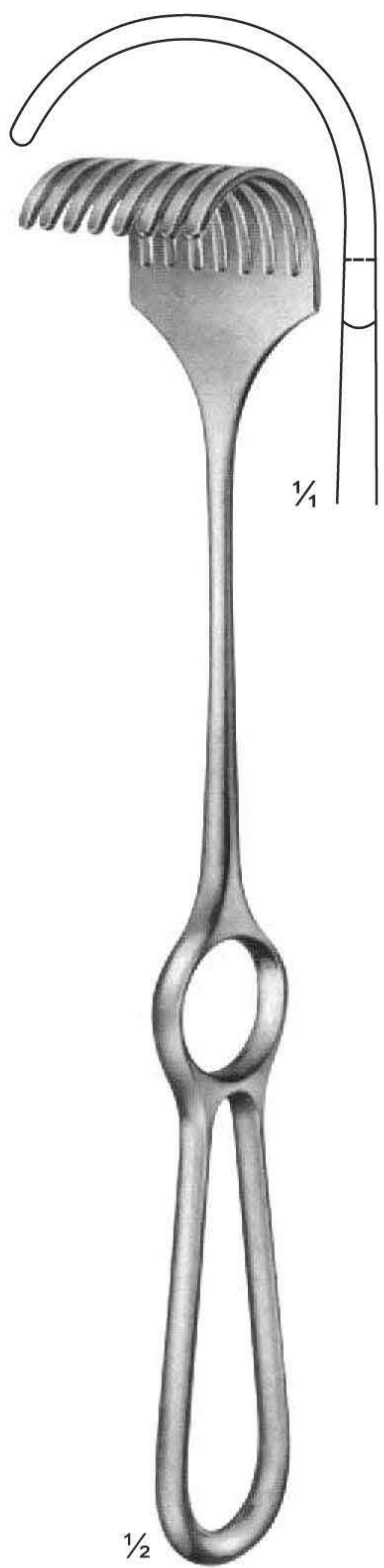

UG-870
KORTE
240 mm



UG-871
ISRAEL
255 mm

Retractors



UG-872
LANGENBECK
210 mm



UG-873
KOCHER-LANGENBECK
215 mm

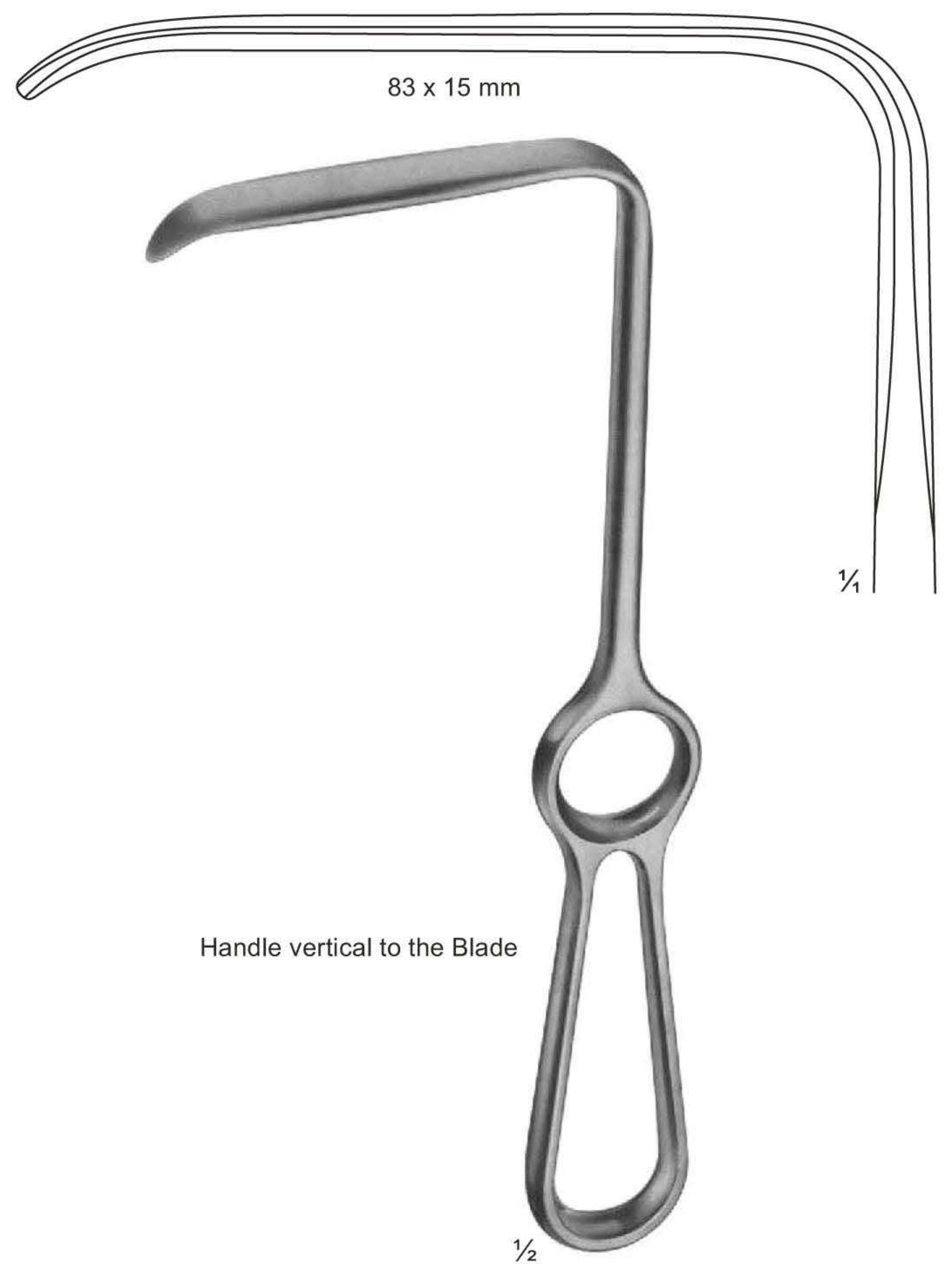

UG-874
LANGENBECK
215 mm

Autopsy & Cartilage Knives



$\frac{1}{2}$
UG-125
 Autopsy & Cartilage Knives
 SIZE:200mm

$\frac{1}{4}$
UG-126
 VIRCHOW
 SIZE:320mm

$\frac{1}{2}$
UG-128
 WALB
 SIZE:120mm

$\frac{1}{2}$
UG-133
 VIRCHOW
 SIZE:120mm

Retractors



1/2

UG-875
KOCHER
230 mm

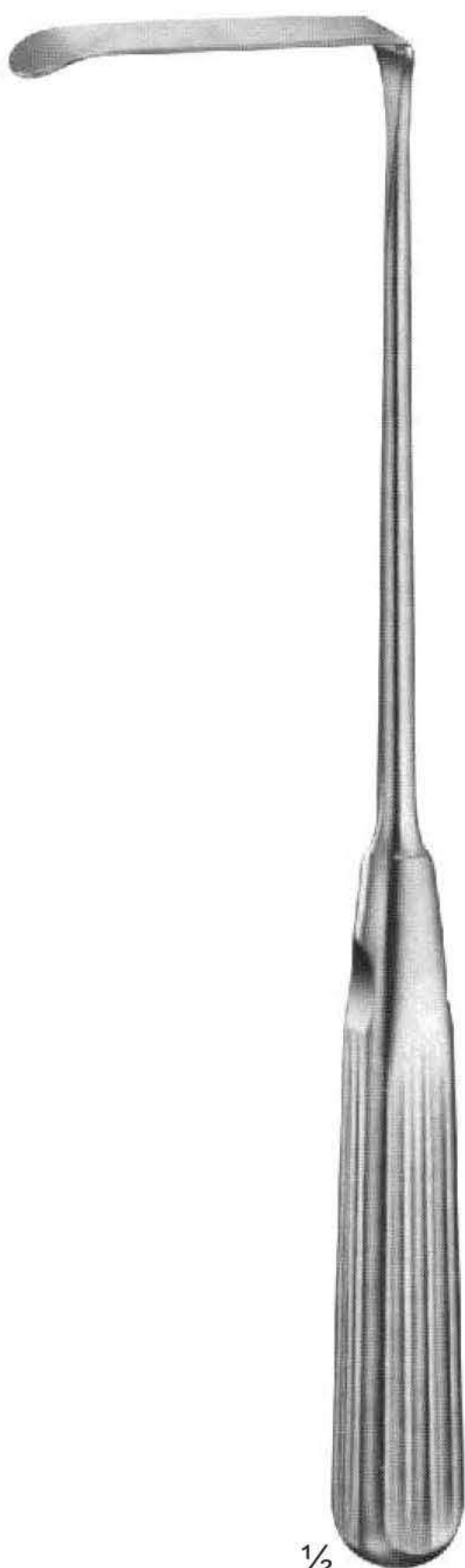

1/2

UG-876
SAUERBRUCH
225 mm

Retractors



1/2
UG-877
MIDDELDORPF

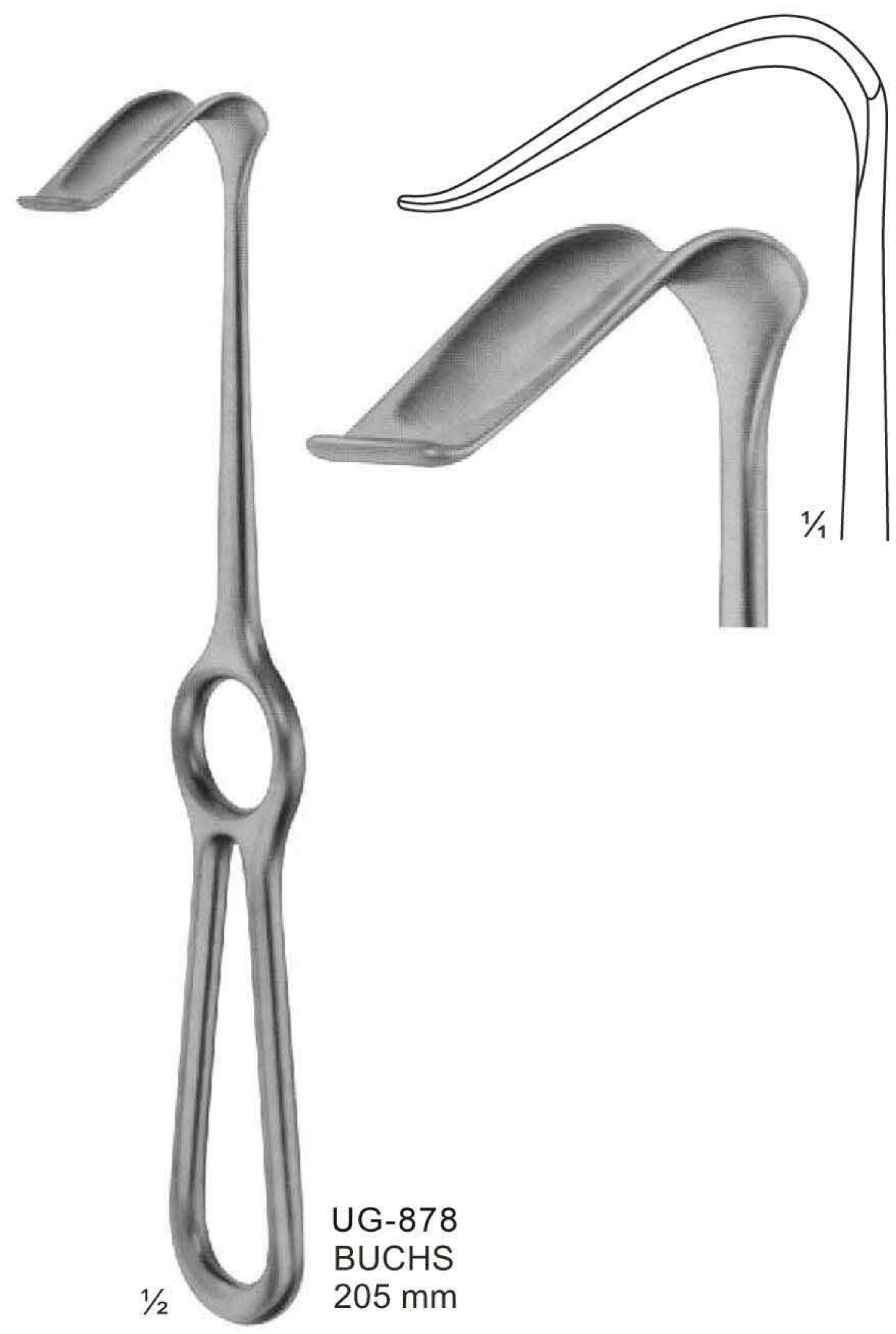

1/2
UG-878
BUCHS
205 mm



1/2
UG-879
CASPAR
210 mm

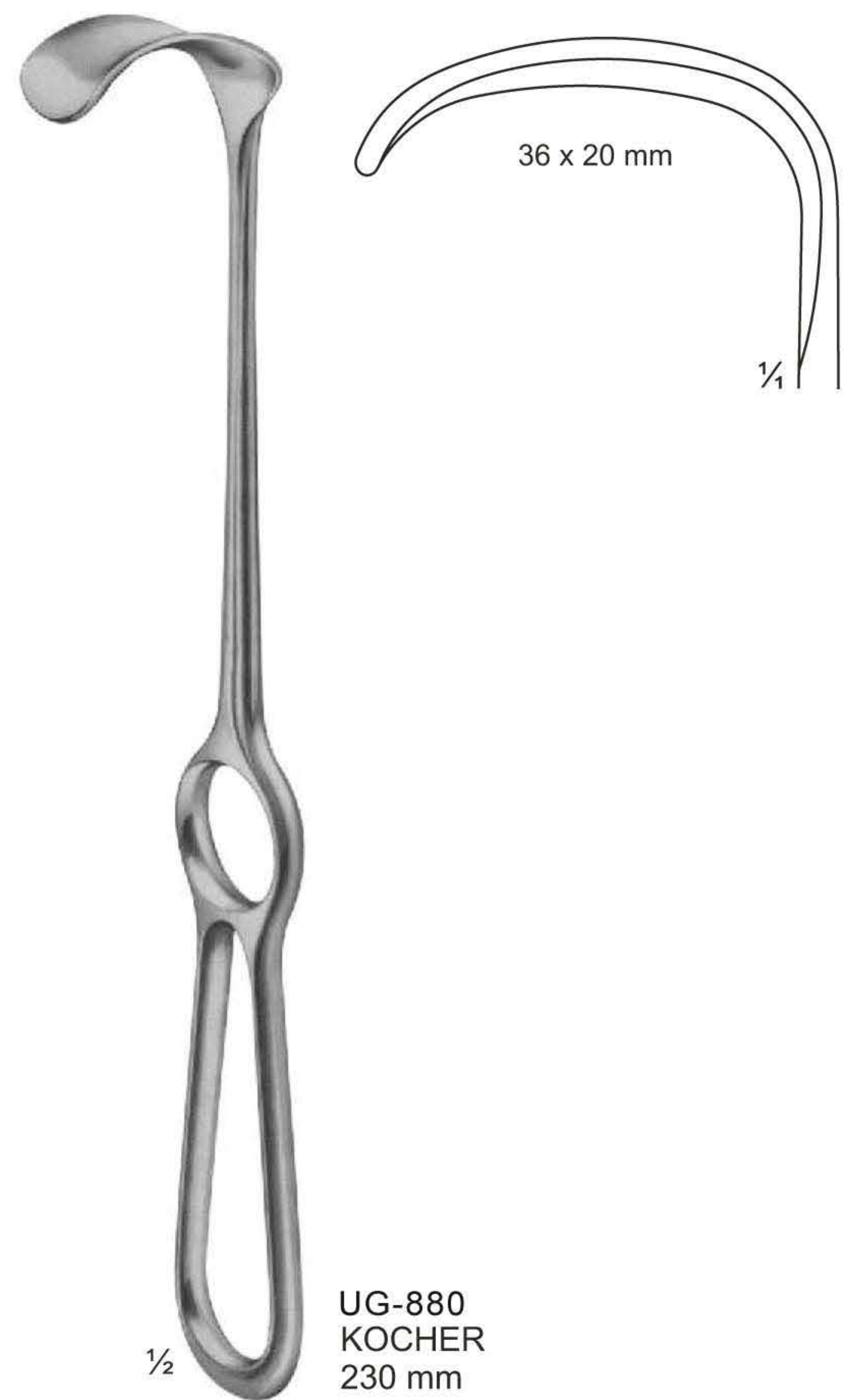

1/2
UG-880
KOCHER
230 mm

Retractors



1/2

UG-881
HOSEL
250 mm

Retractors

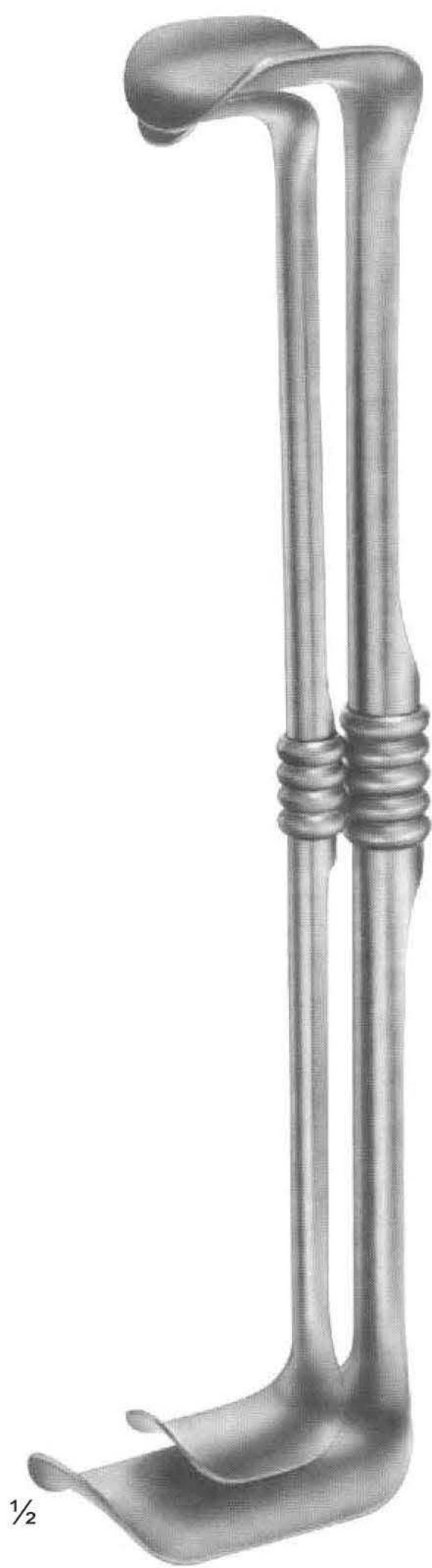

UG-882
RICHARDSON-EASTMAN
Set-250 mm

08-329 250 mm
08-330 270 mm

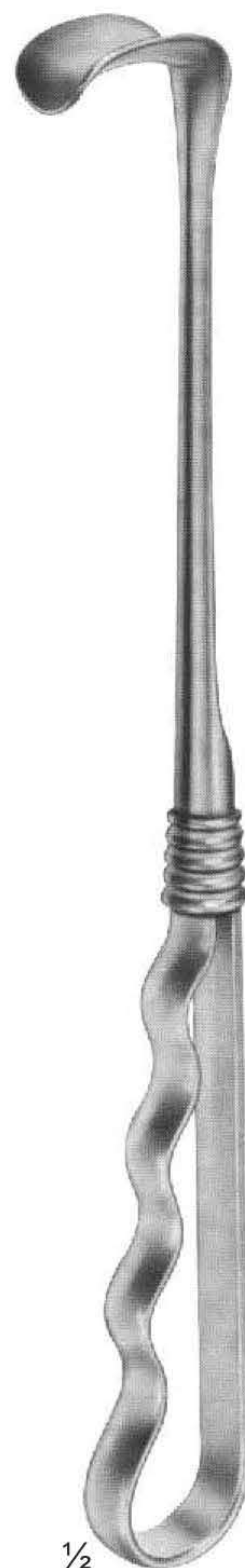

UG-883
RICHARDSON
240 mm



UG-884
RICHARDSON
240 mm

Retractors

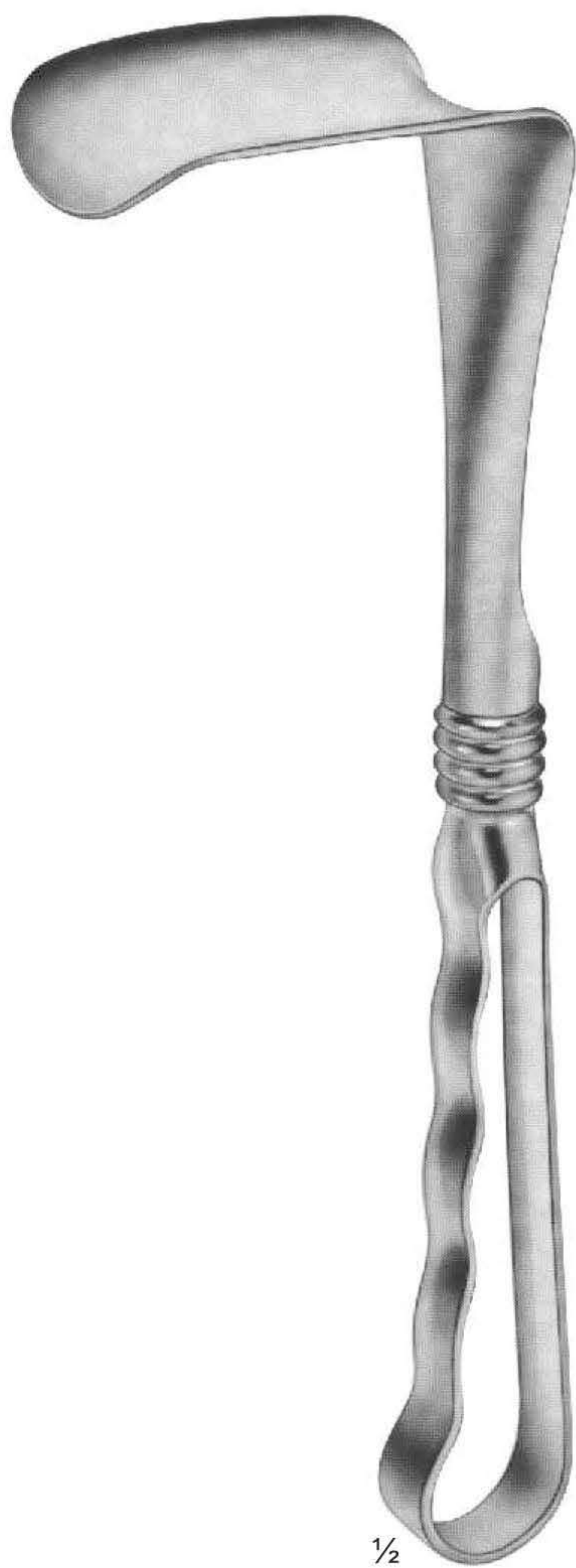

$\frac{1}{2}$
UG-885
KELLY
260 mm



$\frac{1}{2}$
UG-886
MORRIS
245 mm

Retractors For Deep Surgery

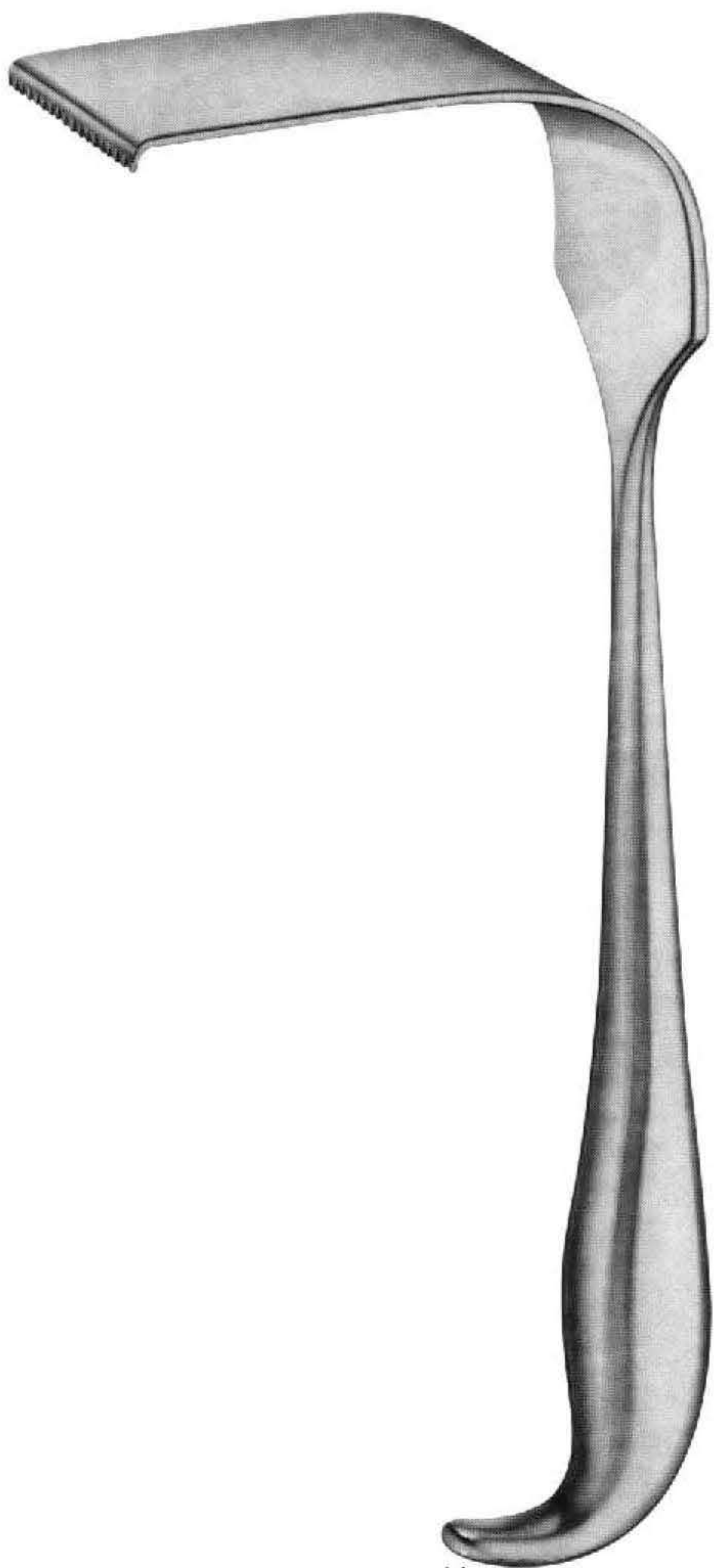

$\frac{1}{2}$
UG-893
MEYERDING
260 mm

Retractors For Deep Surgery

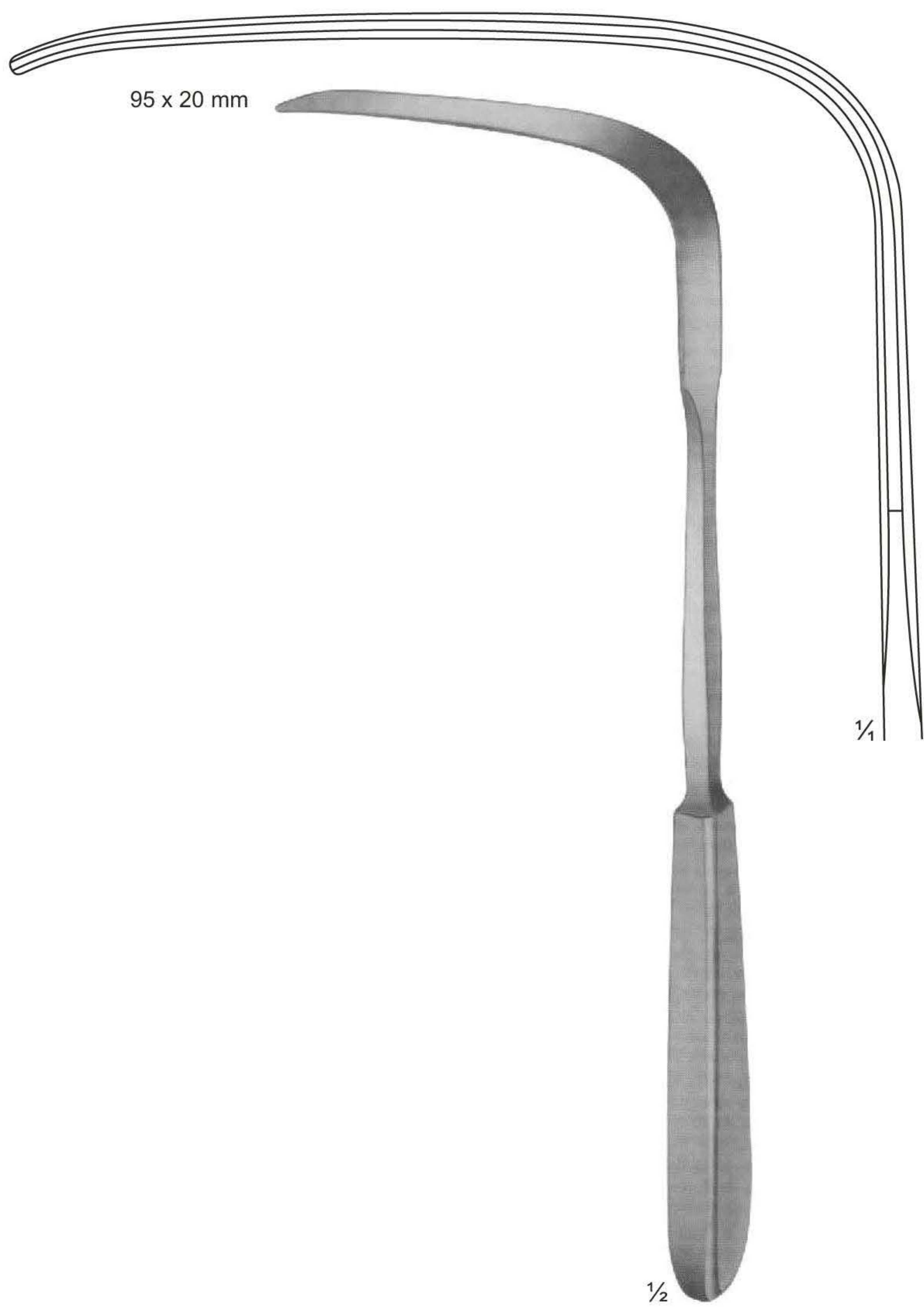

UG-895
MODELL TUBINGEN
265 mm

Vario Retractor System, Germ. Fed. Patent,
Germ. Fed. Regd.Des.



UG-900
BRUNNER
275 mm

1/2



UG-902
Handle with cold
light carrier for
retractor blades.
280 mm

1/2



Handle arrange-
ment verriable

Retractors, Lung Spatulas



UG-904
HARRINGTON
08-355 123 x 45 mm
08-356 123 x 64 mm
Flexible
295 mm



UG-906
ALLISON
255 mm

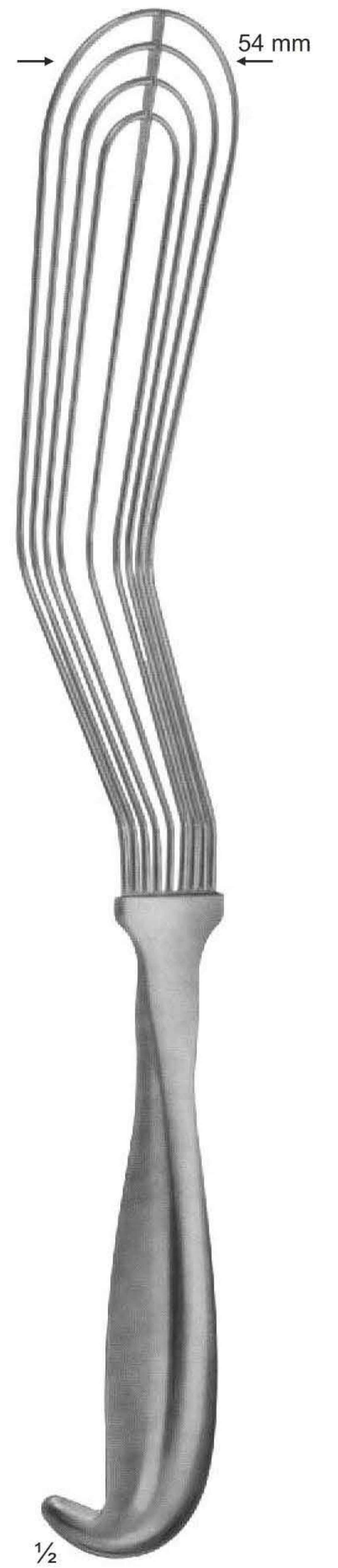

UG-907
ALLISON
320 mm

Retractors, Lung Spatulas



Scalpels, Tenotomes & Resection Knives



1/4

UG-139
GRAEFE
SIZE:155mm



1/4

UG-143
DIEFFENBACH
SIZE:155mm



1/2

UG-145
Scalpels,
Tenotomes &

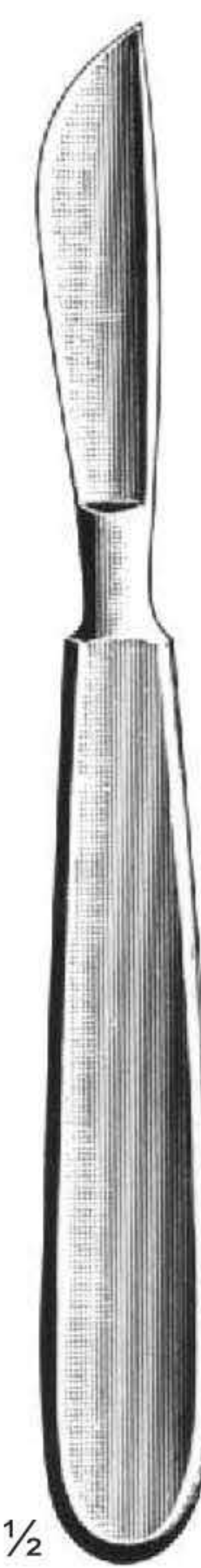

1/2

UG-148
Scalpels,
Tenotomes &

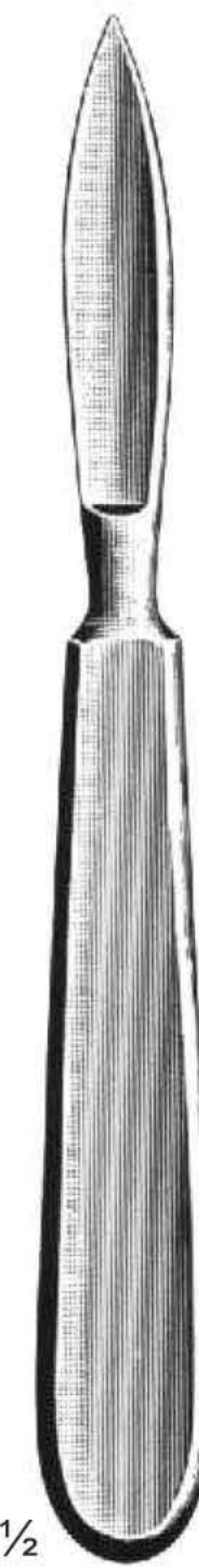

1/2

UG-149
Scalpels,
Tenotomes &
SIZE:130mm

Retractors, Lung Spatulas



Retractors, Lung Spatulas



UG-921
DEAVER
300 mm
Fig. 3

UG-922
DEAVER
310 mm
Fig. 4

UG-923
DEAVER
320 mm
Fig. 5

Retractors, Lung Spatulas

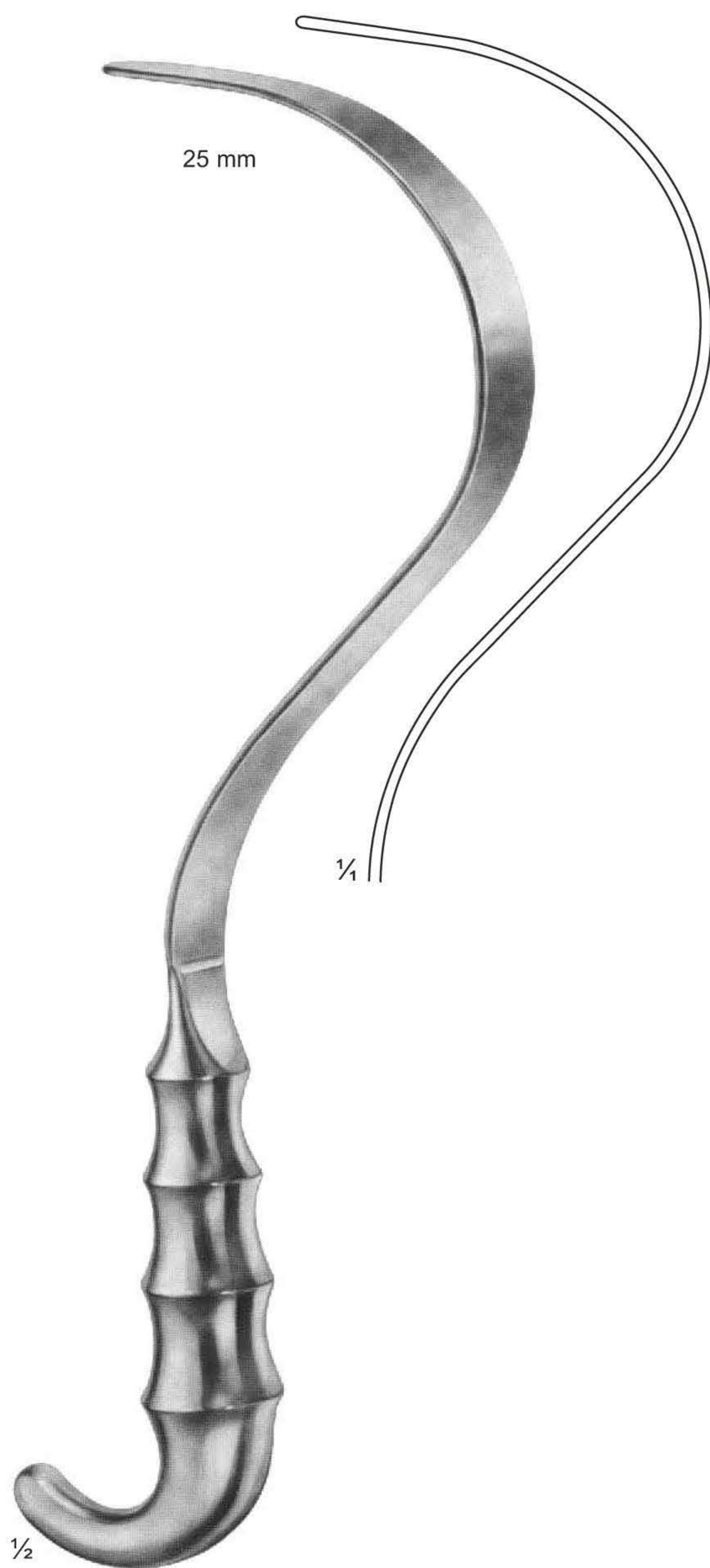

UG-924
DEAVER
310 mm
Fig. 1



UG-926
DEAVER
310 mm
Fig. 3

Retractors, Lung Spatulas

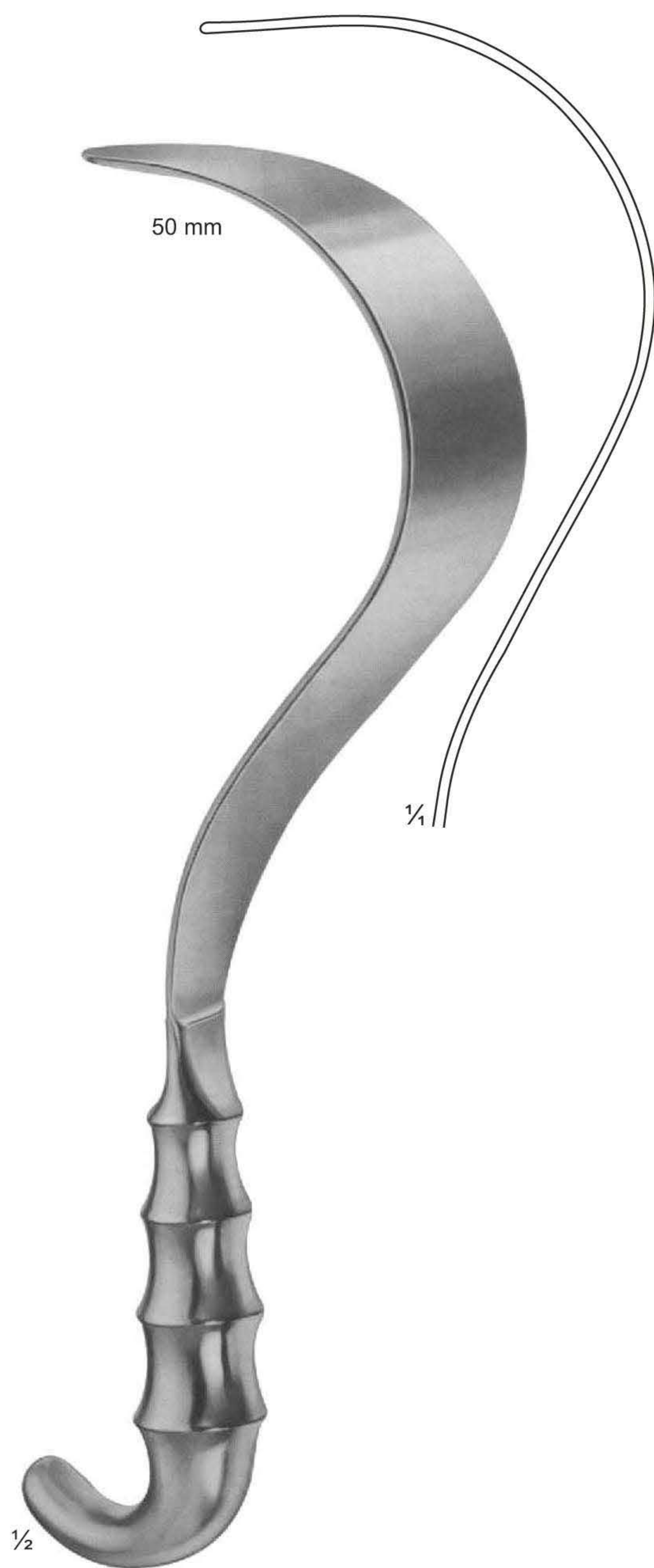

UG-927
DEAVER
305 mm
Fig. 3



UG-928
DEAVER
310 mm
Fig. 4

Retractors For Deep Surgery (Abdominal Retractors)

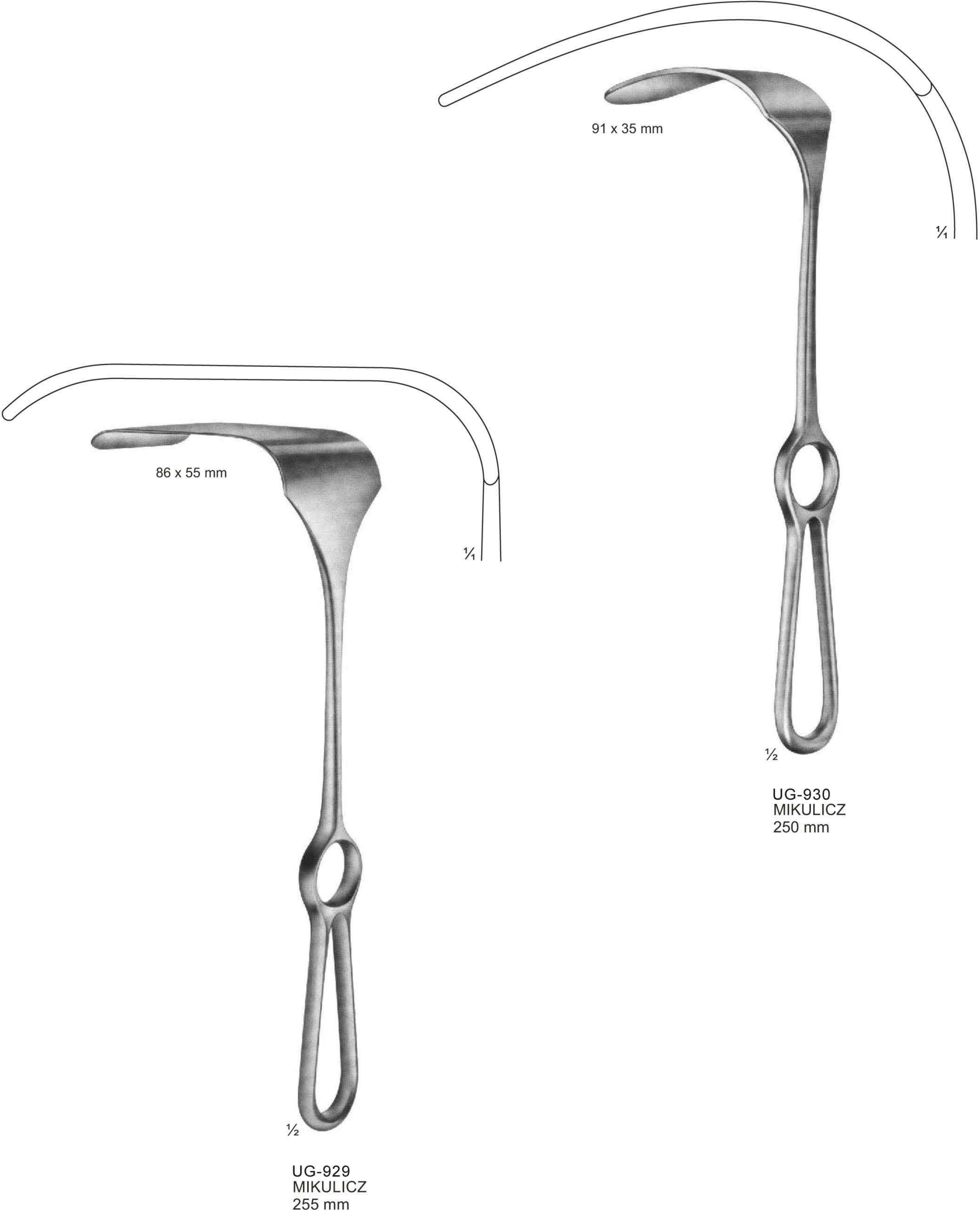

Retractors For Deep Surgery (Abdominal Retractors)



UG-931
08-376 121 x 50 mm
08-377 147 x 50 mm
Liver Retractor
250 mm

$\frac{1}{2}$
UG-932
KELLY
08-378 150 x 39 mm
08-379 150 x 57 mm
260 mm

Retractors, Abdominal Retractors

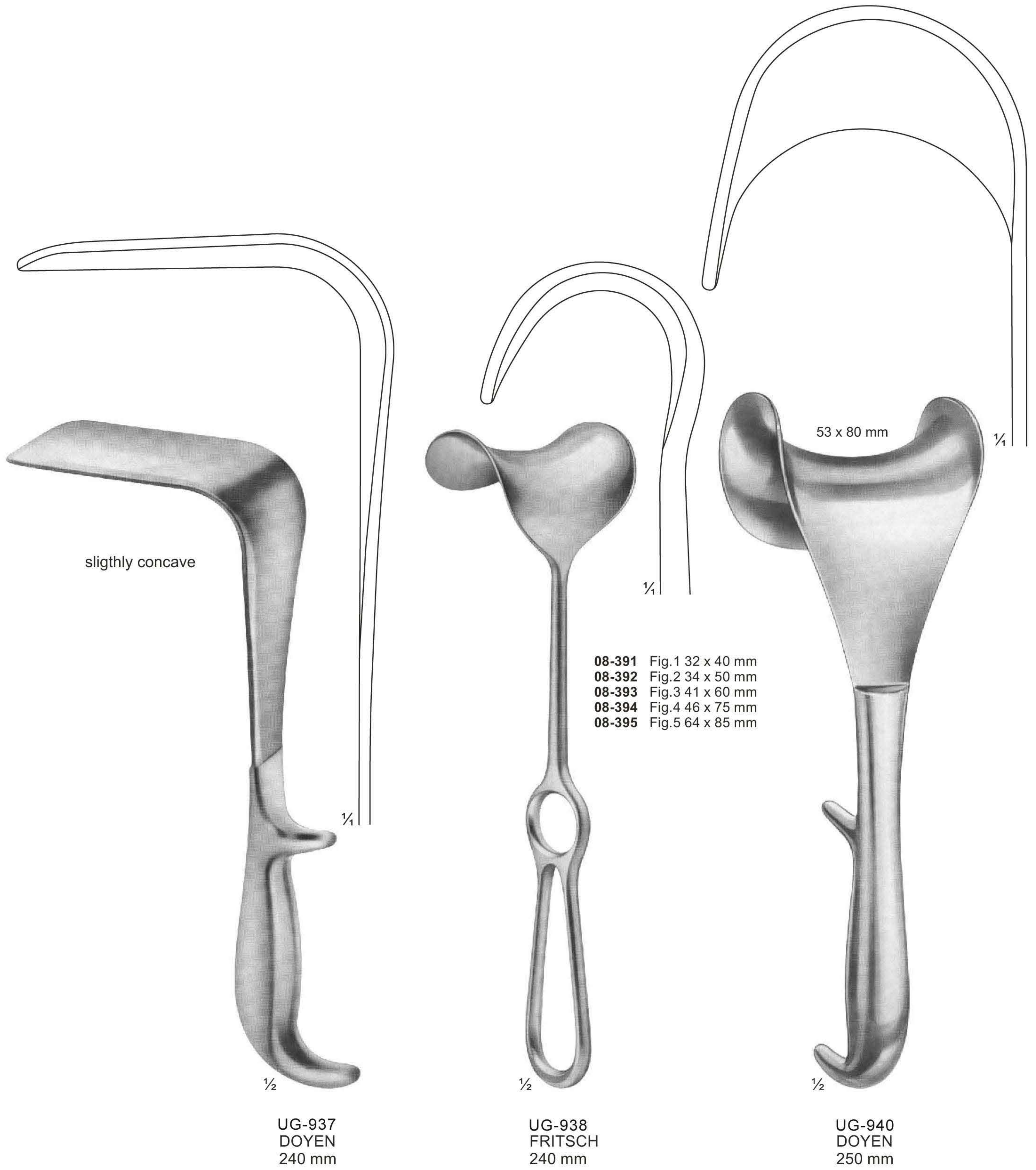

Abdominal Retractors



UG-942
ROCHARD
310 mm
08-397 48 x 90 mm
08-398 48 x 105 mm
08-399 48 x 120 mm
08-400 48 x 135 mm
08-401 48 x 155 mm

1/3



1/3

UG-954



1/3

UG-995
DOYEN
280 mm
08-403 48 x 90 mm
08-404 48 x 105 mm
08-405 48 x 120 mm
08-406 48 x 135 mm



1/3

UG-958
DOYEN-CHILD
Fixation device
220 mm



UG-960
Chain with
weight (747 / 645g)
790 mm

Pelvis Retractors

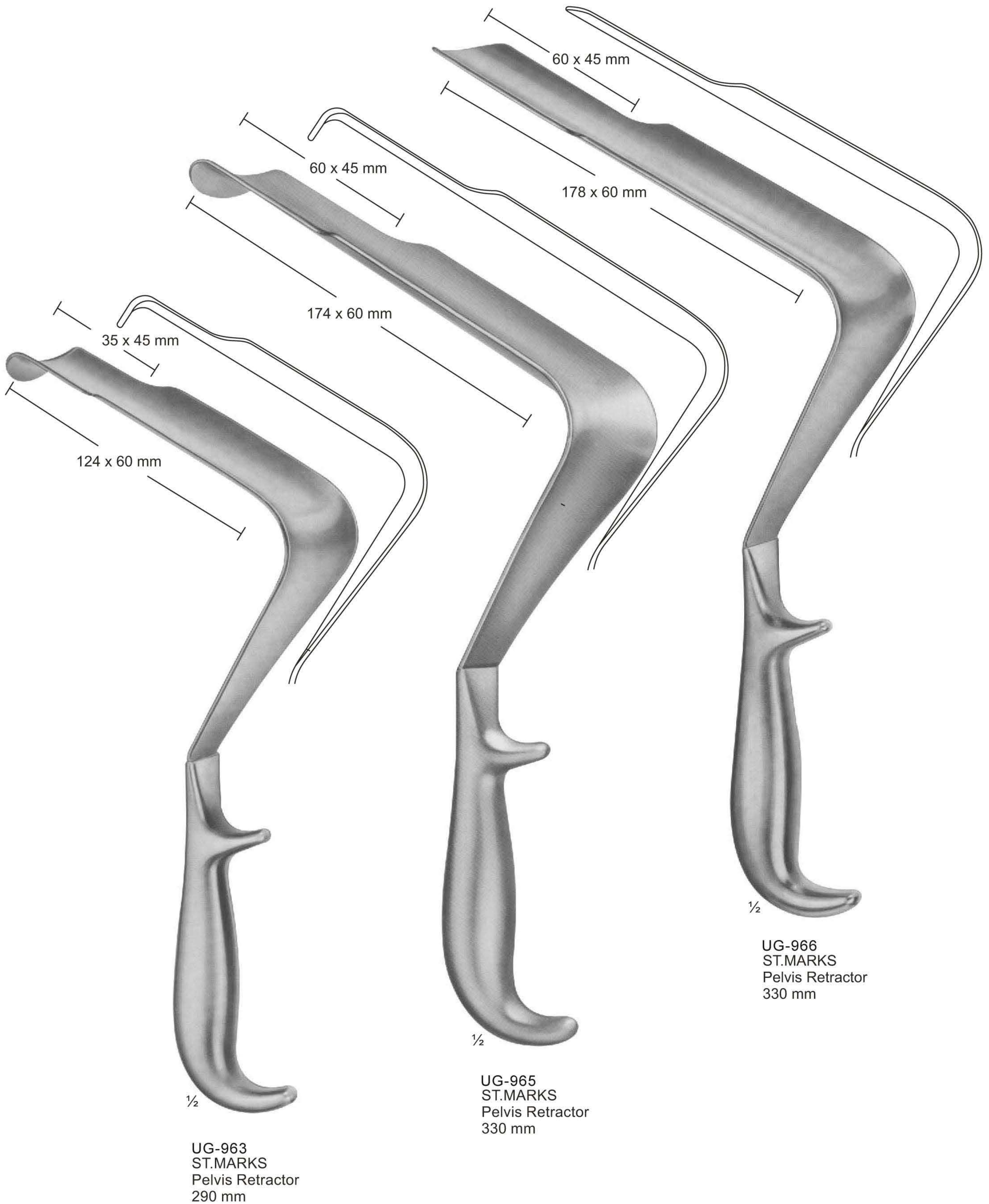

Abdominal- and Intestinal Spatulas



UG-967
LERICHE
255 mm

UG-968
KUMMEL
Malleable
285 mm

UG-970
MIKULICZ
29 mm
250 mm

UG-971
KADER
08-415 30 mm
08-416 40 mm
270 mm



UG-150
Scalpels,
Tenotomes &
Resection

SIZE:100mm

Abdominal- and Intestinal Spatulas



UG-972
REVERDIN
285 mm



UG-973
HABERER
Malleable
305 mm



UG-974
Malleable
330 mm



UG-977
TUFFIER
Melleable
200 mm

Self-Retaining Retractors



UG-978
BOSE
60 mm



UG-980
FINSEN
50 mm



UG-981
FINSEN
70 mm



UG-983
FINSEN modif.
75 mm



UG-984
45 mm



08-428
55 mm



UG-985
MUELLER
65 mm



UG-986
100 mm



08-431



08-432

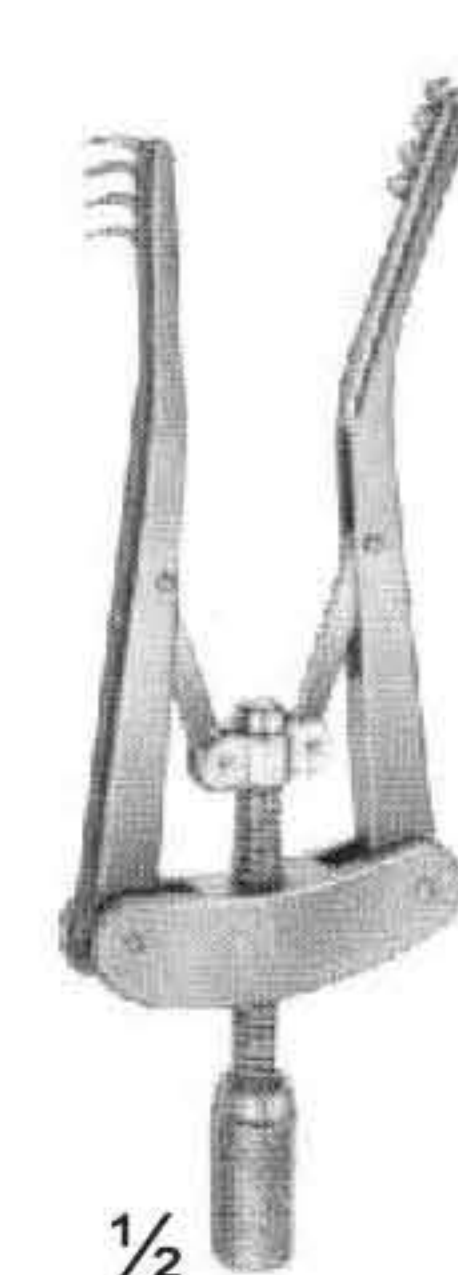

UG-987
ALM
08-431 70 mm
08-432 100 mm

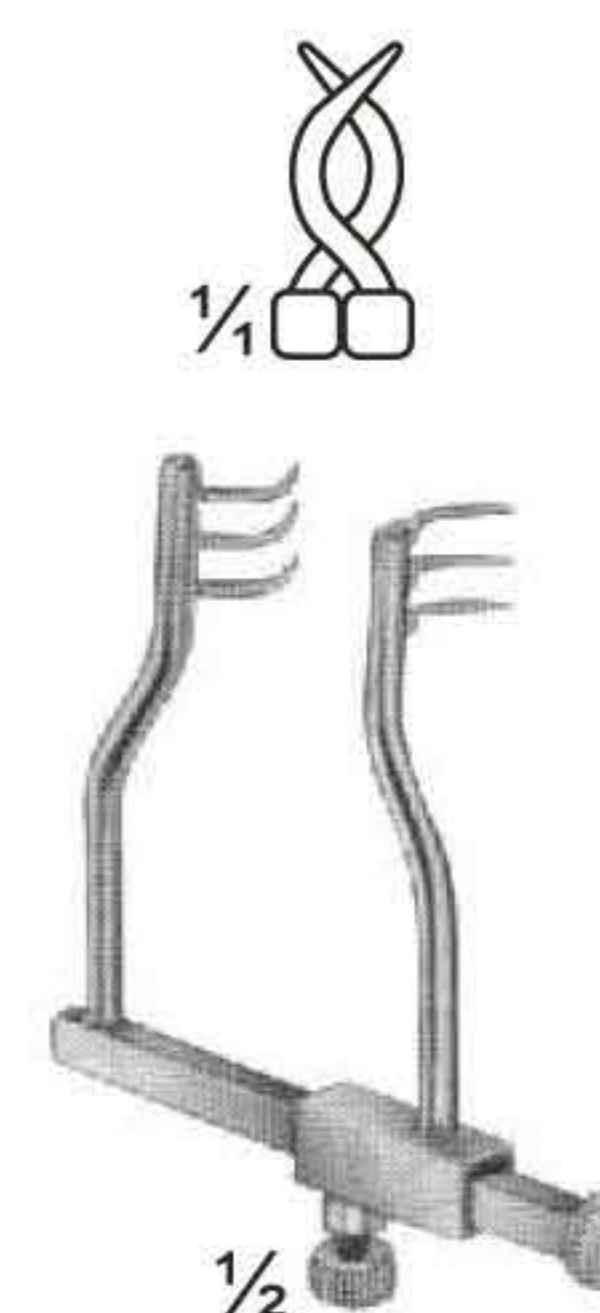

UG-988
LOGAN
modif. REILL
50 mm

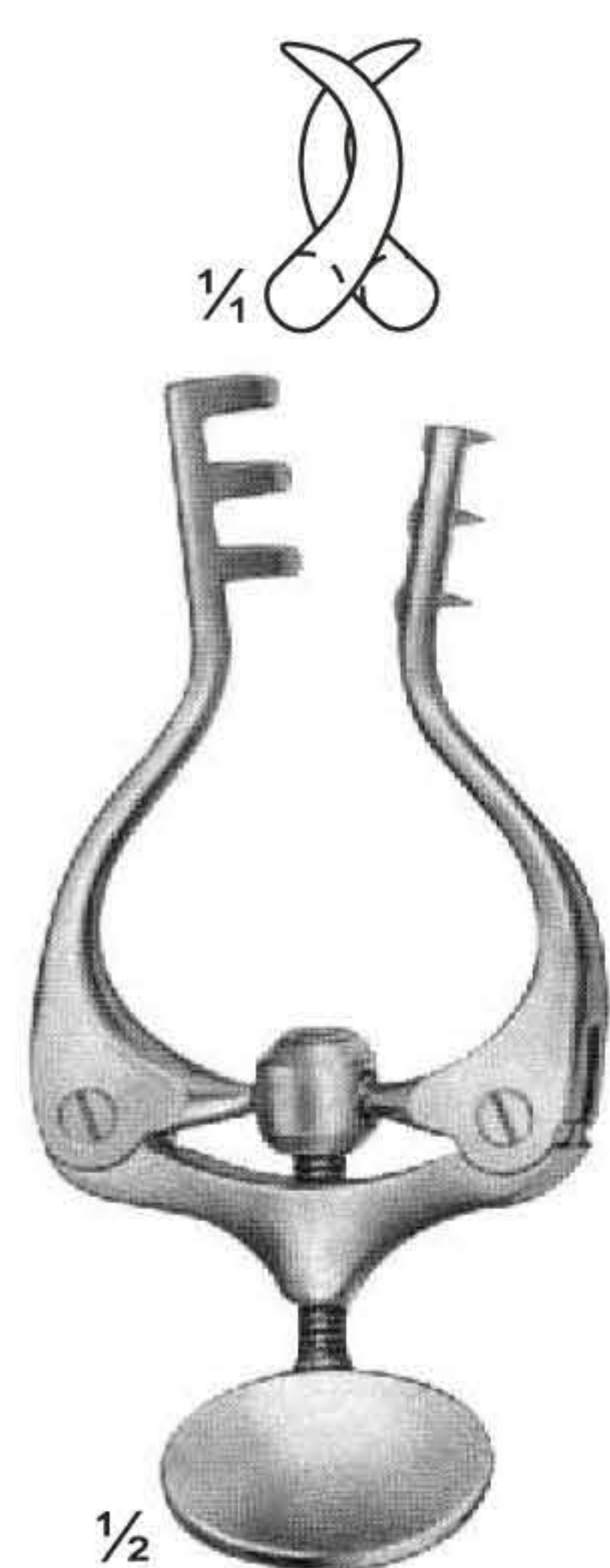

UG-989
JANSEN
100 mm

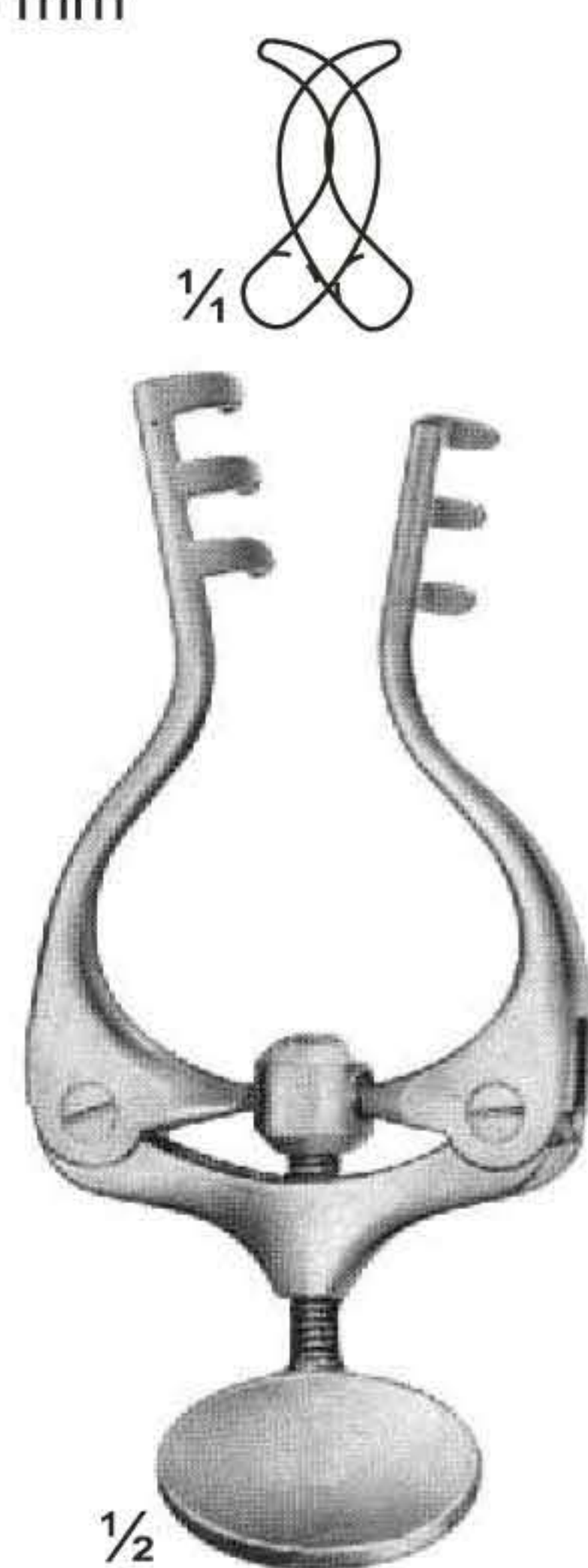

UG-990
100 mm

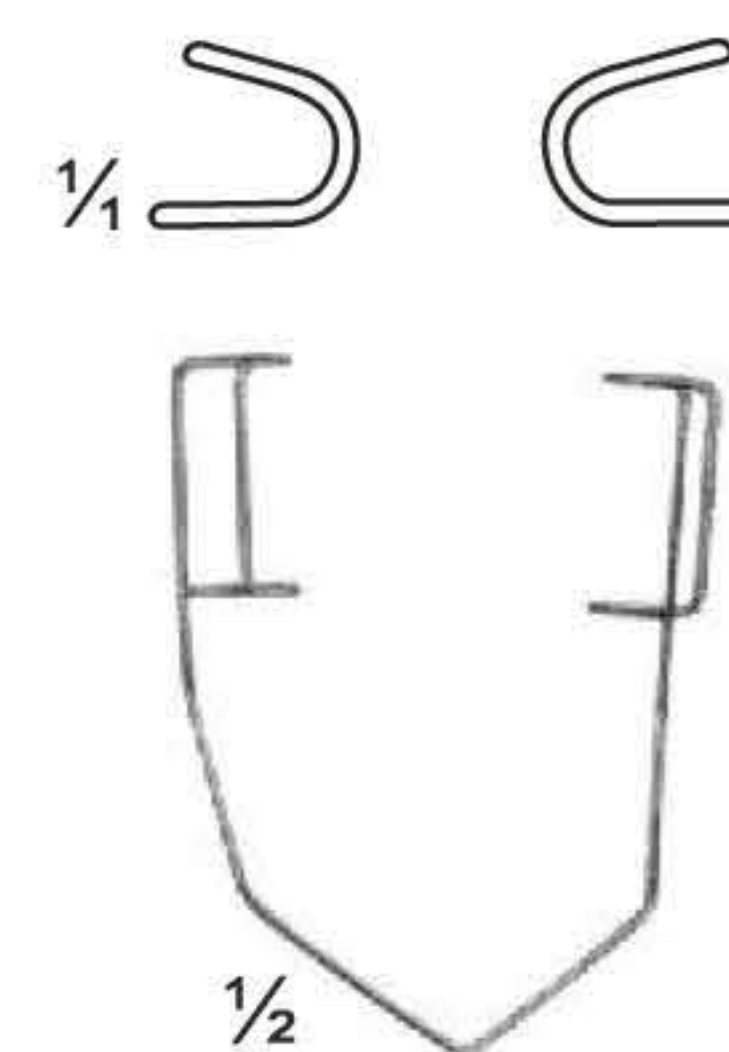

UG-991
BARRAQUER
45 mm

Self-Retaining Retractors

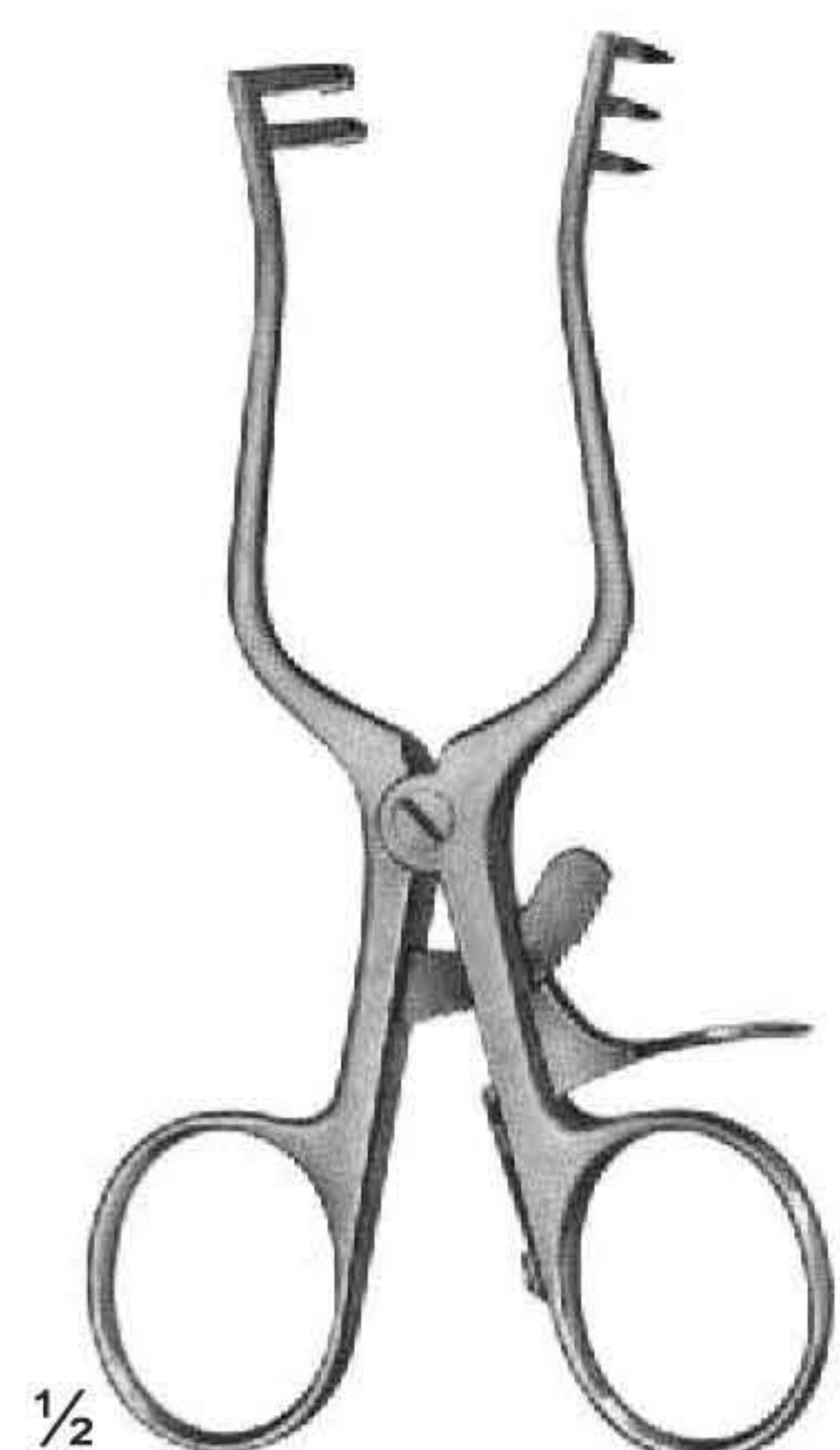

UG-993
WEITLANER
Sharp
110 mm

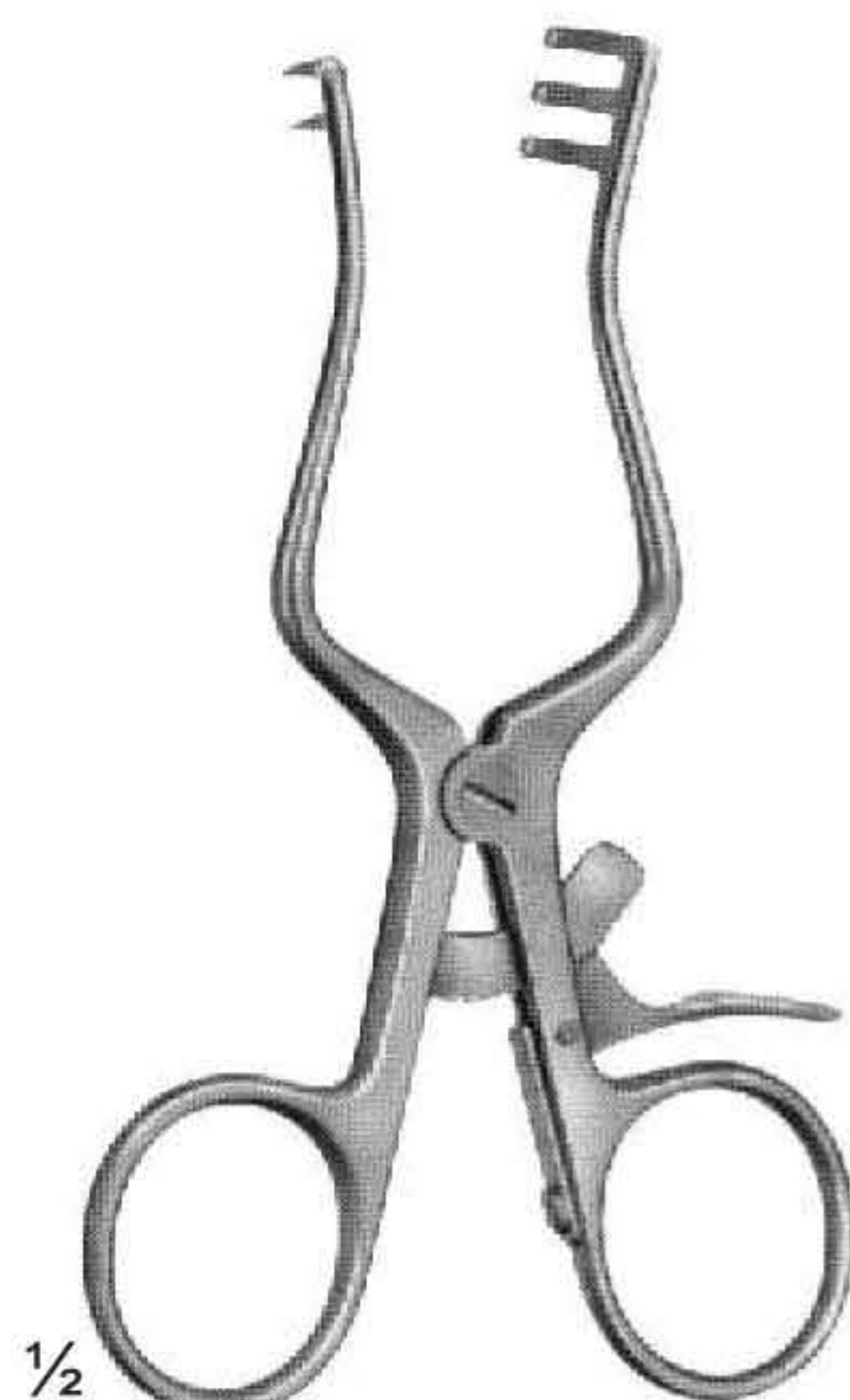

UG-994
WEITLANER
Semi-Sharp
110 mm

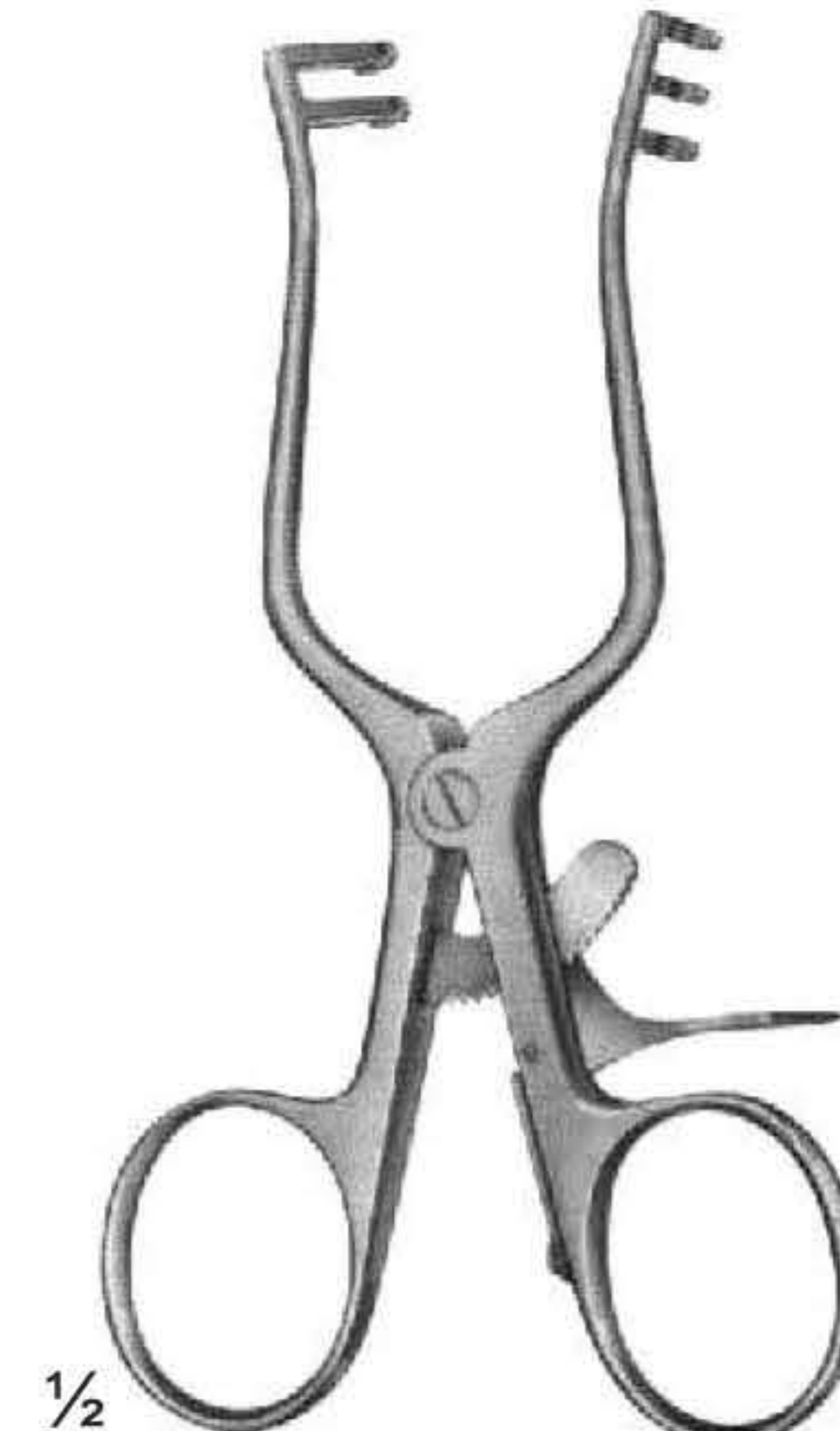

UG-995
WEITLANER
Blunt
110 mm

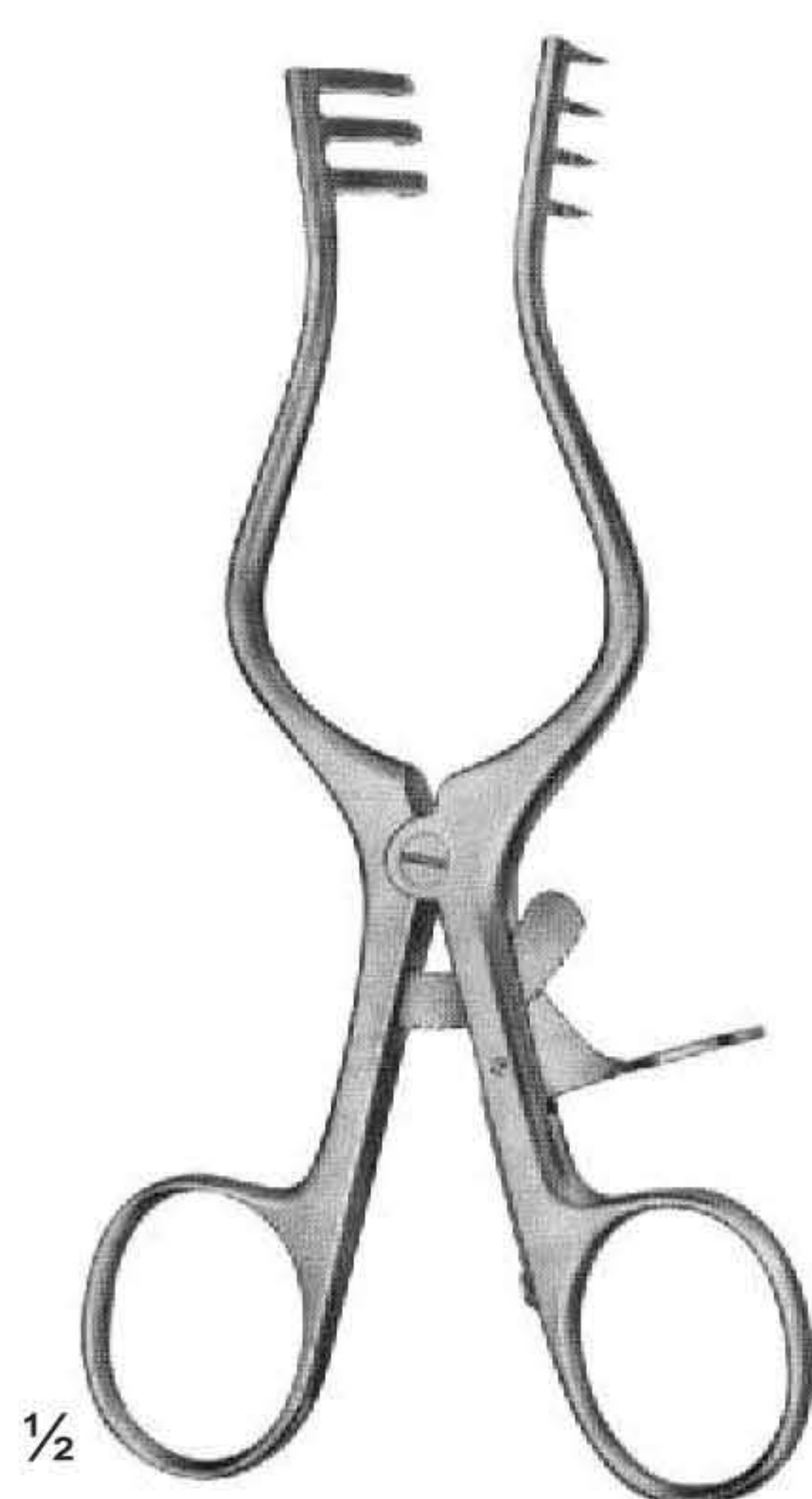

UG-994
WEITLANER
Sharp
130 mm

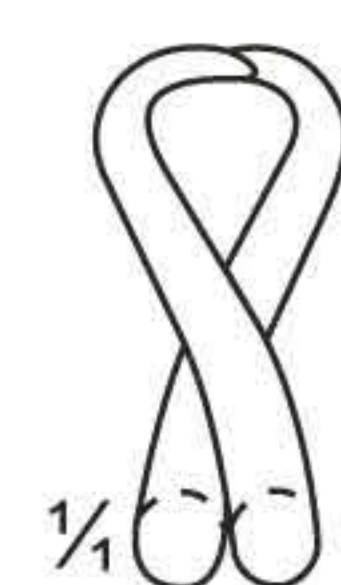

UG-997
WEITLANER
Semi-Sharp
130 mm

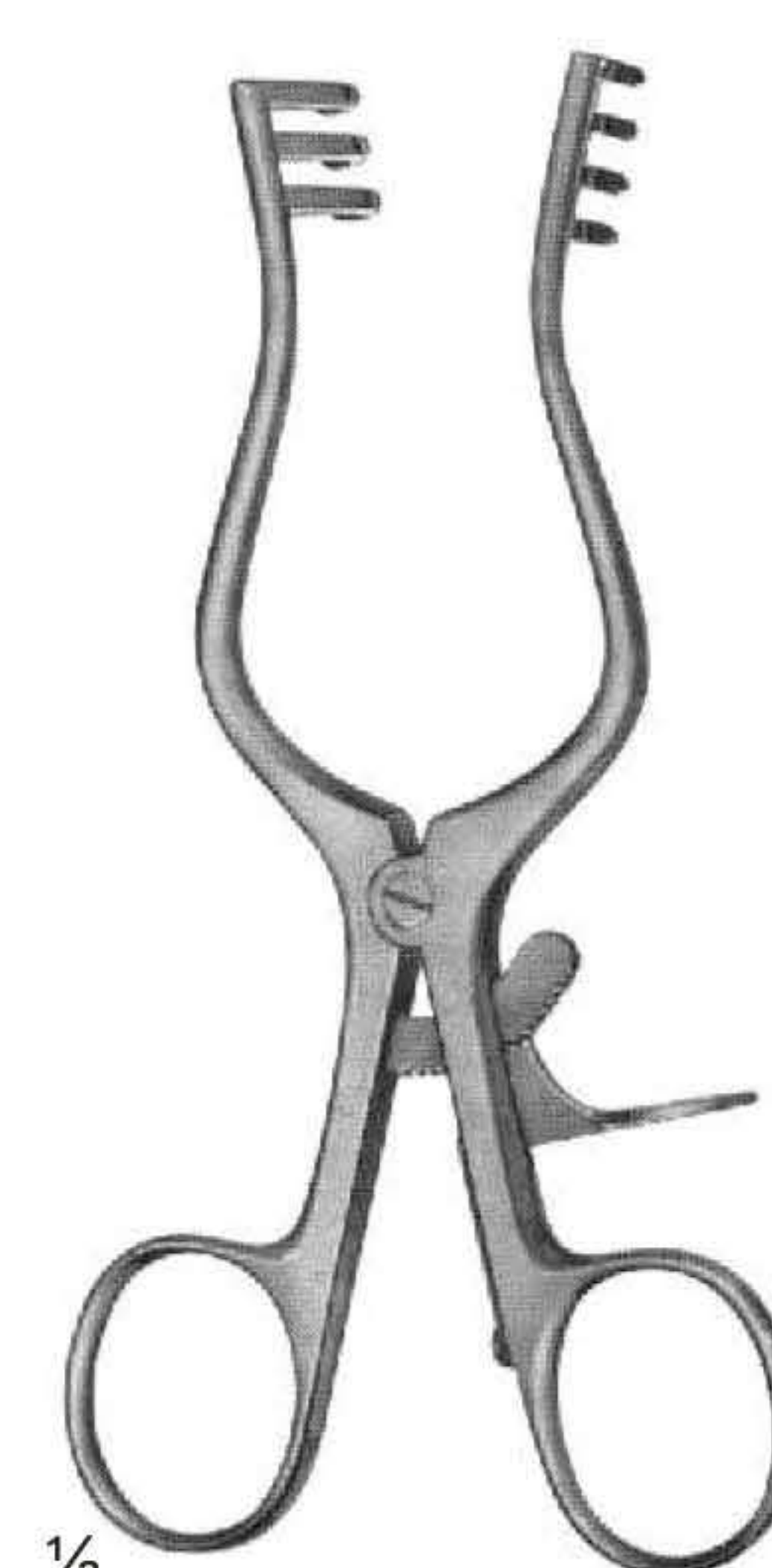

UG-998
WEITLANER
Blunt
130 mm

Self-Retaining Retractors

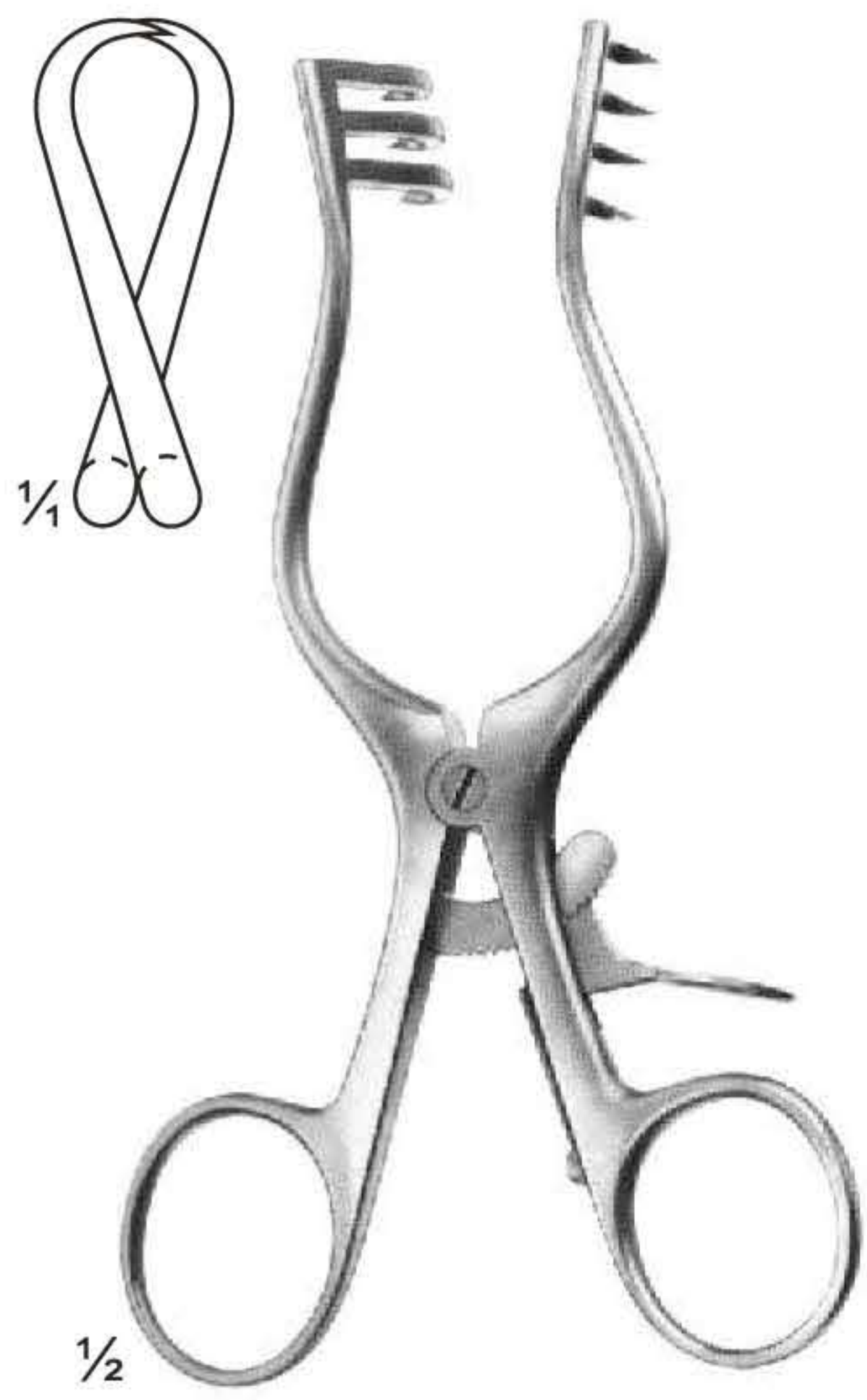

UG-999
WEITLANER
Sharp
130 mm

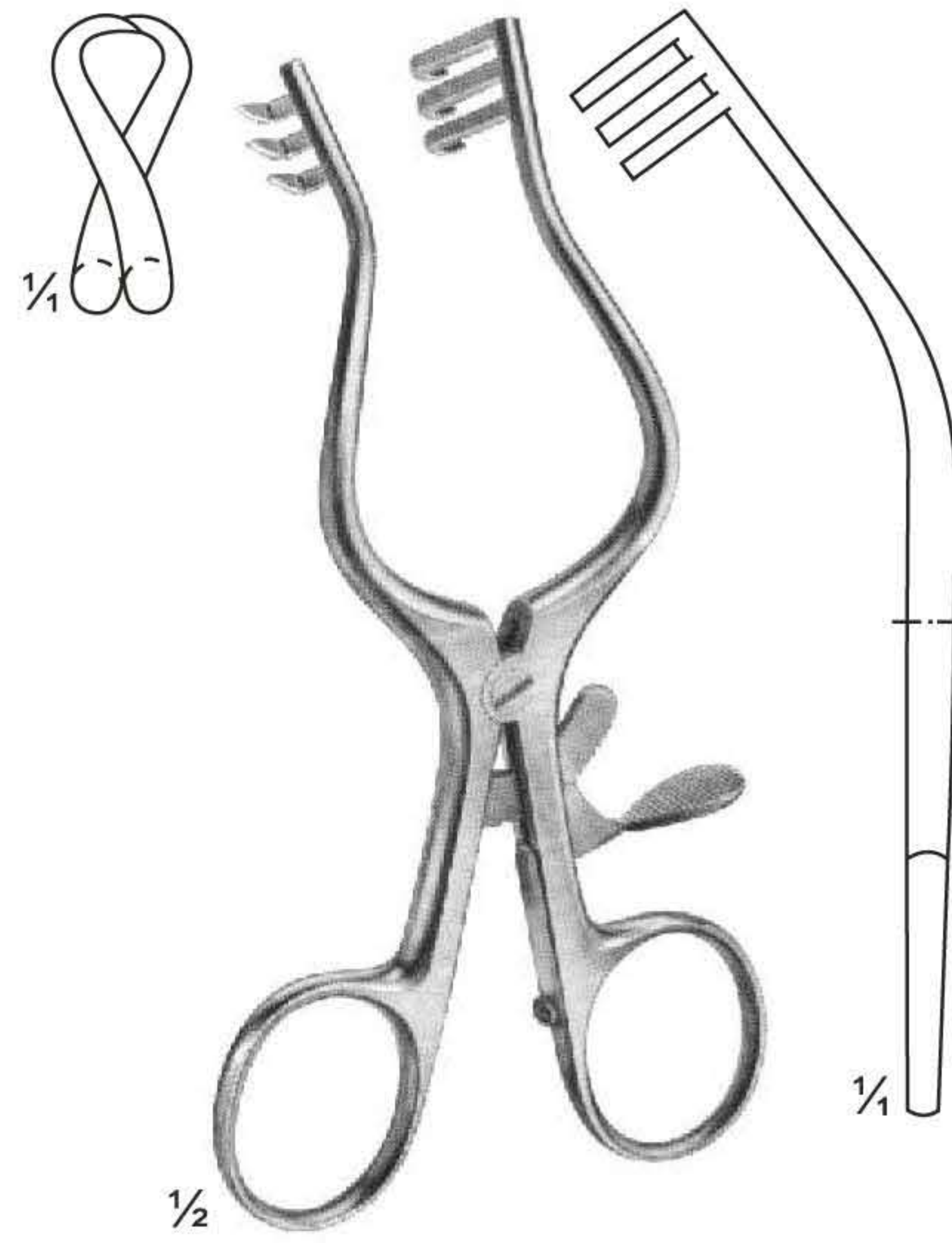

UG-1000
WULLSTEIN
Sharp
130 mm

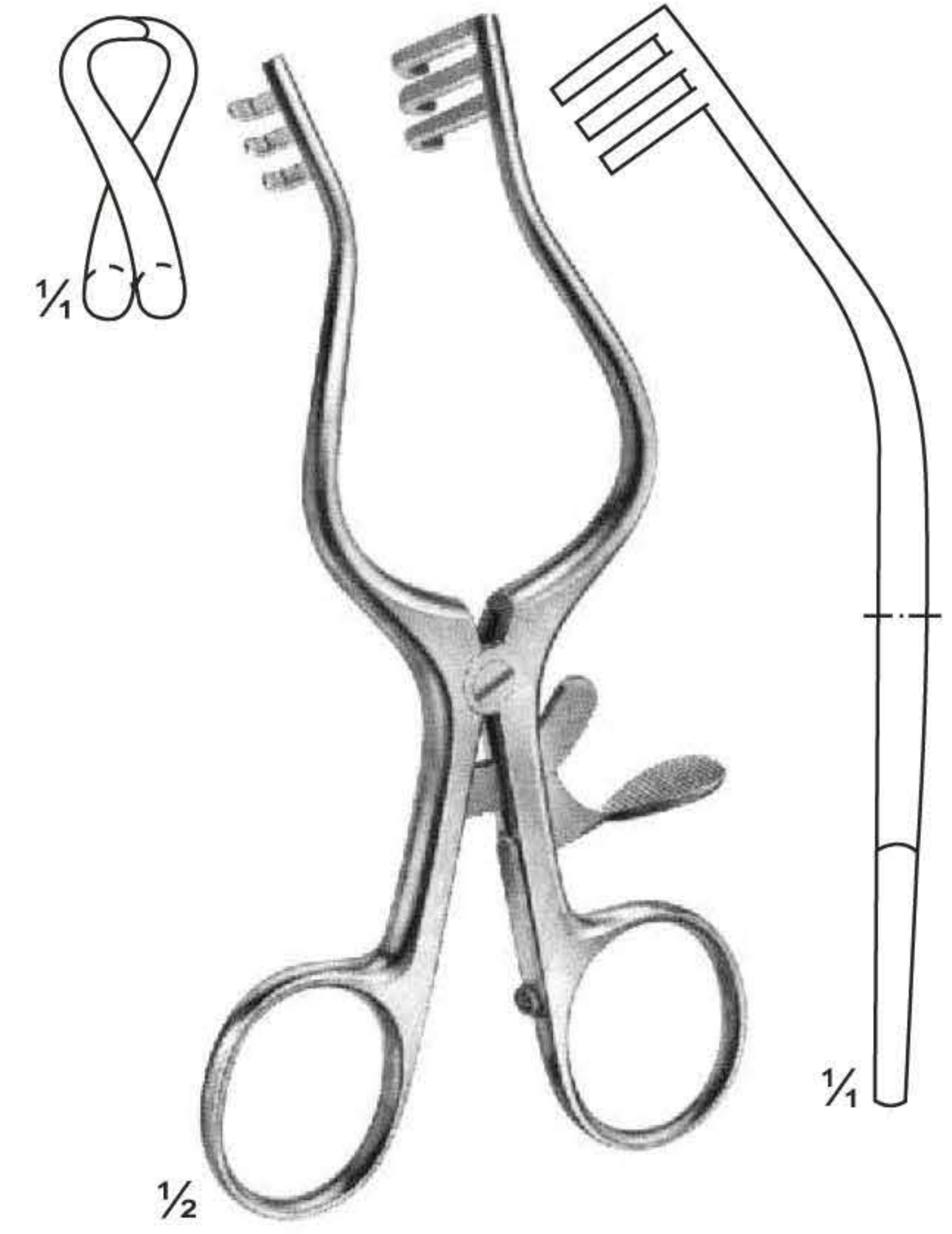

UG-1001
WULLSTEIN
Blunt
130 mm



UG-1002
WEITLANER
Sharp
165 mm



UG-1003
PLESTER
Blunt
110 mm

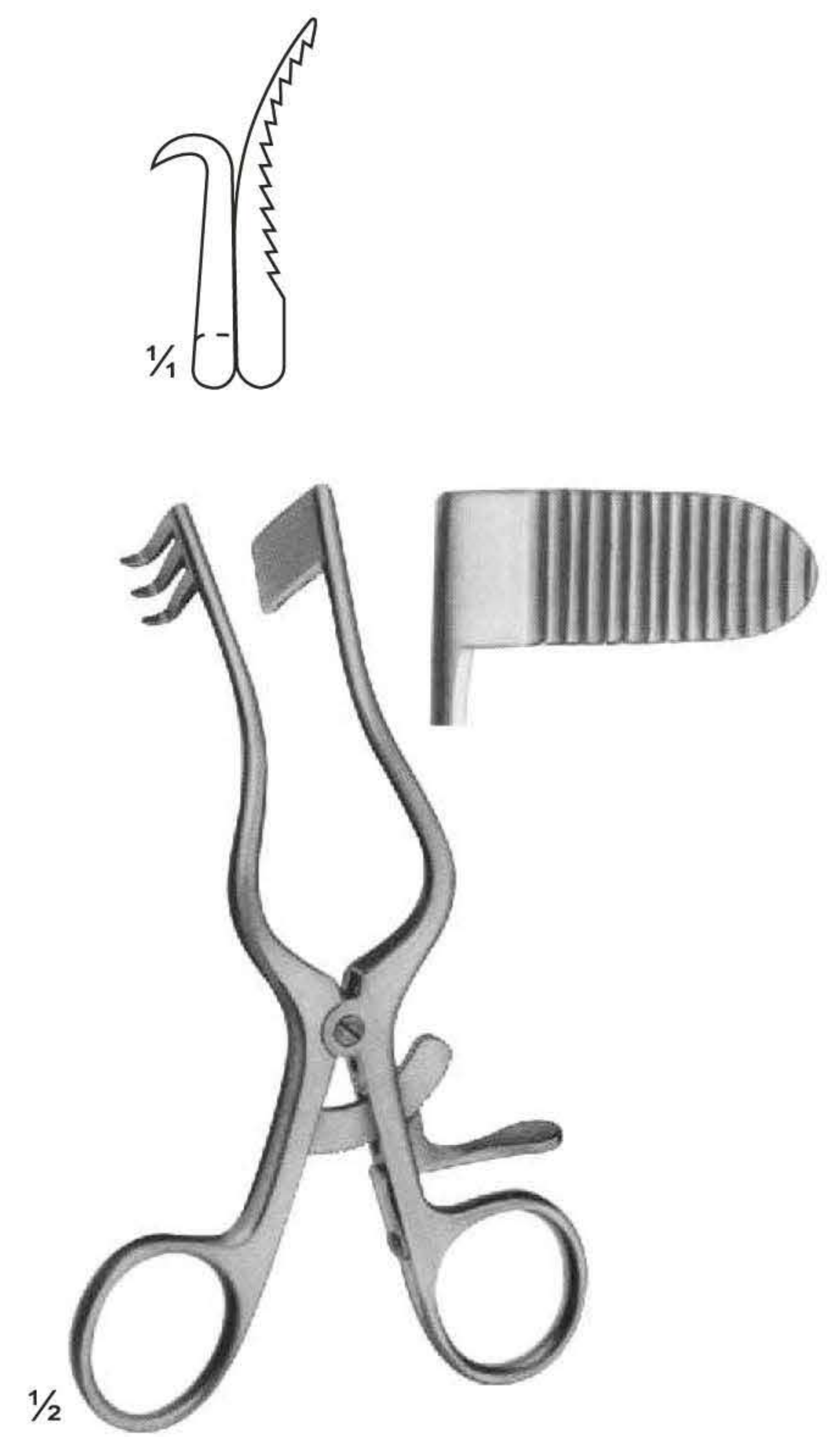

UG-1004
PERKINS
Blunt
130 mm

Self-Retaining Retractors



UG-1005
ADSON-BABY
Blunt
140 mm

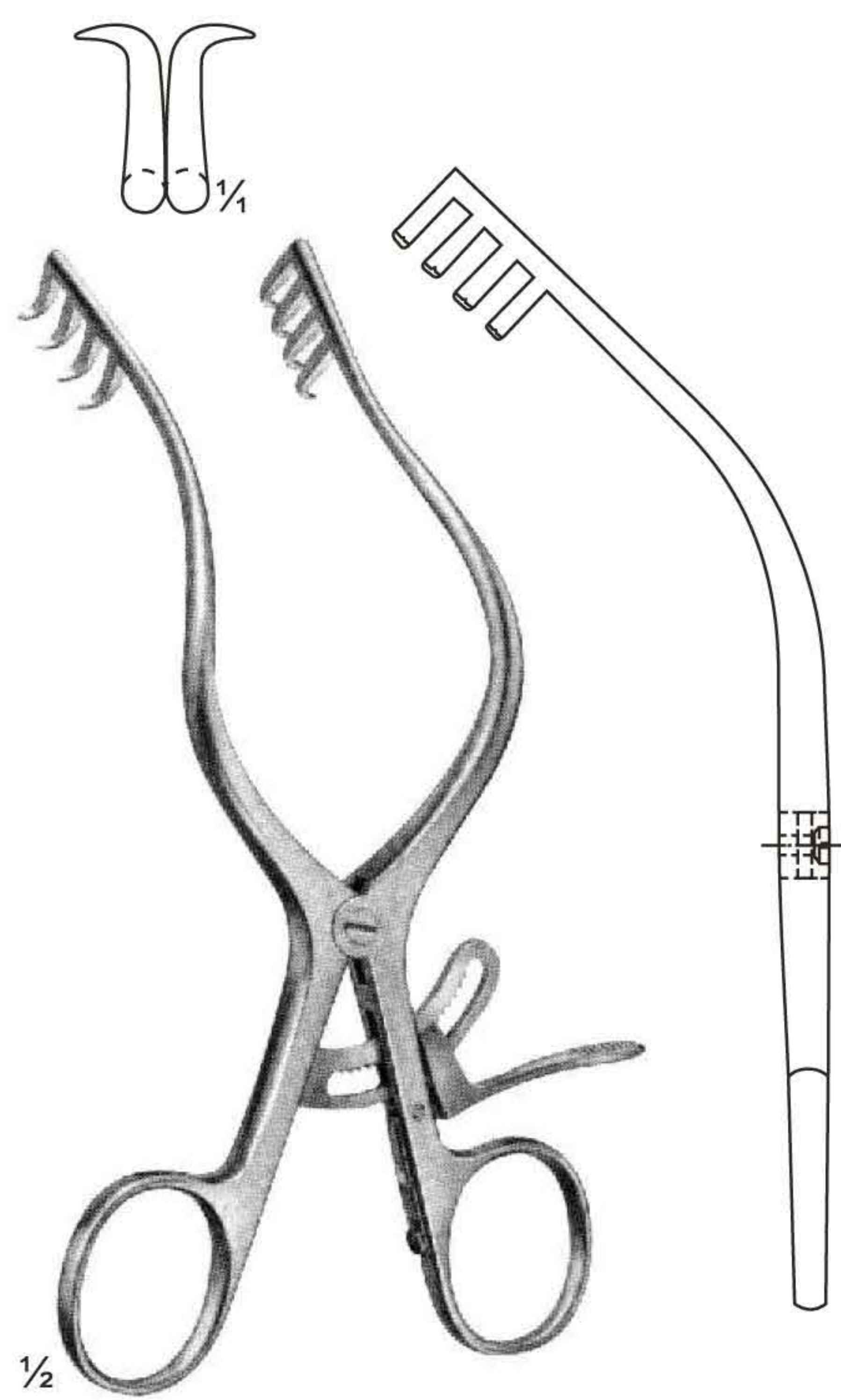

UG-1006
MOLLISON
Sharp
155 mm

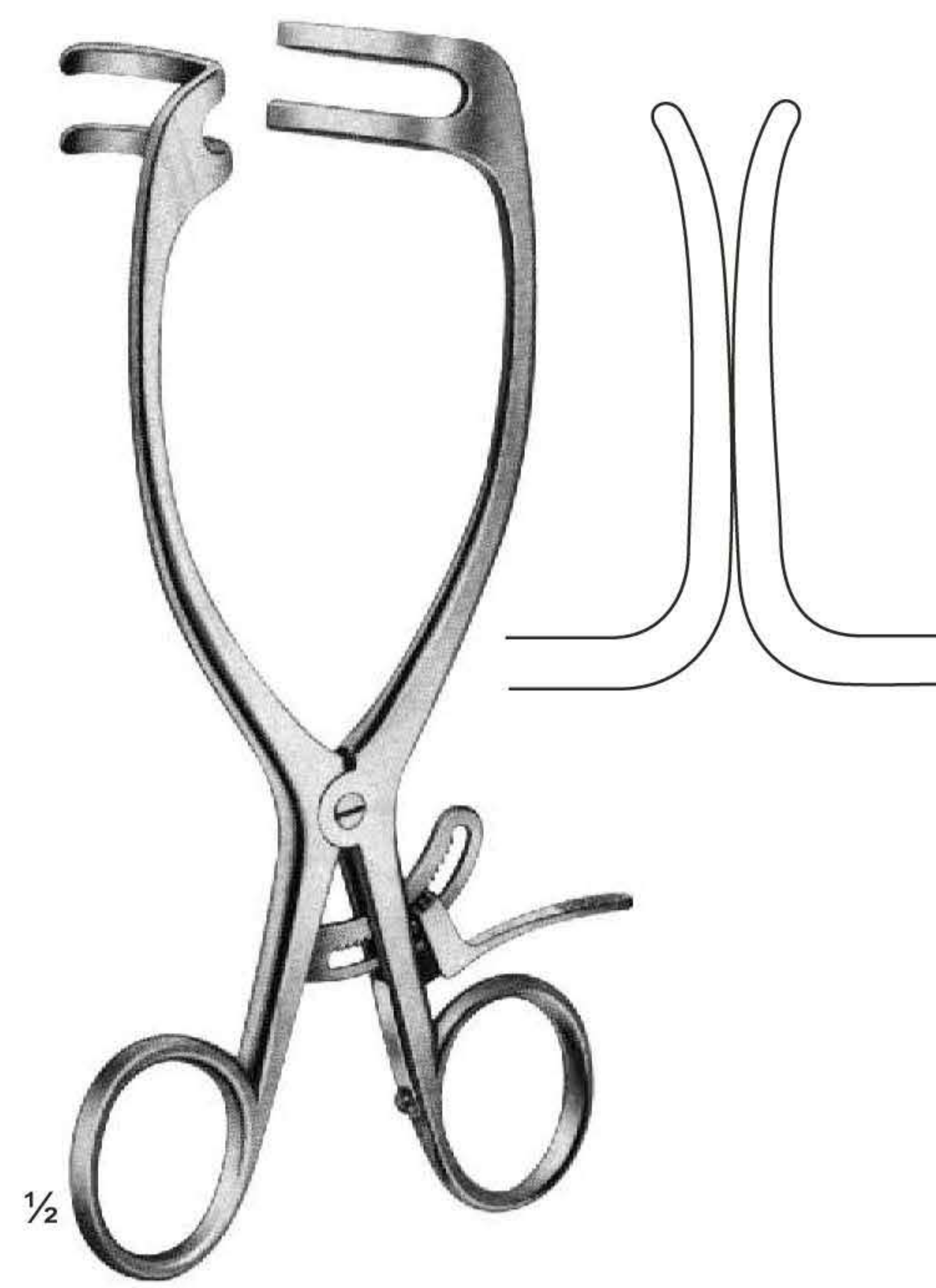

UG-1008
MAYO-ADAMS
165 mm

Self-Retaining Laminectomy Retractors

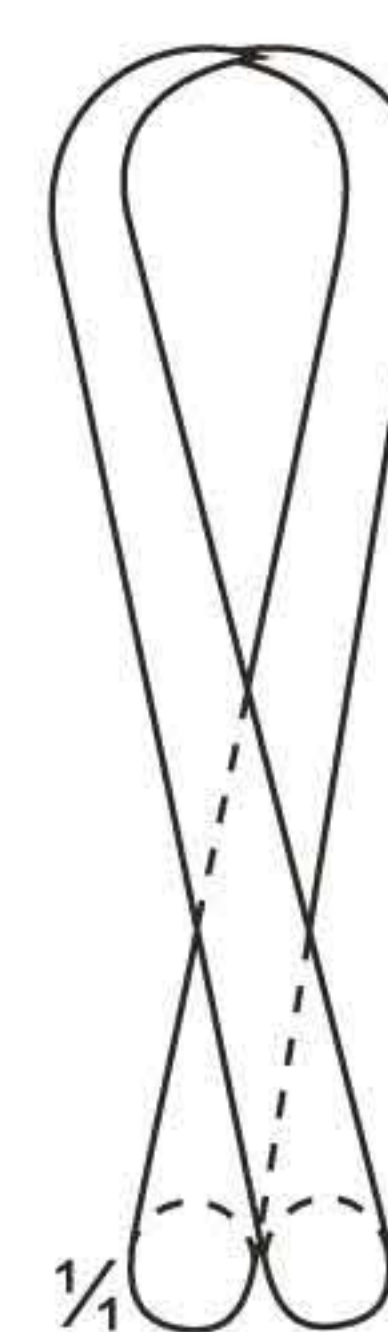
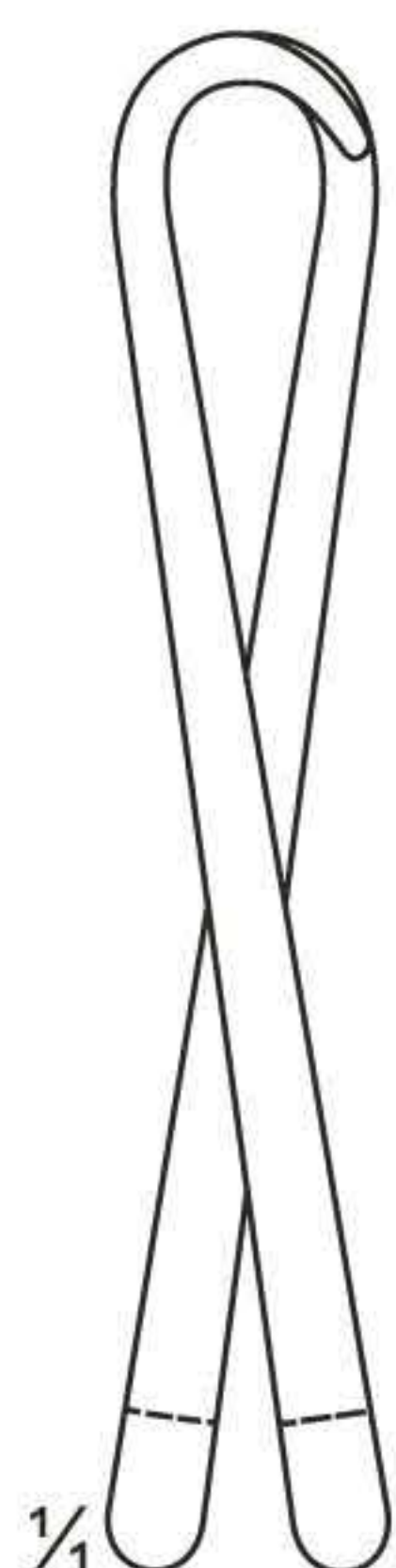
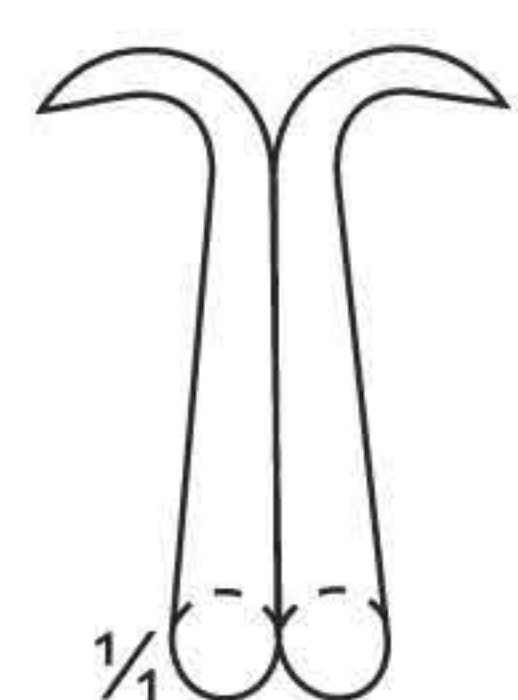

UG-1010
ANDERSON-ADSON
Sharp
190 mm



UG-1013
NORFOLK and
NORWICH
Blunt
220 mm



UG-1015
ADSON
Sharp
265 mm

Self-Retaining Laminectomy Retractors

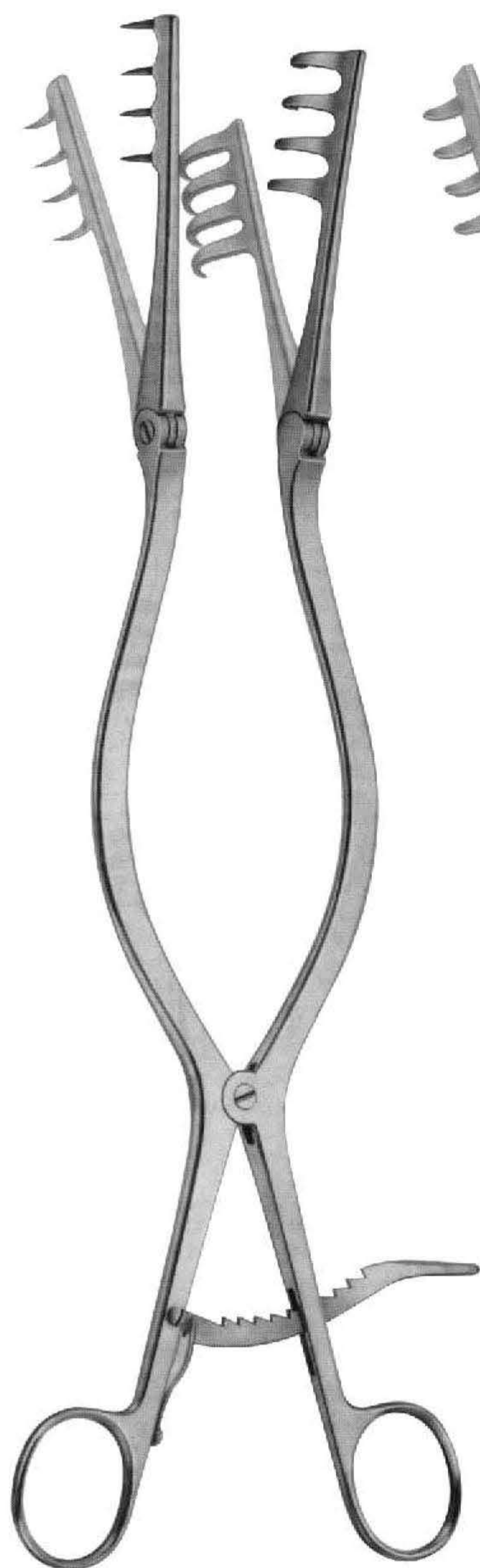
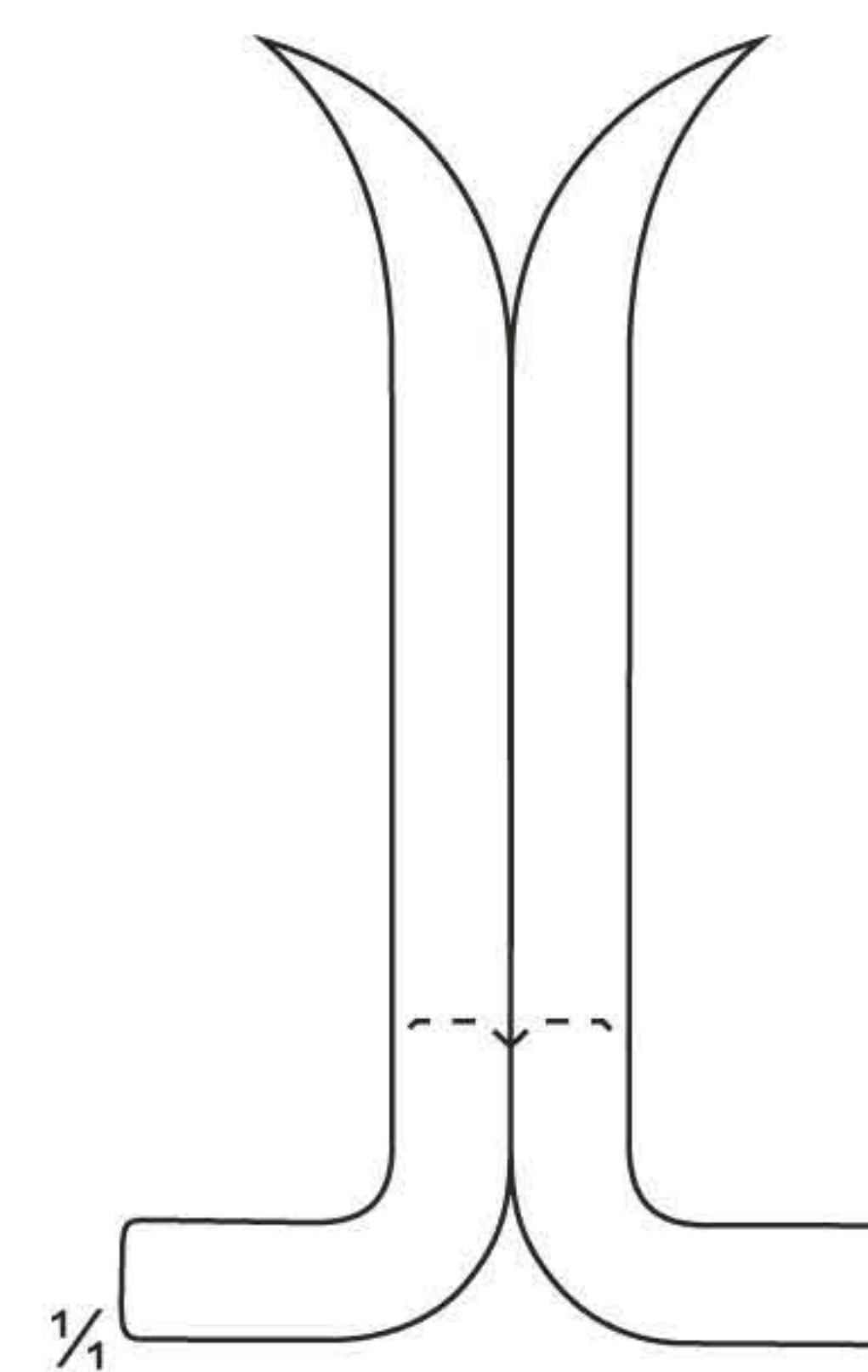
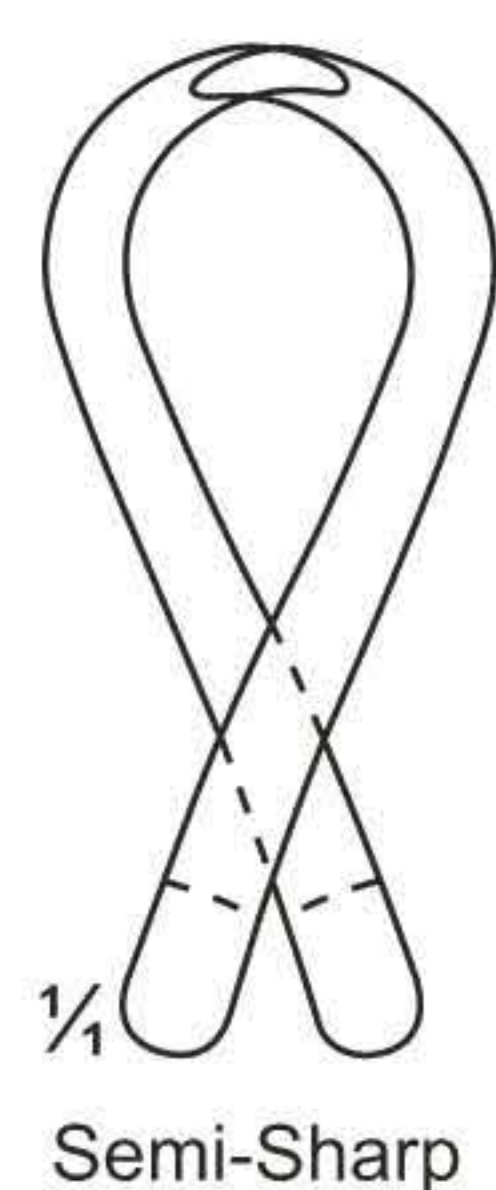
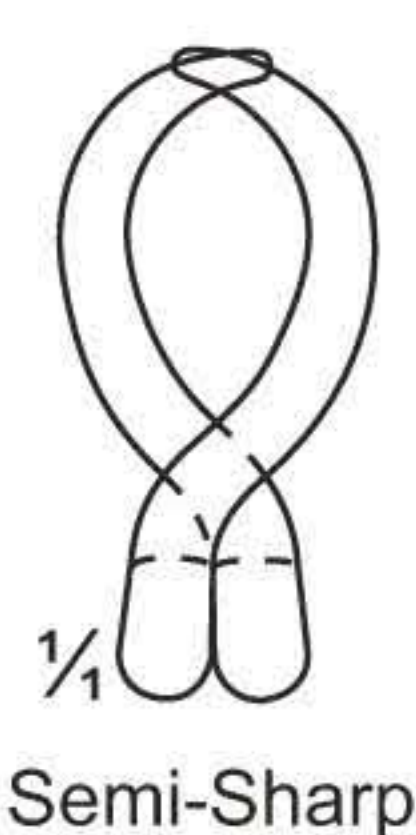
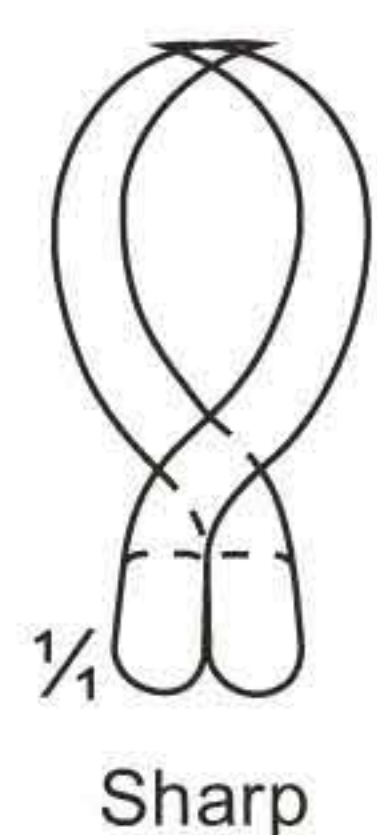

UG-1016
BECKMANN-ADSON
Sharp
310 mm



08-456
BECKMANN-ADSON
Semi-Sharp
310 mm



UG-1018
ADSON
Semi-Sharp
320 mm



UG-1019
BECKMANN-EATON
Sharp
320 mm

Special Retractors



UG-1021
JOLL (FRIEDMAN)
Thyroid- and Vaginal Retractor
155 mm

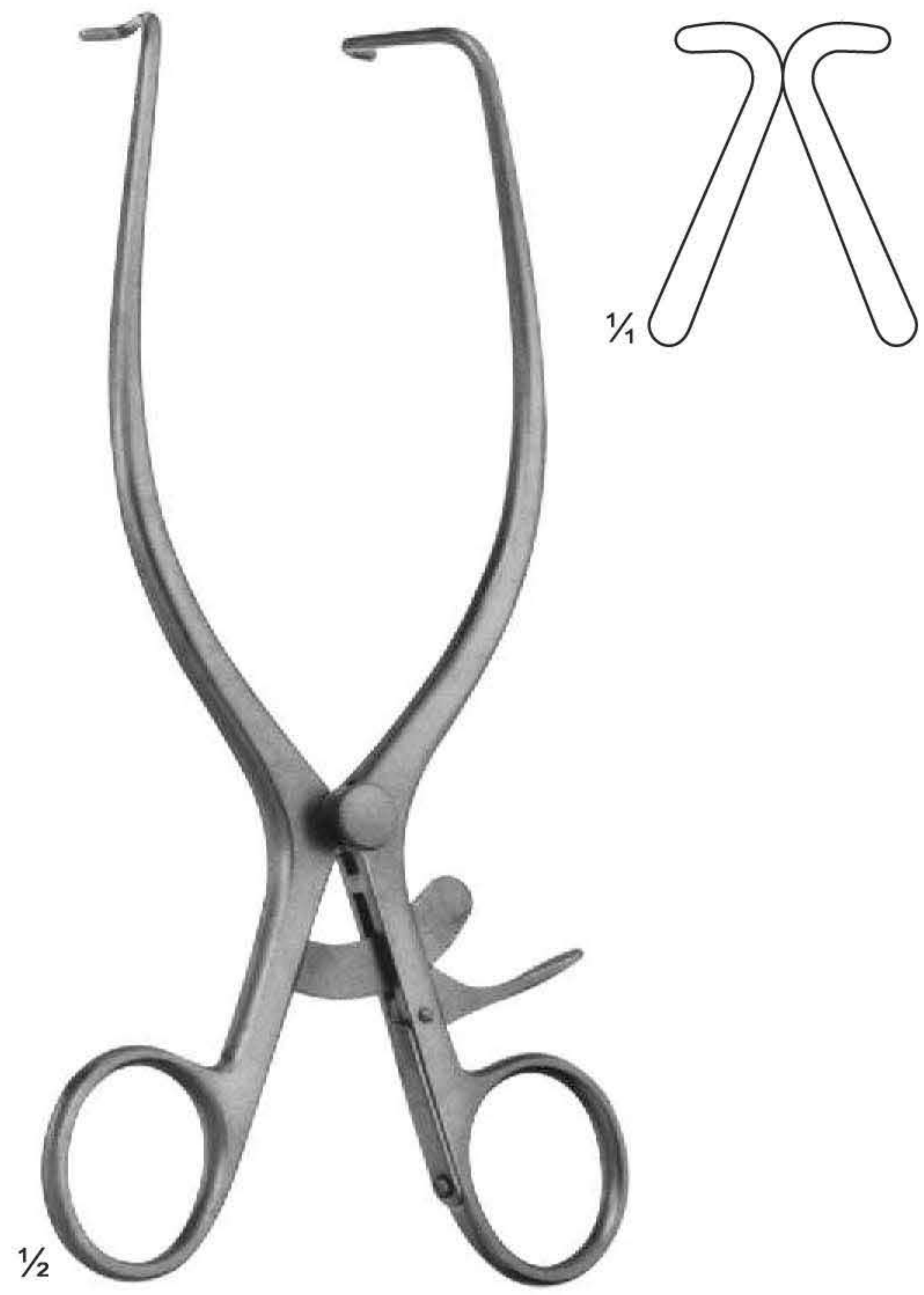

UG-1023
JACKSON BURROWS
Retractor, blunt
185 mm

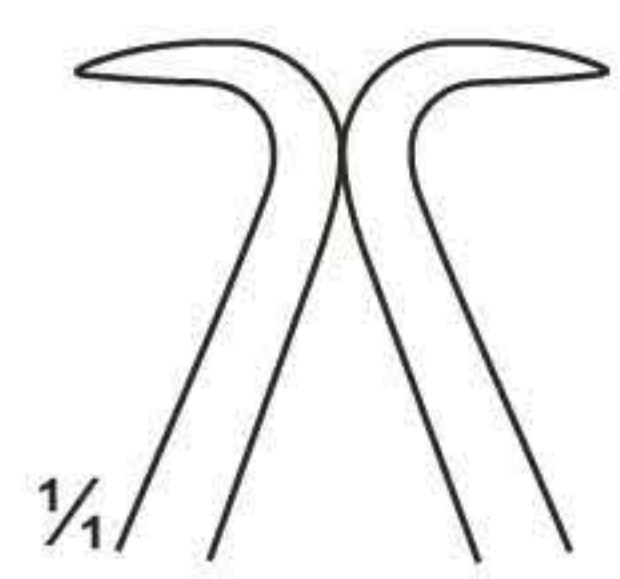

UG-1025
GELPI
Vaginal Retractor
135 mm

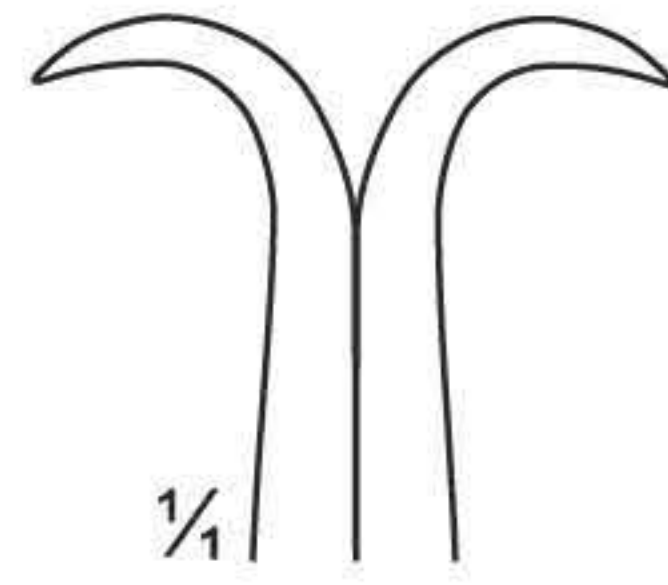

UG-1026
GELPI
Skin- and Vaginal Retractor
175 mm

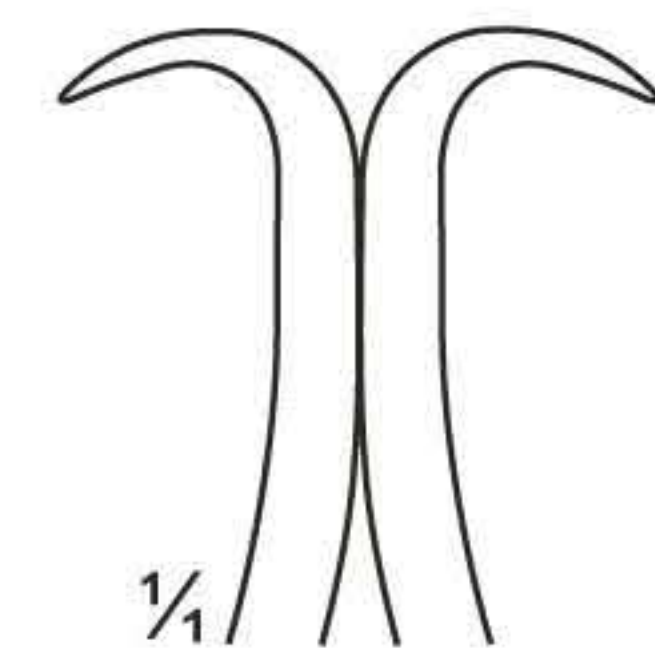

UG-1027
DE BAKEY
Femur Retractor
145 mm

Self Retaining Retractors for Laminectomy and other Operations

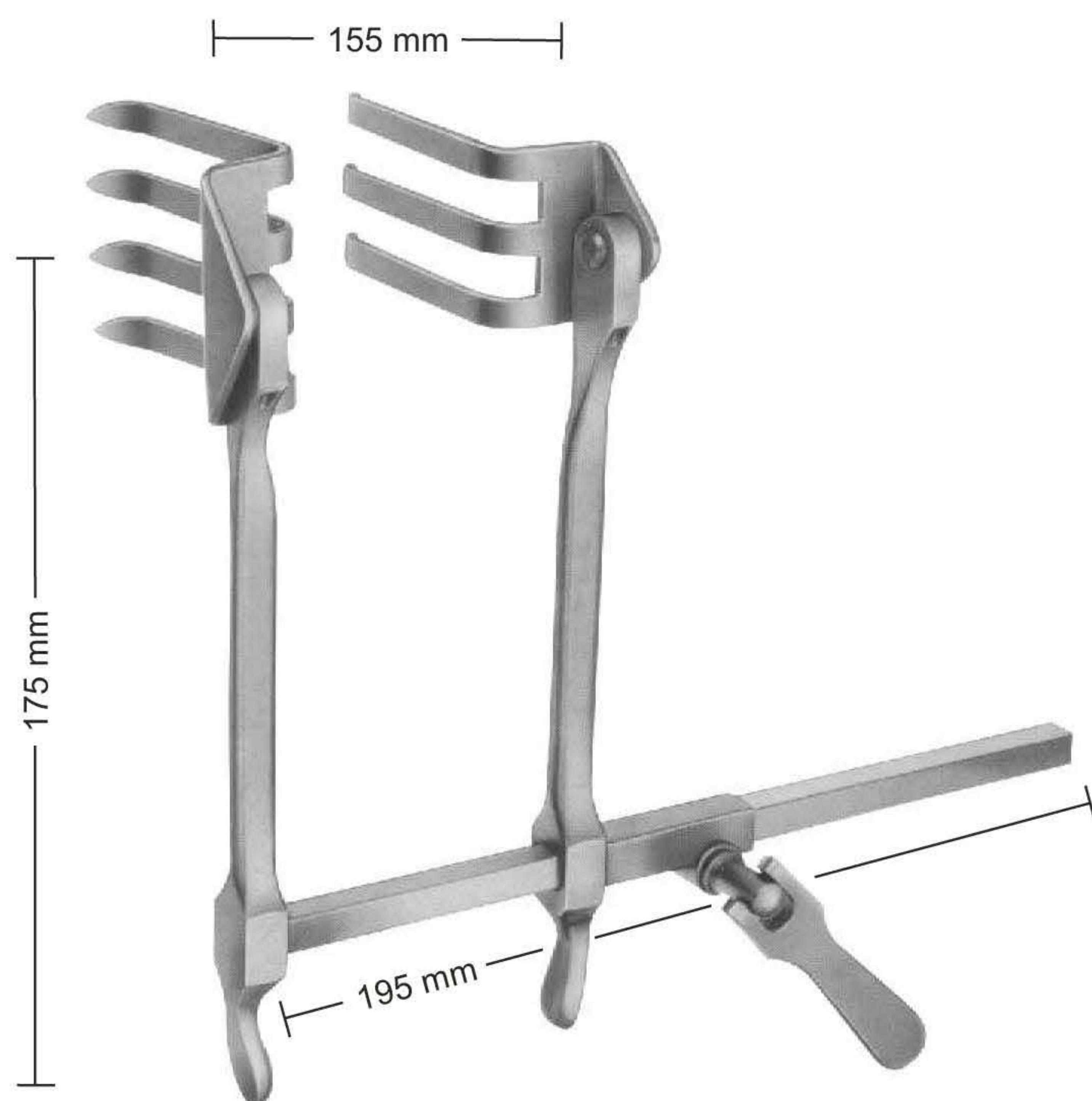

UG-1031
SCOVILLE-RICHTER
Retractor with 1 pair
blades reversible type.
The Retractor bar and
shanks may be easily
rotated 180° when
blades are in situ.

Retractors for Cervical Spine



UG-1036
CLOWARD modif.
Spreader Only

Amputating Knives, Cartilage Knives, Autopsy Knives

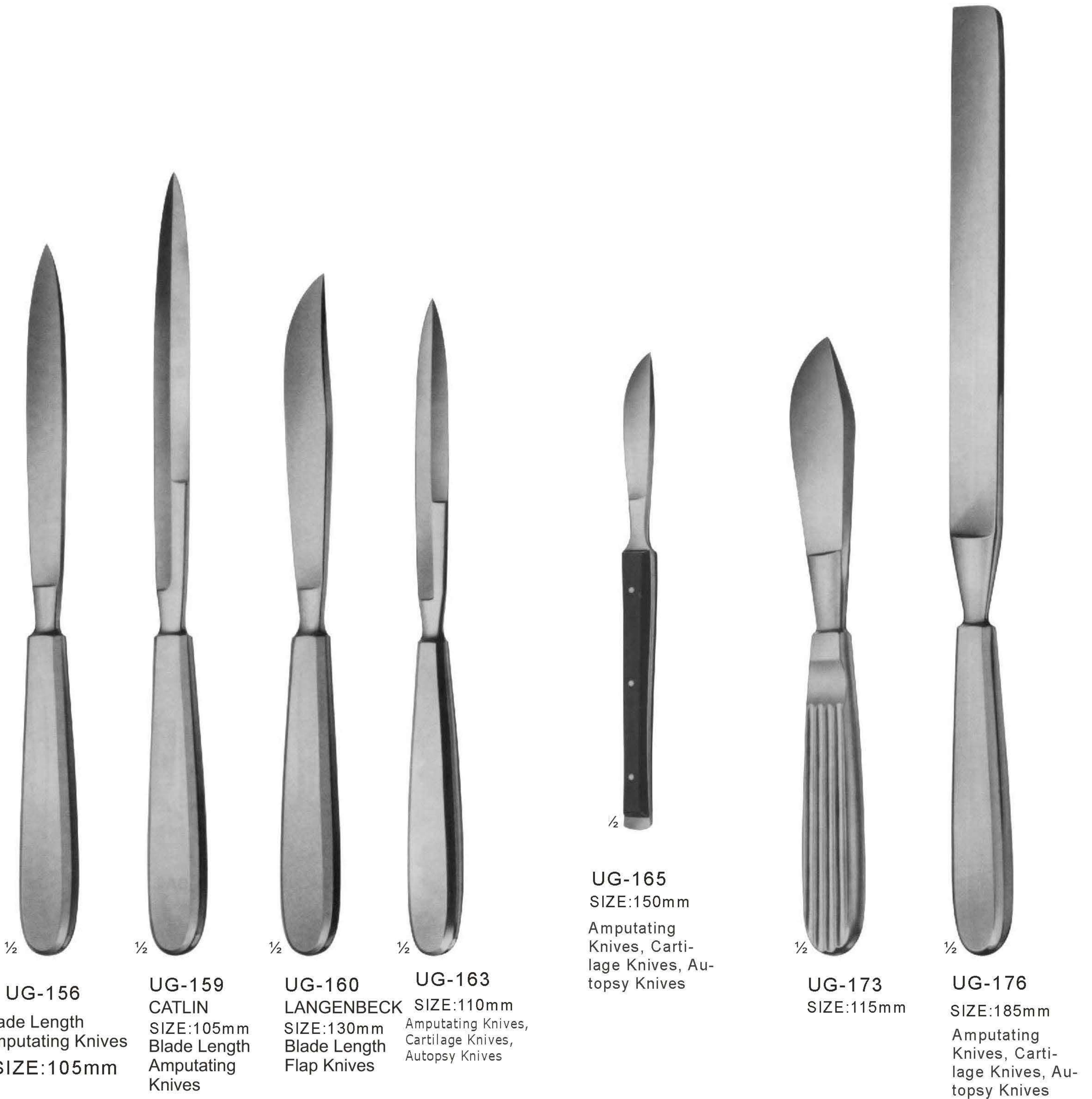

Retractors for Cervical Vertebral Column

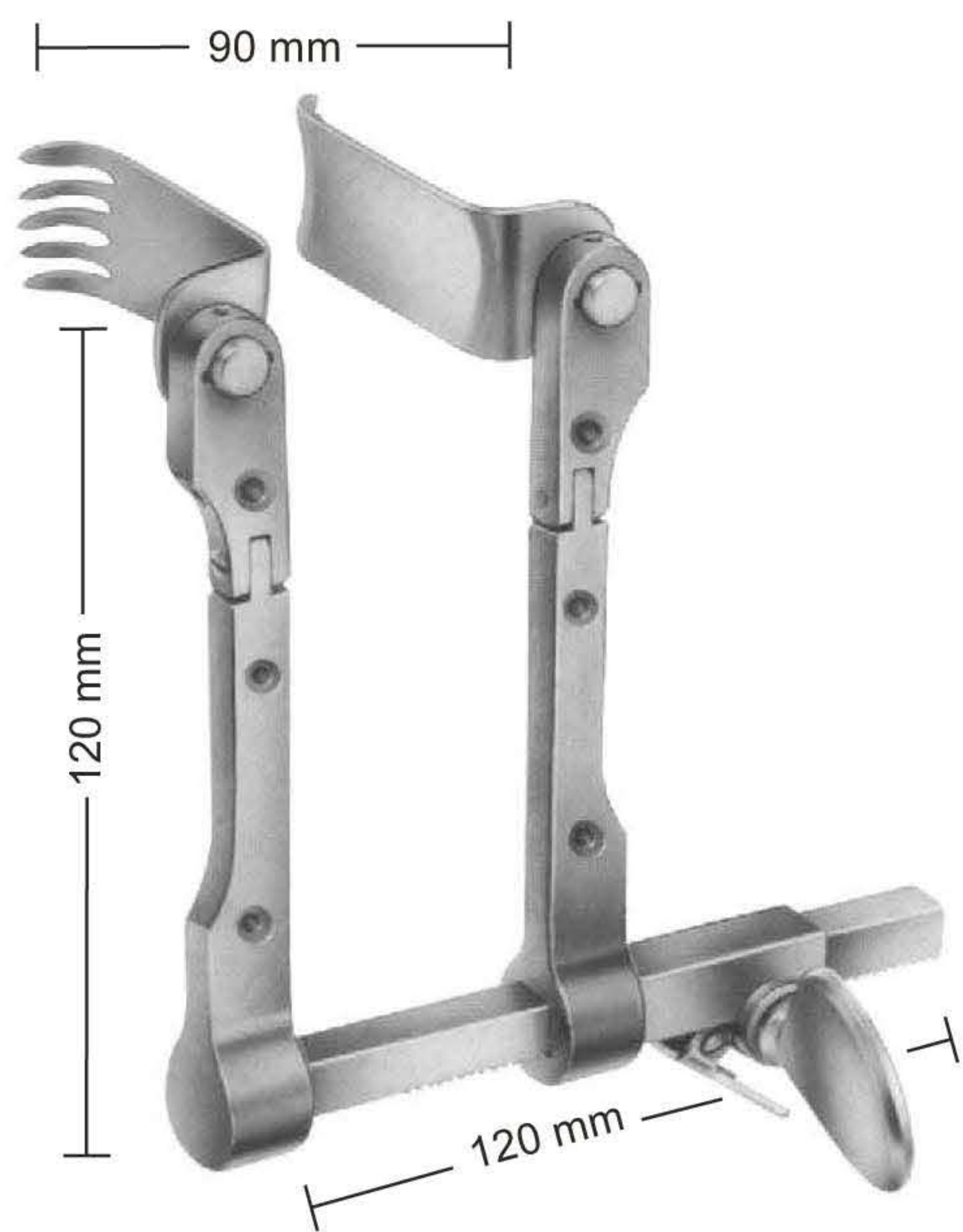

UG-1043
CASPAR
Retractor, adjustable,
consisting of: 5 medial
blades, 5 Lateral blades.

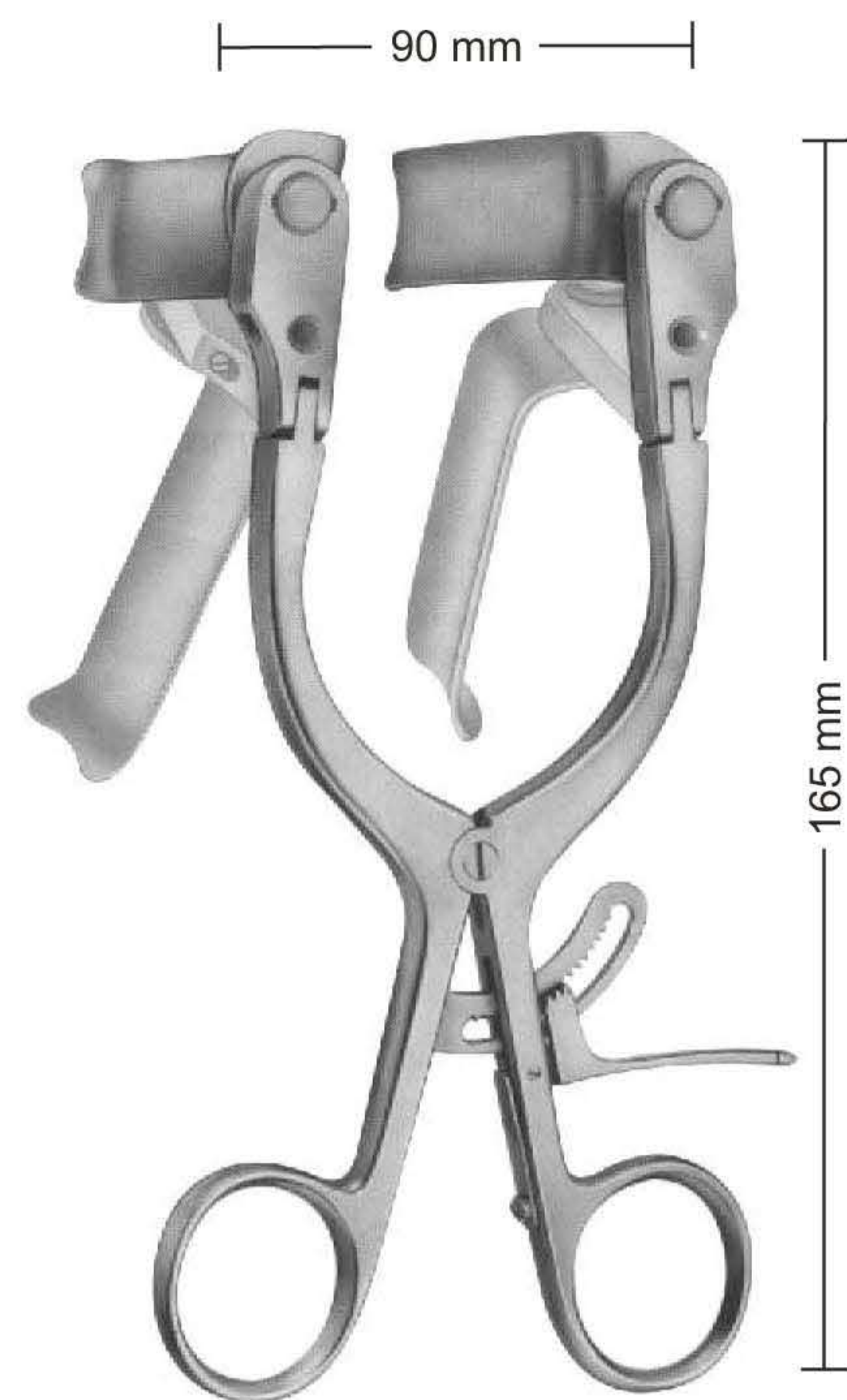

UG-1044
CASPAR
Counter retractor, adjustable,
consisting of: 5 blades.

Lamina Spreaders

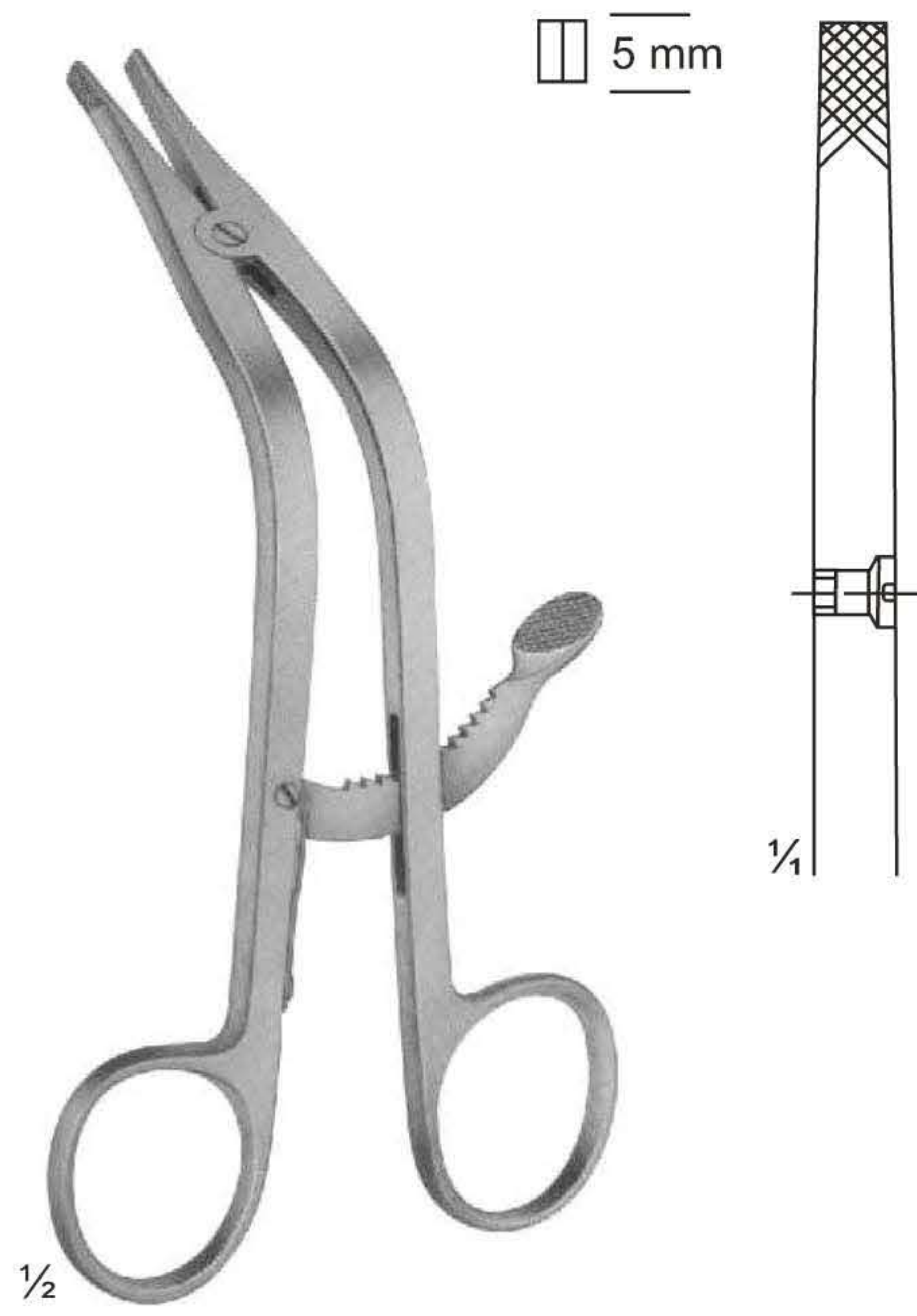

5 mm

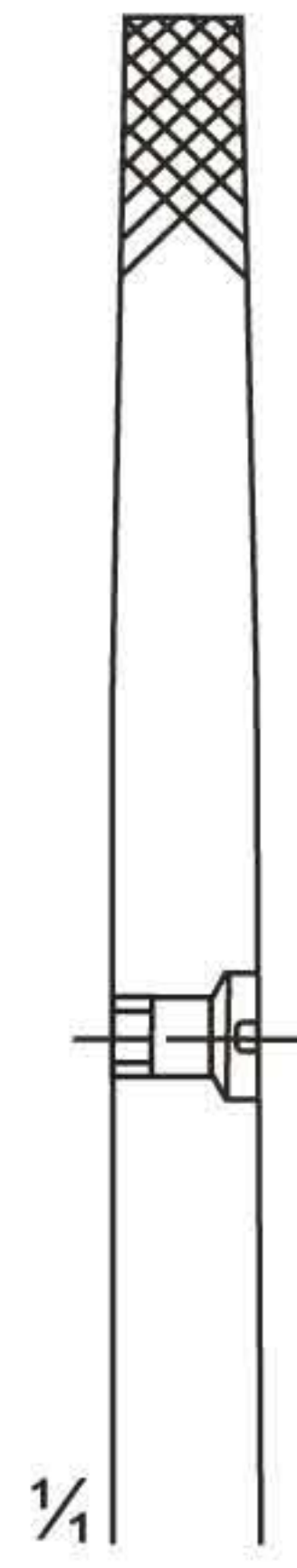

UG-1051
CLOWARD
155 mm



4,5 mm

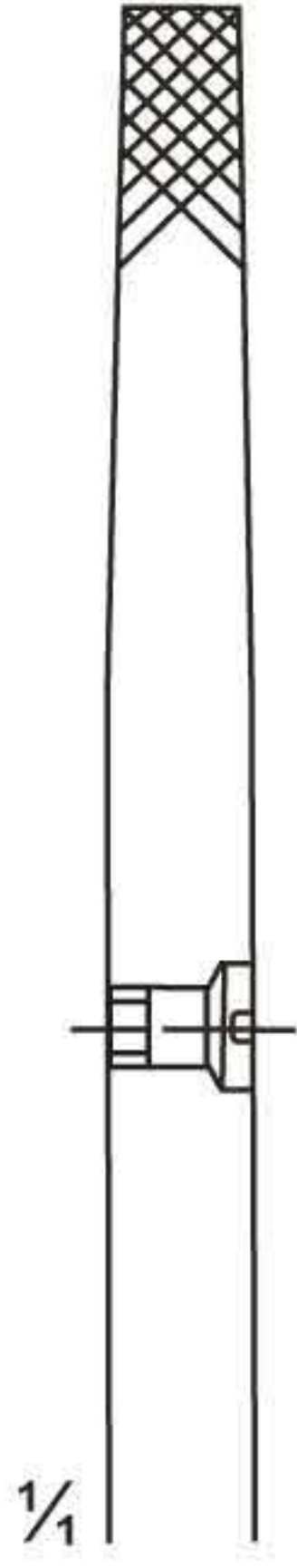

UG-1052
CLOWARD
135 mm

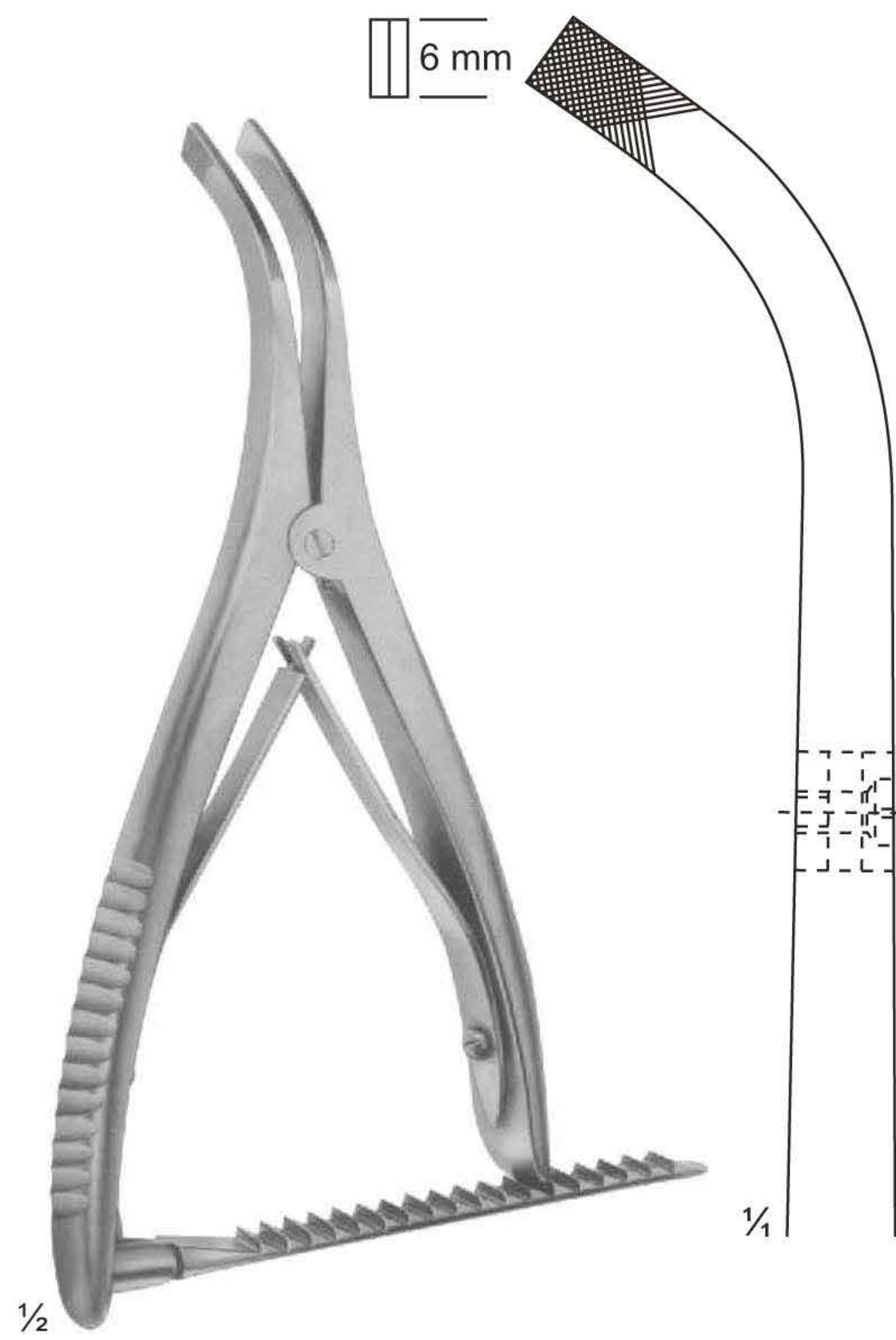

6 mm

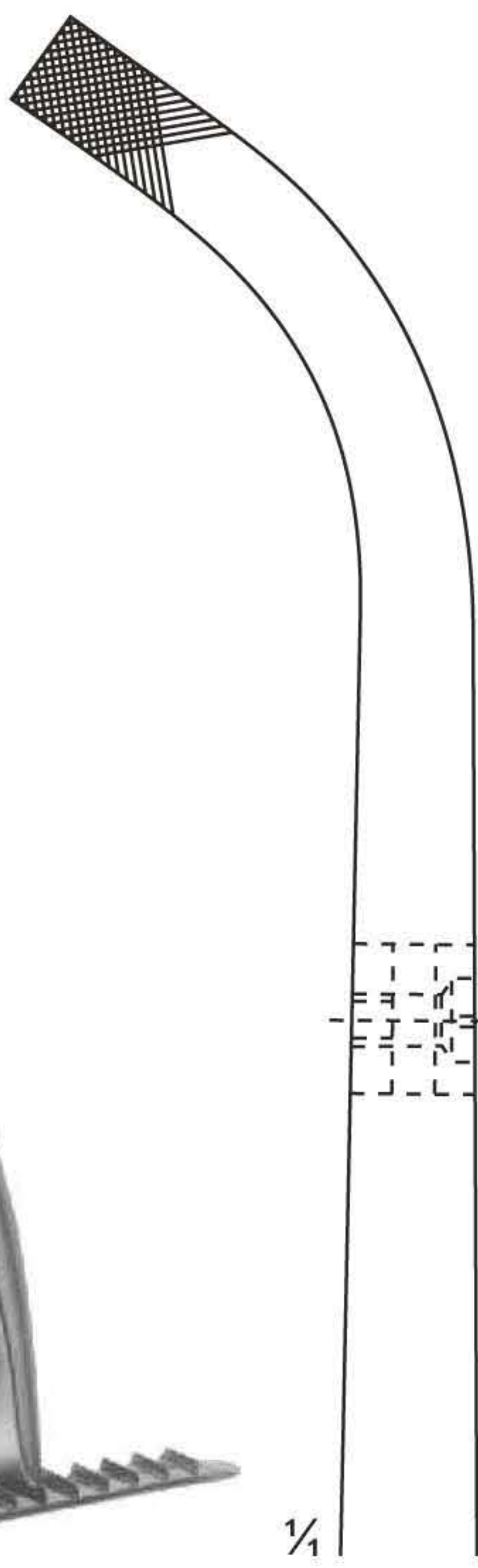

UG-1054
INGE
170 mm

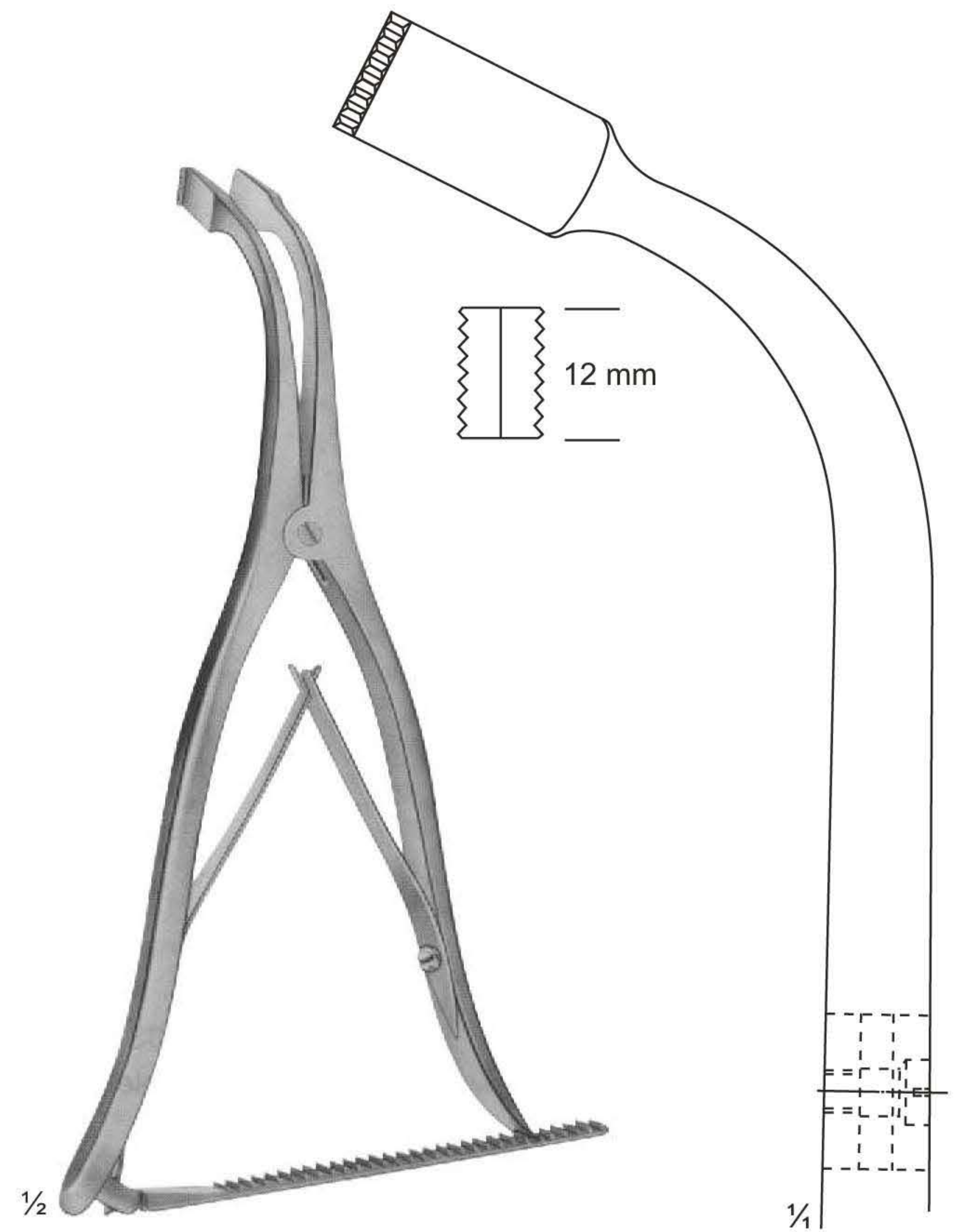

12 mm

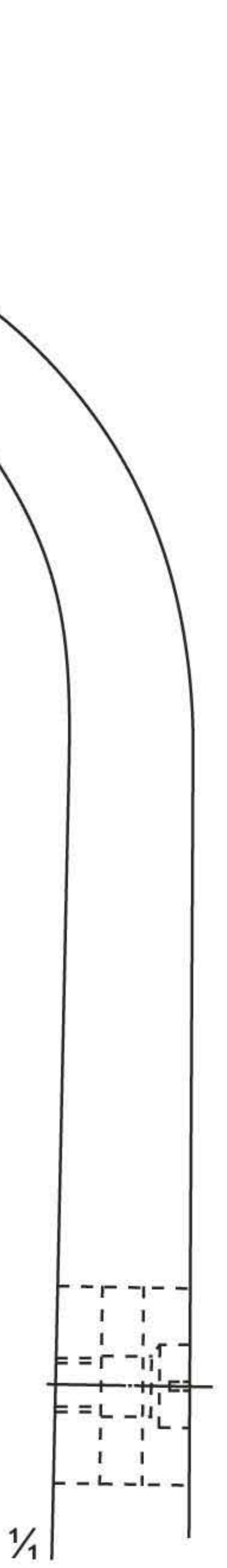

UG-1055
INGE
275 mm

Abdominal Retractors

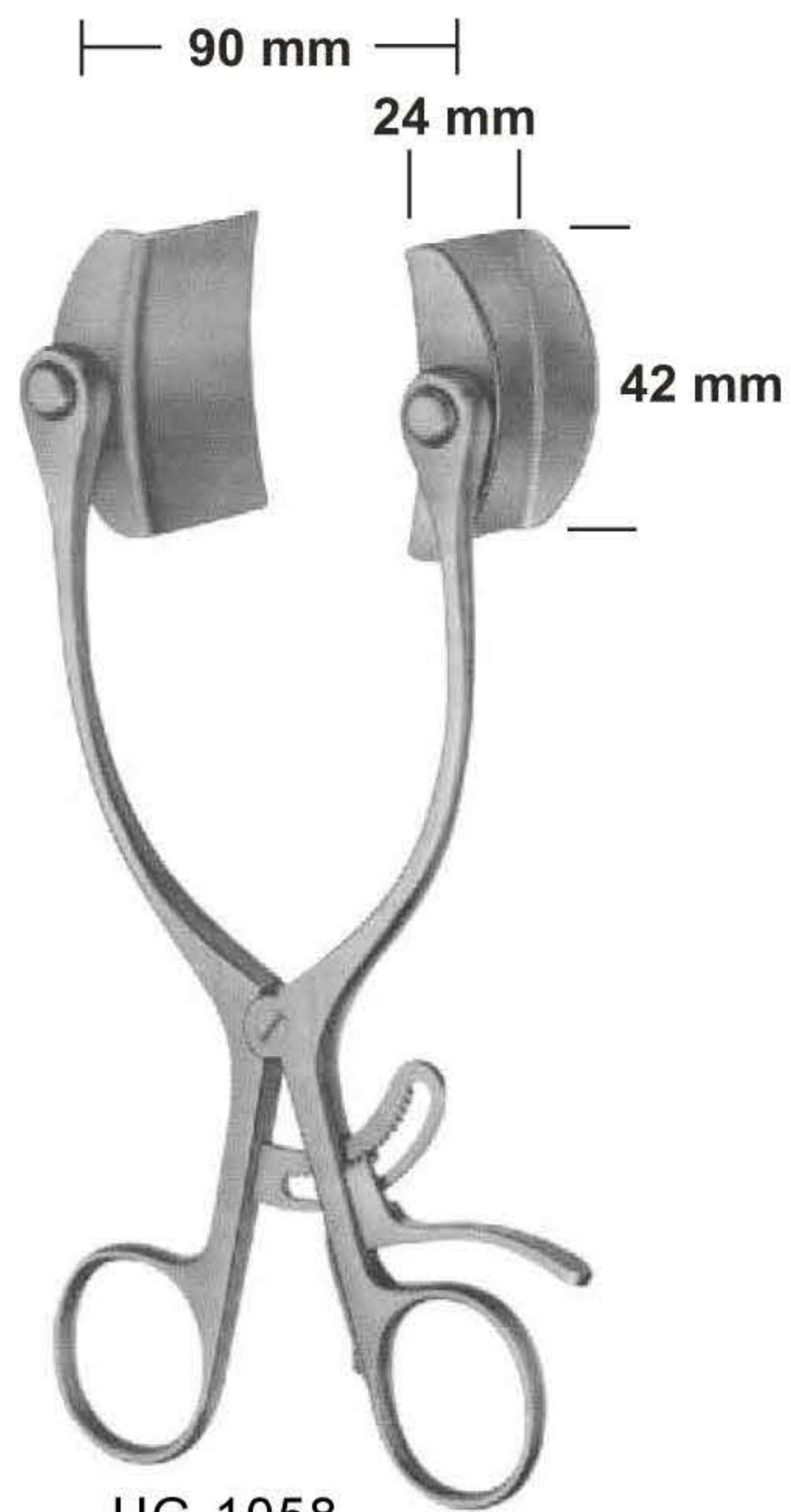

UG-1058
BABY-COLLIN
with 2 pair of blades

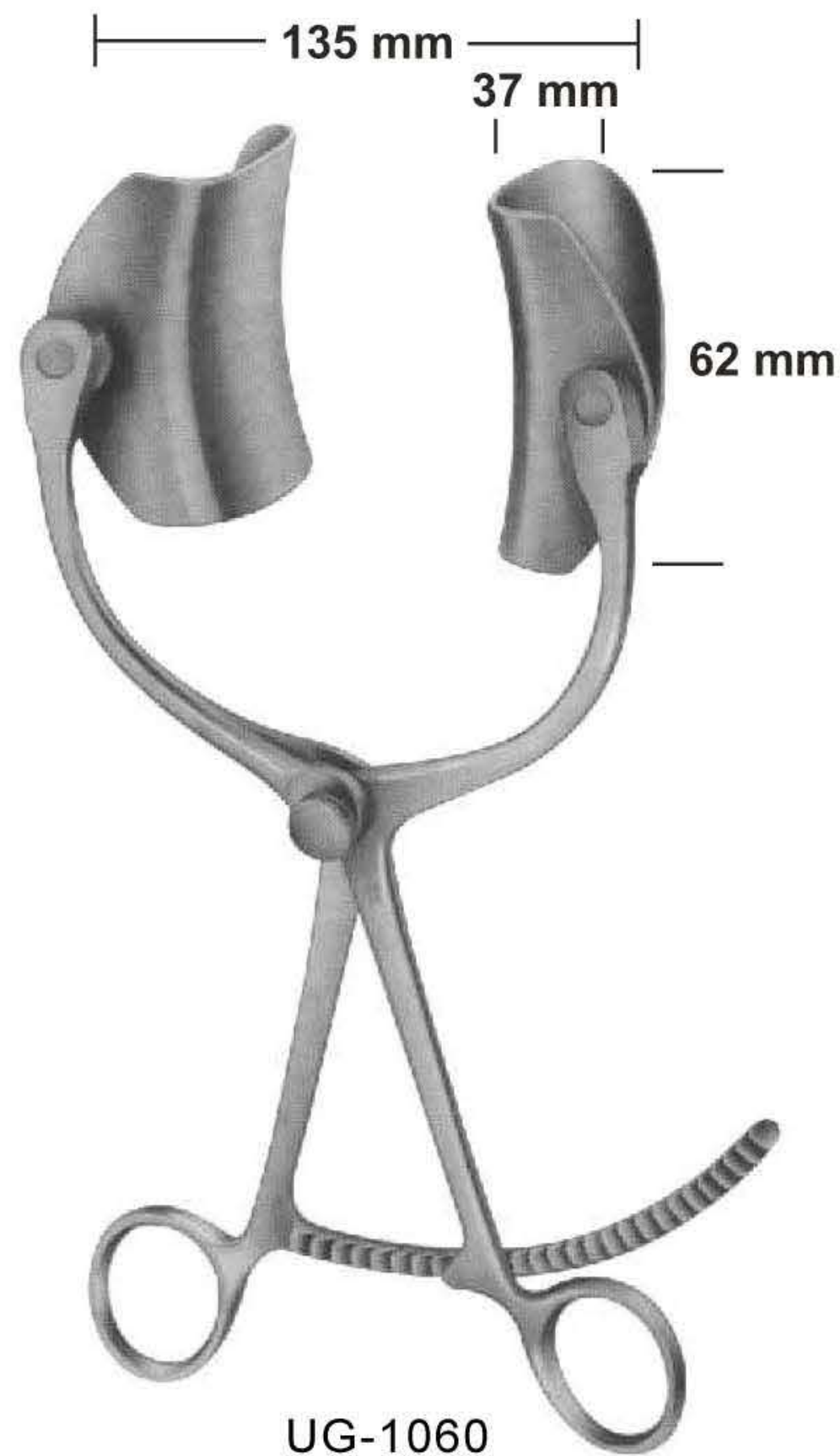

UG-1060
COLLIN
complete



UG-1063
COLLIN
complete



UG-1067
RICARD
complete



UG-1069
HOLZBACH
Complete

Abdominal Baldes

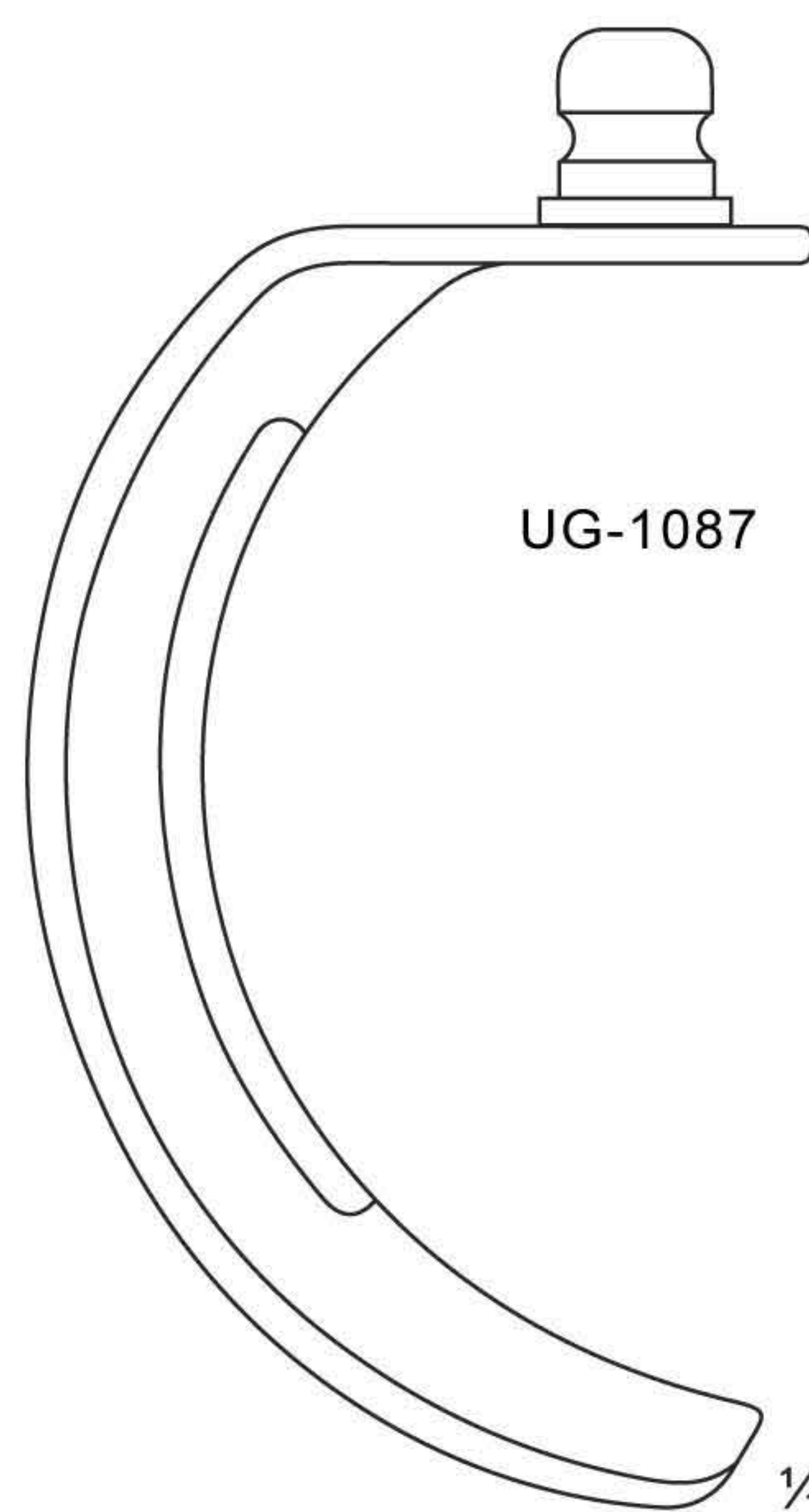
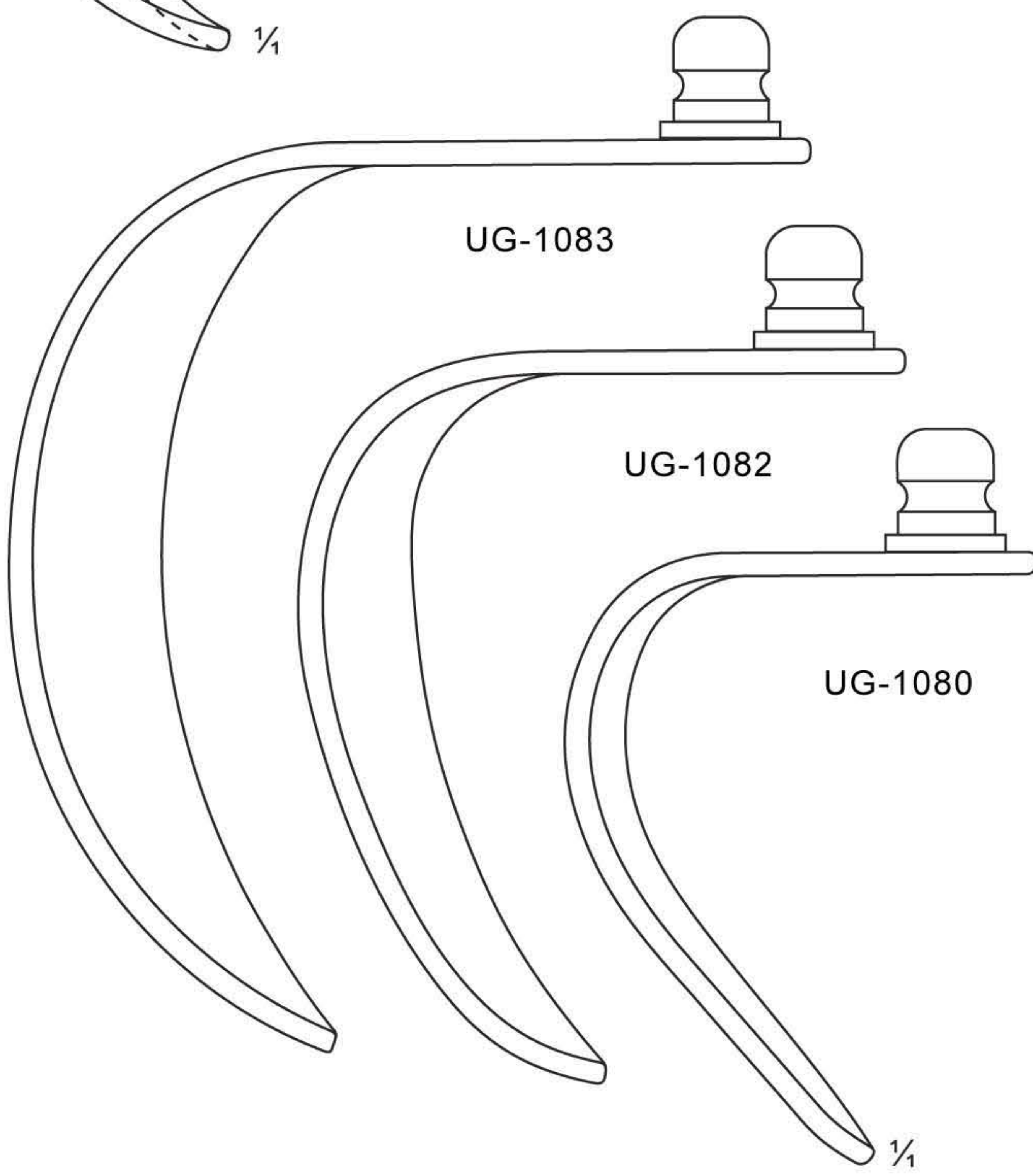
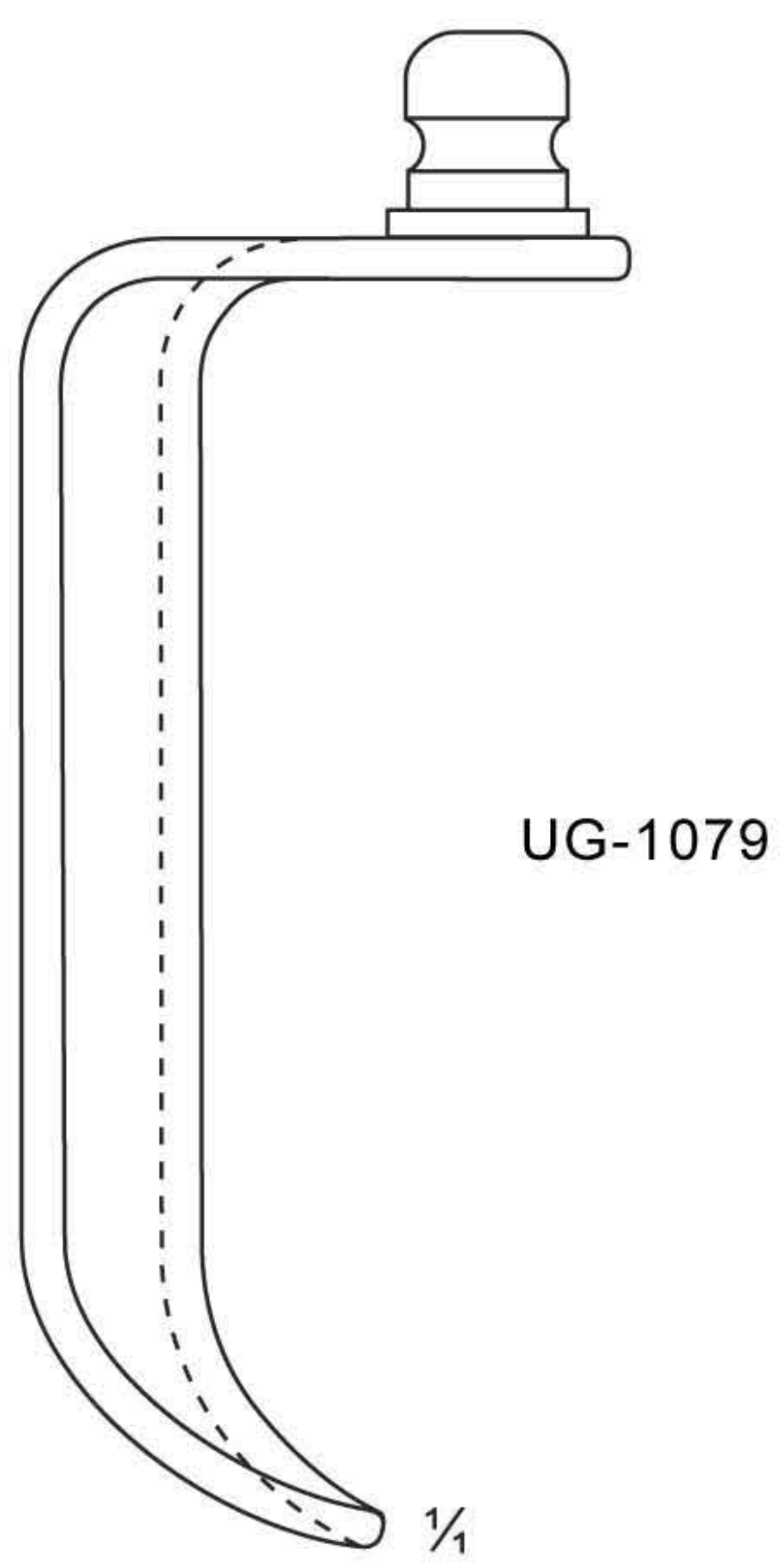
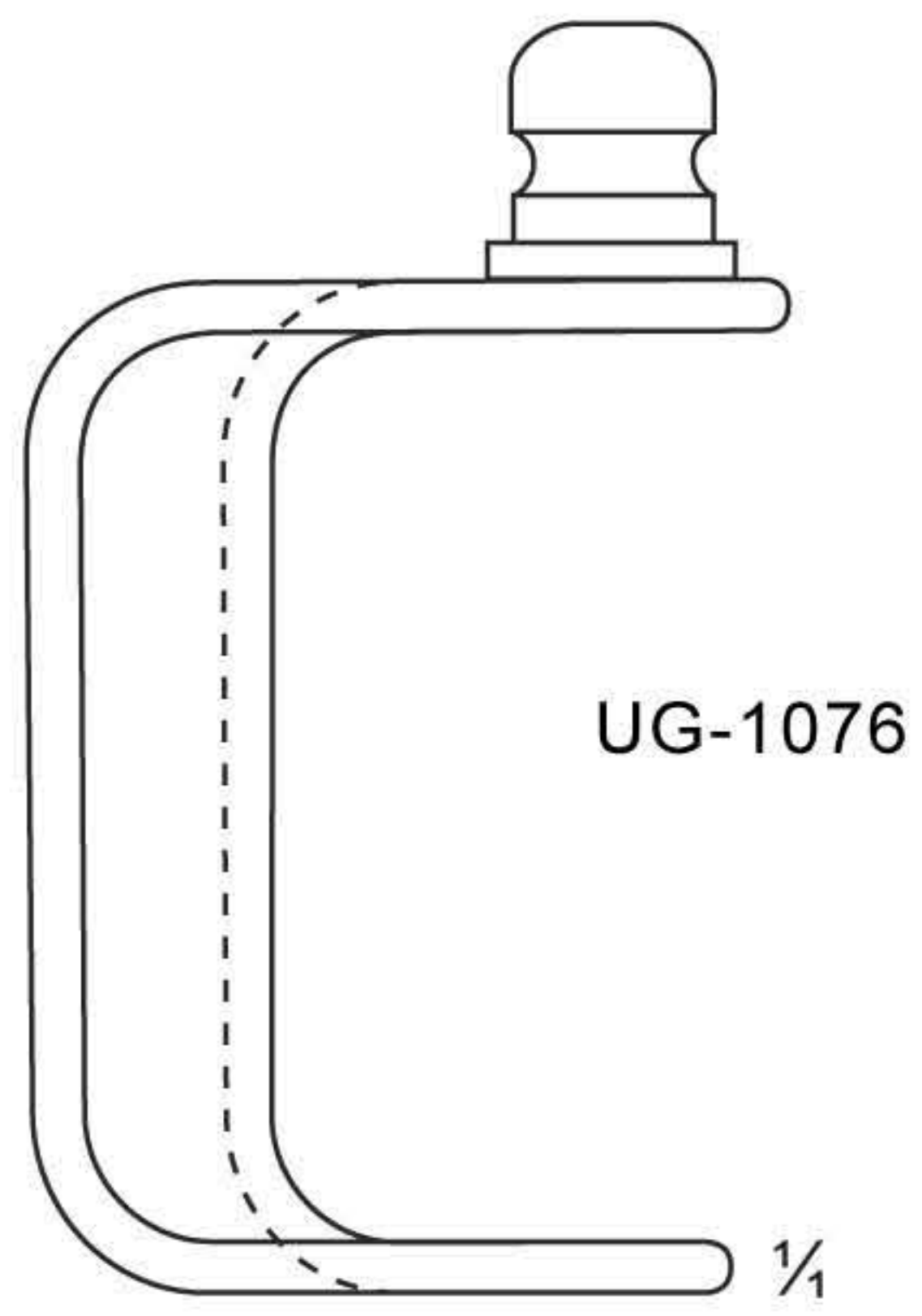

Abdominal Retractors

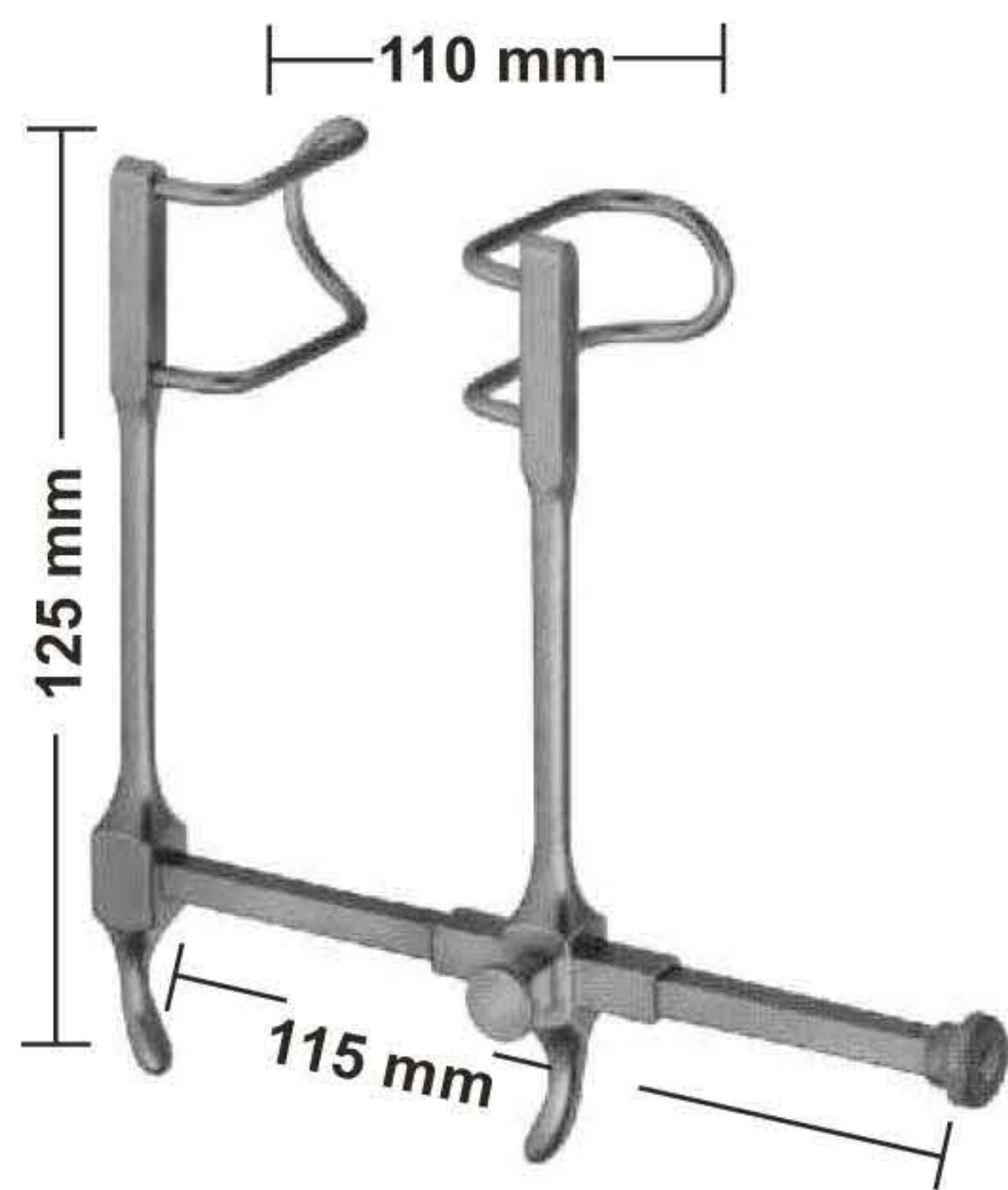

UG-1090
GOSSET
Blades:38 mm deep

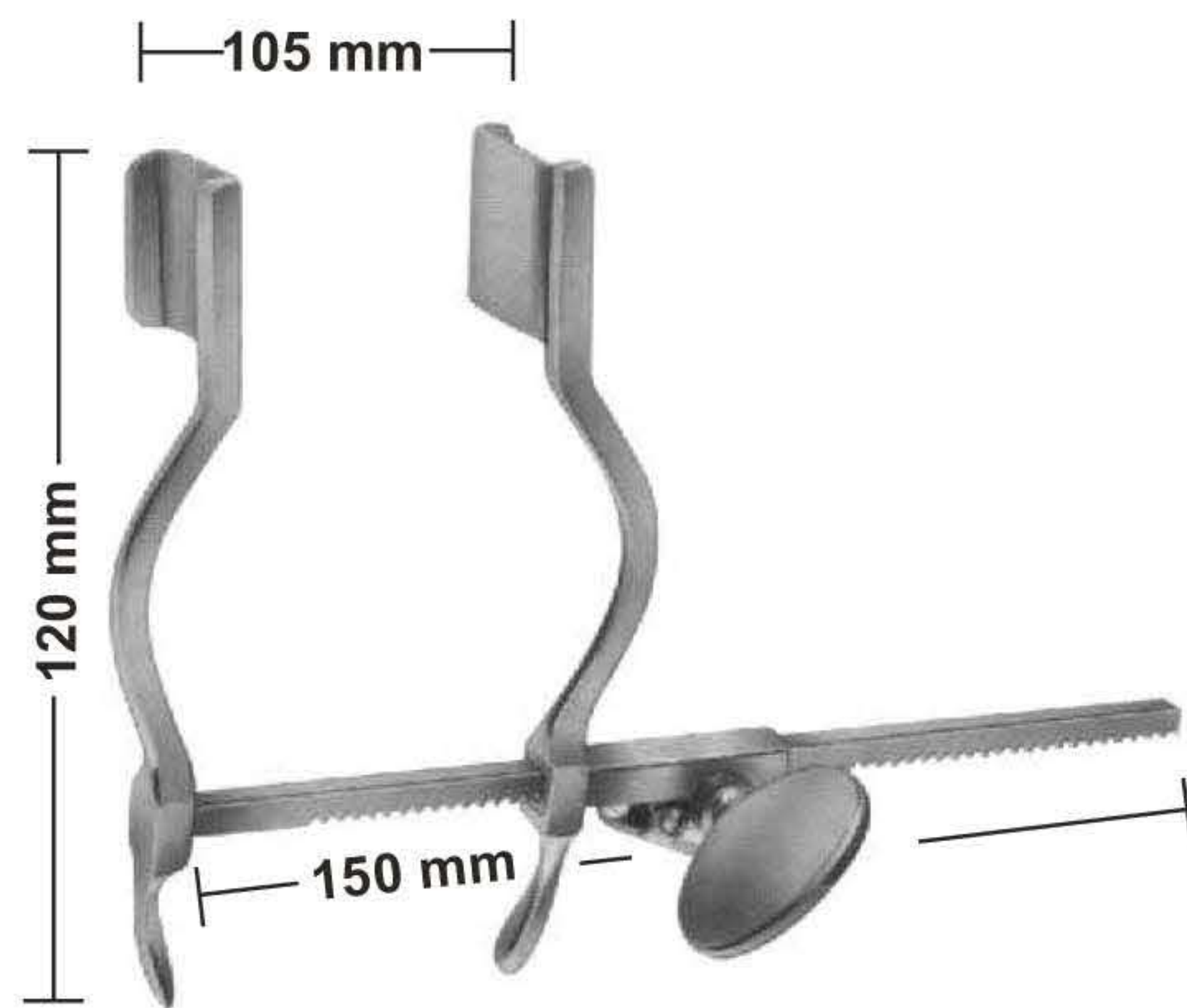

UG-1092
HERTZLER
Blades 20 X 25 mm

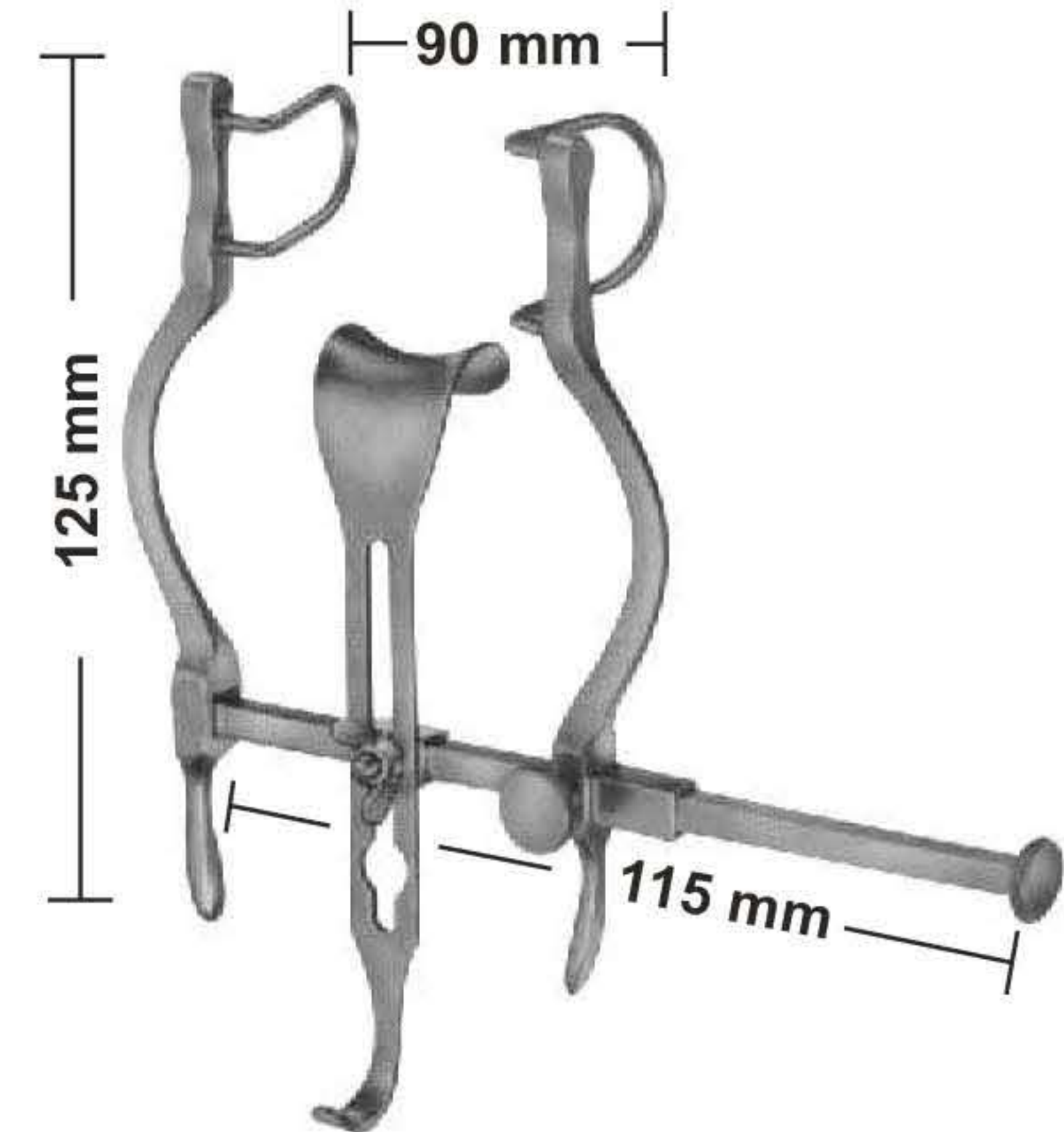

UG-1094
BALFOUR-BABY
Lateral blades 27 mm deep
Center blade 21x24 mm

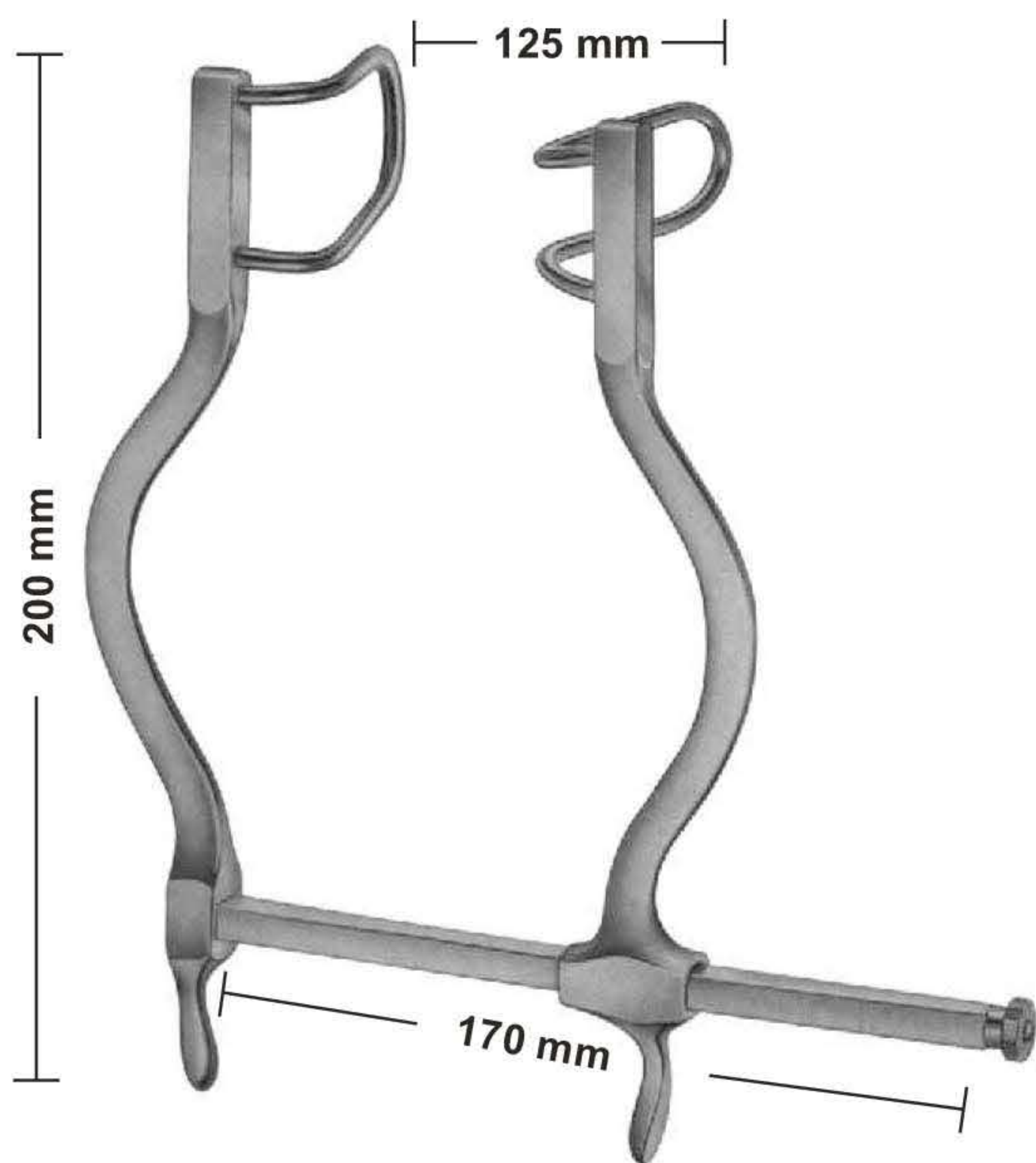

UG-1096
GOSSET
Blades:55mm deep

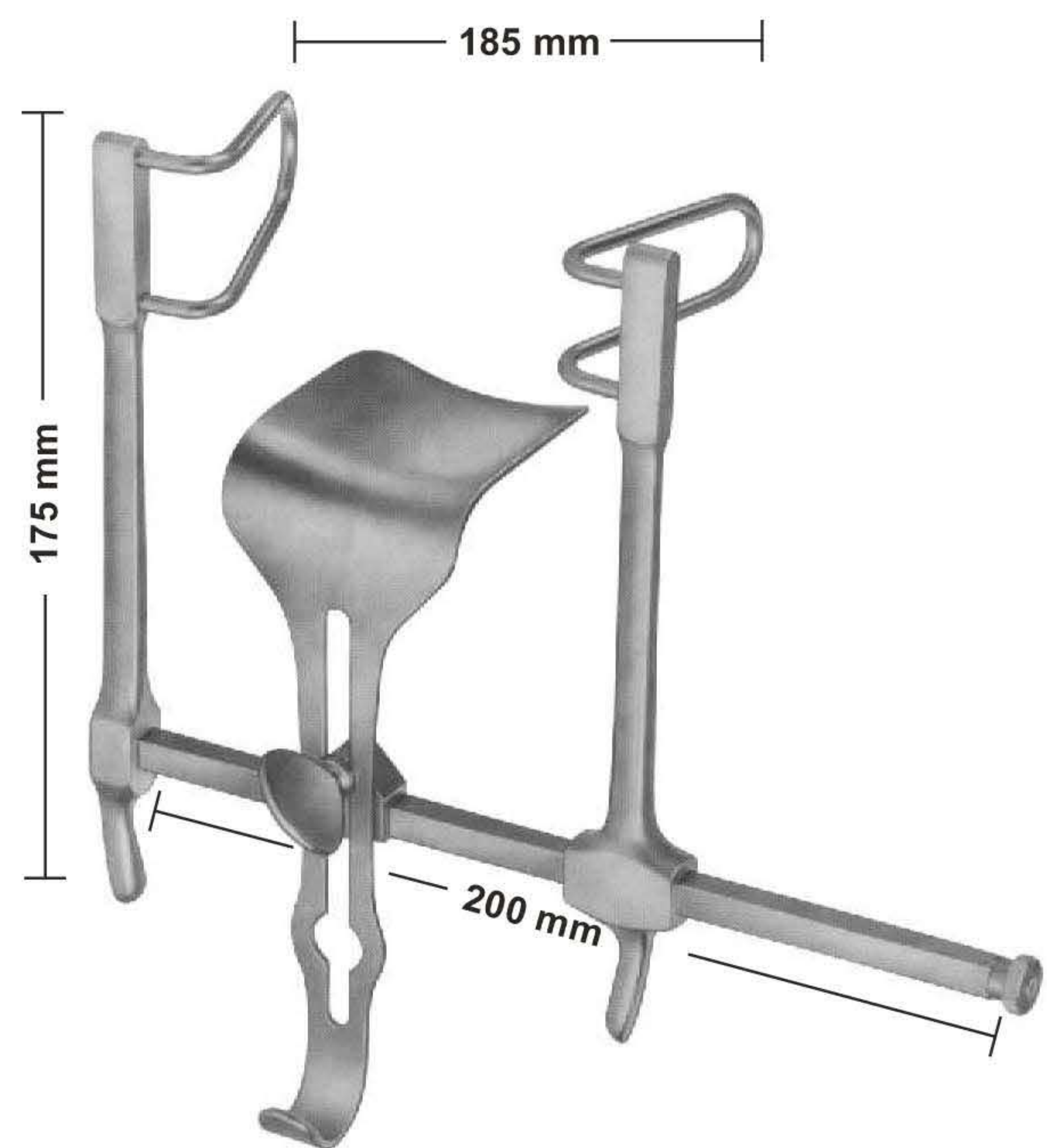

UG-1098
GOSSET
Lateral blades 58 mm deep
Center blade 59 x 57 mm

Abdominal Retractors

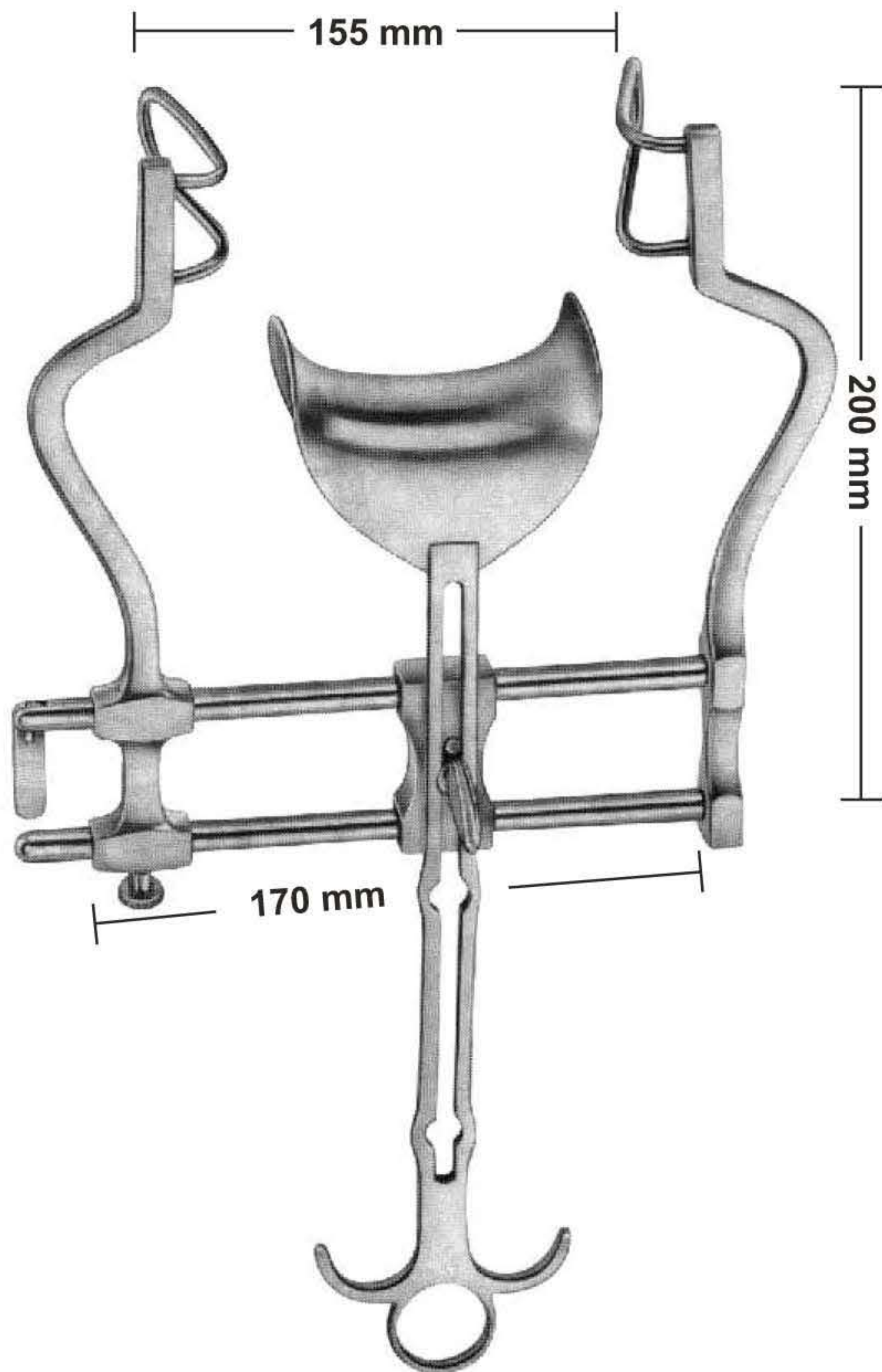

UG-1099
BALFOUR
Lateral blades 60 mm deep
Center blade 47 x 80 mm

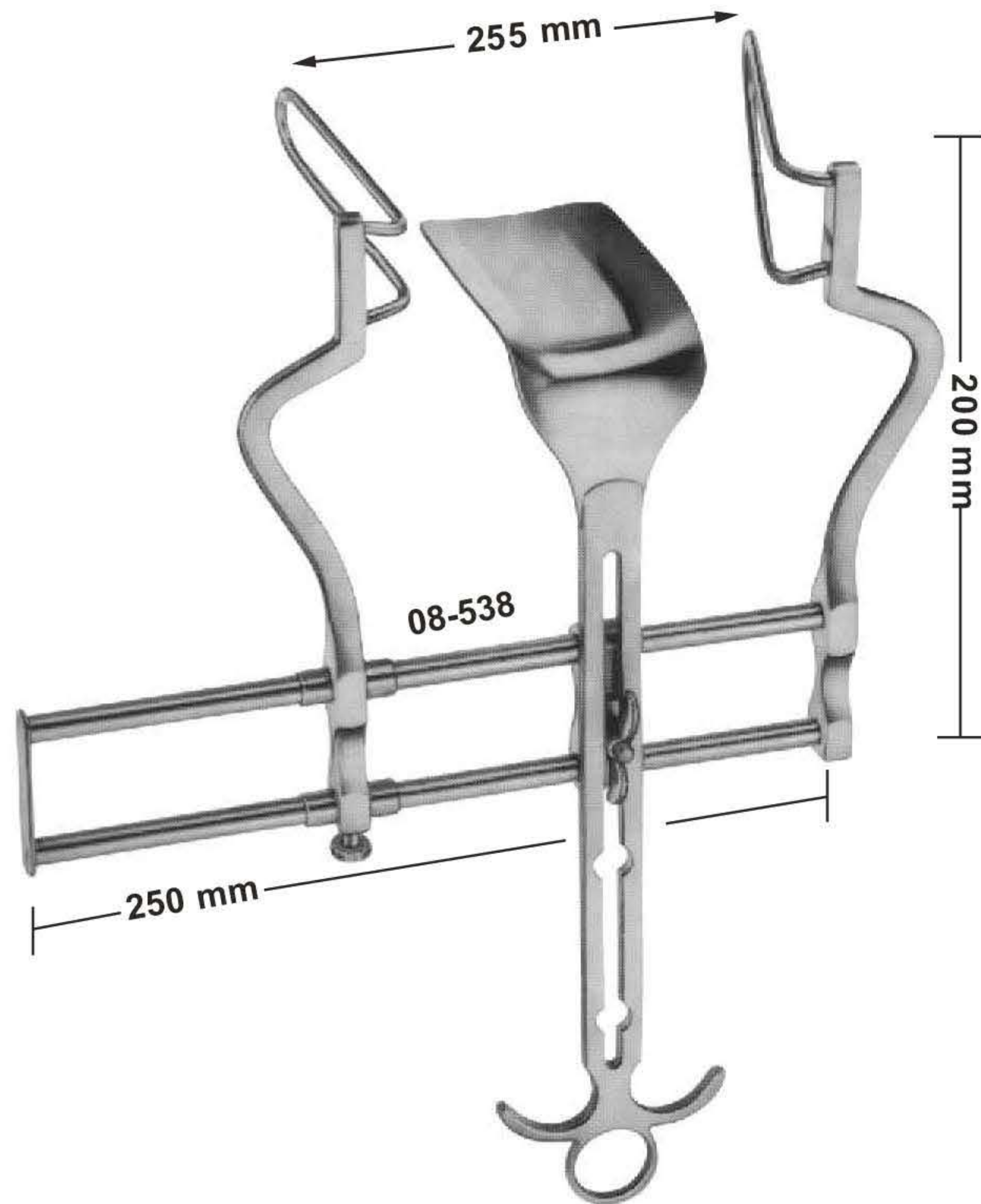

UG-1100
BALFOUR
Lateral blades 105 mm deep
Center blade 107x 59 mm

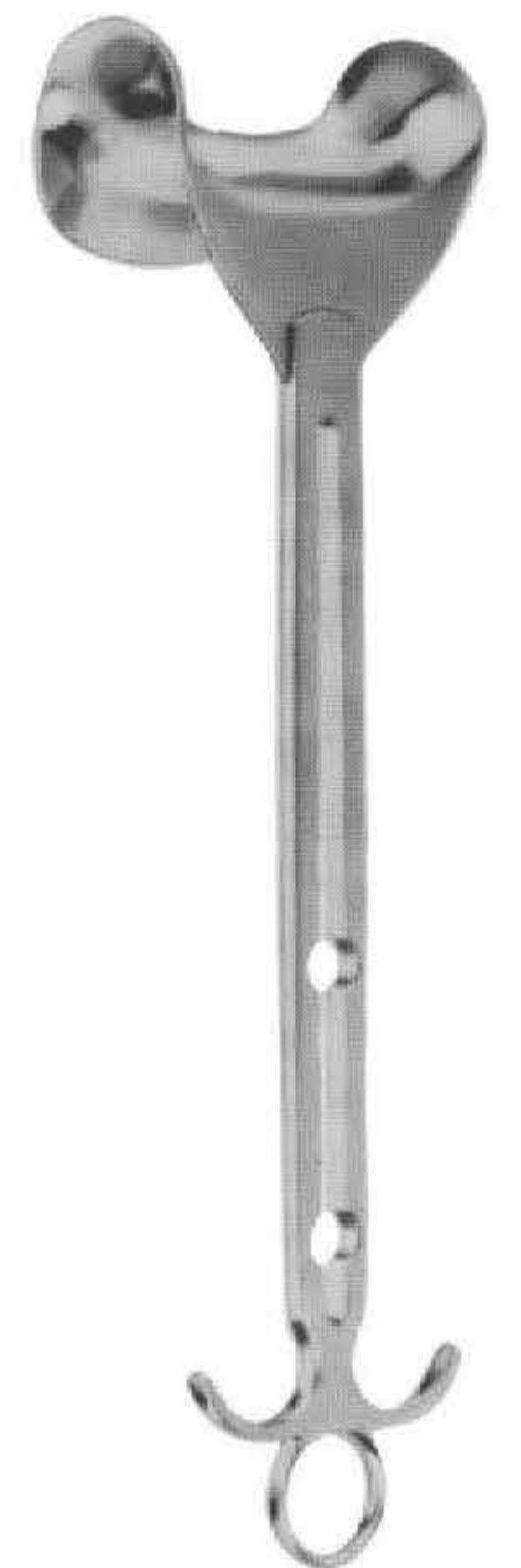

UG-1103
Center blade only
54x80 mm

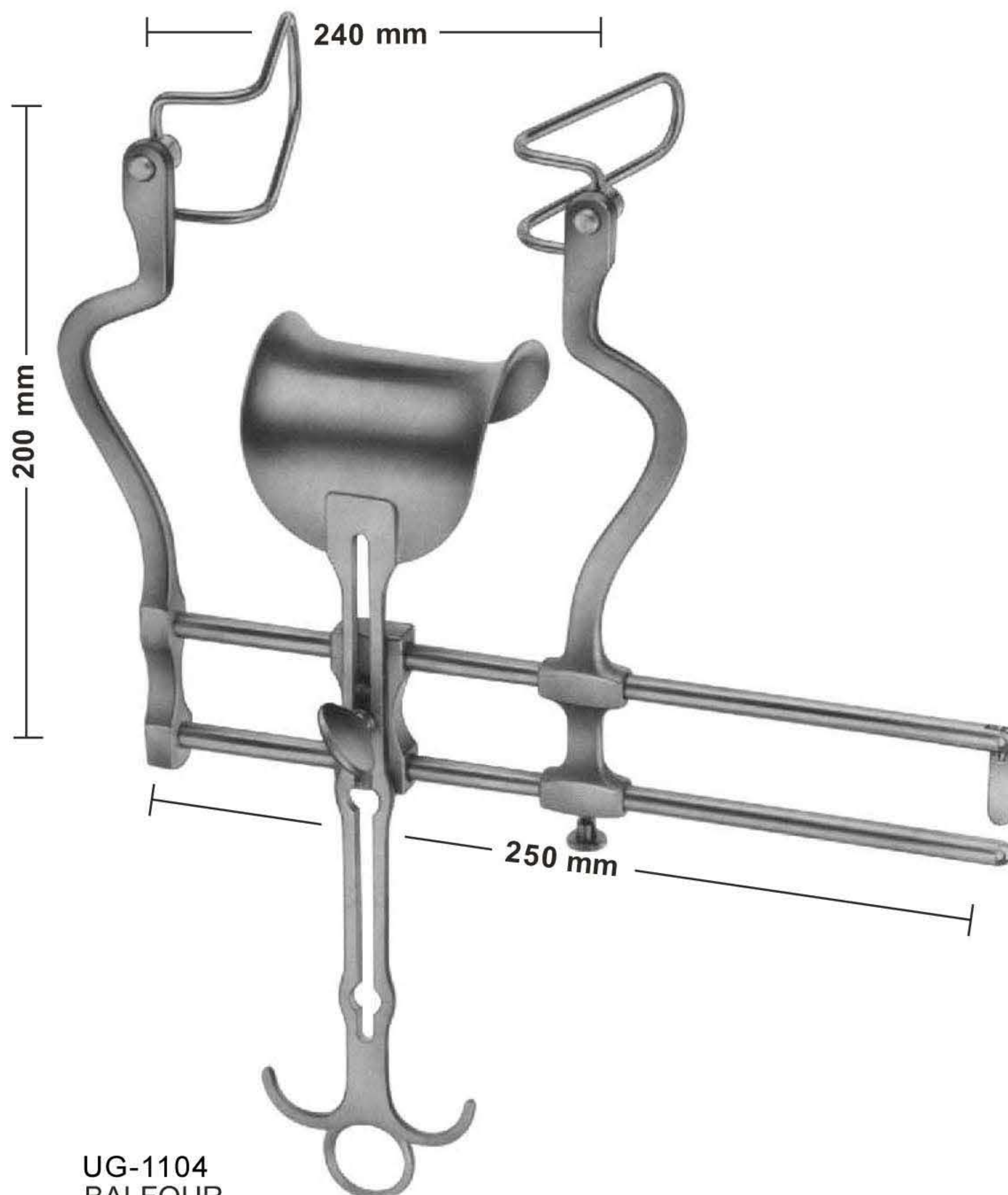

UG-1104
BALFOUR
Spreader only 08-540 08-541 08-542 08-543
Lateral blades 50 mm 60 mm 75 mm 90 mm
Center blade 47 x 80 mm 62x76 mm 80x80 mm 80x80 mm

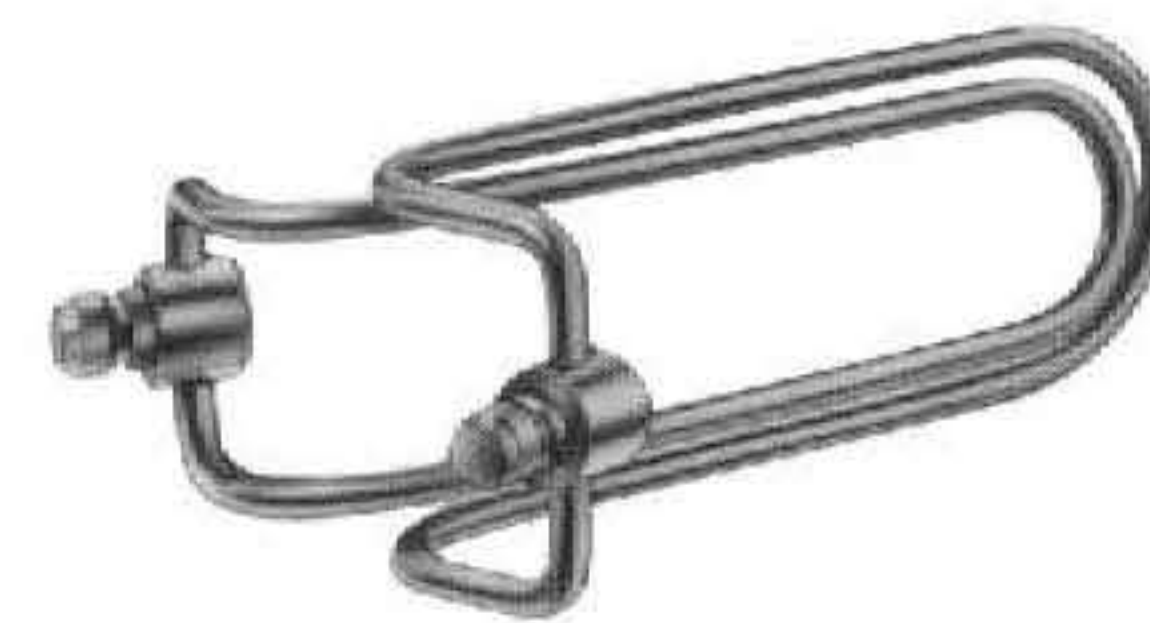

Sales Unit of blades:PR = pair

Lateral blades
08-544 50 mm deep
08-545 60 mm deep
08-546 75 mm deep
08-547 90 mm deep

Abdominal Retractors

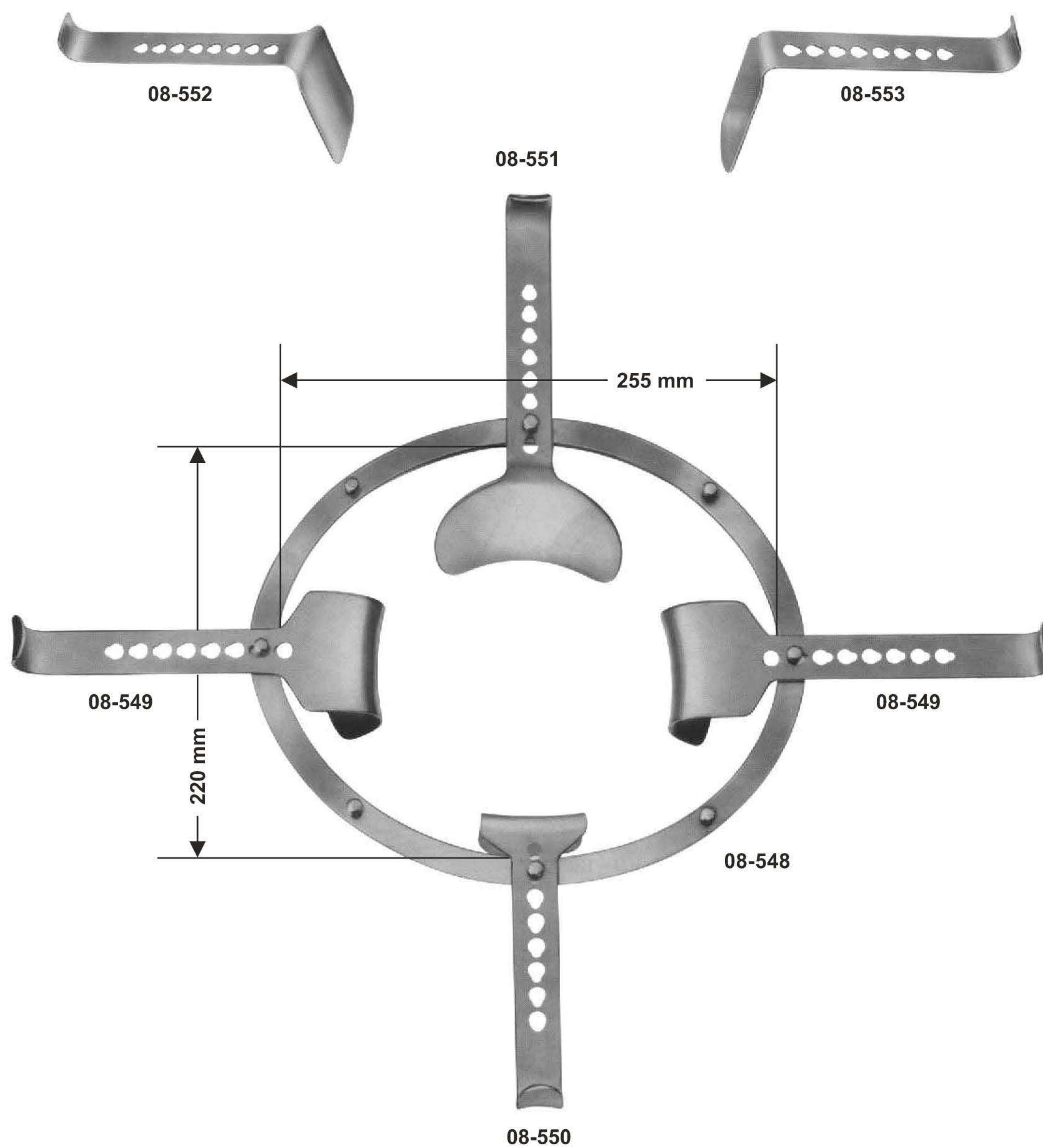

UG-1110

SEMM

consisting of:

08-548 1 frame 225 x 220 mm

08-549 2 blades 46 x 64 mm

08-550 1 blade 53 x 54 mm
(for bladder)

08-551 1 blade 82 x 97 mm
(for intestine)

08-552 1 blade 98 x 51 mm
(for intestine)

08-553 1 blade, narrow
107 x 36 mm

Abdominal Retractors

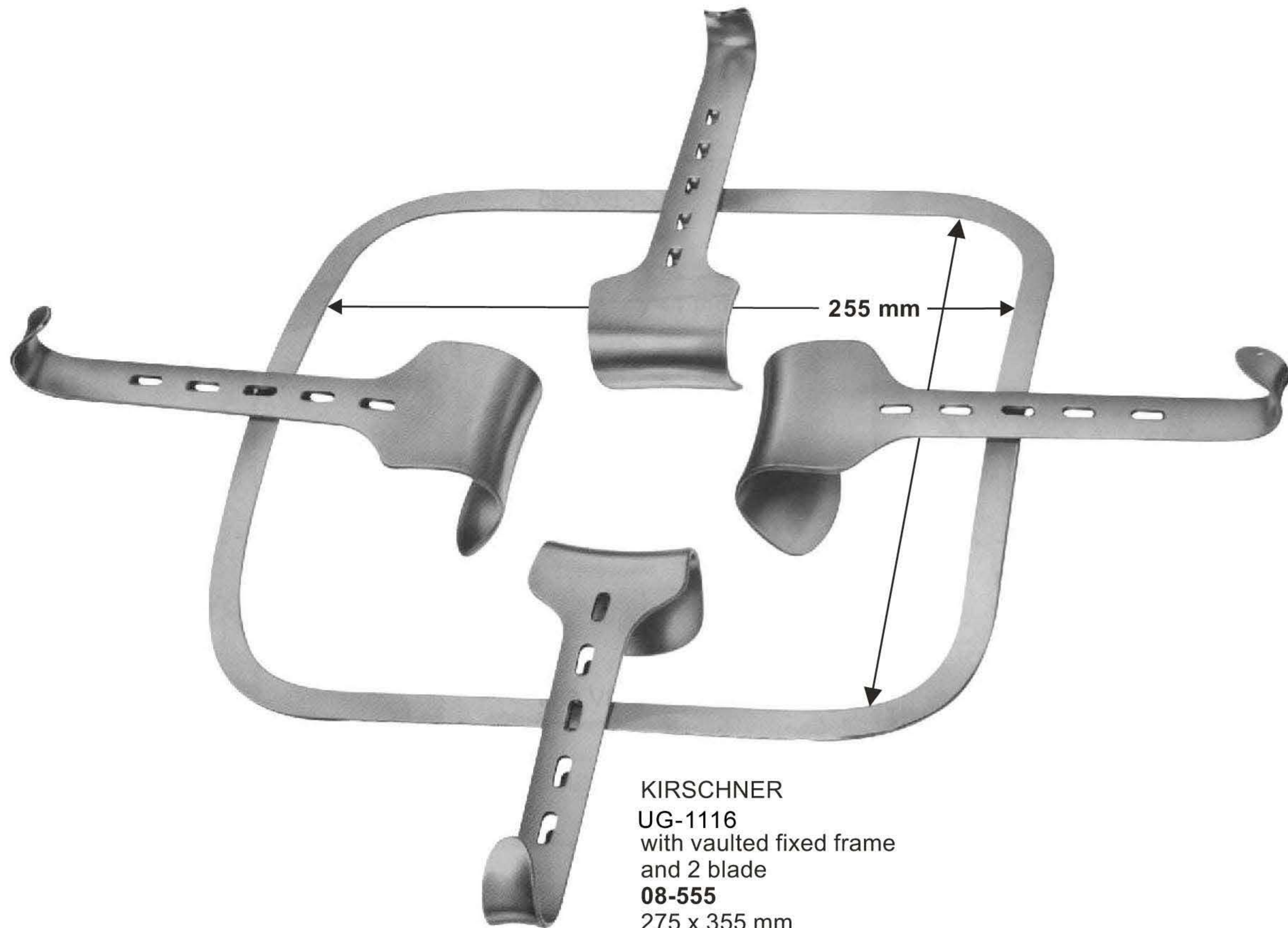

KIRSCHNER
 UG-1116
 with vaulted fixed frame
 and 2 blade
08-555
 275 x 355 mm
 Frame only, over-sized
08-556
 295 x 275 mm
 Frame only



UG-1120
 KIRSCHNER
 64 x 80 mm



UG-1121
 KIRSCHNER-BALFOUR
 80x 82 mm



UG-1122
 KIRSCHNER
08-559 90x 69mm
08-560 92x 95mm
08-561 78x 58mm



UG-1124
 KIRSCHNER
08-562 108x42mm
08-563 91x 55mm
08-564 121x 55mm

Intestinal and Tissue Grasping Forceps

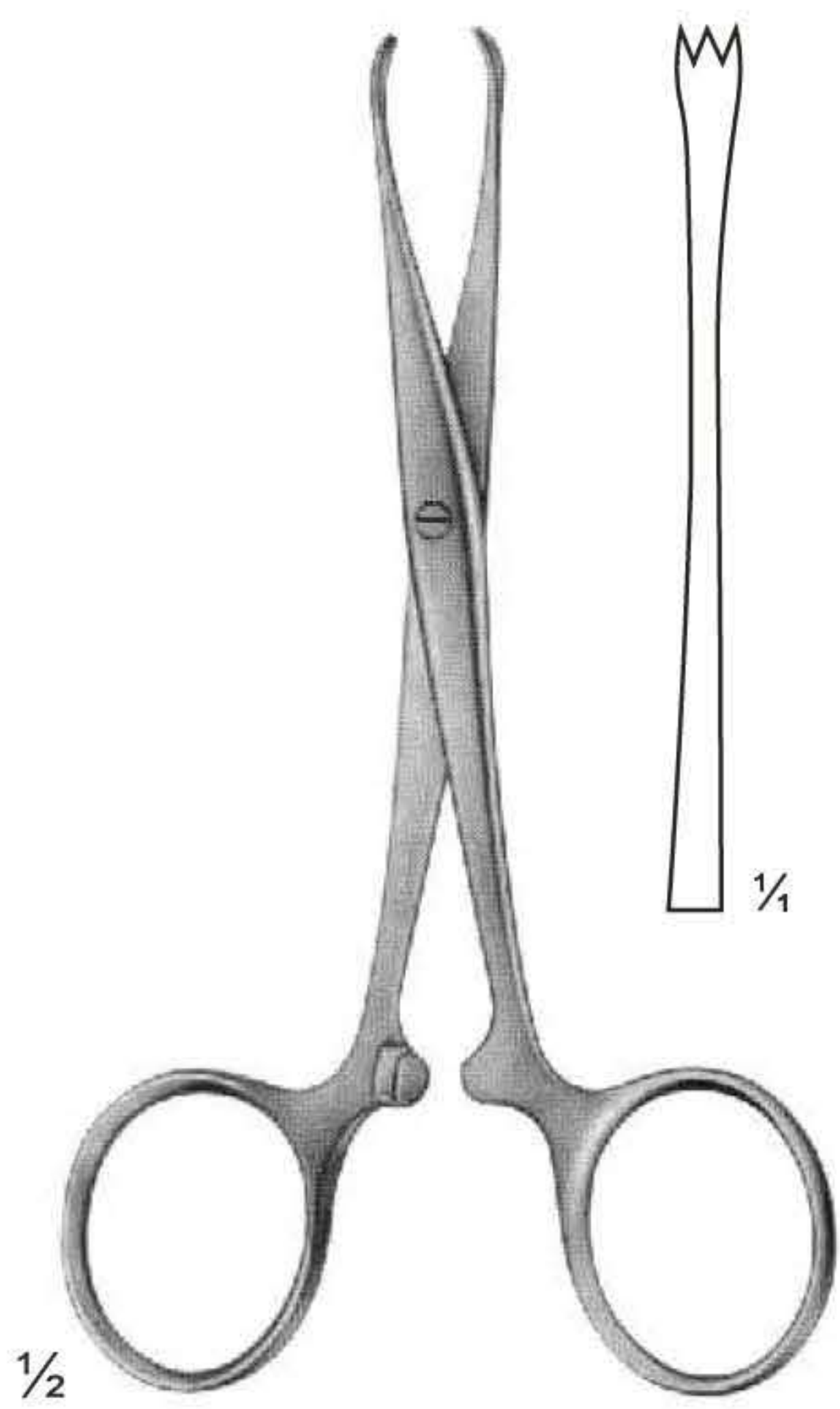

UG-1127
CHAPUT
 2 X 3 teeth, sharp
 125 mm,

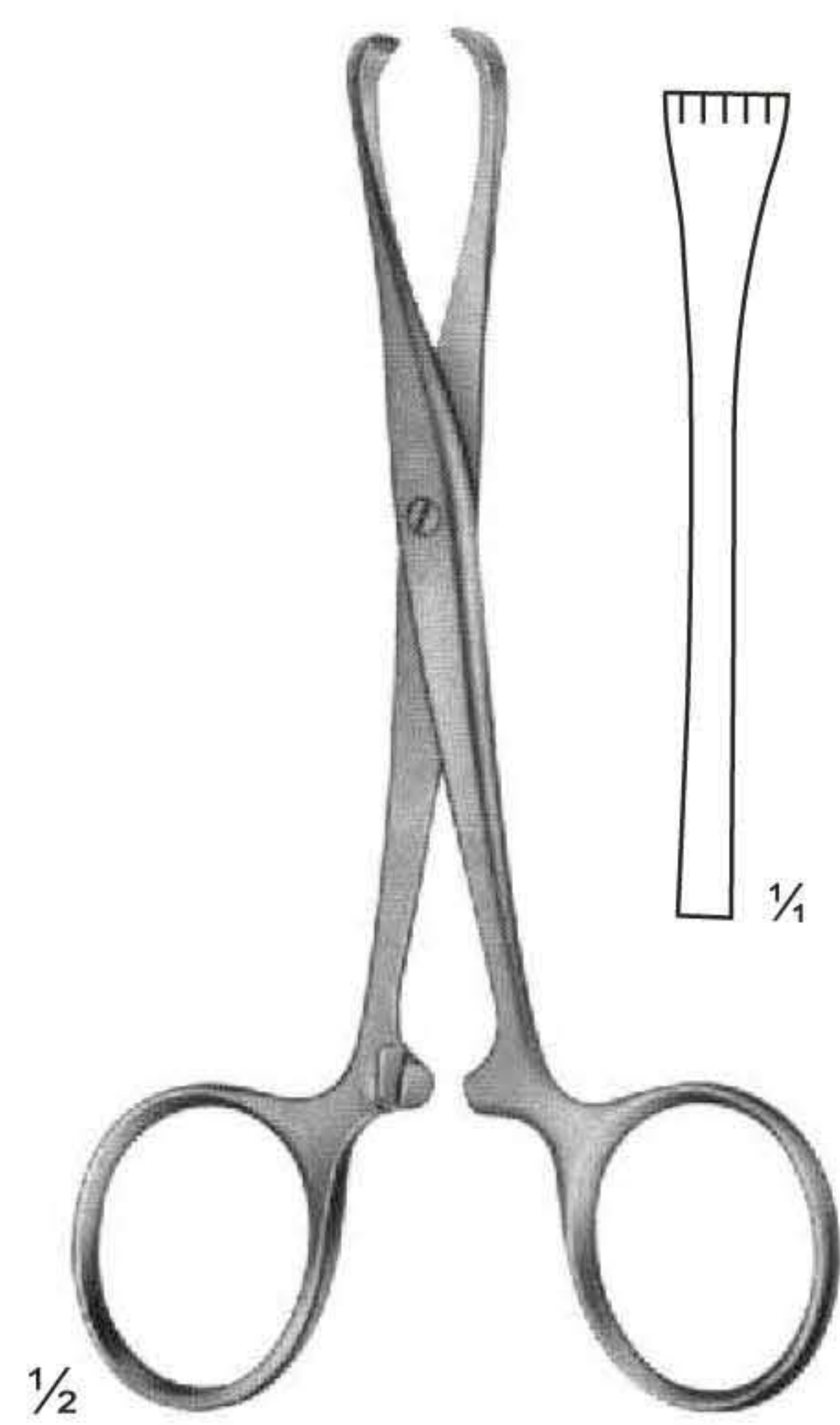

UG-1128
TUFFIER
 5 X 6 teeth, sharp
 125 mm,

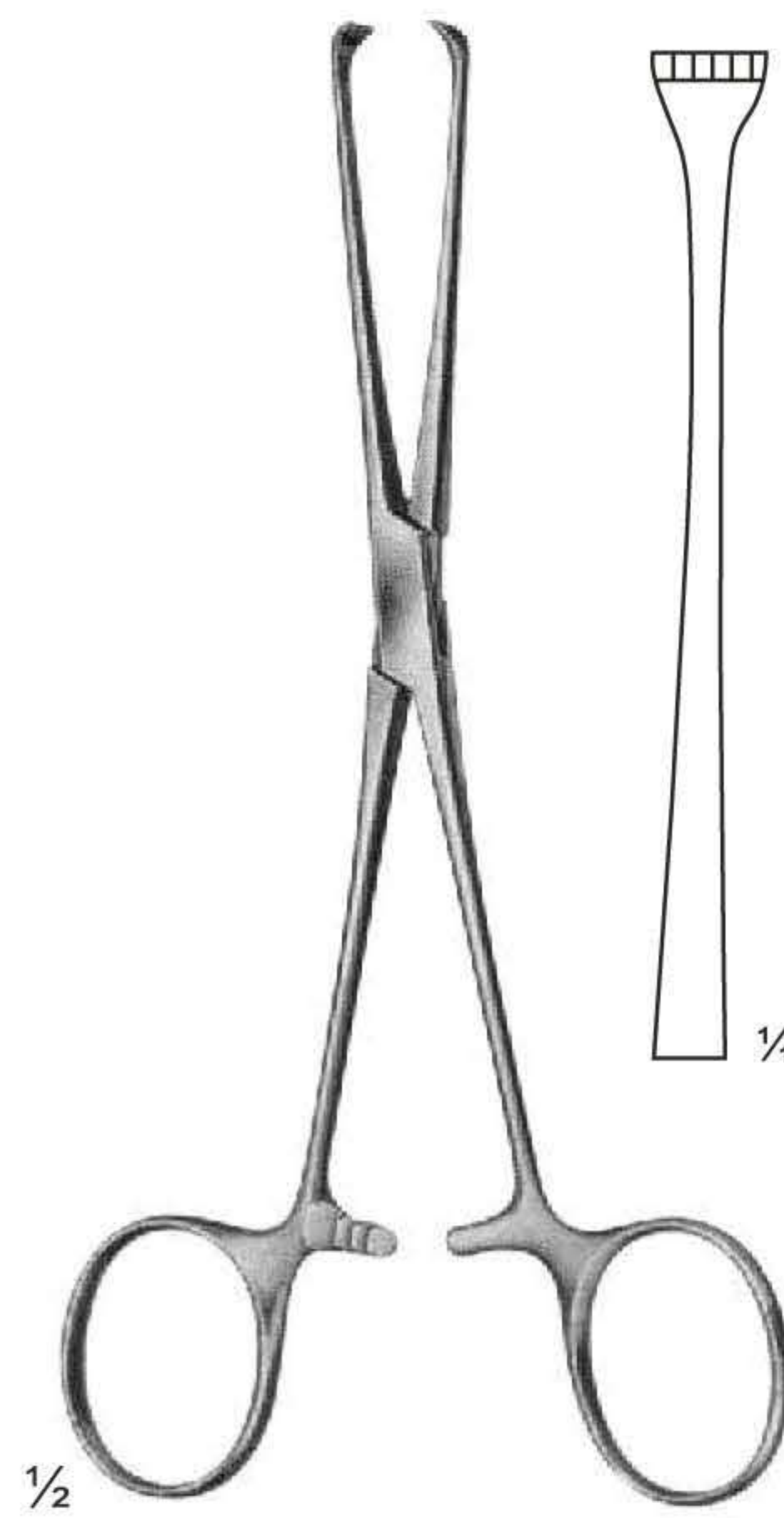

UG-1129
BOYS-ALLIS
 5 X 6 teeth, sharp
 155 mm,

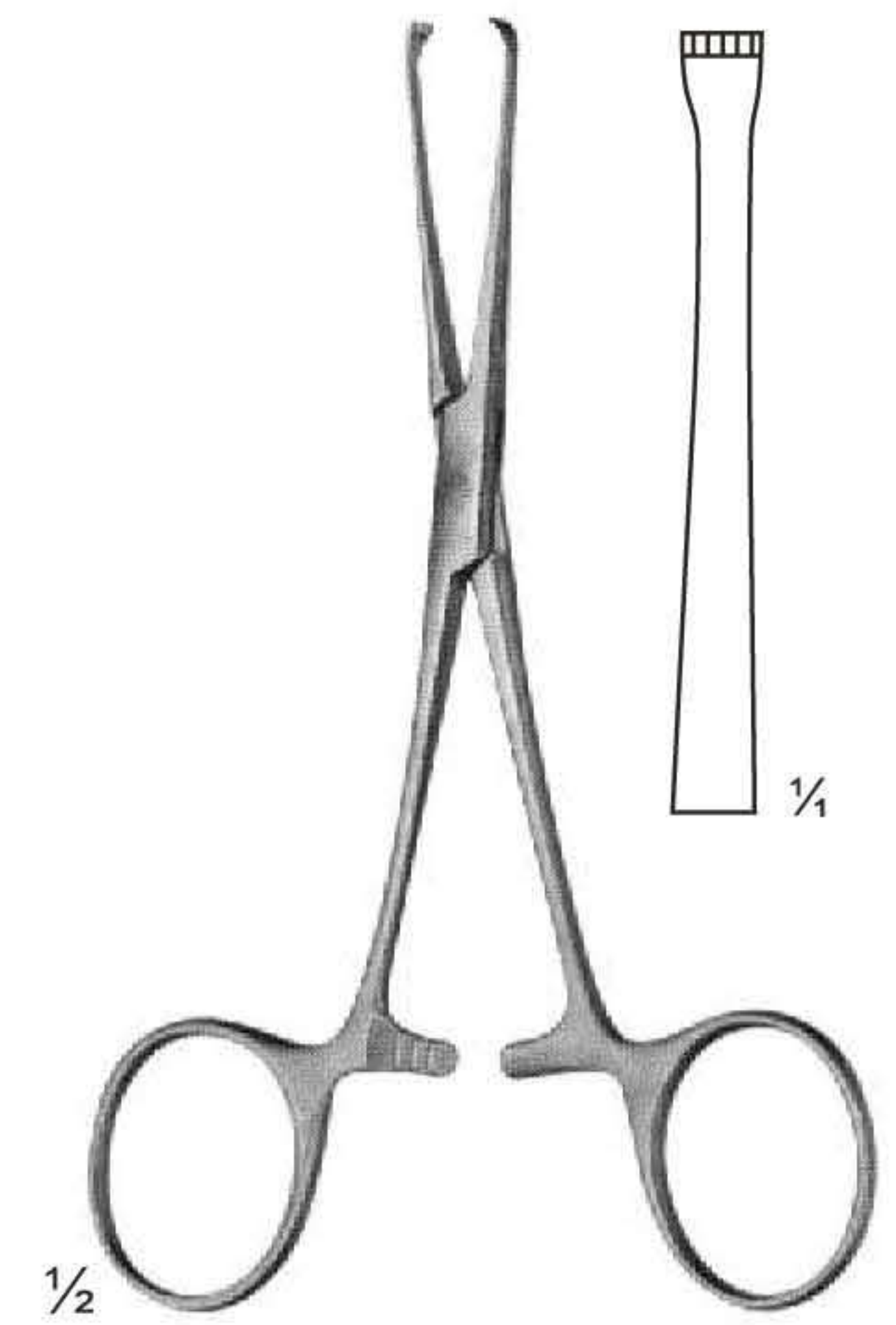

UG-1130
ALLIS
 4 X 5 teeth
 155 mm,



UG-1131
ALLIS
 155 mm,
 4 X 5 teeth



UG-1132
ALLIS
 190 mm,
 255 mm,
 5 X 6 teeth



UG-1133
JUDD-ALLIS
 3 X 4 teeth
 195 mm,

Intestinal Grasping Forceps

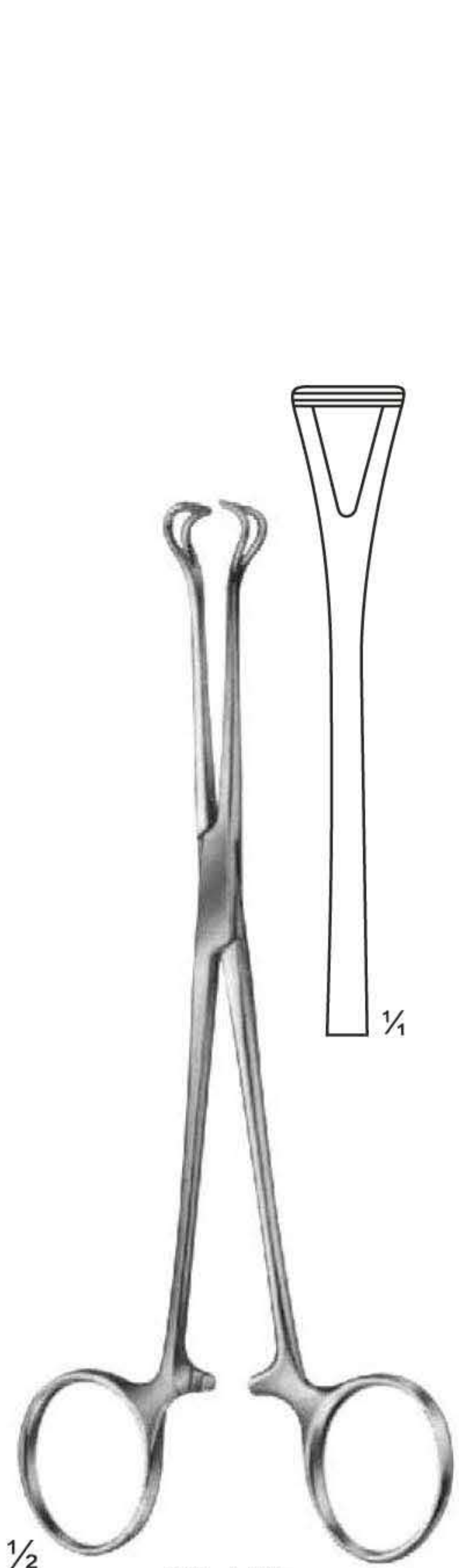

$\frac{1}{2}$
UG-1135
 BABCOCK
 155 mm



$\frac{1}{2}$
UG-1136
 BABCOCK

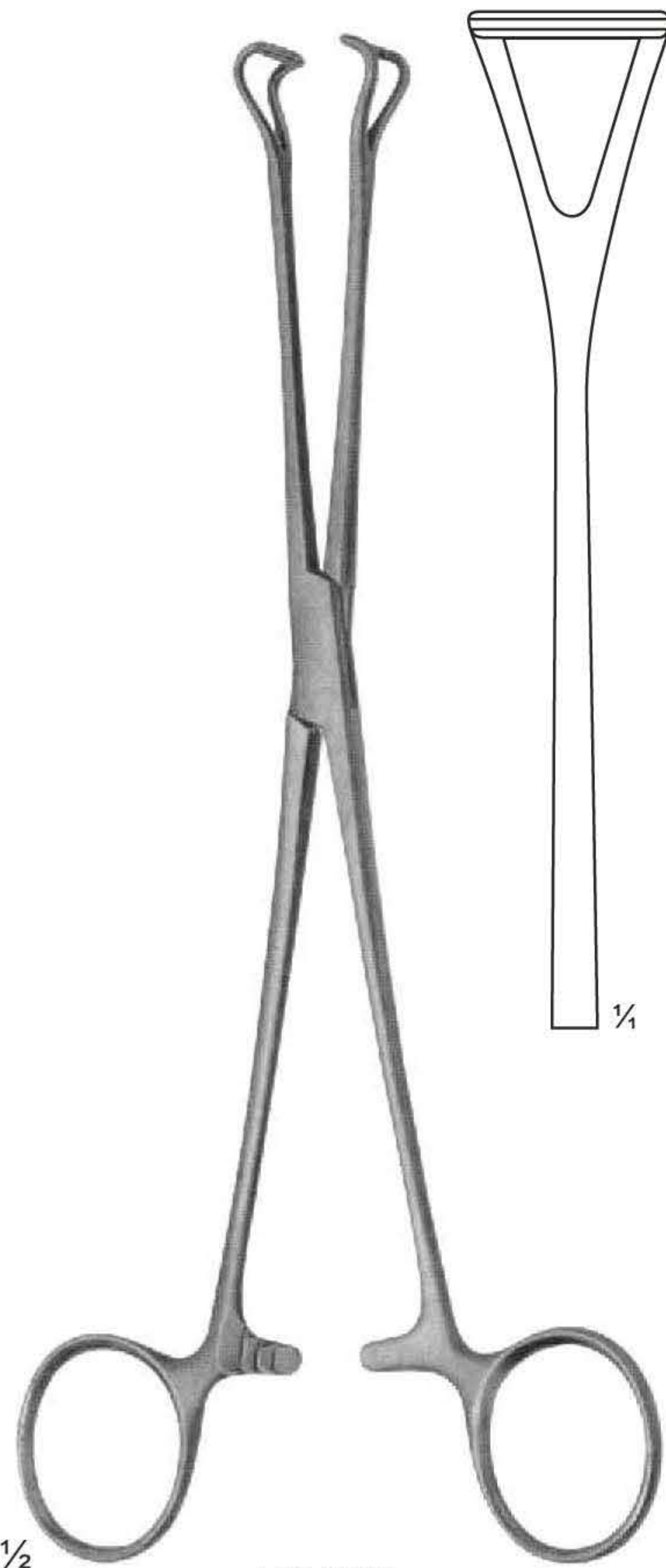

$\frac{1}{2}$
UG-1138
 BABCOCK
 220 mm

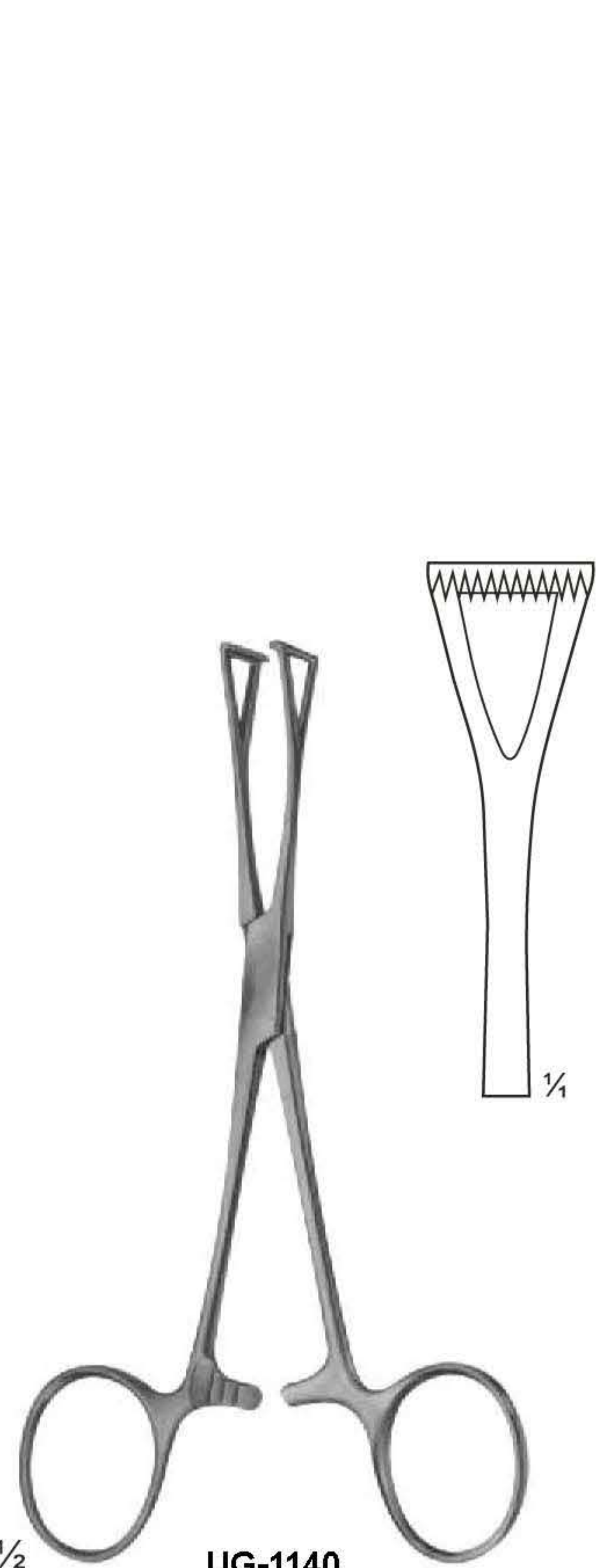

$\frac{1}{2}$
UG-1140
 COLLIN
 140 mm,

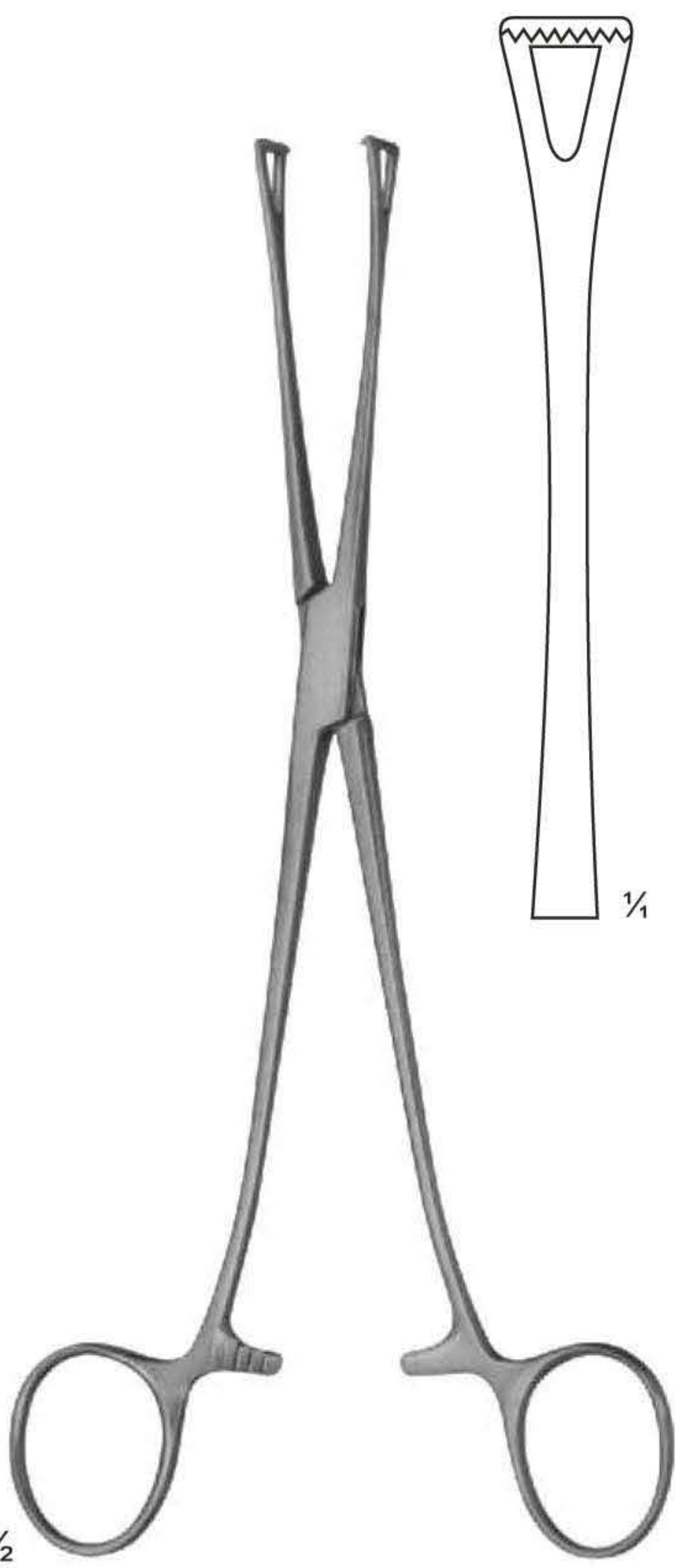

$\frac{1}{2}$
UG-1141
 LOCKWOOD
 200 mm,

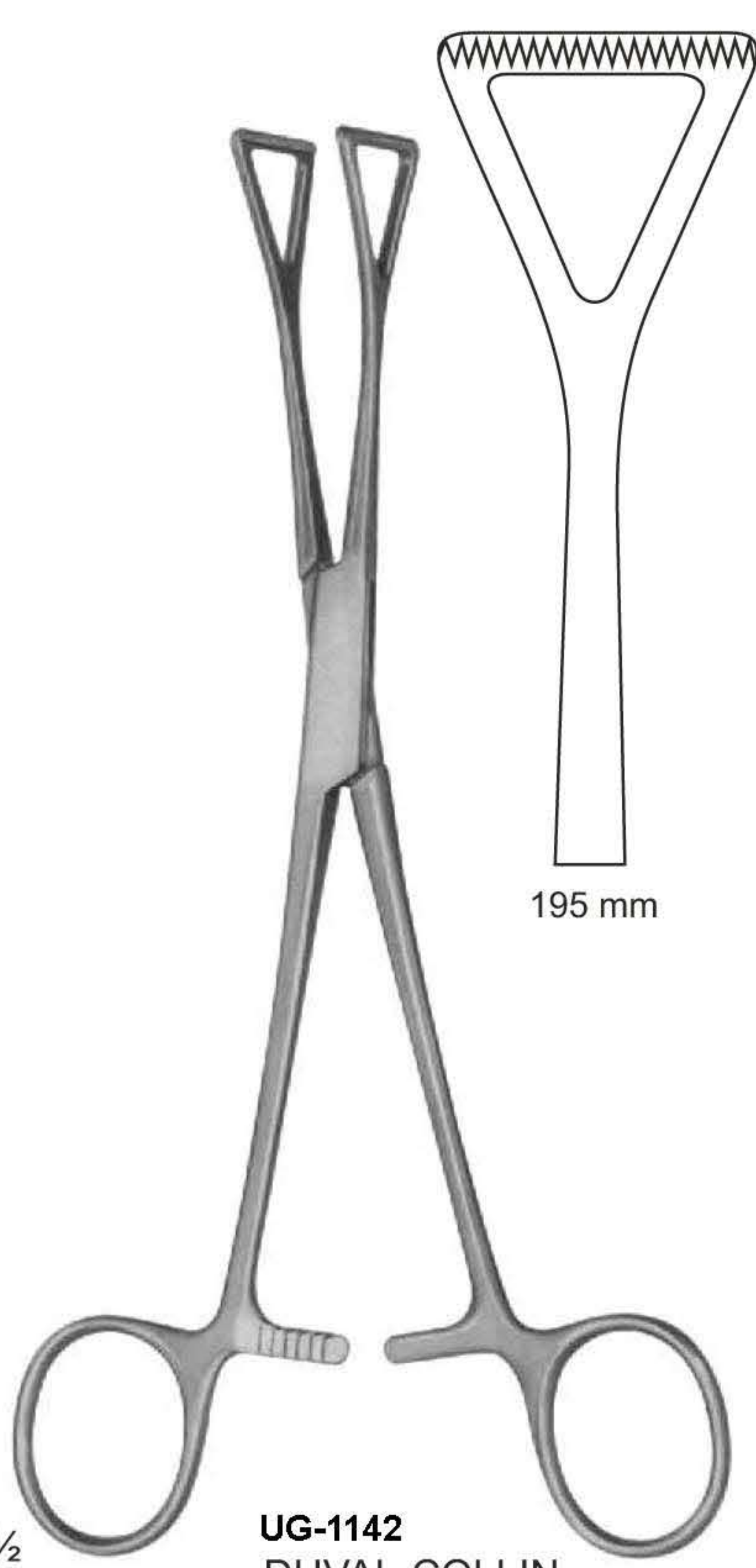

$\frac{1}{2}$
UG-1142
 DUVAL-COLLIN
 195 mm
 200 mm

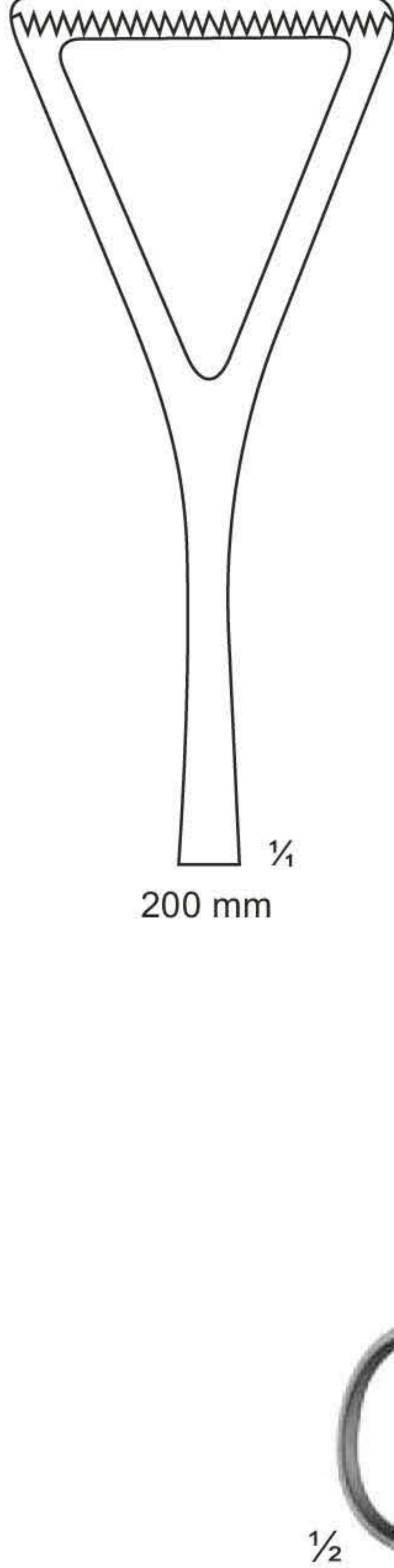

$\frac{1}{2}$
UG-1143
 DUVAL
 230 mm,

Cone Knives, Myomatome, Trigeminal & Tonsil Knives



UG-179
AYRE
 Size: 200mm
 Cone Knife

UG-182
 Size: 120mm
 Cone Knife

UG-185
SEGOND
 Size: 115mm
 Myomatome

UG-186
OLIVECRONA
 Size: 110mm
 Trigeminal
 Knife

UG-189
CONE
 Size: 55 mm
 Trigeminal
 Knife

UG-190
FOWLER
 Size: 115mm
 Tonsil Knife

UG-191
ABRAHAM
 Size: 115mm
 Tonsil Knife

UG-192
BRUNINGS
 Size: 115mm
 Tonsil Knife

Organ - Tissue Grasping, Dissecting & Intestinal Forceps



UG-1146
LANE

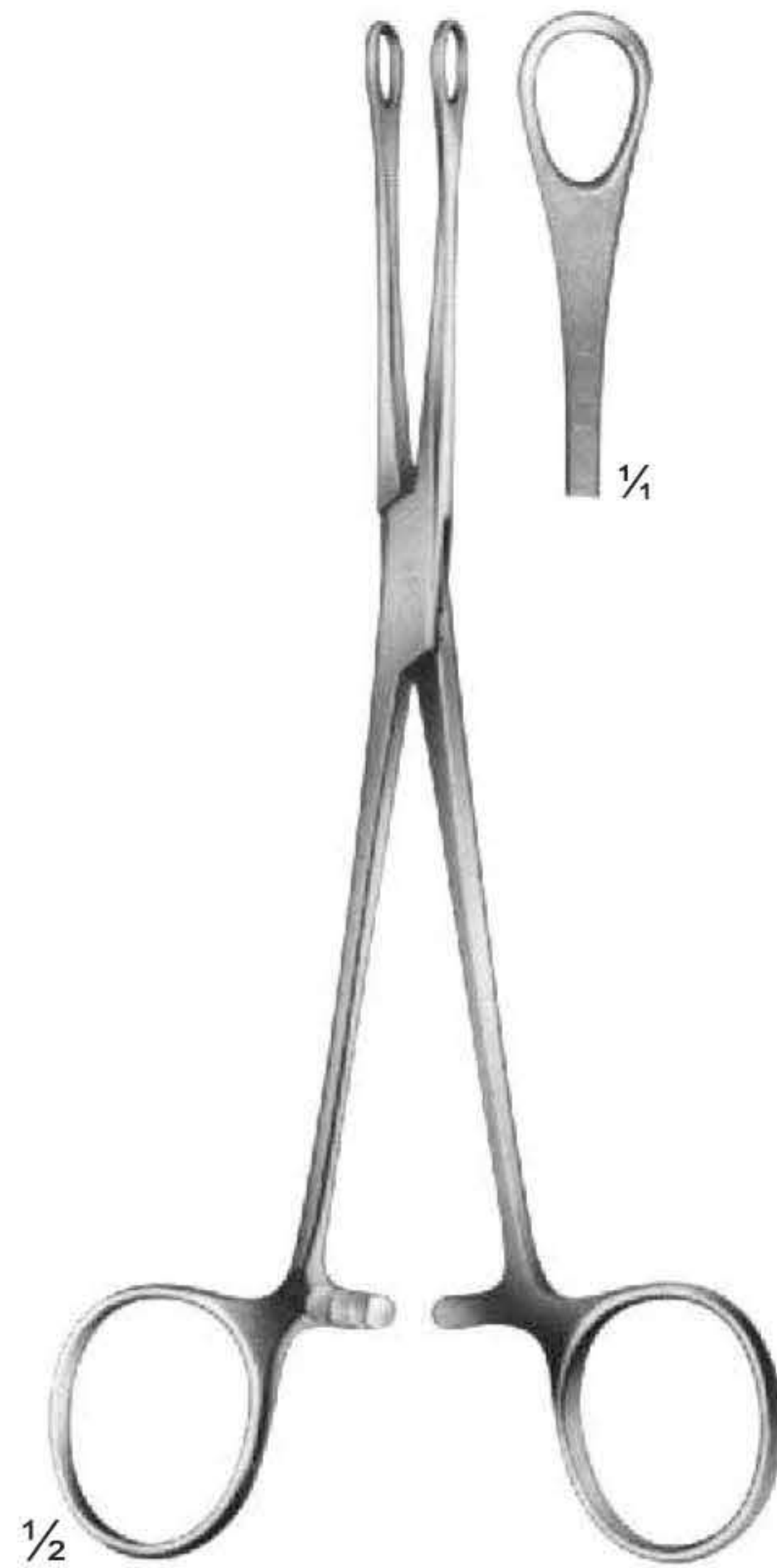

UG-1147
WILLIAMS
160 mm



UG-1148
DENIS
BROWNE
190 mm

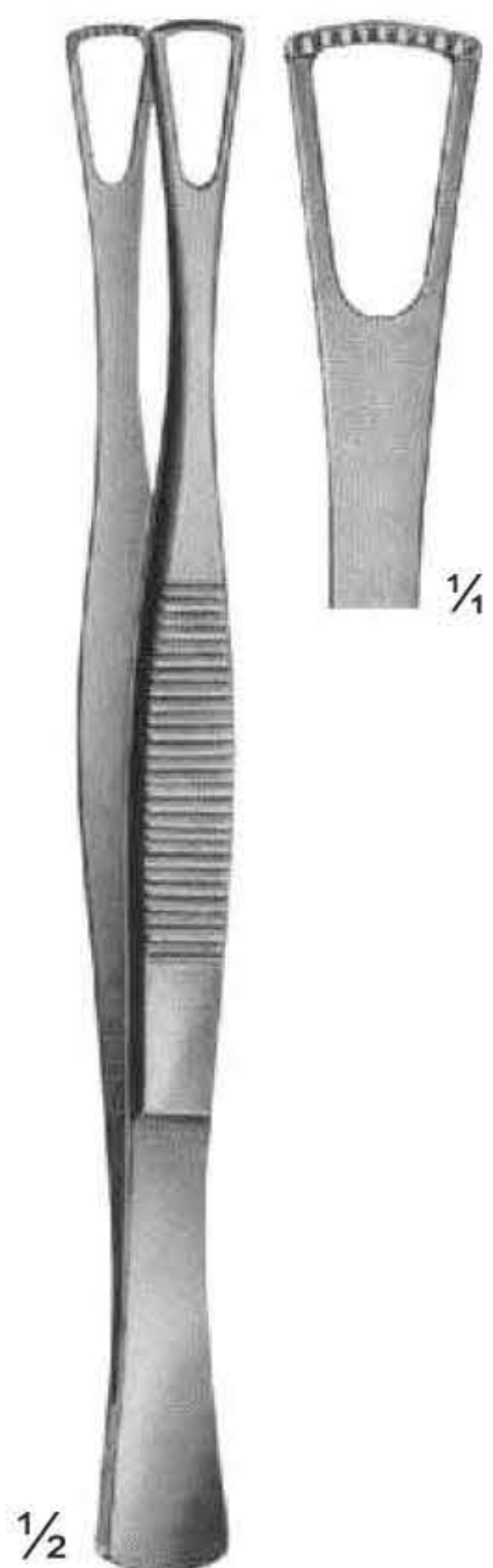

UG-1149
DUVAL
140 mm

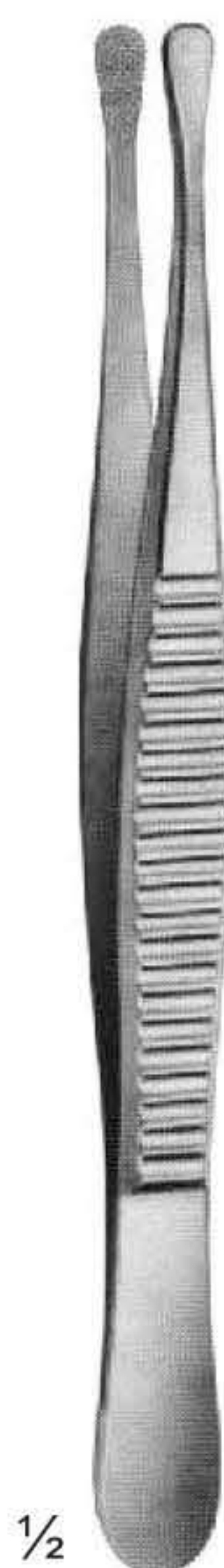

UG-1150
WANGENSTEEN
150 mm

230 mm



UG-1152
WANGENSTEEN
150 mm

230 mm

Organ - Tissue Grasping, Dissecting & Intestinal Forceps

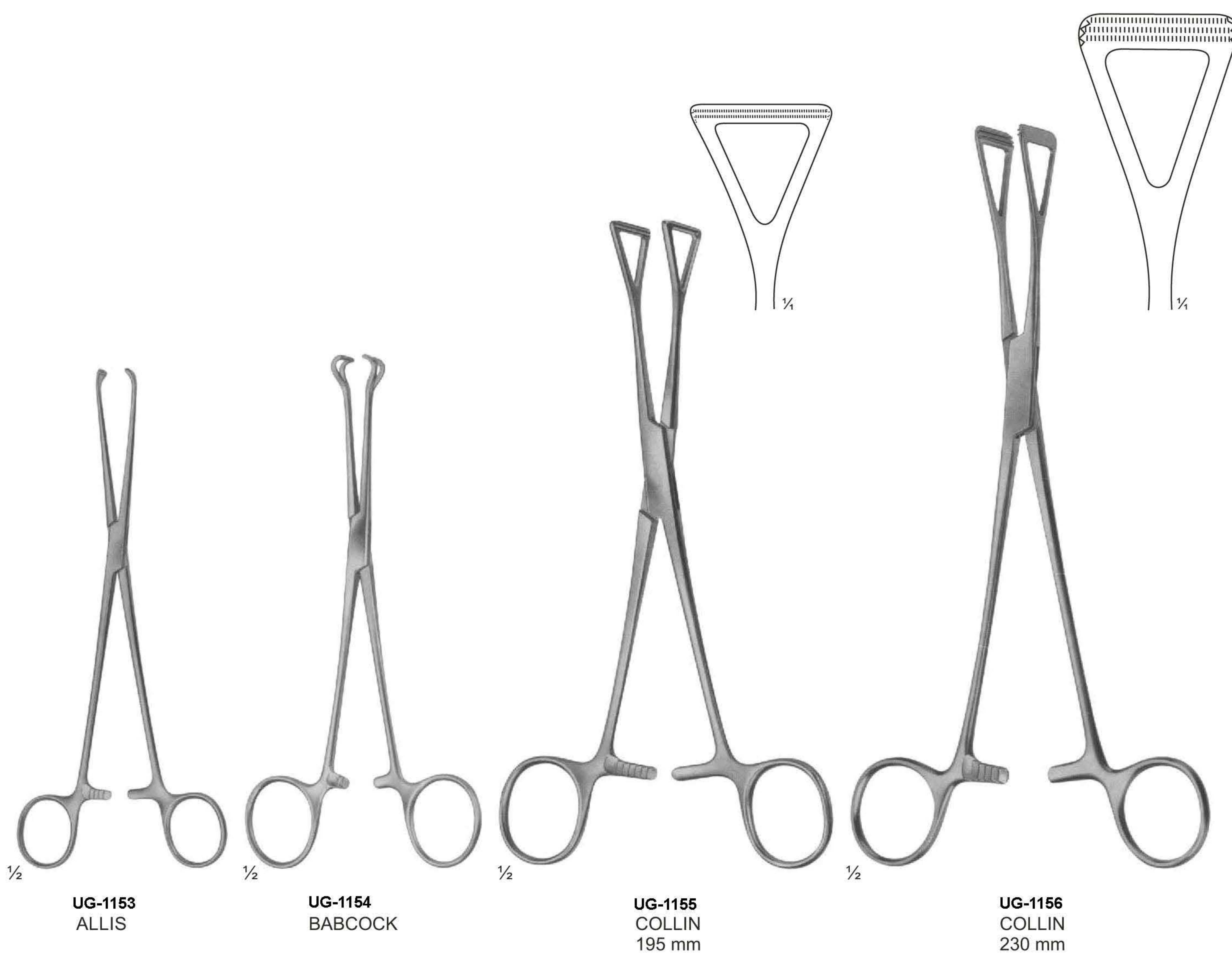

Ultra - Light - Forceps, Dissecting Forceps



1/2

UG-1157 150 mm
200 mm
240 mm
300 mm

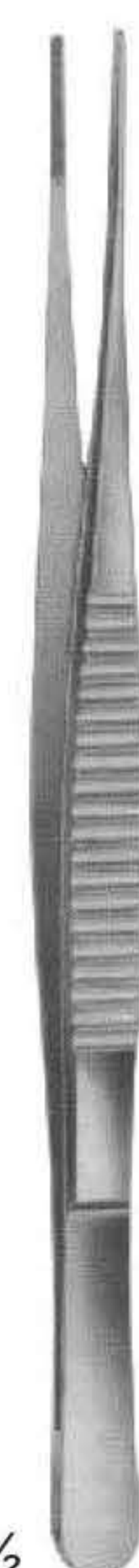

1/2

DE BAKEY
UG-1158 150 mm
200 mm
240 mm
300 mm



1/2

DE BAKEY
UG-1159 150 mm
200 mm
240 mm
300 mm



1/2

DE BAKEY
UG-1160 200 mm
240 mm
300 mm

Intestinal Clamps for Children



UG-1161
BAINBRIDGE
155 mm



UG-1162
ALLEN
155 mm



UG-1165
BABY-KOCHER
very elastic blades
130 mm

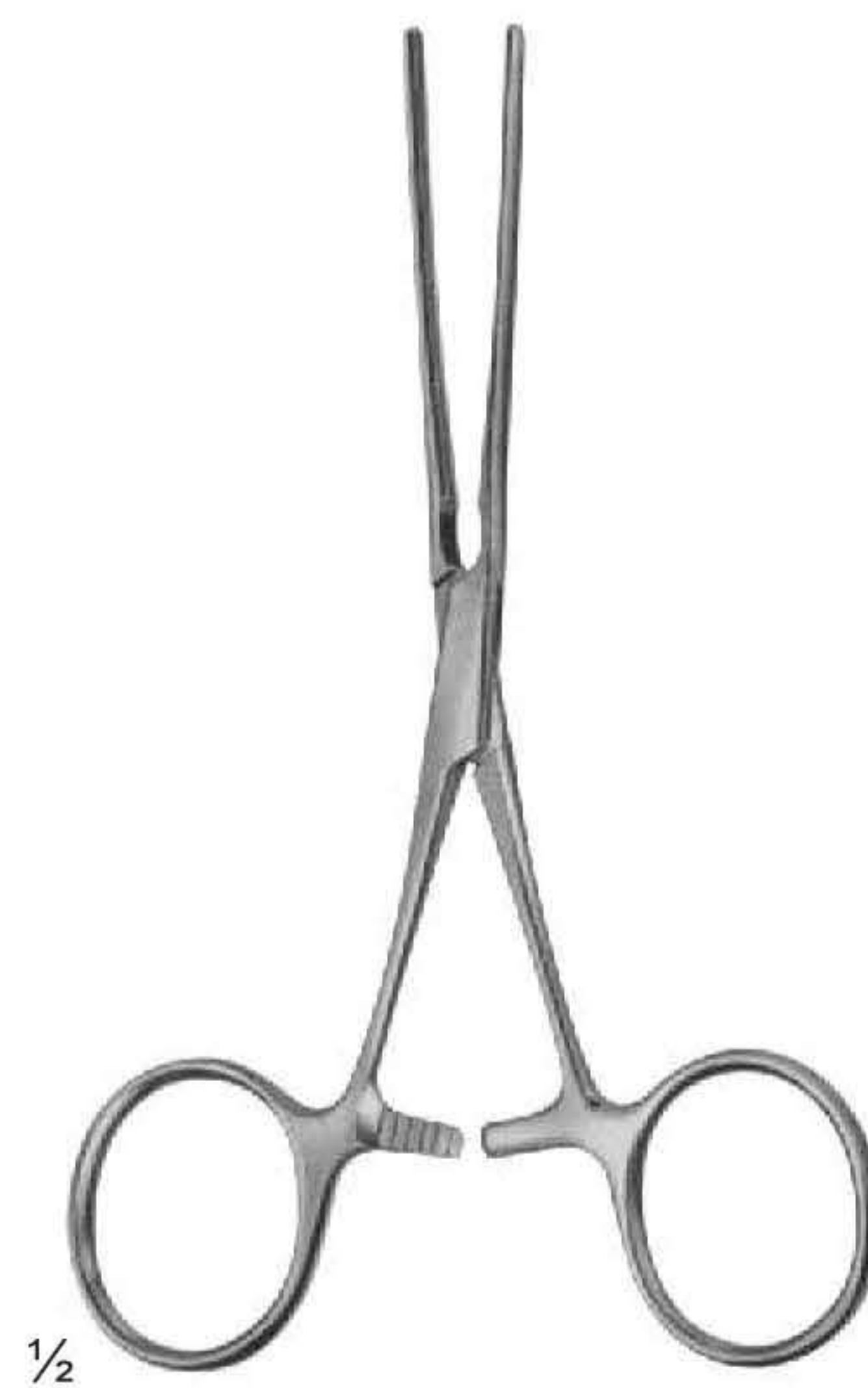

UG-1167
BABY-KOCHER
with elastic blades
130 mm

Intestinal Clamps, Soft Elastic



1/2

UG-1169
DOYEN
elastic
165 mm



1/2

UG-1171
DOYEN
with elastic blades
170 mm



1/2

UG-1172
HARTMANN
with elastic blades
200 mm



1/2

UG-1174
HARTMANN
with elastic blades
200 mm

Intestinal Clamps, Soft elastic



UG-1175
KOCHER
with elastic blades
210 mm
230 mm



UG-1178
DOYEN
with elastic blades
210 mm

Intestinal Clamps, Soft elastic



$\frac{1}{2}$ **UG-1179**
DOYEN
with elastic blades
235 mm

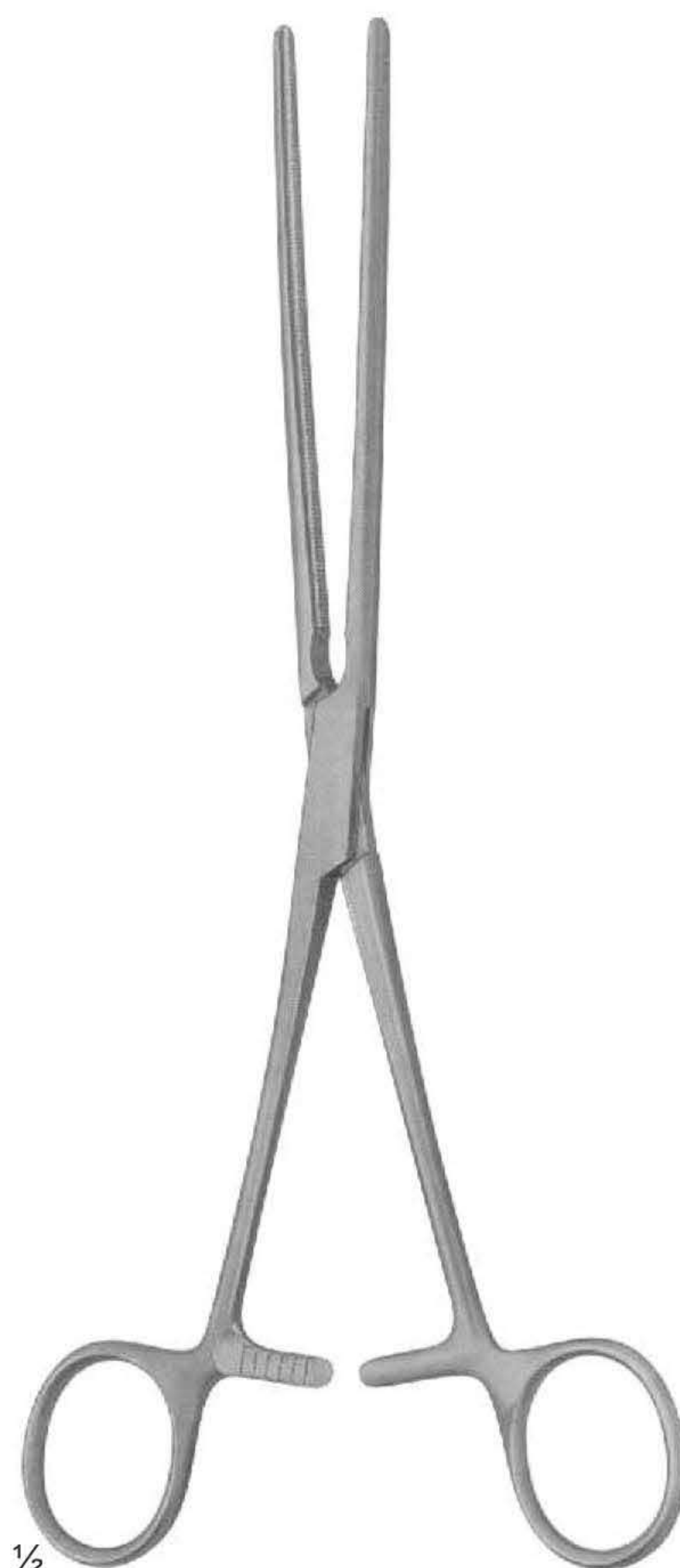

$\frac{1}{2}$ **UG-1182**
DOYEN
with elastic blades
230 mm

Intestinal Clamps, Soft elastic



1/2

UG-1183
KOCHER
with very elastic blades

Intestinal Clamps, Soft elastic



$\frac{1}{2}$

UG-1184
KOCHER
with very elastic blades

Intestinal Clamps



UG-1189
NUSSBAUM
with elastic blades
250 mm

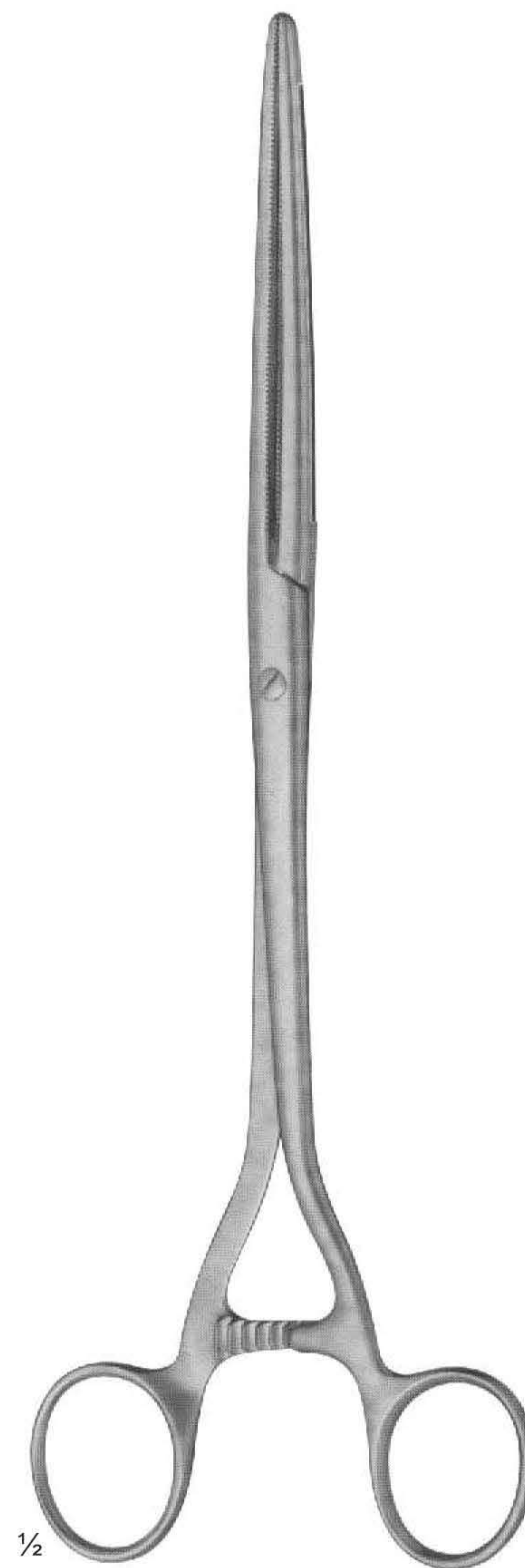

UG-1192
MOYNIHAN
280 mm

Scalpels, Dura Knives & Comedone Extractors



UG-194
JOSEPH
SIZE:125mm

Double Edged
Nasal Knives, Pointed

1/4

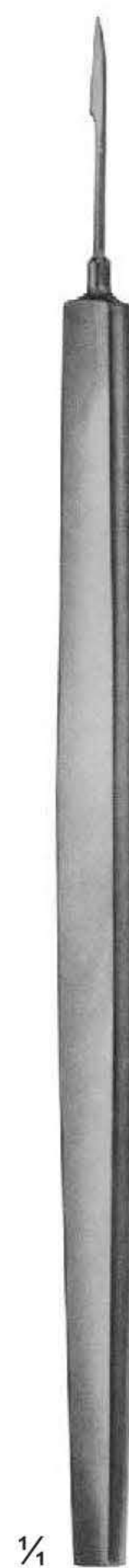

UG-196
ZIEGLER

1/4



UG-200
VIDAL
Lupus Scraper

1/2

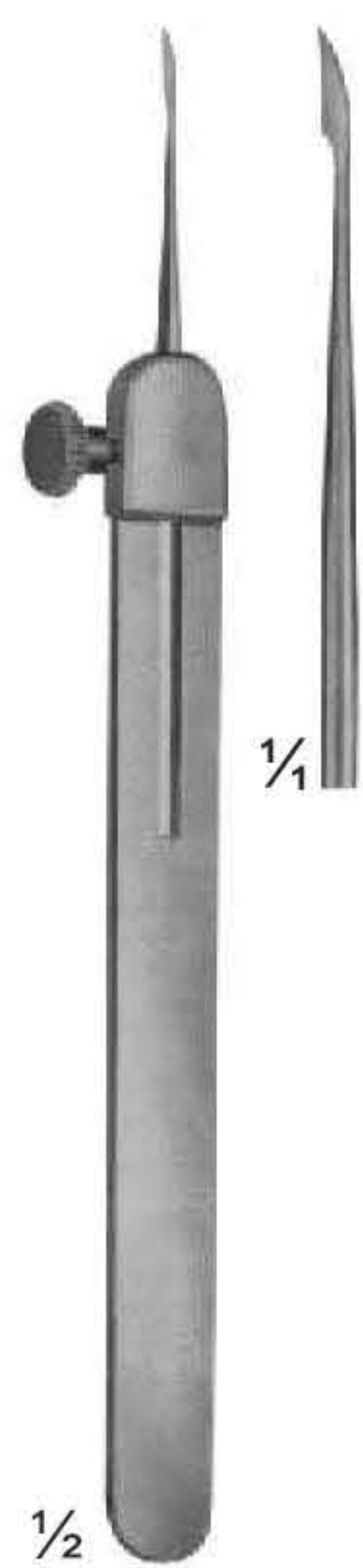

UG-201
MONCORPS
Milium Knives
SIZE:130mm

1/2



UG-202
SAALFELD
SIZE:195mm

1/2



UG-203
HEBRA
Size: Metal
handle"

1/2



UG-205
Scalpels, Dura
Knives &
Comedone Ex-
tractors

1/2



UG-206
UNNA
SIZE:235mm

1/2

Intestinal Clamps



$\frac{1}{2}$ **UG-1196**
MAYO-ROBSON
hard elastic
250 mm

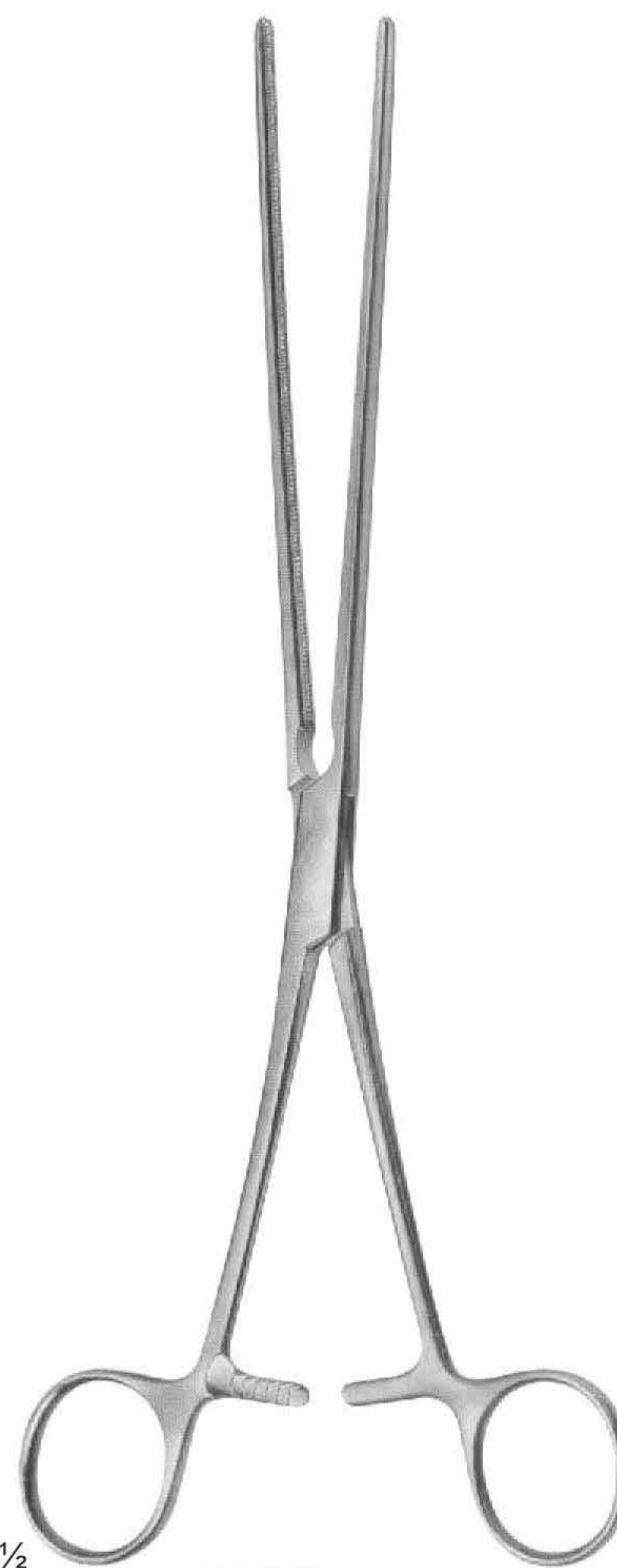

$\frac{1}{2}$ **UG-1199**
MAYO-ROBSON
250 mm

Gastro-Intestinal Forceps, twin



UG-1205
LANE
300 mm

UG-1207
LANE
300 mm

Stomach Clamps



$\frac{1}{2}$
UG-1215
SCUDDER
330 mm



$\frac{1}{2}$
UG-1218
KLEINSCHMIDT
Spur crushers and
Appendectomy clamps
130 mm

Intestinal and Pylorus Clamps



UG-1221
PAYR
Intestinal clamp
light pattern,
for children
180 mm

UG-1223
PAYR
200 mm

UG-1224
PAYR
275 mm

UG-1226
PAYR
Pylorus clamp
315 mm

Anastomosis Forceps



UG-1231
PARKER-KERR
anastomosis forceps
for colon resection
180 mm

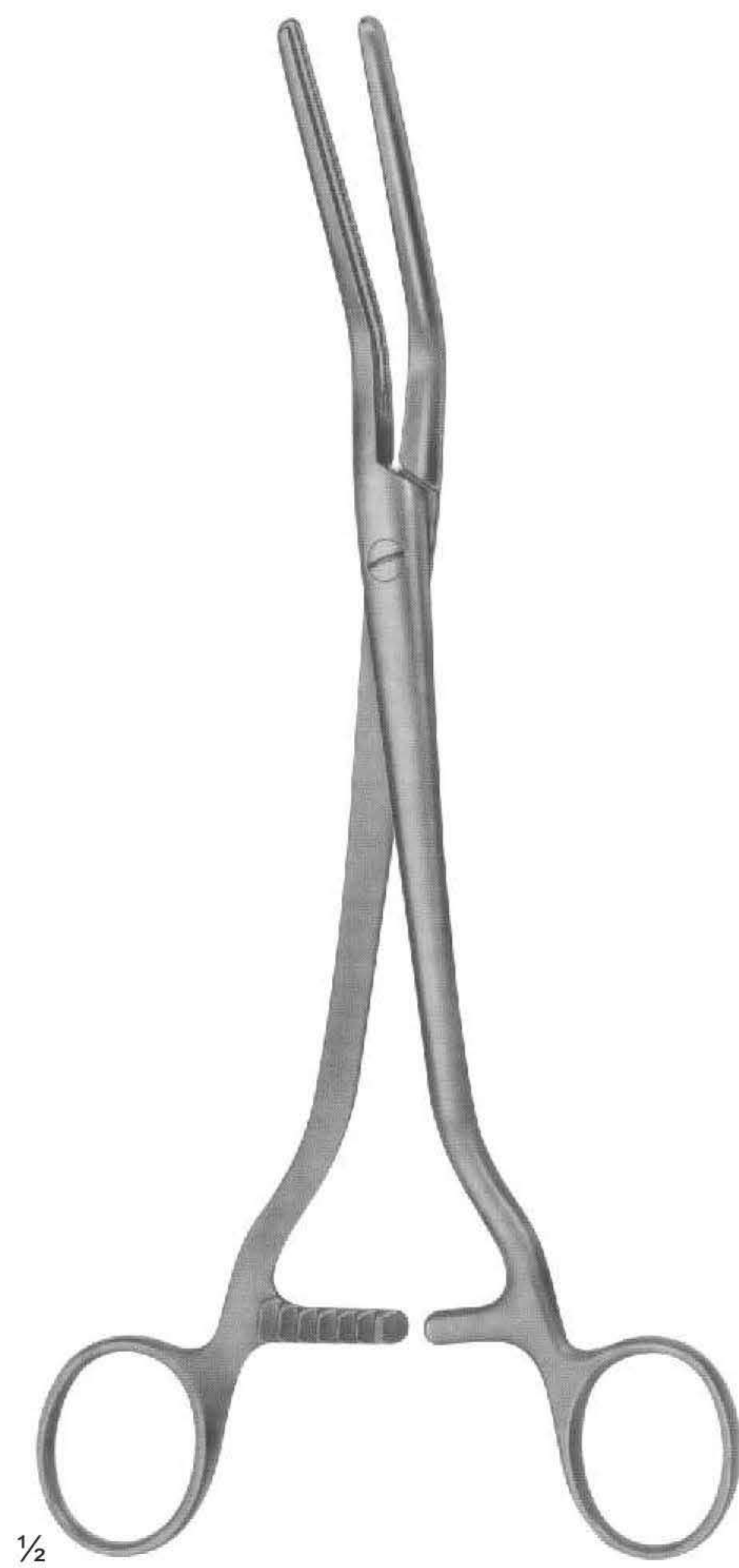

UG-1232
DICK
pressure clamps
180 mm

Sigmoid Anastomosis Forceps



UG-1262
230 mm



UG-1263
LLOYD-DAVIS
315 mm

Sigmoid Anastomosis Forceps

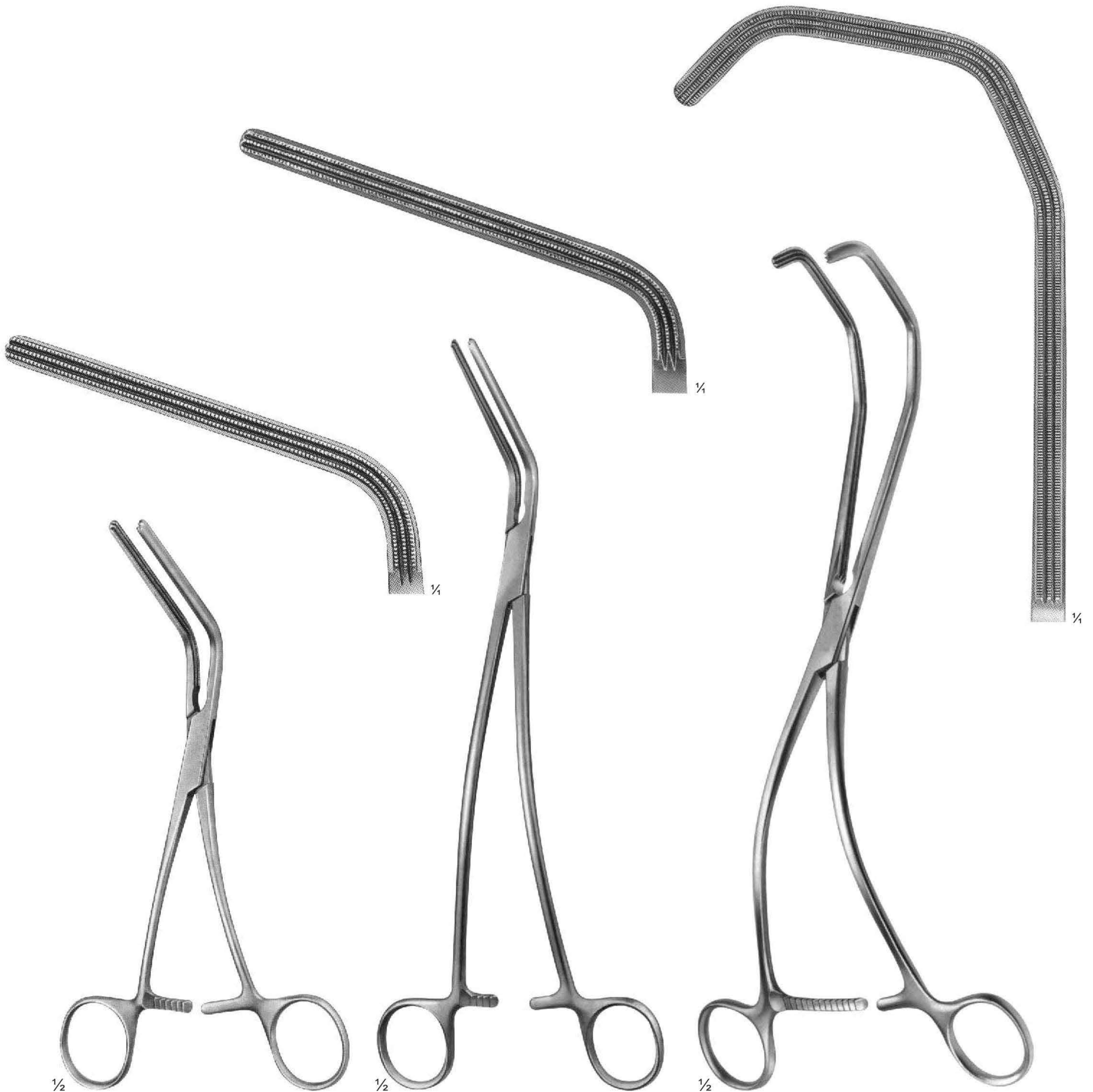

UG-1264
MORRIS
175 mm

UG-1265
DE BAKEY
(MORRIS modif.)
240 mm

UG-1266
KERSTING
270 mm

Rectal Specula

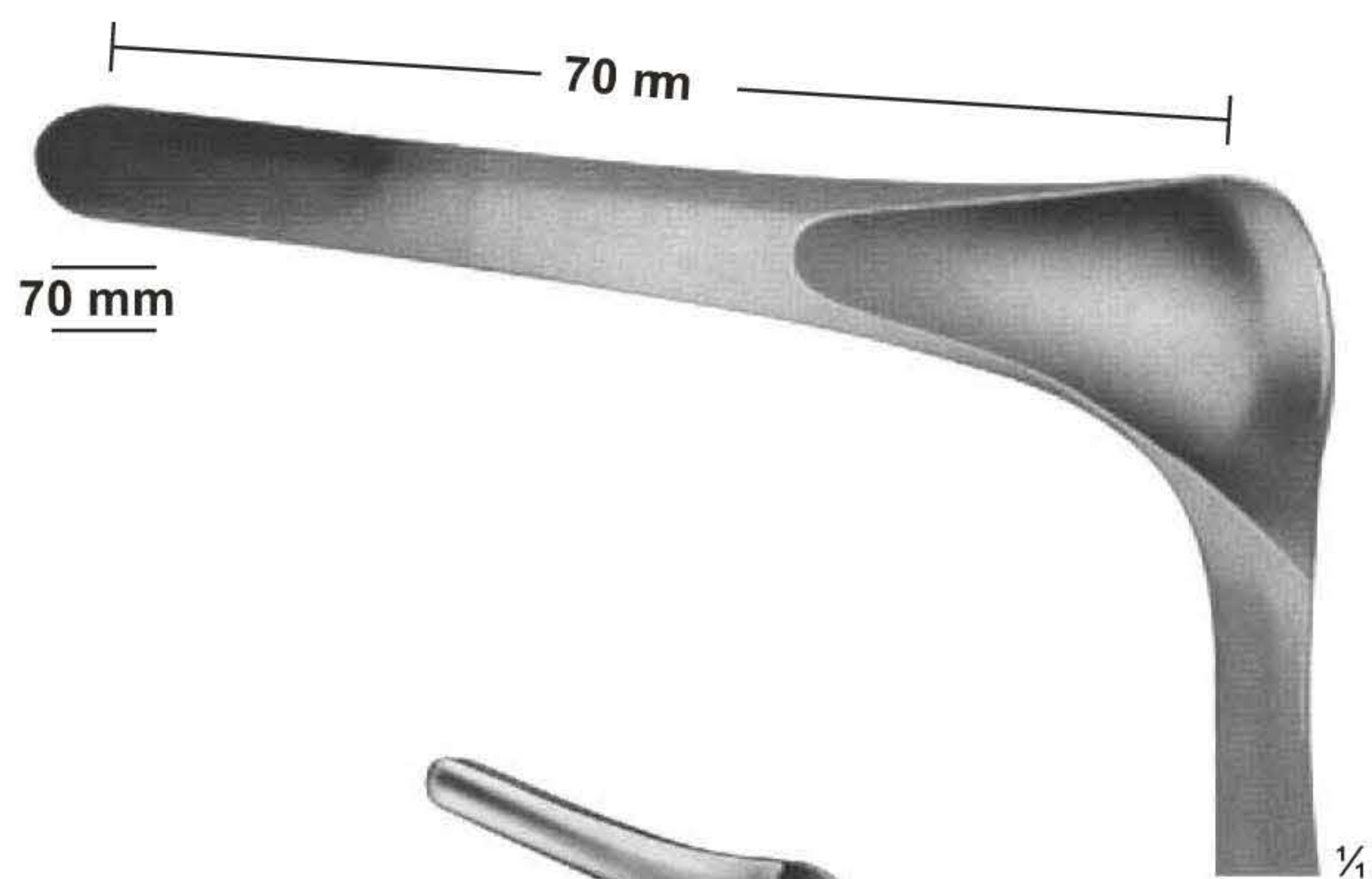

UG-1267
KILLIAN
for children
145 mm



UG-1268
SIMS
160 mm



UG-1269
SIMS
160 mm

Rectal Specula

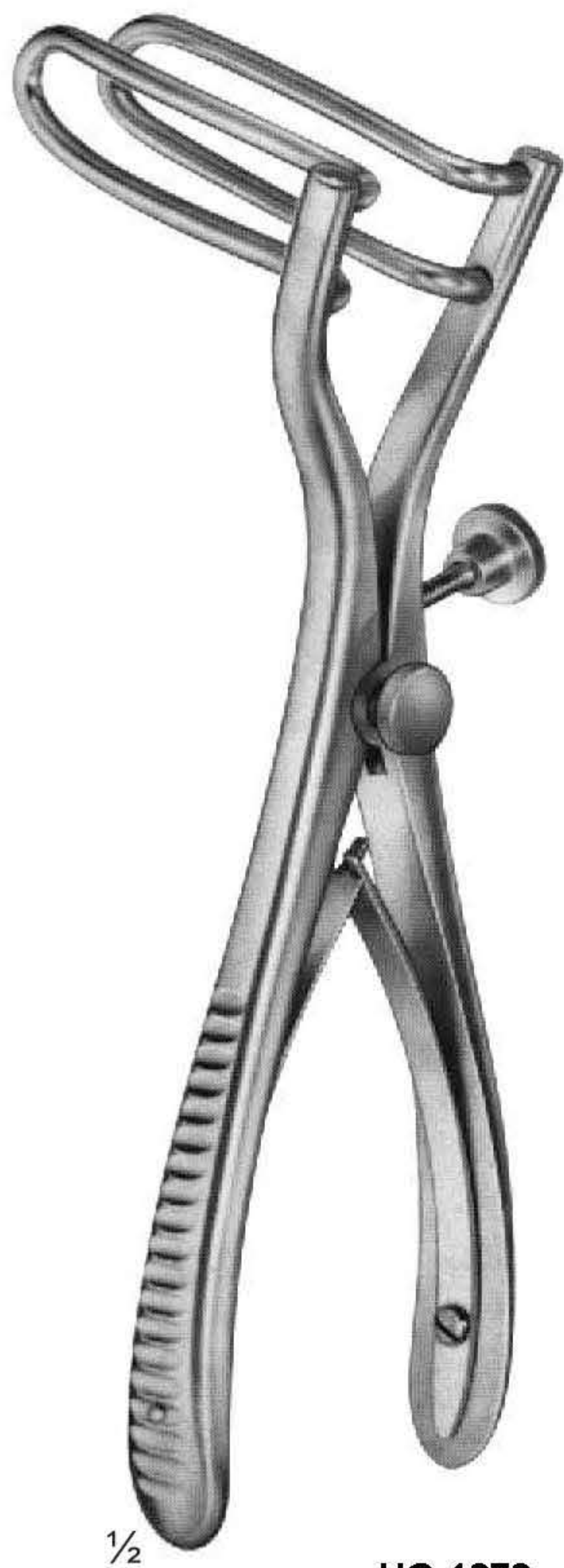

1/2

UG-1272



25 mm

80 mm

1/2

UG-1277
PRATT
205 mm

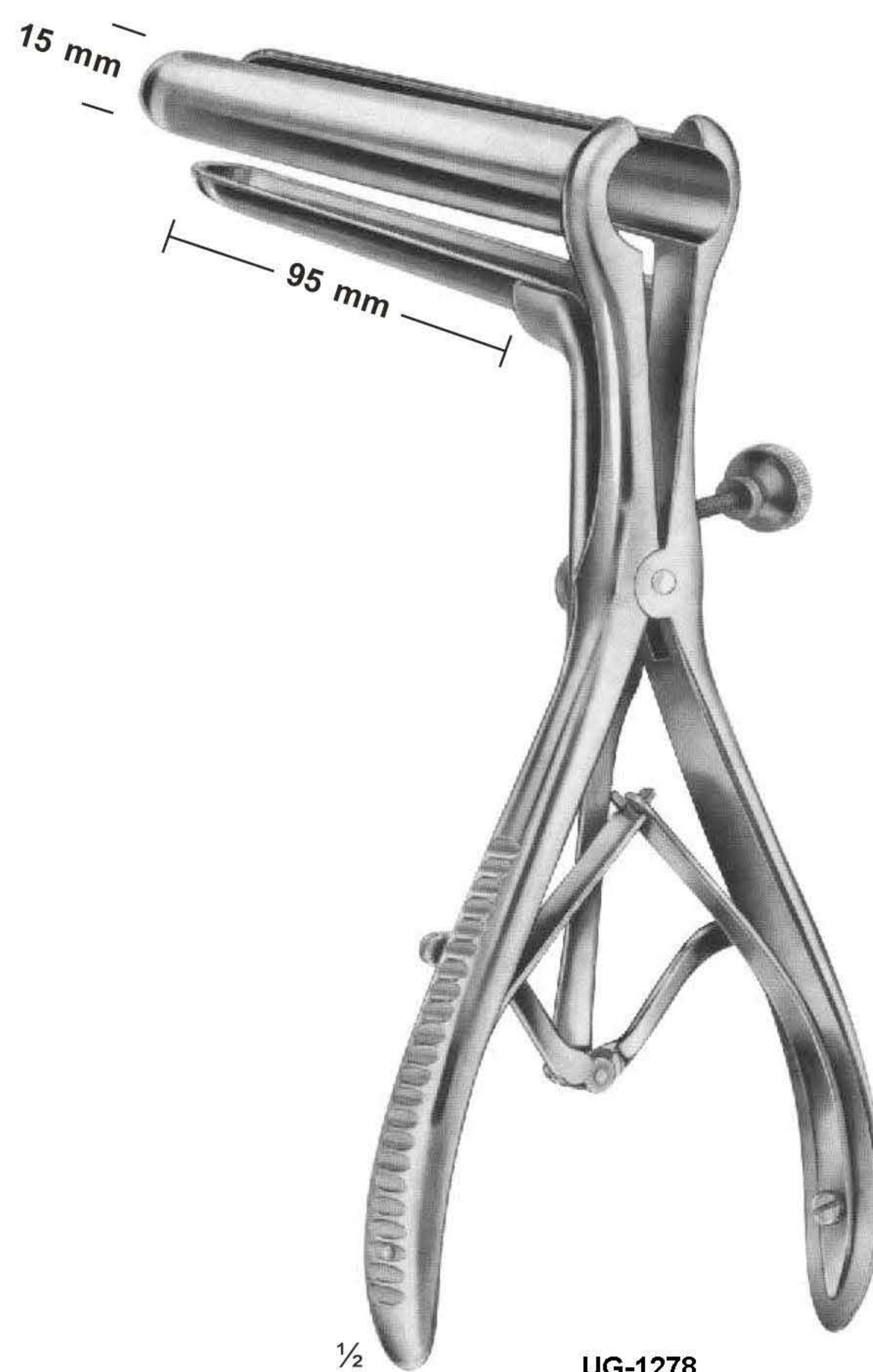

15 mm

95 mm

1/2

UG-1278
MATHIEU
215 mm

Anusscopes-Sphincteroscopes



UG-1280
IVES-FANSLER
Anuscope
145 mm

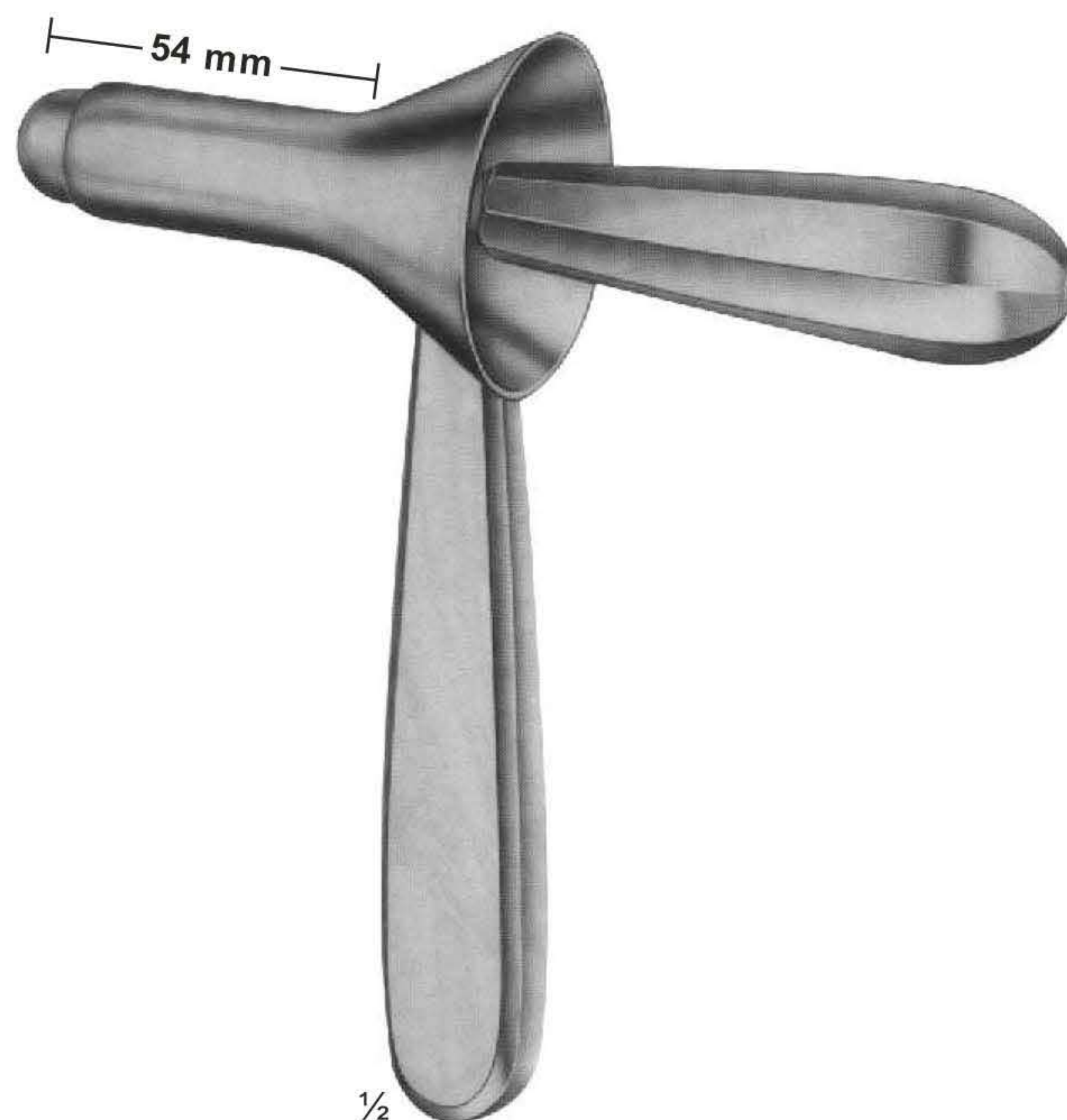

UG-1282
KELLY
Sphincteroscope
160 mm

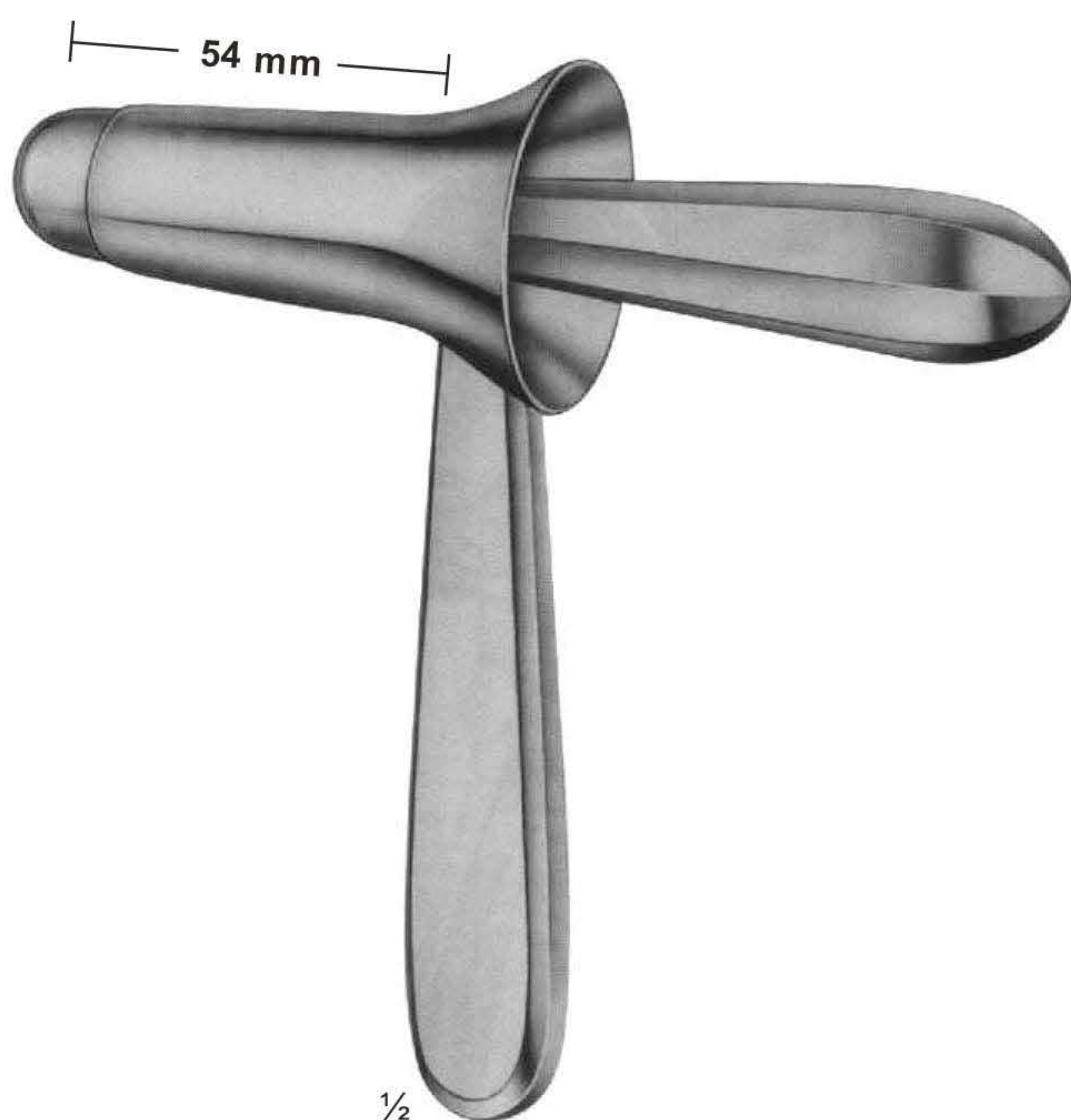

UG-1284
KELLY
Sphincteroscope
160 mm

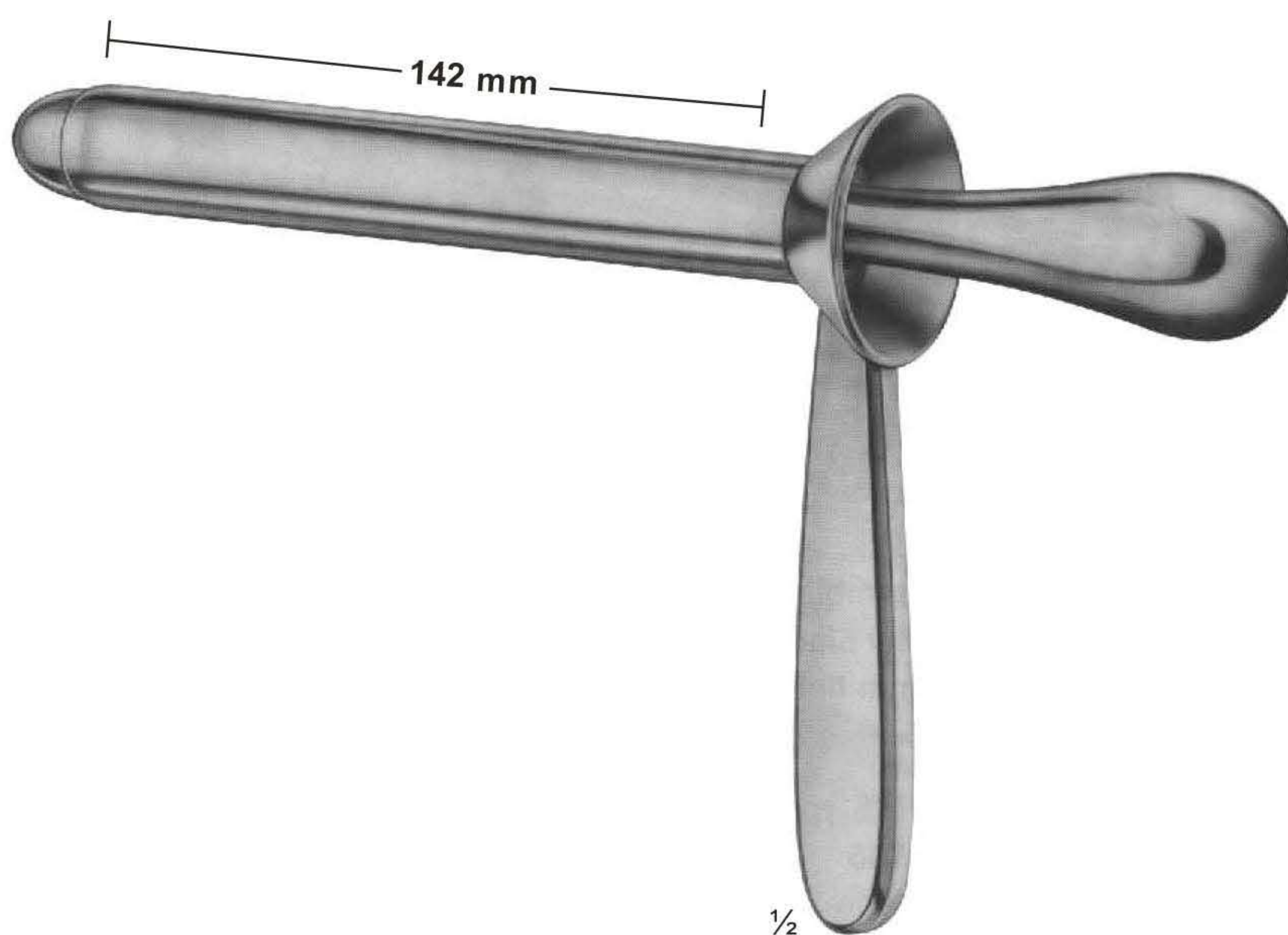

UG-1285
KELLY
Proctoscope
160 mm

Razor Blade Holders & Breakers



UG-207
TROUTMAN-CHRIS
SIZE:150mm

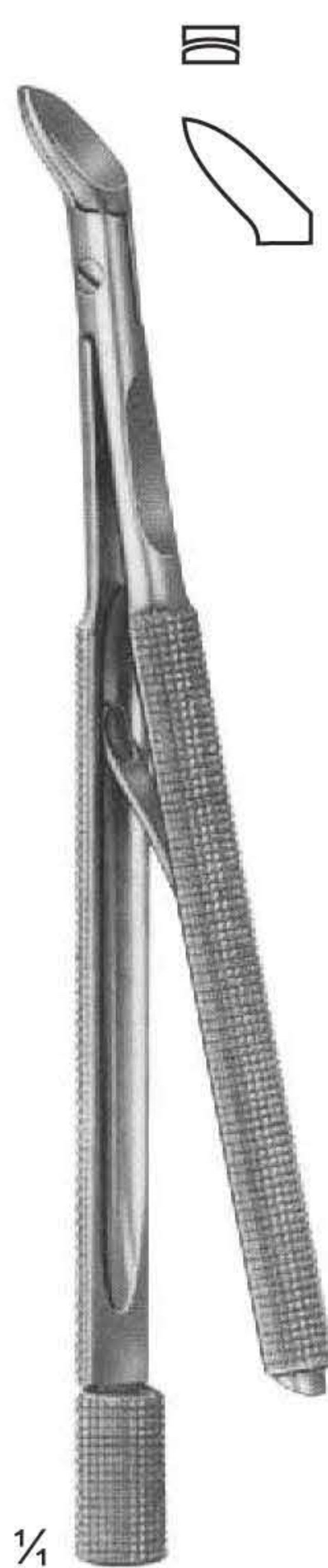

UG-209
TROUTMAN-CHRIS
SIZE:200mm



UG-210
SIZE:230mm

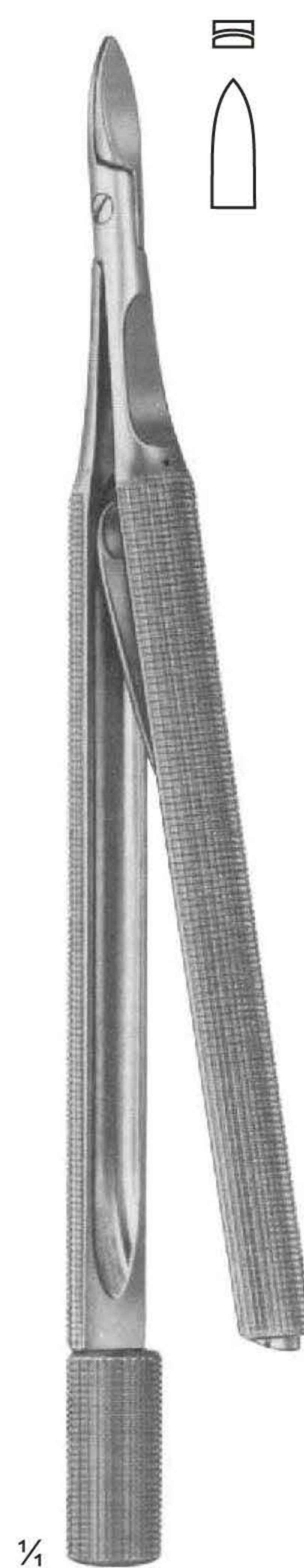

UG-212
CASTROVIEJO
SIZE:300mm



UG-213
SIZE:270mm

Biopsy forceps for rectum

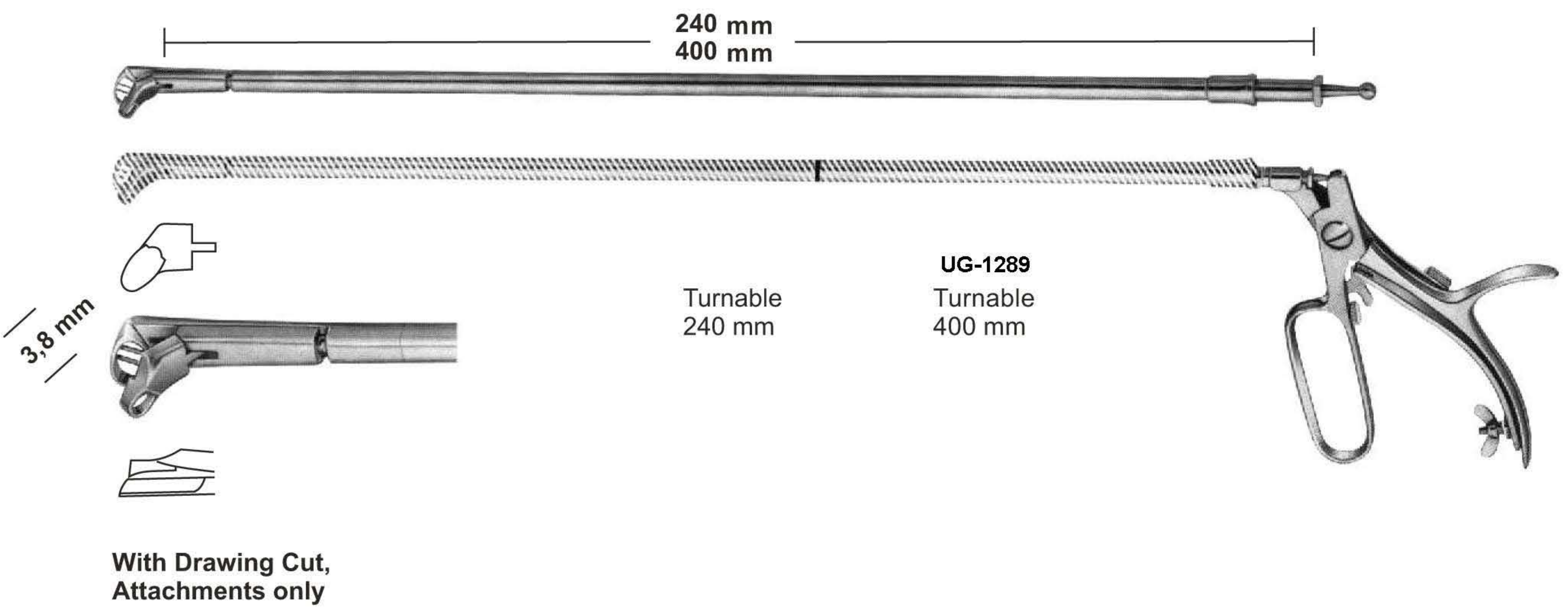
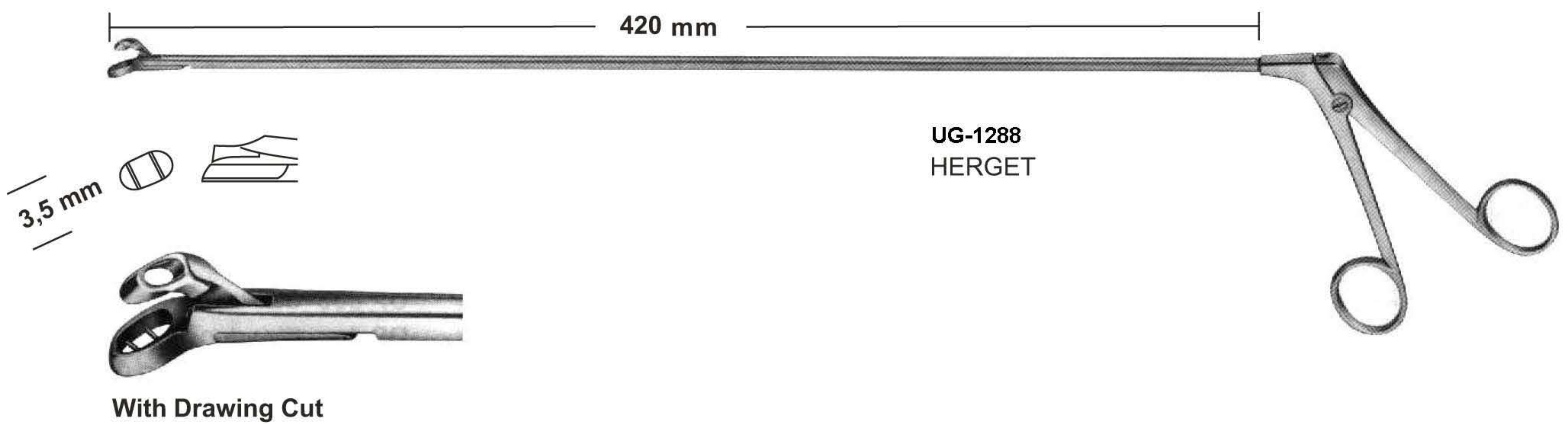
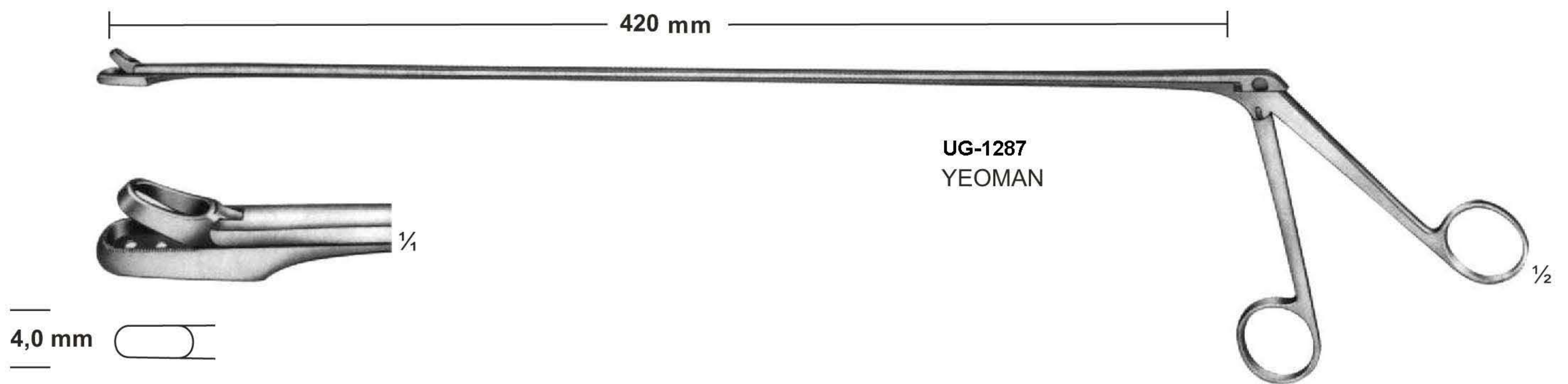
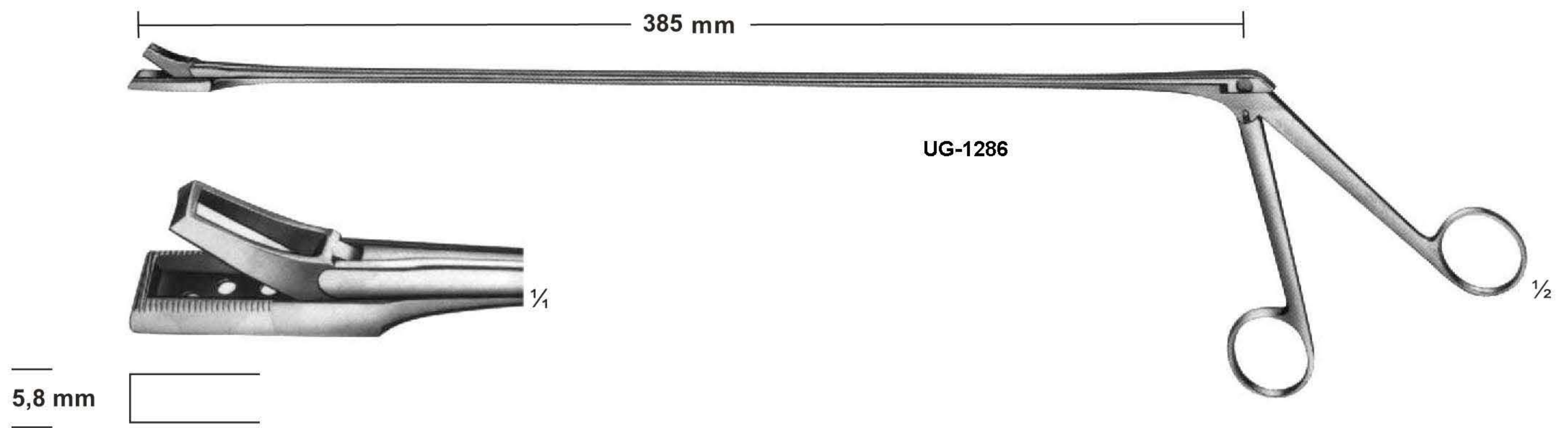

Biopsy Forceps & Swab Holders

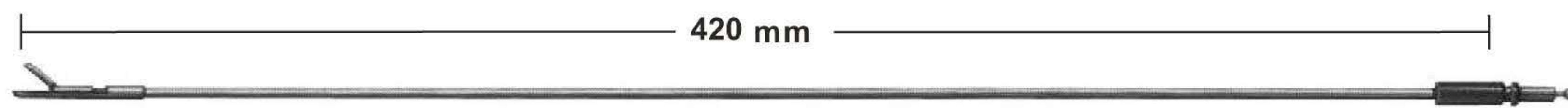

UG-1291
Handle for 119 - 120 - 121 - 122



UG-1292
Biopsy Forceps, spoon-shaped
oval jaws, straight.

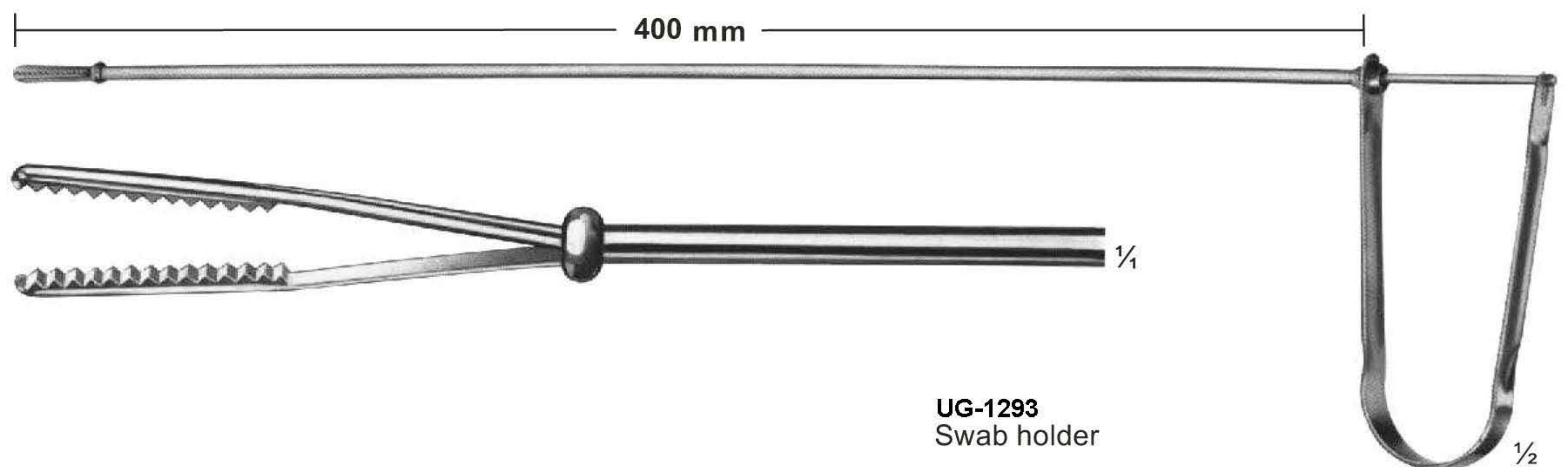

UG-1293
Swab holder

Haemorrhoidal Forceps

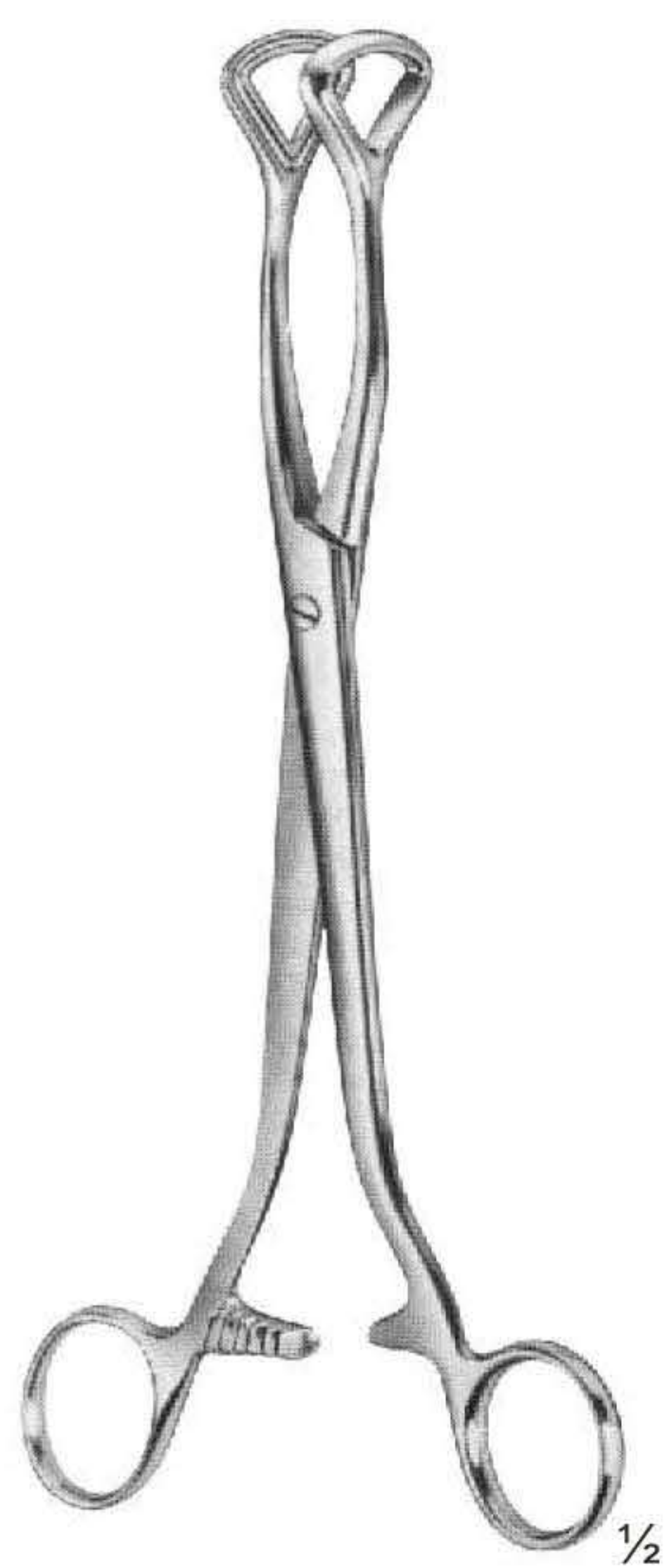

UG-1294
LUER

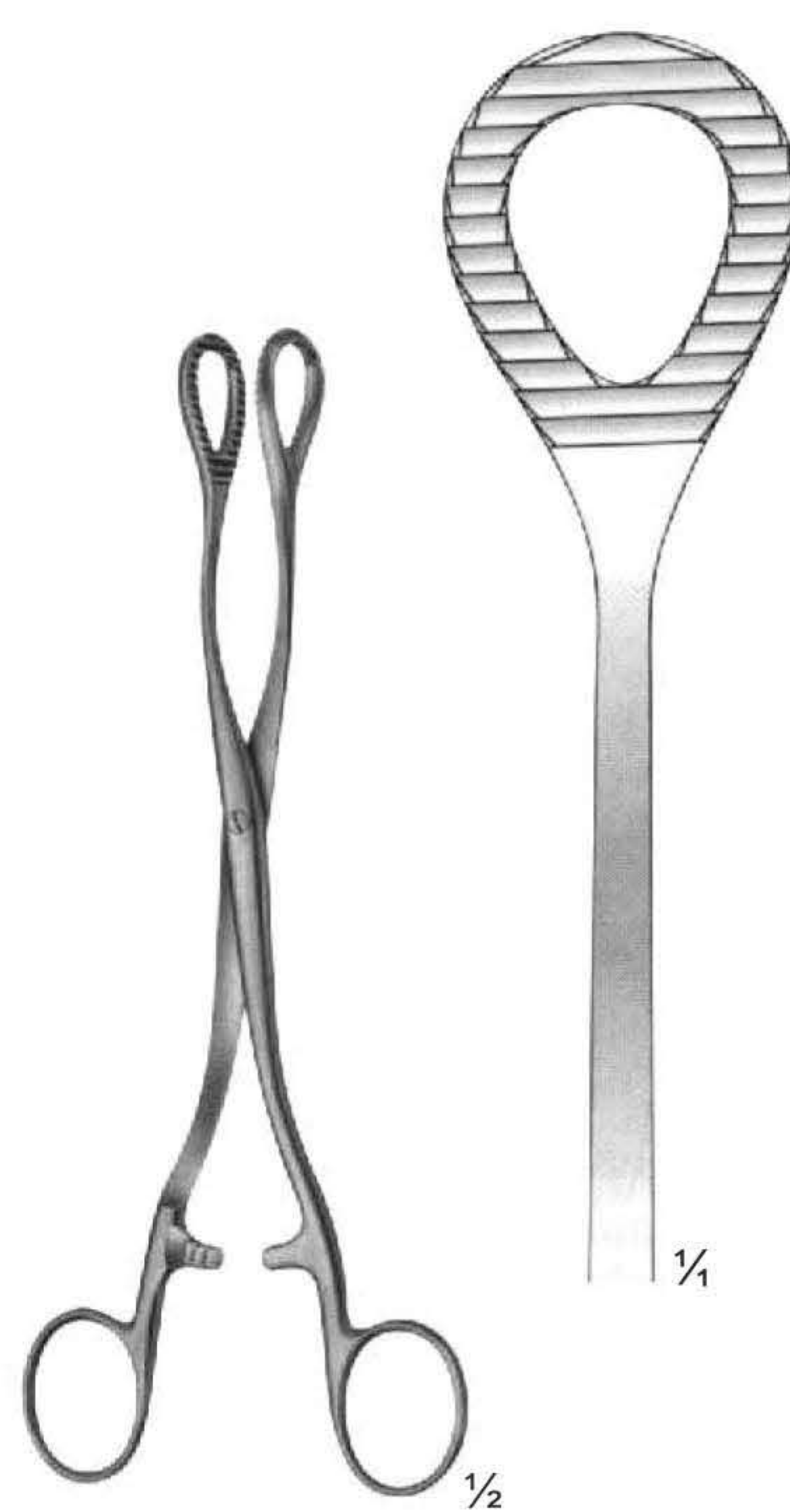

UG-1295
HEYWOOD-SMITH
200 mm



UG-1296
HEYWOOD-SMITH
modif
200 mm

Haemorrhoidal Forceps



UG-1300
250 mm
270 mm



UG-1303
FERGUSON
200 mm



UG-1304
RUDD
Haemorrhoidal ligator
with loading
attachment and 100
ligature rubber rings
315 mm

Gall Duct Forceps



UG-1007
LOWER
180 mm



UG-1009
LAHEY (SWEET)
190 mm

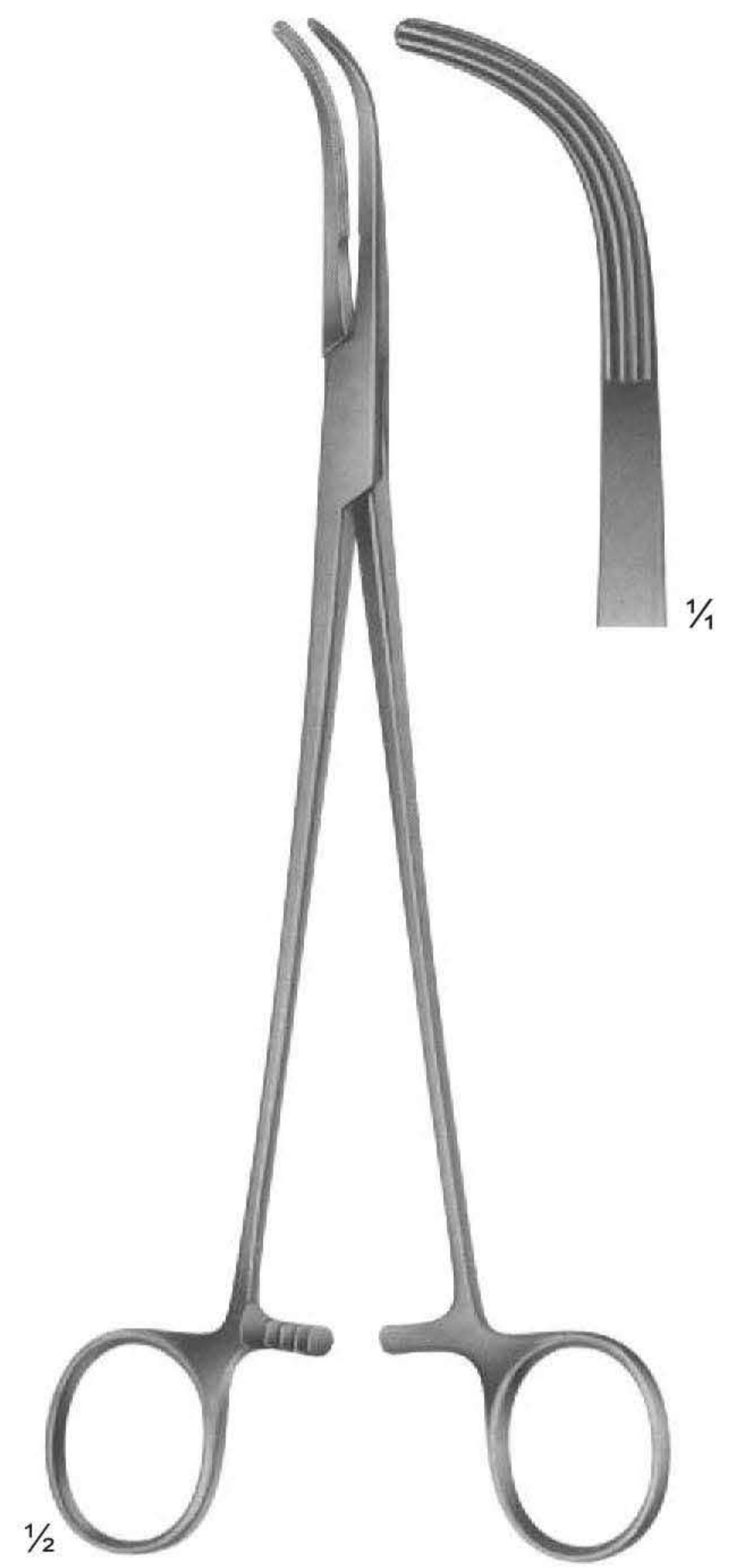

UG-1011
LAHEY
220 mm

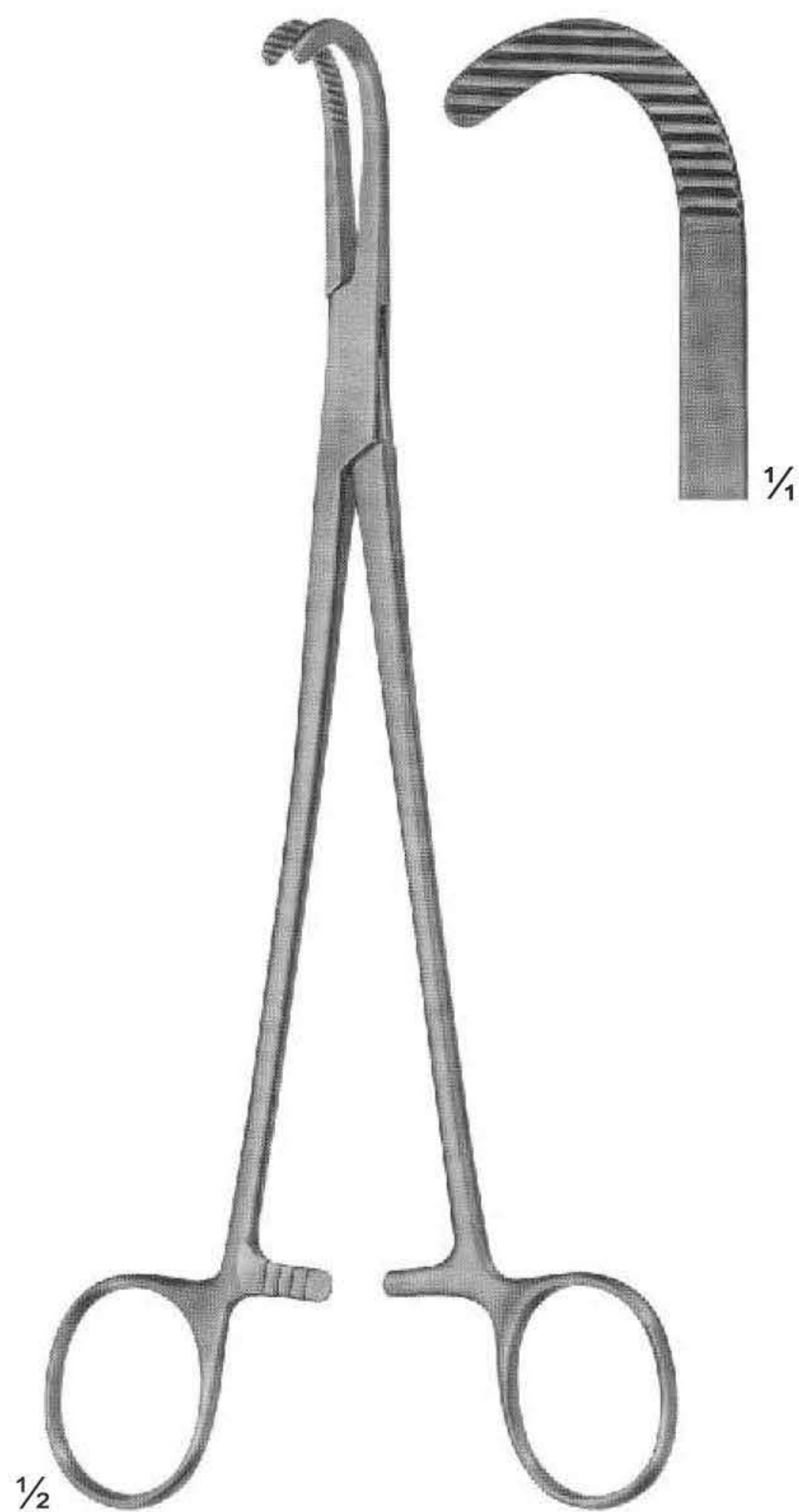

UG-1012
DESJARDINS
Gall duct-and cystic forceps
210 mm

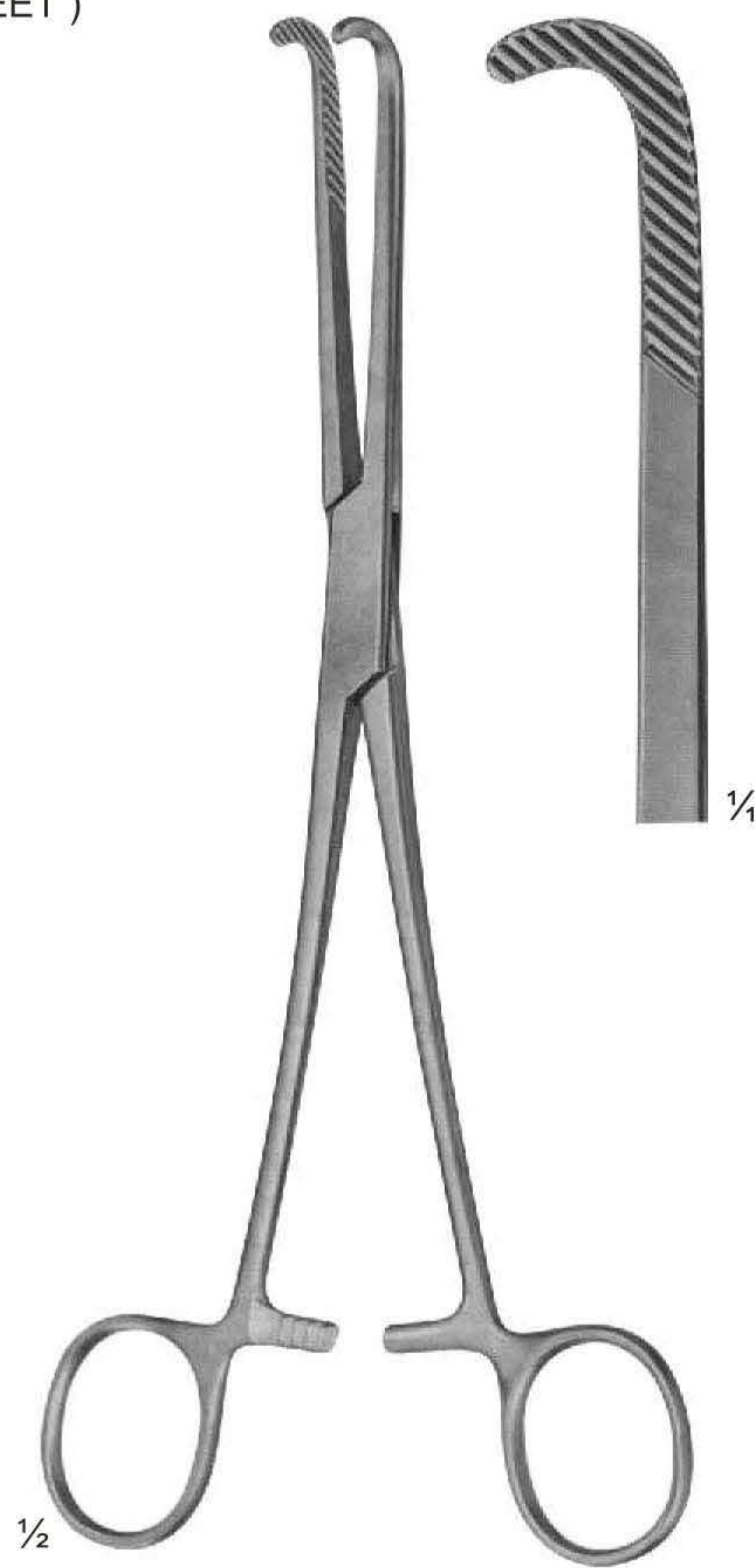

UG-1014
NISSEN
Gall duct-and cystic forceps
215 mm

Gall Duct Forceps and Choledochus Forceps



UG-1017
GRAY
180 mm



UG-1020
MIXTER
Gall duct-and cystic forceps
230 mm



UG-1022
FOERSTER-BALLENGER
240 mm

Gall Bladder Forceps and Gall Duct Scissors

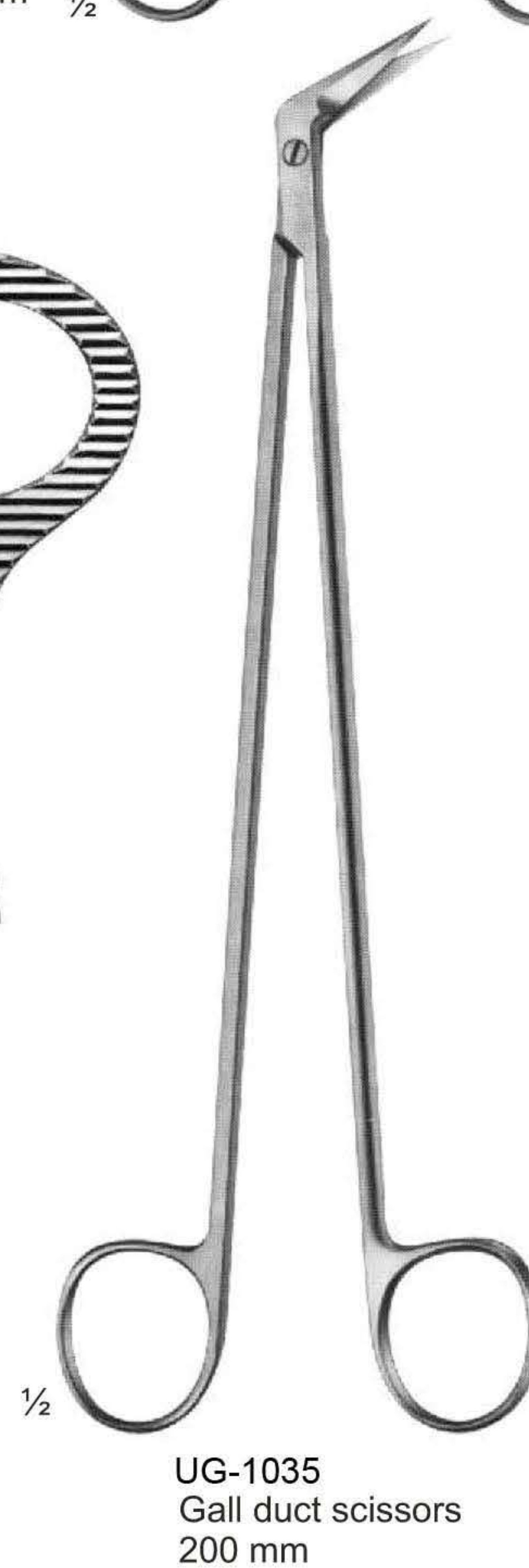
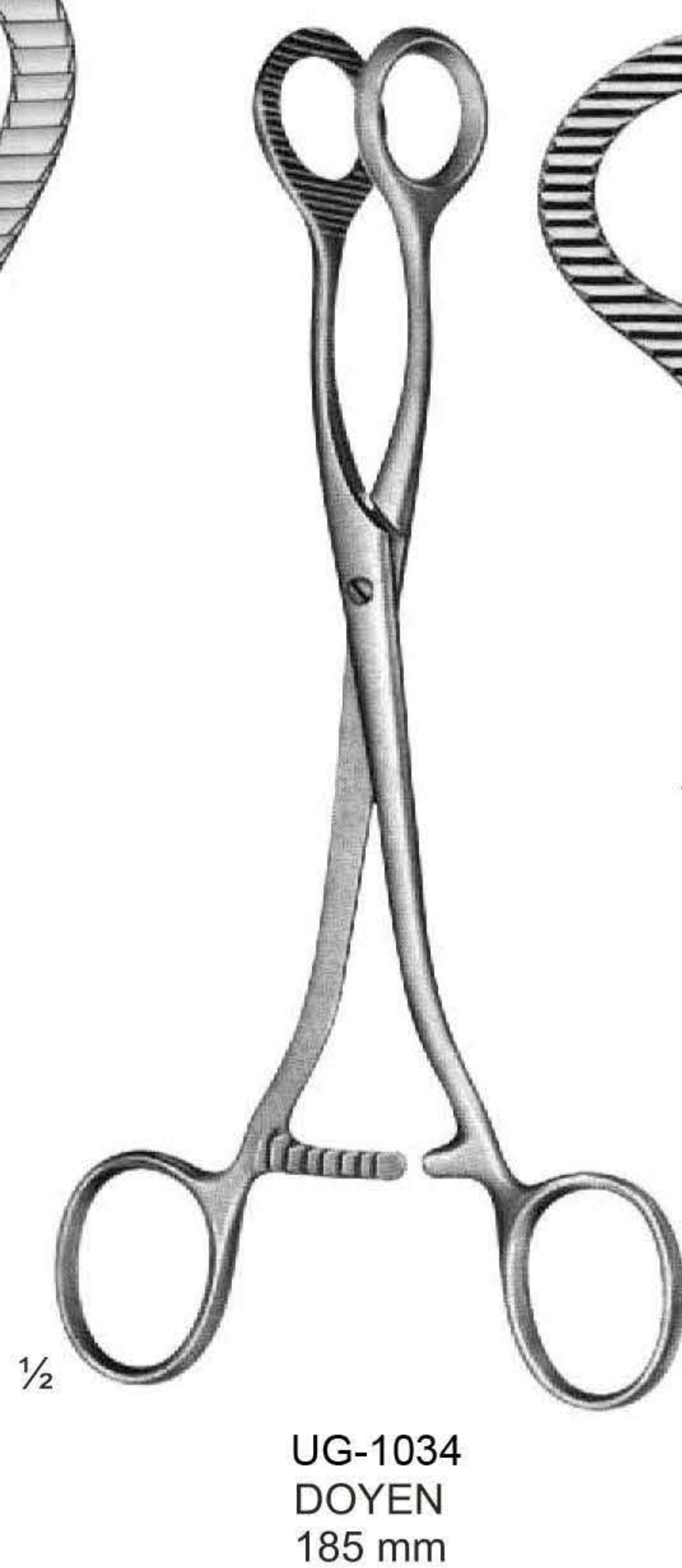
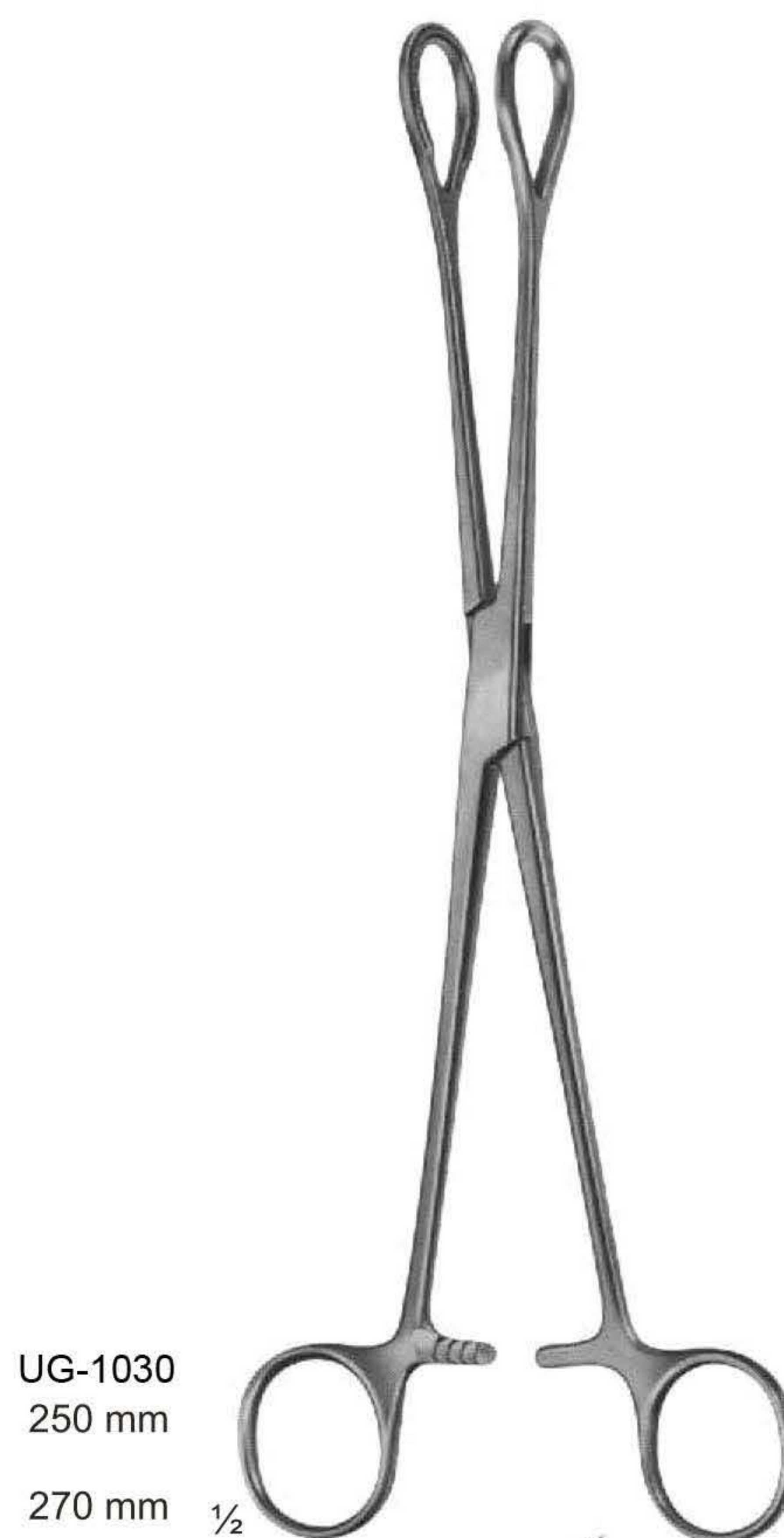
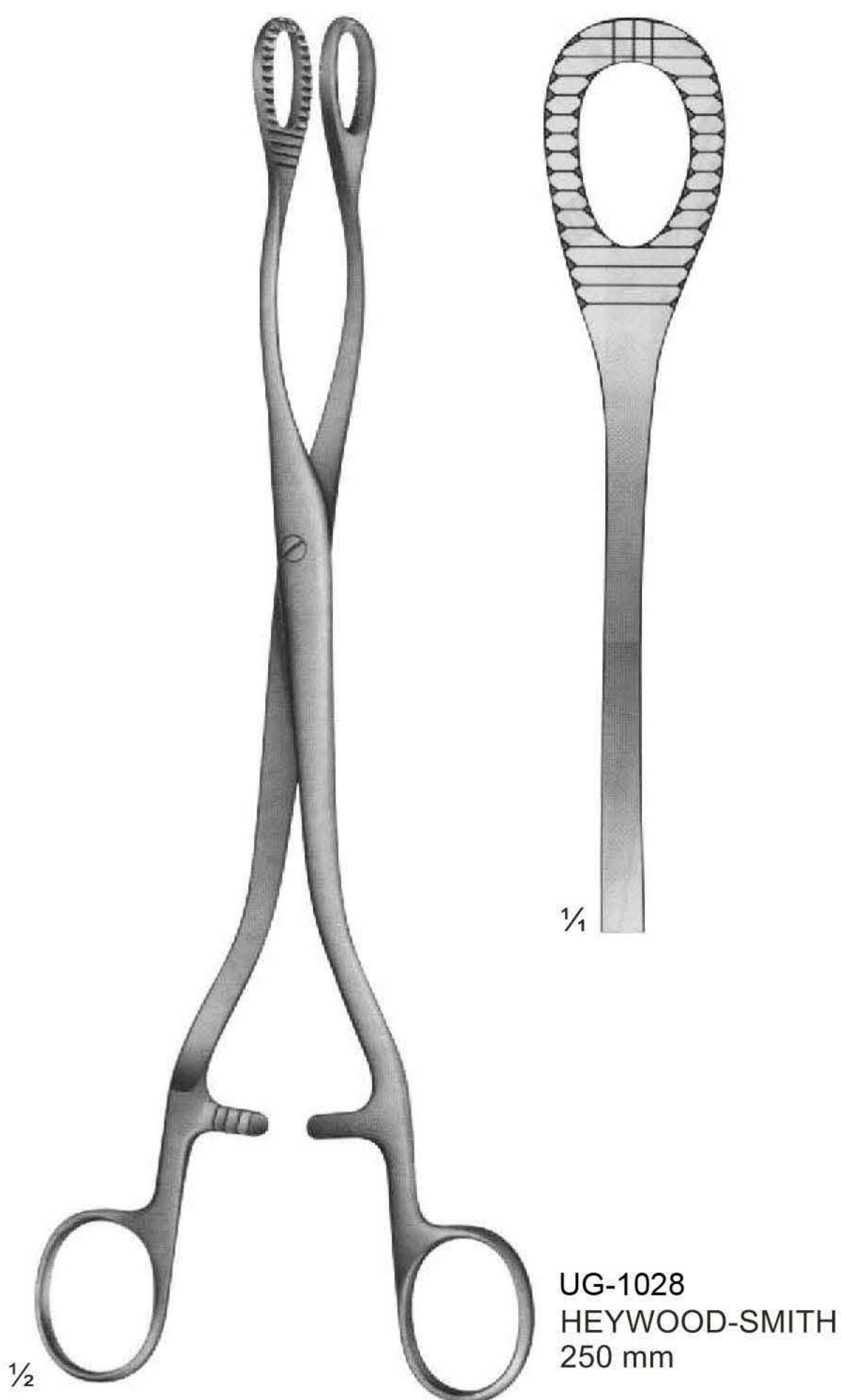

Gall Duct Probes

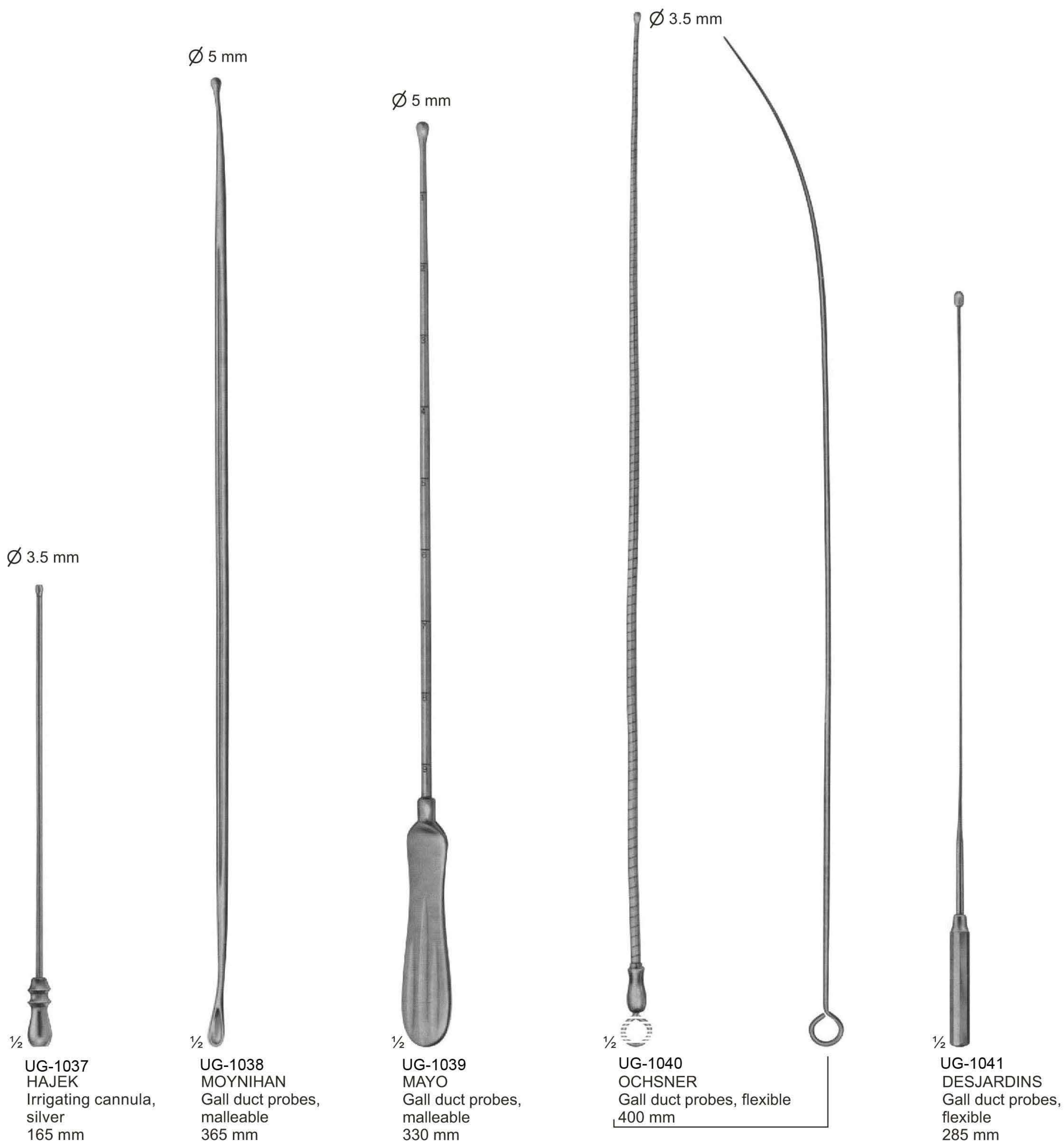

Gall Duct Dilators & Gall Stone Scoops



UG-1042
DITTEL
Metall bougies and
dilating sounds, stiff
345 mm



UG-1045
BAKES
Common bile duct
dilators, malleable
315 mm, 320 mm



UG-1053
DESJARDINS
Probes and catch
with flexible schaft
300 mm



UG-1061
LUER-KORTE modif
with malleable shaft
310 mm

Gall Stone Forceps

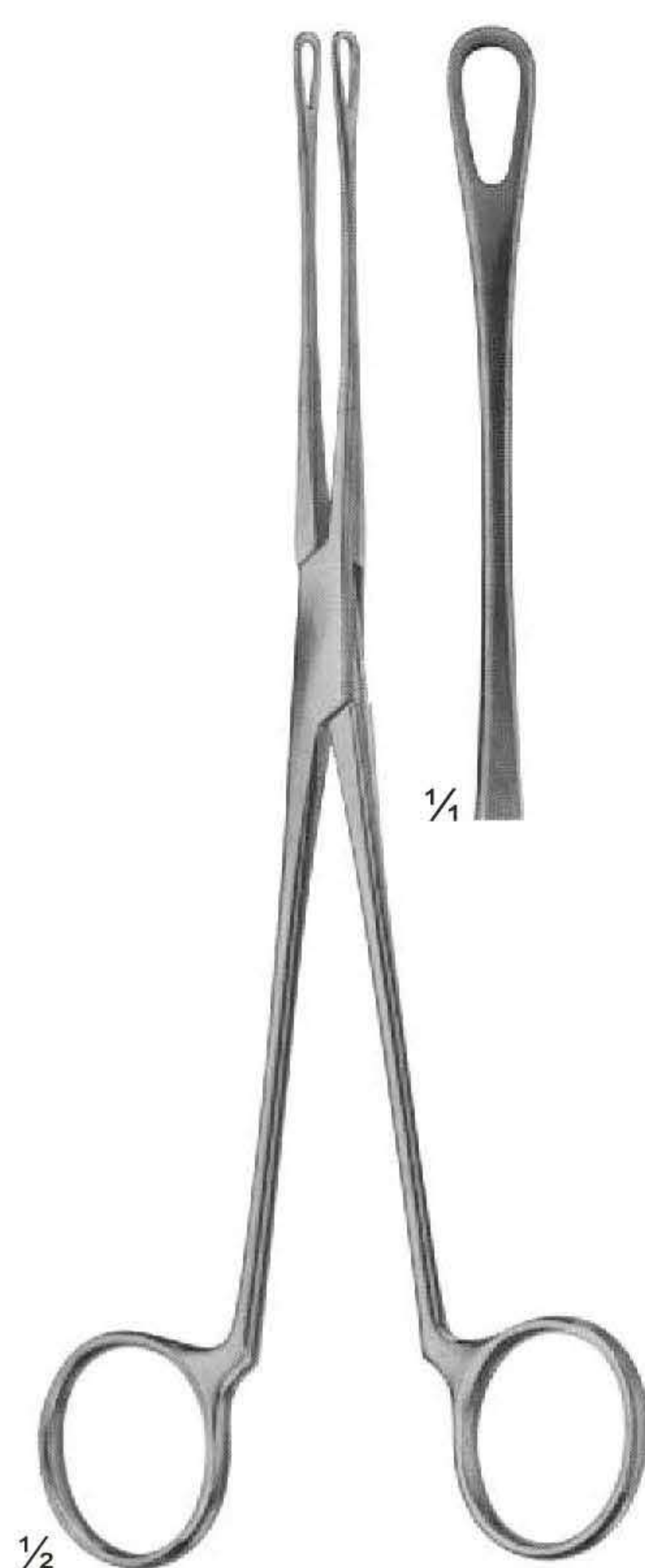

UG-1071
BLAKE
205 mm

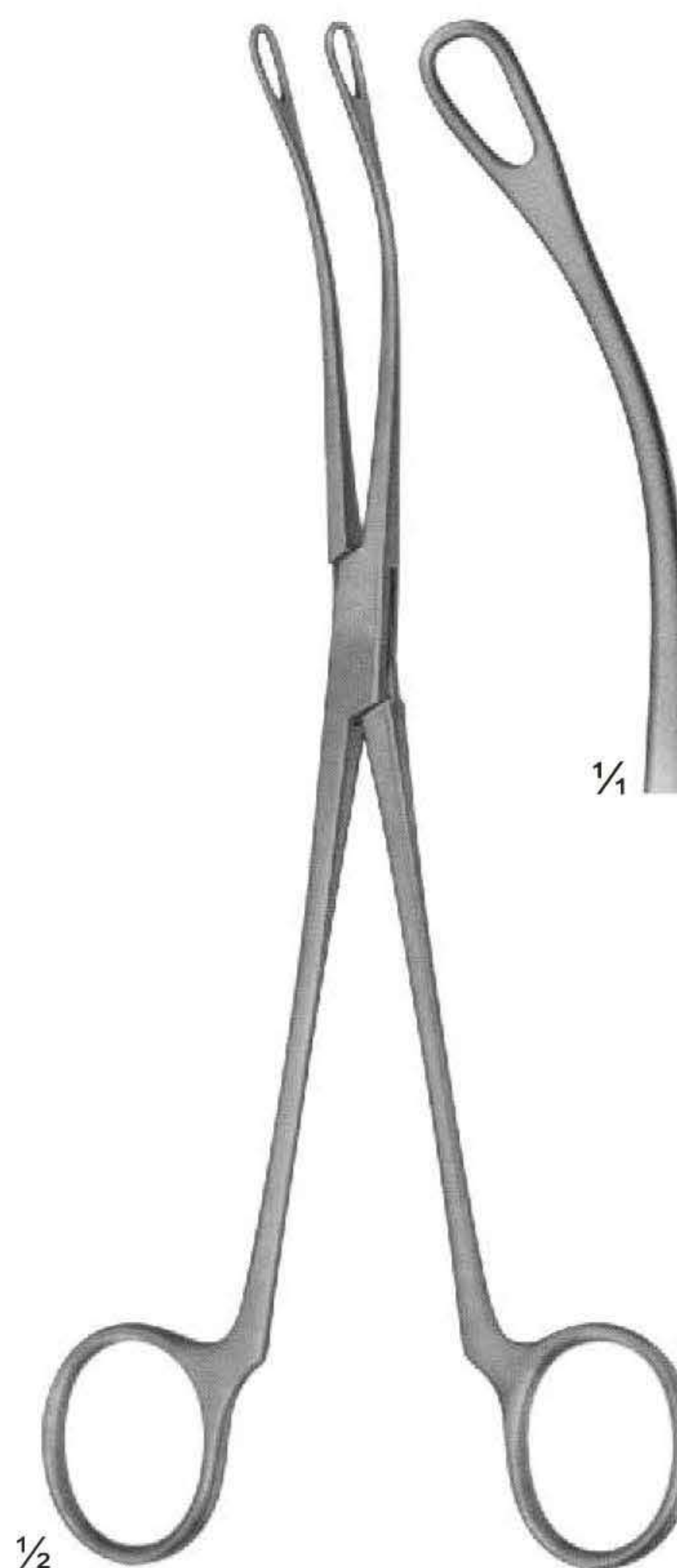

UG-1073
BLAKE
205 mm

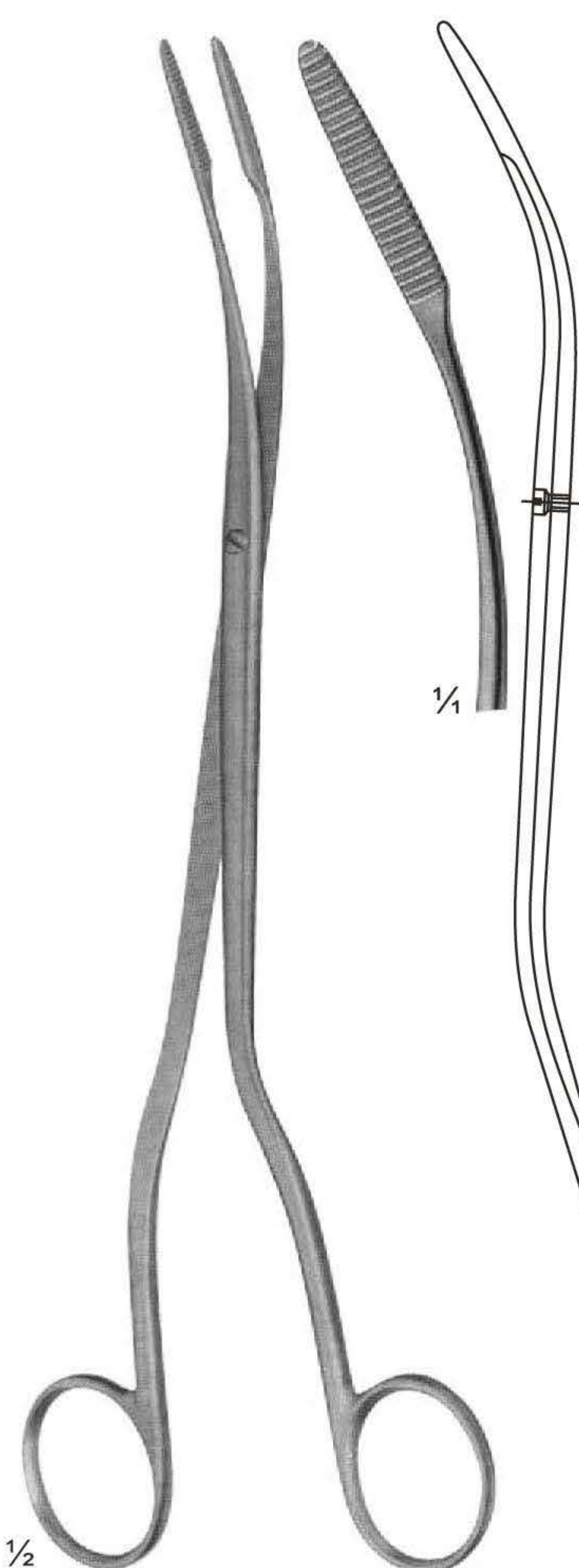

UG-1075
CZERNY
245 mm

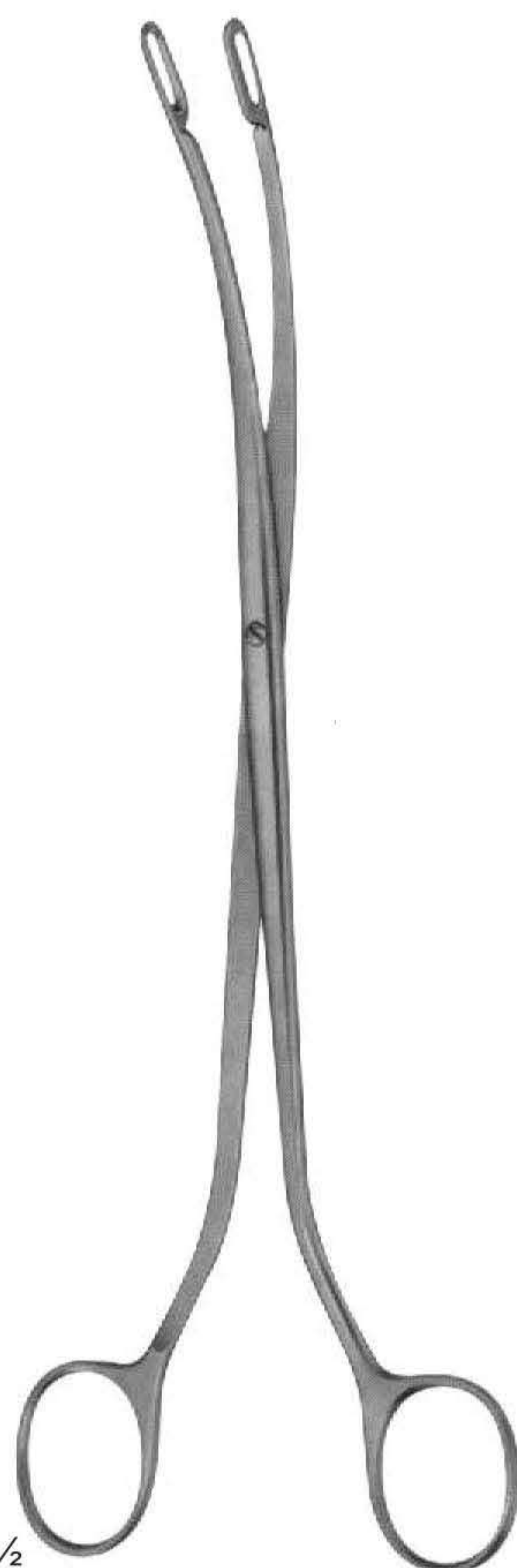

UG-1077
DESJARDINS
225 mm



UG-1078
DESJARDINS
Extremely delicate patterns

Scalpel Handles

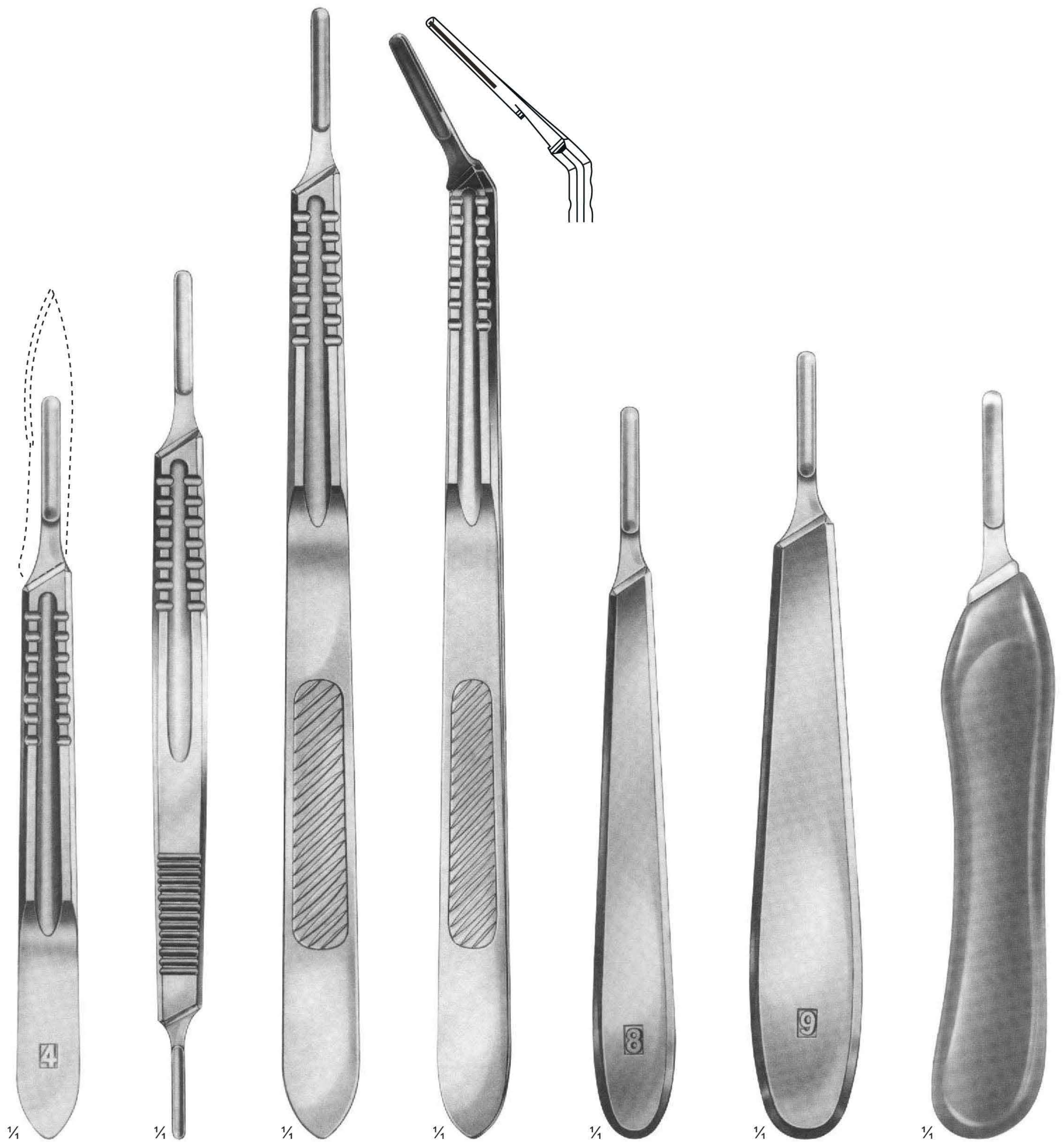

¼
UG-216
STANDARD
SIZE:130mm

¼
UG-218
Double Handel
SIZE:230mm

¼
UG-230
Straight
SIZE:200mm

¼
UG-221
SIZE:215mm
Scalpel
Handles

¼
UG-223
COLLIN
SIZE:145mm

¼
UG-224
COLLIN
SIZE:115mm

¼
UG-226
Plastic
SIZE:115mm

Scalpel Handles

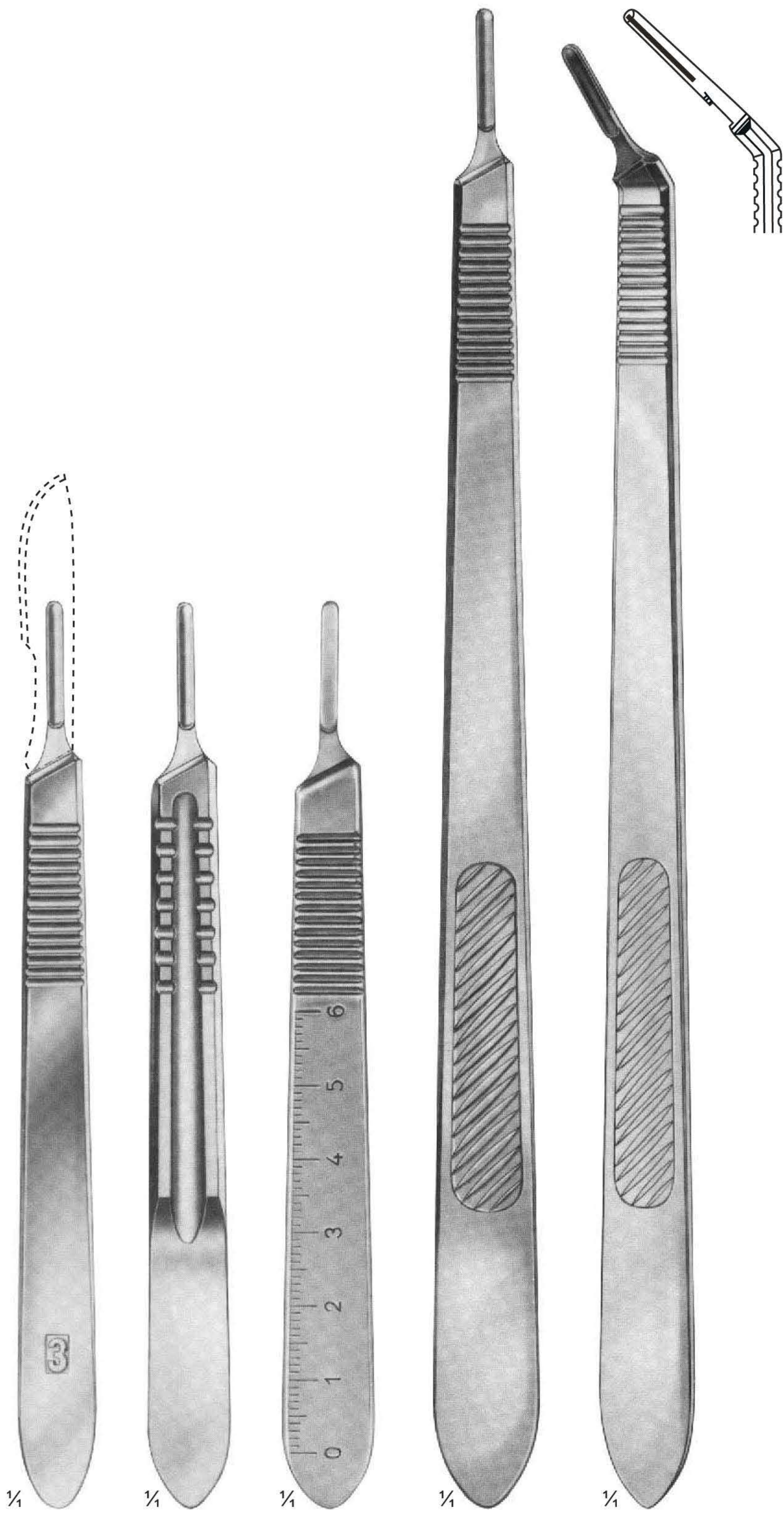

1/4	1/4	1/4	1/4	1/4
UG-228	UG-229	UG-230	UG-232	UG-235
STANDARD No. 3	No. 3	No. 3	No. 3 L	No. 3 L
SIZE: 100mm	SIZE: 135mm	SIZE: 130mm		SIZE: 145mm

Micro Scissors, "Spring Type" Flat Handles



1/2

UG-022
VANNAS
Size: 85 mm



1/2

UG-028
CASTROVIEJO
Size: 95 mm



1/2

UG-031
NOYES
Size: 125 mm



1/2

UG-032
WECKER
Eye Scissor
Size: 110 mm



1/2

UG-033
CASTROVIEJO
Eye Scissor
Size: 115 mm



1/2

UG-036
CASTROVIEJO
Eye Scissor
Size: 110 mm

Micro Scissors, "Spring Type" Flat Handles



1/2
UG-043
 Size: 120 mm

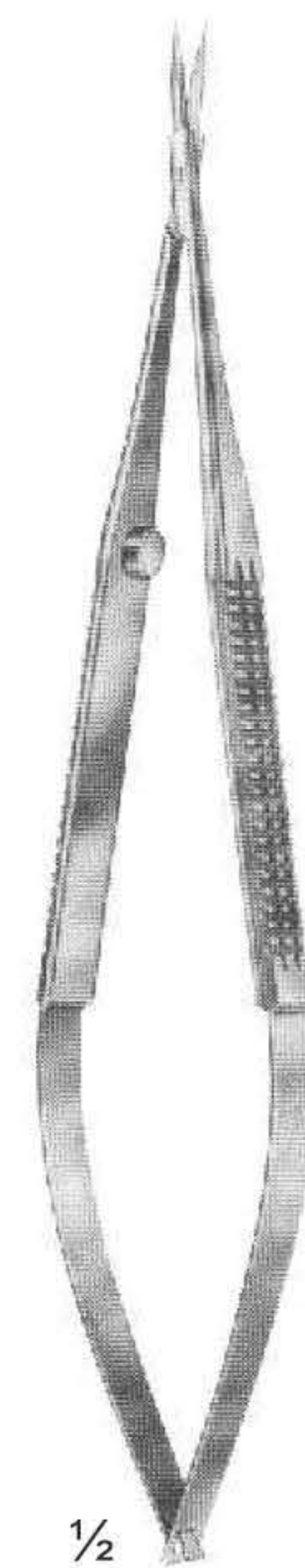

1/2
UG-046
 VANNAS
 Size: 160 mm

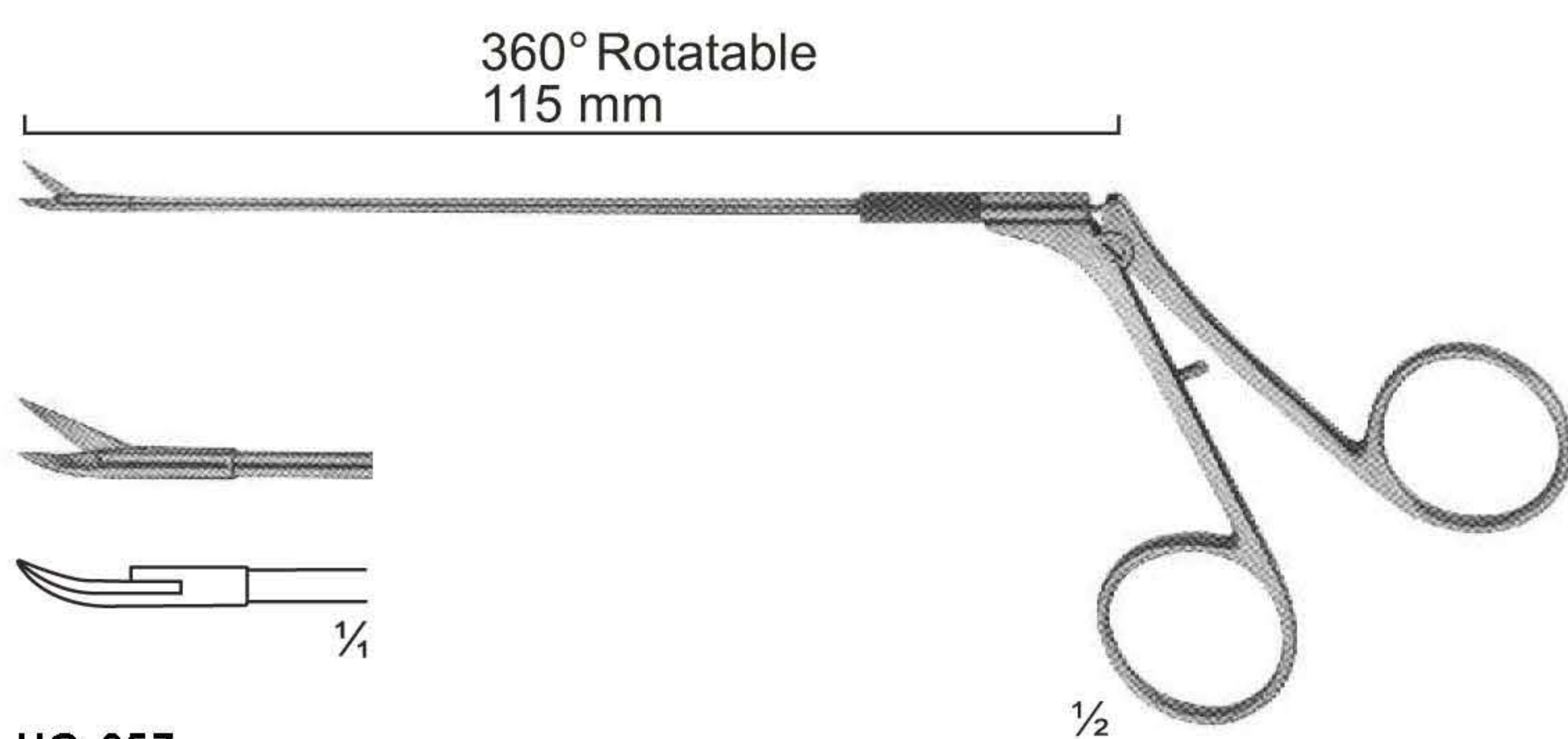

360° Rotatable
 115 mm
 1/4
UG-057
 CASPAR
 Micro Scissor Curved
 Size: 115 mm



1/2
UG-061
 Micro Dissecting Scissor
 Size: 145 mm

Micro Scissors, "Spring Type" Bayonet Shape

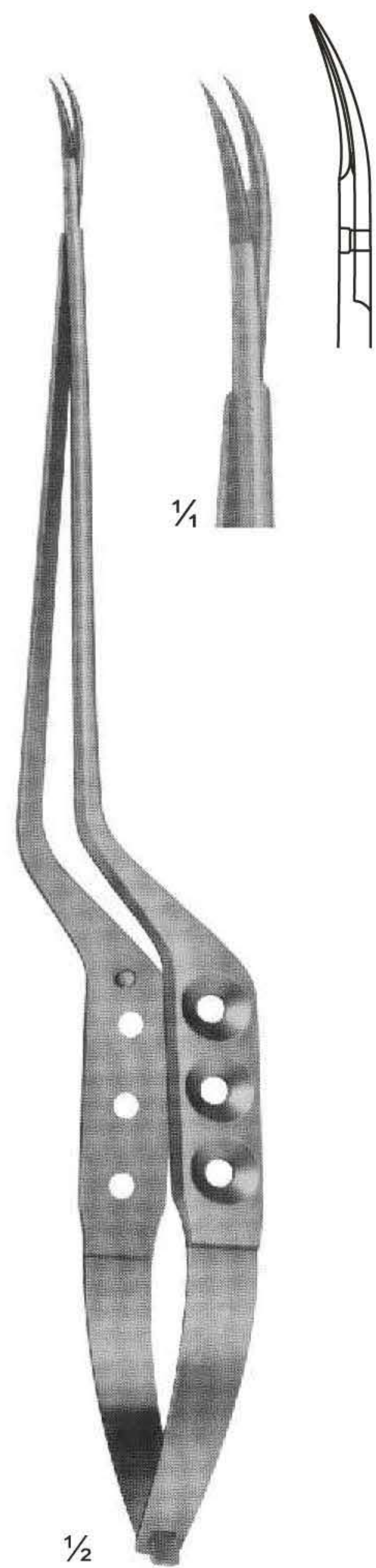

UG-069
YASARGIL
Size: 245 mm

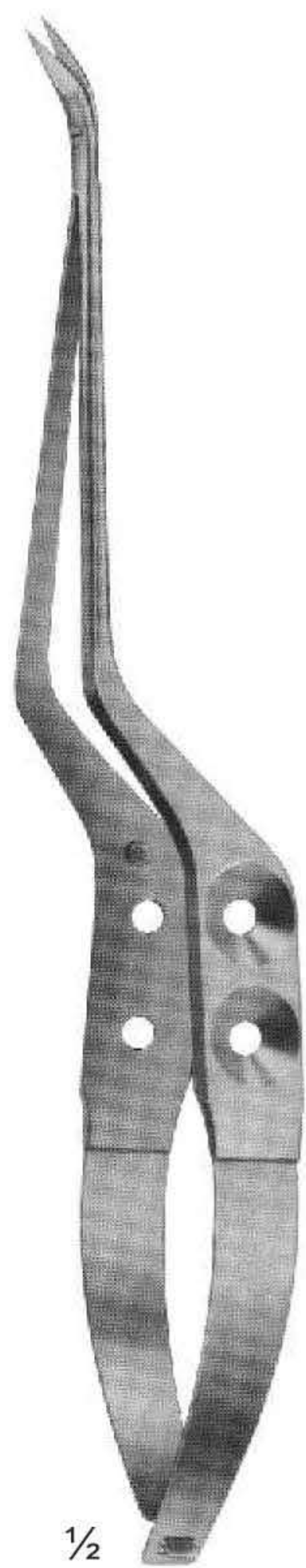

UG-070
Laterally Angled
Size: 200 mm

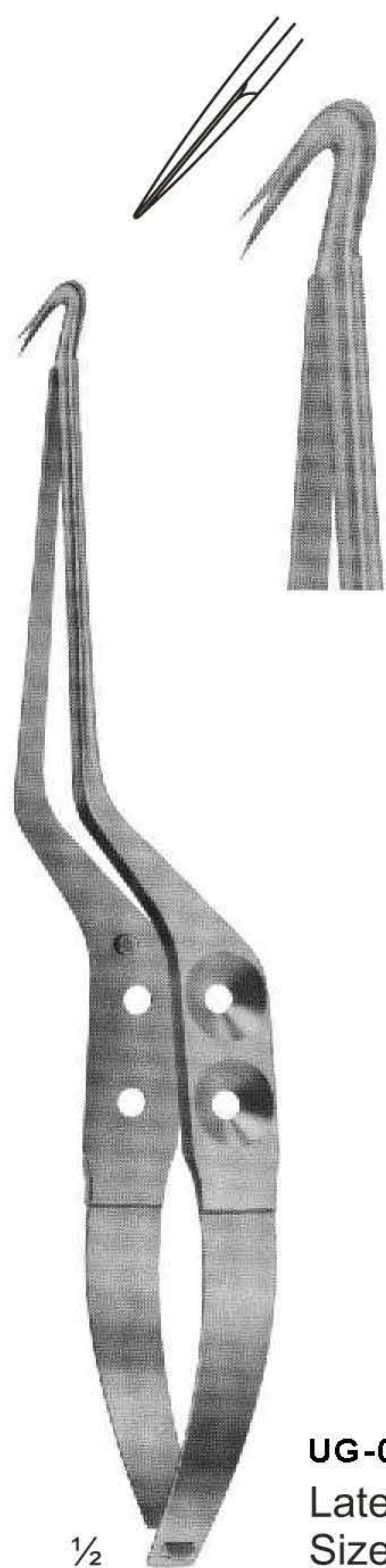

UG-073
Laterally Angled
Size: 190 mm



UG-074
YASARGIL
Size: 225 mm

Delicate Scissors



UG-077
Size: 120 mm



UG-089
STEVENS
Dissecting Scissors
Size: 115 mm



UG-092
METZENBAUM
Dissecting Scissors
Size: 145 mm

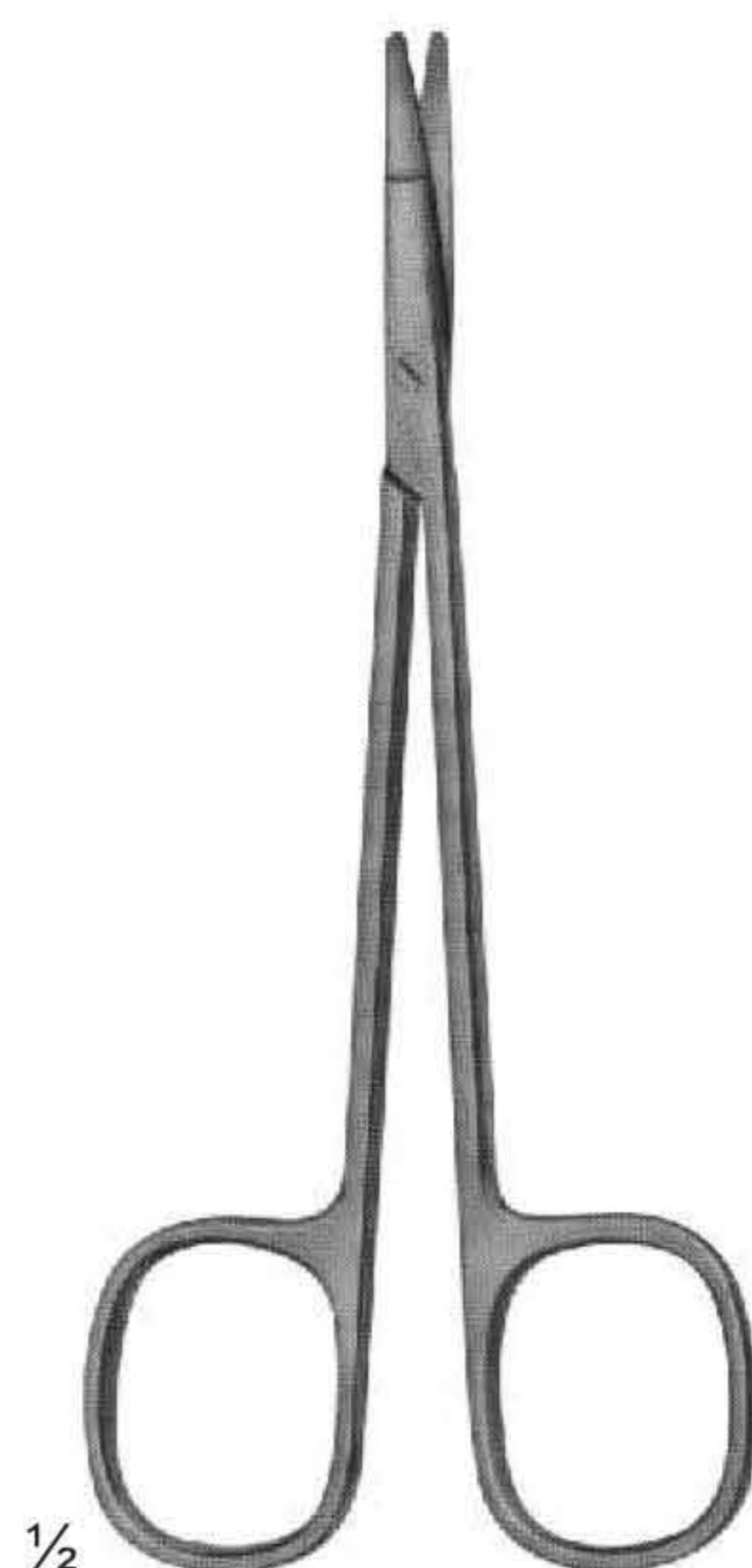

UG-095
Special flat points for
dissecting and
undermining the skin
Size: 145 mm

Delicate Scissors



UG-099
Size: 90 mm



UG-103
Size: 95 mm



UG-113
Size: 105 mm



UG-119
Size: 120 mm



UG-124
Size: 115 mm



UG-127
Size: 120 mm



UG-127
Size: 130 mm

Delicate Scissors



UG-134
JOSEPH
Size: 150 mm

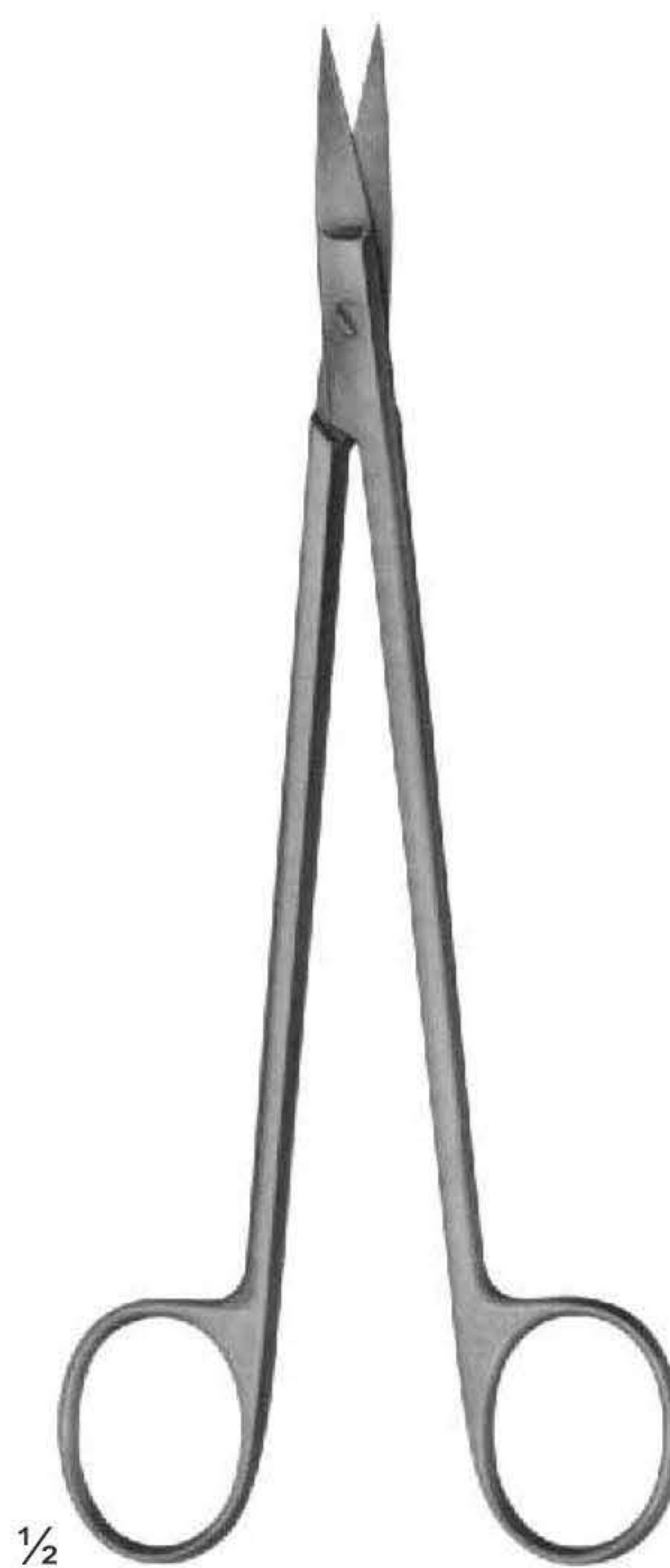

UG-138
KELLY
Size: 175 mm

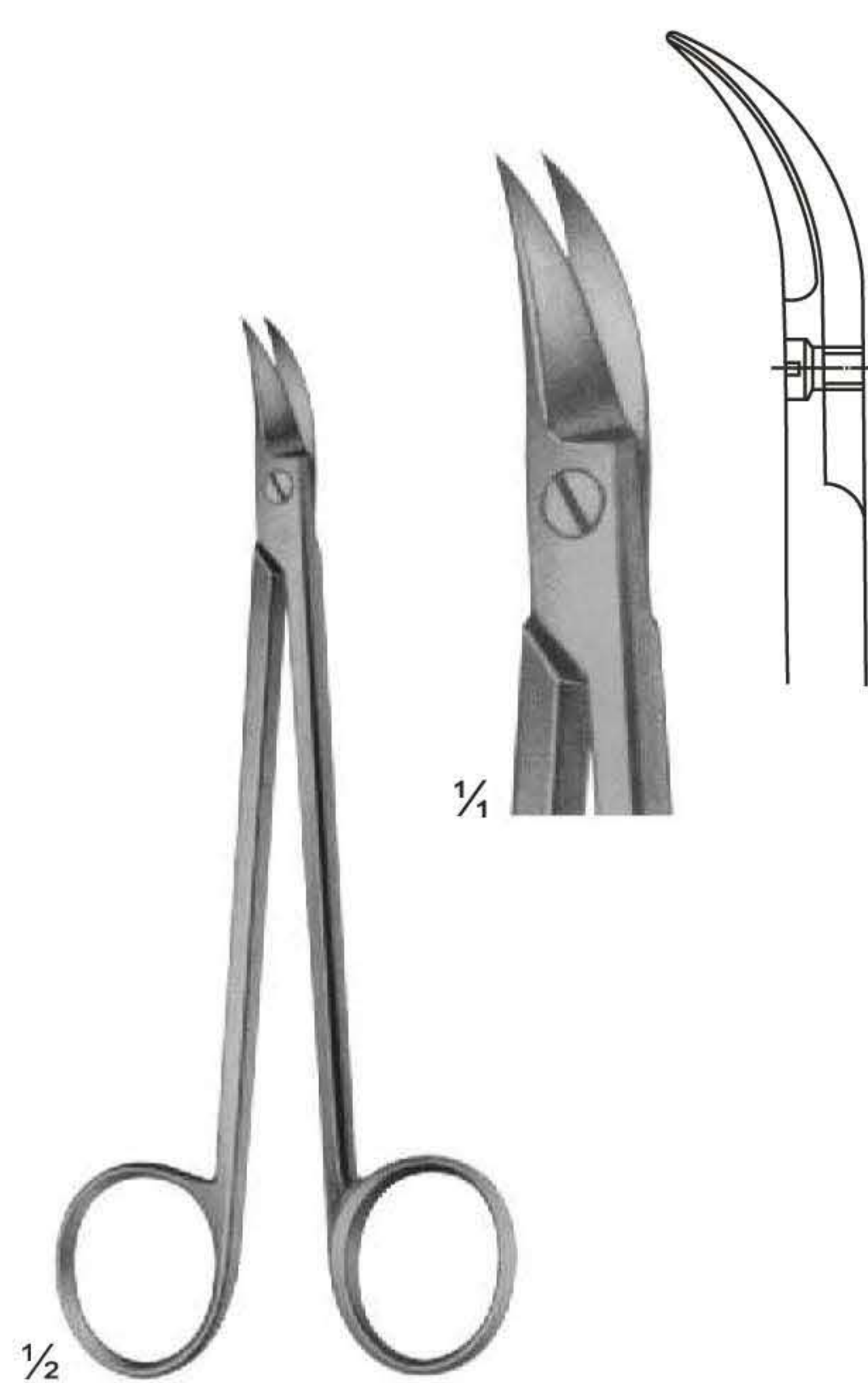

UG-141
QUINBY
Size: 130 mm

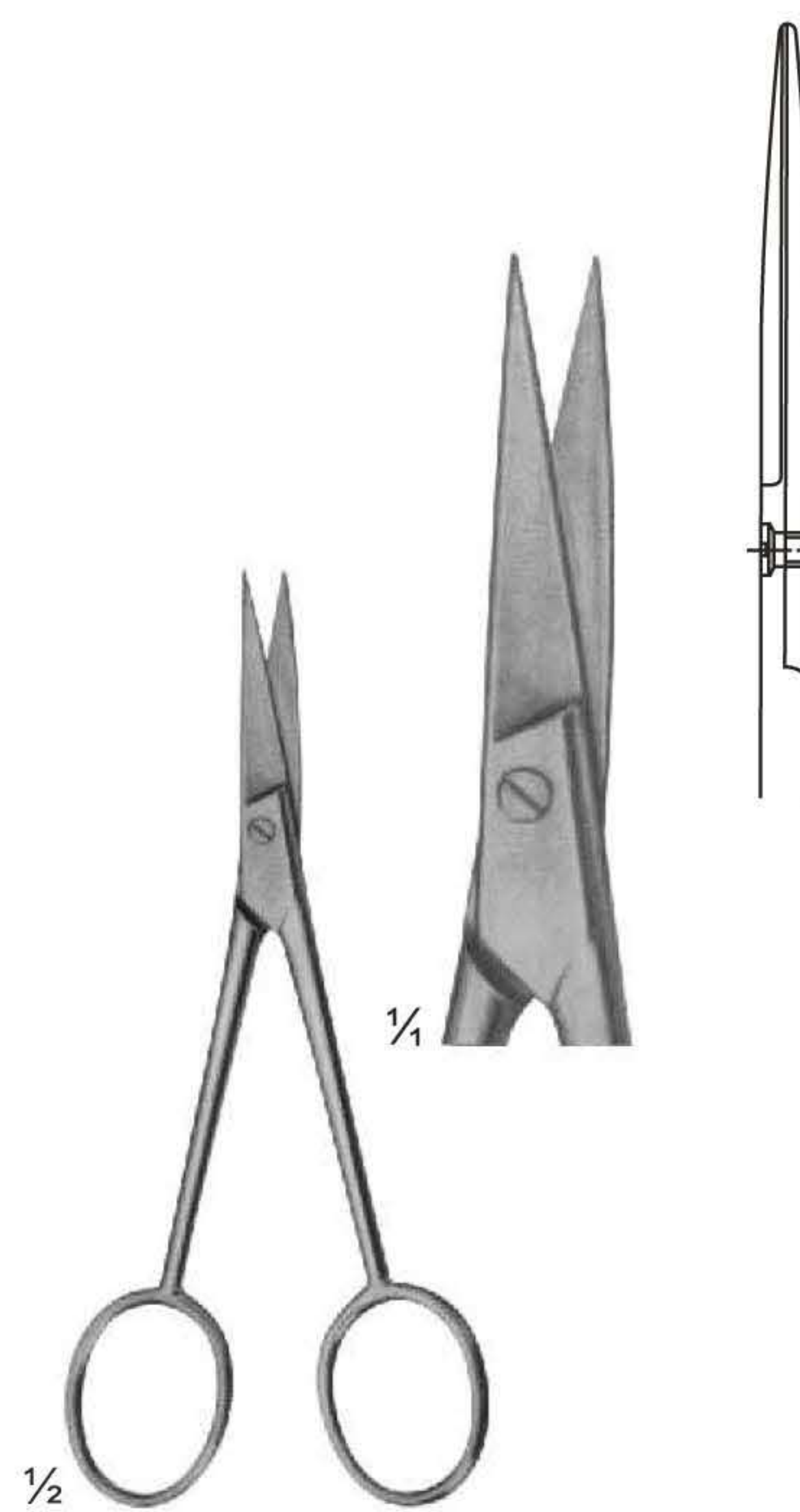

UG-142
Size: 110 mm

Surgical Scissors

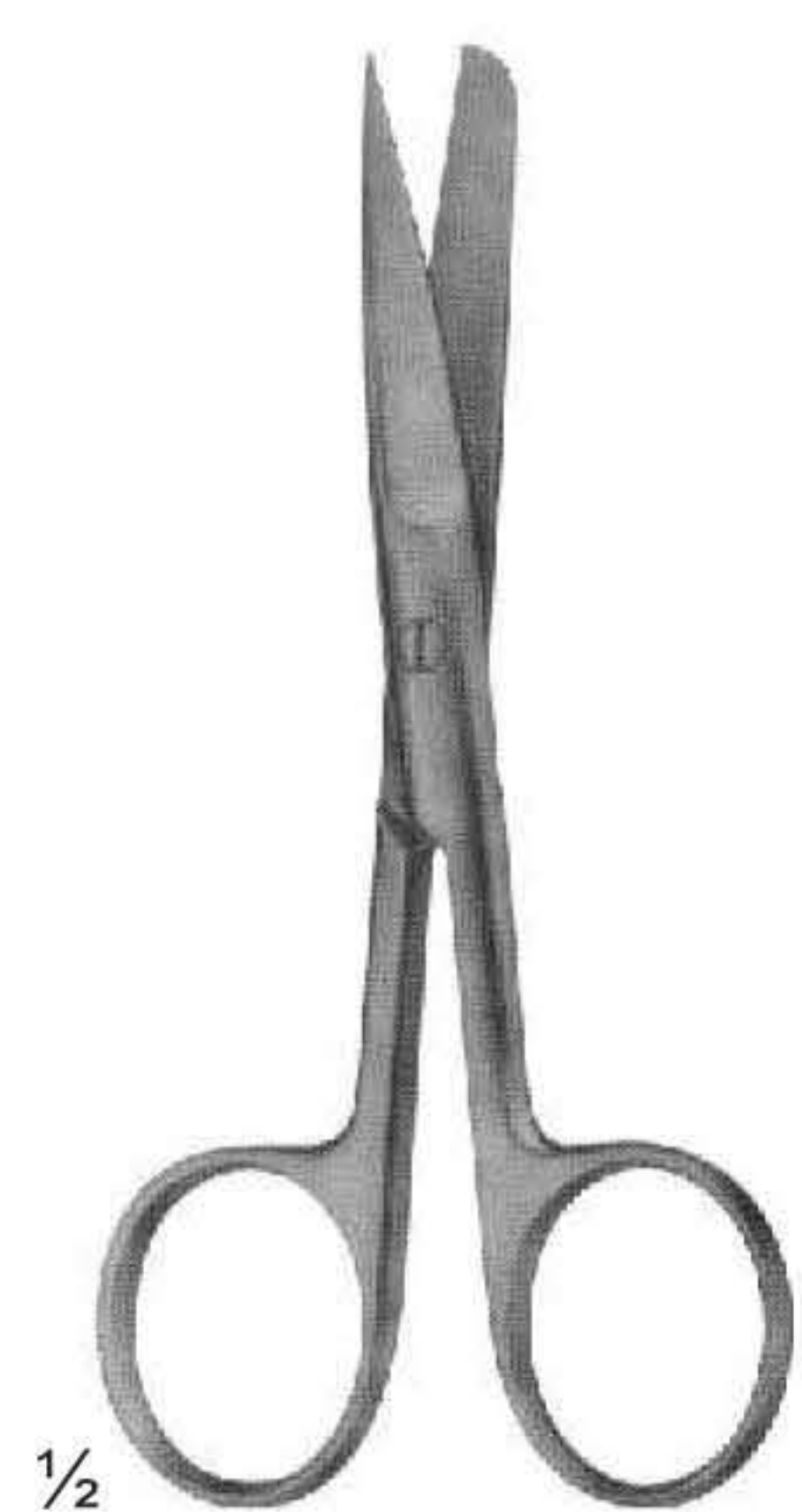

UG-147

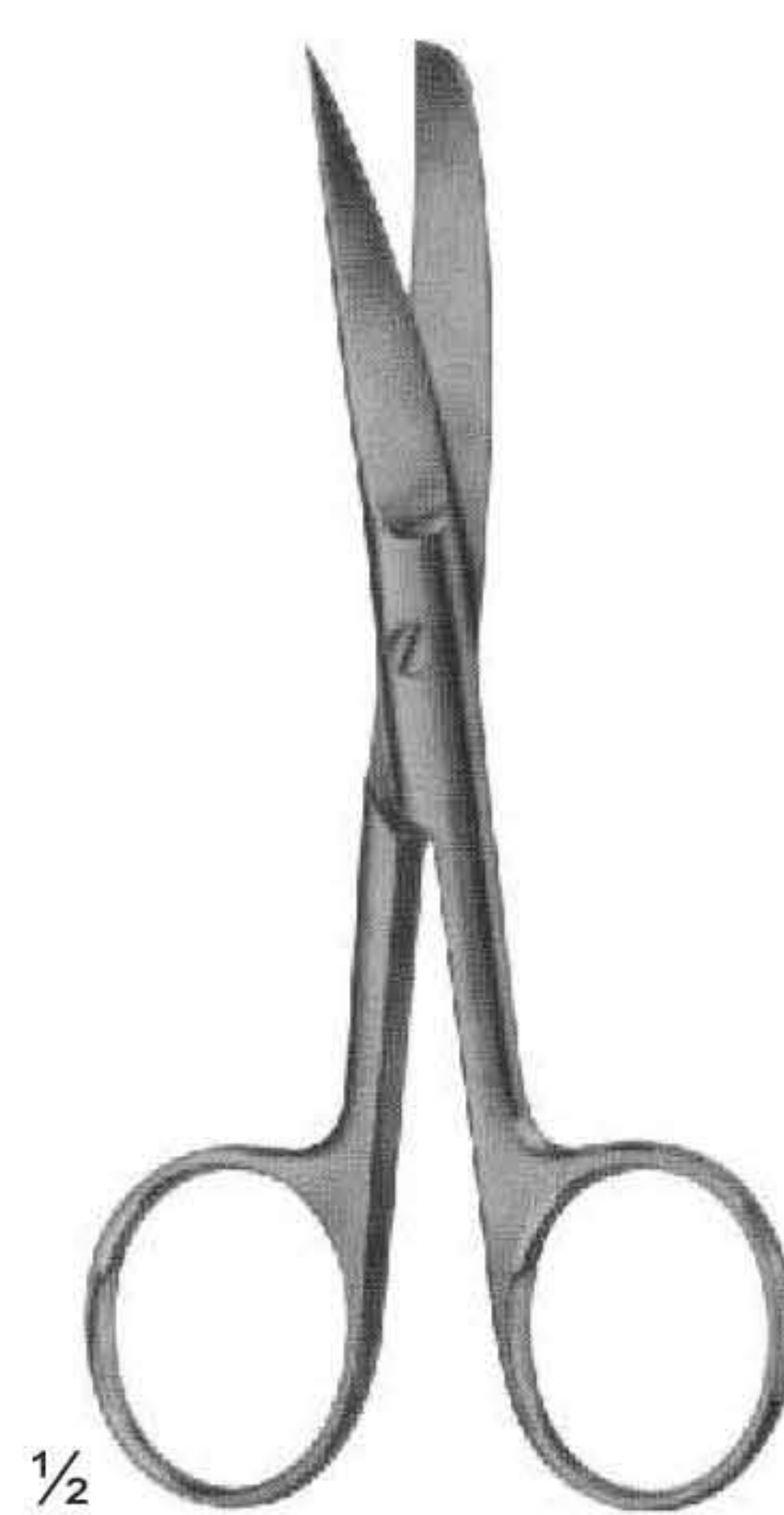

UG-152



UG-154
Slender Types



UG-157
For Wound Edges
1 Blade Serrated

Surgical Scissors



UG-161



UG-164 COOPER



UG-166
Standard Types



UG-168
Standard Types

Surgical Scissors

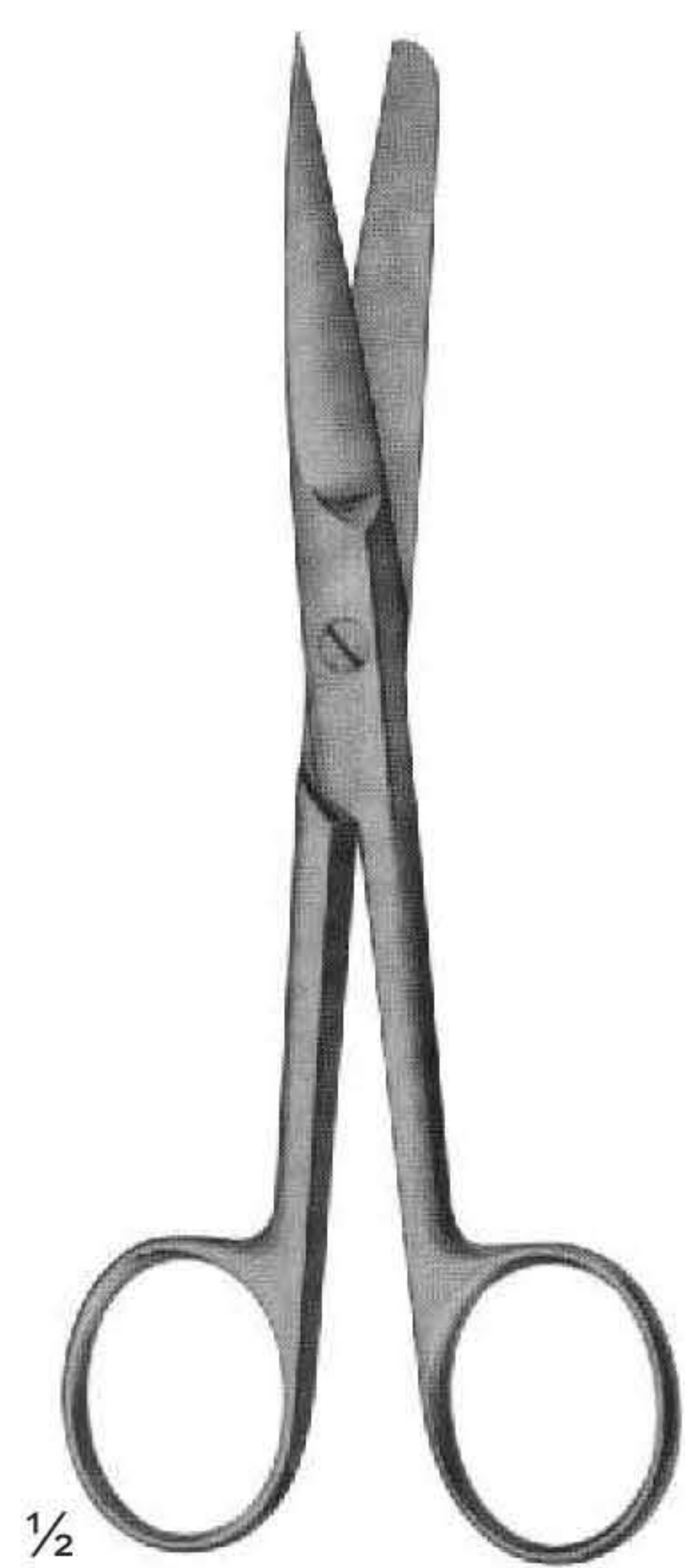

UG-171

DEAVER
With flat lock



UG-175

Incision Scissors

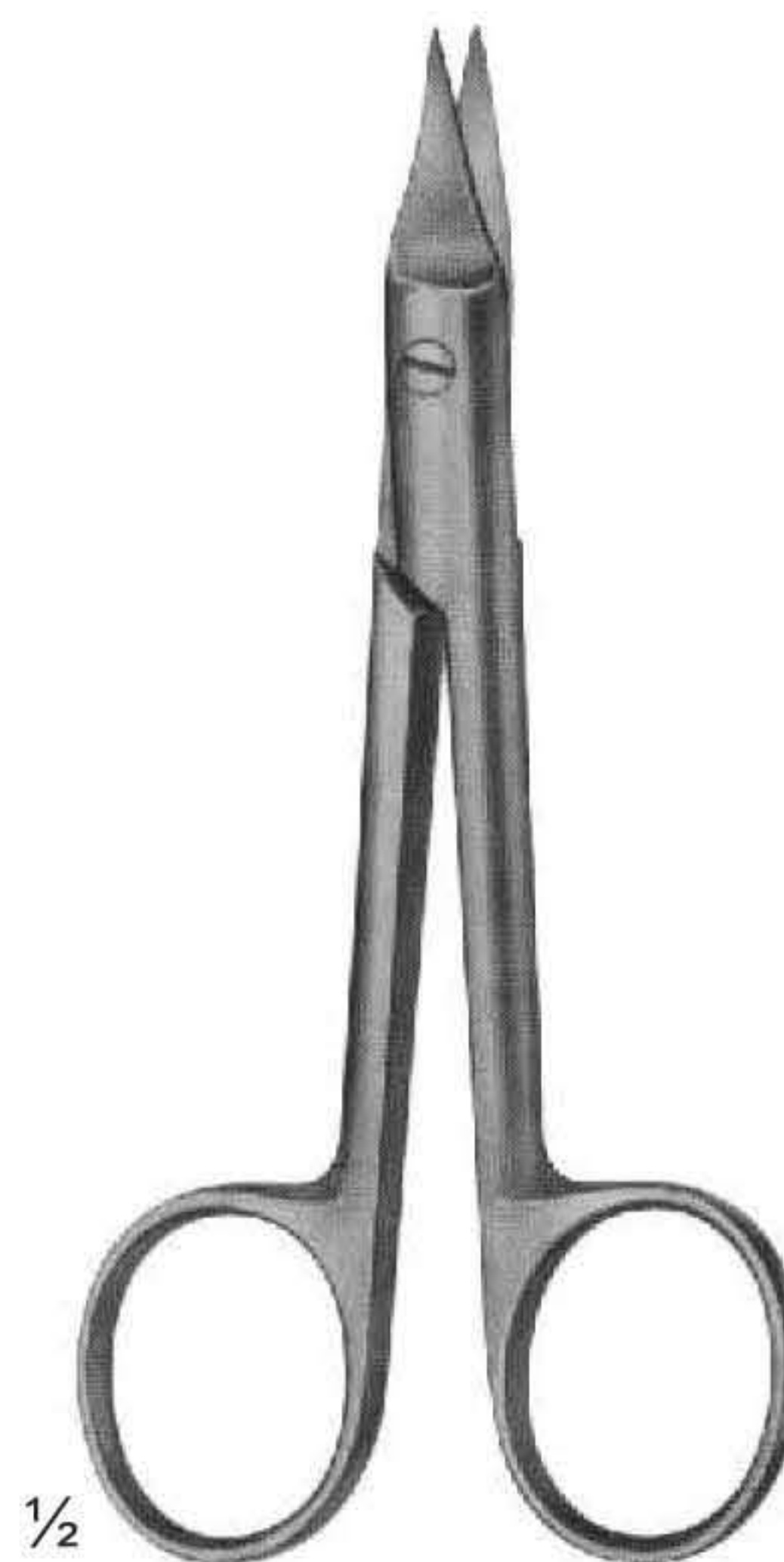

UG-188

SYSTRUNK
Nail Splitting Scissors

Dissecting Scissors

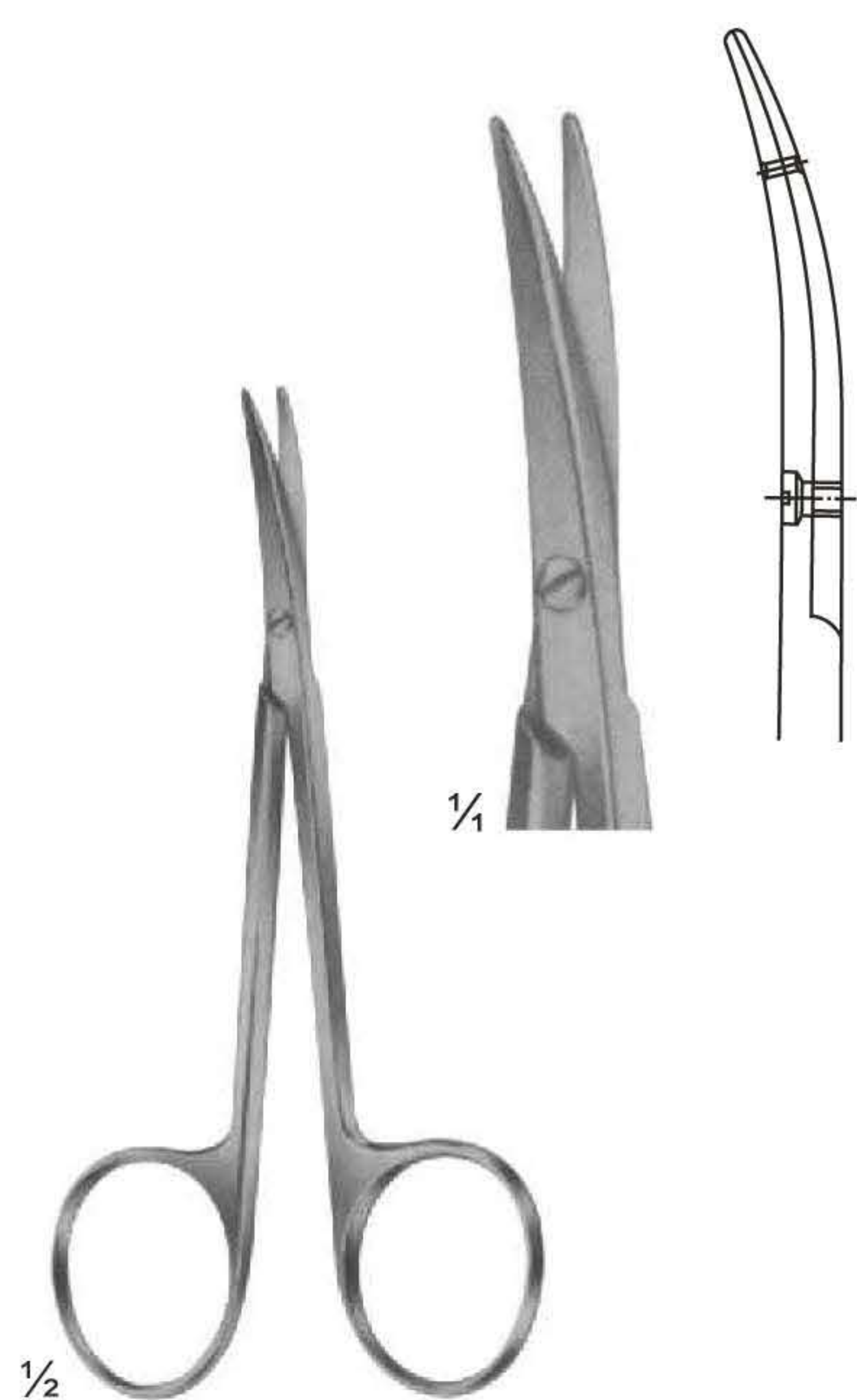

UG-195
LITTLER
Dissecting Scissors
Tips with eye for suture
Size: 115 mm

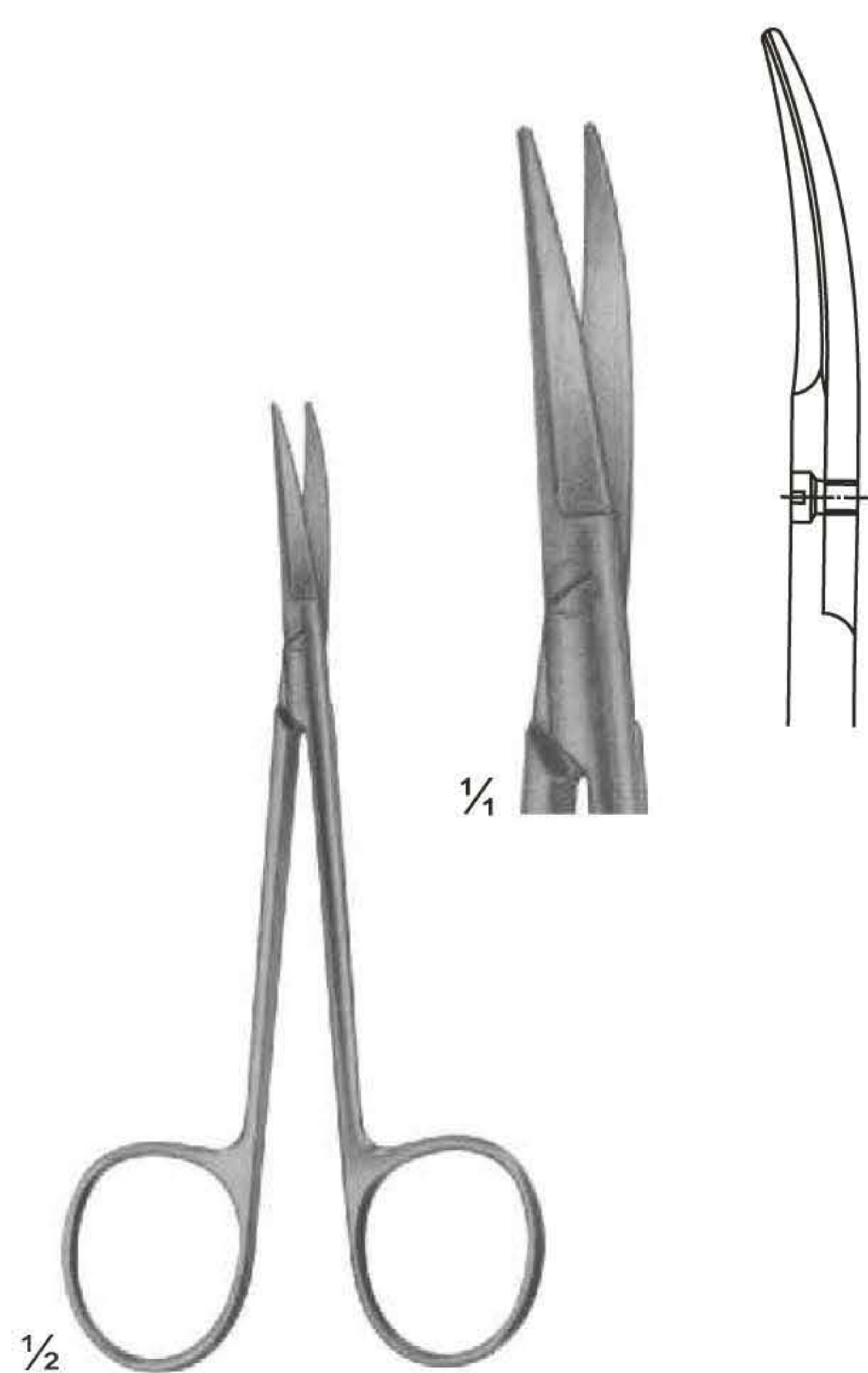

UG-197
COTTLE
Bulldog Scissors
Size: 115 mm



UG-199
STEVENS
Vessel and tendon Scissors
Size: 100 mm

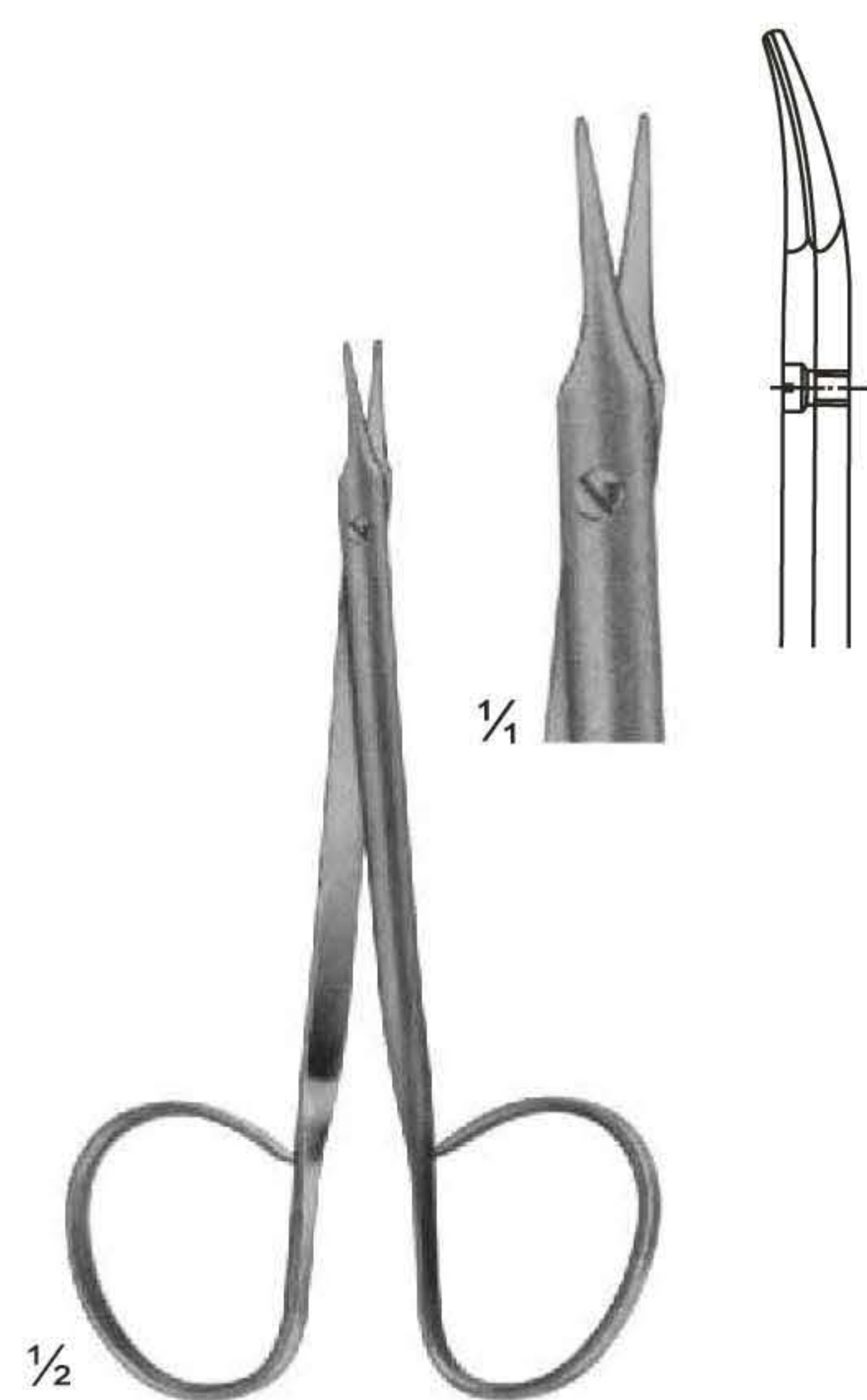

UG-366
STEVENS
Fine Dissecting Scissors
Size: 110 mm



UG-369
STEVENS
Vessel and tendon Scissors
Size: 110 mm

Dissecting Scissors

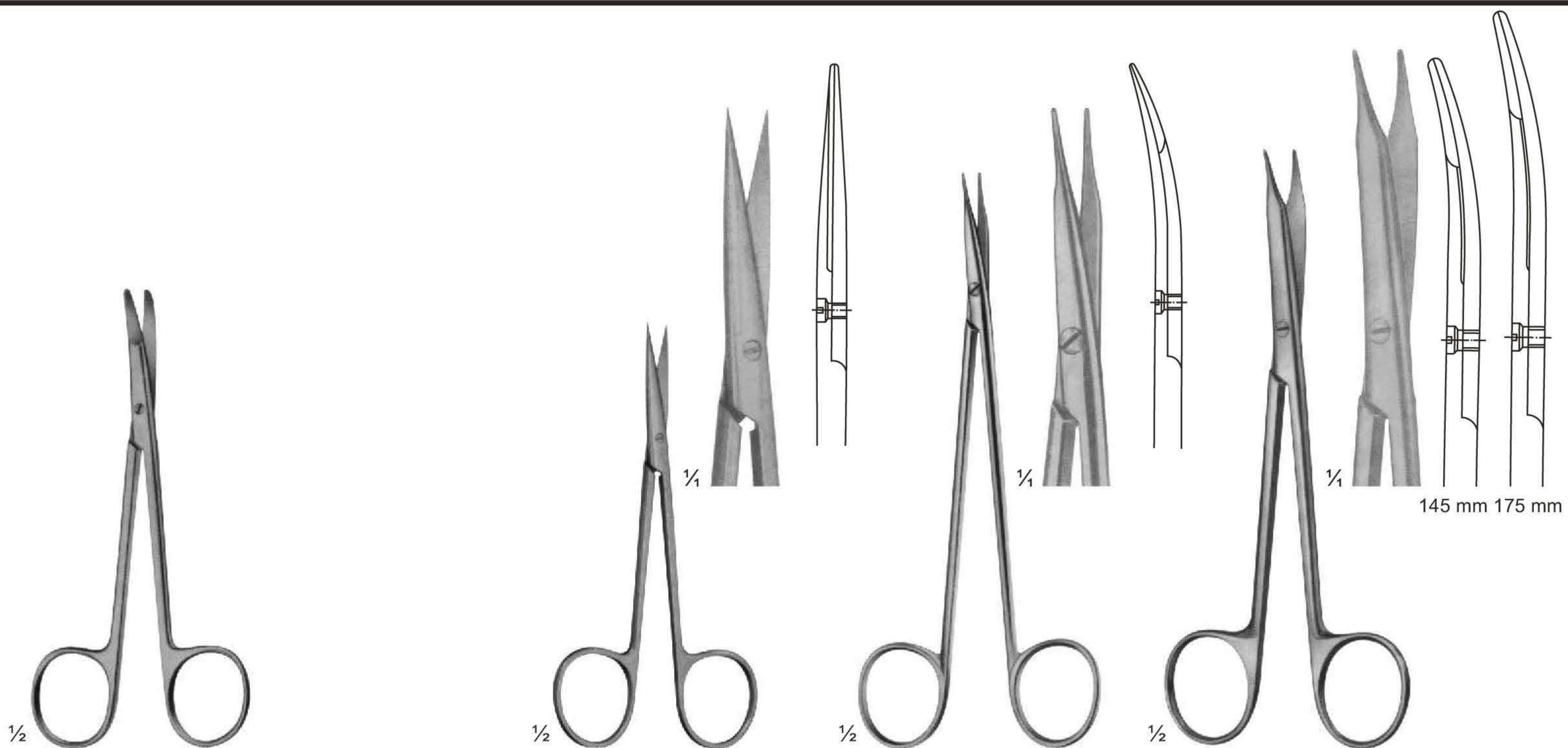

UG-433
KILNER
 Special flat points for dissecting and undermining the skin

UG-436
KILNER
 Fine dissecting scissors
 Size: 115 mm

UG-437
JAMESON
 Dissecting scissors
 Size: 150 mm

UG-439
REYNOLDS
 Dissecting scissors
 Size: 145 - 175 mm

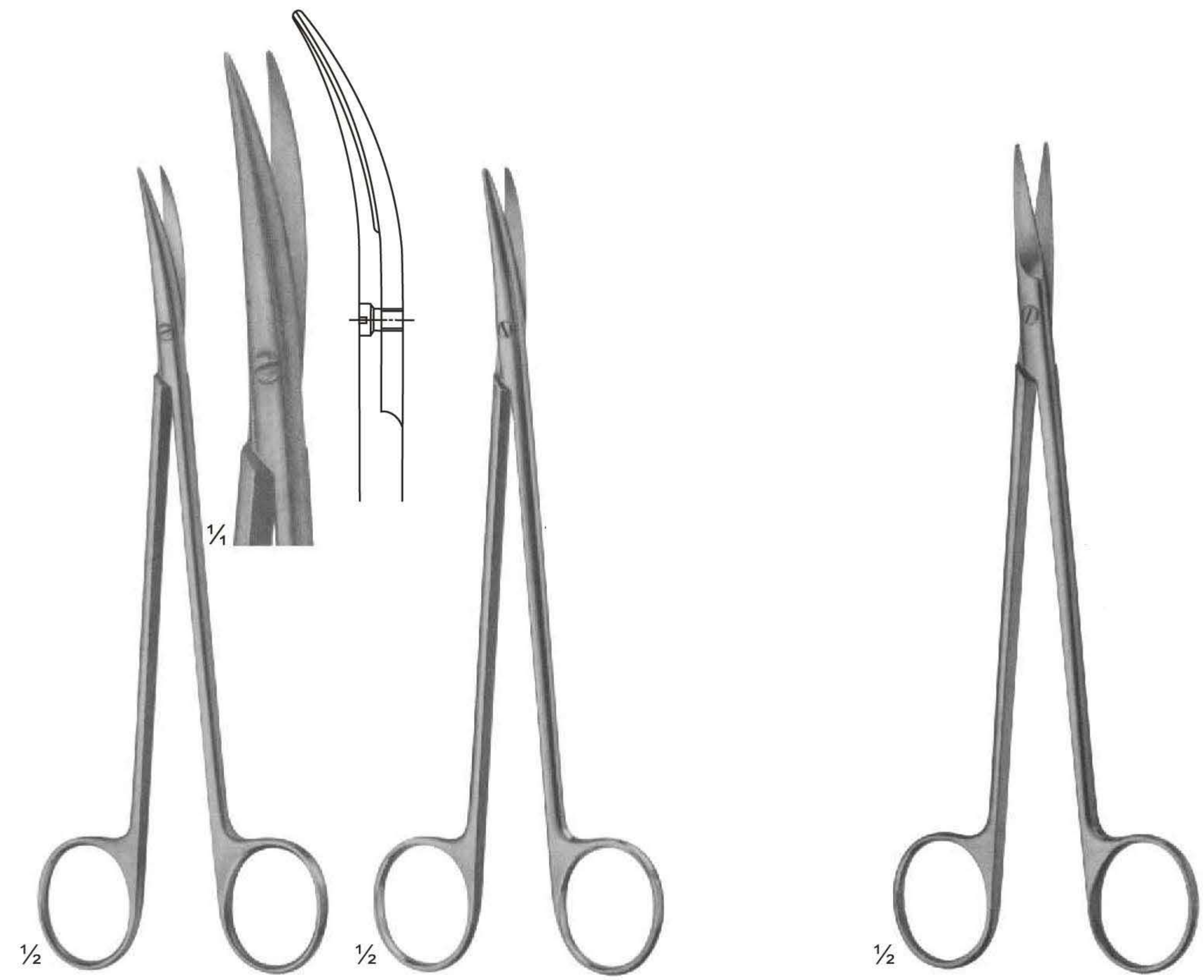

UG-442
DE BAKEY
 Ateriotomy scissors
 Size: 175 mm

UG-445
TOENNISADSON
 Dissecting scissors
 Size: 175 mm

UG-448
TOENNIS
 Dissecting scissors
 Size: 150 mm

Dissecting & Surgical Scissors



UG-449
FOMON
Lower lateral scissors



UG-451
LANDOLT
Enucleation scissors
Size



UG-453
MAYO



UG-457
MAYO-STILLE

Dissecting Scissors



UG-461
MAYO-STILLE
With chamfered blades

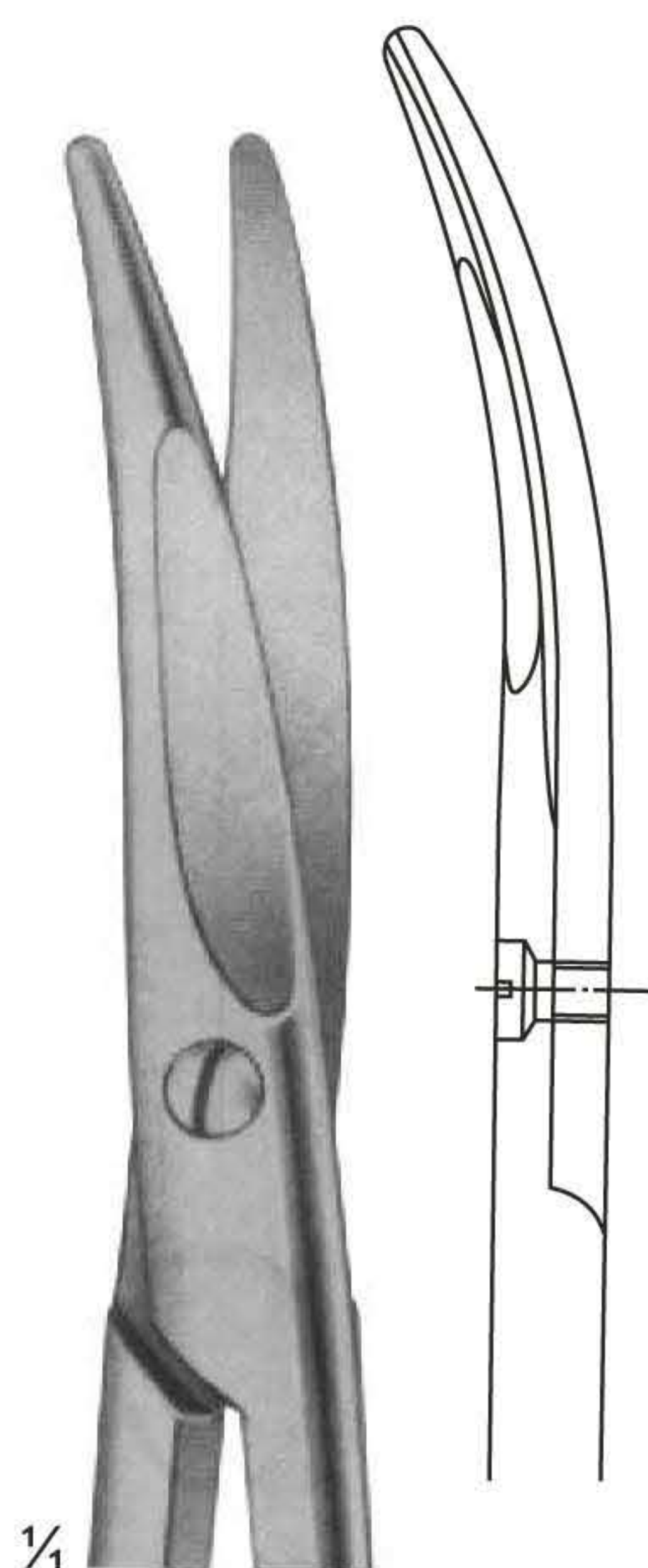

MAYO-STILLE
UG-463
Size: 140 mm
Size: 170 mm



MAYO
With chamfered blades
UG-465



UG-469
MAYO-NOBLE
Broad pattern



UG-472
MAYO-HARRINGTON

Dissecting Scissors



UG-475
STILLE
Size: 150 mm



UG-478
LEXER
Narrow
Size: 165 mm



UG-480
MAYO-LEXER
Standard



UG-481
MAYO

Dissecting Scissors



$\frac{1}{2}$
UG-486
BABY - METZENBAUM



$\frac{1}{2}$
UG-491
METZENBAUM



$\frac{1}{2}$
UG-503
NELSON - METZENBAUM

Vessel Scissors



UG-518
DE BAKEY
Size: 155 mm

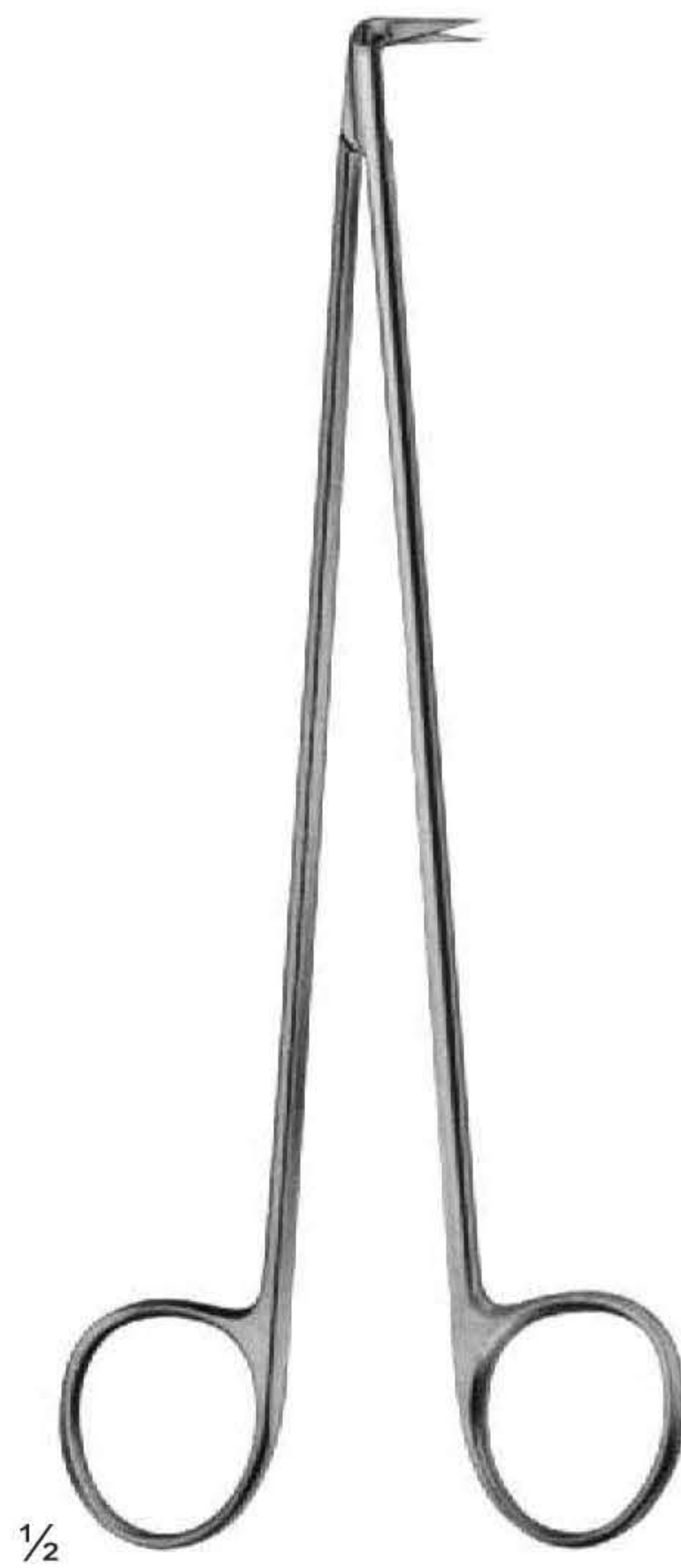

UG-534
DIETRICH
Size: 170 mm

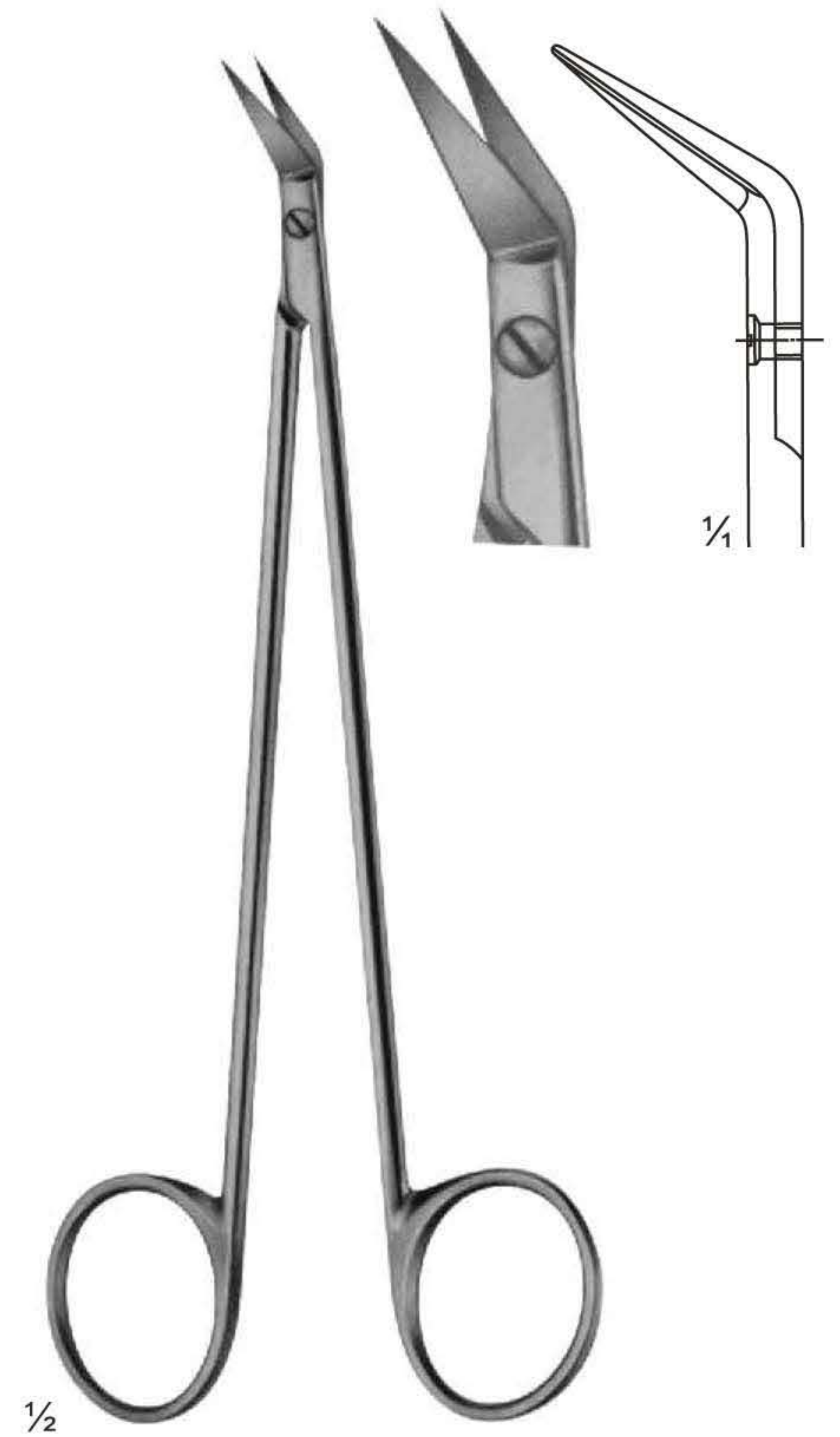

UG-536
POTTS-SMITH
Size: 180 mm

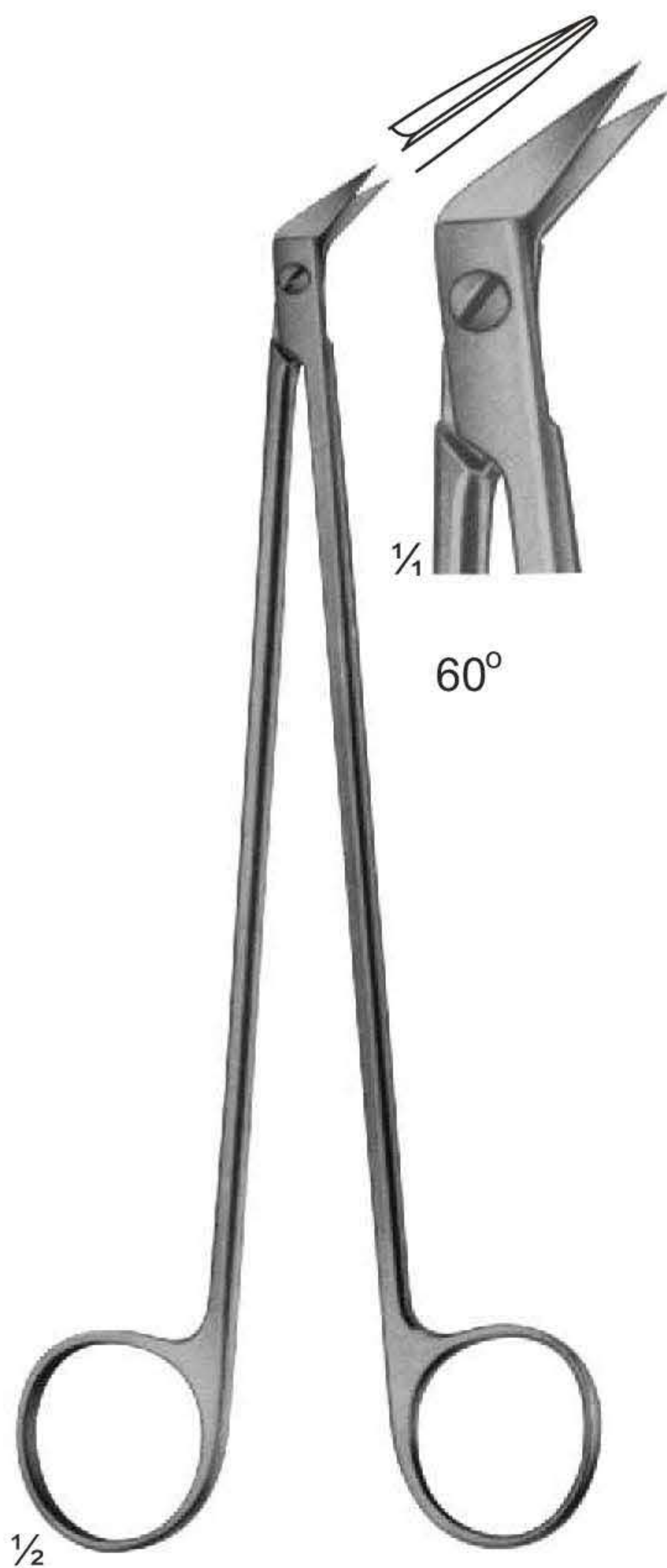

UG-538
POTTS-SMITH
Size: 180 mm



UG-539
DEBAKEY
Size: 155 mm

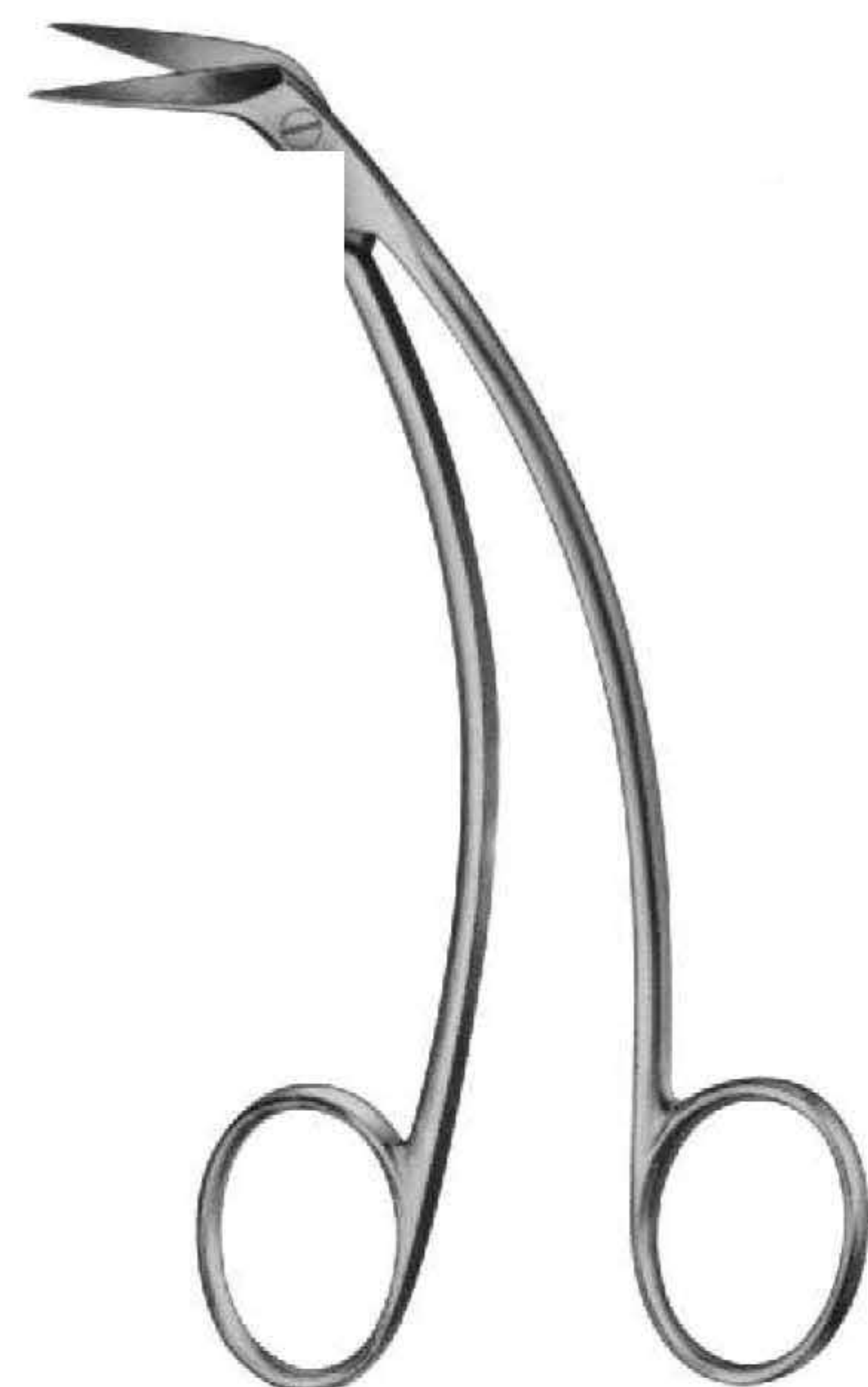

UG-542
FAVOLORO
Size: 140 mm

Cardiovascular and Neuro-Surgery Scissors



UG-552
OLIVECRONA
Dura Scissors

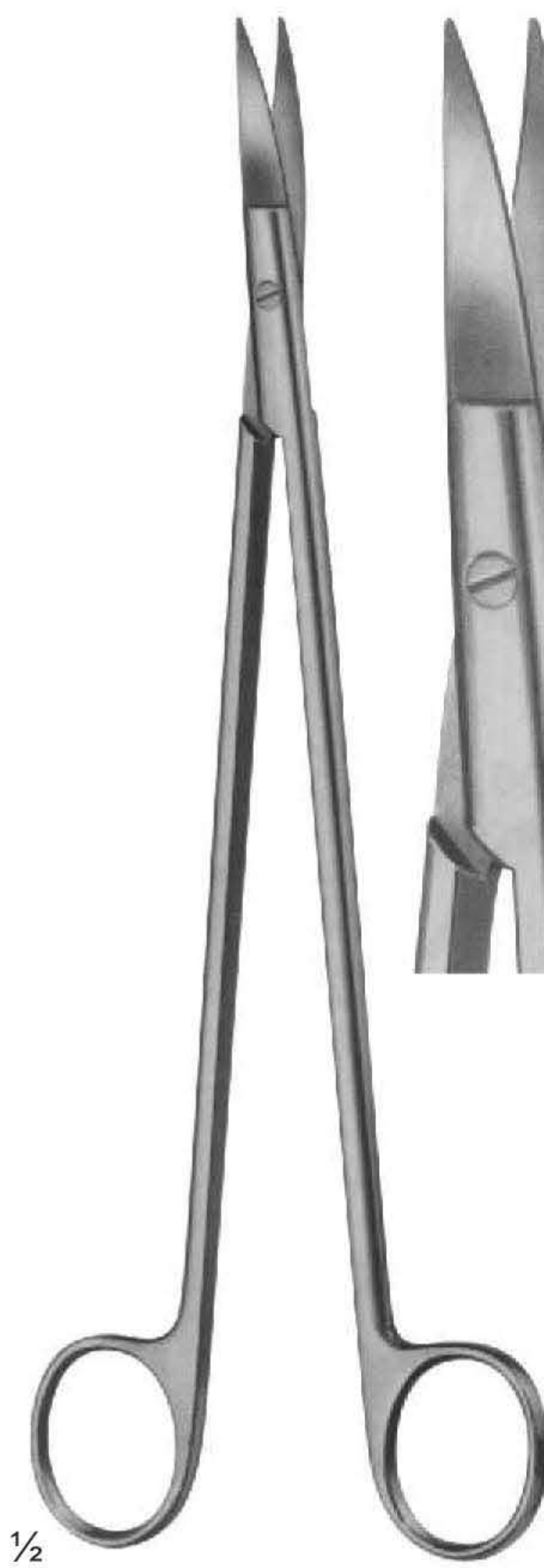

UG-555
STRULLY
Pointed
Size: 220 mm

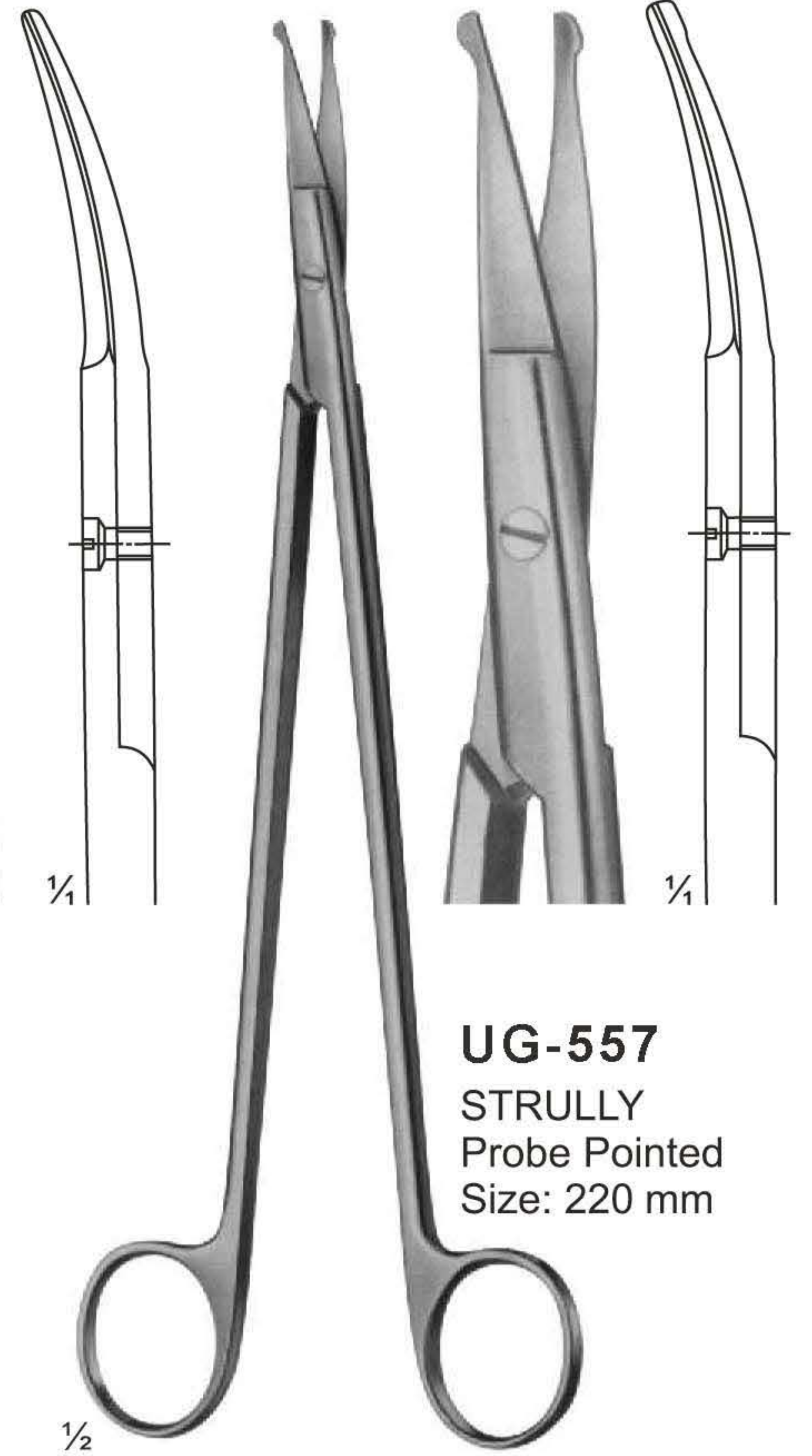

UG-557
STRULLY
Probe Pointed
Size: 220 mm

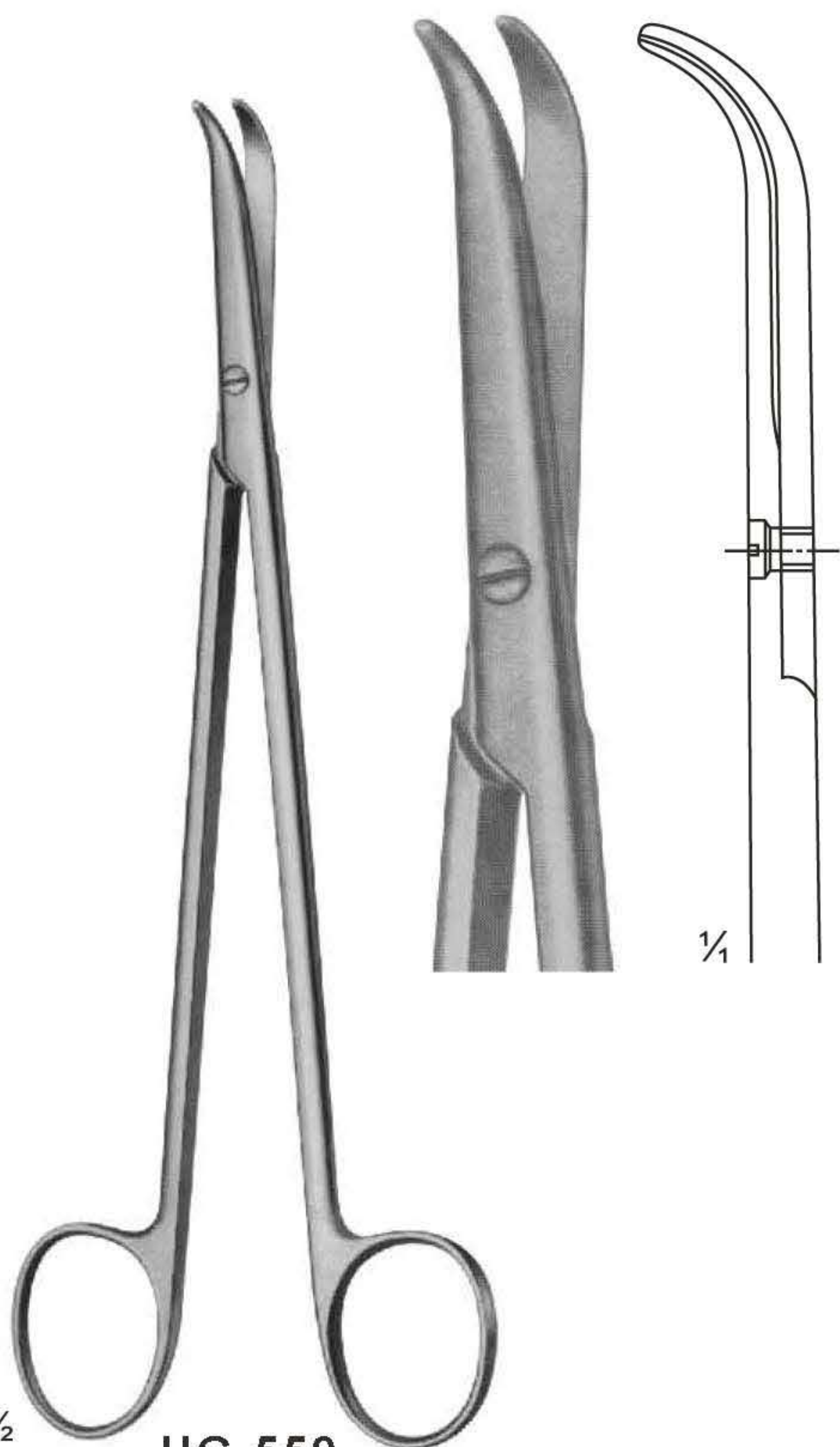

UG-559
THOREK
Size: 180 mm

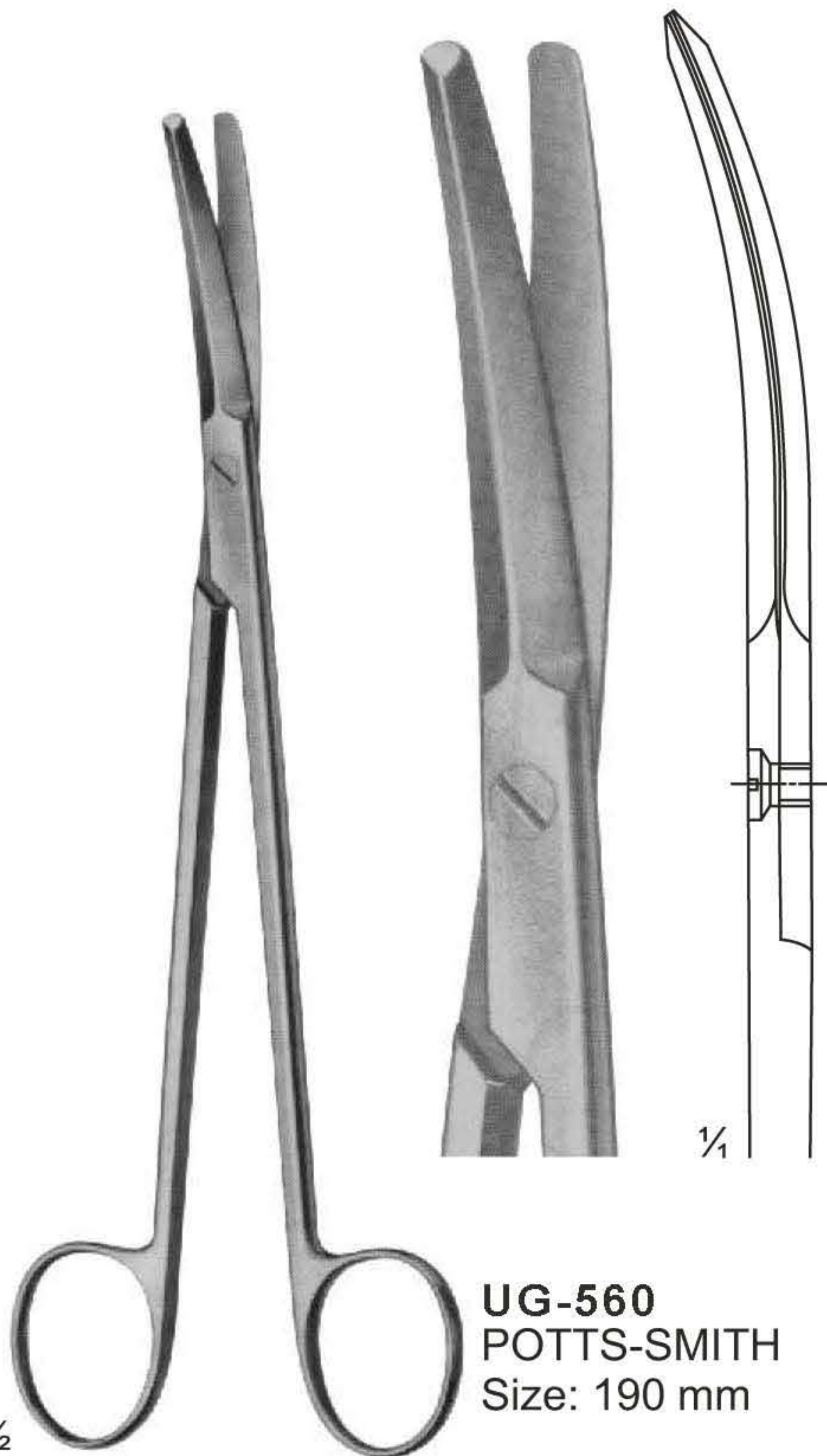

UG-560
POTTS-SMITH
Size: 190 mm

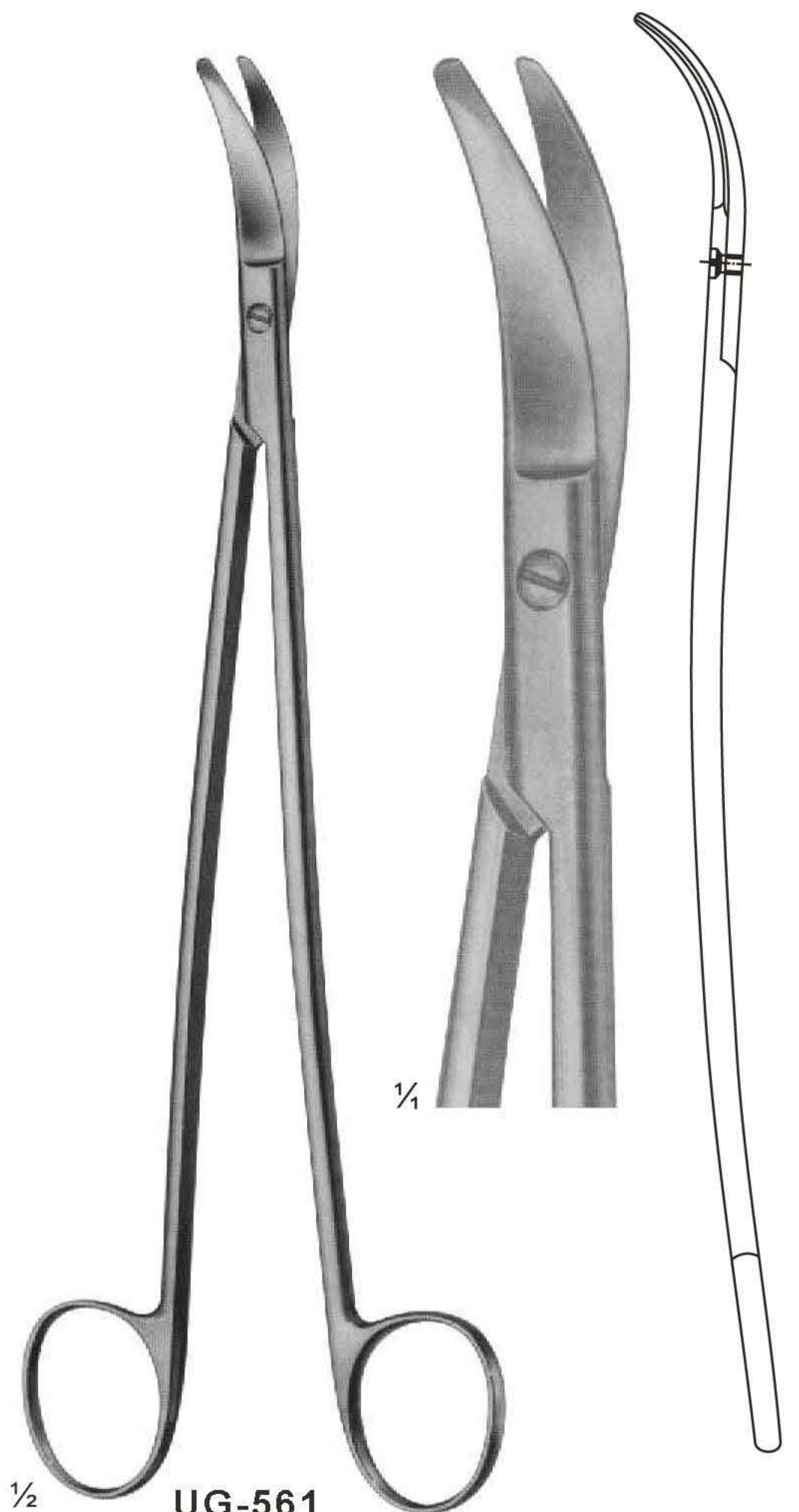

UG-561
SATINSKY
Size: 245 mm

Delicate, Nasal and Tonsil Scissors



UG-565
1 Finely Toothed Blade
Size: 130 mm

UG-567
LOCKLIN
Curved Sideways,
1 Toothed Blade
Size: 155 mm

UG-568
FOMON
Blades Serrated
Size: 145 mm

UG-569
COTTLE
Size: 165 mm

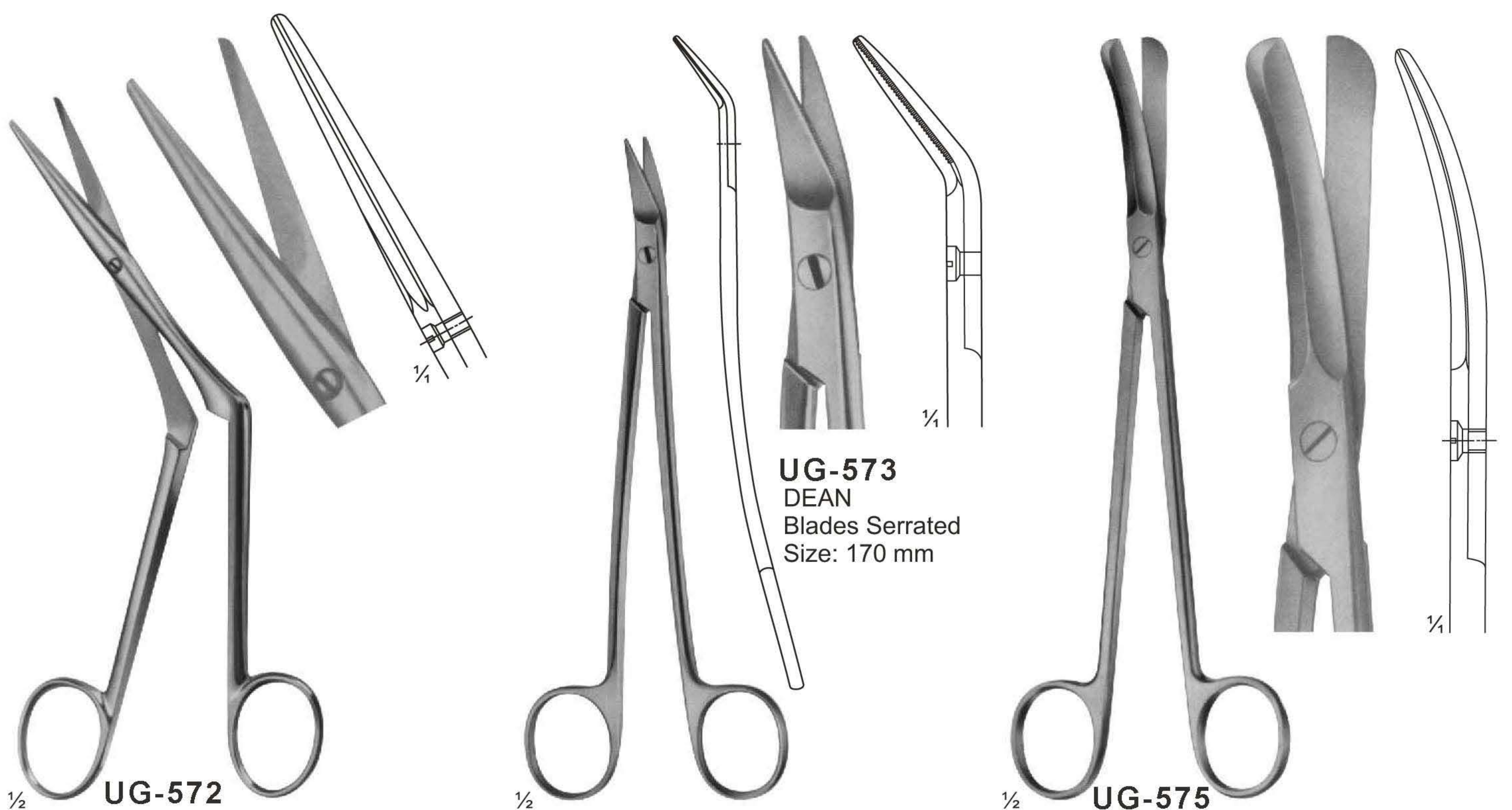

UG-572
HEYMANN-KNIGHT
Size: 175 mm

UG-573
DEAN
Blades Serrated
Size: 170 mm

UG-575
GOOD
Size: 195 mm

Bone Shears



UG-577
KILLIAN
Size: 200 mm

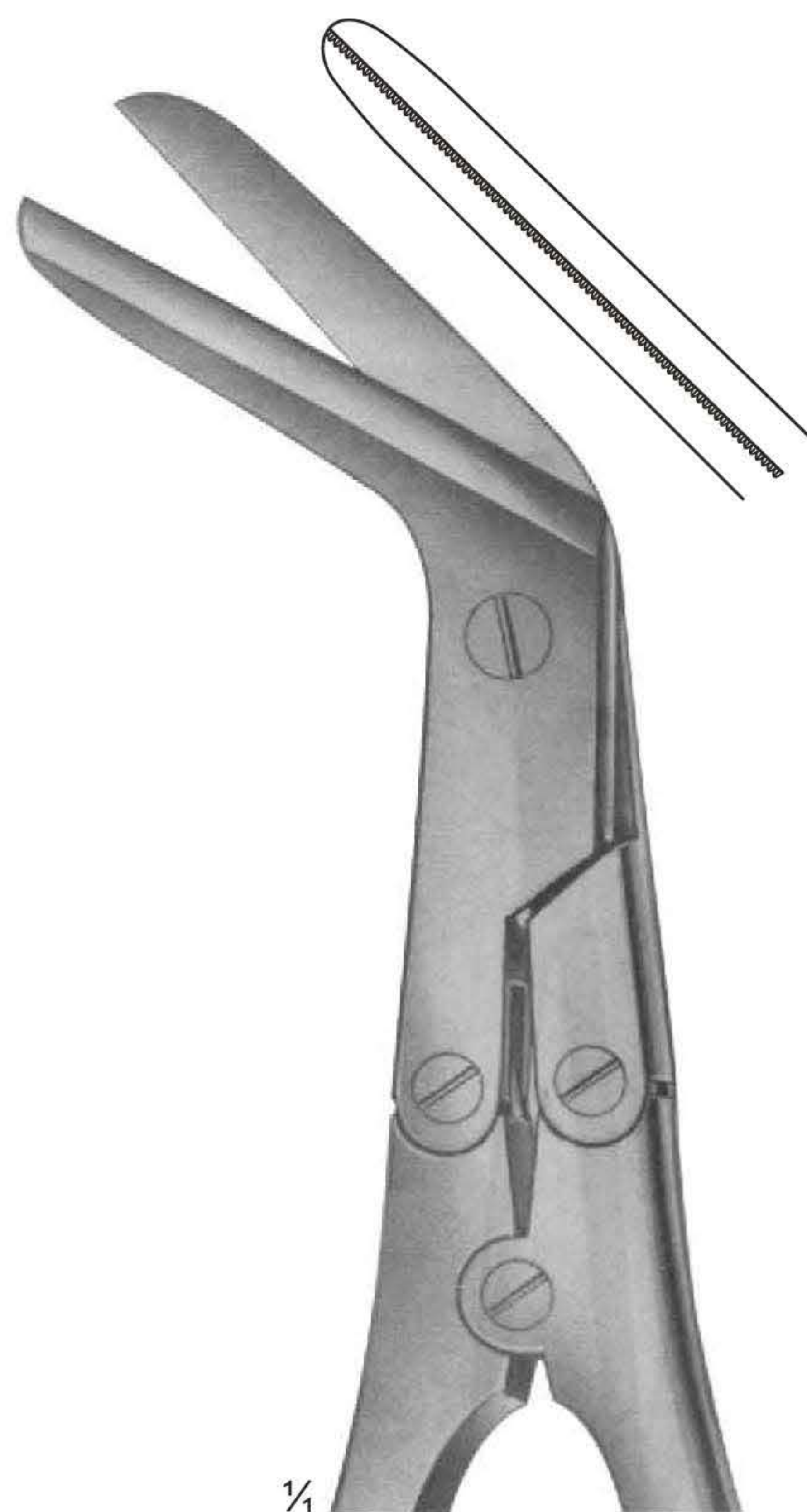

UG-579

Operating and Gynaecology Scissors

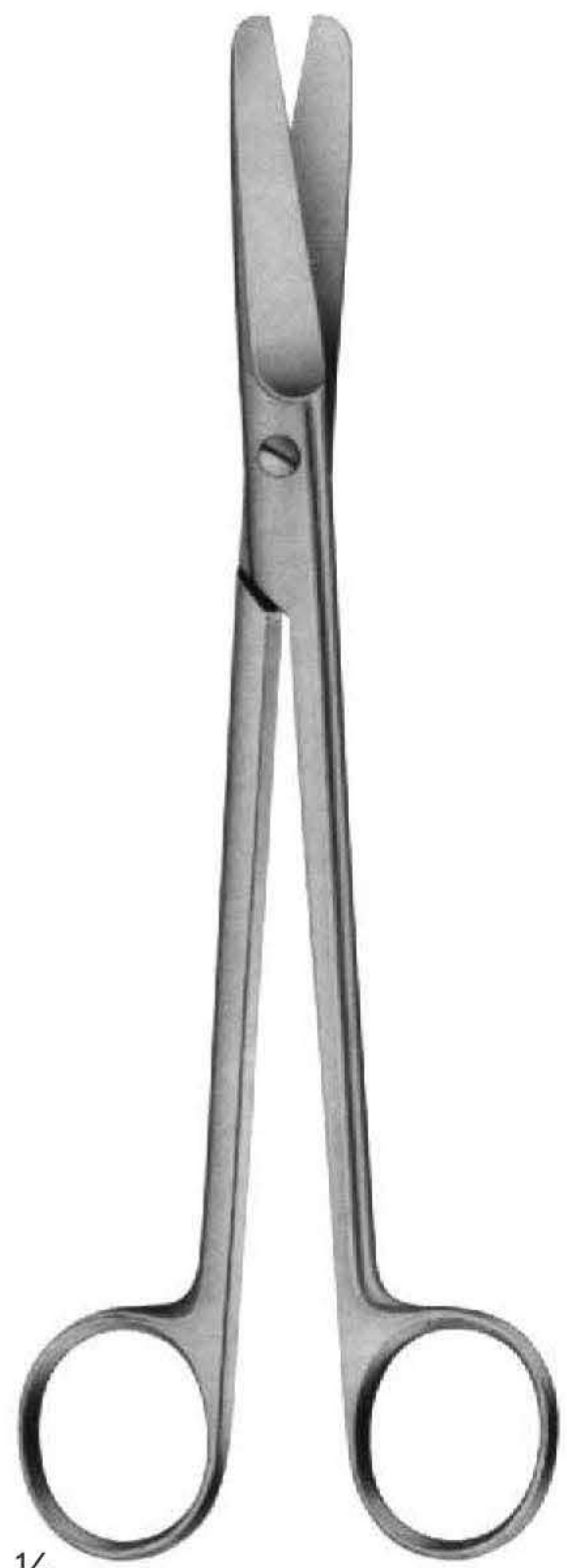

$\frac{1}{2}$
UG-581
SIMS



$\frac{1}{2}$
UG-610
SIMS



$\frac{1}{2}$
UG-611
SIMS

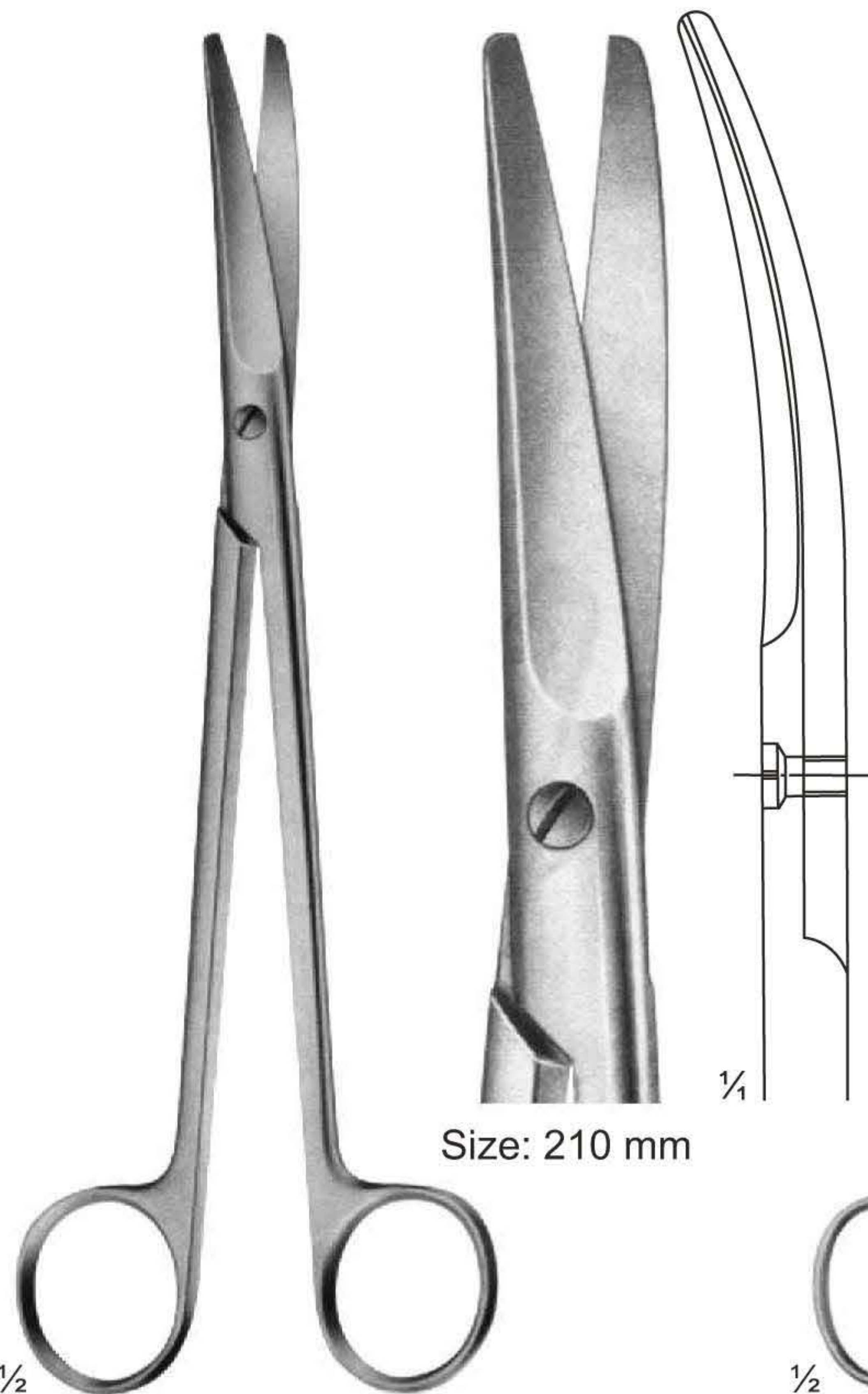

$\frac{1}{2}$
UG-612
SIMS

Size: 210 mm

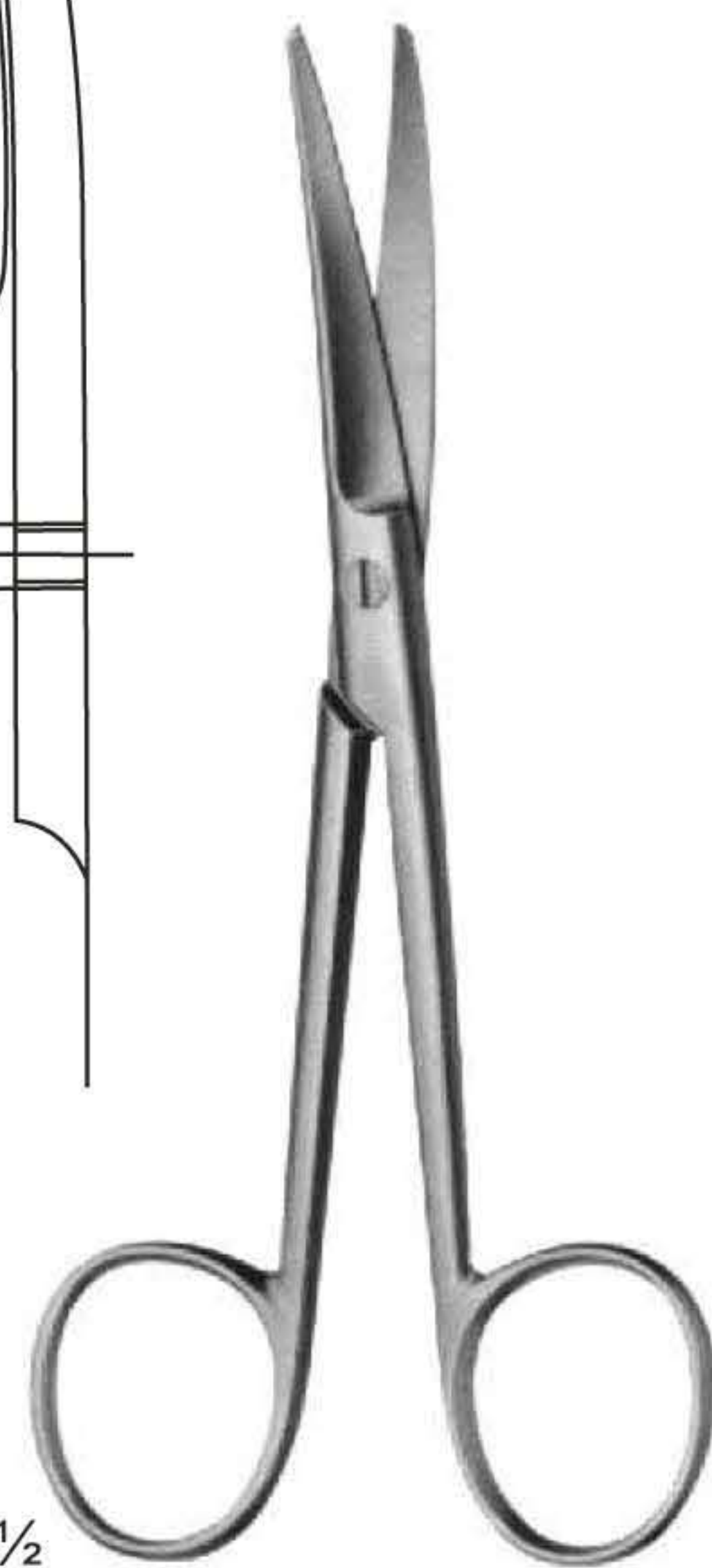

$\frac{1}{2}$
UG-614
WERTHEIM

Operating and Gynaecology Scissors

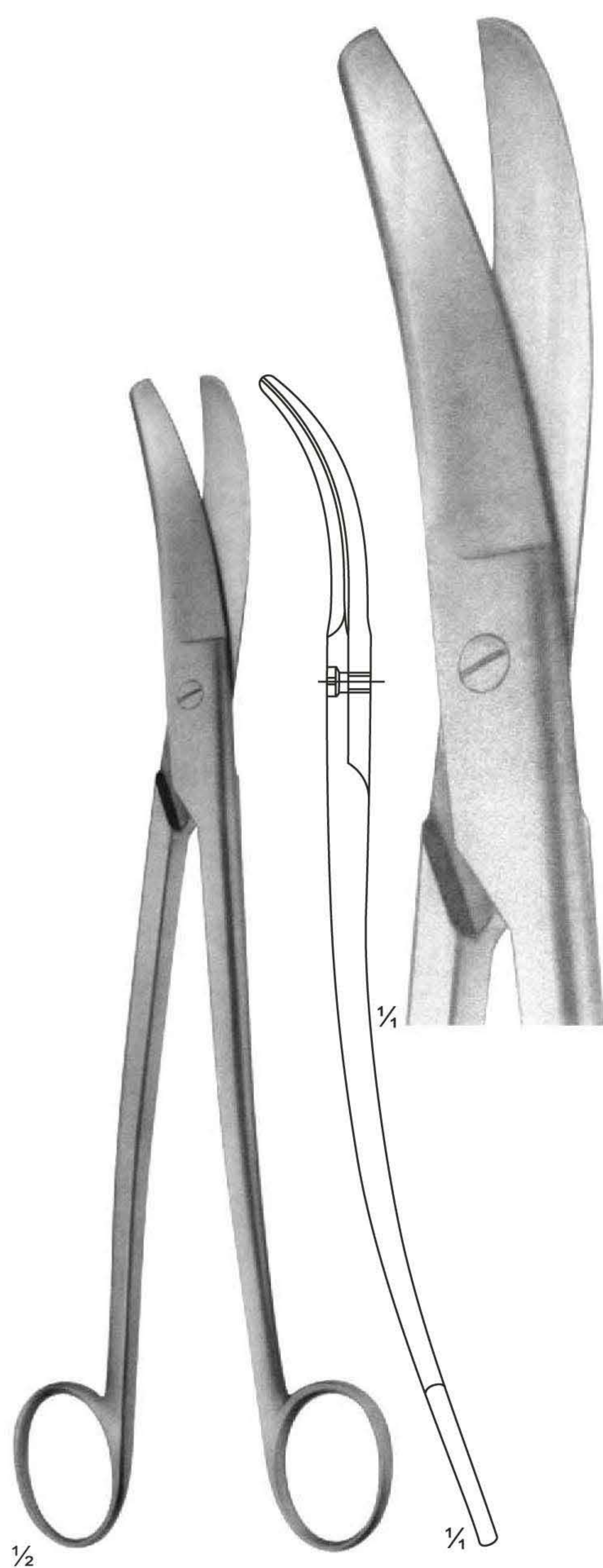

UG-615
SIEBOLD
Uterine Scissors
Size: 245 mm

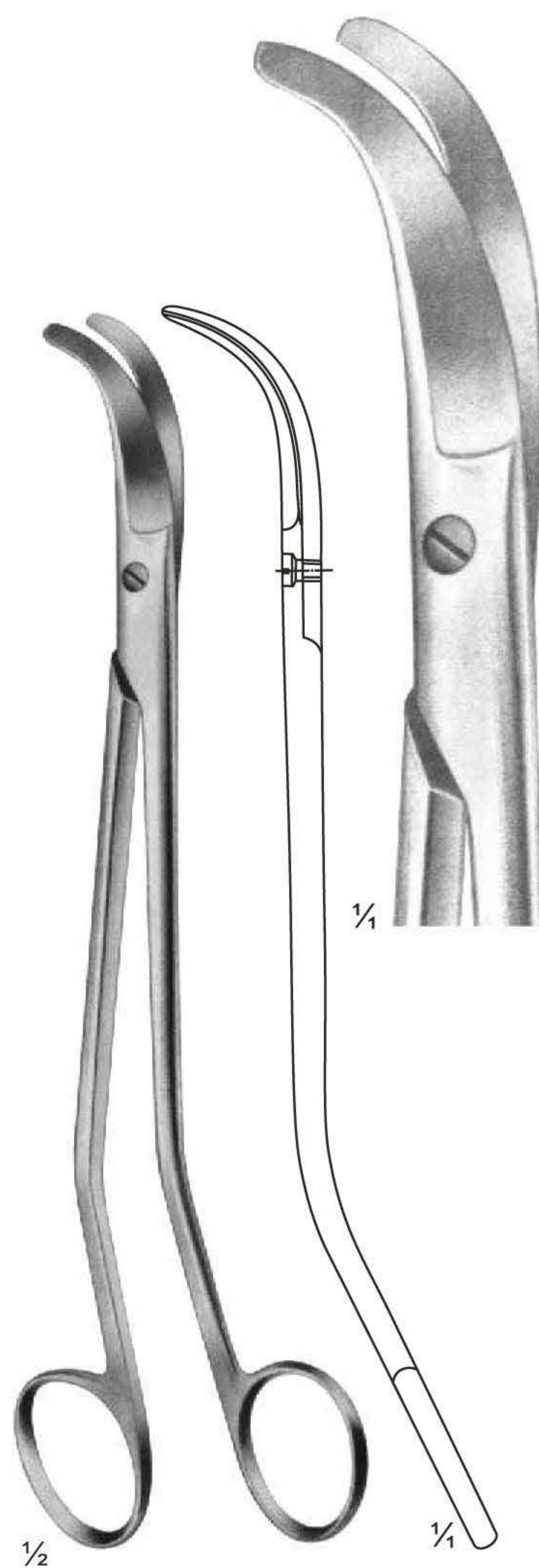

UG-617
BOZEMANN
Uterine Scissors
Size: 220 mm

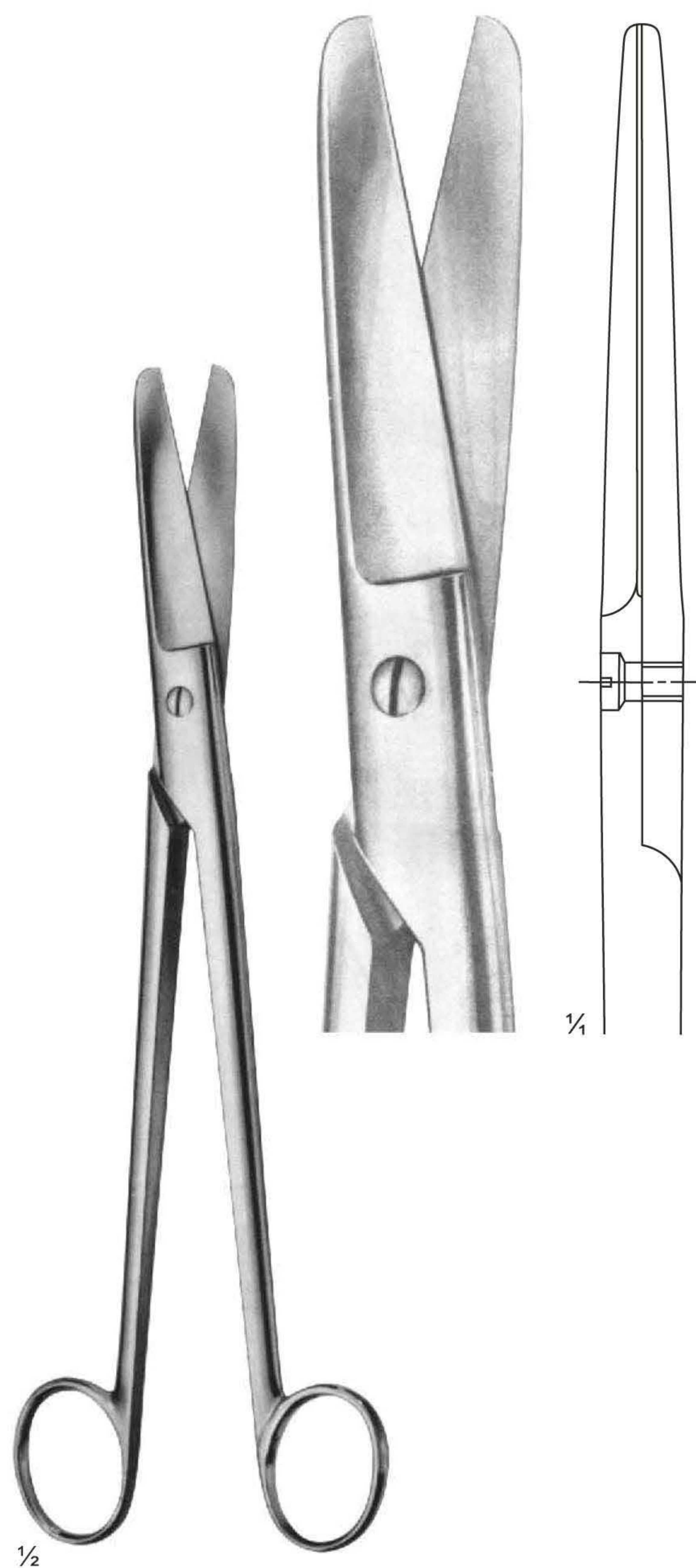

UG-618
SIMS-SIEBOLD
Uterine Scissors
Size: 250 mm

Operating and Gynaecology Scissors

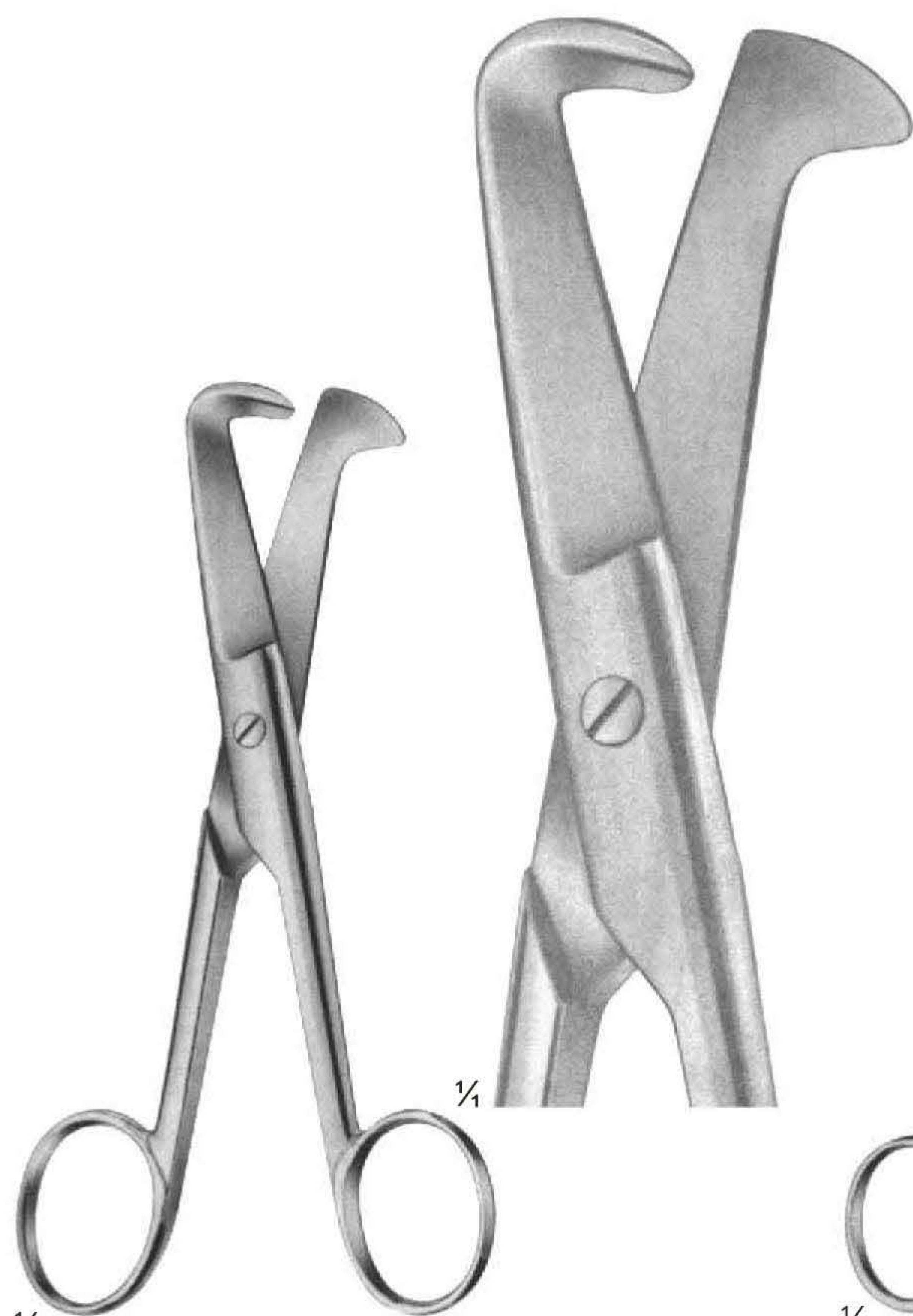

$\frac{1}{2}$
UG-619
 SCHUMACHER
 Umbilical Cord Scissors
 Size: 155 mm



$\frac{1}{2}$
UG-620
 Umbilical Cord Scissors
 Size: 105 mm

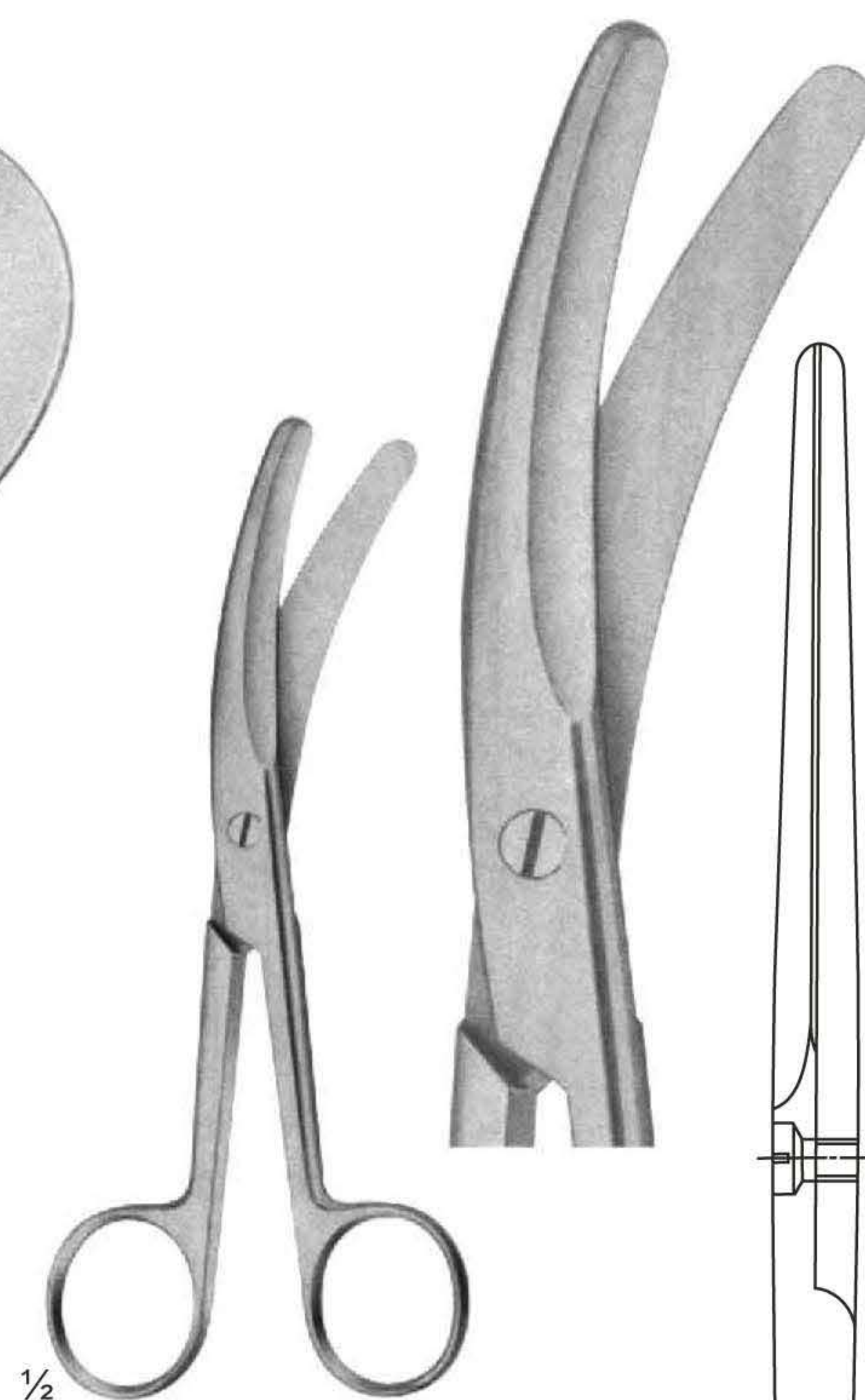

$\frac{1}{2}$
UG-623
 Umbilical Cord Scissors

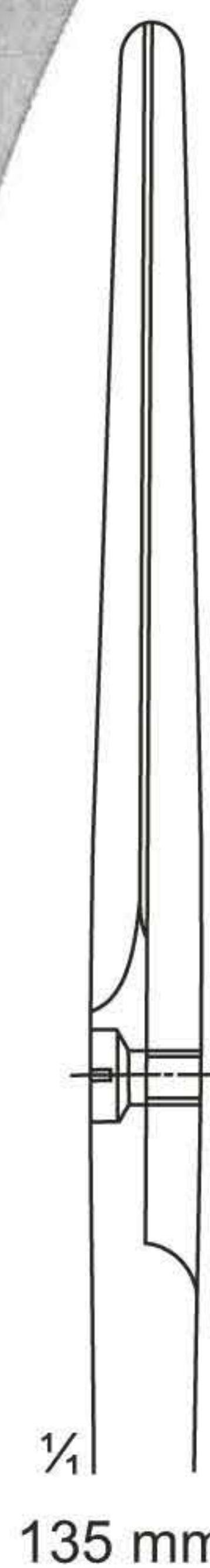

$\frac{1}{4}$
 135 mm



$\frac{1}{2}$
UG-624
 BRAUN-STADLER
 Empisiotomy Scissors



$\frac{1}{2}$
UG-626
 DAMMSCHERE
 Empisiotomy Scissors
 240 mm

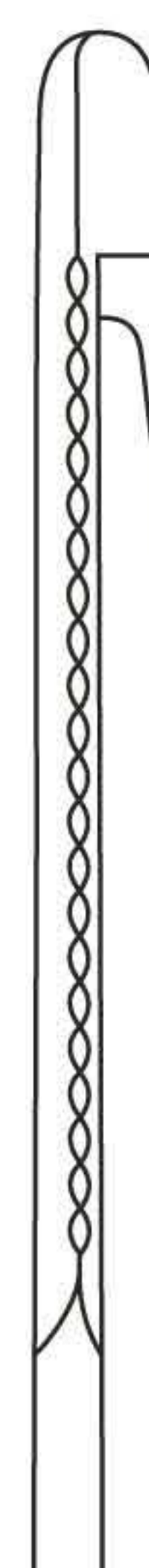

Bowel Scissors, Cartilage Scissors

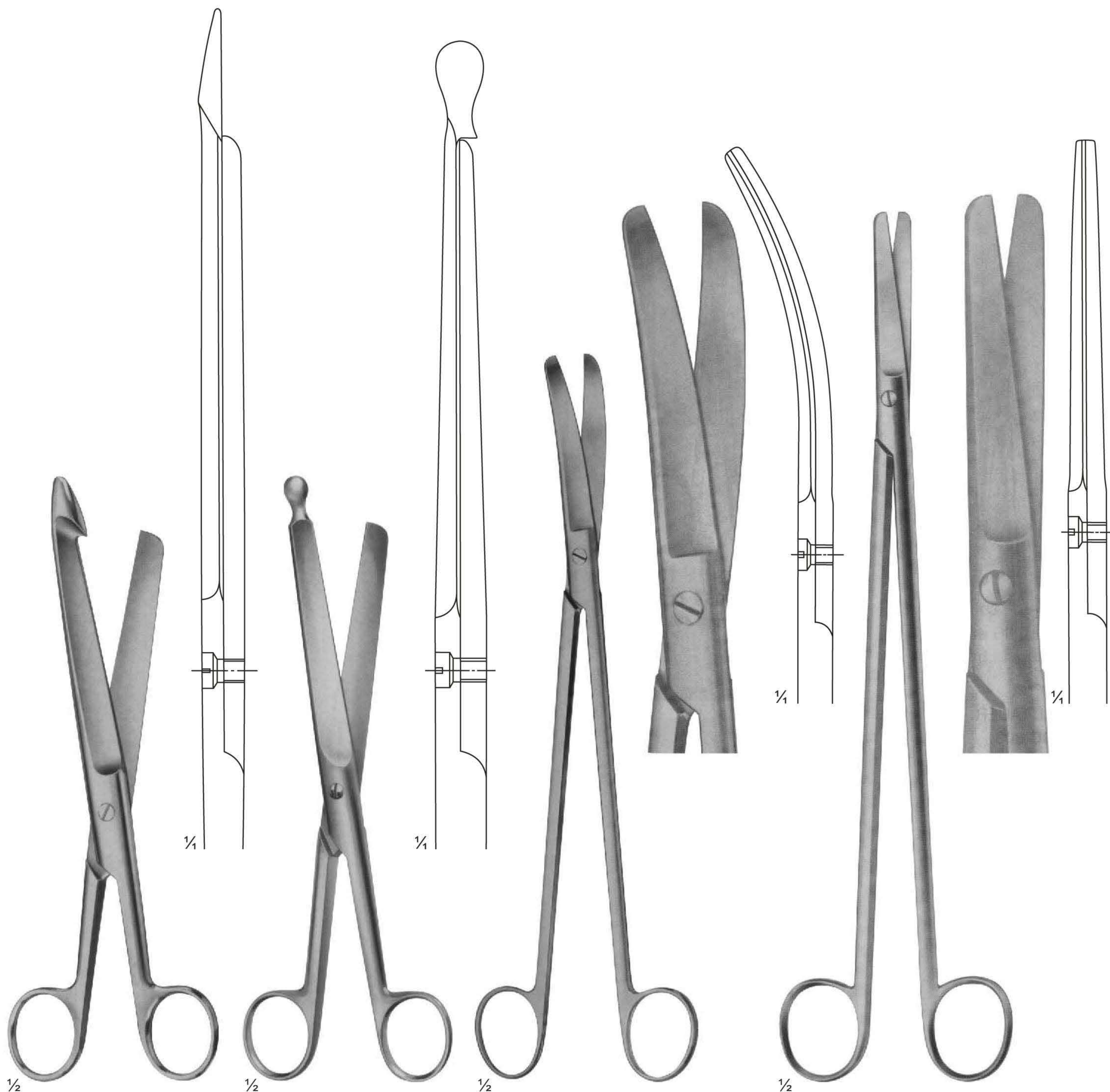

UG-628
DAMMSCHERE
Bowel Scissors
Size: 210 mm

UG-629
DAMMSCHERE
Bowel Scissors
Size: 210 mm

UG-630
LLOYD-DAVIES
(GOLIGHER'S)
Rectal Scissors
Size: 255 mm

UG-631
STELZNER
Rectal Scissors
Size: 310 mm

Ligature Scissors

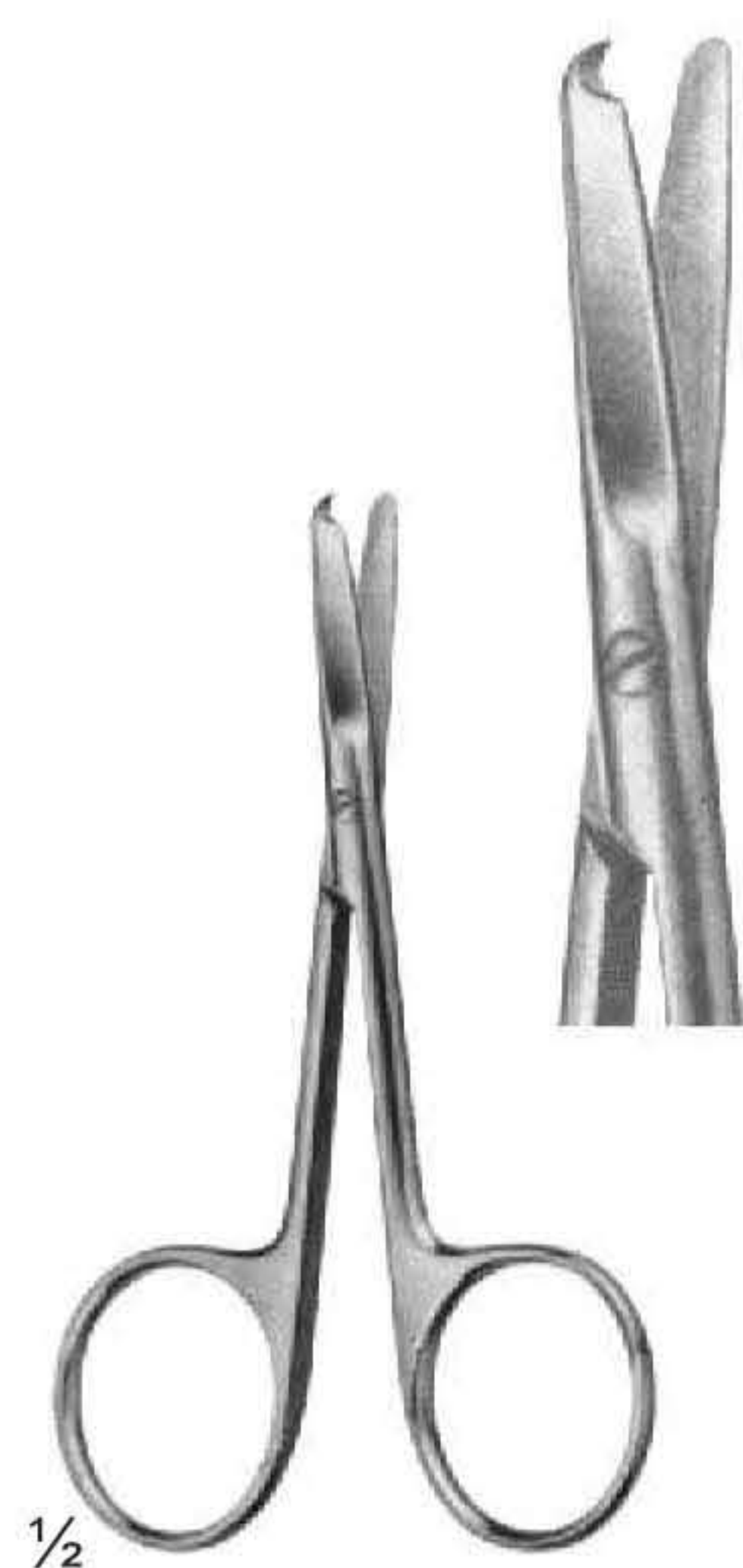

UG-633
SPENCER

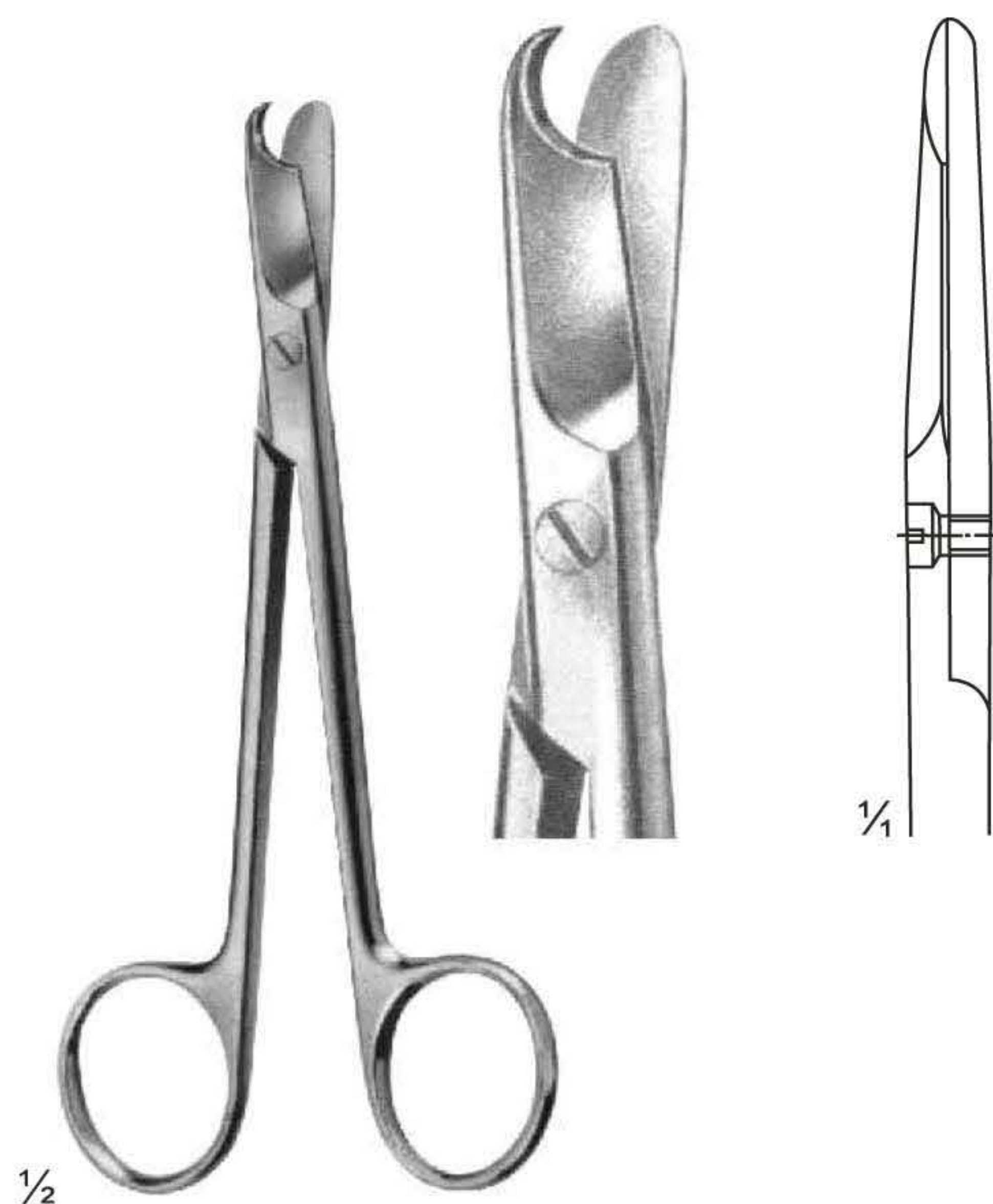

UG-635
LITTAUER
Size: 135 mm

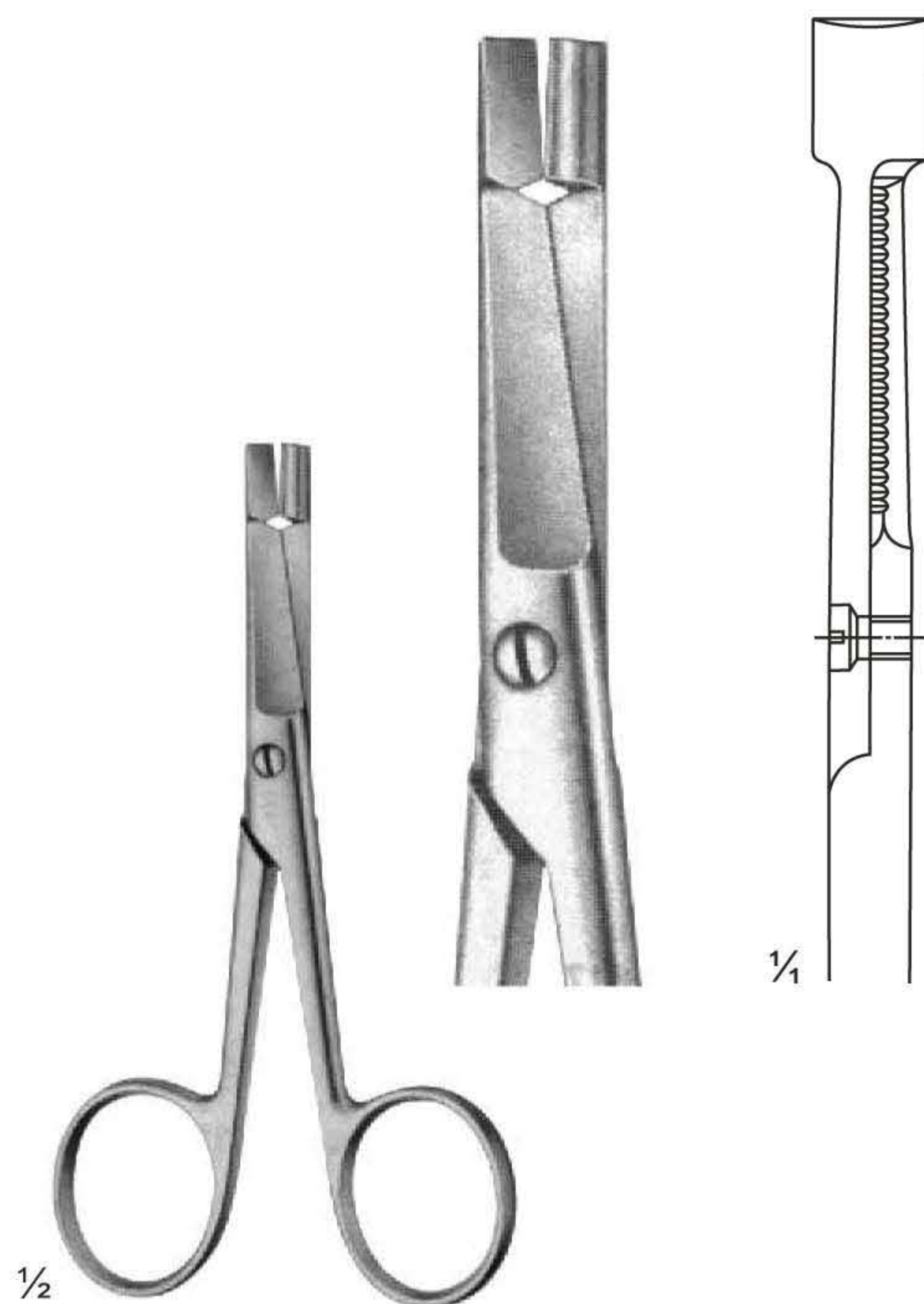

UG-636
EISELSBERG
Size: 115 mm

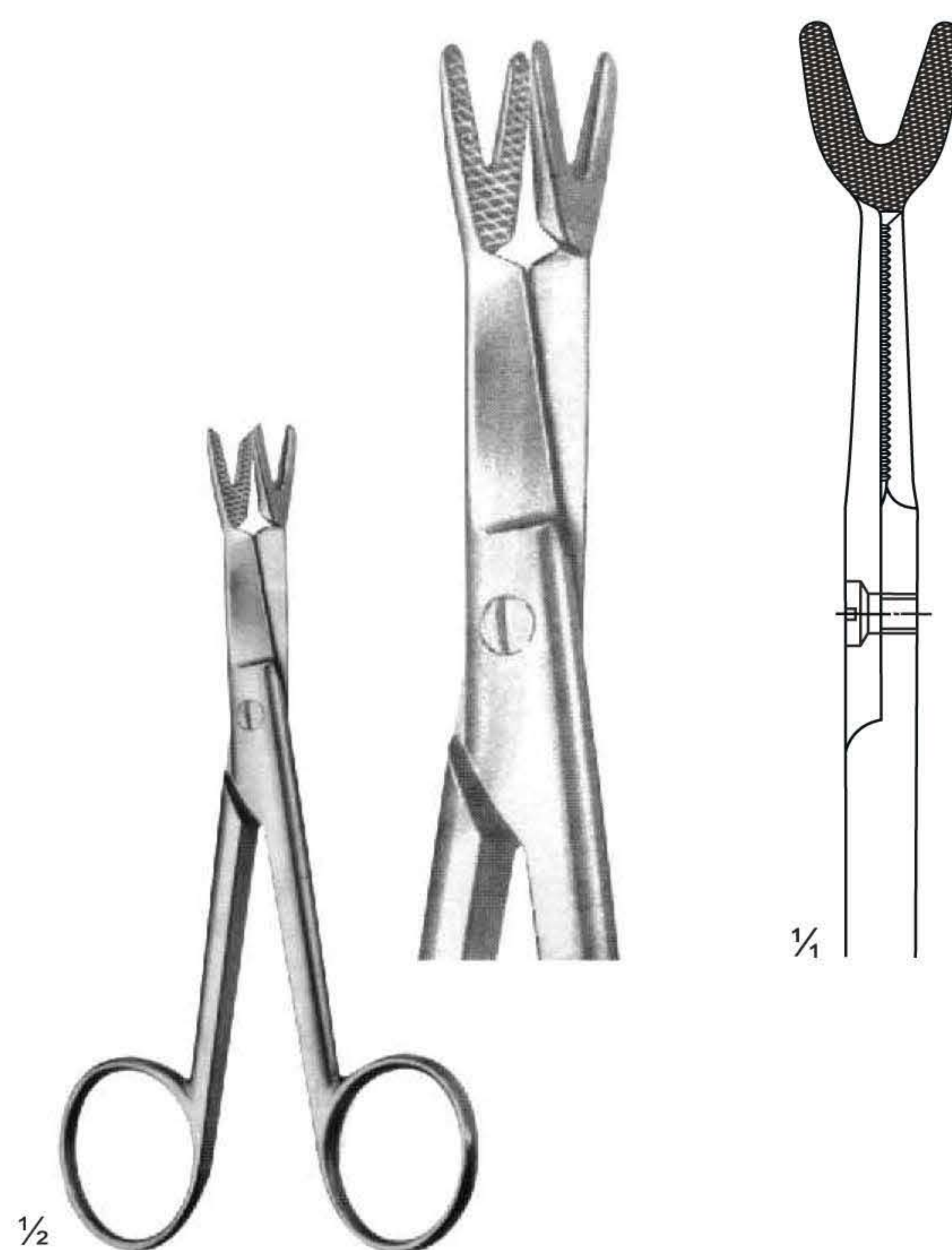

UG-638
SCHOEMAKER-LOTH
Size: 125 mm

Wire and Plate Scissors



UG-639
BEEBE
Size: 110 mm

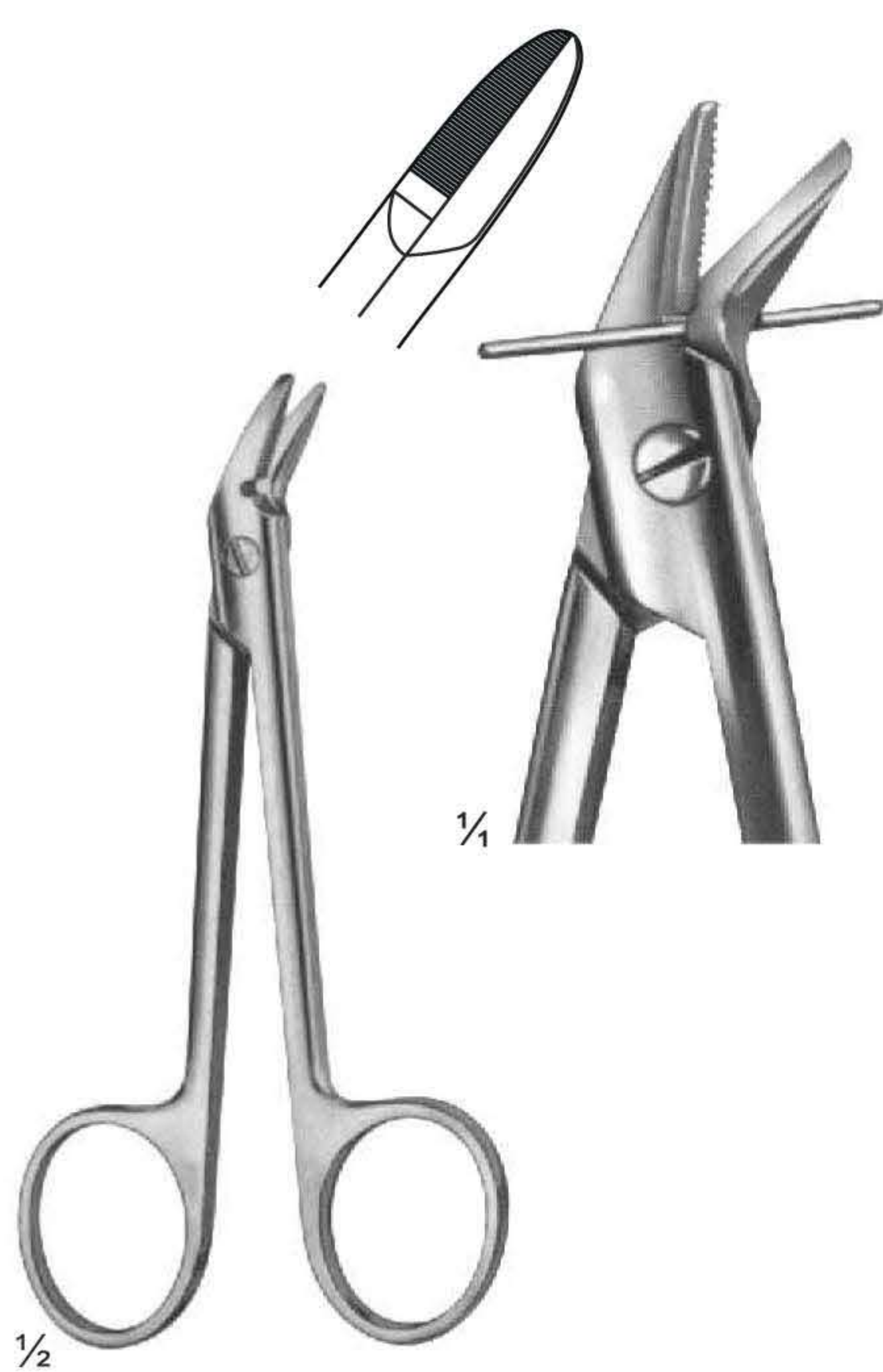

UG-642
1 Blade Serrated
Size: 120 mm

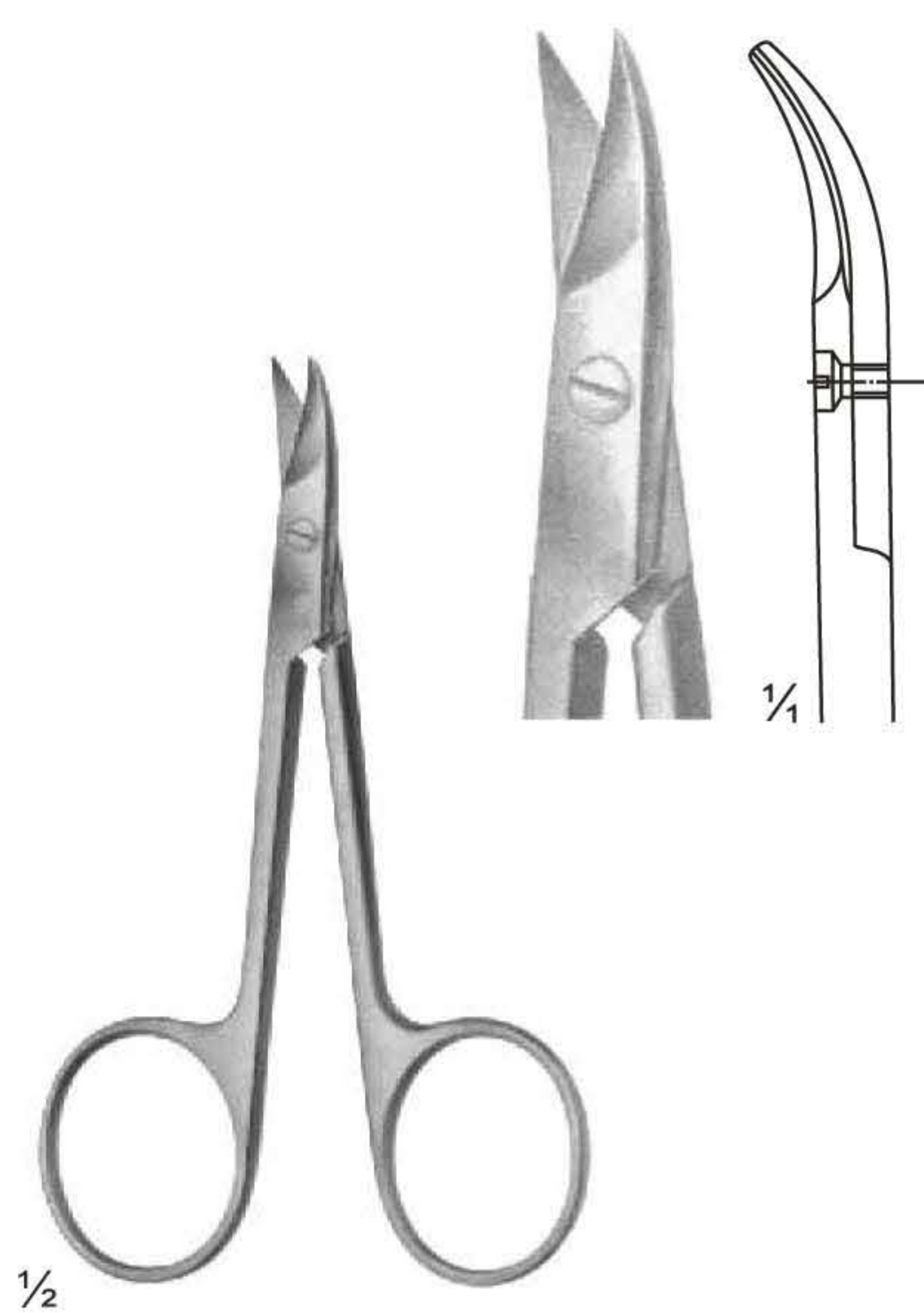

UG-644
STRACK
Size: 100 mm

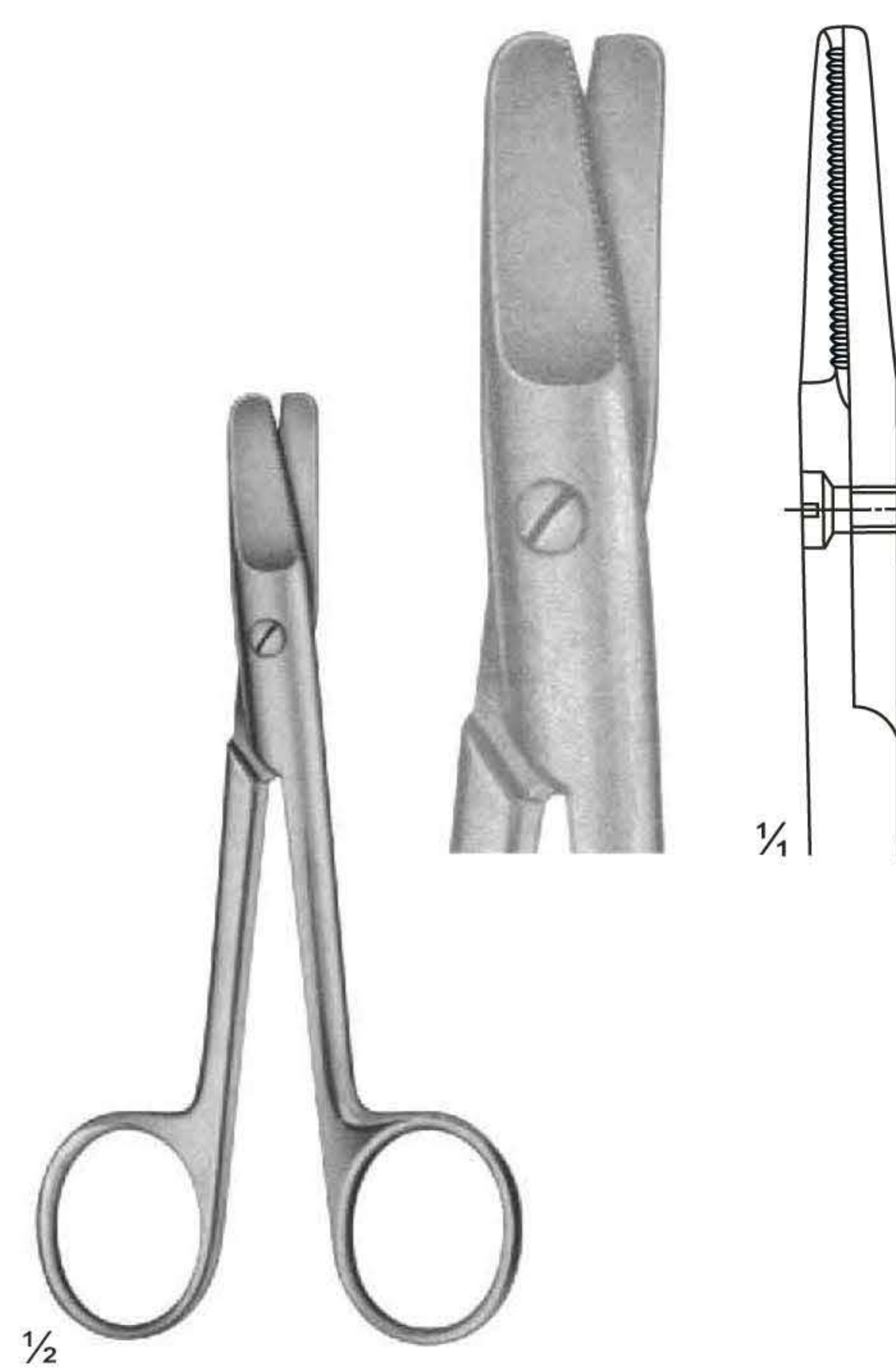

UG-646
HARVEY
Size: 125 mm

Wire and Plate Scissors

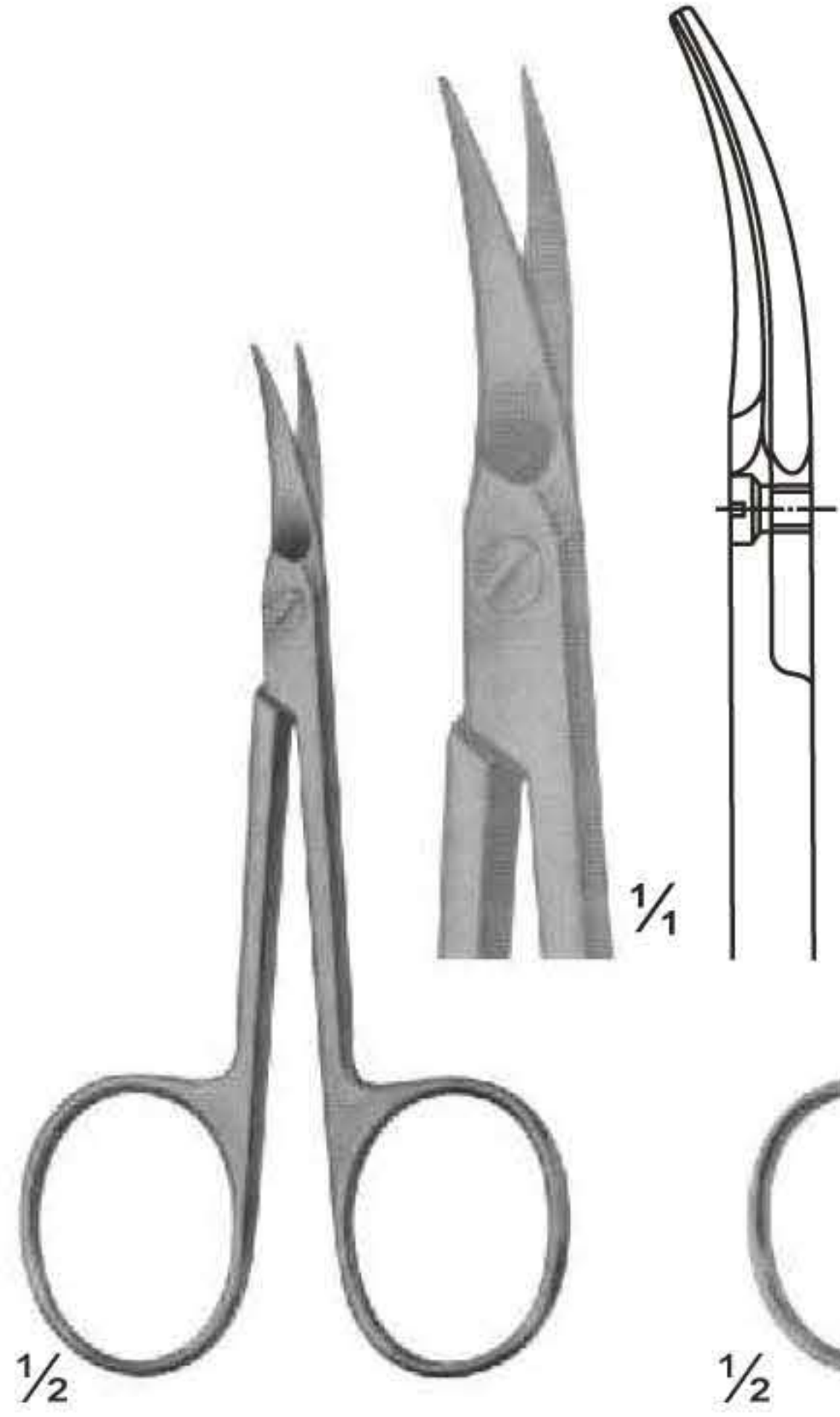

UG-649
NAIL SCISSORS
Size: 90 mm

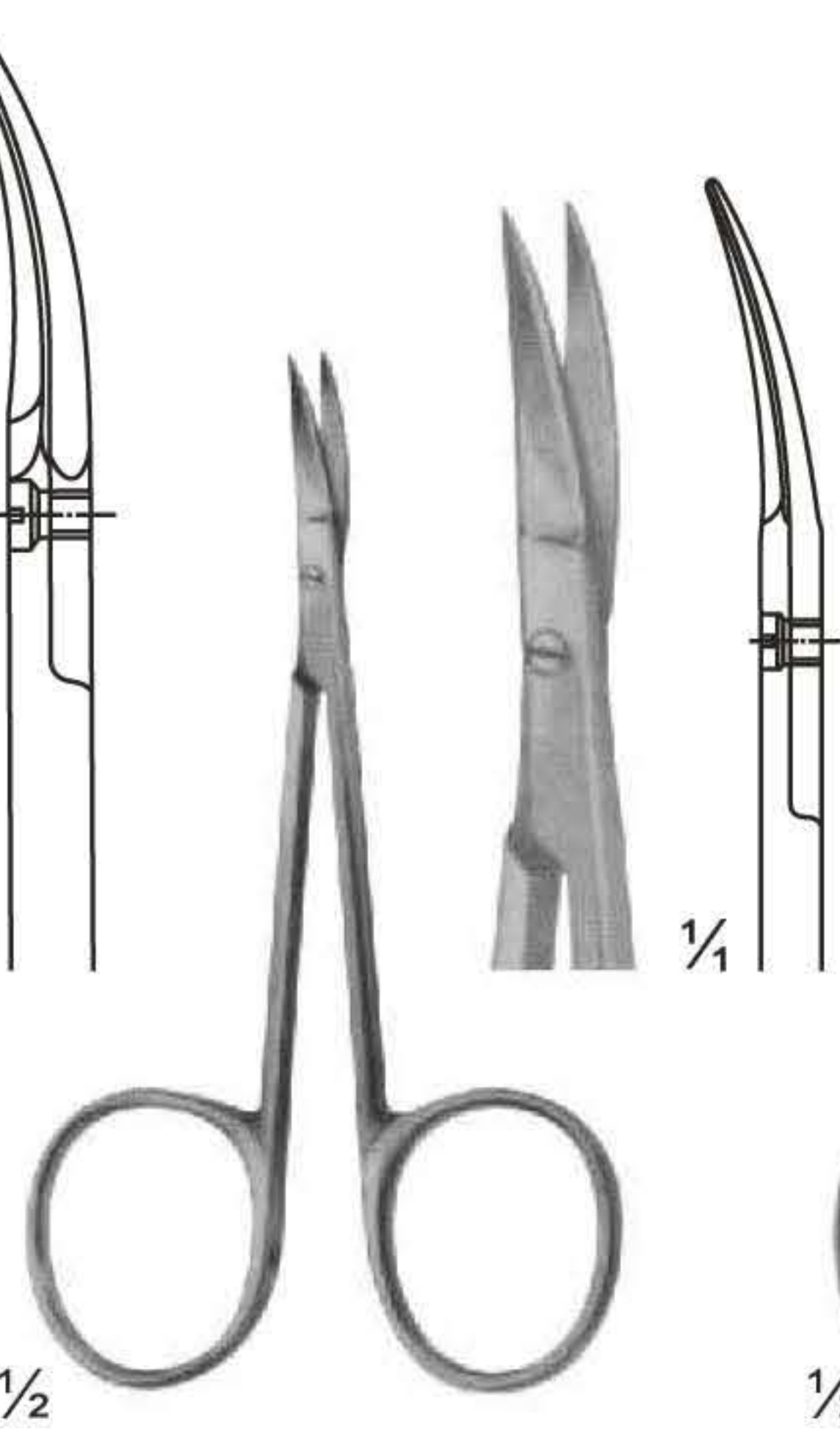

UG-650
NAIL SCISSORS
Size: 90 mm

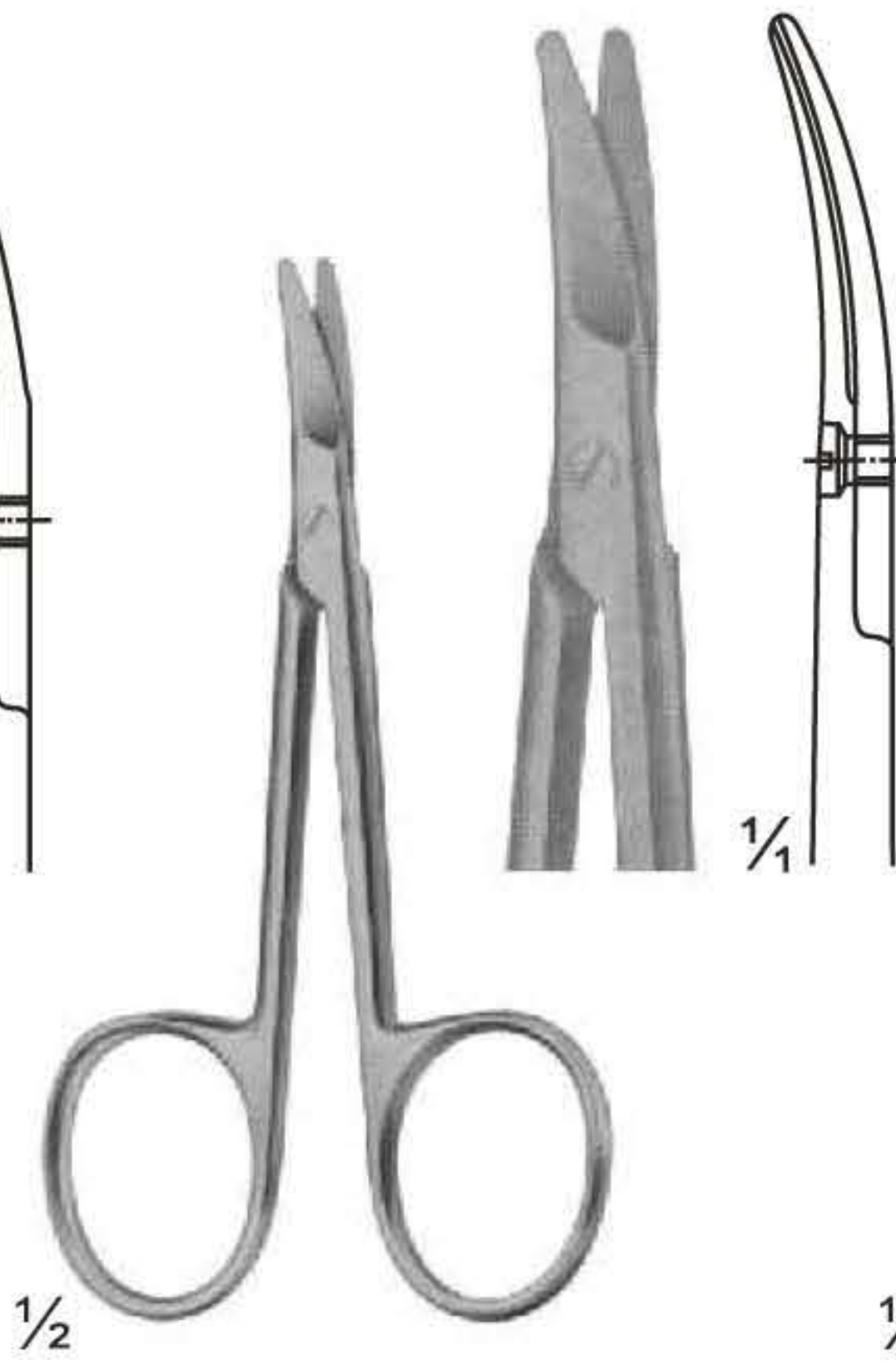

UG-651
BABY NAIL SCISSORS
Size: 85 mm

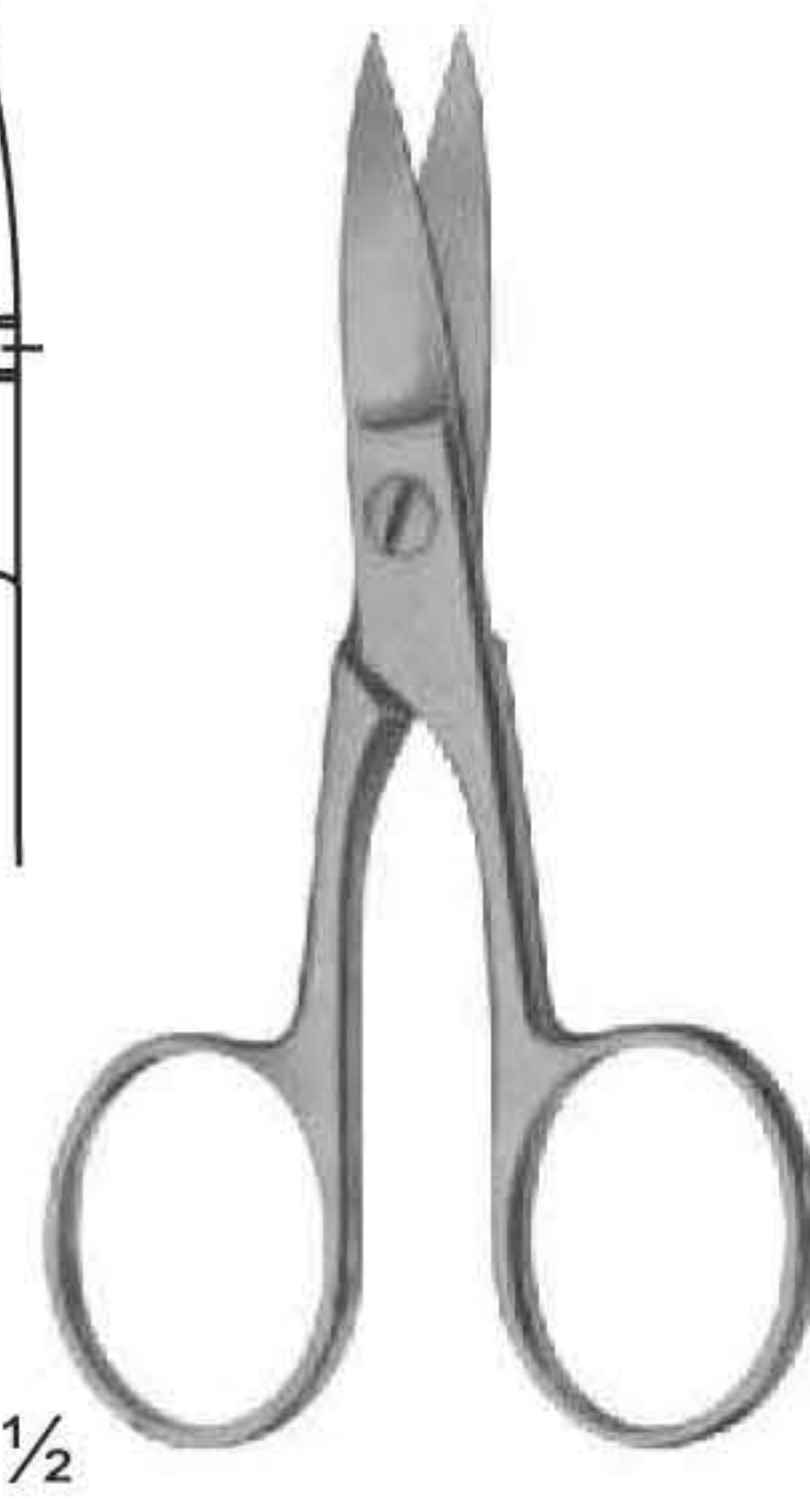

UG-656
NAIL SCISSORS
Size: 90 mm



UG-657
NAIL SCISSORS
Size: 90 mm

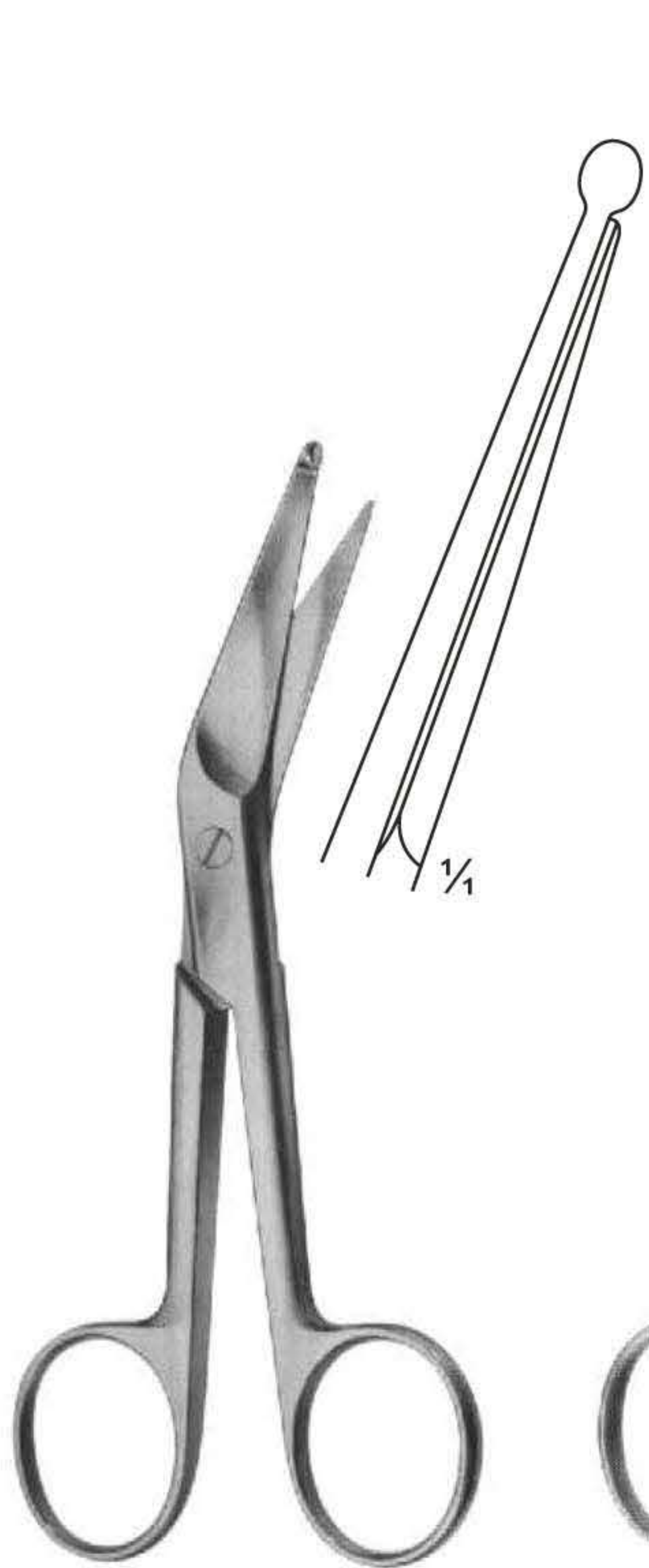

UG-658
KNOWLES
Size: 140 mm

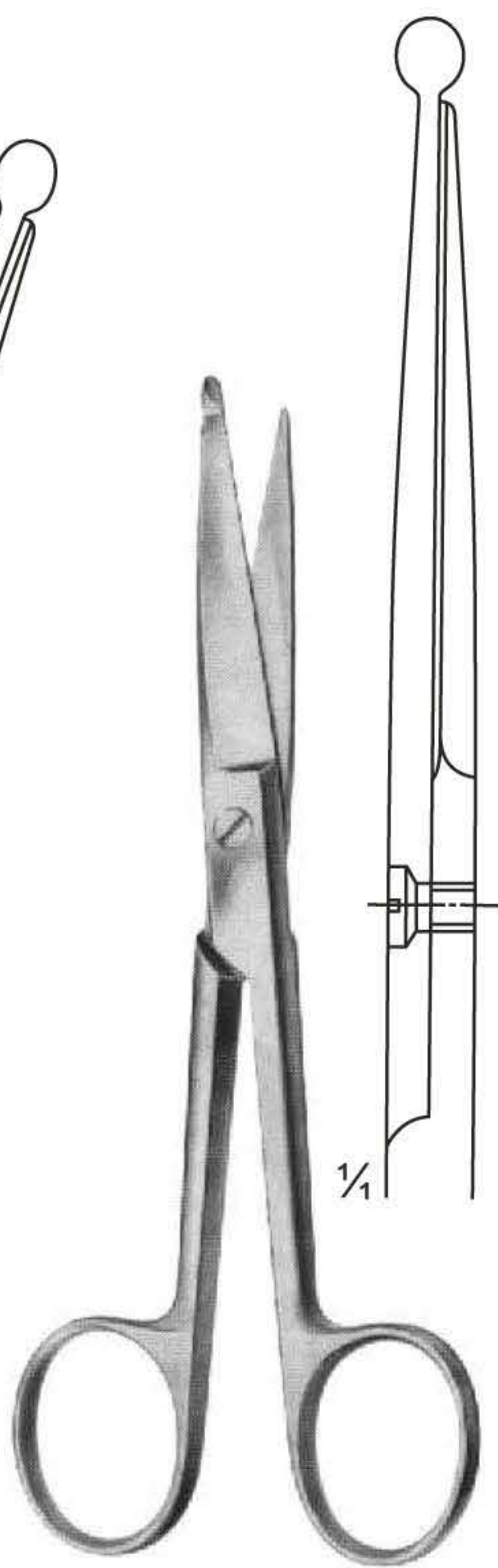

UG-659
KNOWLES
Size: 145 mm

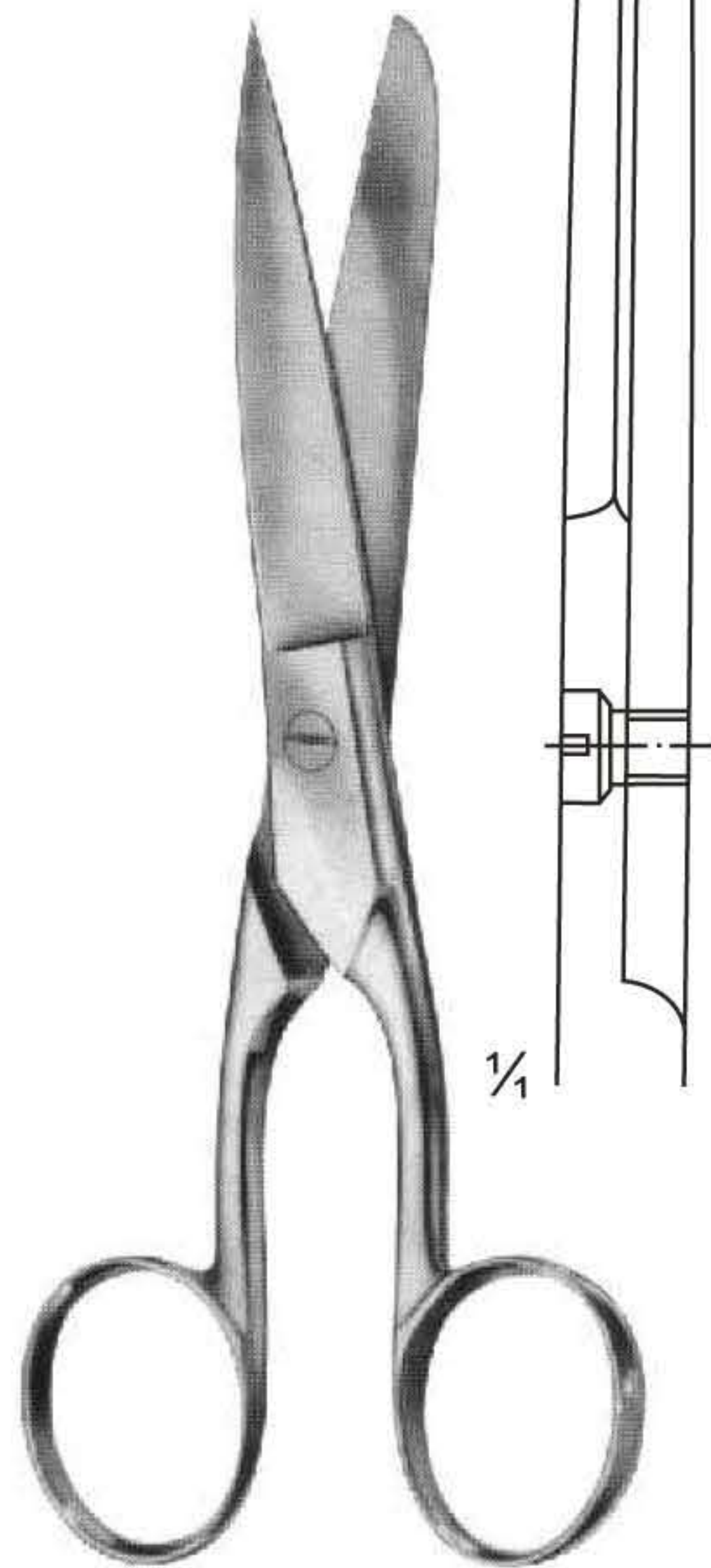

UG-660
Size: 150 mm

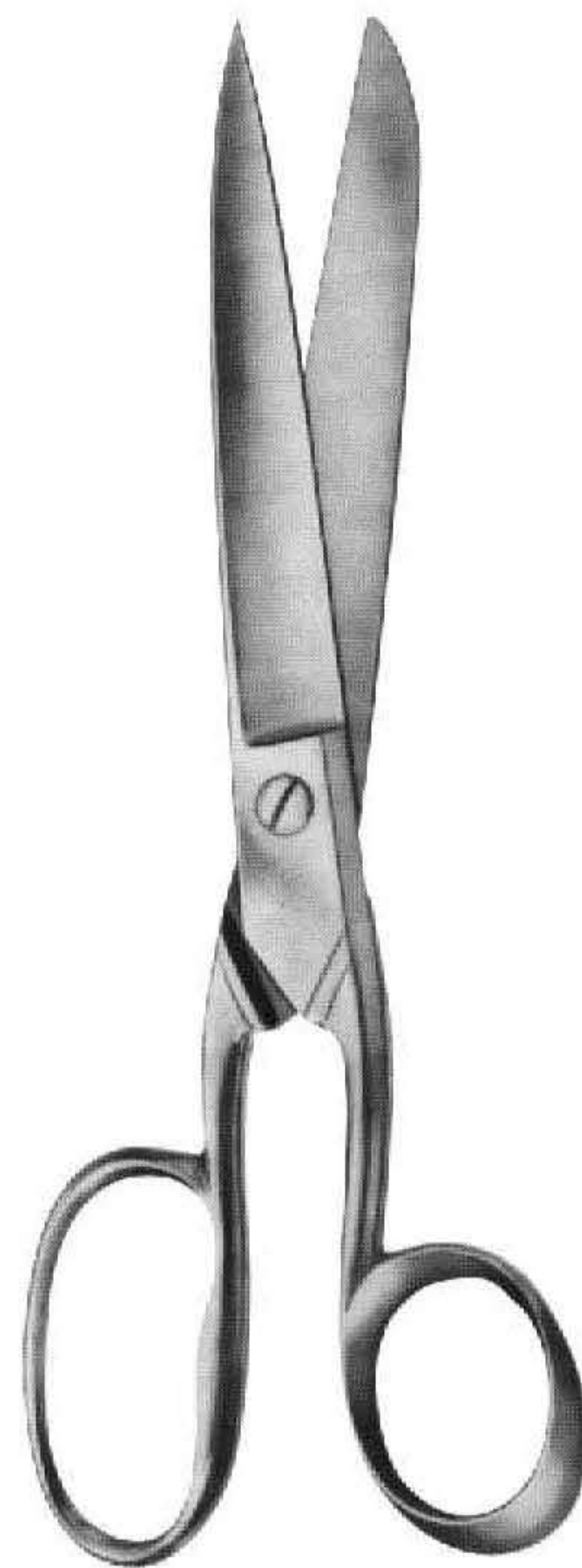

UG-661
SMITH
Size: 180 mm

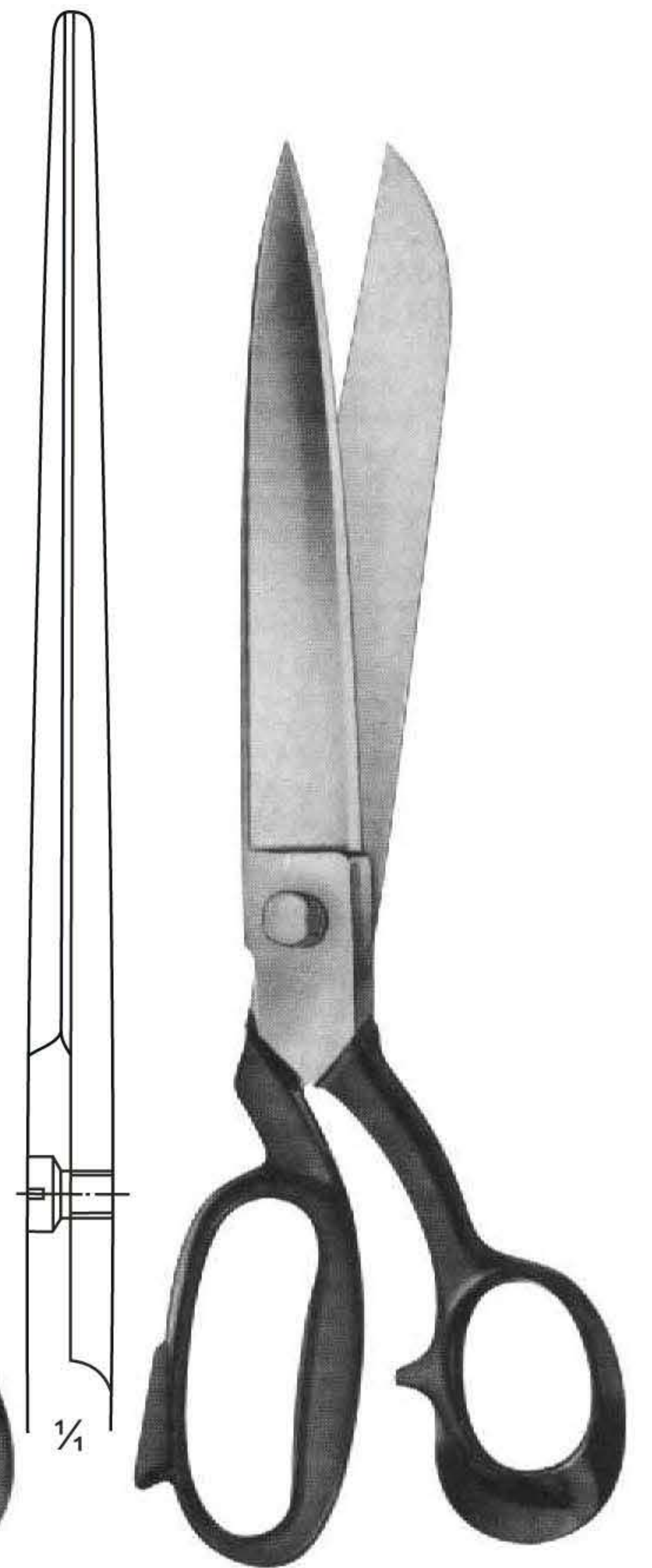

UG-662
Size: 310 mm

Bandage and Cloth Scissors

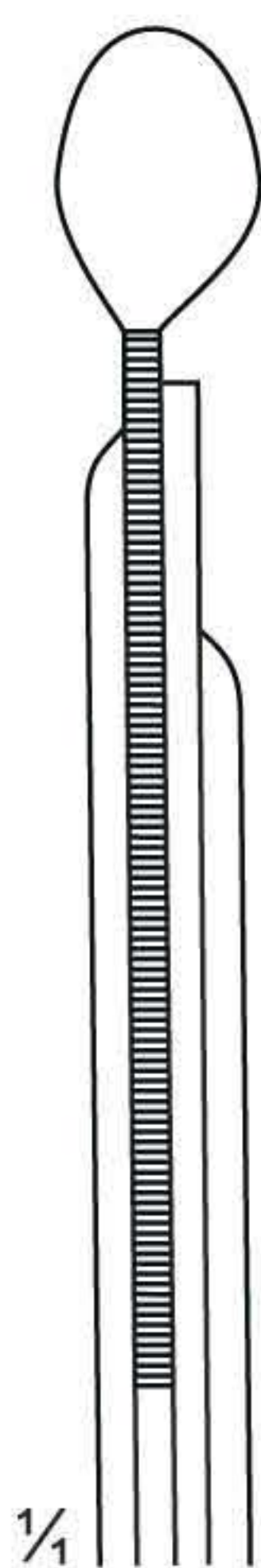

UG-664
UNIVERSAL AND BANDAGE SCISSORS
180 mm

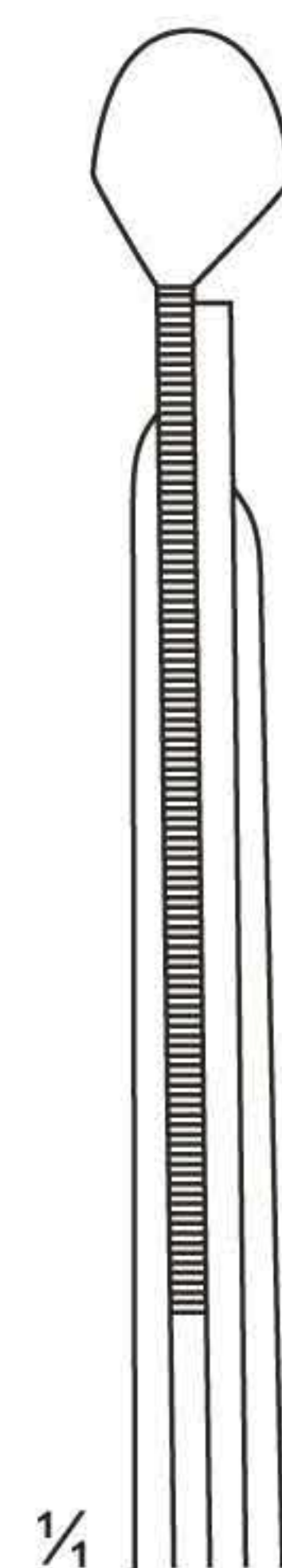
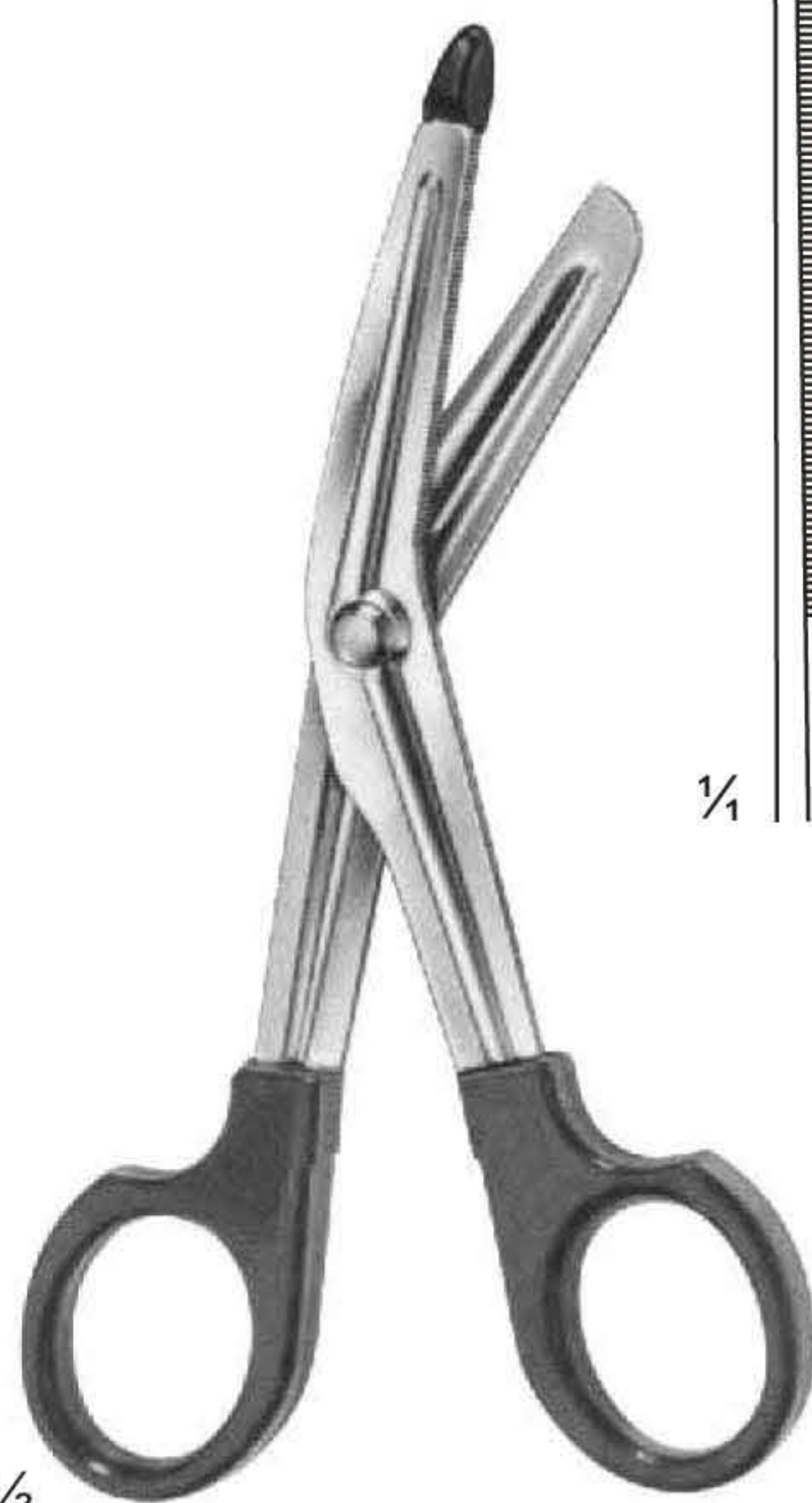

UG-665
LISTER
Size: 145 mm

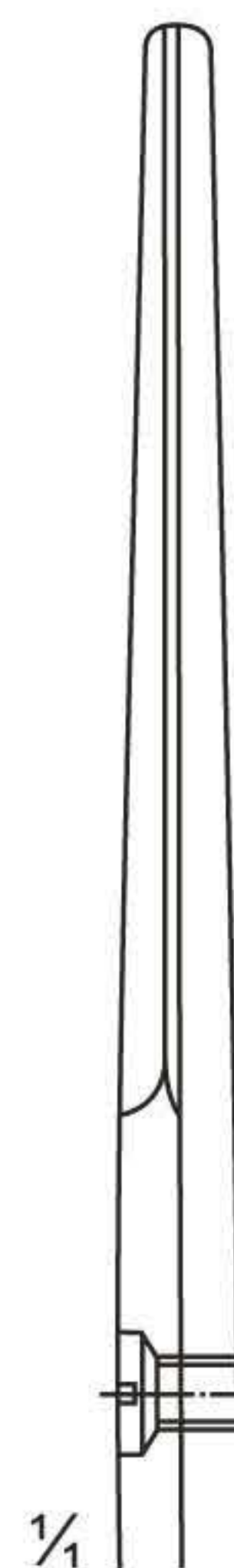
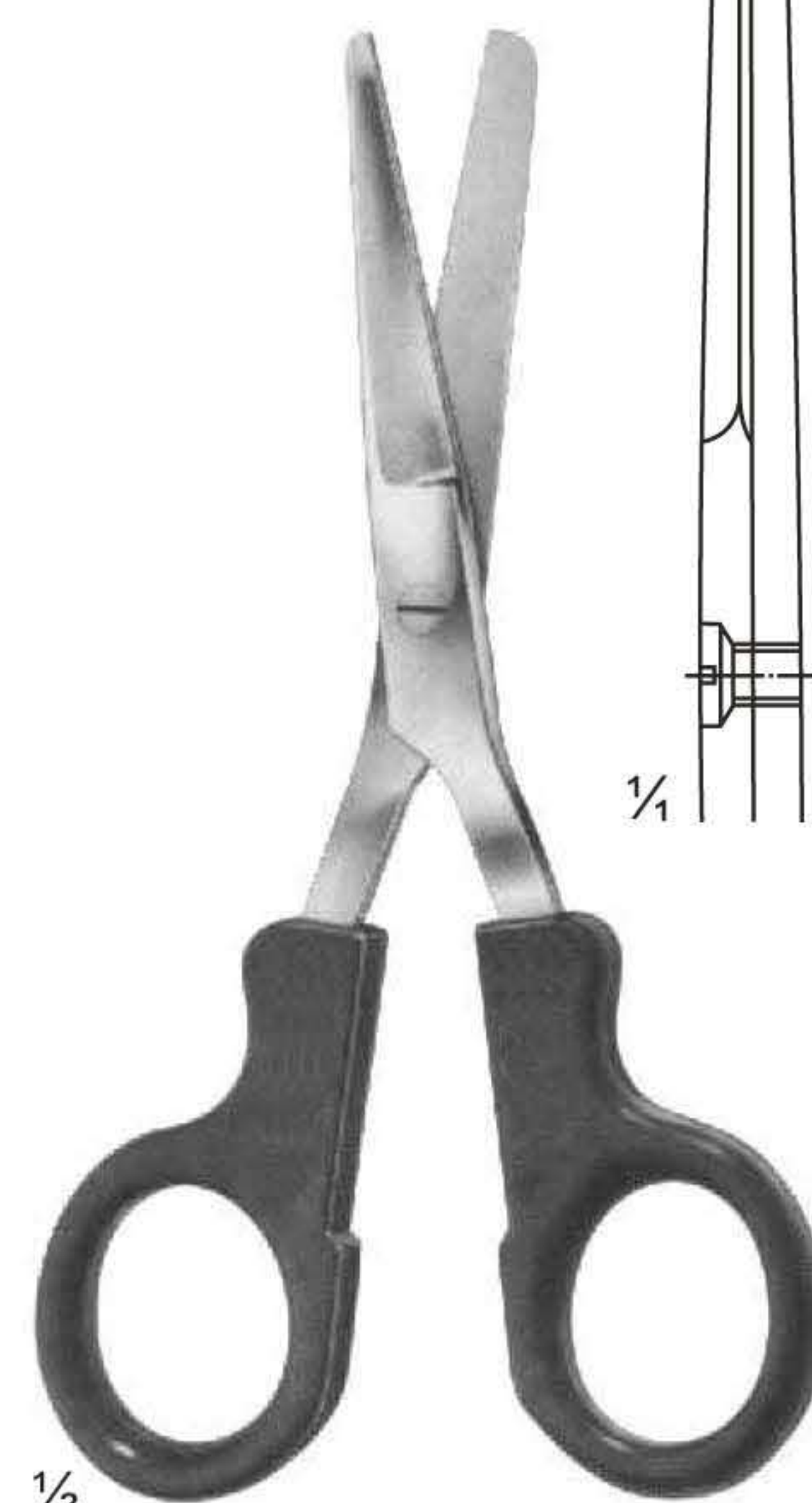

UG-666
LISTER
Size: 145 mm



UG-667
LISTER



UG-672
LISTER

Bandage, Cloth and Plaster Scissors

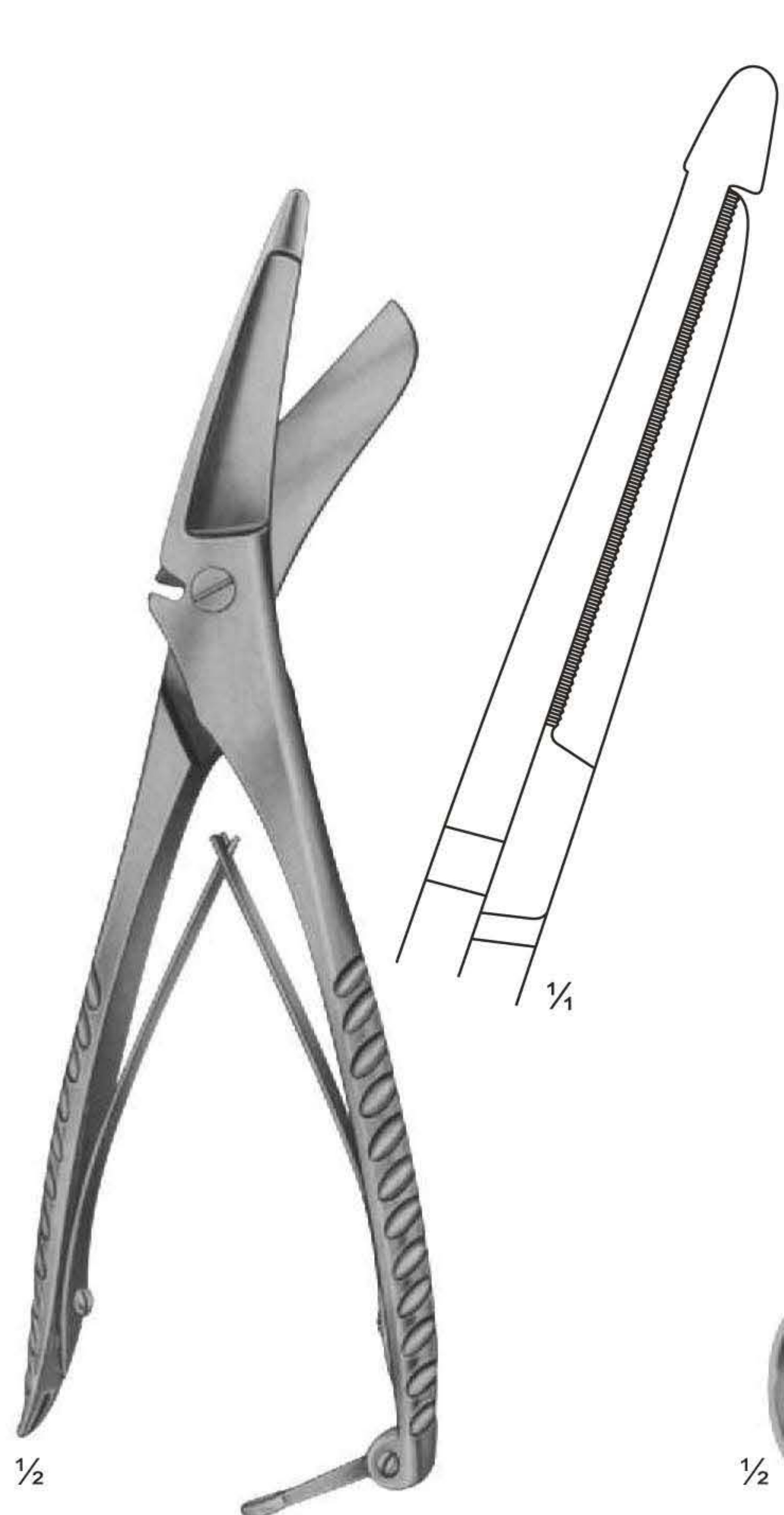

UG-677
CLOTH SCISSORS
205 mm

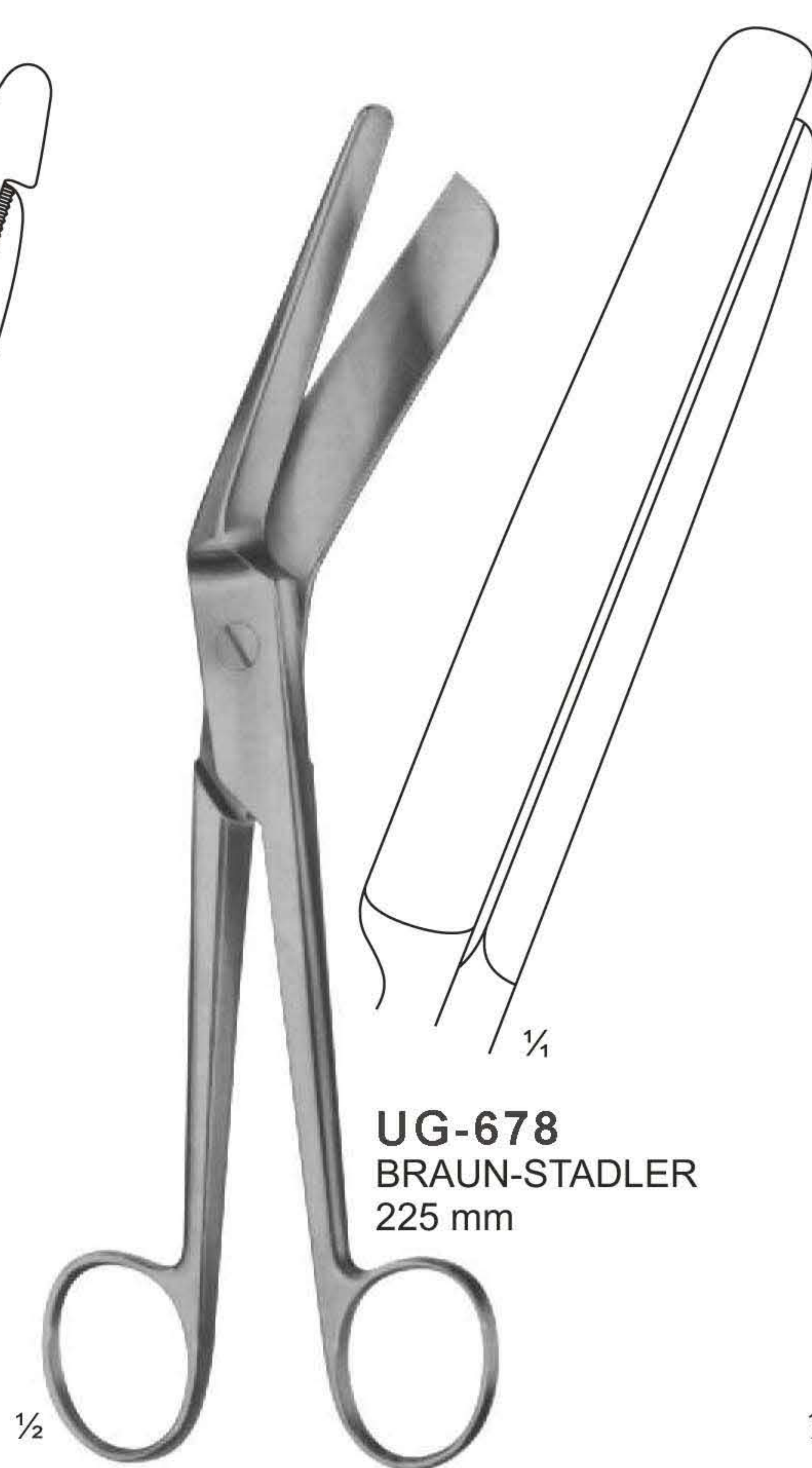

UG-678
BRAUN-STADLER
225 mm

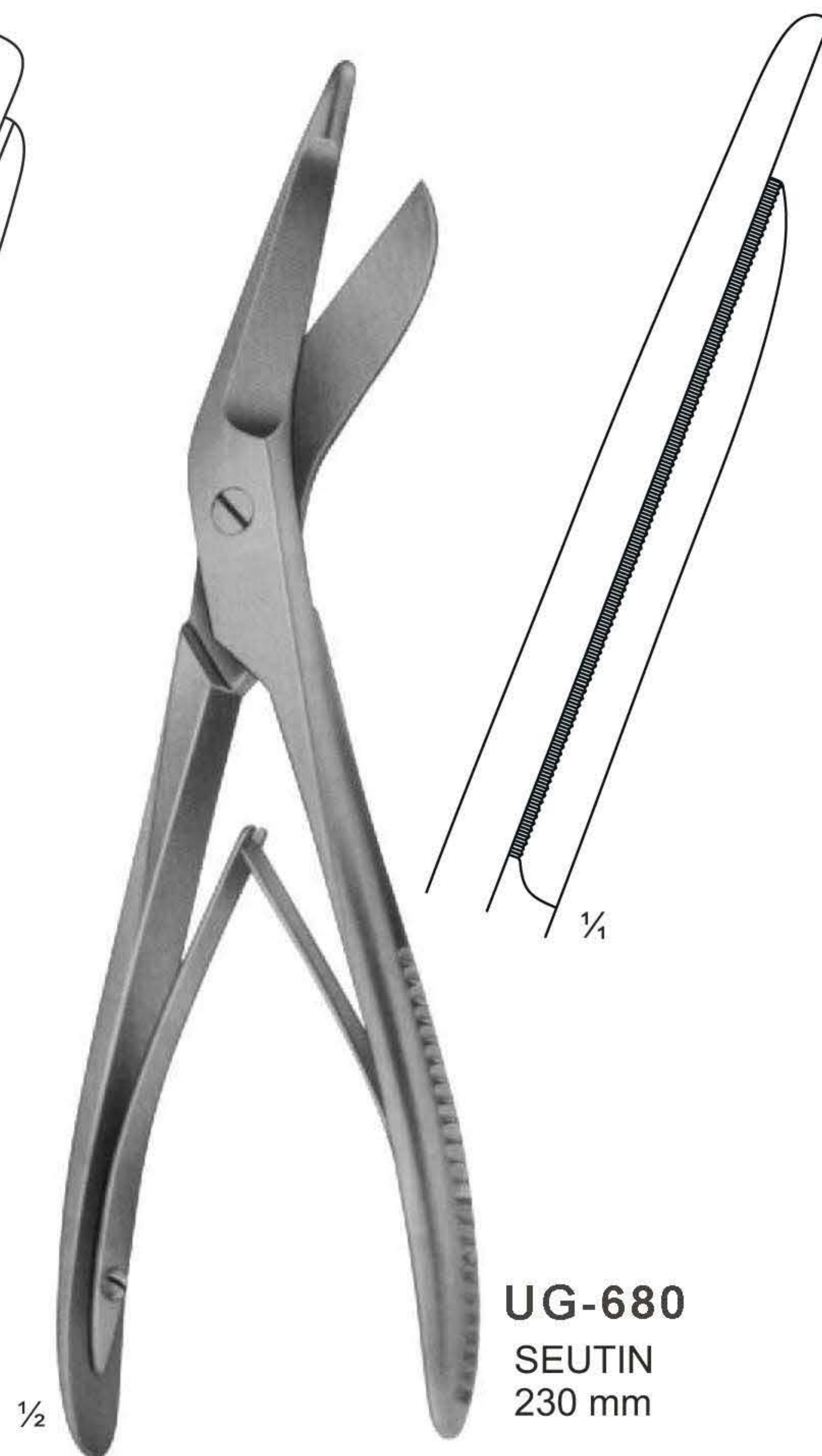

UG-680
SEUTIN
230 mm



UG-681
ESMARCH

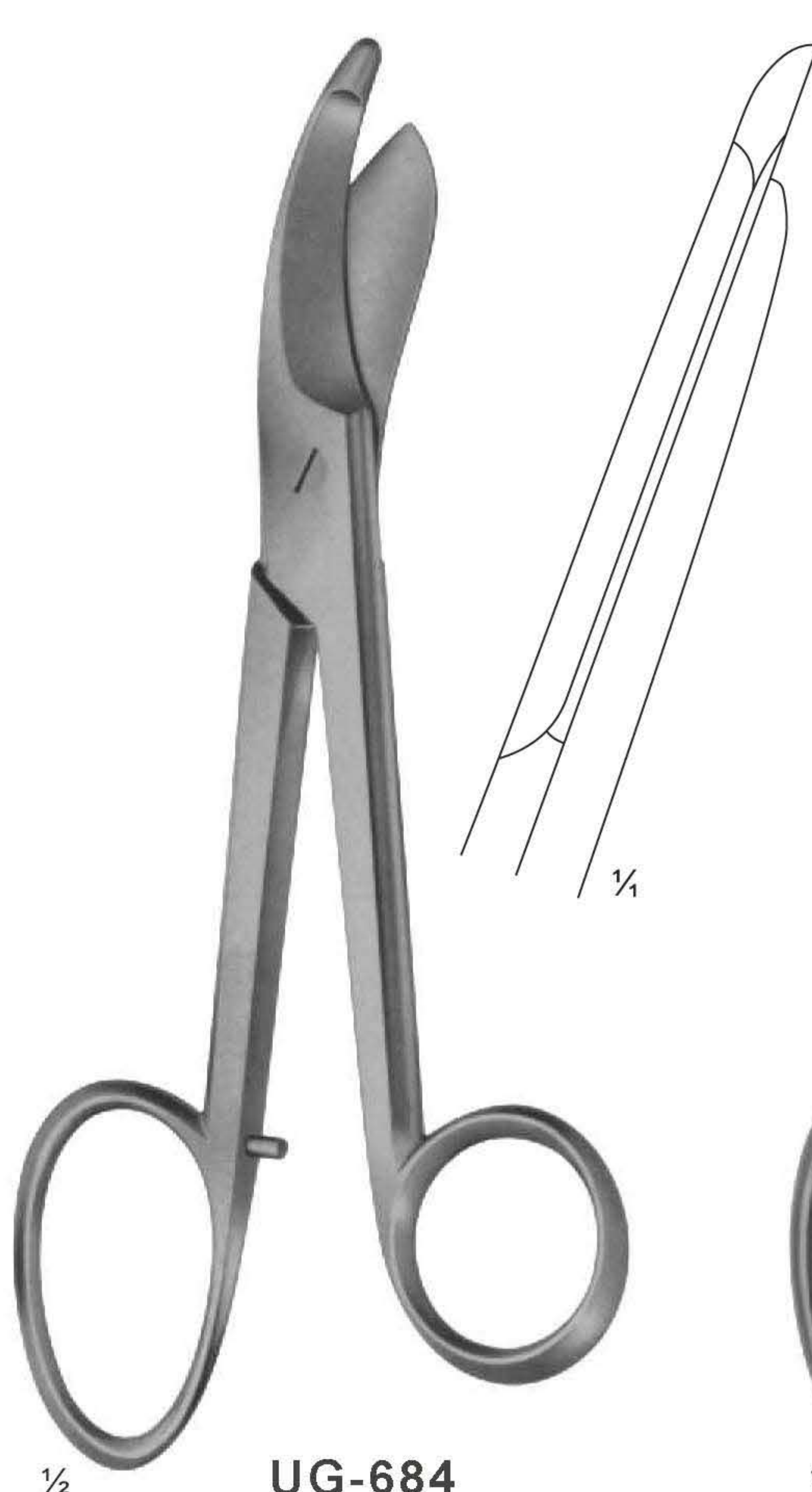

UG-684
BRUNS
235 mm

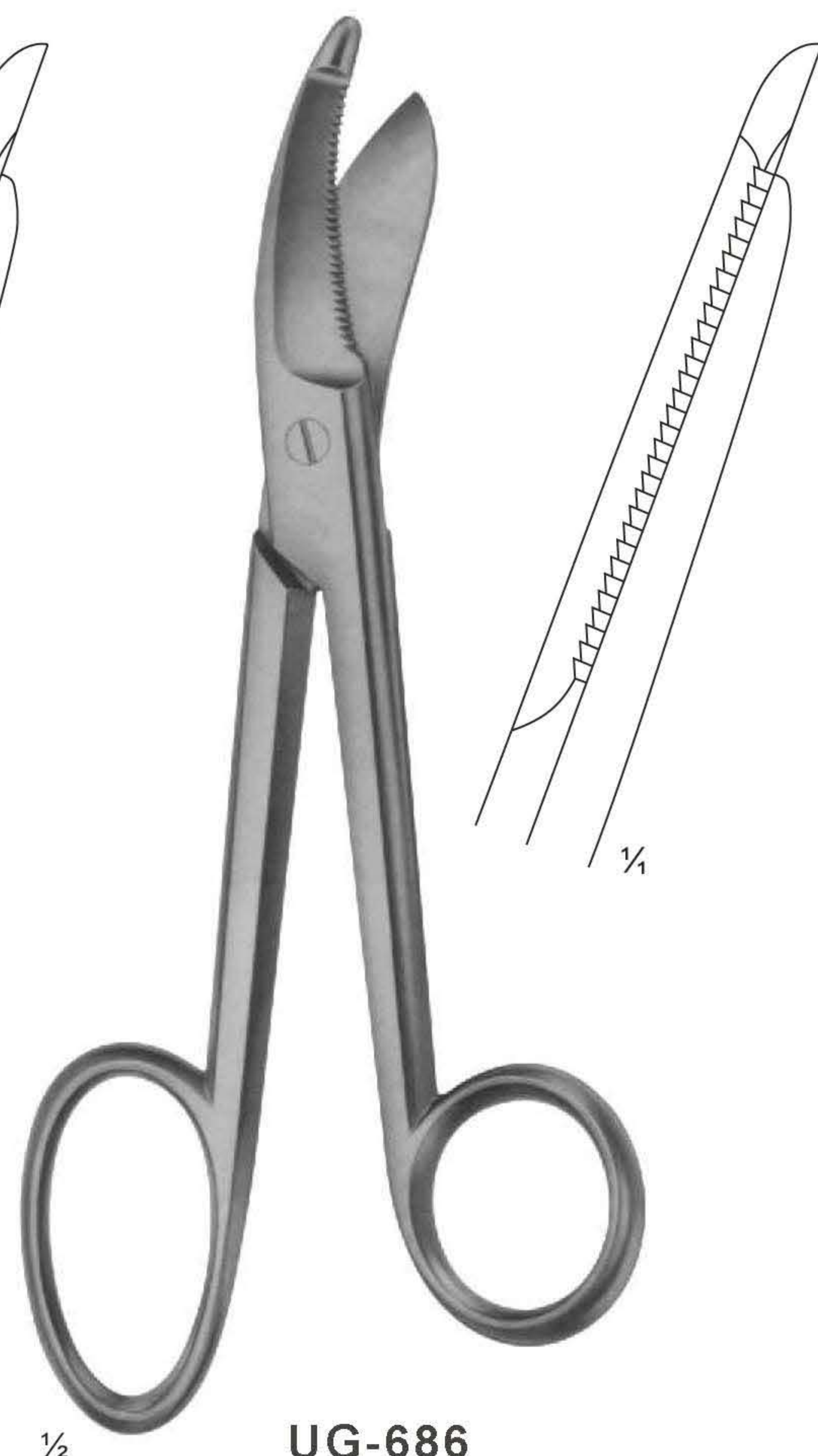

UG-686
BRUNS
235 mm

Micro Forceps, Jeweler Types

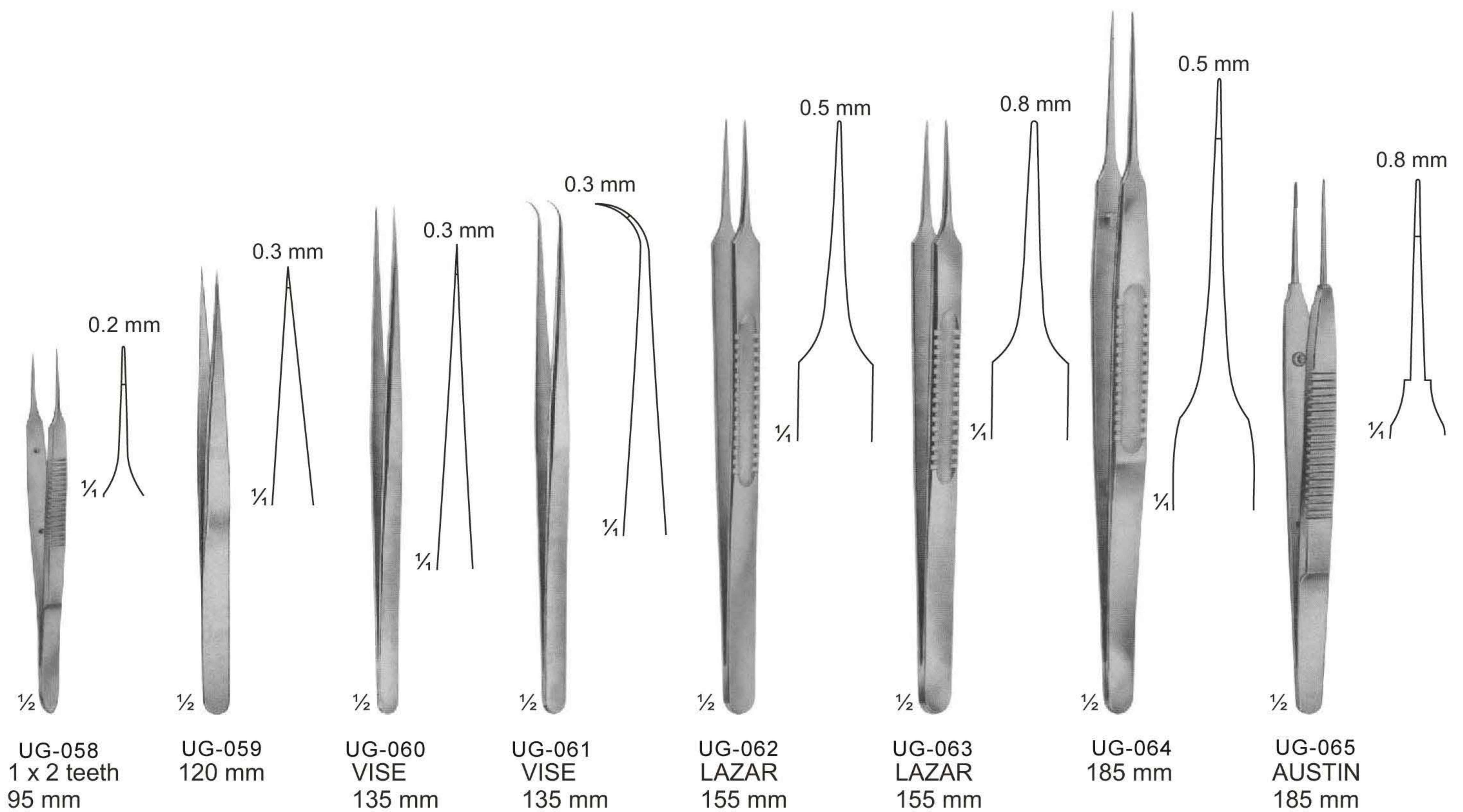
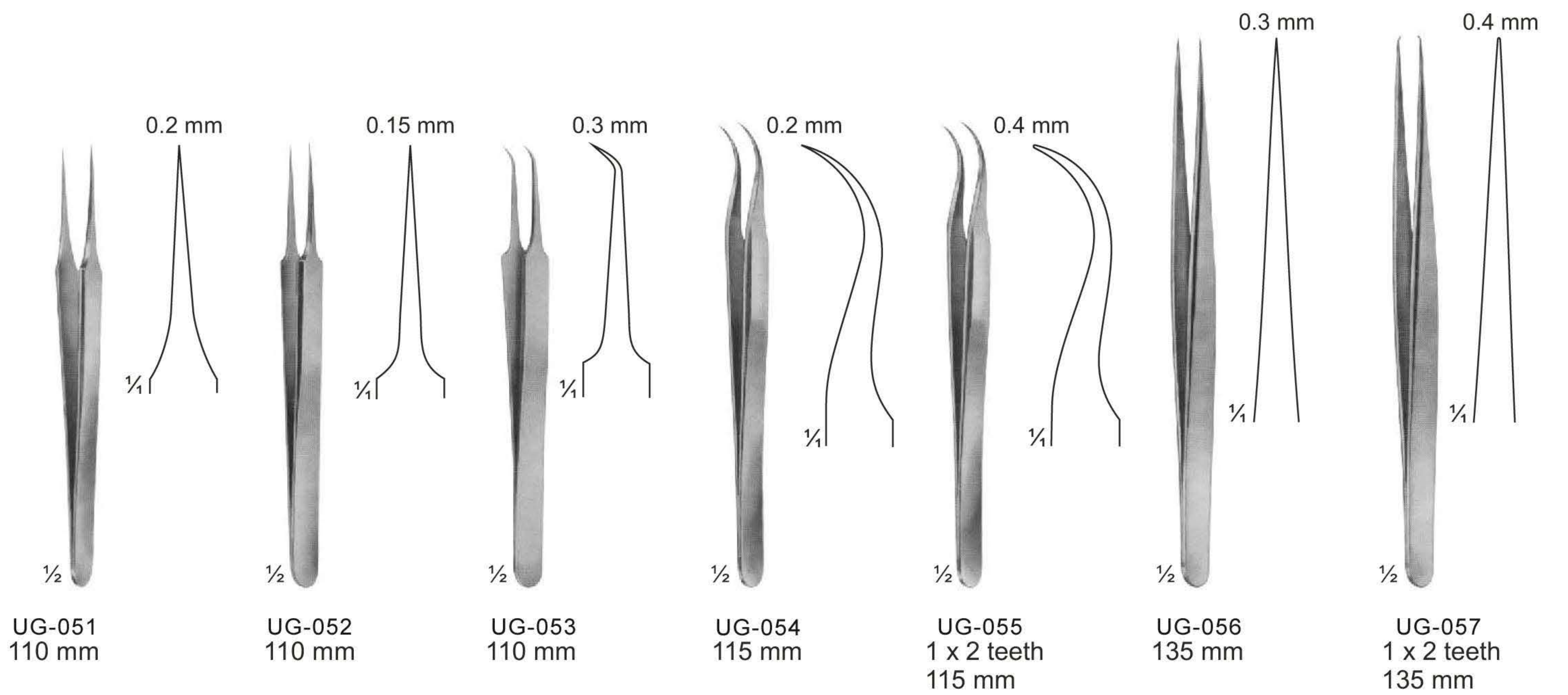

Ligature Forceps, Micro Forceps (Light Patterns)



UG-068
MULLER
110 mm

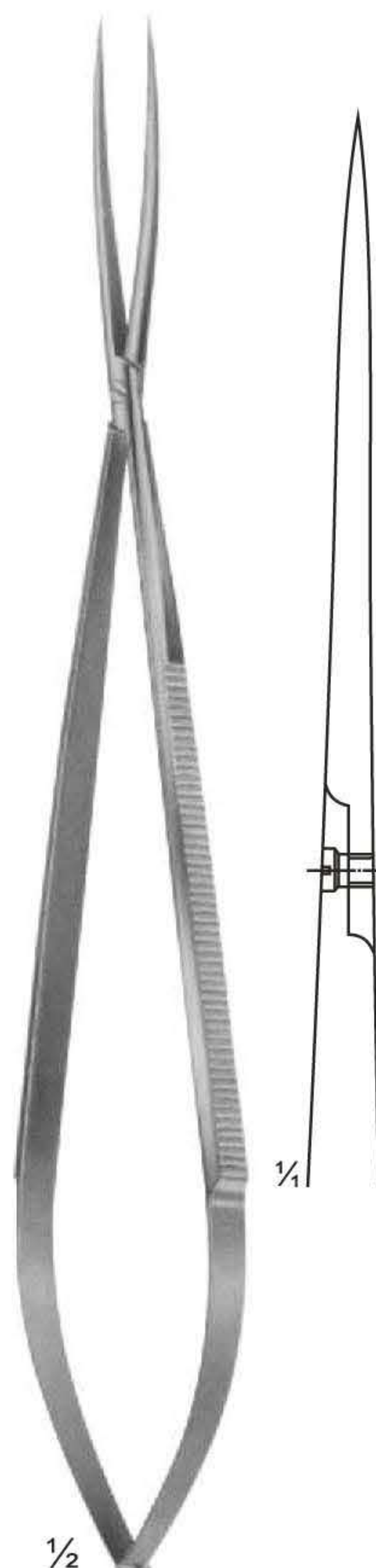

UG-071
LIGATURE FORCEPS
220 mm



UG-072
YASARGIL
185 mm



UG-075
MICRO FORCEPS
185 mm



UG-076
YASARGIL
180 mm



UG-085
YASARGIL
200 mm



UG-086
YASARGIL
220 mm



UG-087
YASARGIL
240 mm

Forceps for Grasping Tissue, Tumors



1/2

UG-090
YASARGIL-SAMI
Jaws Spoon-Shaped
240 mm



1/2

UG-094
YASARGIL
Jaws Spoon-Shaped
220 mm



1/2

UG-097
SAMII
Jaws Spoon-Shaped
230 mm



1/2

UG-100
SAMII
Jaws Spoon-Shaped
230 mm

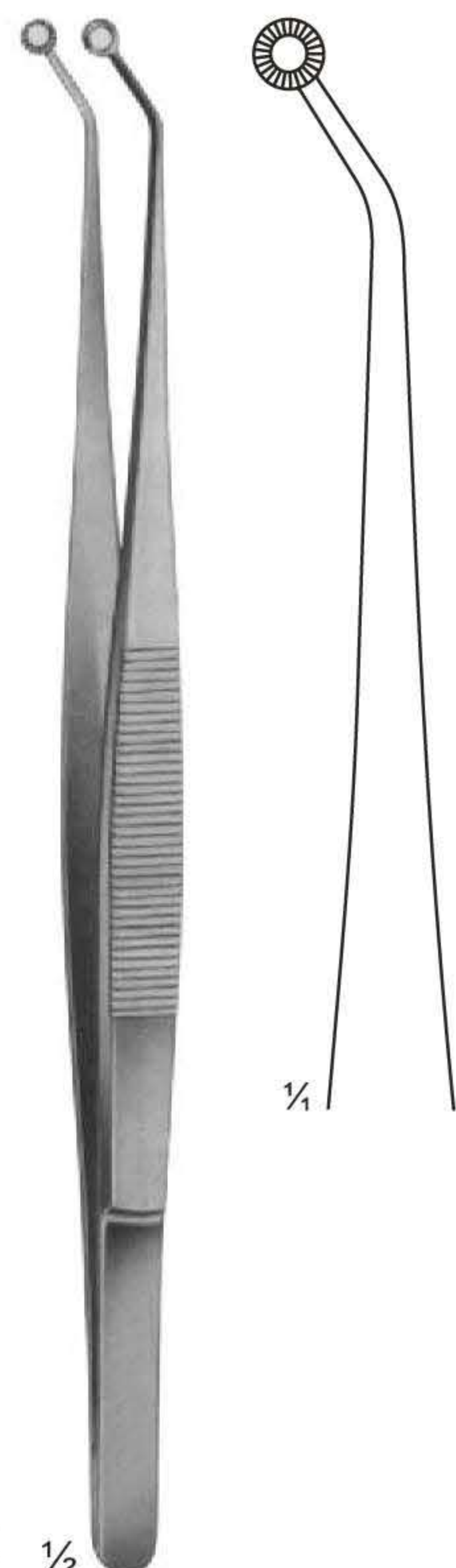

1/4

UG-104 1/2
HUNT
Tumor-and Vessel Forceps
200 mm

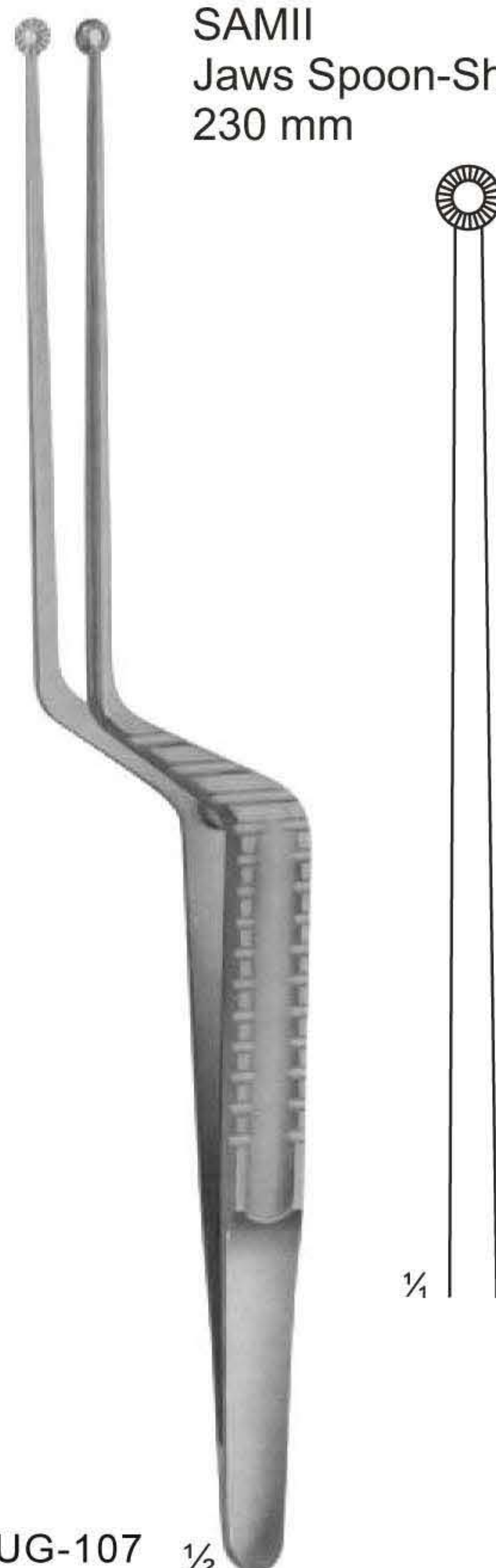

1/4

UG-107 1/2
HUNT
Tumor-and Vessel Forceps
200 mm

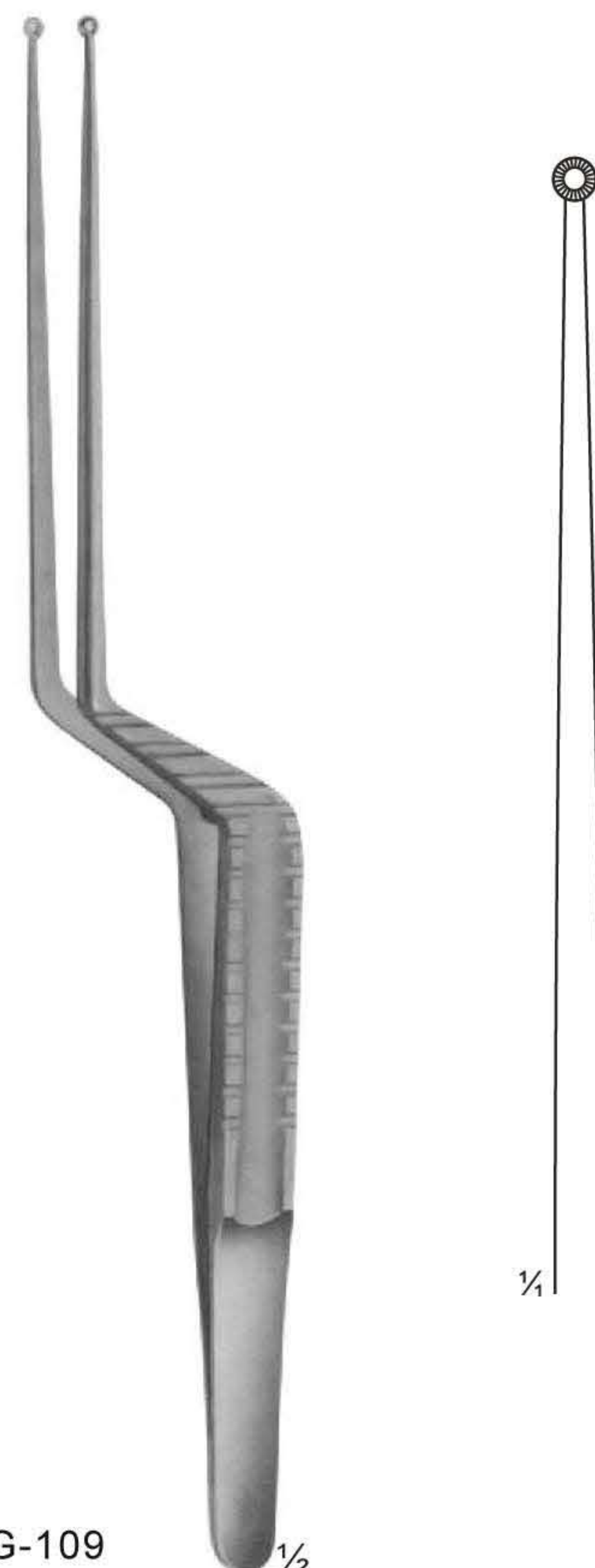

1/4

UG-109 1/2
YASARGIL
Tumor-and Vessel Forceps
200 mm

Delicate Dissecting, Microscopic, Sterilizing Forceps

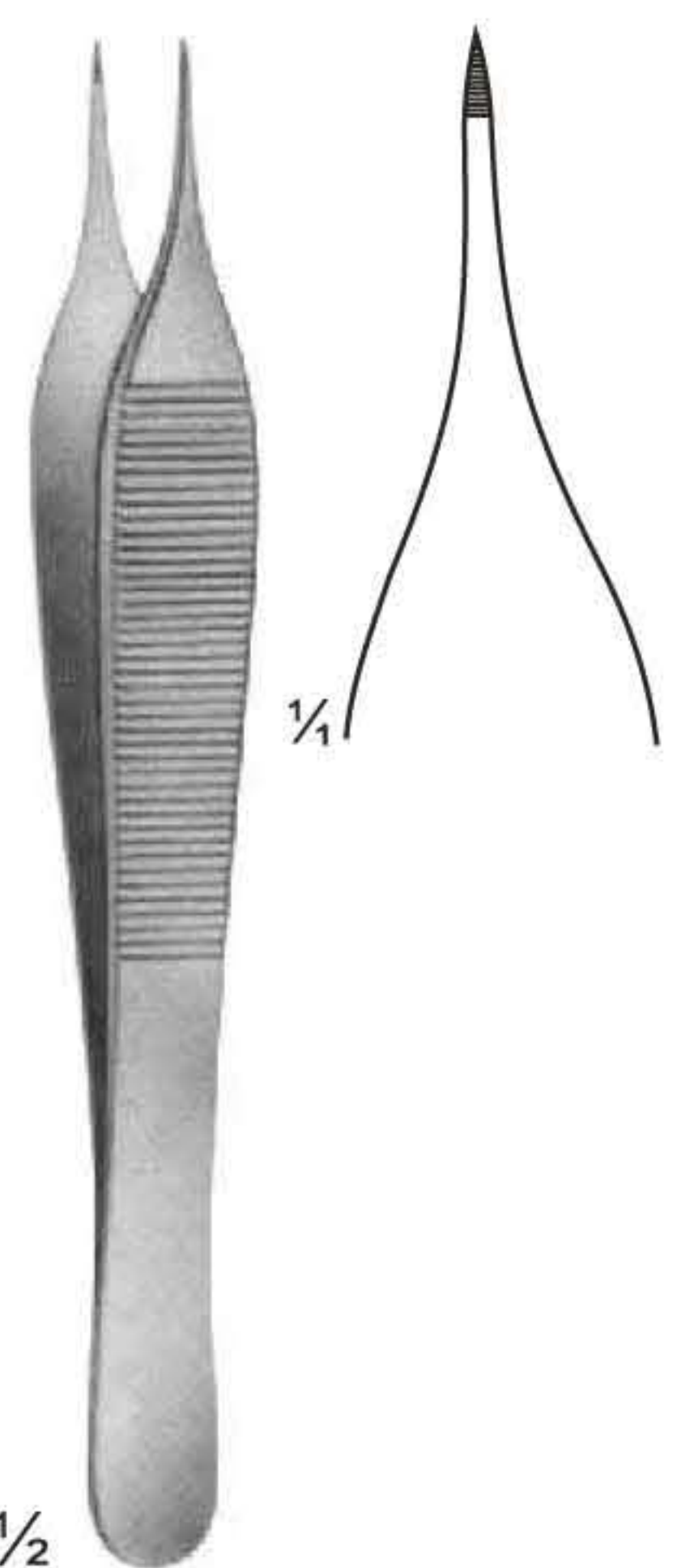

UG-112
THORPE
Corneal Forceps
120 mm

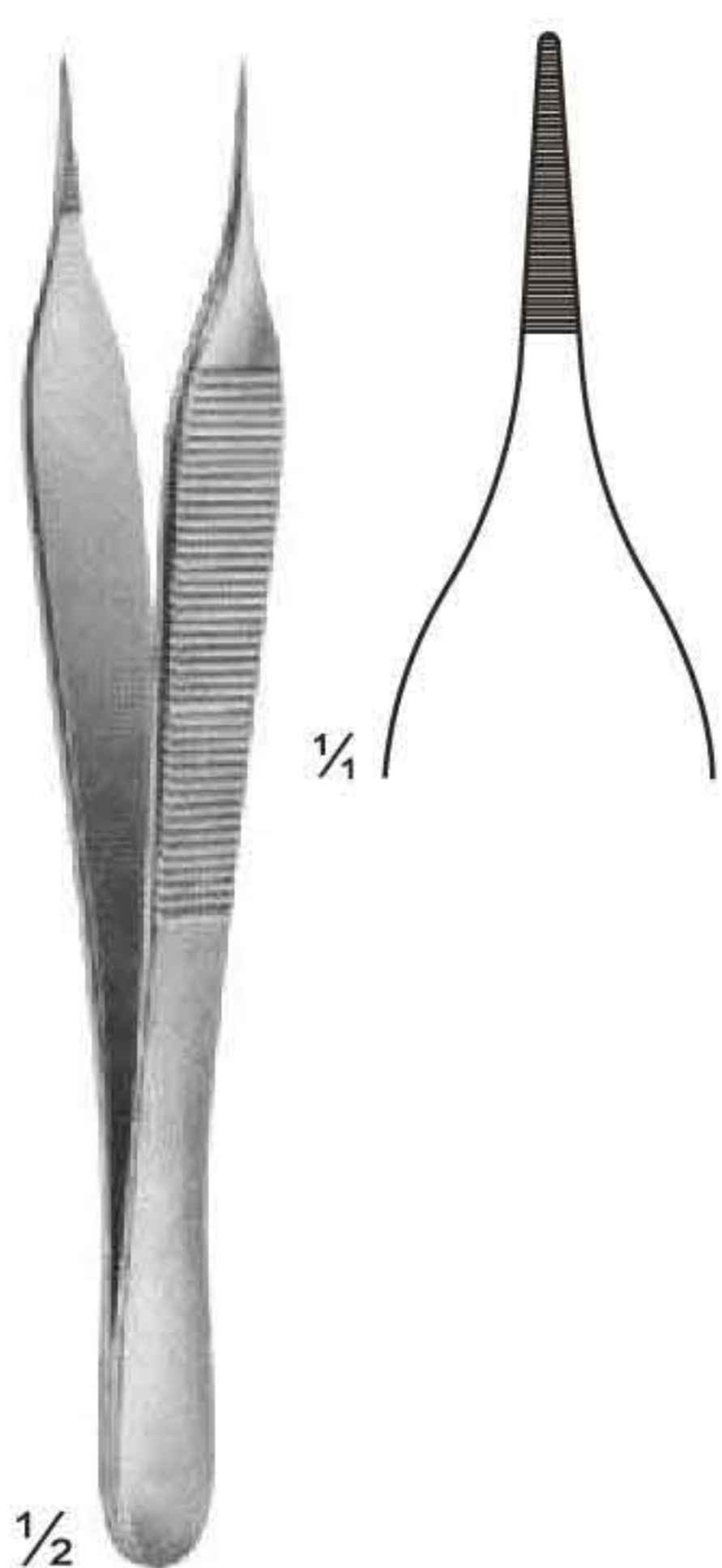

UG-115
MICRO-ADSON
120 mm

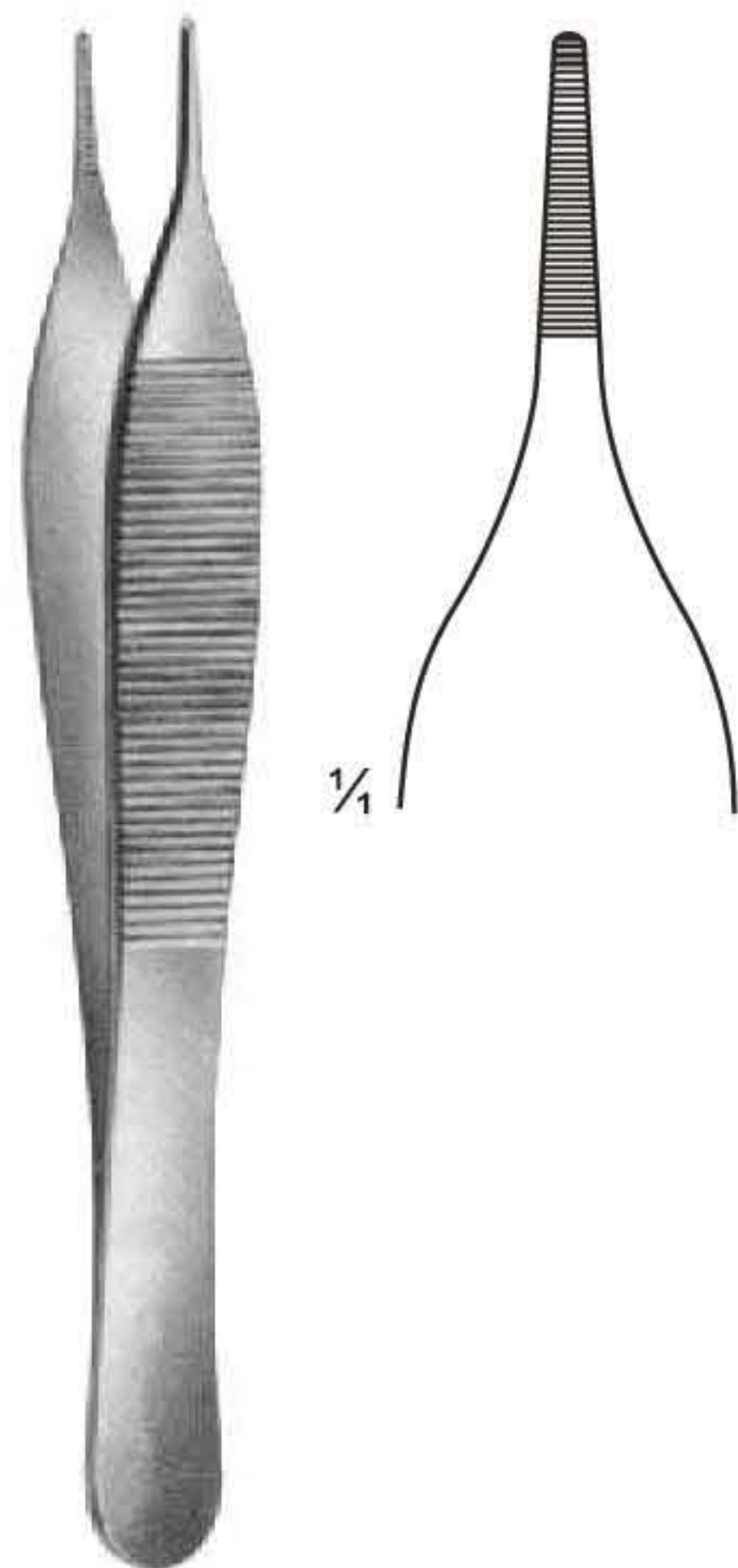

UG-116
ADSON
120 mm

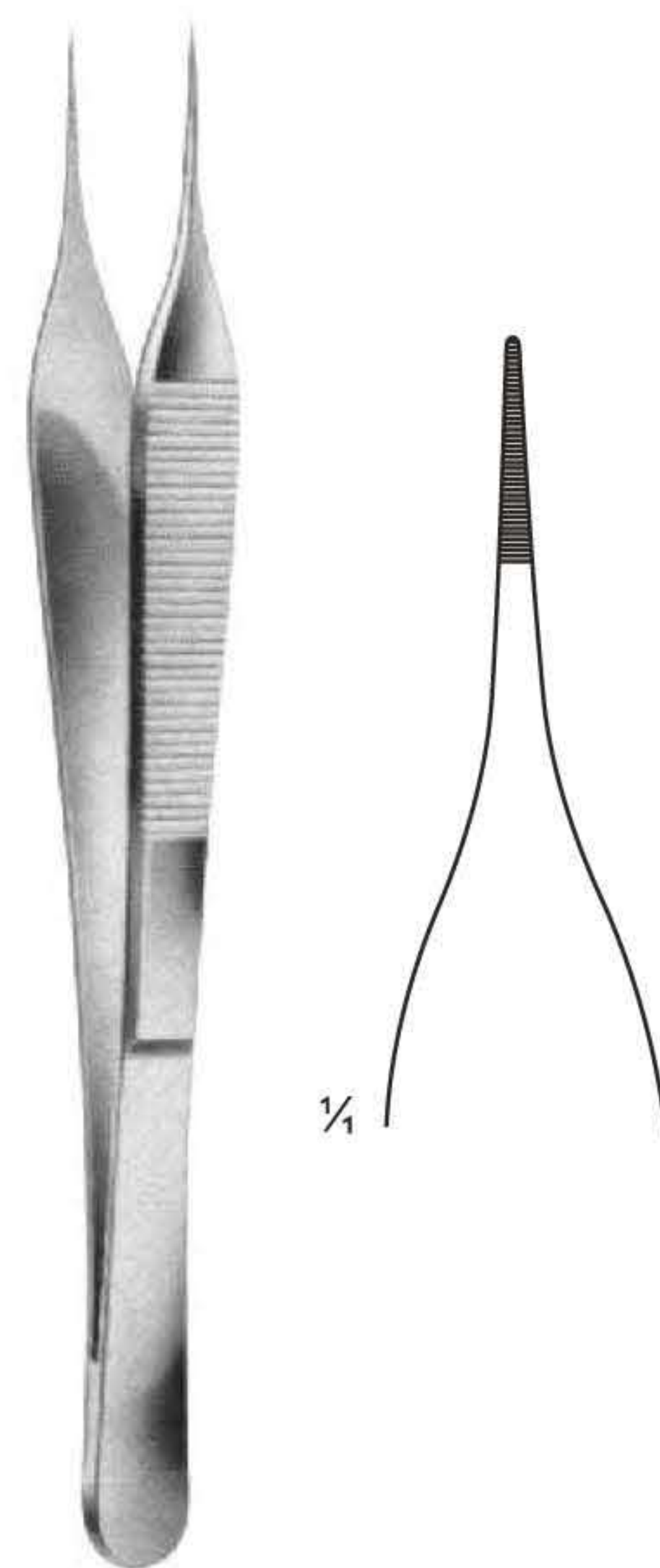

UG-117
MICRO-ADSON
150 mm



UG-118
100 mm

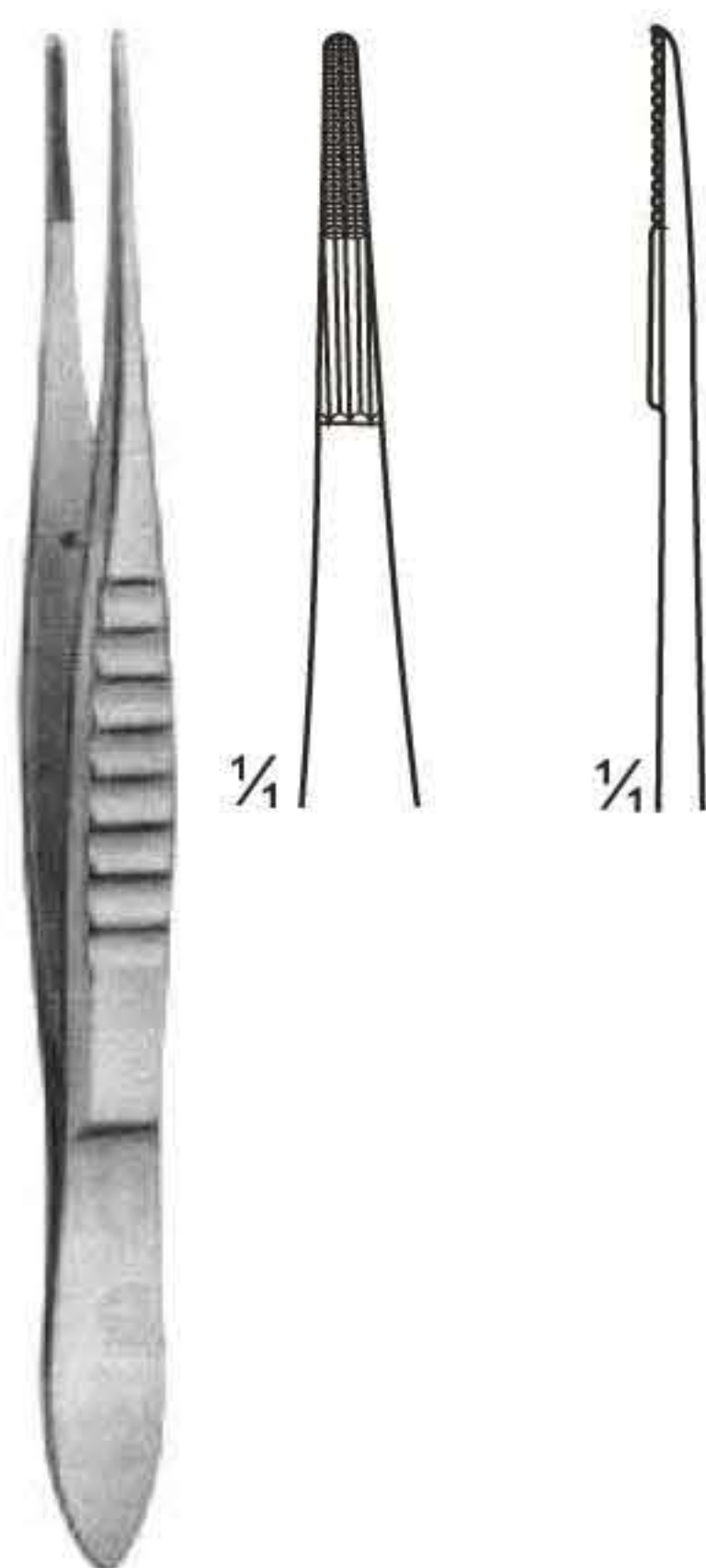

UG-120
110 mm

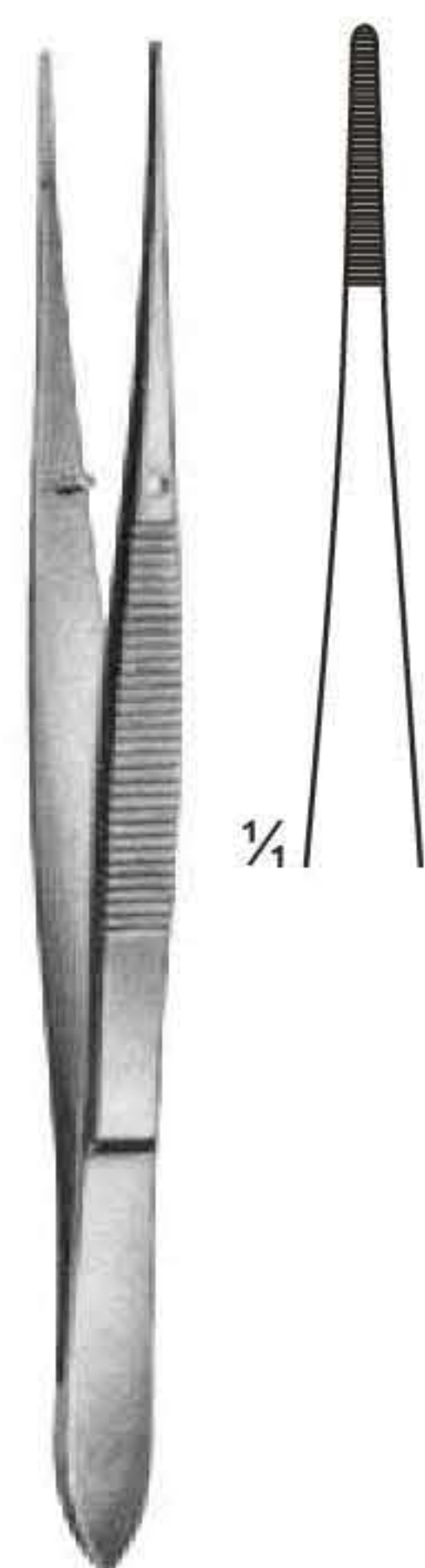

UG-121
115 mm



UG-123

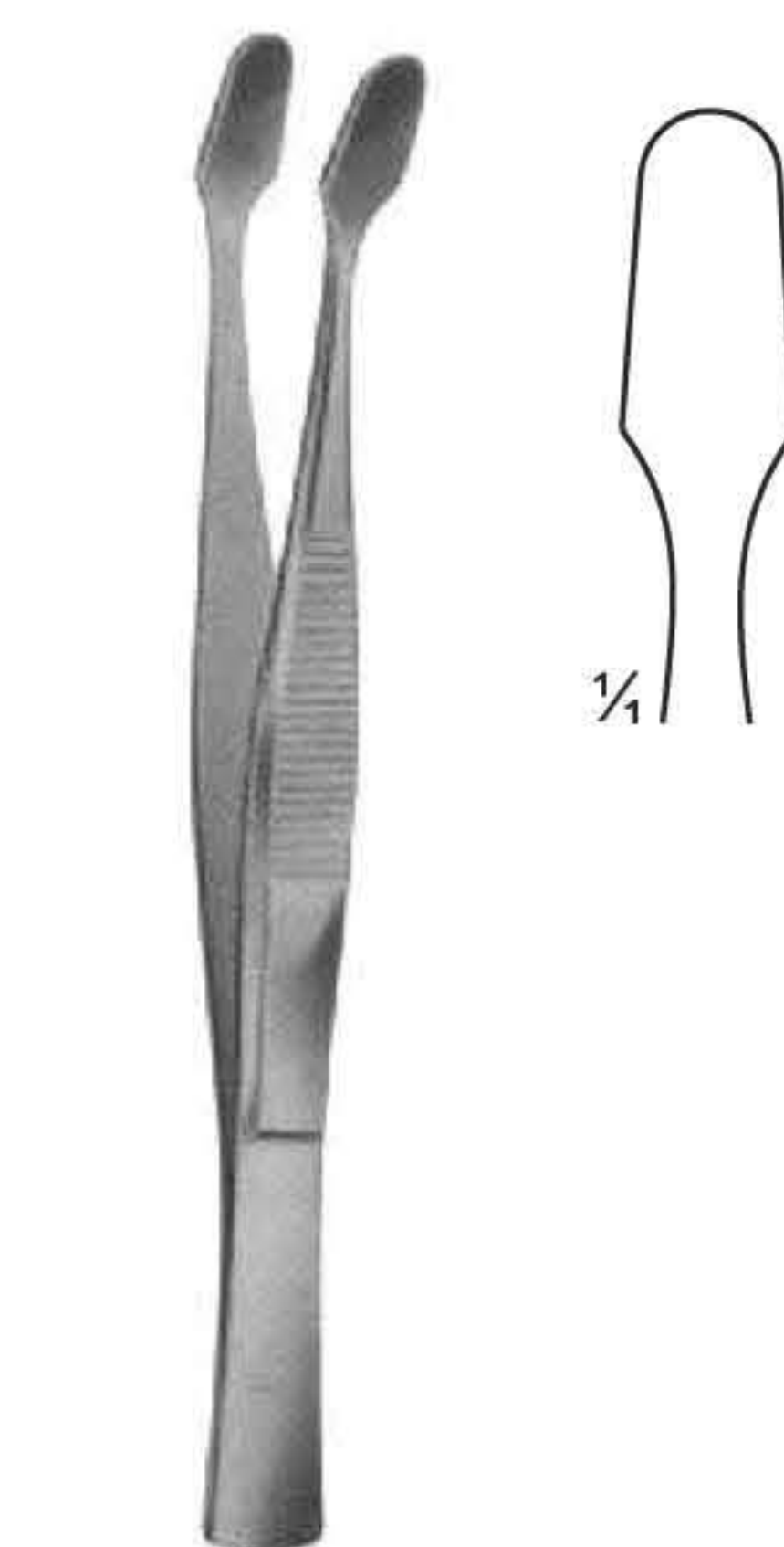

UG-135
COVER GLASS FORCEPS
105 mm

UG-136
160 mm

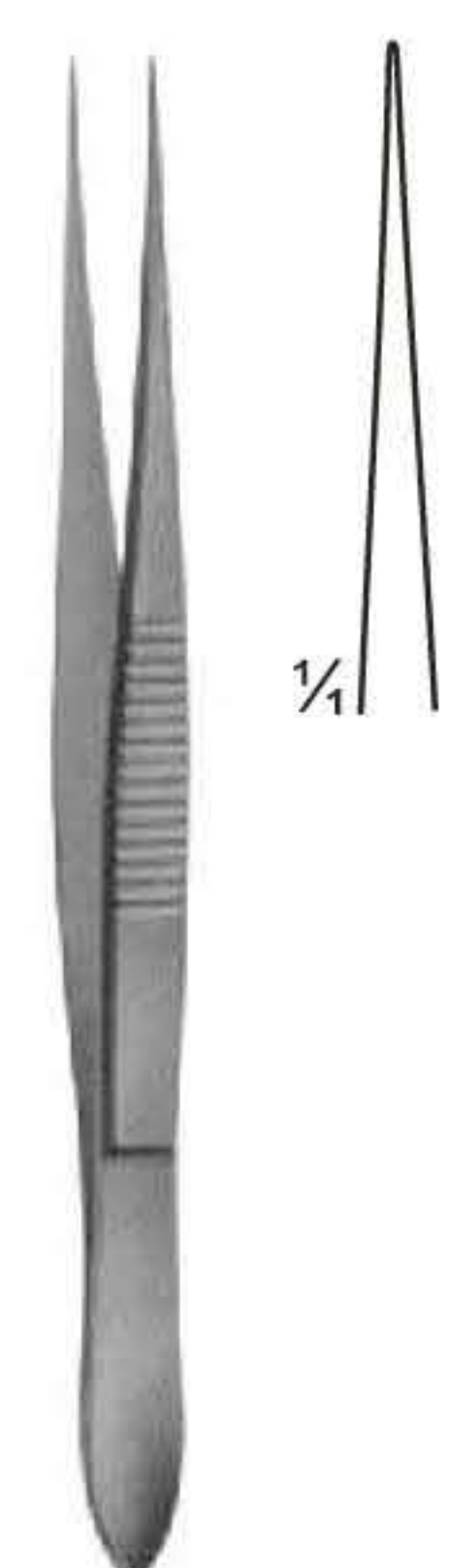

UG-130
100 mm

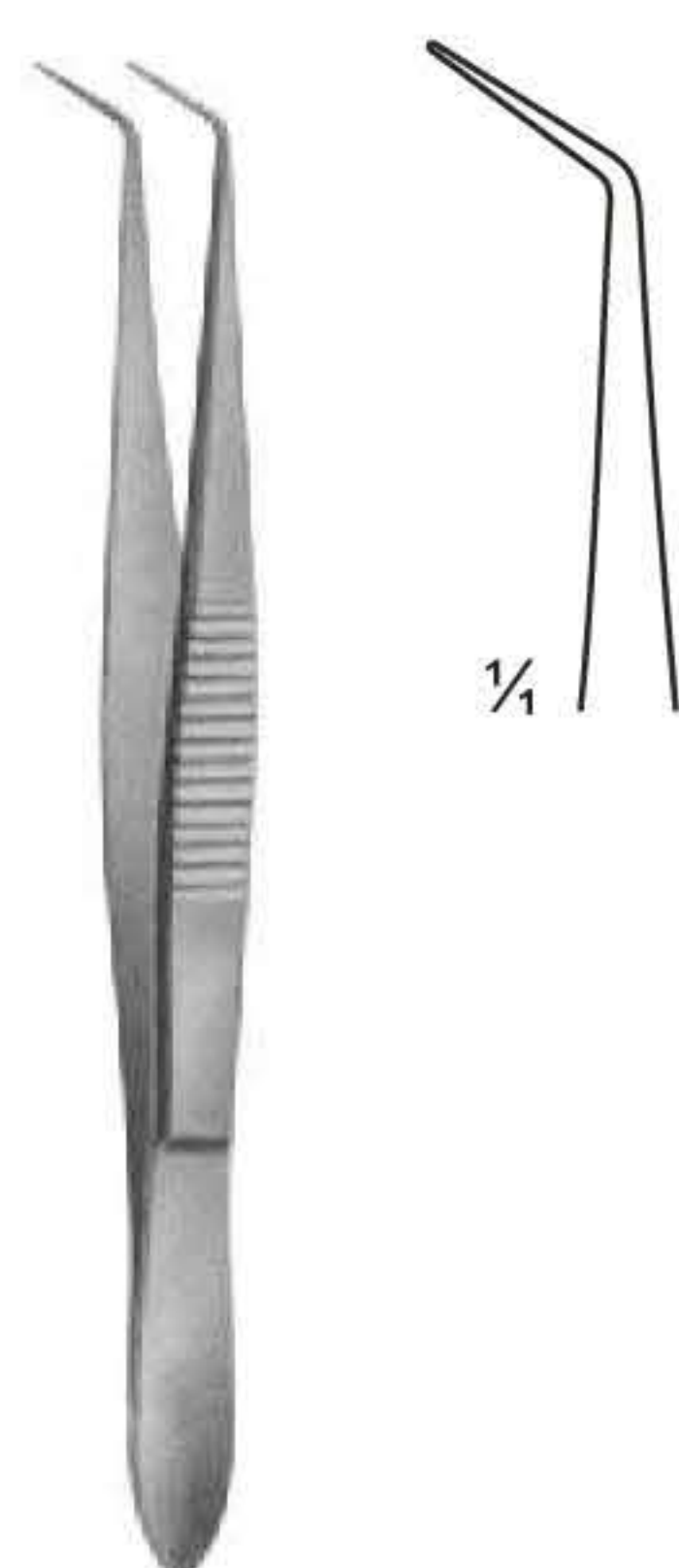

UG-131
100 mm

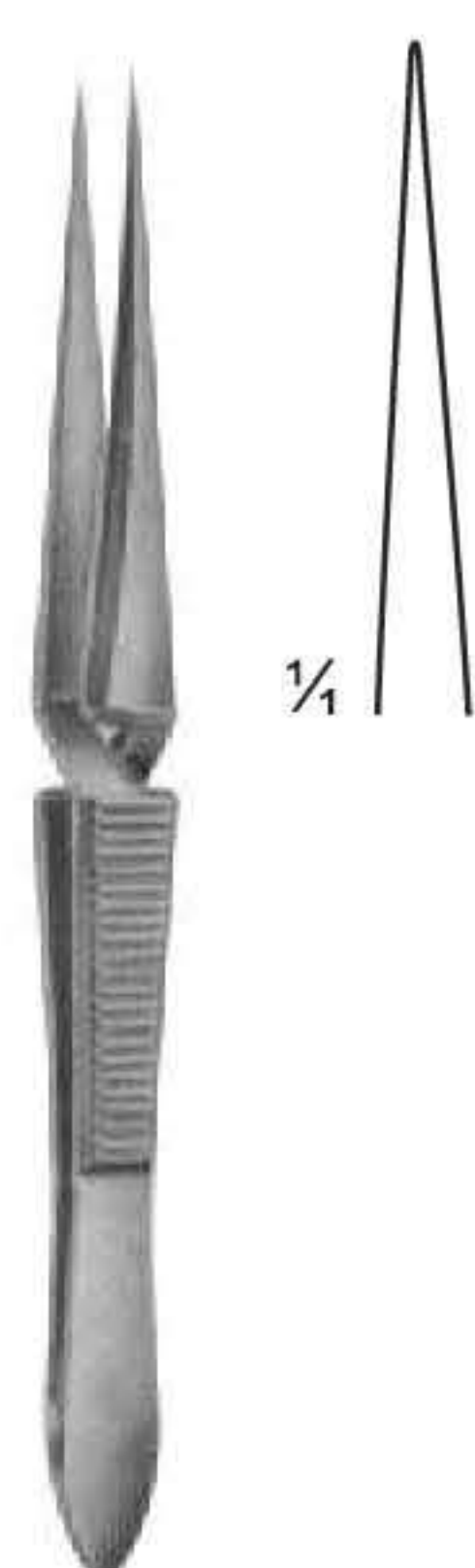

UG-132
100 mm

Delicate Dissecting Forceps



½
UG-137
SEMKEN

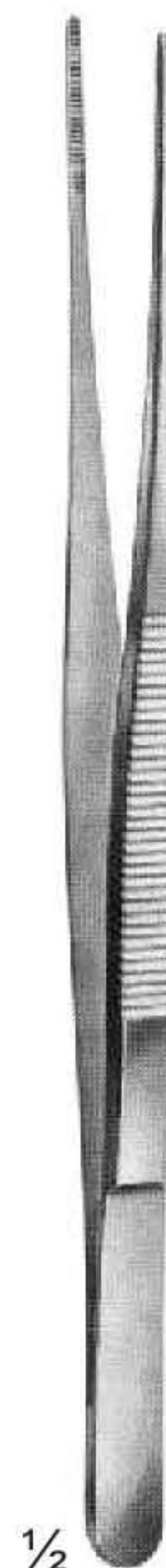

½
UG-140

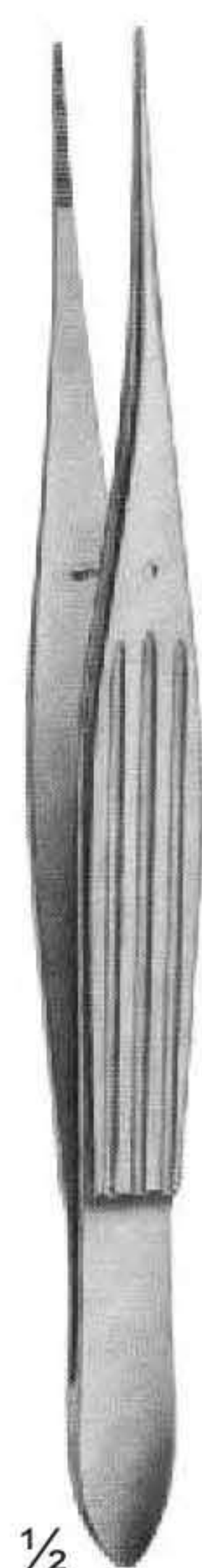

½
UG-144
MC INDOE

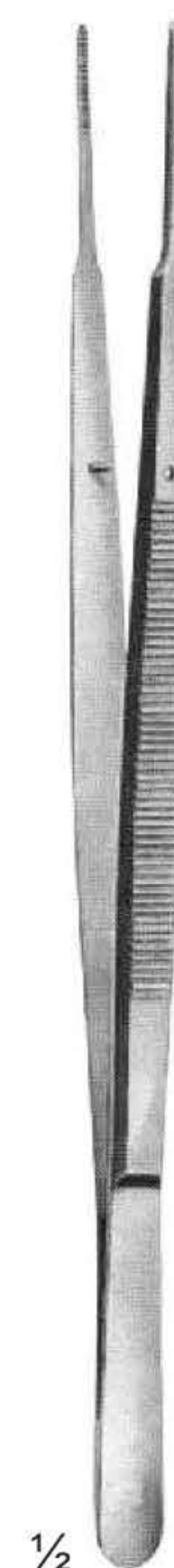

½
UG-146
GERALD



½
UG-151
CUSHING

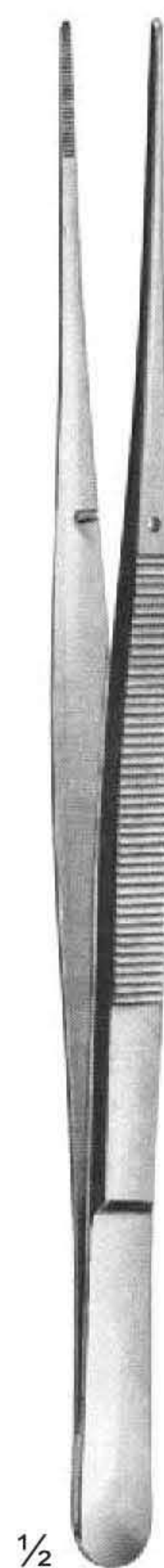

½
UG-153
BROPHY



½
UG-155
SMOOTH JAWS



½
UG-158

Dissecting Forceps



UG-162
STANDARD



UG-167
MEDIUM



UG-169
MEDIUM

Dissecting Forceps



UG-170



UG-172

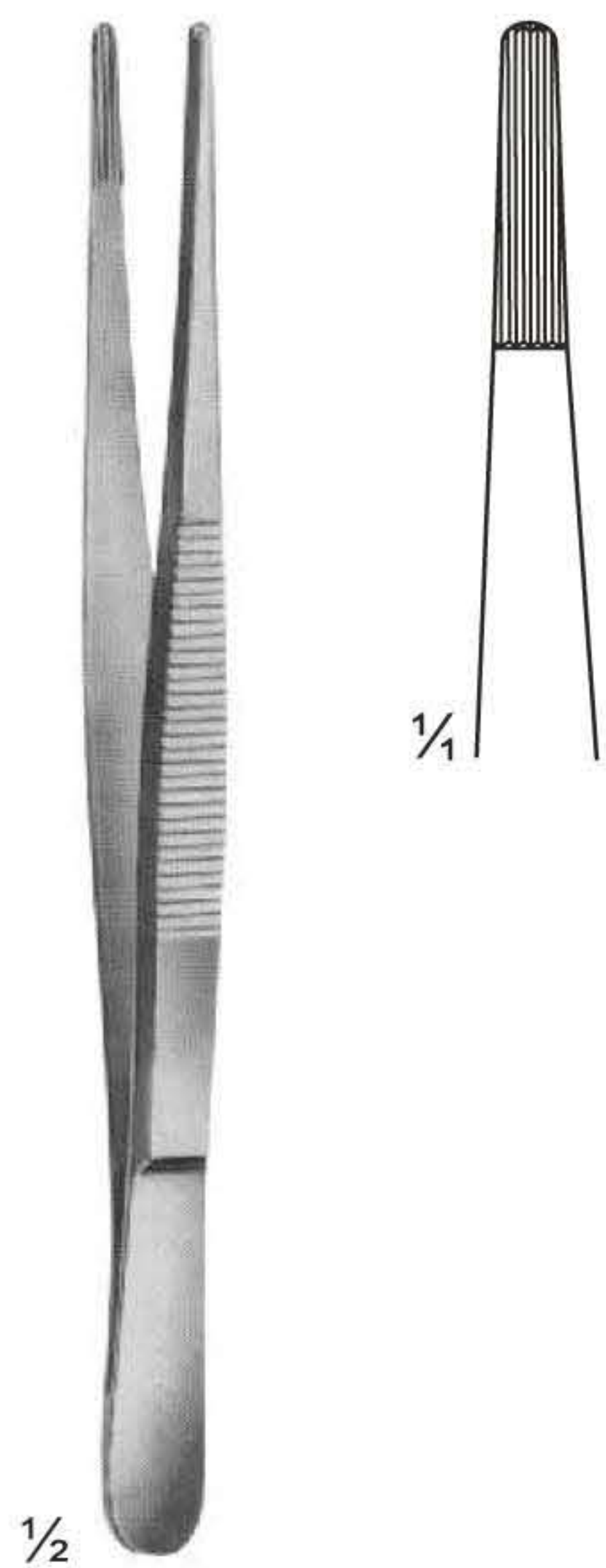

UG-174
OCHSNER

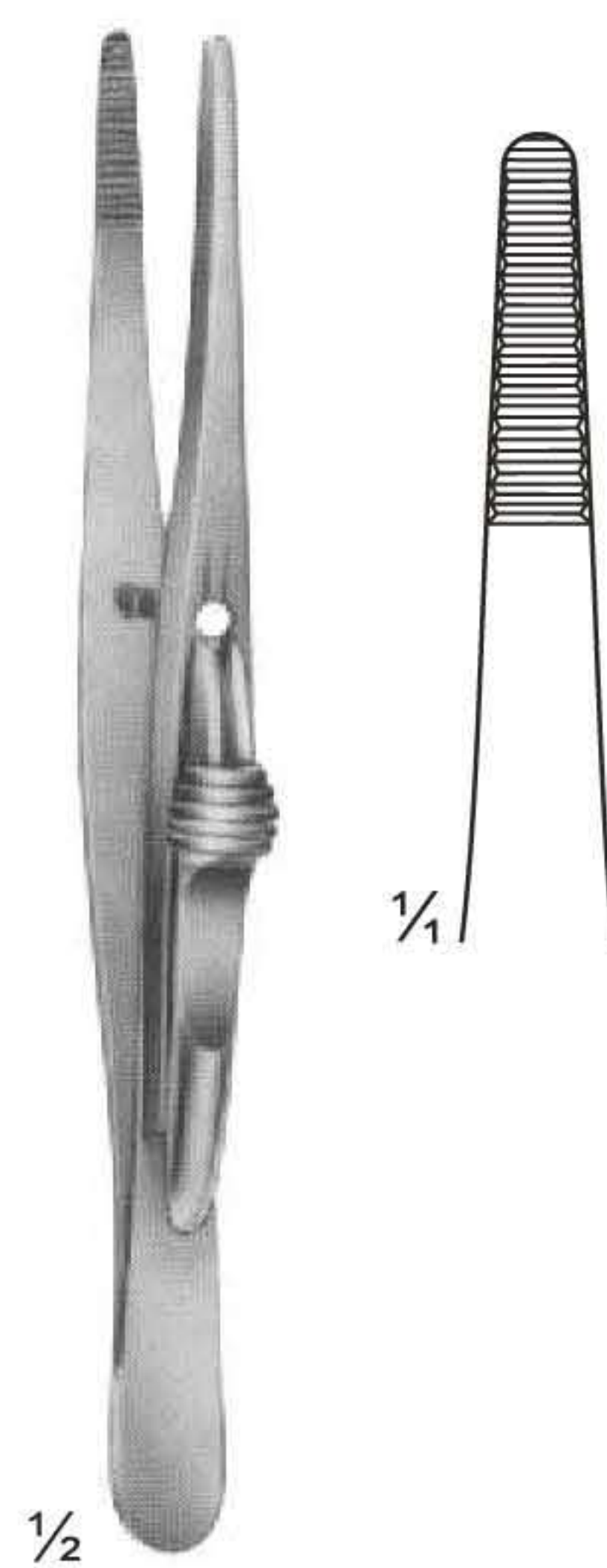

UG-177
FRICKE

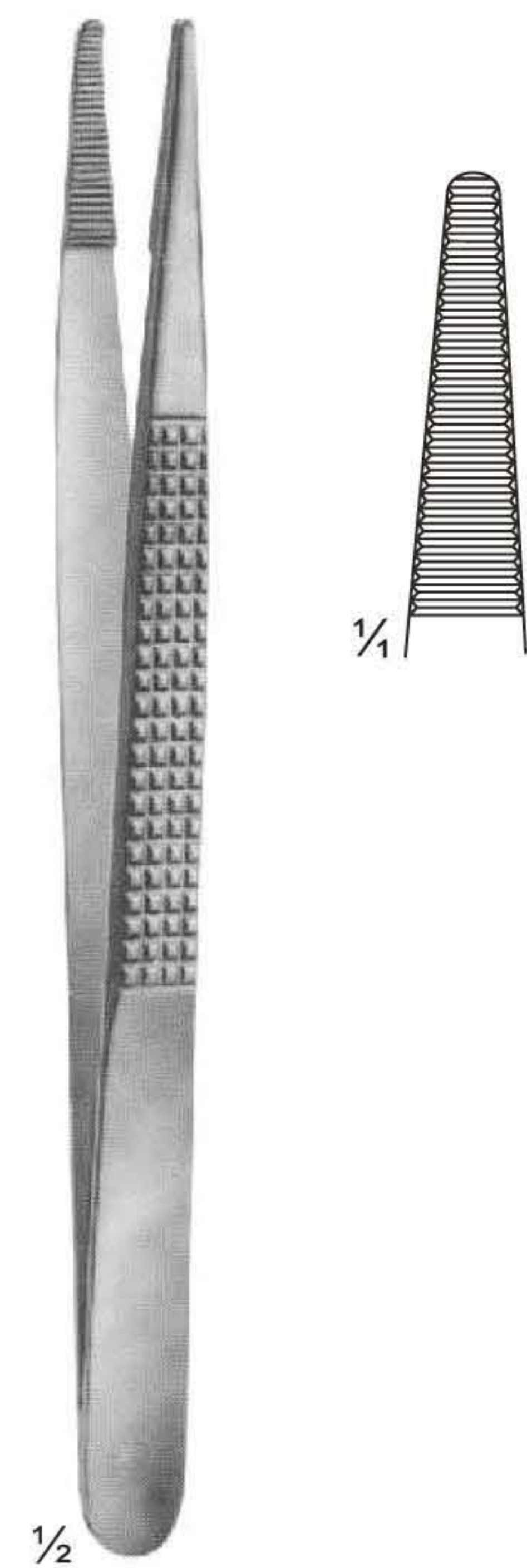

UG-178
BONNEY

Ultra-Light Forceps



UG-180
150 mm

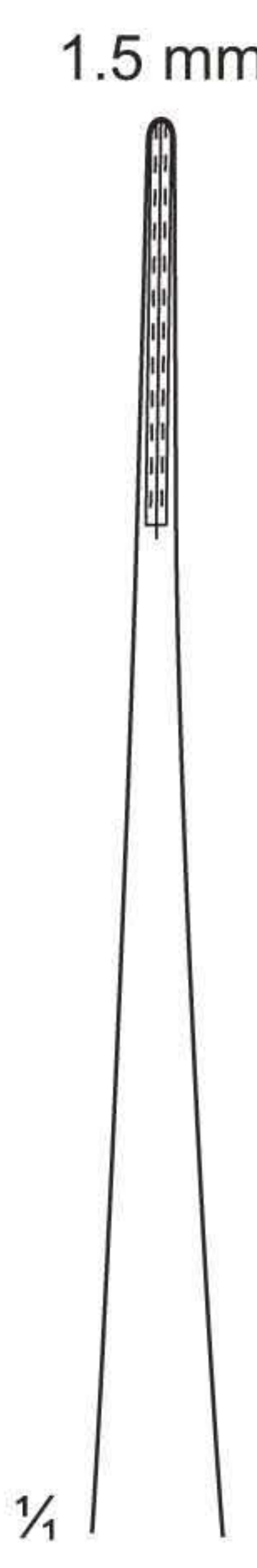

UG-181
200 mm

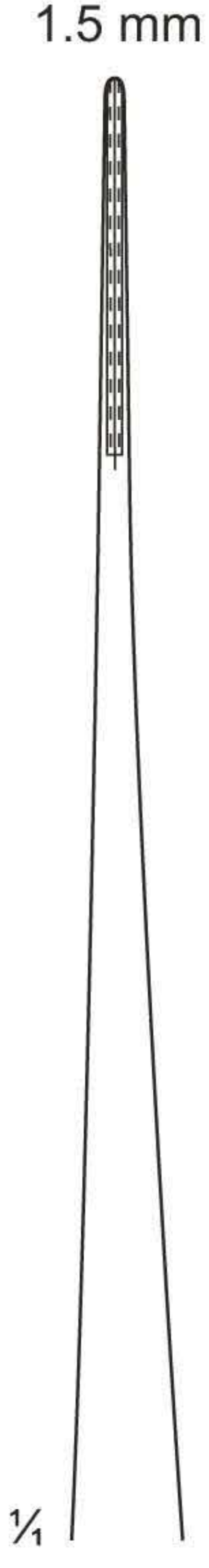
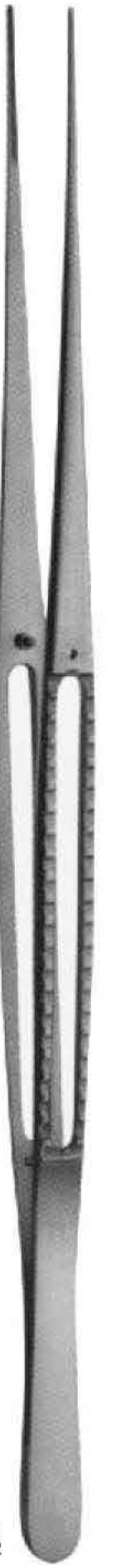

UG-183
240 mm

Forceps



½
UG-187
DE BAKEY



½
UG-193
DE BAKEY



½
UG-198
DE BAKEY

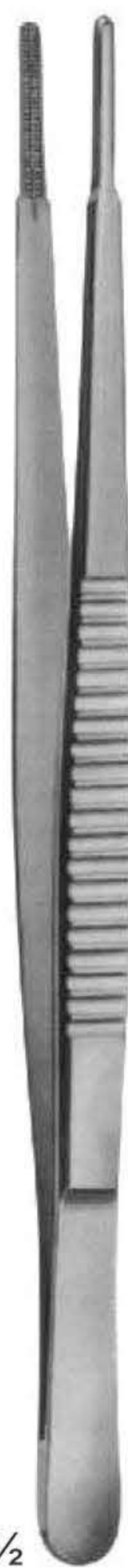

½
UG-204
DE BAKEY



½
UG-208
DE BAKEY



½
UG-211
DE BAKEY

Forceps, Bayonet - Shaped

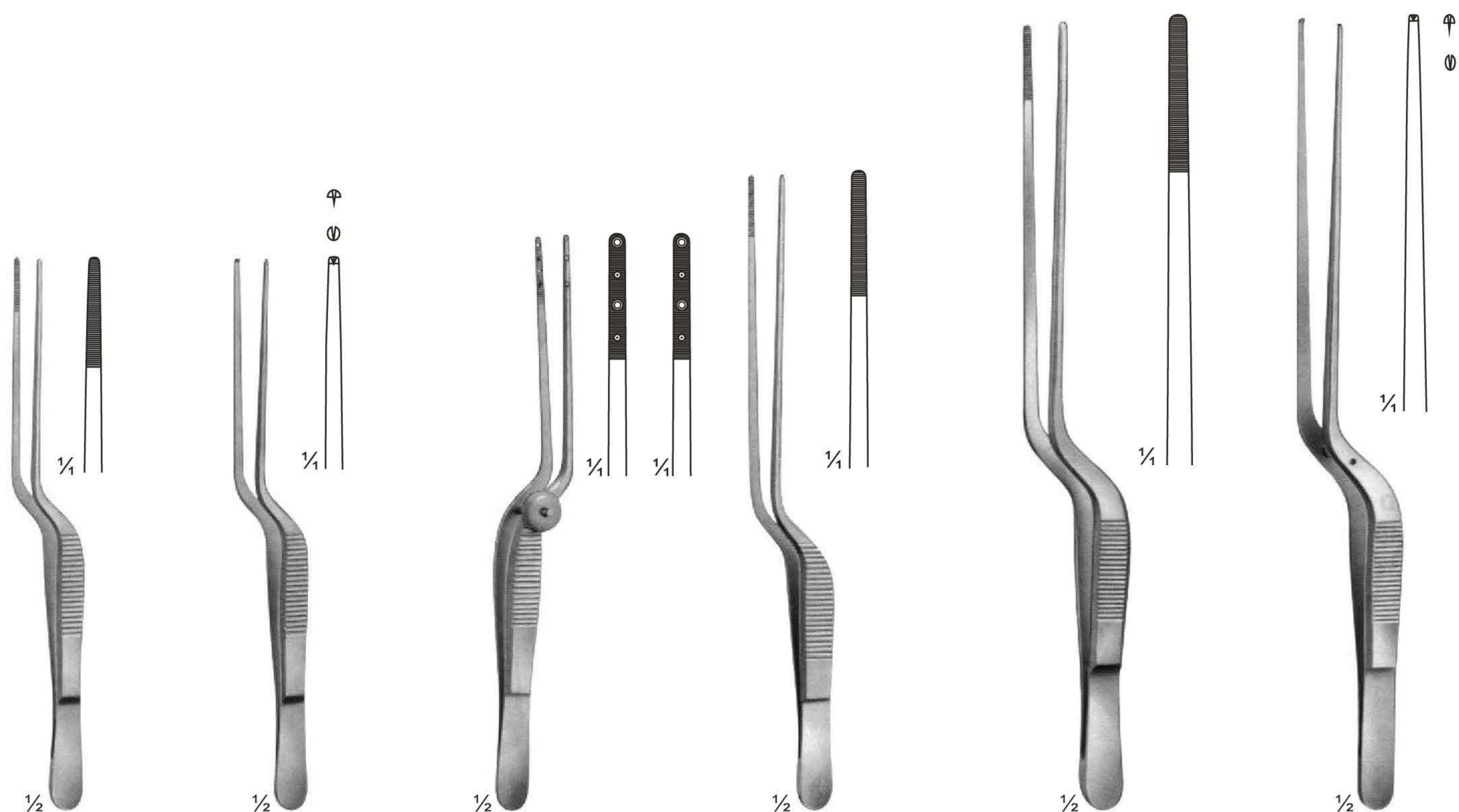

UG-214
LUCAE
140 mm

UG-215
LUCAE
1x2 teeth
140 mm

UG-217
COTTLE
Forceps with
jaws toothed
and serrated
140 mm

UG-220
JANSEN
160 mm

UG-222
GRUENWALD
200 mm

UG-225
1x2 teeth
200 mm

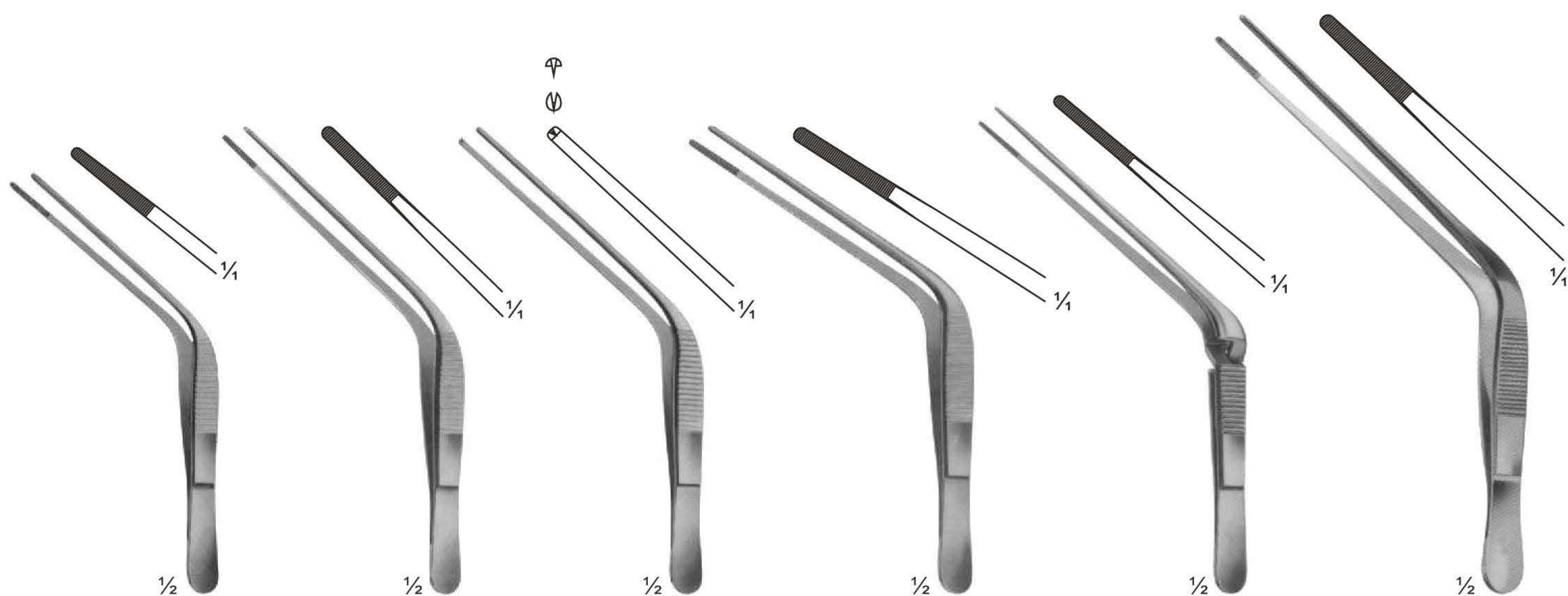

UG-227
TROELTSCH
100 mm

UG-231
TROELTSCH
115 mm

UG-233
TROELTSCH
1X2 teeth
115 mm

UG-234
WILDE
115 mm

UG-236
TROELTSCH
Cross action
120 mm

UG-237
TROELTSCH
140 mm

Delicate Tissue Forceps

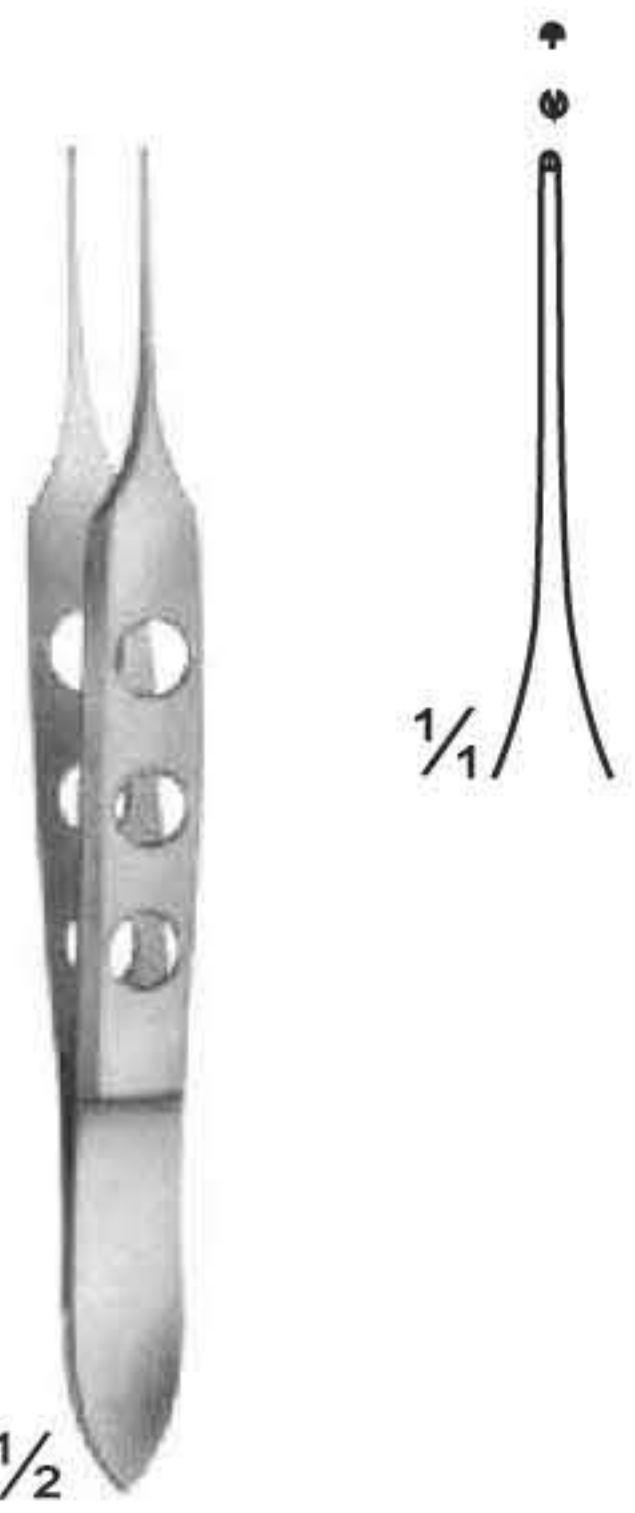

UG-238
BISHOP-HARMON
85 mm

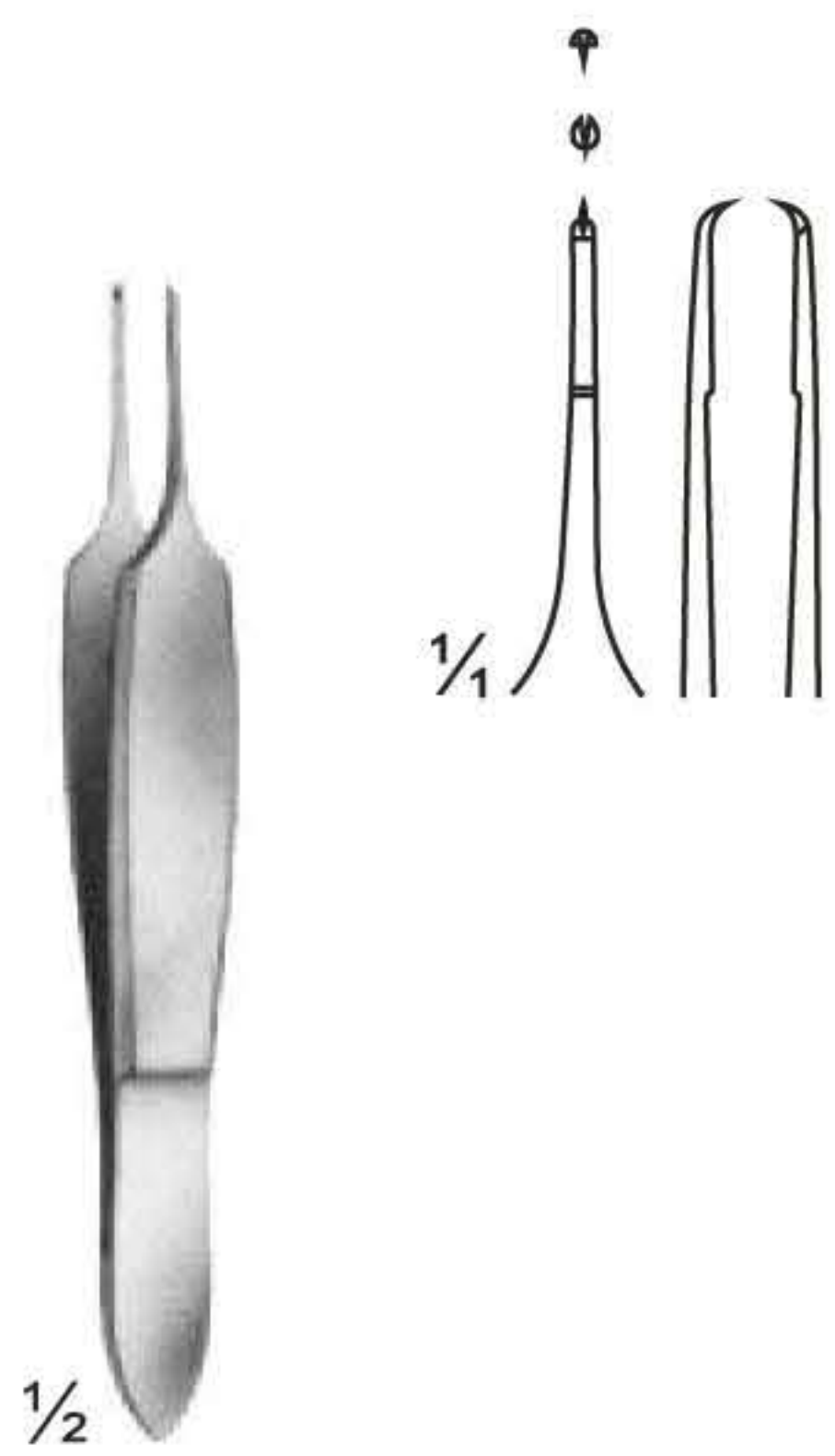

UG-239
ST. MARTIN
80 mm

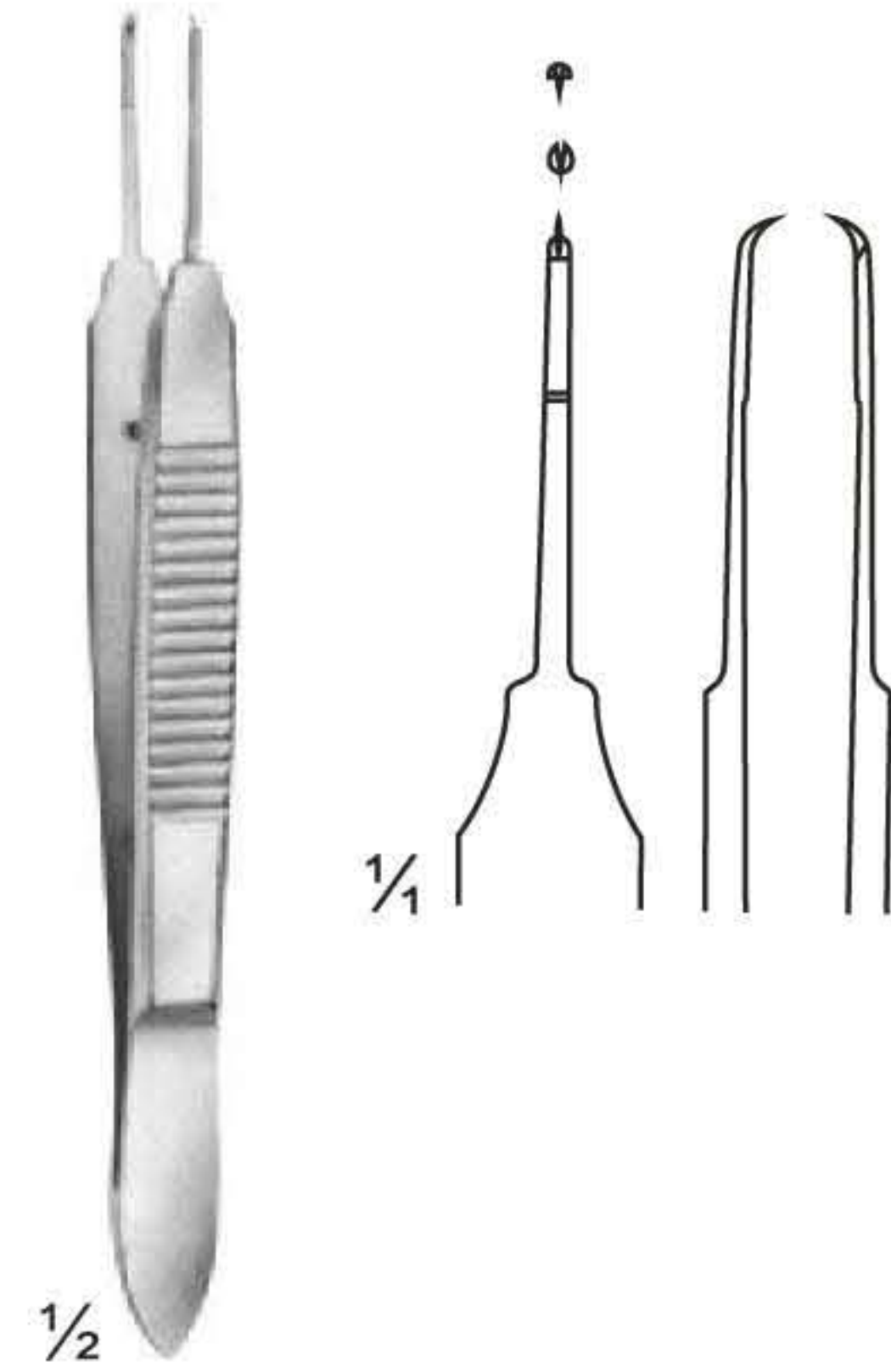

UG-240
CASTROVIEJO
teeth 0.9 mm
100 mm

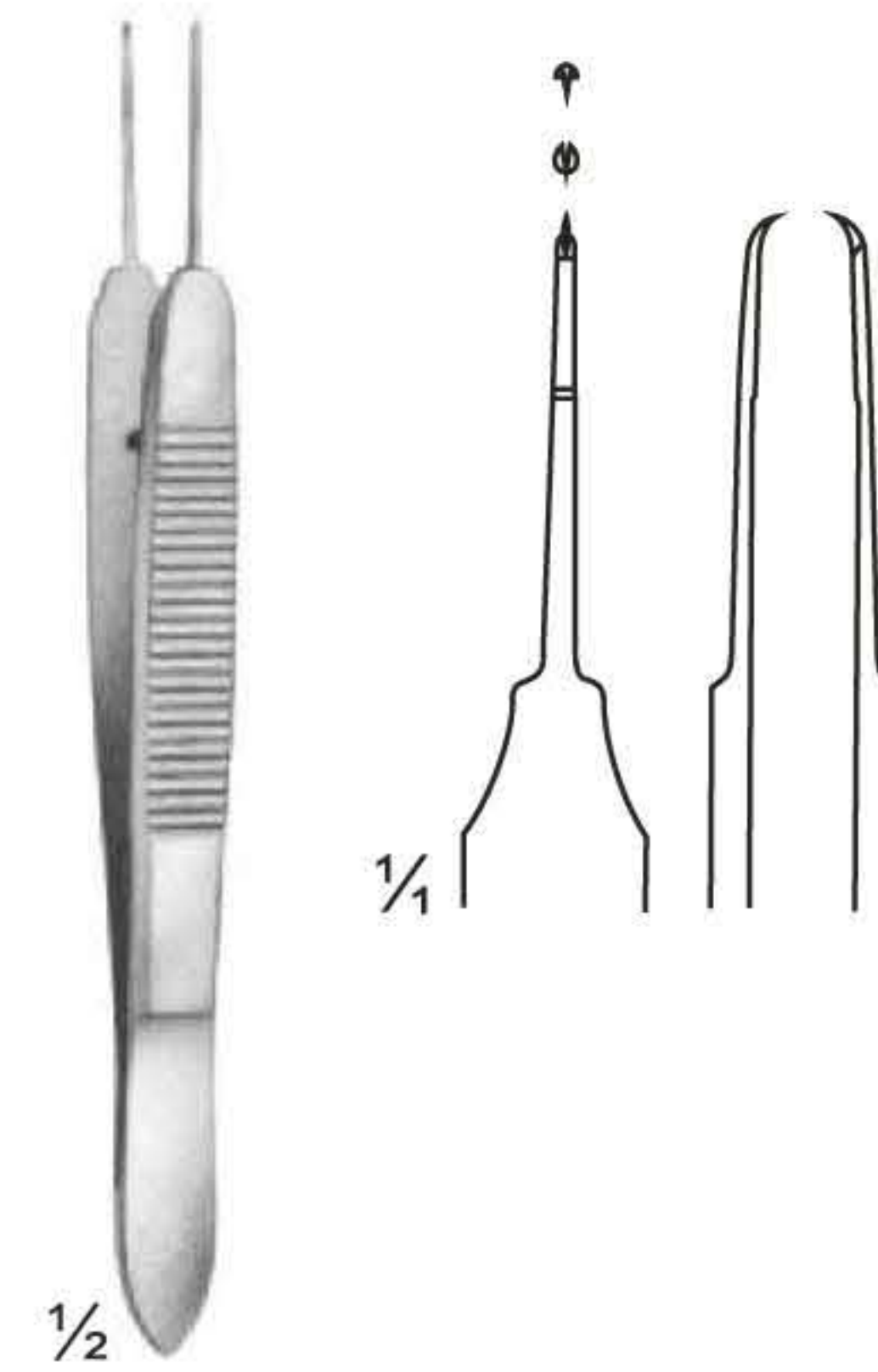

UG-241
CASTROVIEJO
teeth 0.5 mm
100 mm

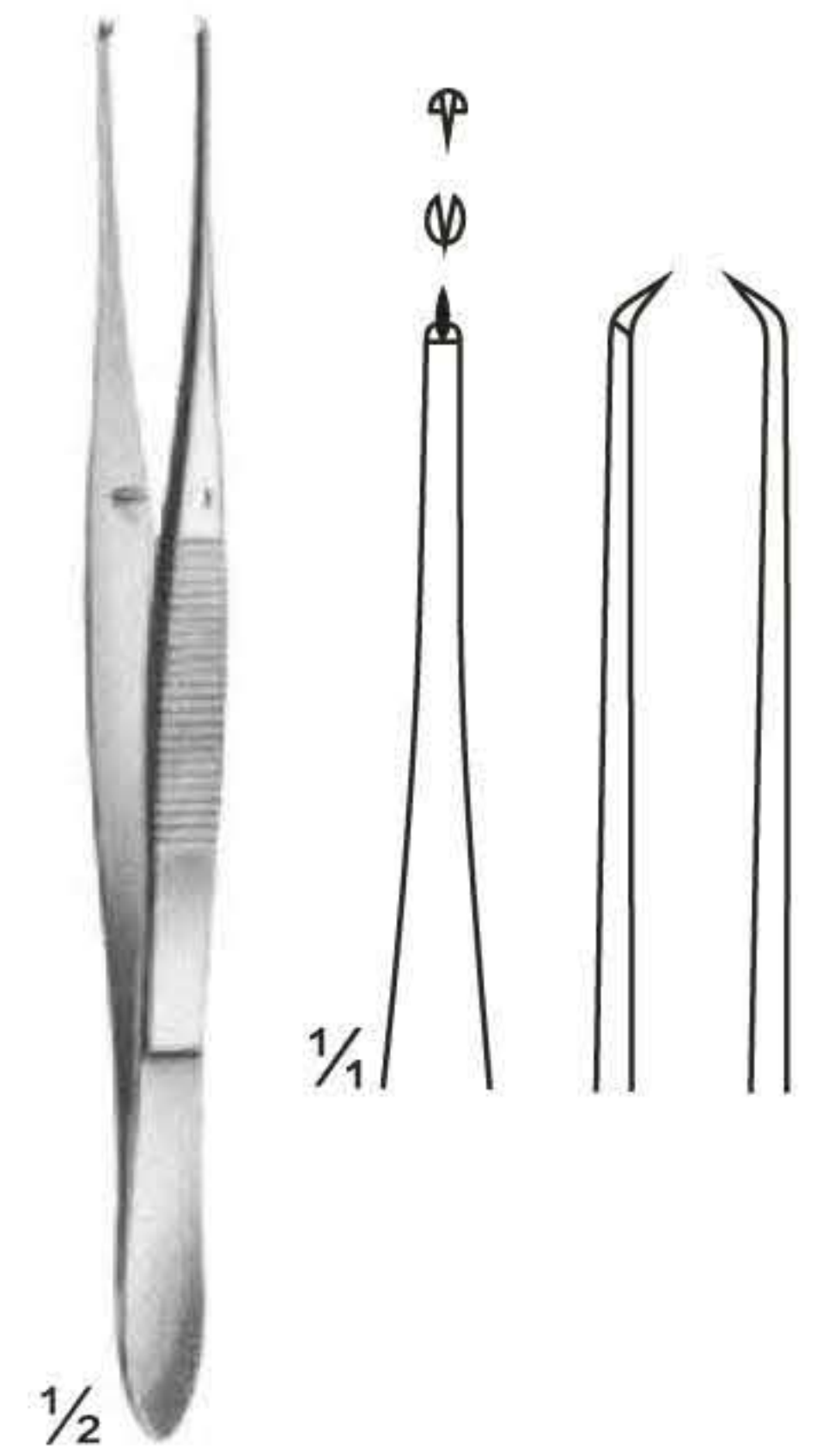

UG-247
ELSCHING
110 mm

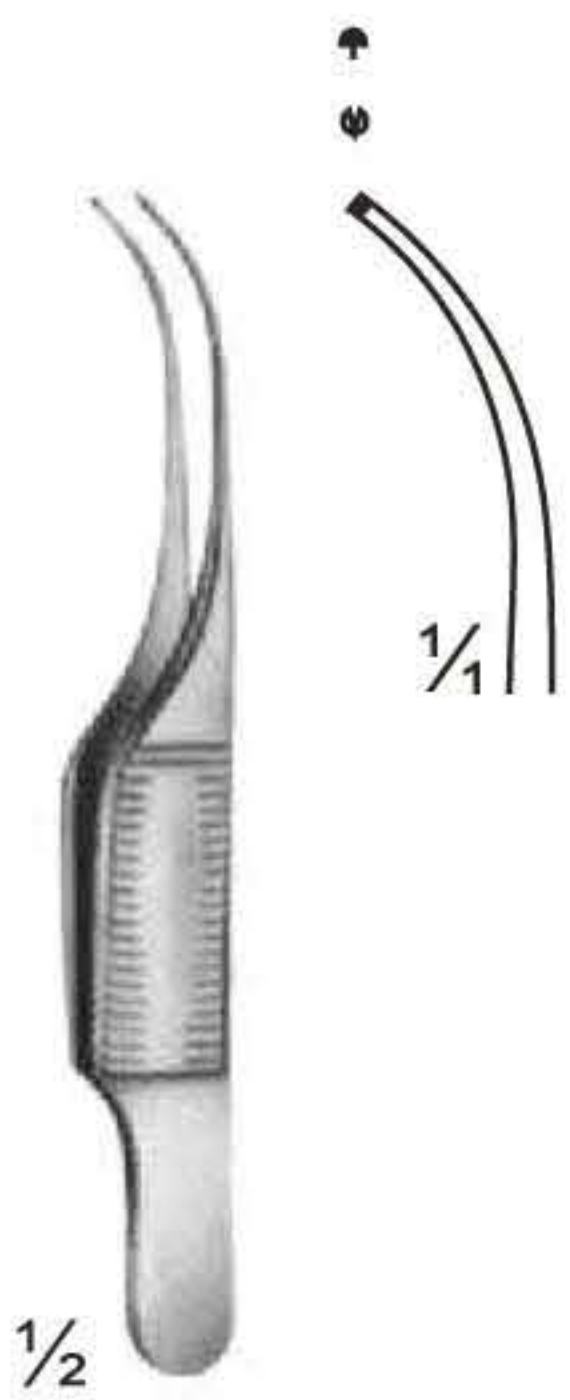

UG-248
GILL
75 mm

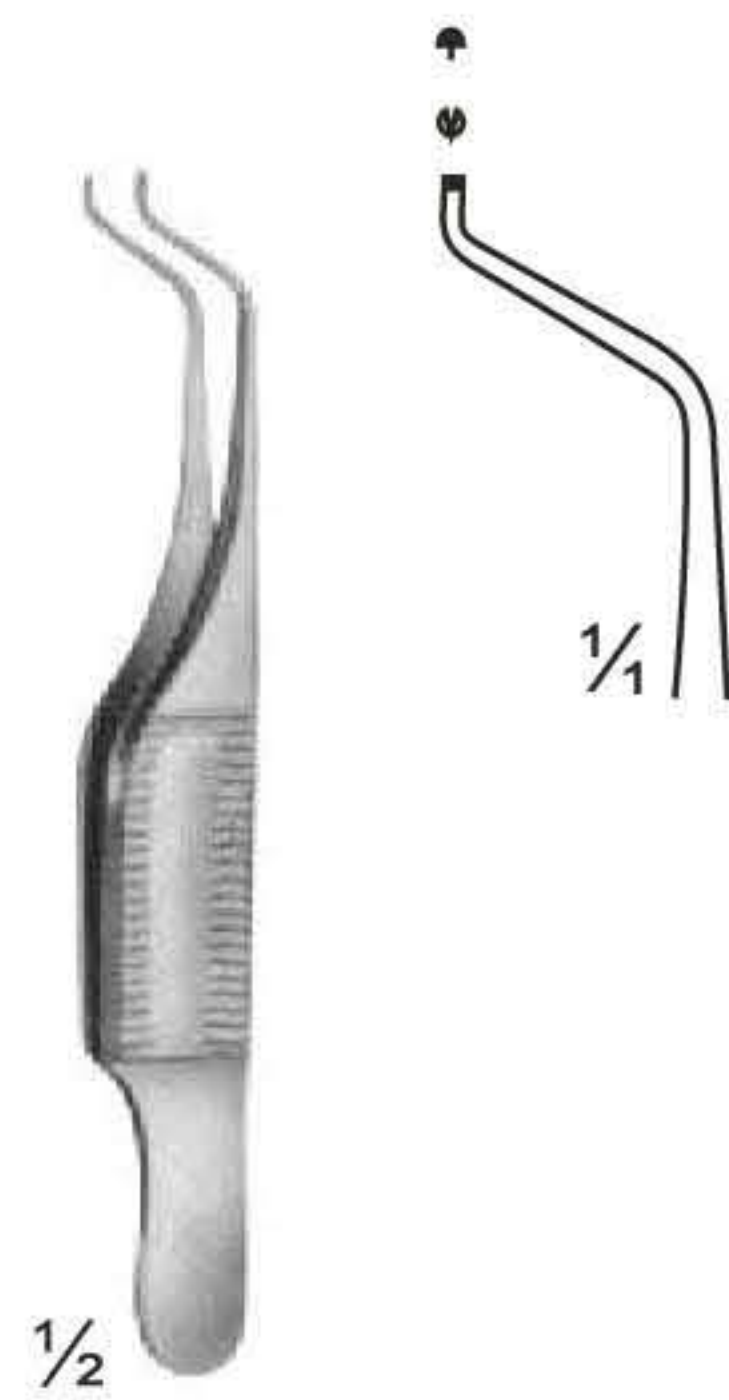

UG-249
GILL - HESS
75 mm

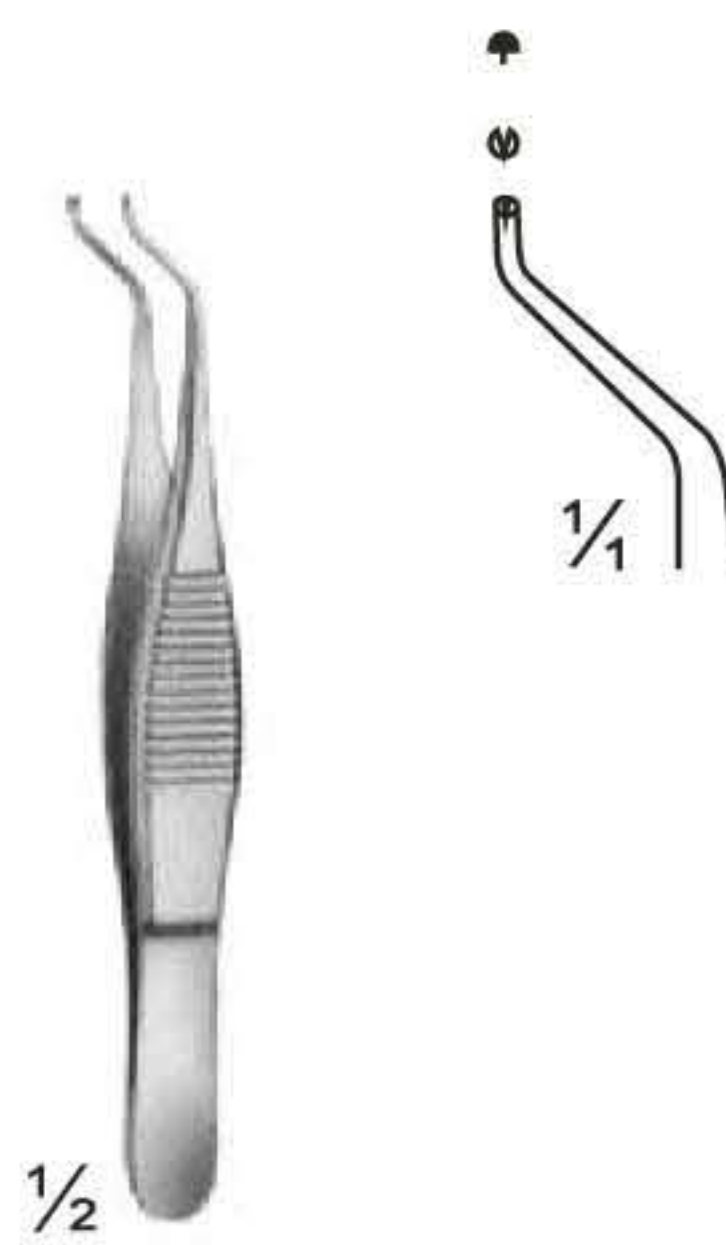

UG-249
HESS
70 mm

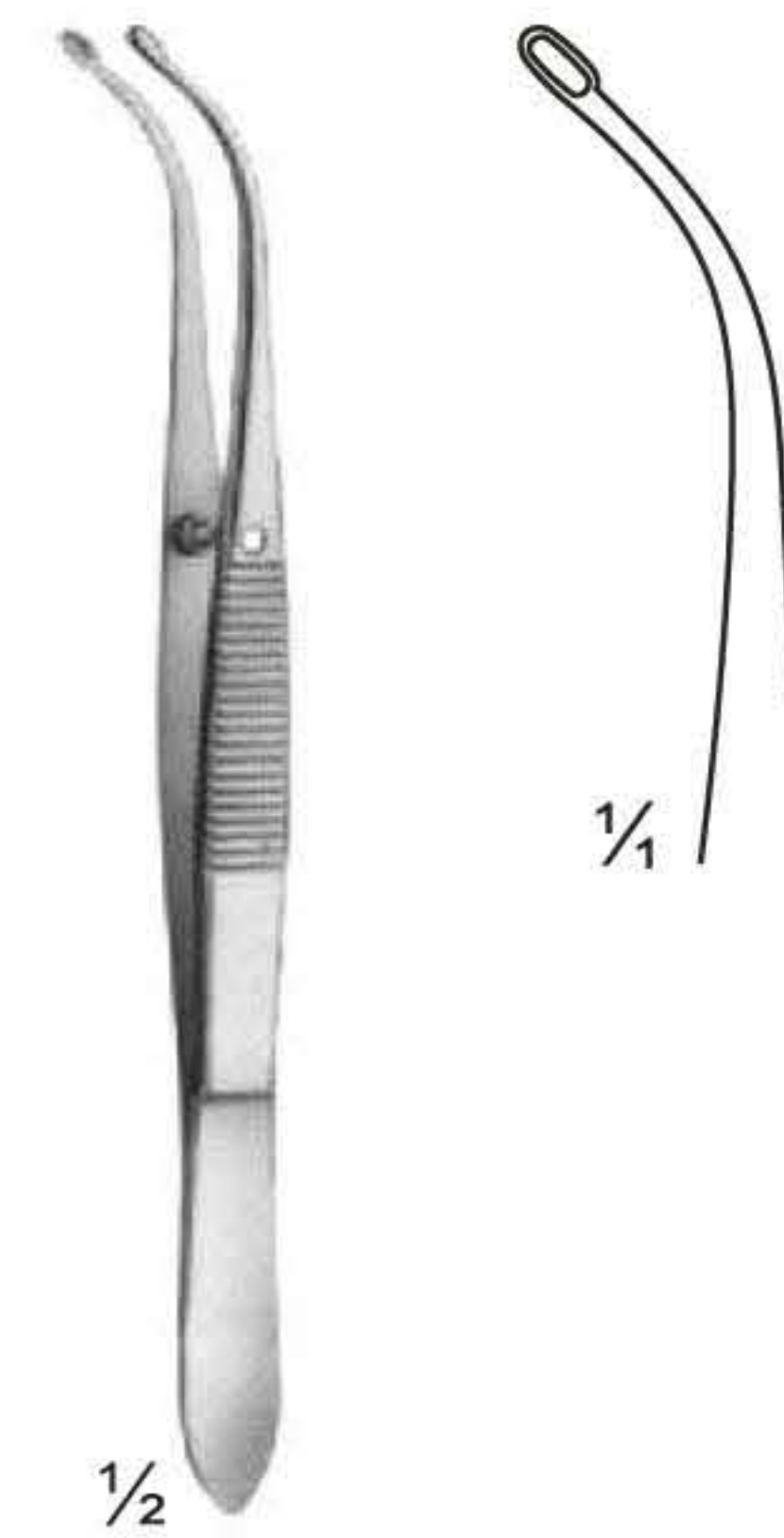

UG-250
ARRUGA
100 mm

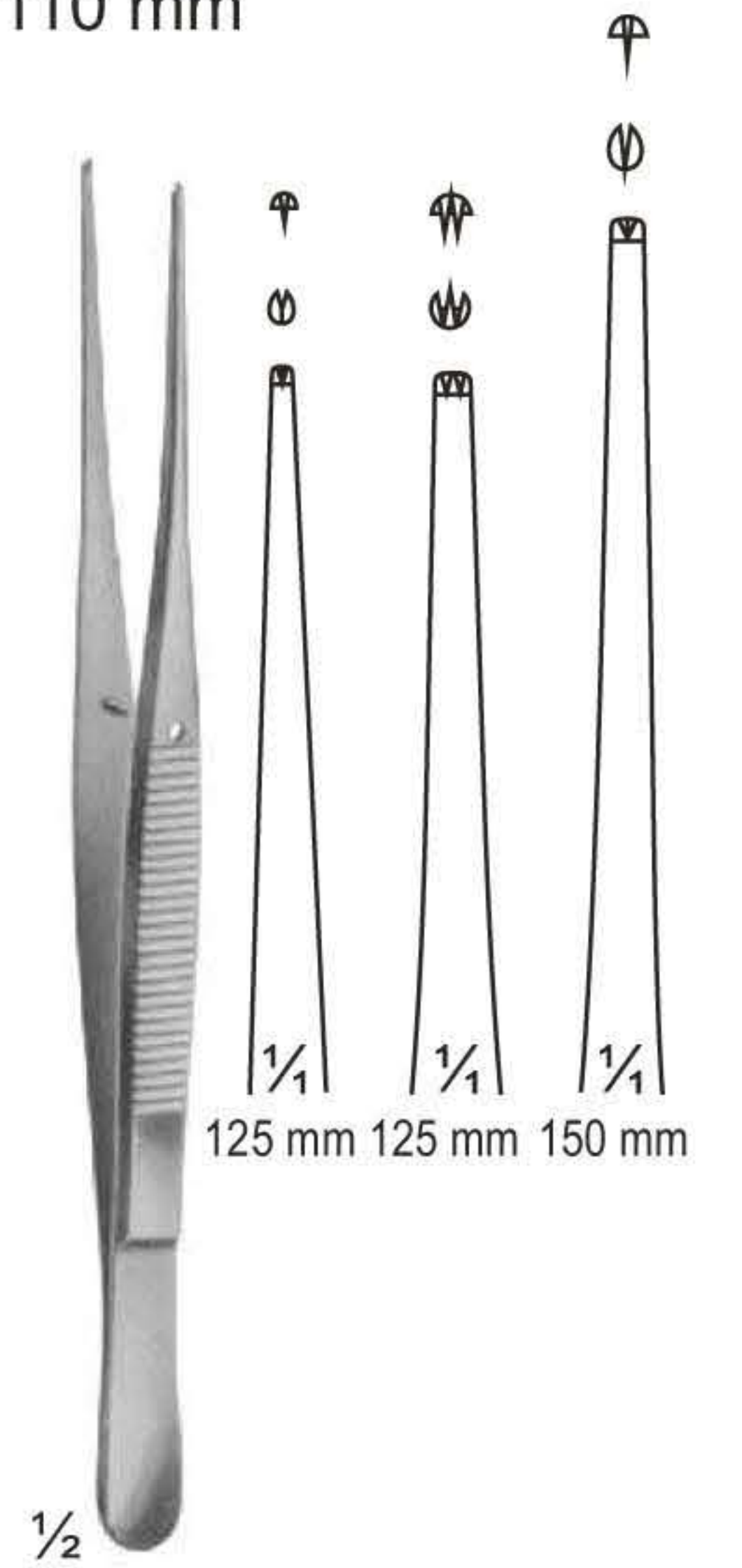

UG-251
SEMKEN
125 mm 125 mm 150 mm

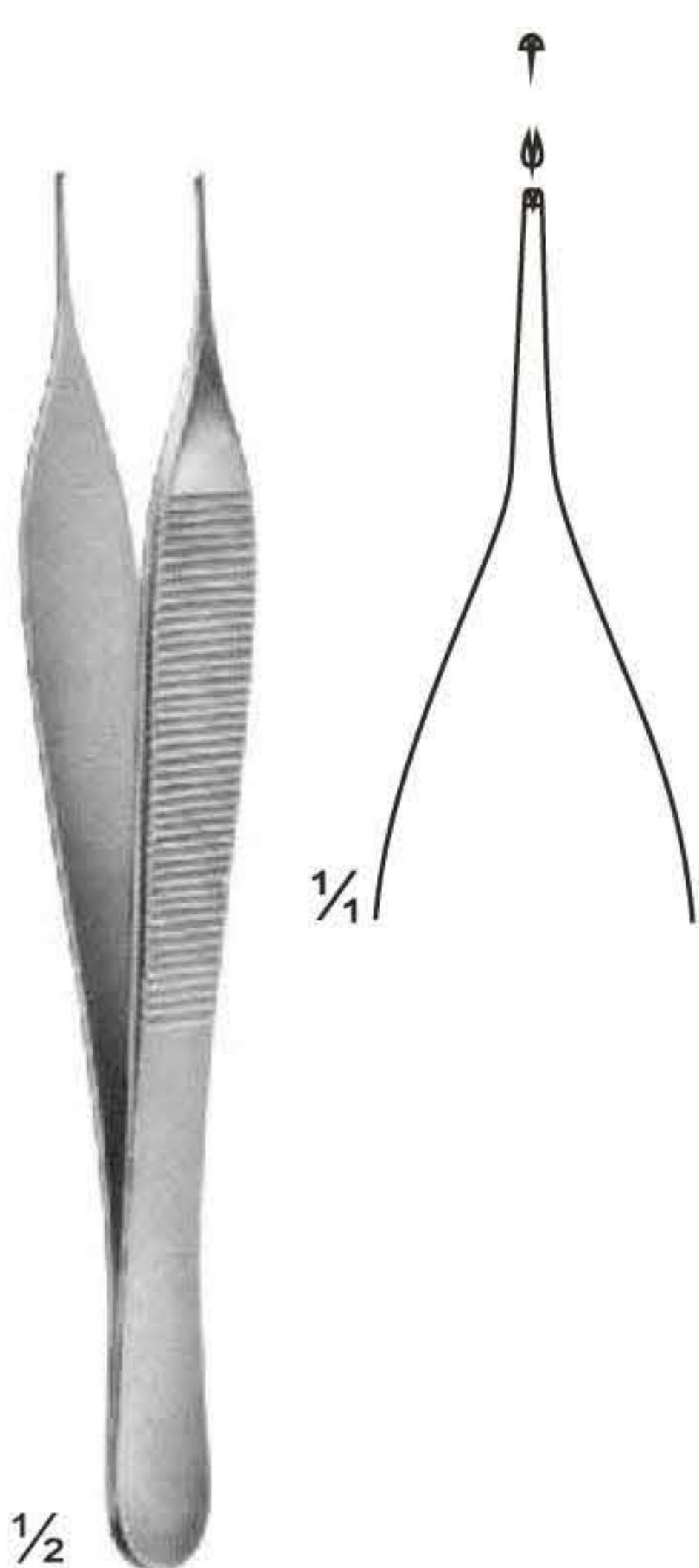

UG-252
MICRO-ADSON
120 mm

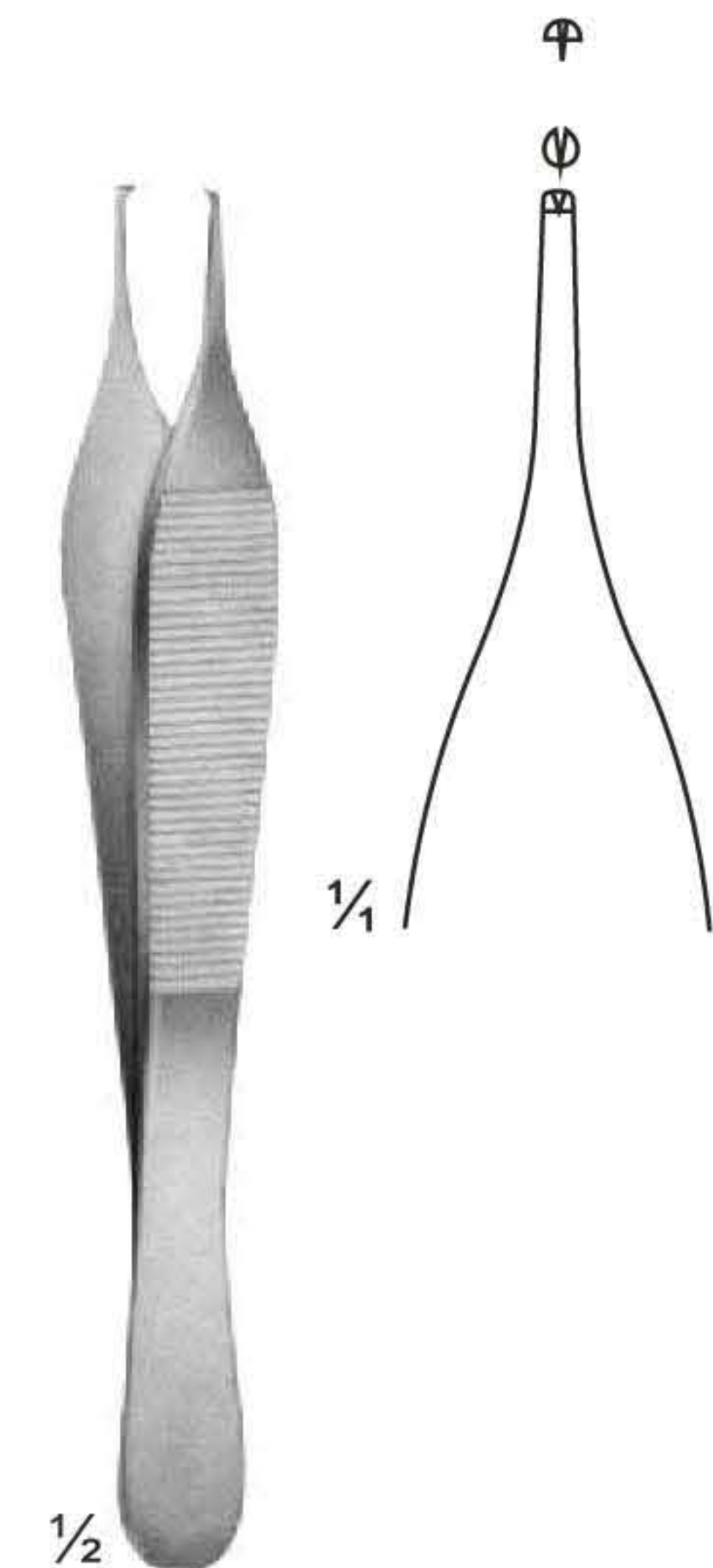

UG-253
ADSON
120 mm

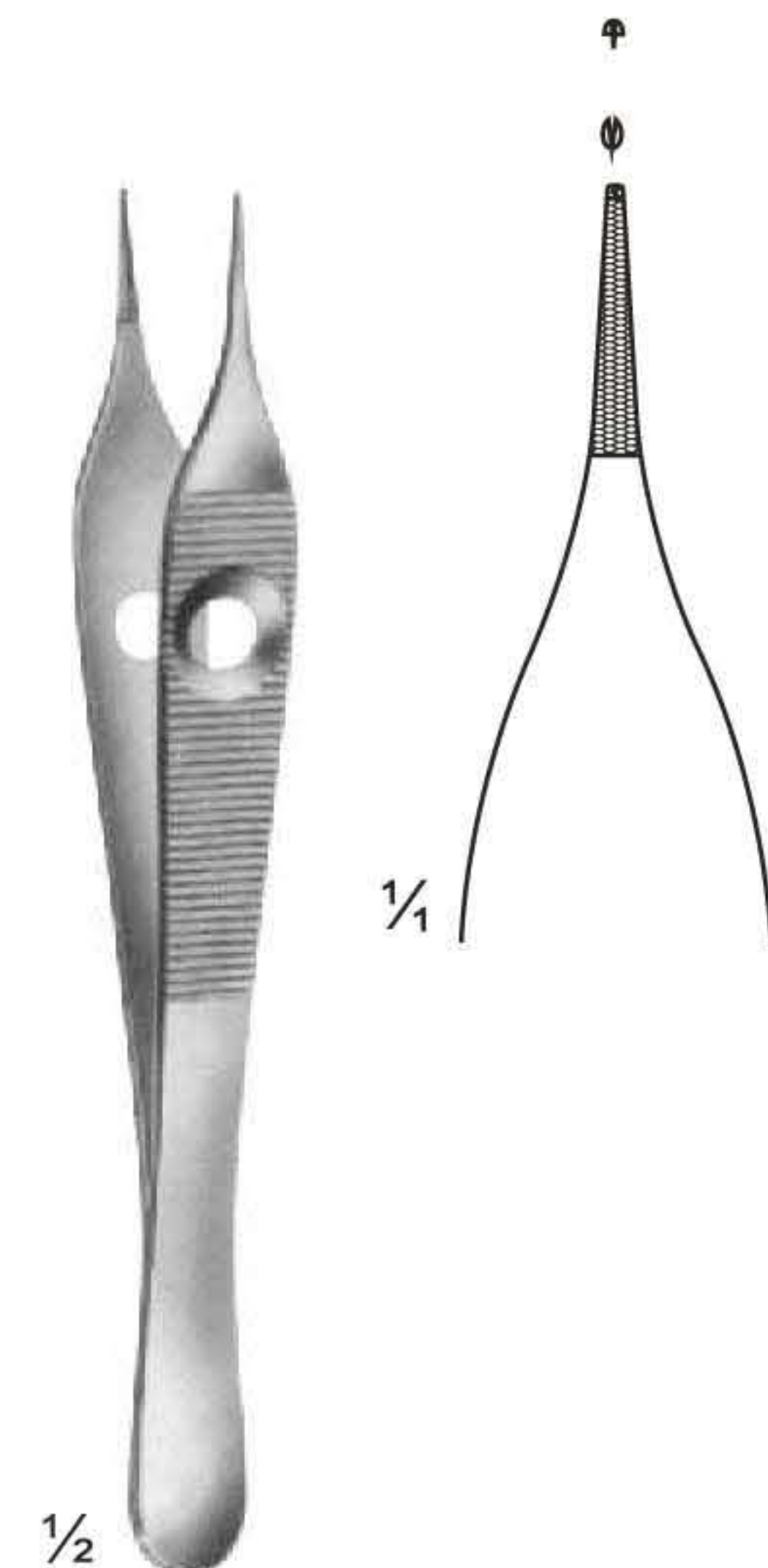

UG-254
ADSON
120 mm



UG-255
ADSON
120 mm

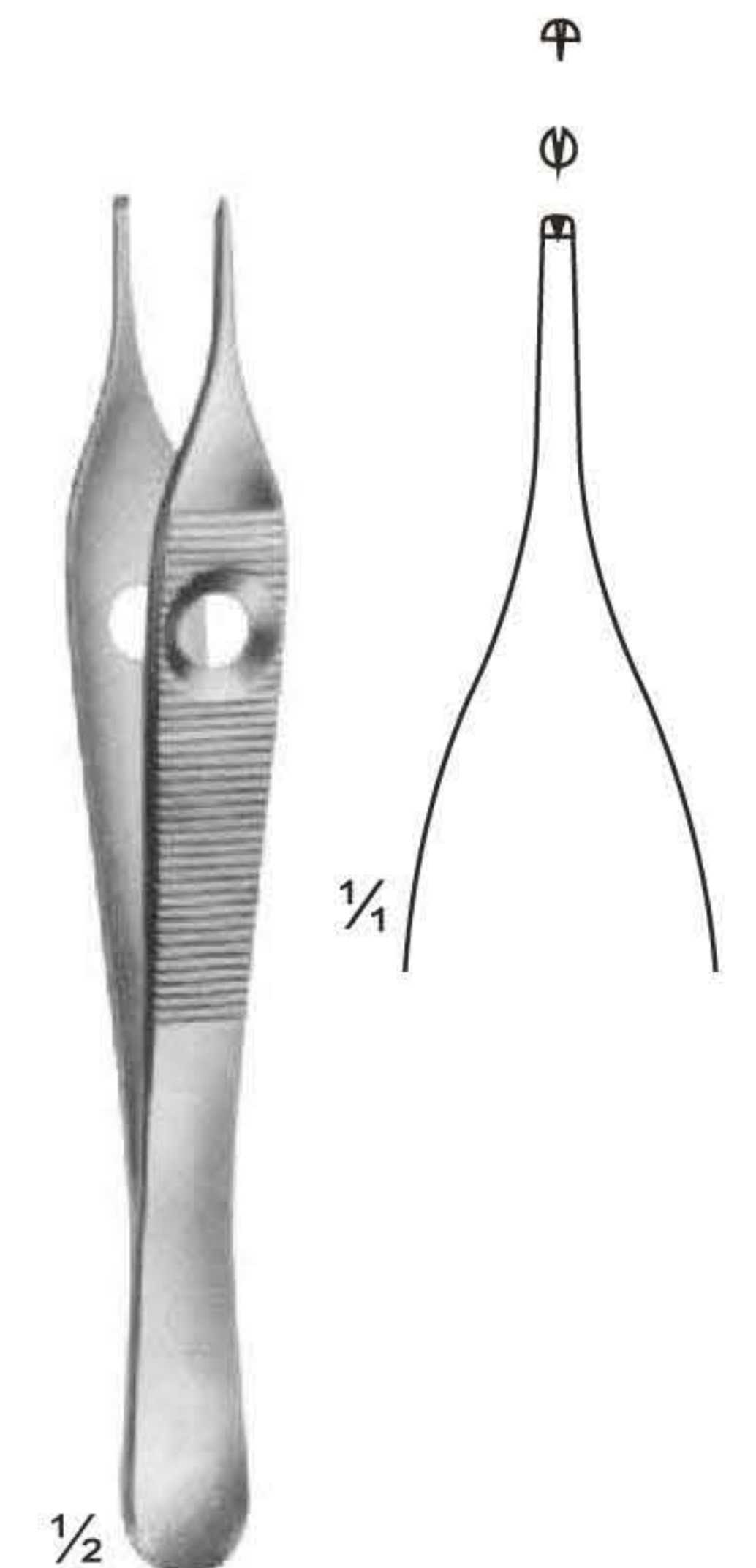

UG-256
ADSON
150 mm

Tissue Forceps

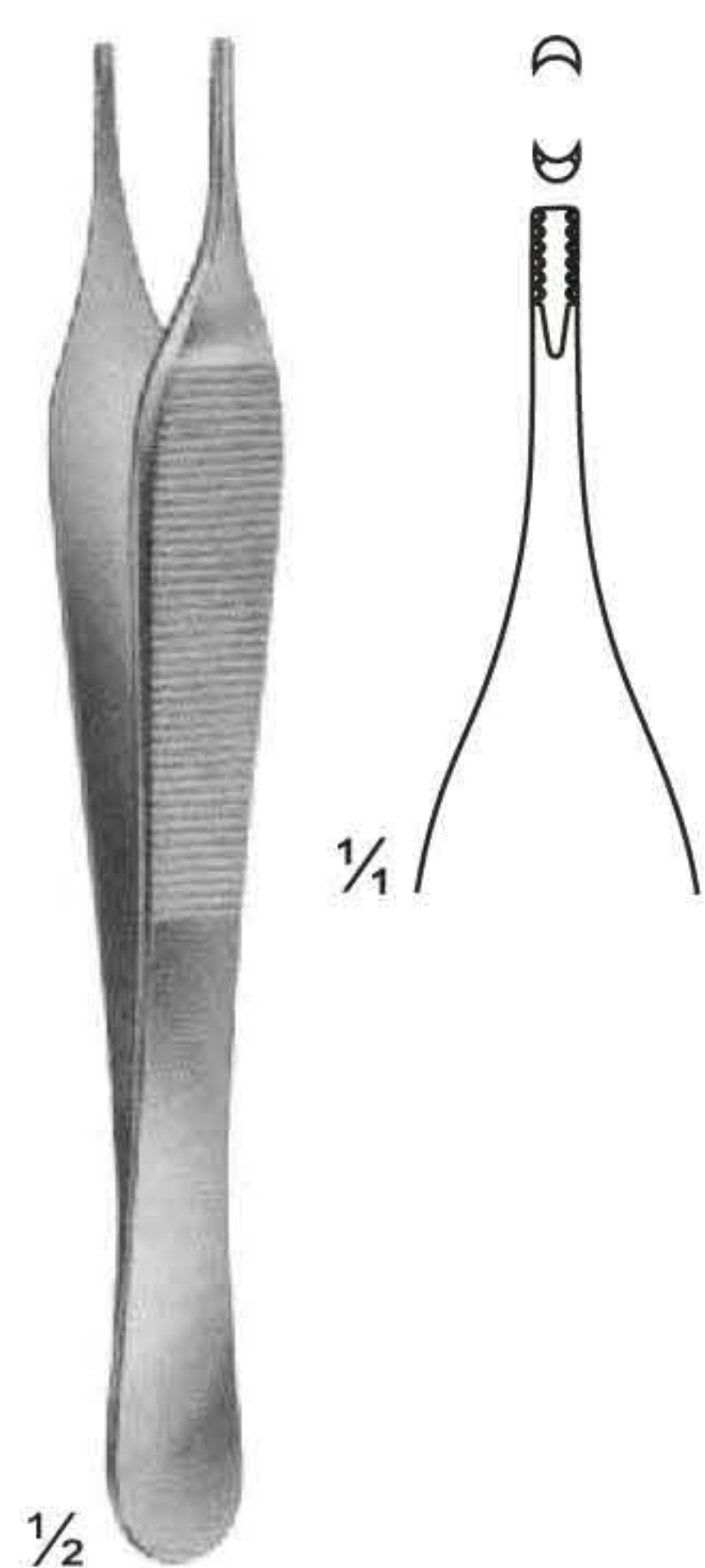

UG-257
ADSON - BROWN
Non-traumatic
120 mm

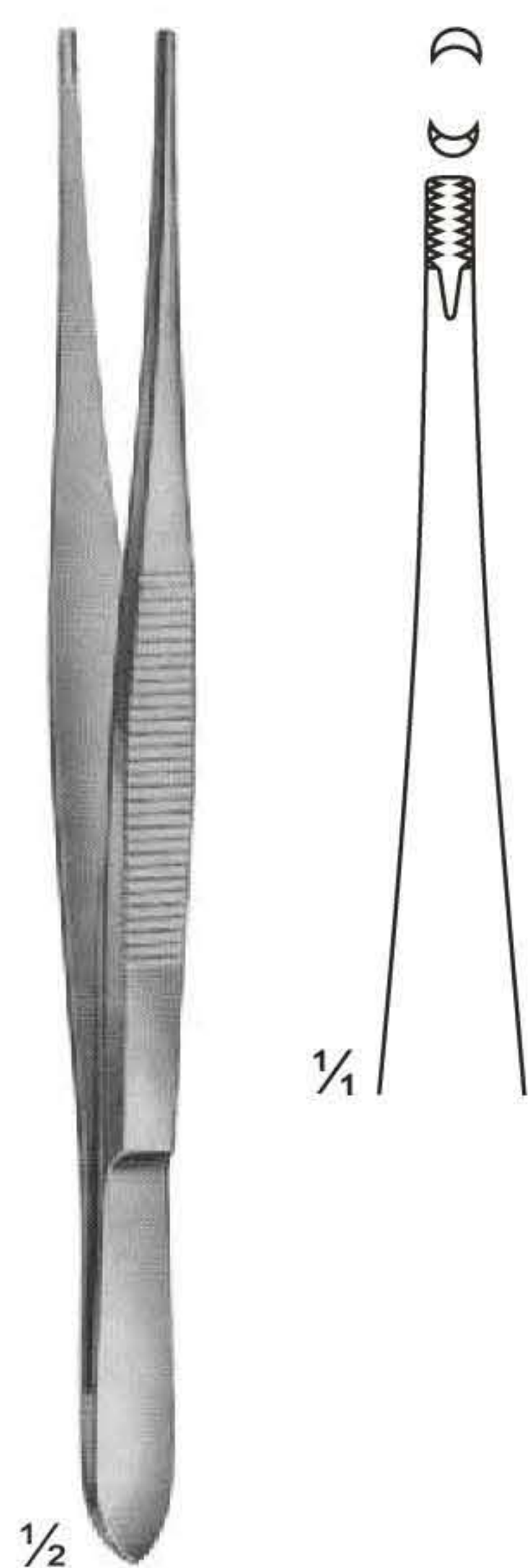

UG-258
BROWN
120 mm

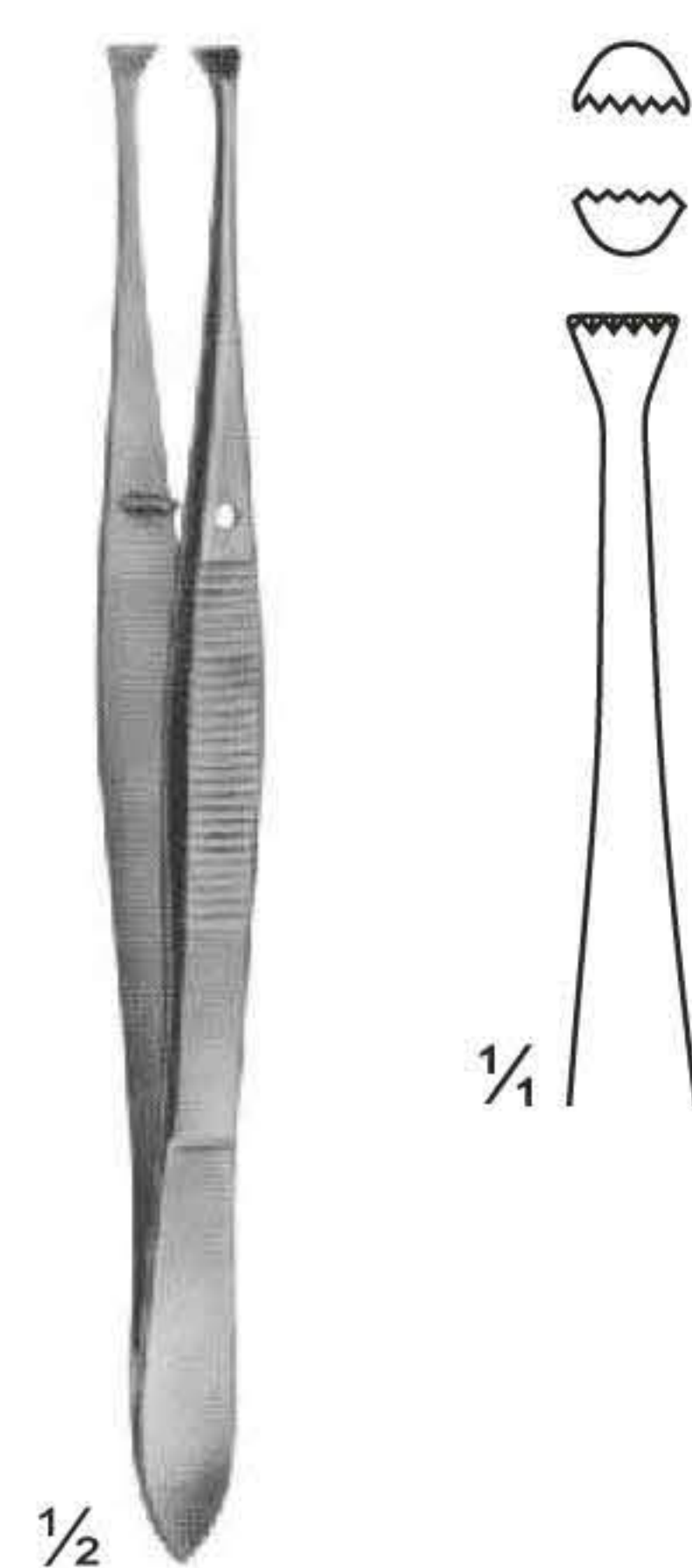

UG-259
GRAEFE
110 mm

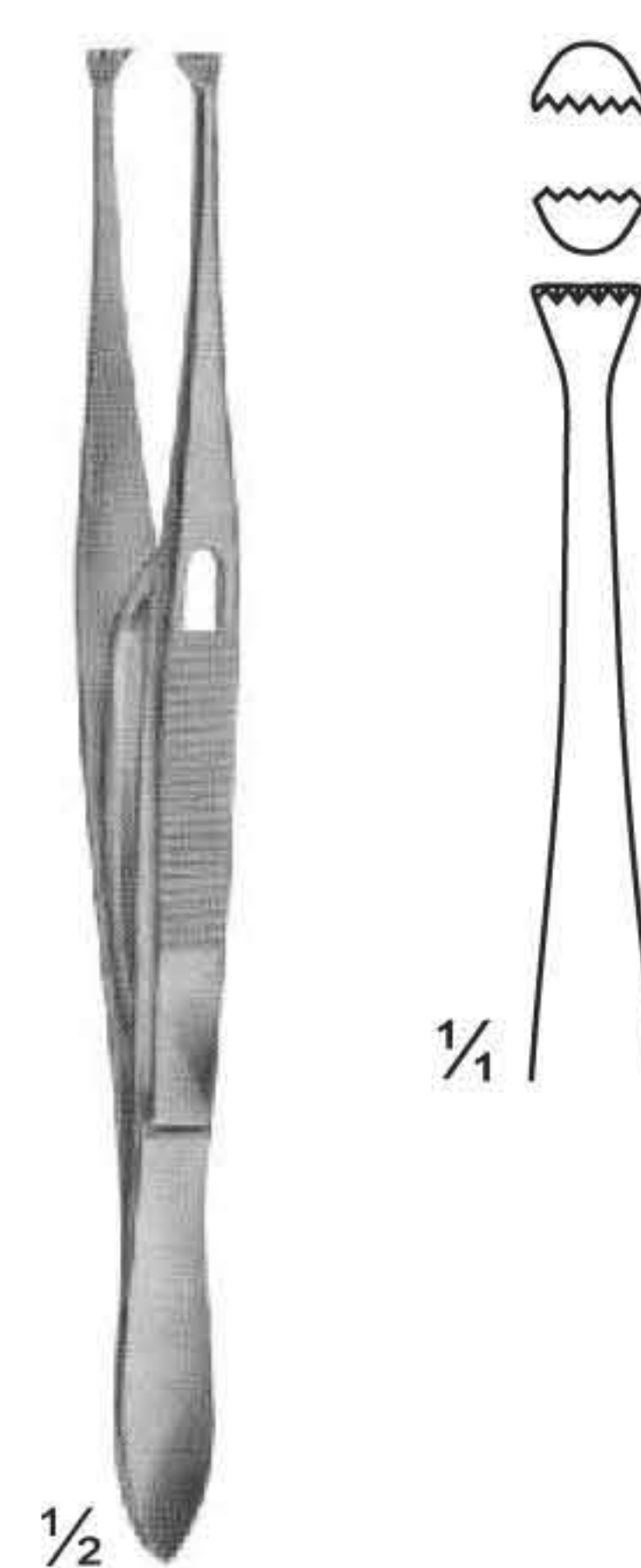

UG-260
GRAEFE
With Catch
110 mm



UG-262
STANDARD



UG-266
GRAEFE
110 mm

Tissue Forceps



1/2
UG-270
3x4 teeth



1/2
UG-272
MC INDOE



1/2
UG-274
GILLIES



1/2
UG-276
GERALD



1/2
UG-278
WAUGH



1/2
UG-281
BROPHY

Tissue Forceps, Lung Dissecting Forceps



1/2
UG-285
LANE



1/2
UG-294
**STRASSBURGER
MODELL**

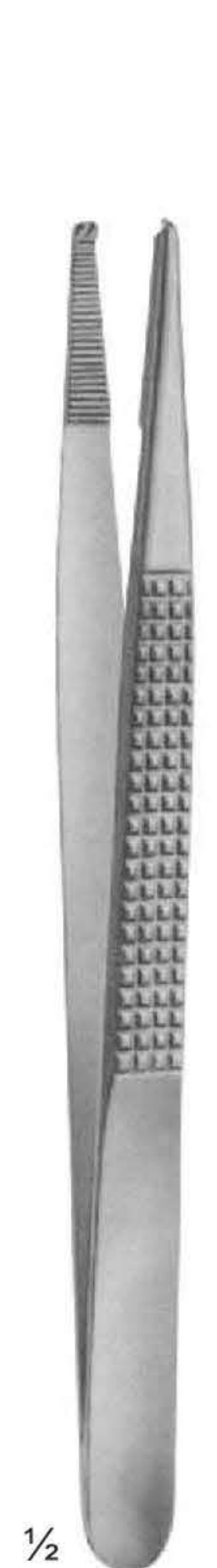

1/2
UG-296
BONNEY



1/2
UG-297
RUSS. MODELL
200 mm

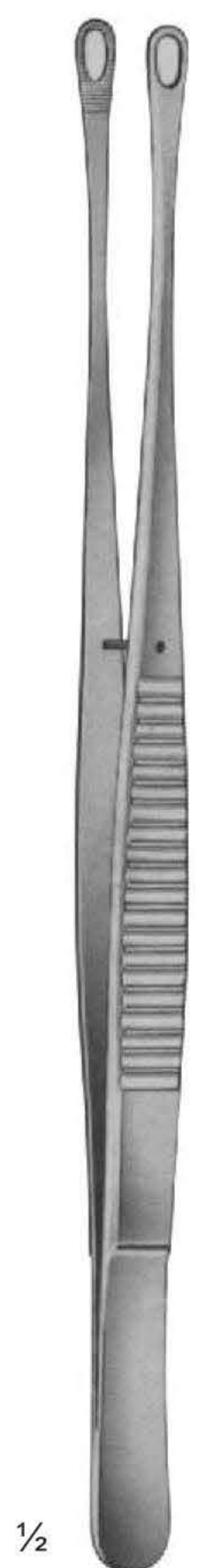

1/2
UG-299
TUTTLE
Lung Dissecting Forceps
230 mm

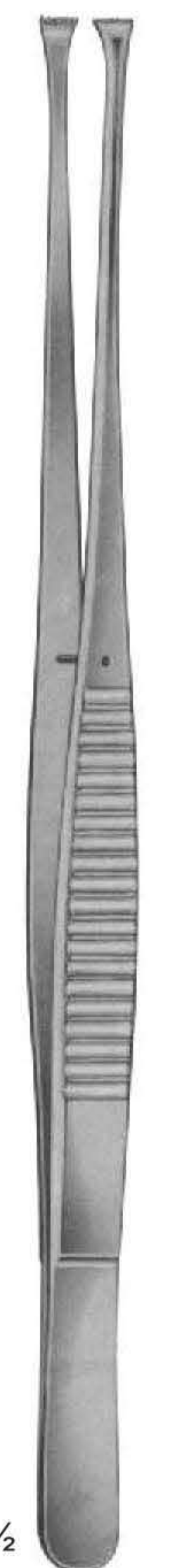

1/2
UG-300
NELSON
Lung Dissecting Forceps
230 mm

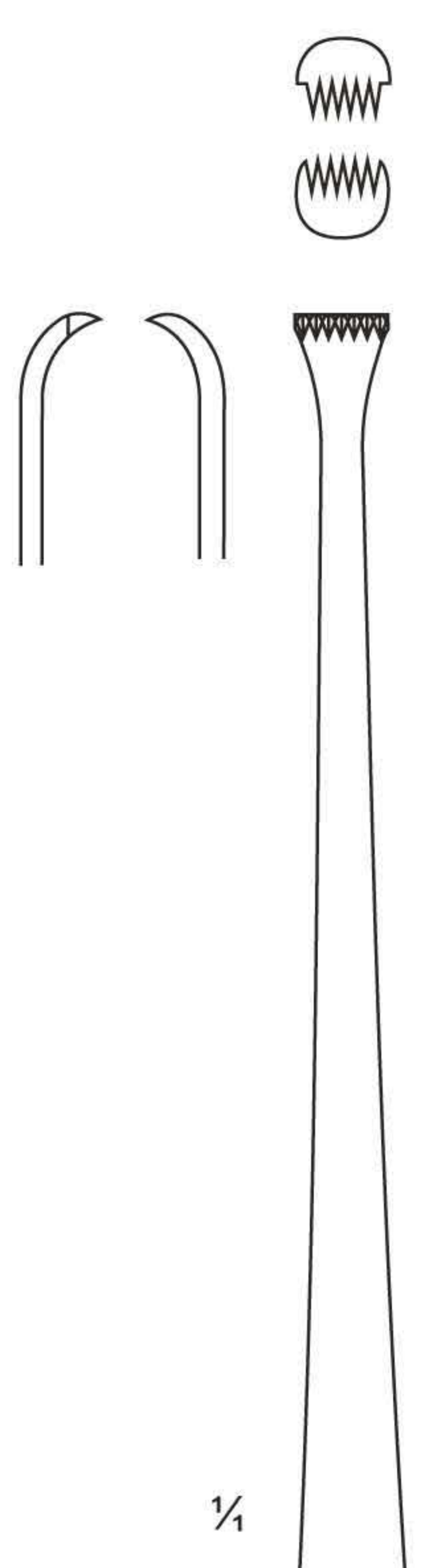

1/2
UG-303
DUVAL
Intestinal Forceps
140 mm

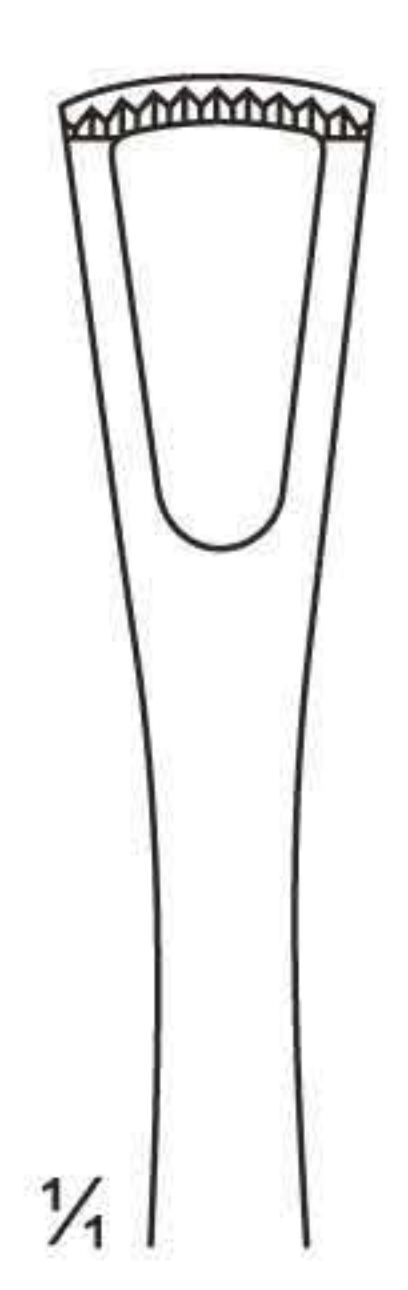

1/2
UG-306
DENIS-BROWNE
Intestinal Forceps
190 mm

Splinter and Cilia Forceps

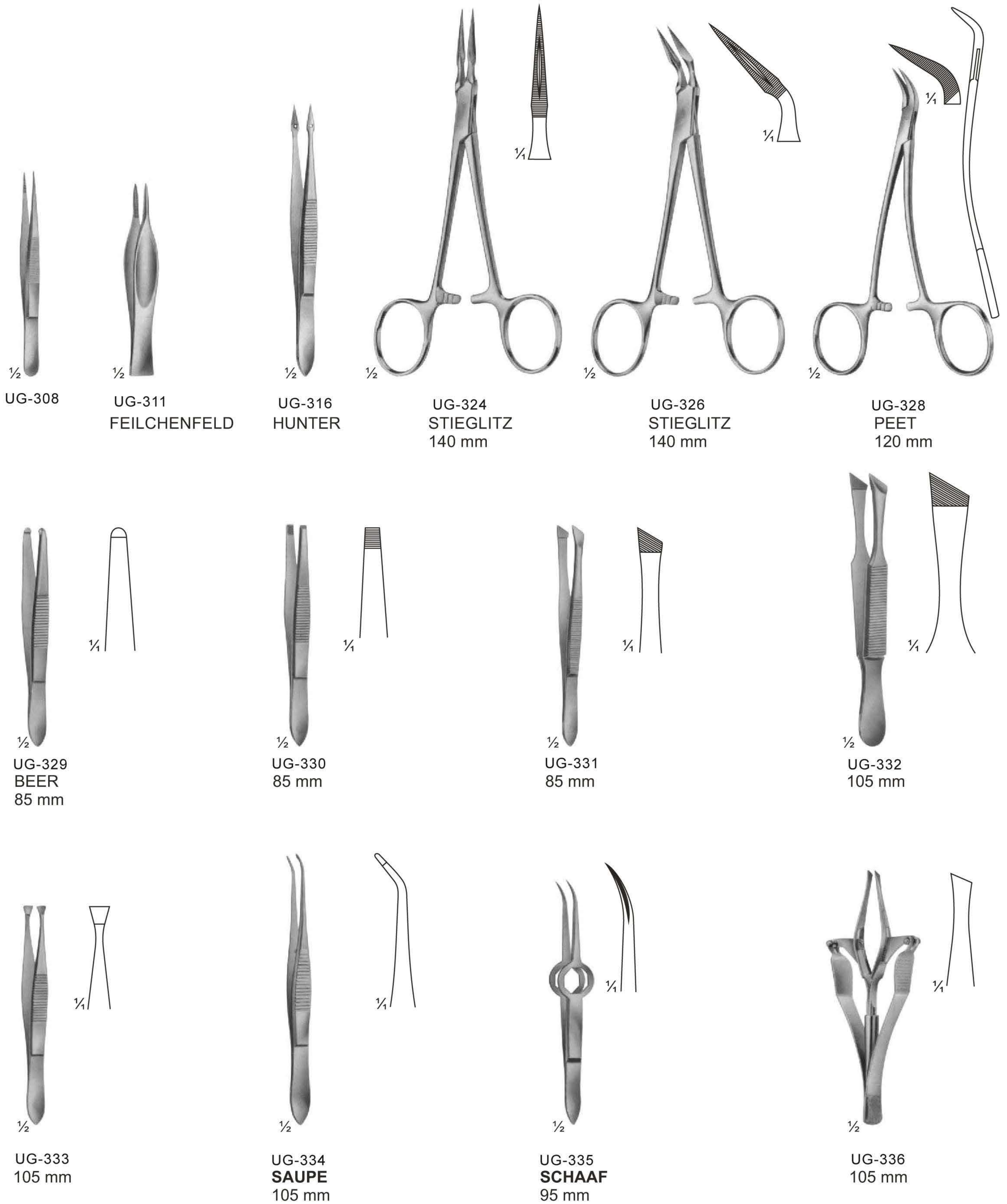

Sponge and Dressing Forceps

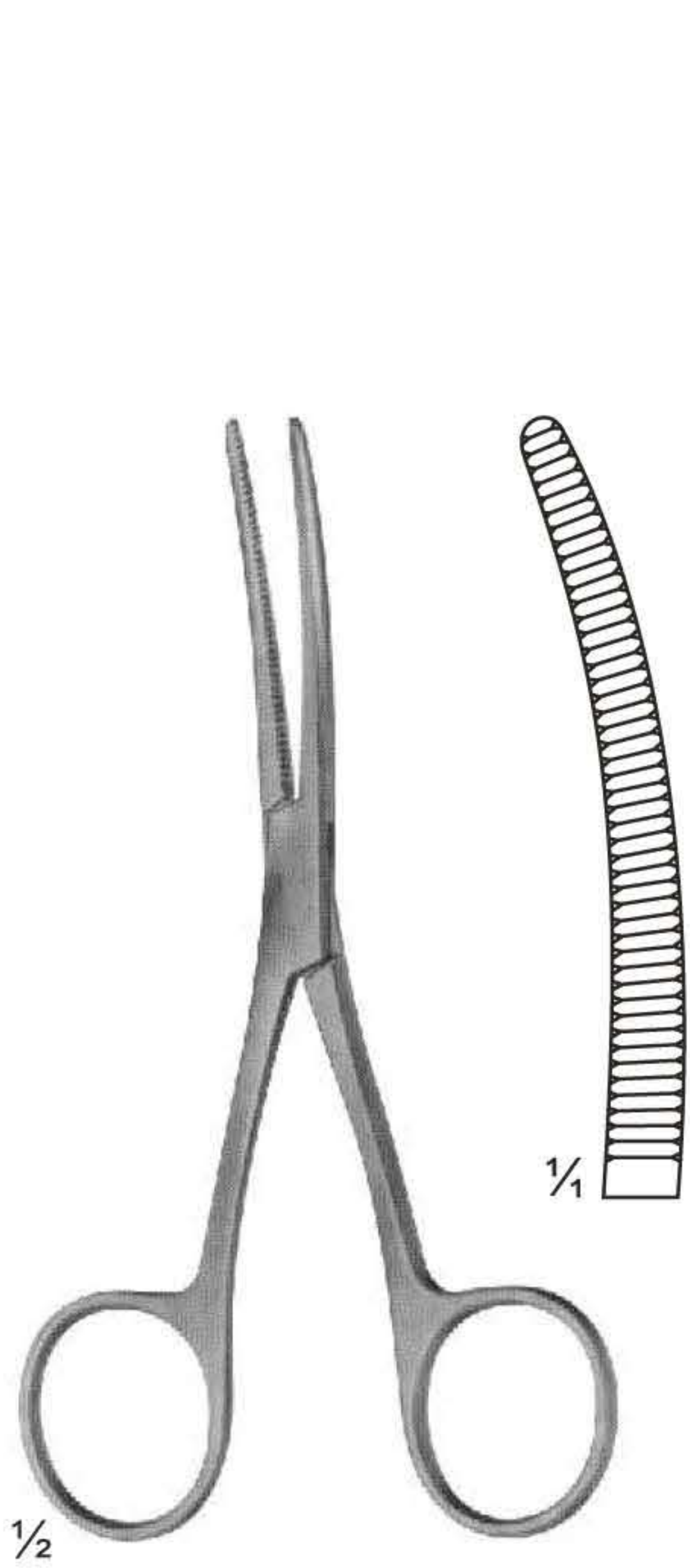

UG-337
BRYANT
130 mm

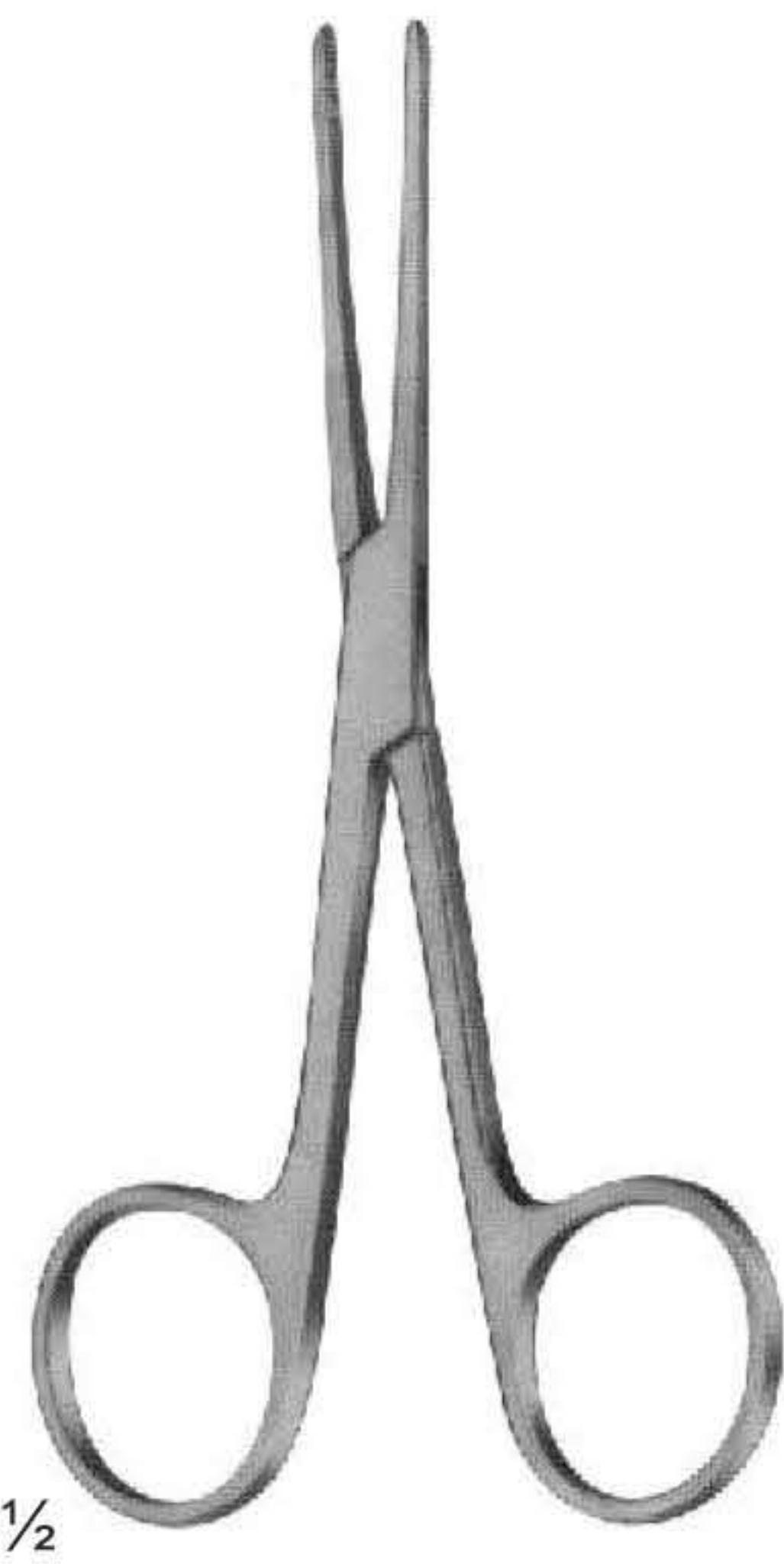

UG-338
LISTER
Sinus Forceps

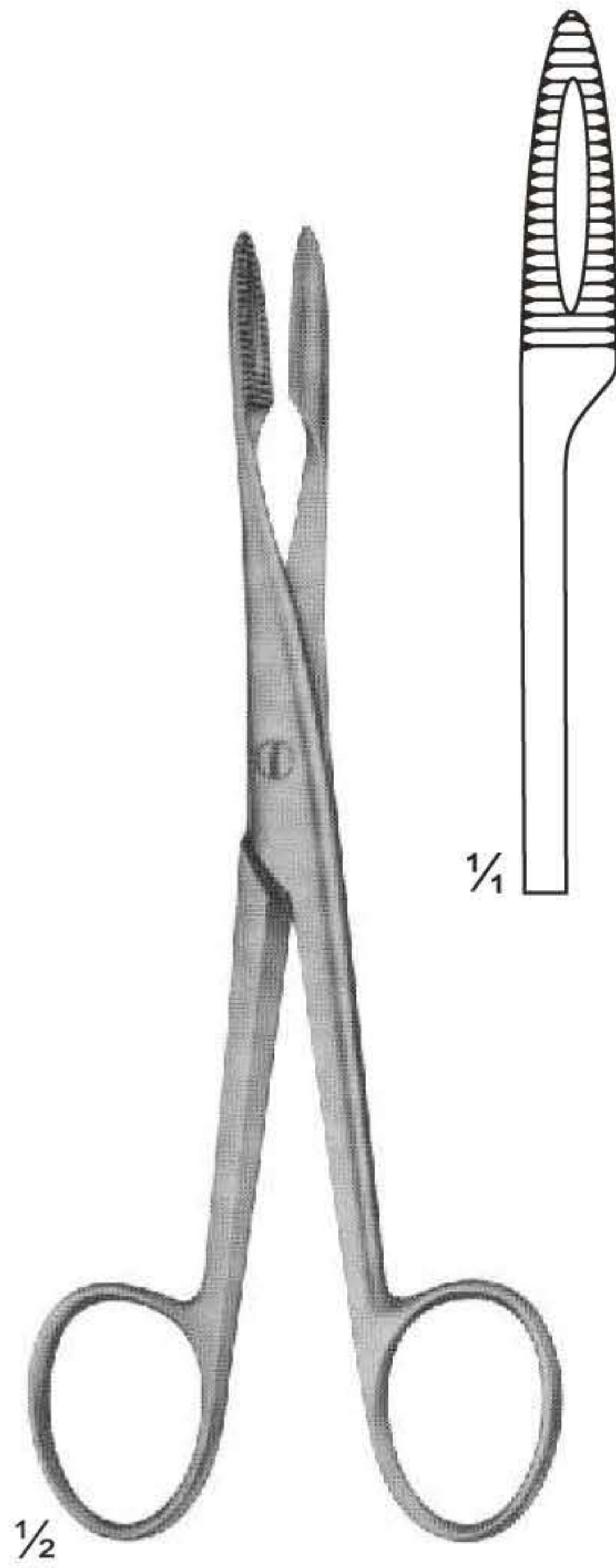

UG-343
Without Ratchet
145 mm

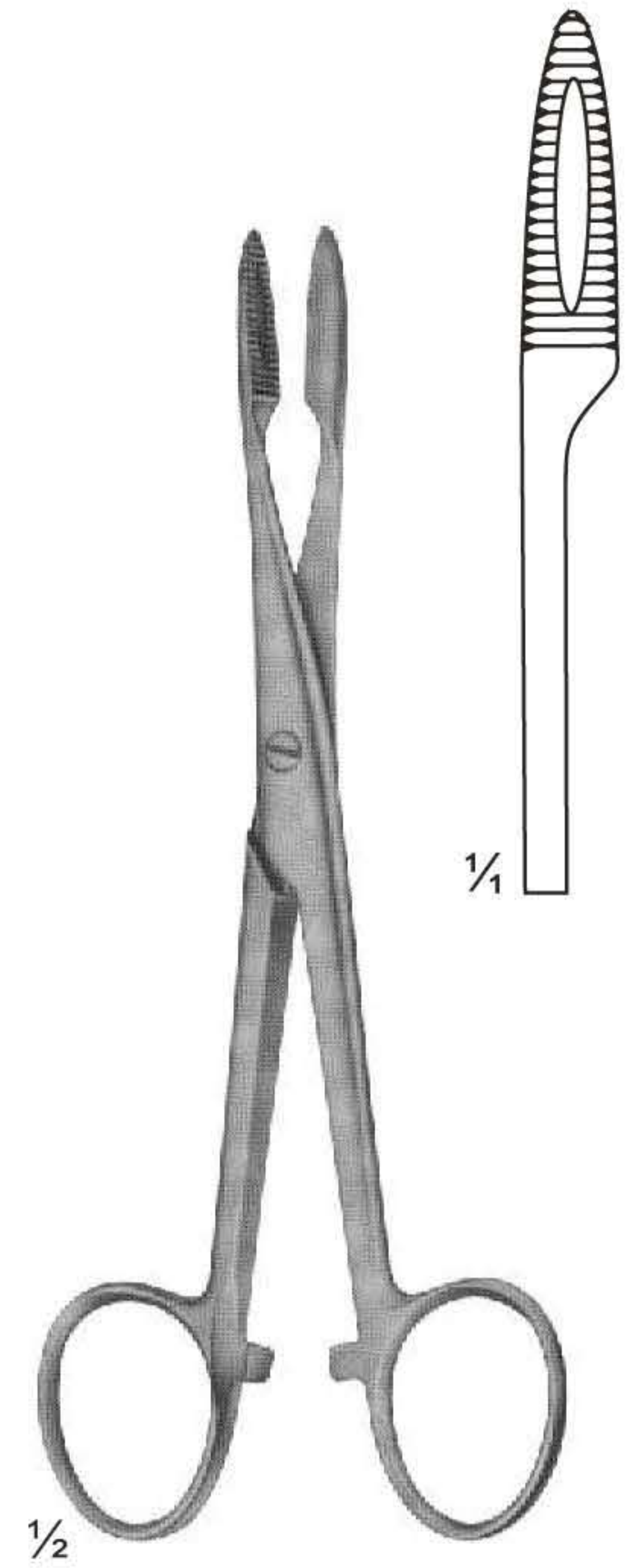

UG-345
With Ratchet
145 mm

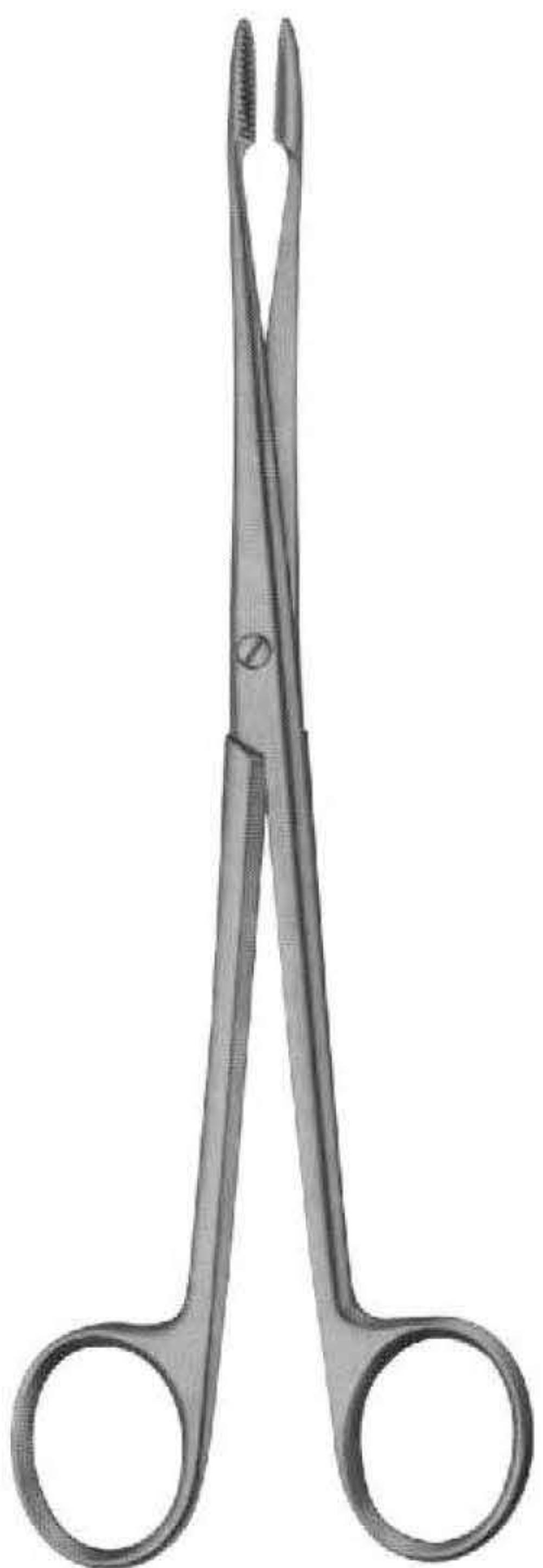

UG-350
GROSS
Without Ratchet
200 mm

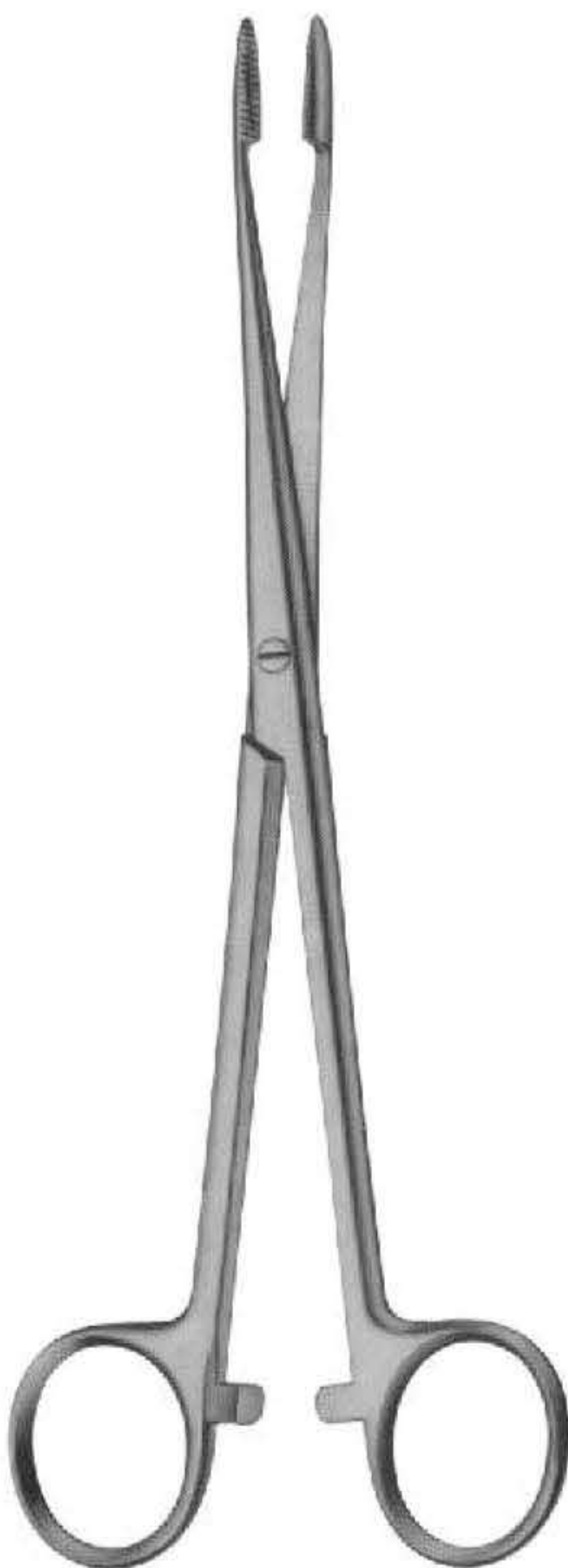

UG-355
GROSS
With Ratchet
180 mm

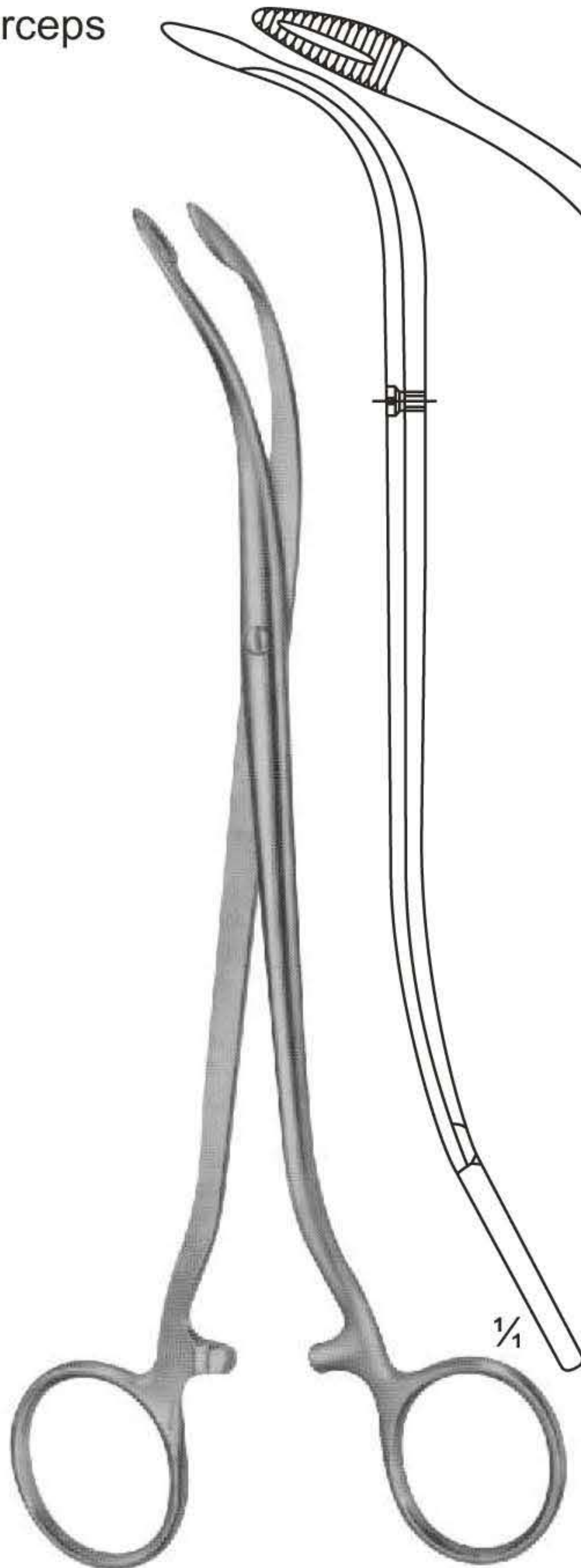

UG-359
DUPLAY
190 mm

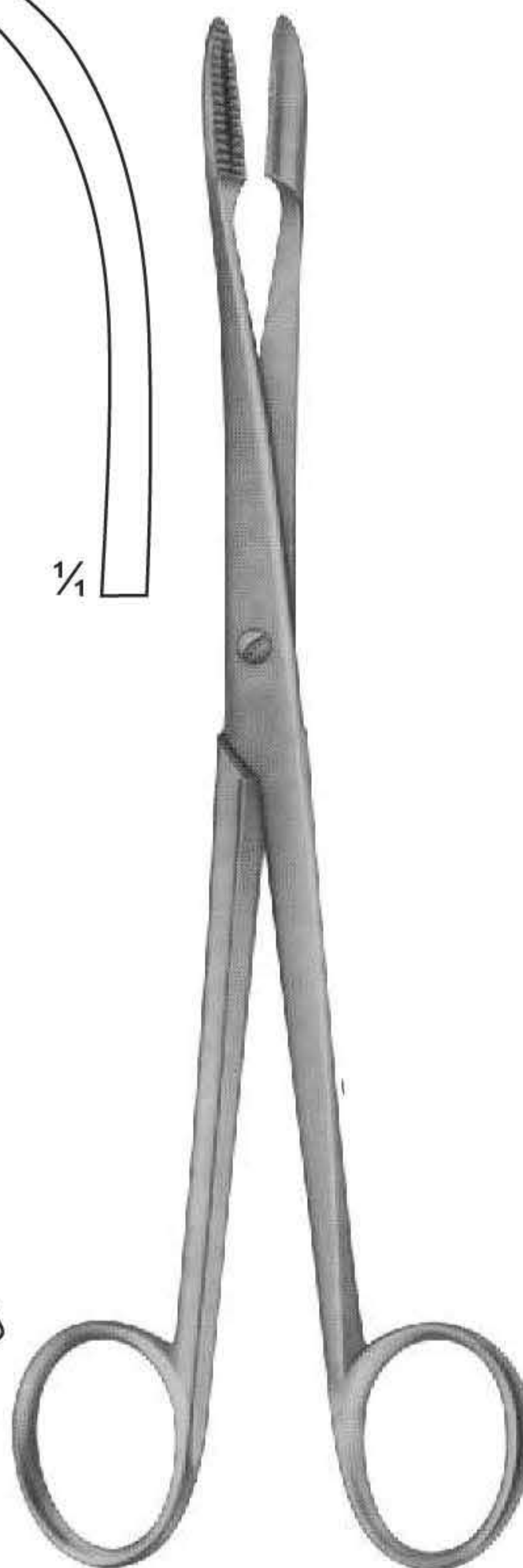

UG-362
GROSS
Without Ratchet
200 mm



UG-363
GROSS
With Ratchet
200 mm

Sponge and Dressing Forceps

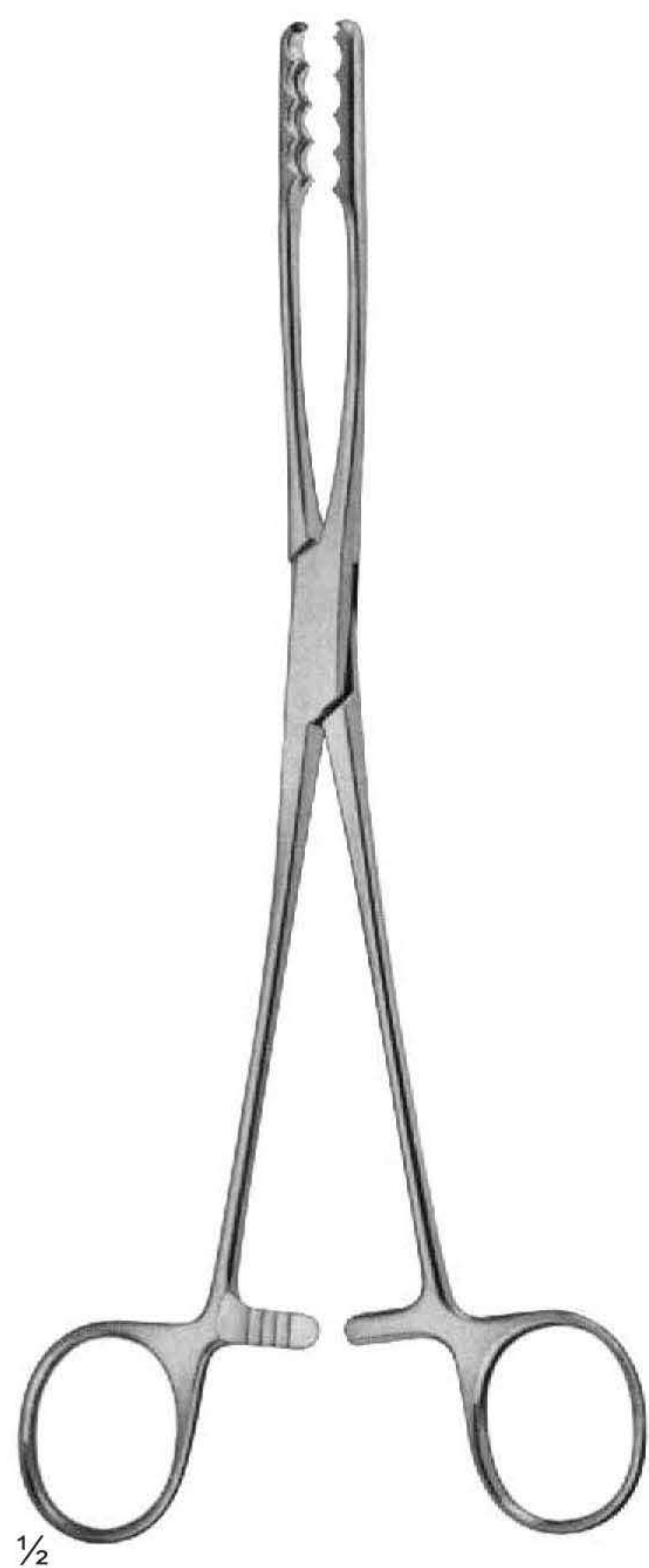

UG-365
AESCULAP
220 mm



UG-367
MAIER
Without Ratchet
265 mm



UG-370
MAIER
With Ratchet
265 mm

Sponge and Dressing Forceps



UG-450
SIMS-MAIER
280 mm

UG-452
COLLIN
240 mm

UG-454
CHERON
Handles Laterally Angled
240 mm

UG-455
EMMET
210 mm

Dressing, Sponge holding, Organ and Tissue Grasping Forceps

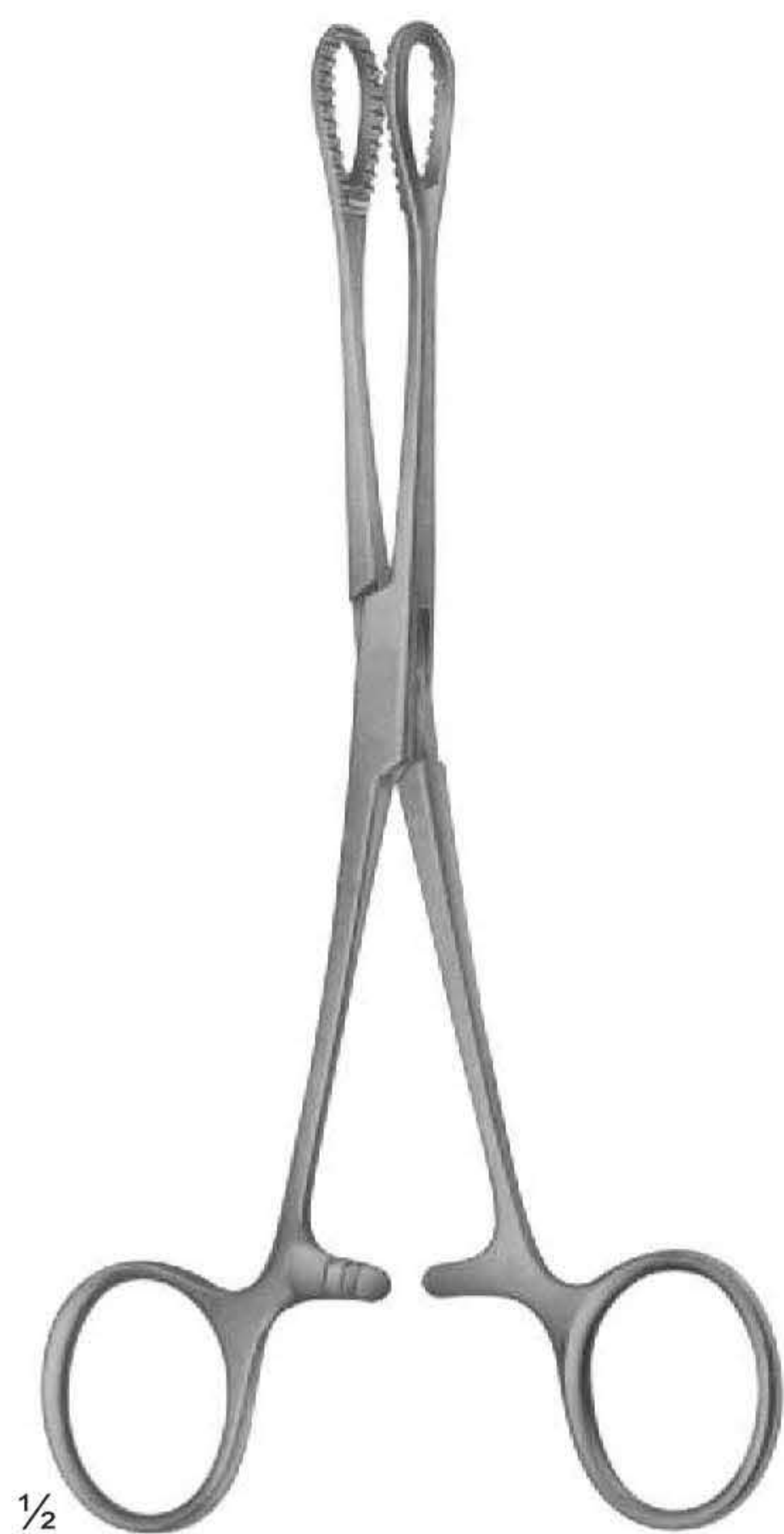

1/2

UG-456
FOERSTER-BALLENGER
180 mm



1/2

UG-458
RAMPLEY



1/2

UG-460
FOERSTER-BALLENGER
240 mm

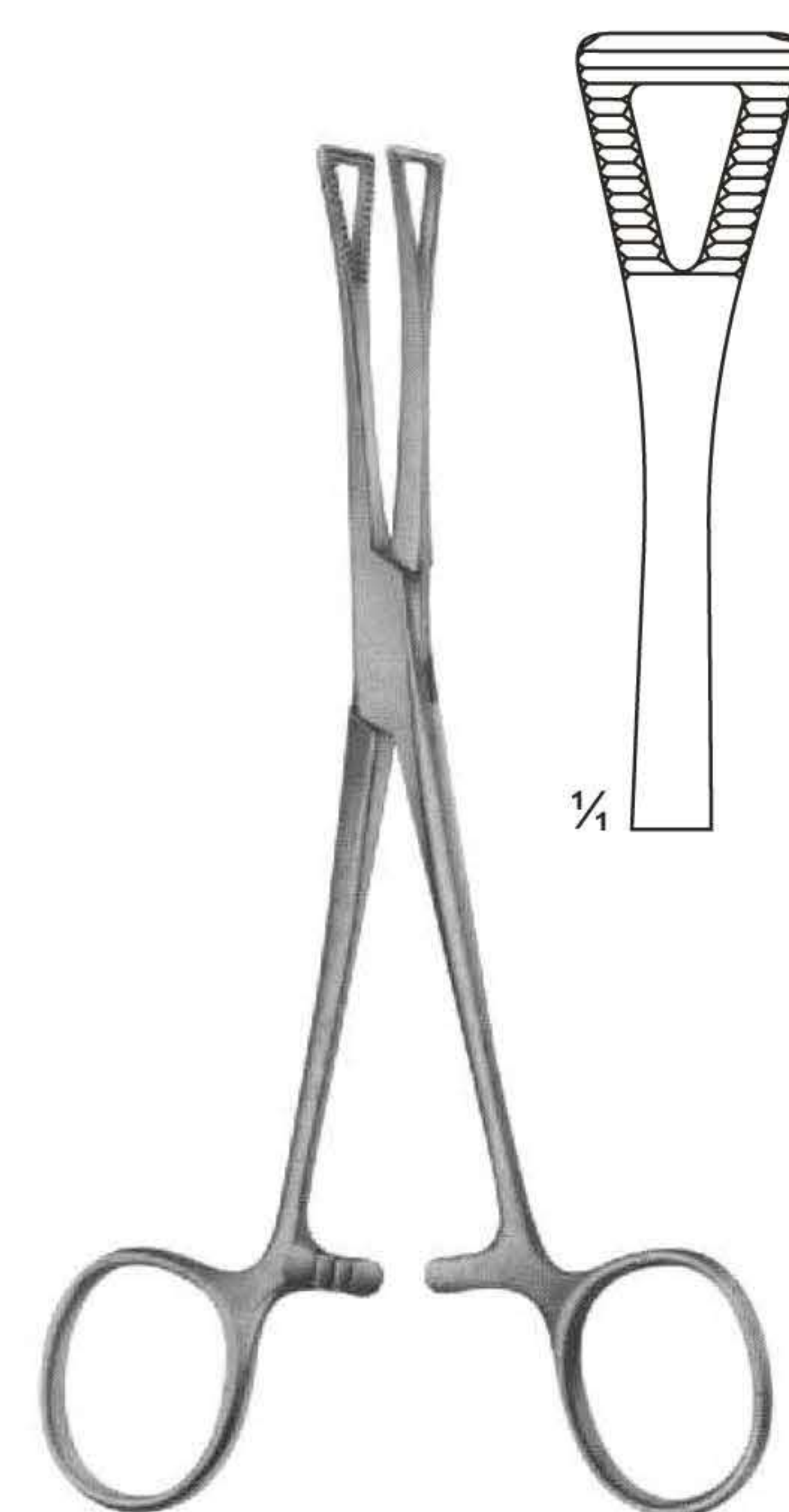

1/4

UG-462
PENNINGTON
155 mm

Dressing, Sponge holding, Organ and Tissue Grasping Forceps



UG-464
COLLIN



UG-466
COLLIN

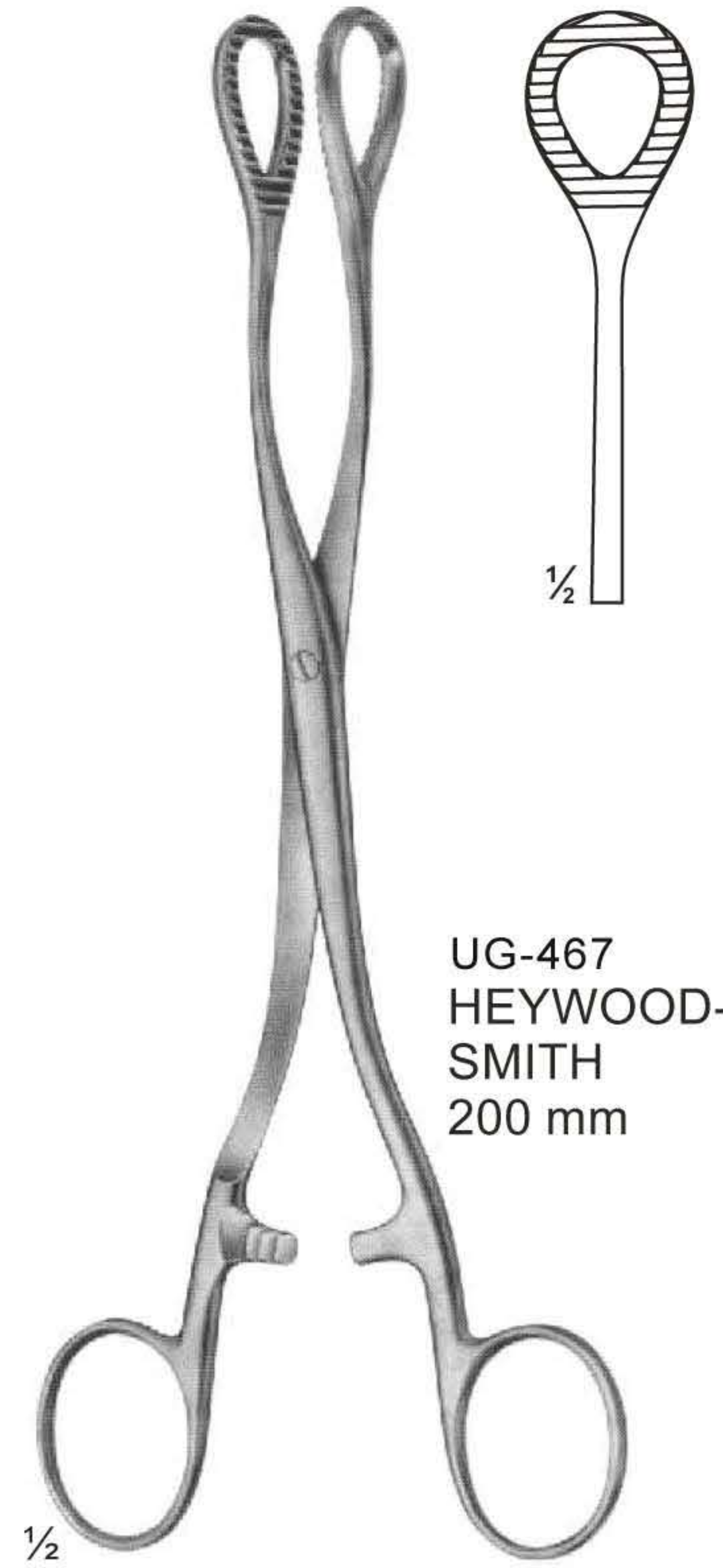

UG-467
HEYWOOD-
SMITH
200 mm

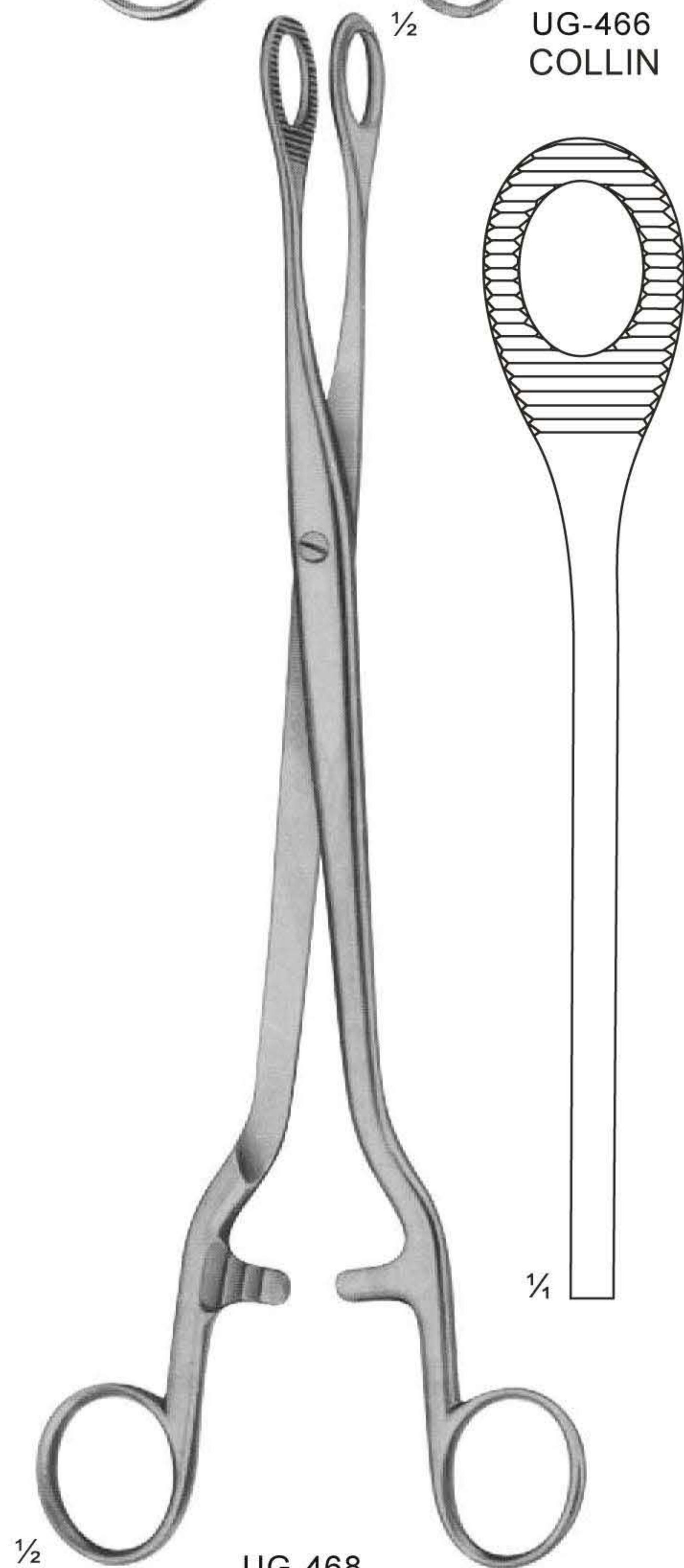

UG-468
NOTO
280 mm

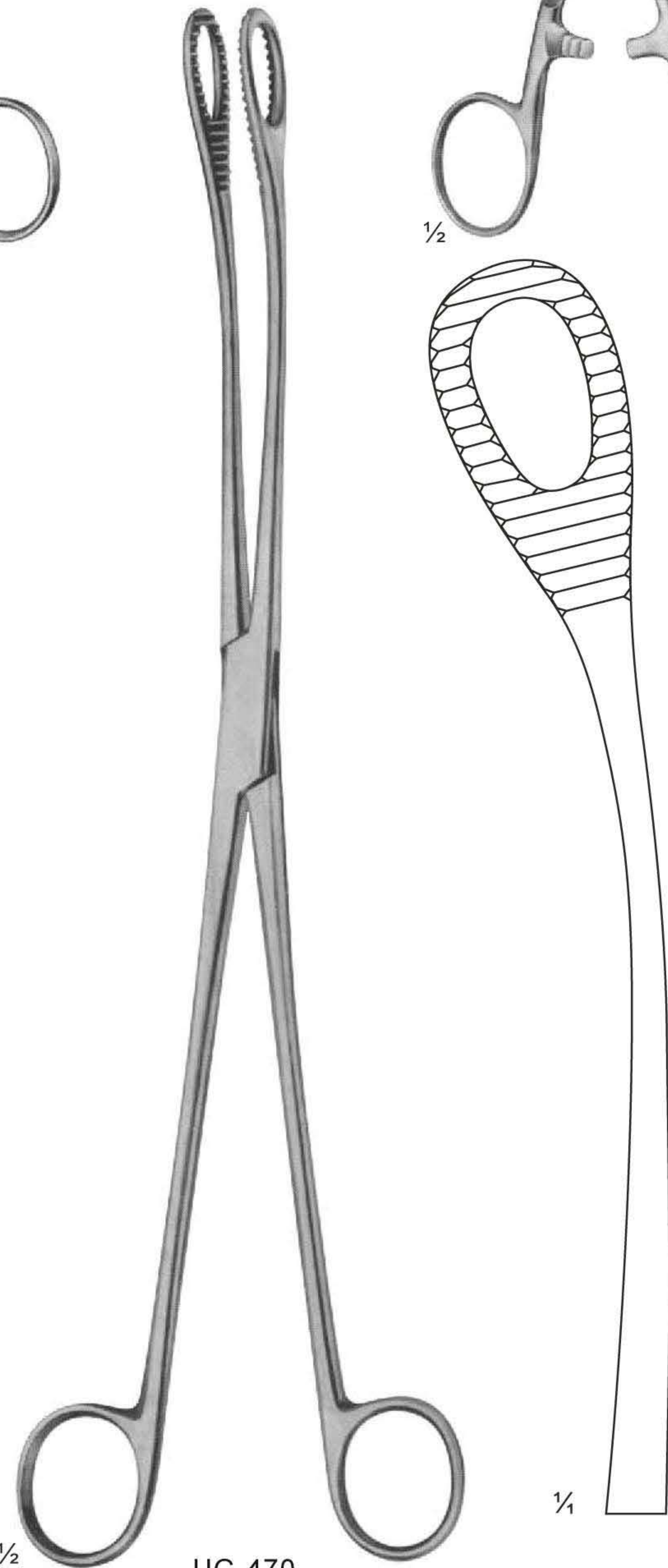

UG-470
KELLY
320 mm

Tendon Seizing Forceps



1/2
UG-471
HERZ
155 mm



1/2
UG-473
JACKSON
4 x 5 teeth
150 mm

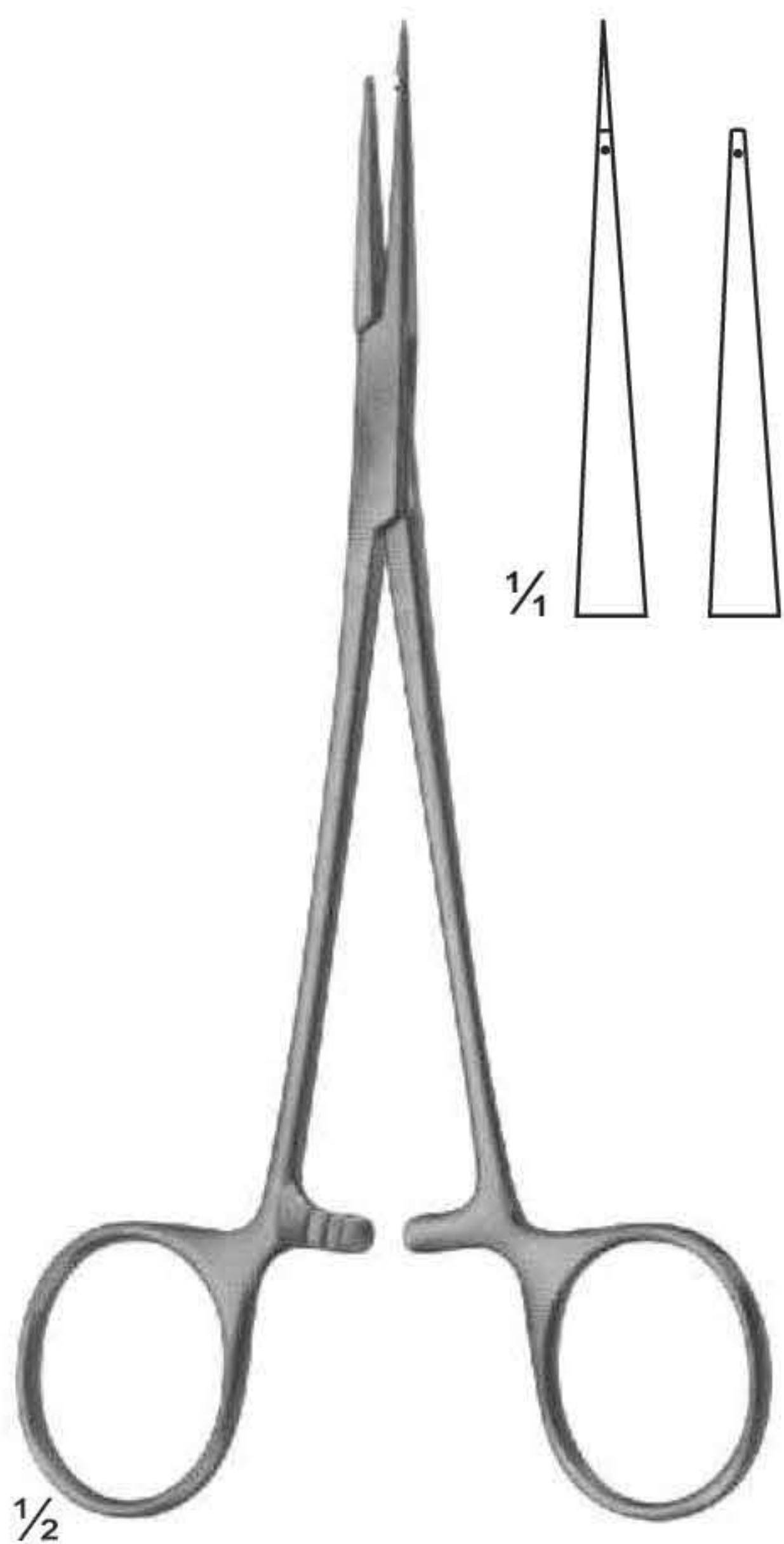

1/2
UG-474
150 mm

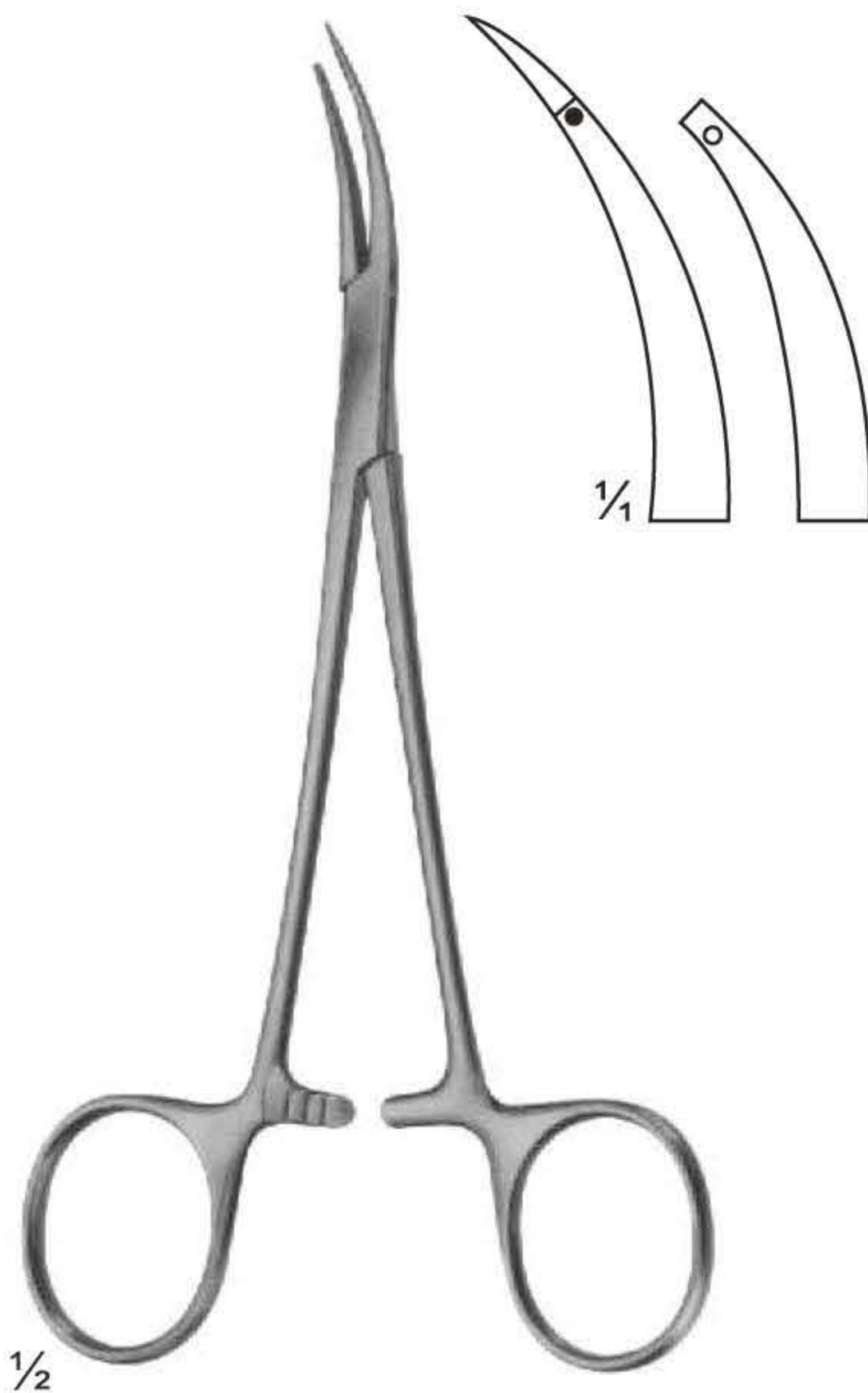

1/2
UG-476
150 mm

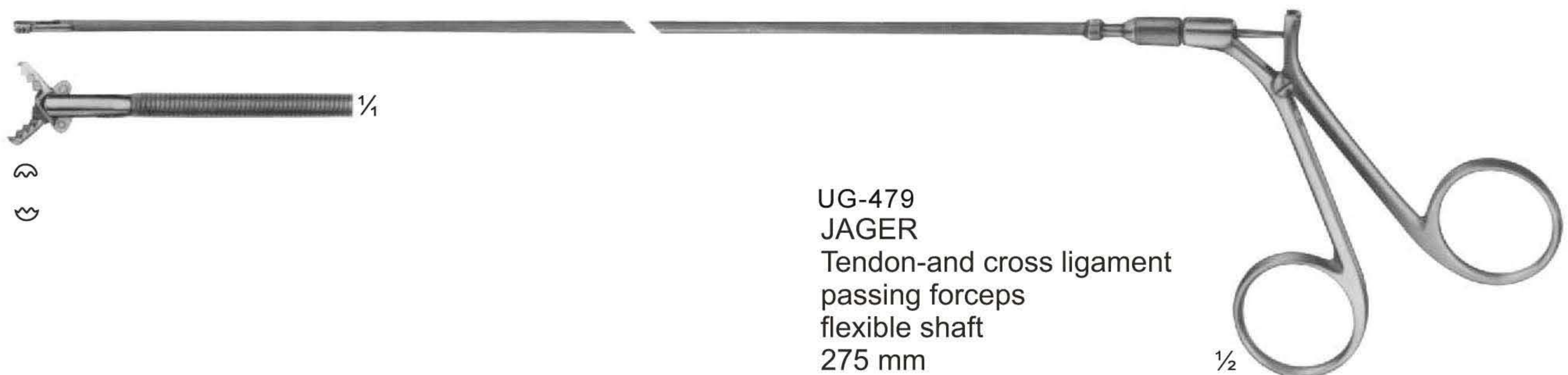

UG-479
JAGER
Tendon-and cross ligament
passing forceps
flexible shaft
275 mm

1/2

Artery Traction - and Tissue Grasping Forceps

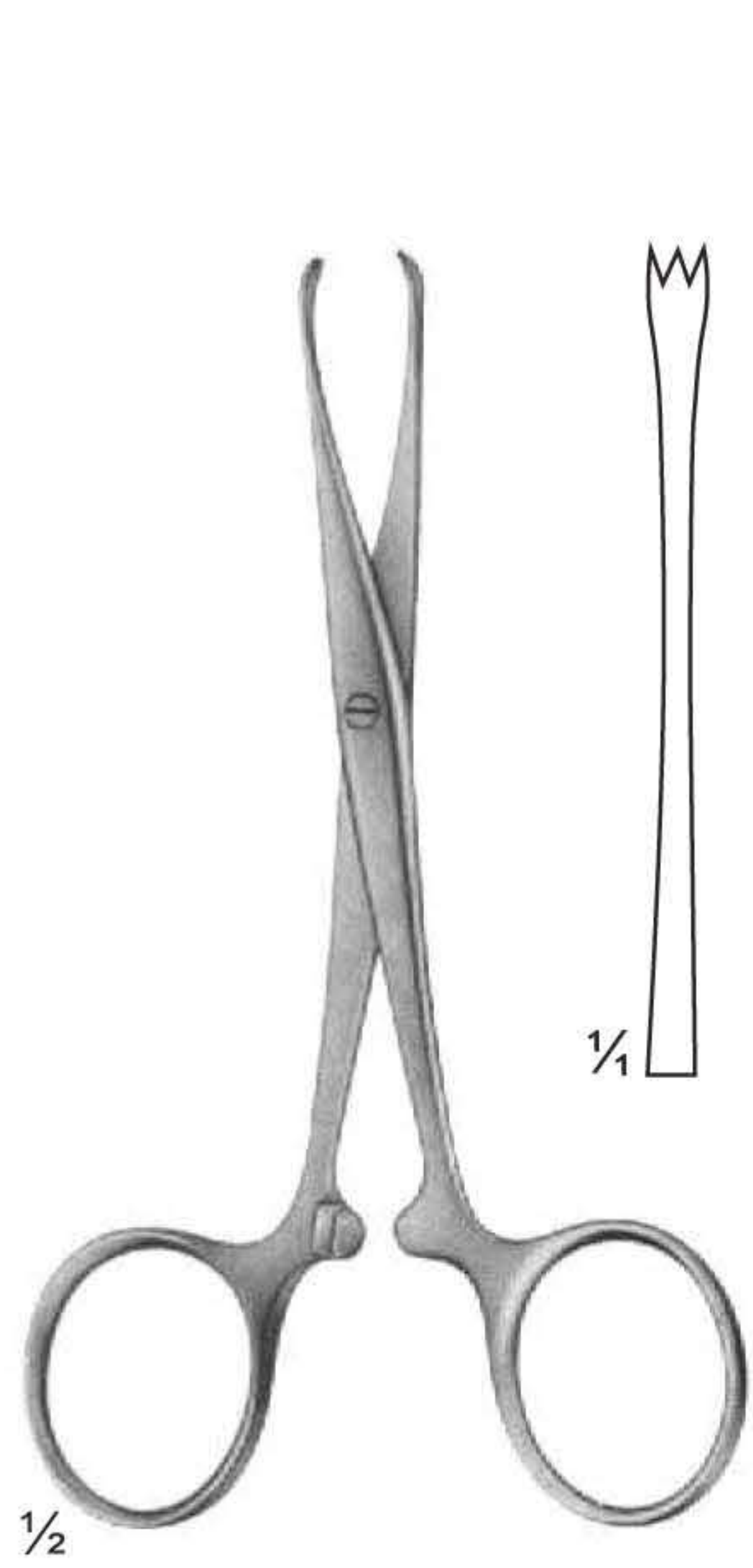

UG-482
CHAPUT
2 x 3 teeth
125 mm

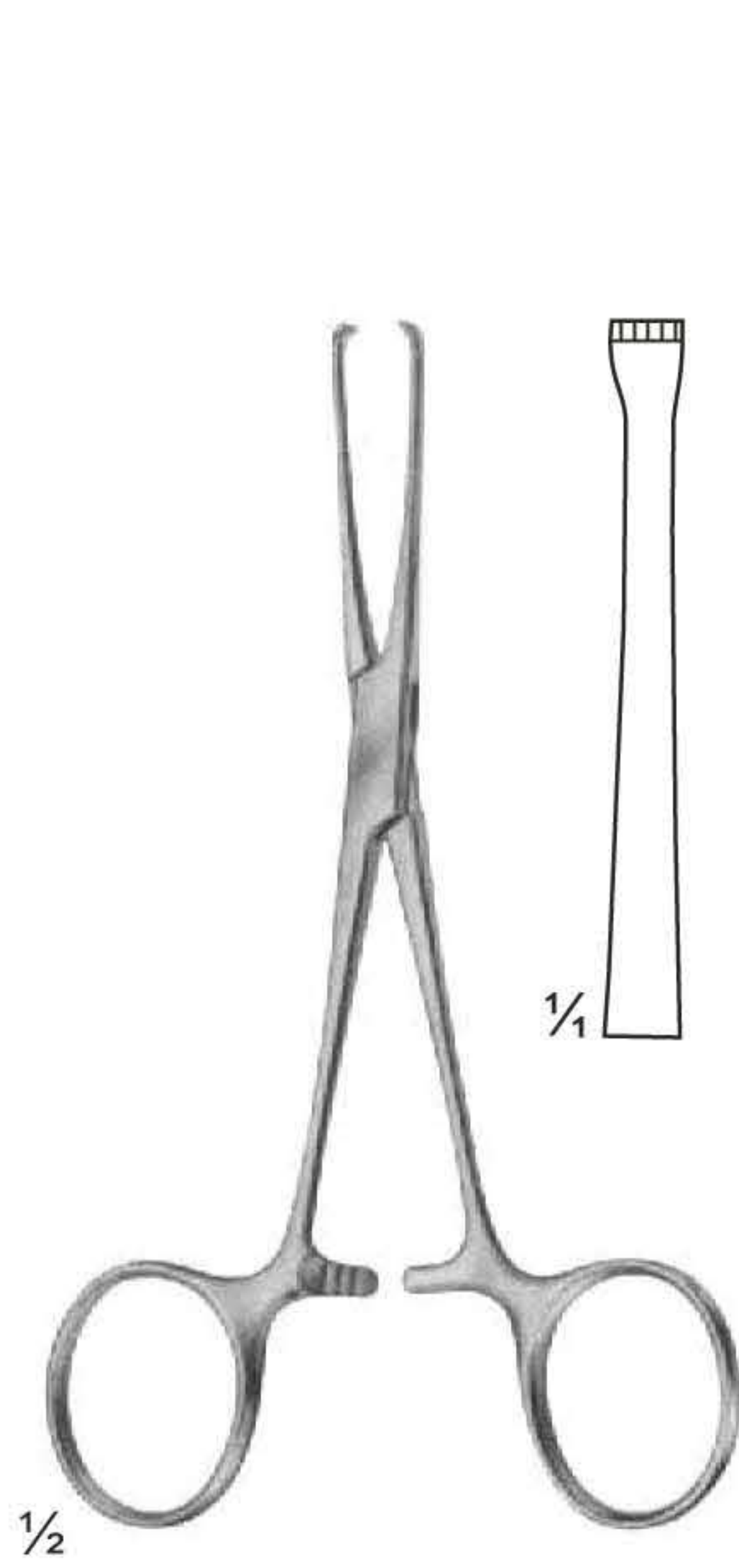

UG-483
BABY-ALLIS
4 x 5 teeth
130 mm

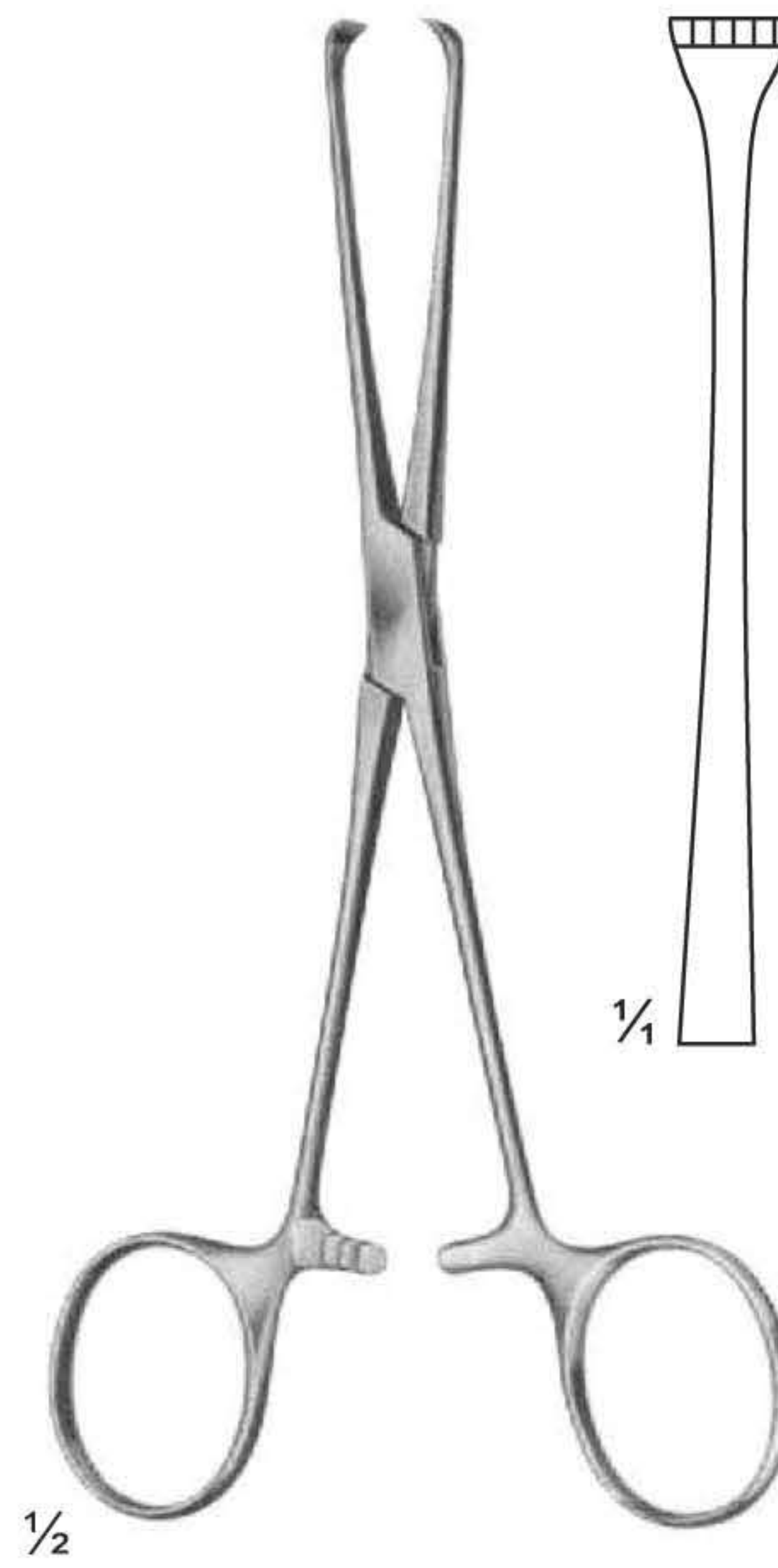

UG-484
BOYS-ALLIS
5 x 6 teeth
155 mm

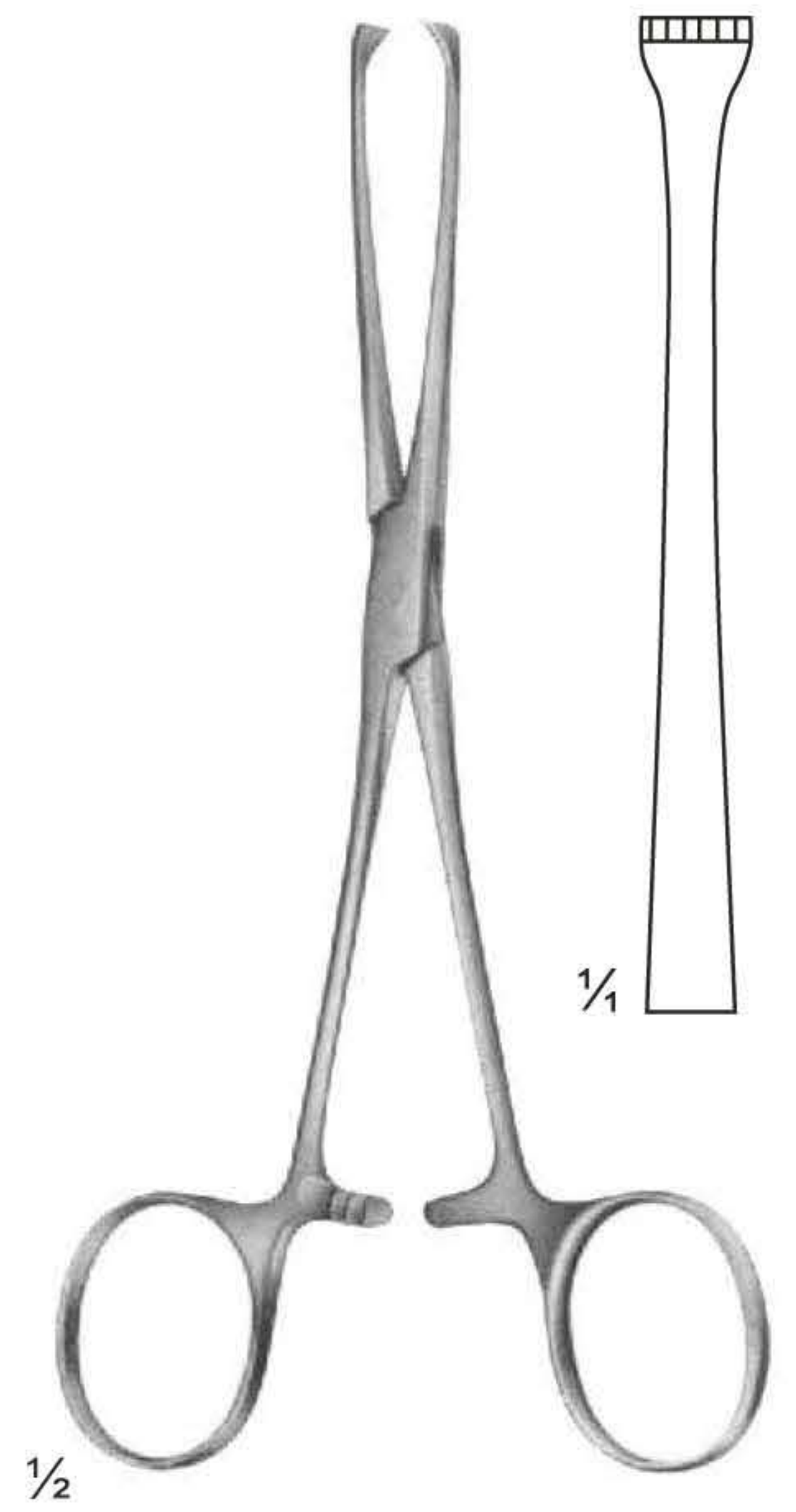

UG-485
ALLIS
5 x 6 teeth
155 mm

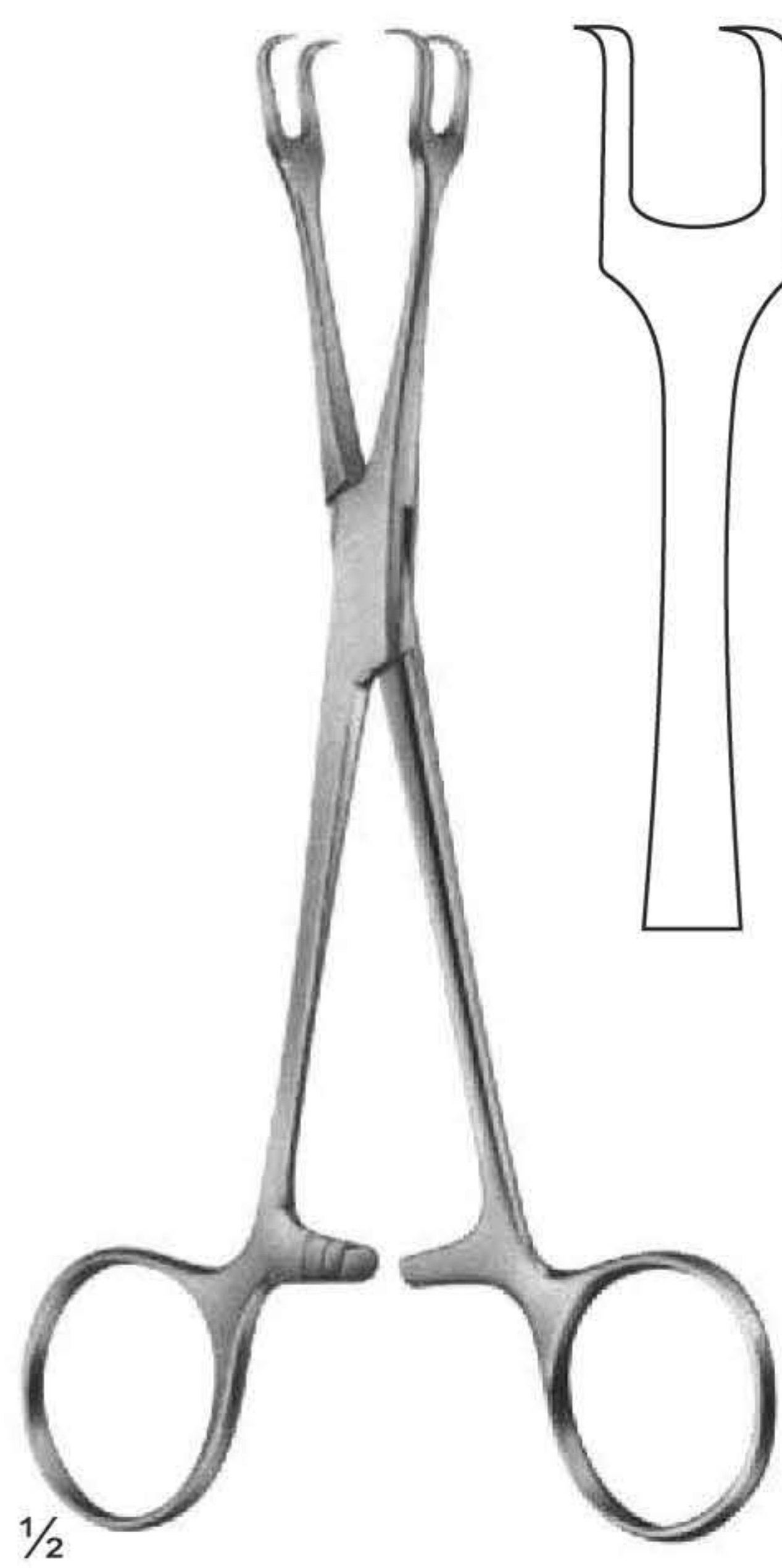

UG-487
LAHEY
135 mm

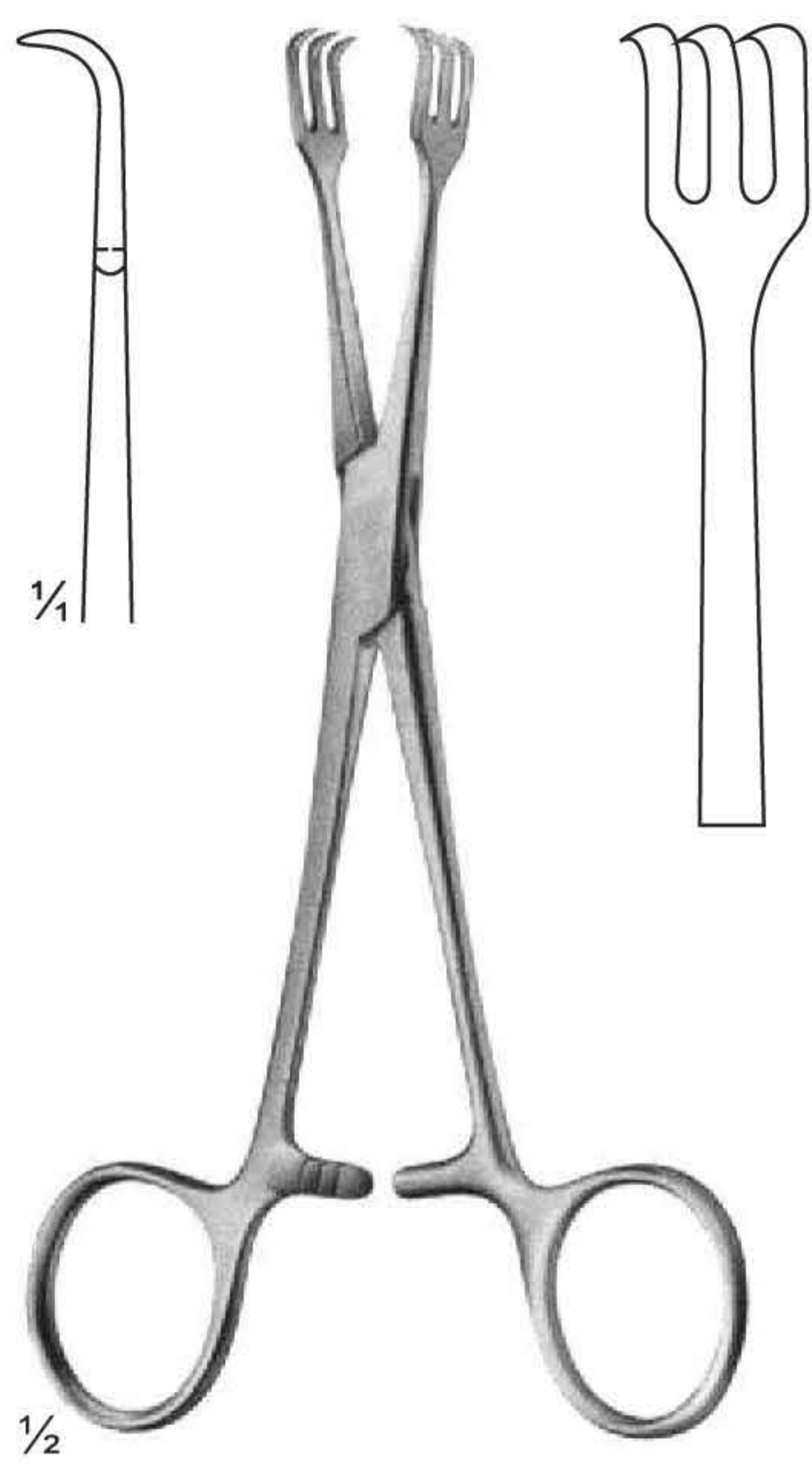

UG-488
LAHEY
135 mm

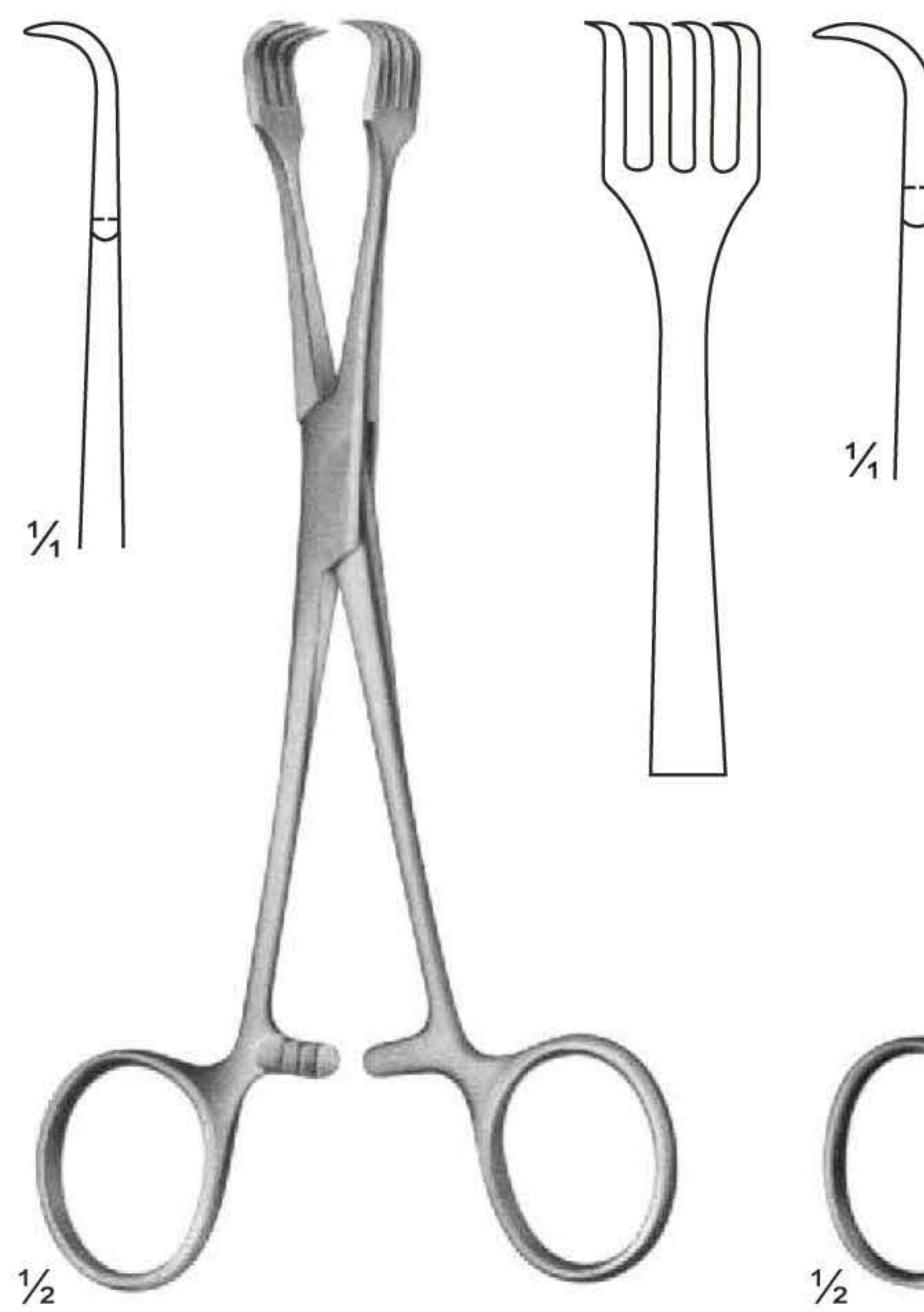

UG-489
BRAUN
155 mm

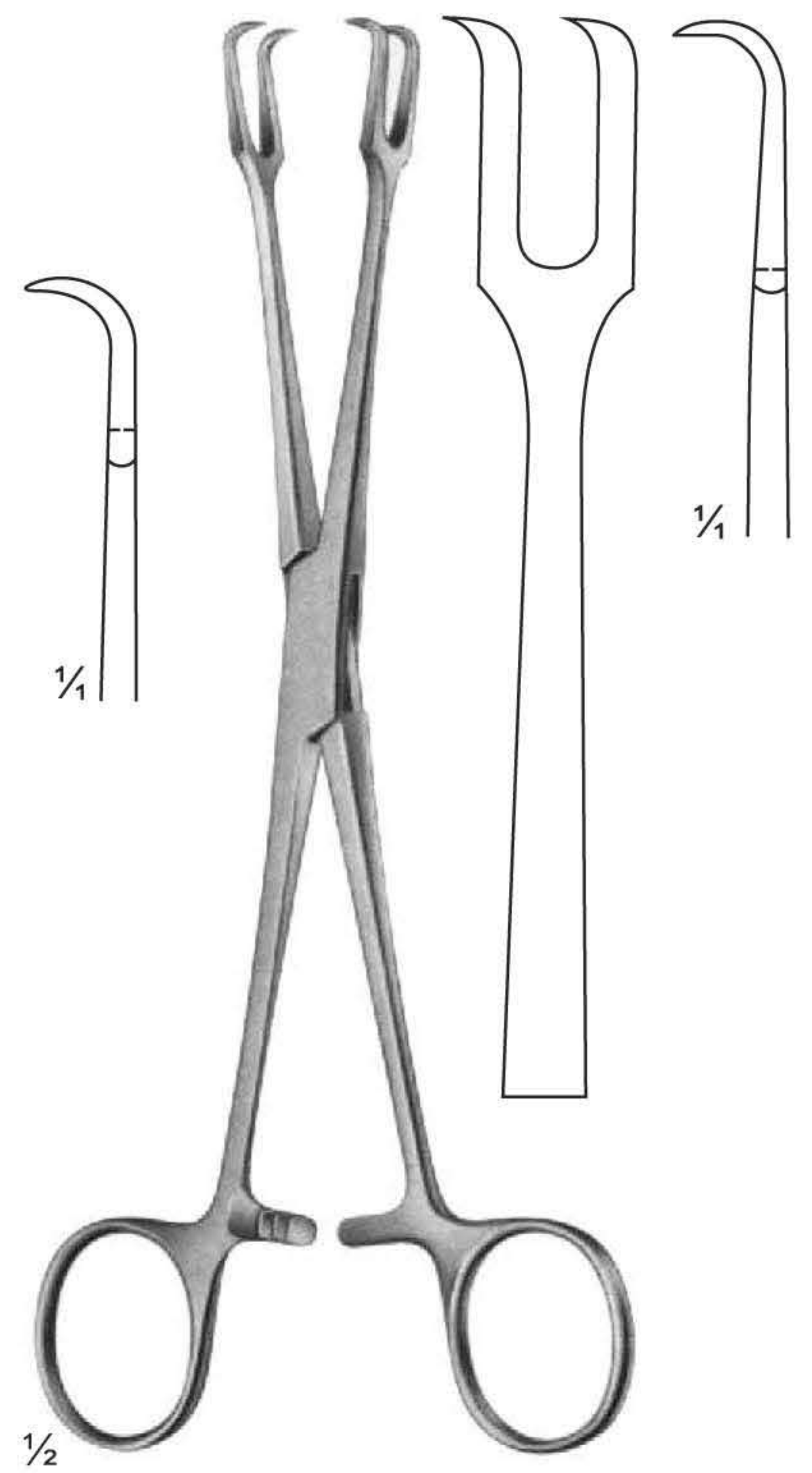

UG-490
MUSEUX
200 mm

Organ - and Tissue Grasping Forceps

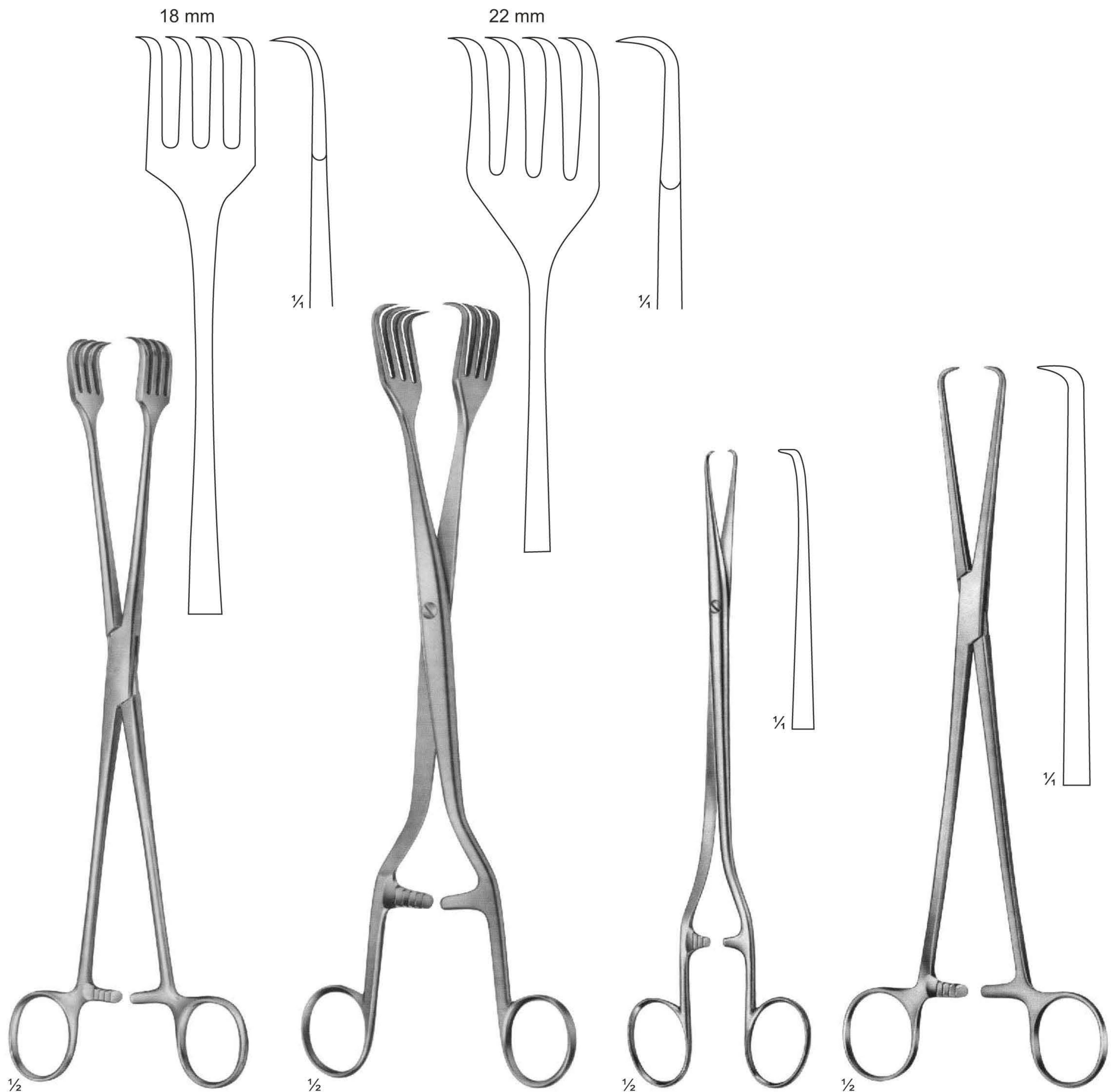

UG-492
AESCULAP
260 mm

UG-493
PRATT
270 mm

UG-494
TIEMANN
Bullet forceps
220 mm

UG-495
SCHRODER
250 mm

Towel Clamps

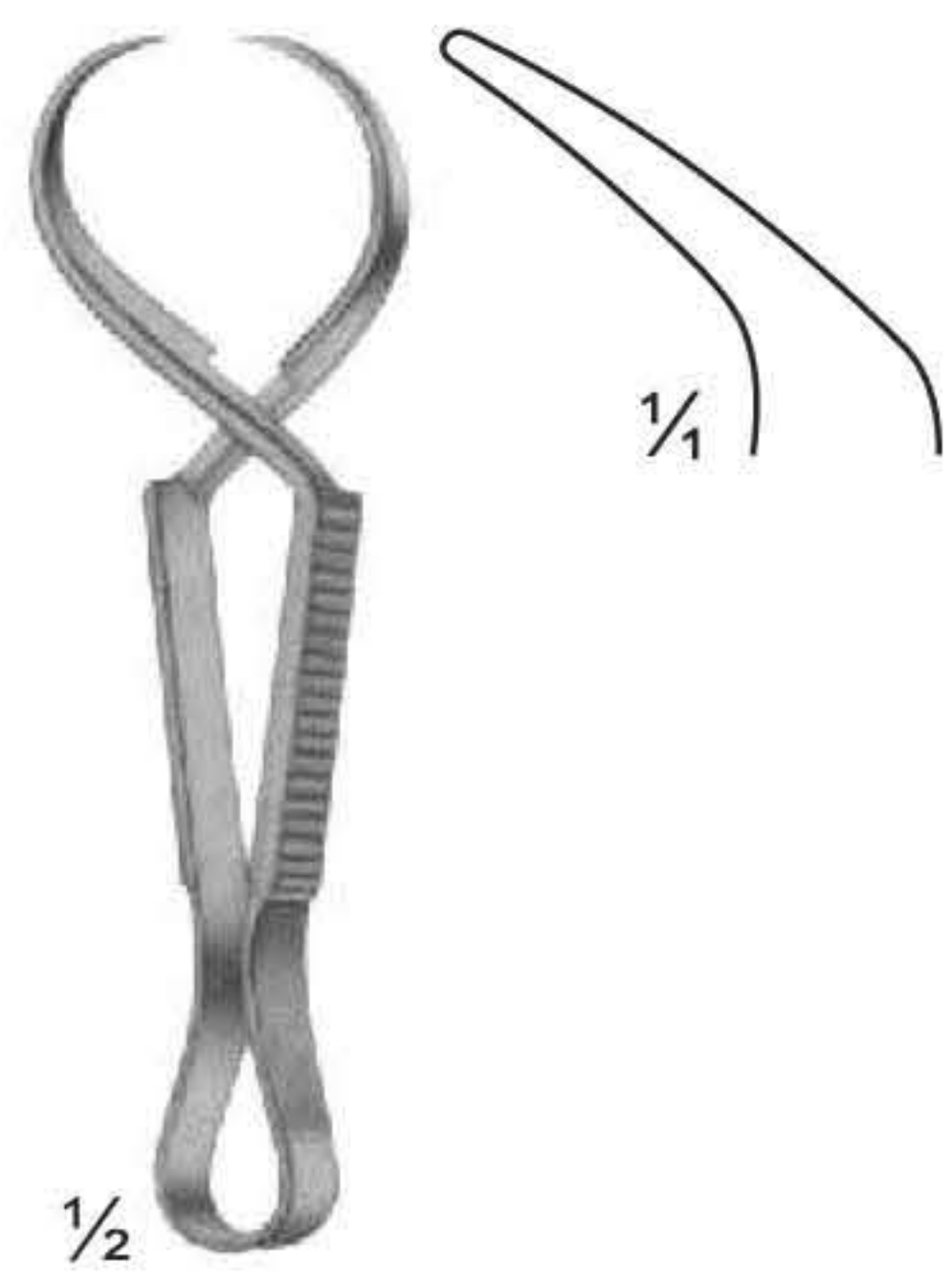

UG-496
JONES
85 mm



UG-498
ENGL. MOD.
85 mm

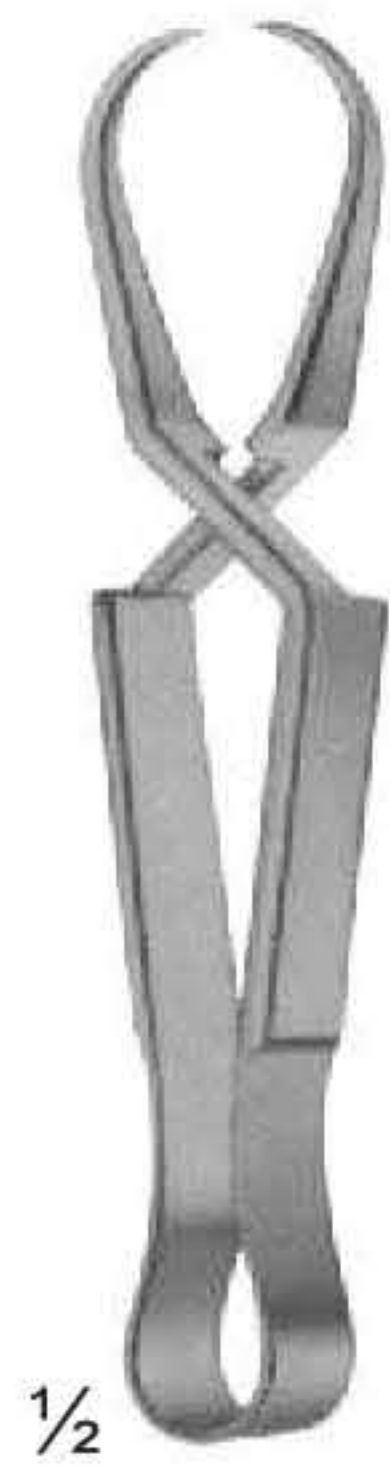

UG-499
SCHAEDEL
85 mm

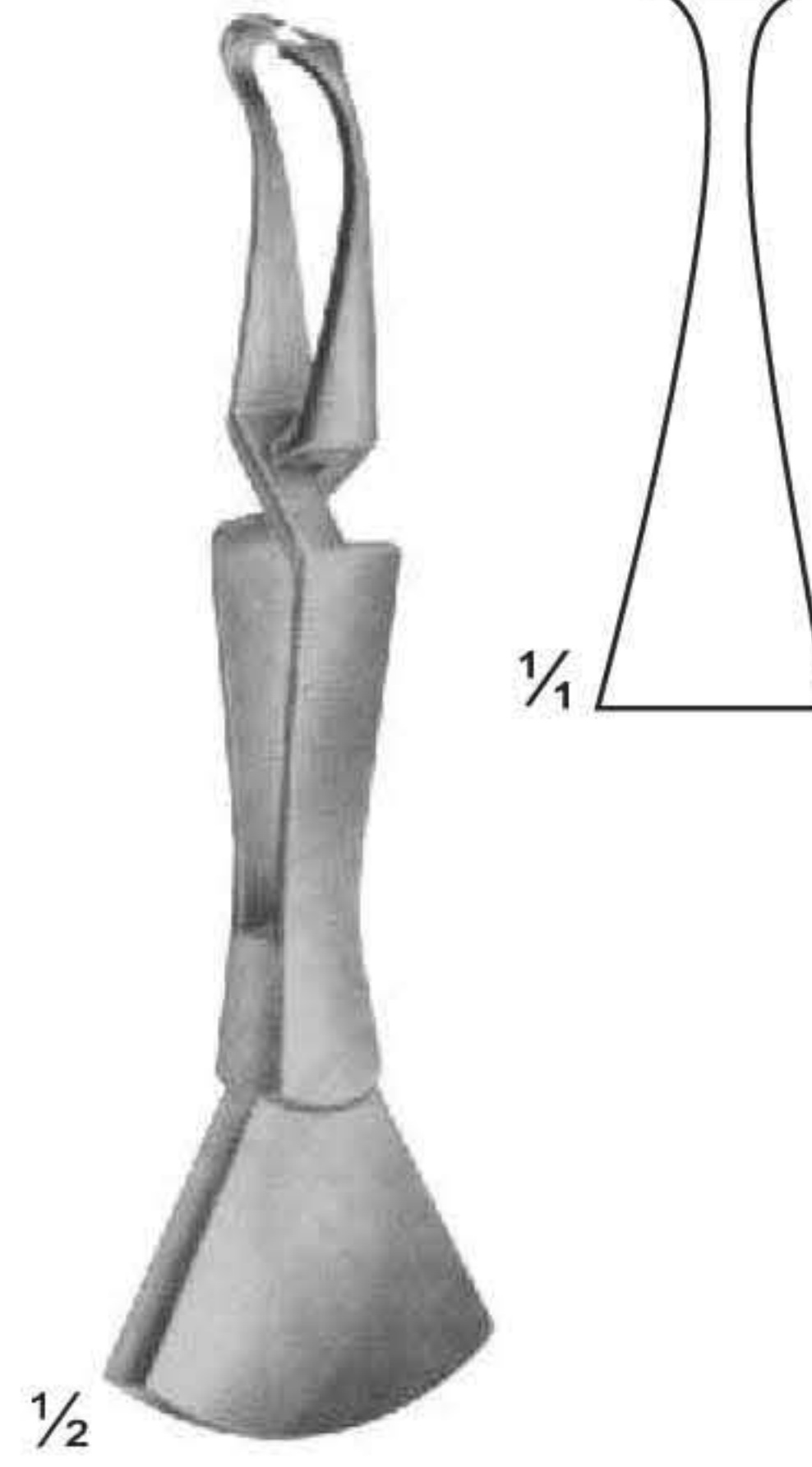

UG-502
DOYEN
110 mm

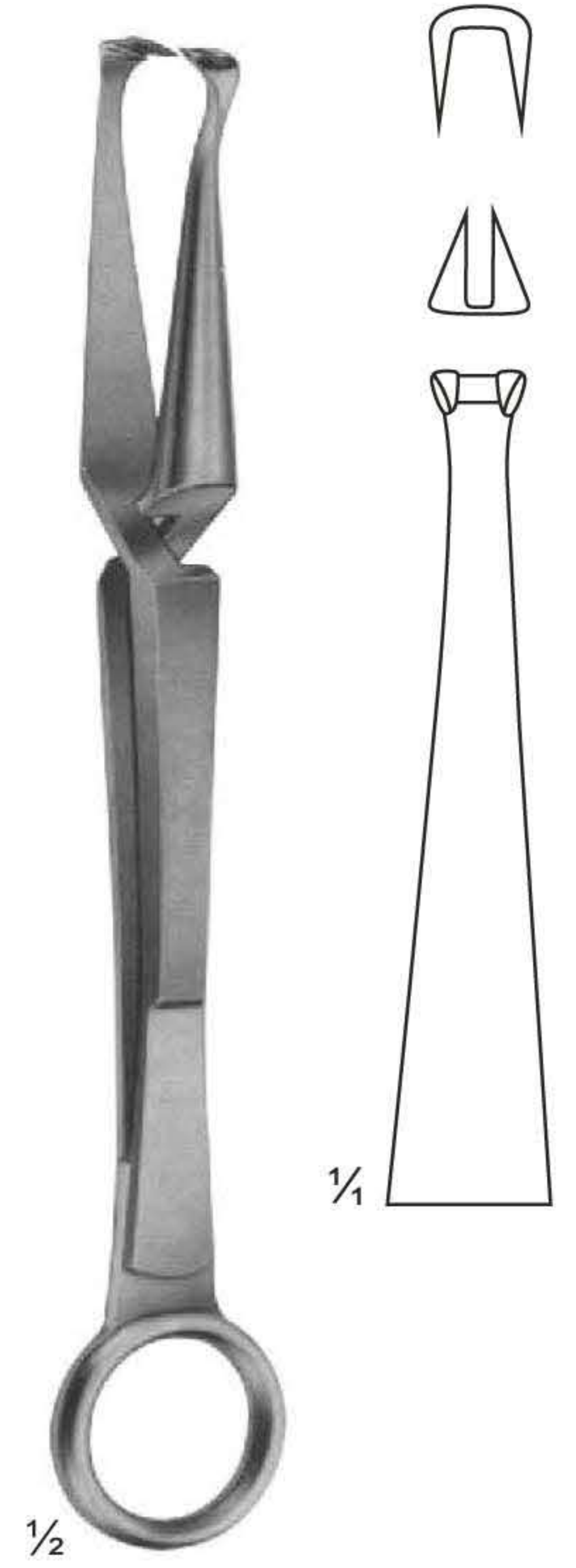

UG-504
DOYEN
180 mm



UG-508
LANE



UG-515
BACKHAUS



UG-516
BACKHAUS

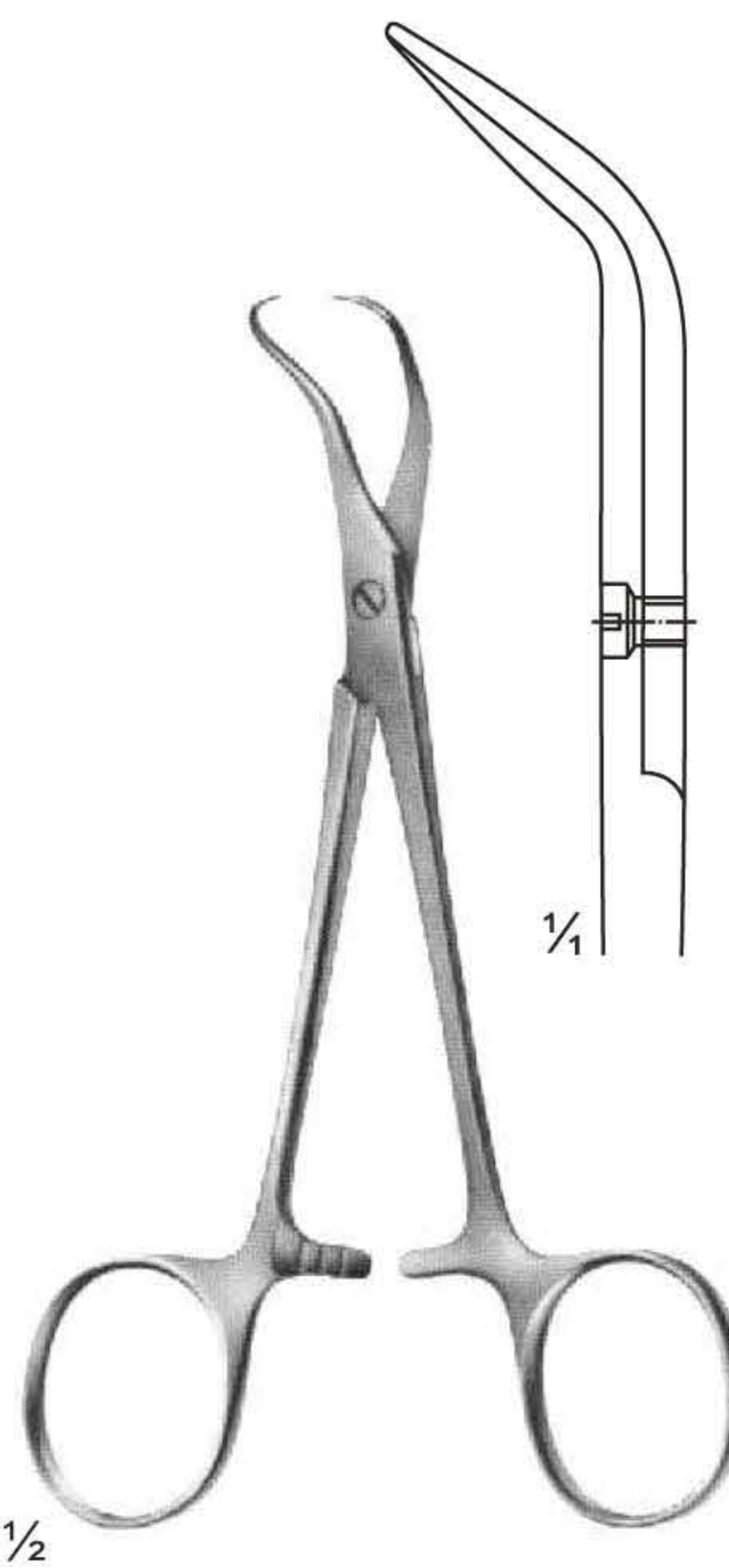

UG-517
BACKHAUS-KOCHER
135 mm

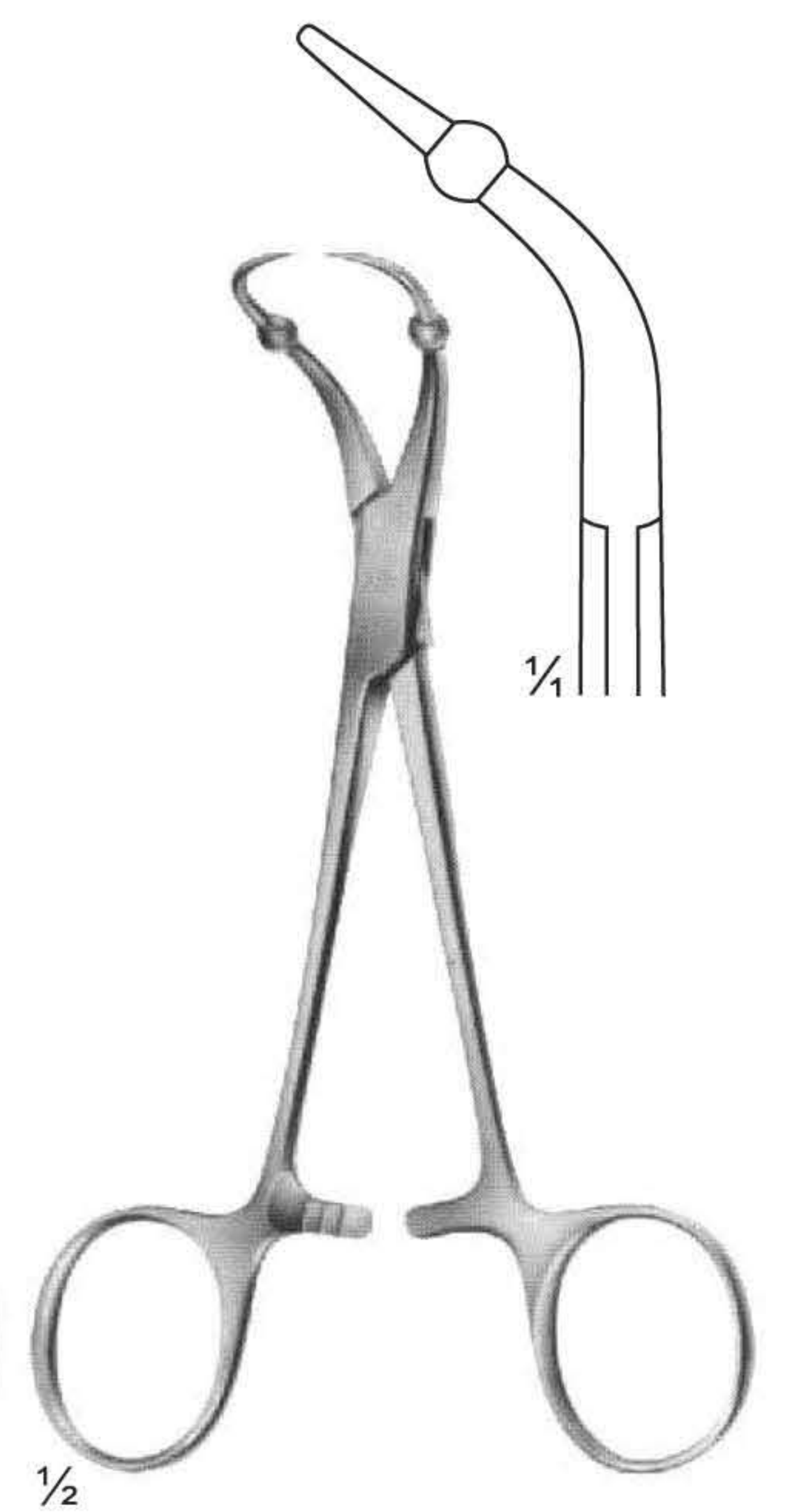

UG-520
ROEDER
135 mm

Towel Clamps

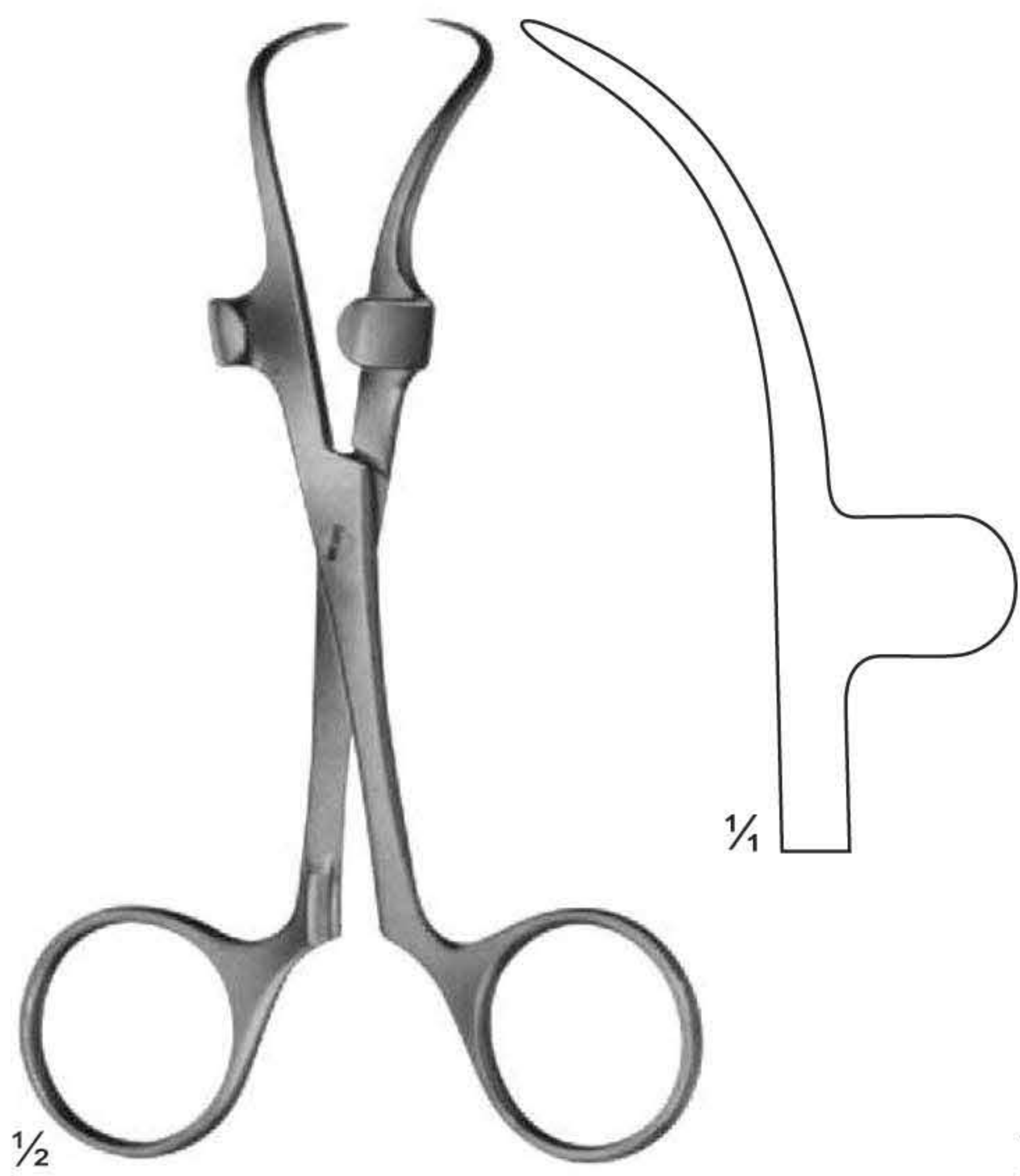

UG-522
ROBIN
with holders for tubing
up to 13 mm
135 mm

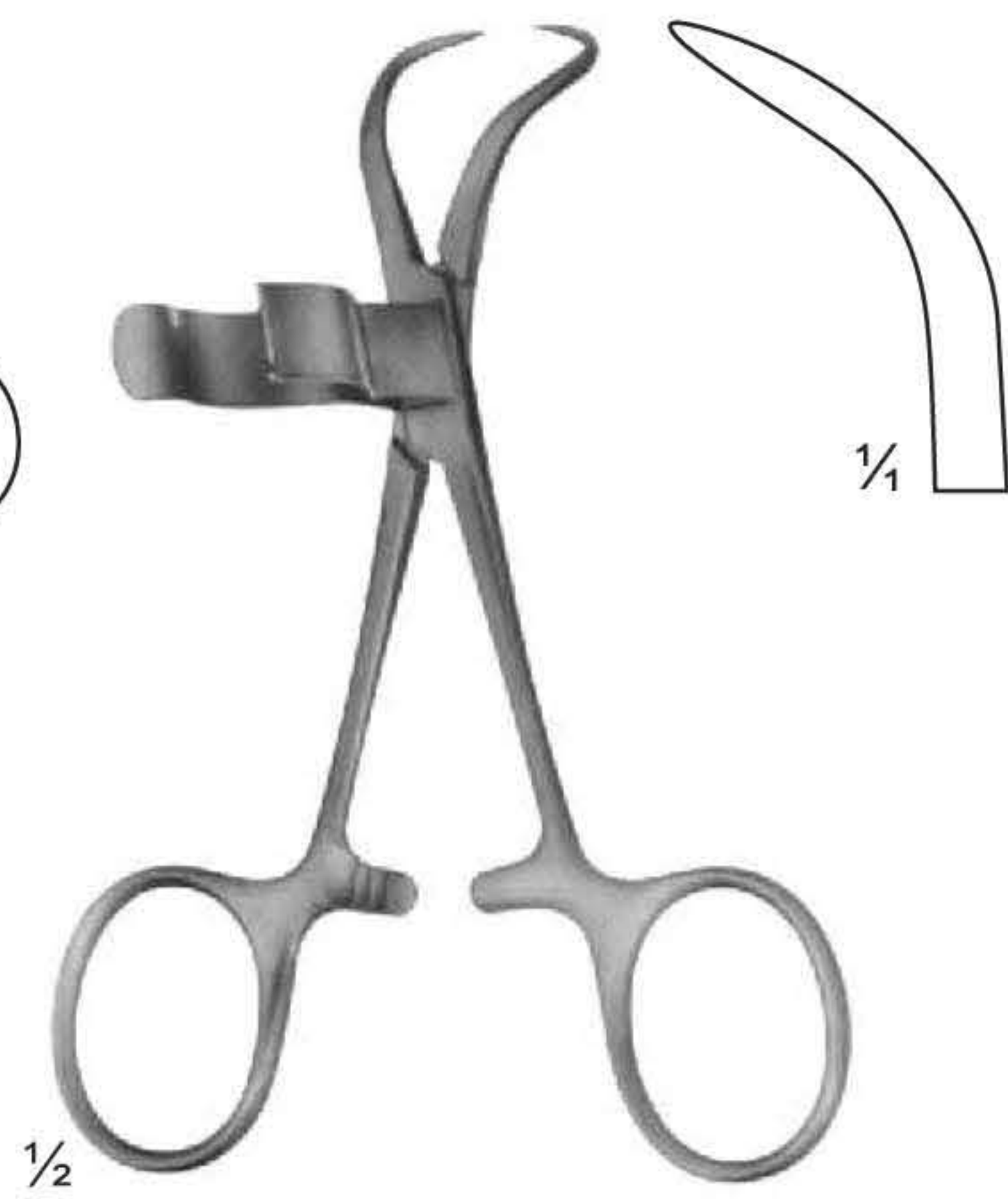

UG-524
with clip for tubing
up to 15 mm
110 mm

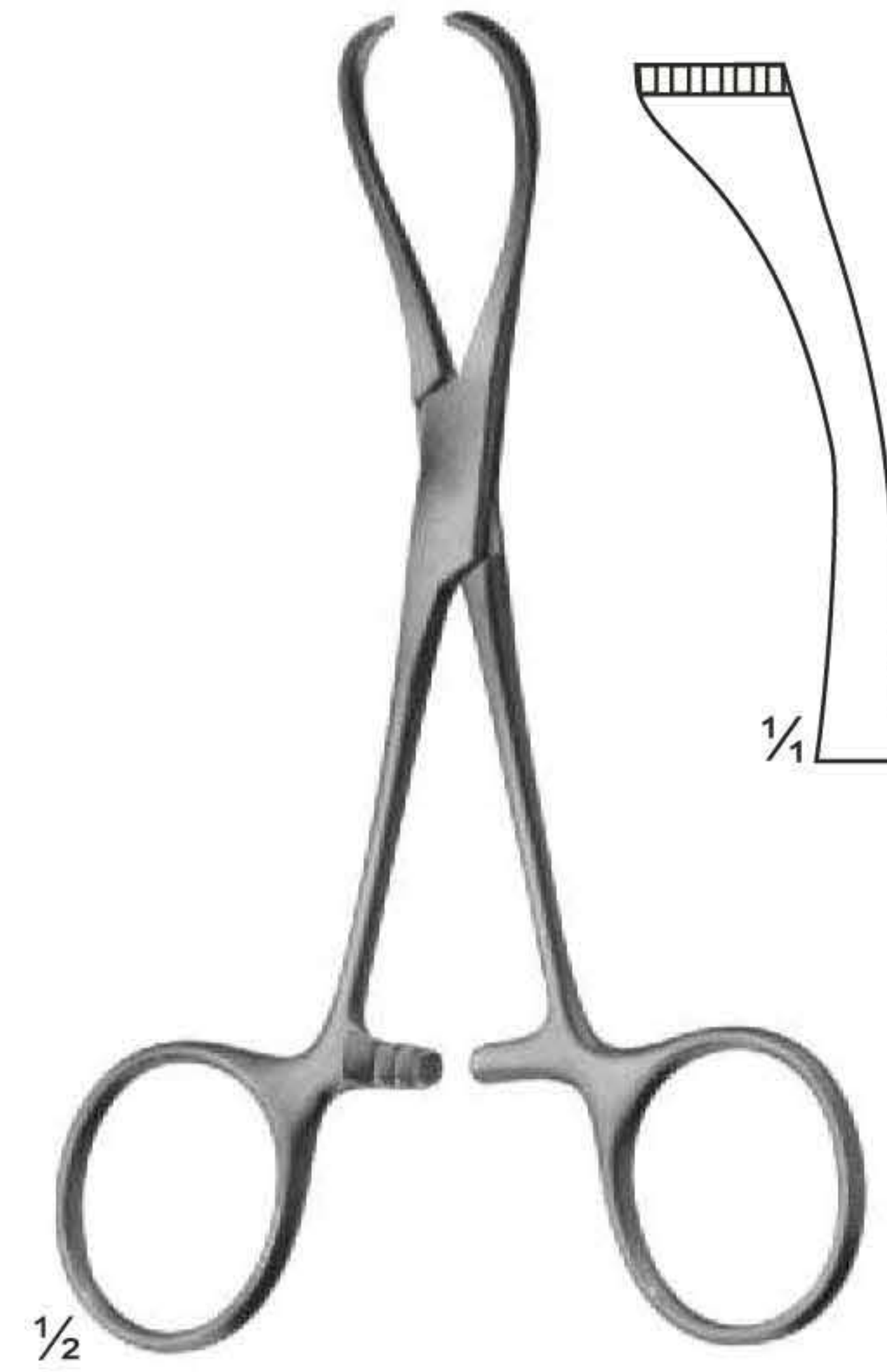

UG-527
LORNA
non perforating
130 mm

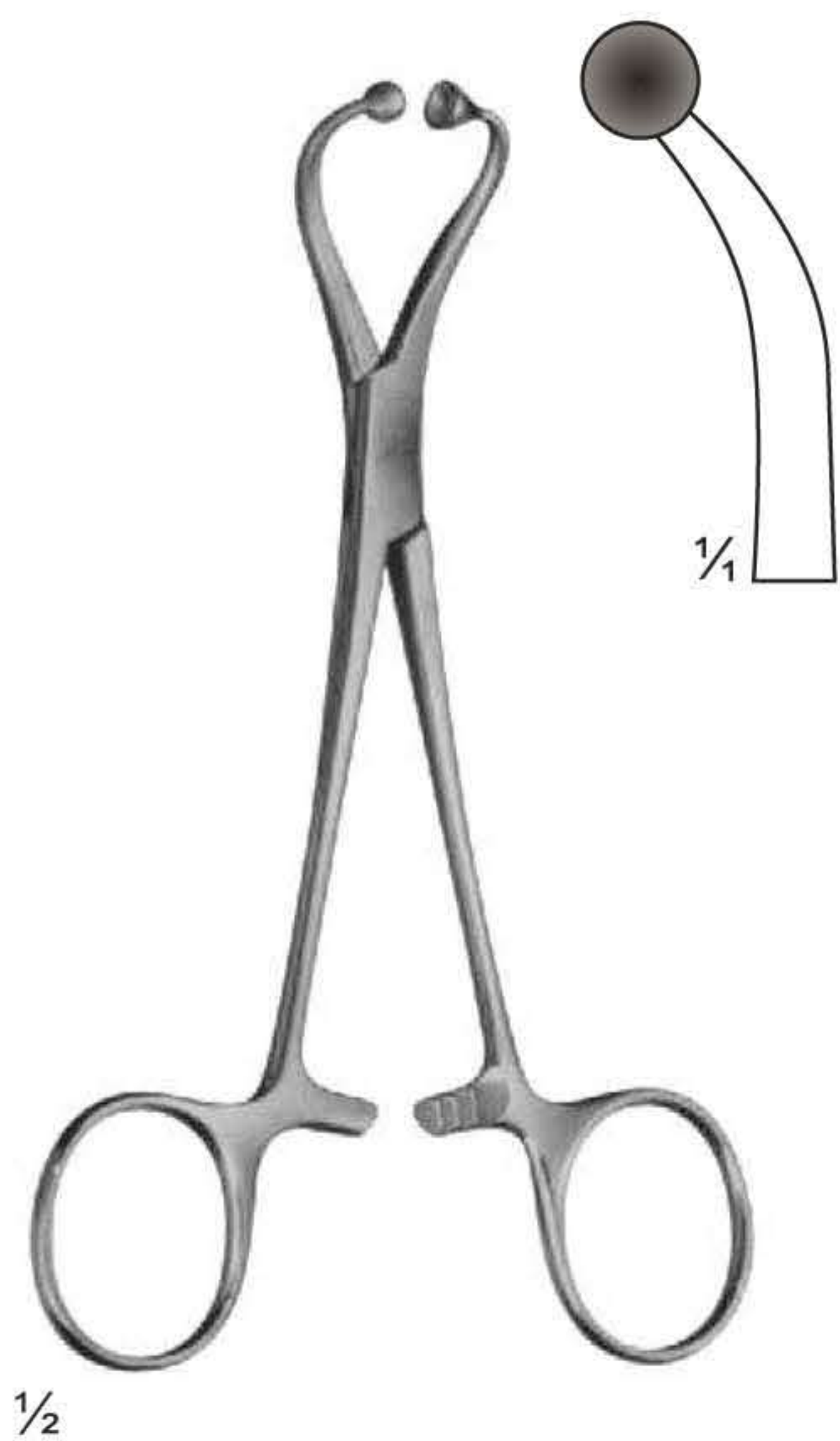

UG-528
for paper cloths
140 mm



UG-529
BUNT
105 mm



UG-531
MAYO
140 mm

Delicate Haemostatic Forceps



UG-583
CARREL
85 mm



UG-584
BABY-MOSQUITO
(HARTMANN)
100 mm



UG-585
MICRO-HALSTED
125 mm



UG-586
HALSTED-MOSQUITO
125 mm



UG-587
PROVIDENCE-HOSPITAL
140 mm



UG-588
KELLY
140 mm



UG-589
DANDY
Curved sideways
140 mm

Delicate Haemostatic Forceps



1/2

UG-591
BABY-CRILE
140 mm



1/2

UG-592
CRILE
140 mm



1/2

UG-593
RANKIN
160 mm



1/2

UG-594
CRILE
160 mm



1/2

UG-595
ADSON
185 mm



1/2

UG-596
HALSTED
185 mm

Delicate Haemostatic Forceps



½
UG-597
HALSTED-MOSQUITO
200 mm



½
UG-598
HEISS
200 mm



½
UG-599
HALSTED
215 mm



½
UG-600
BENGOLEA
245 mm



½
UG-601
CRAFOORD
245 mm

Haemostatic Forceps

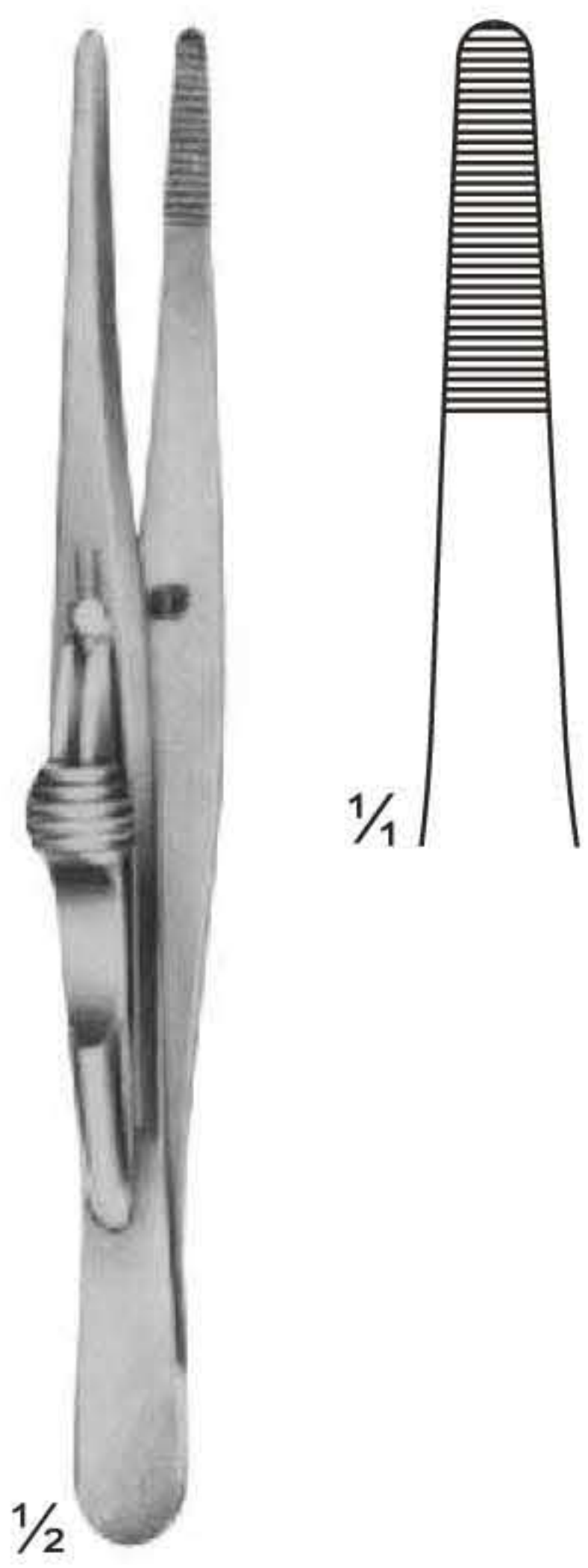

UG-602
FRICKE
Artery forceps
130 mm

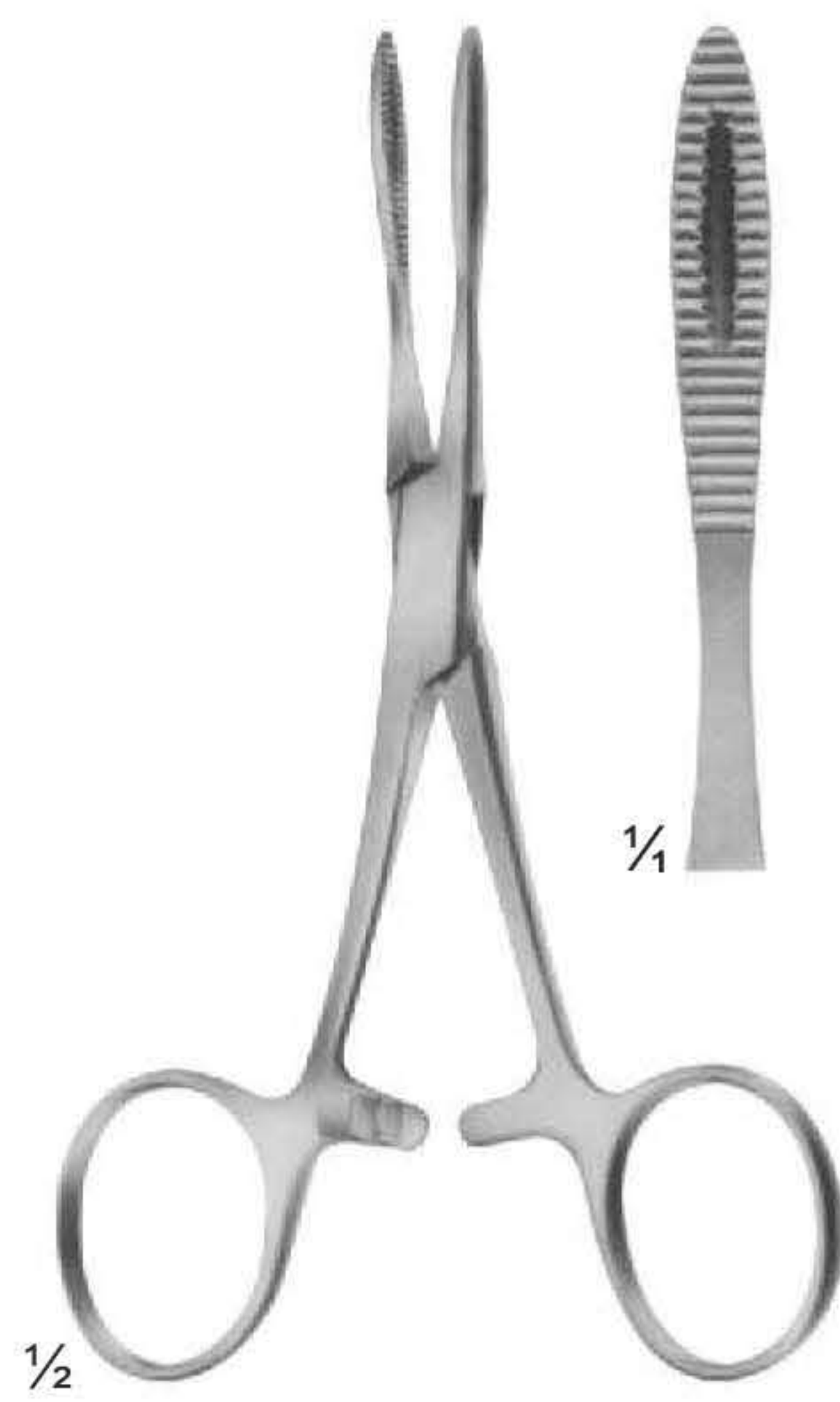

UG-603
KRONLEIN
130 mm

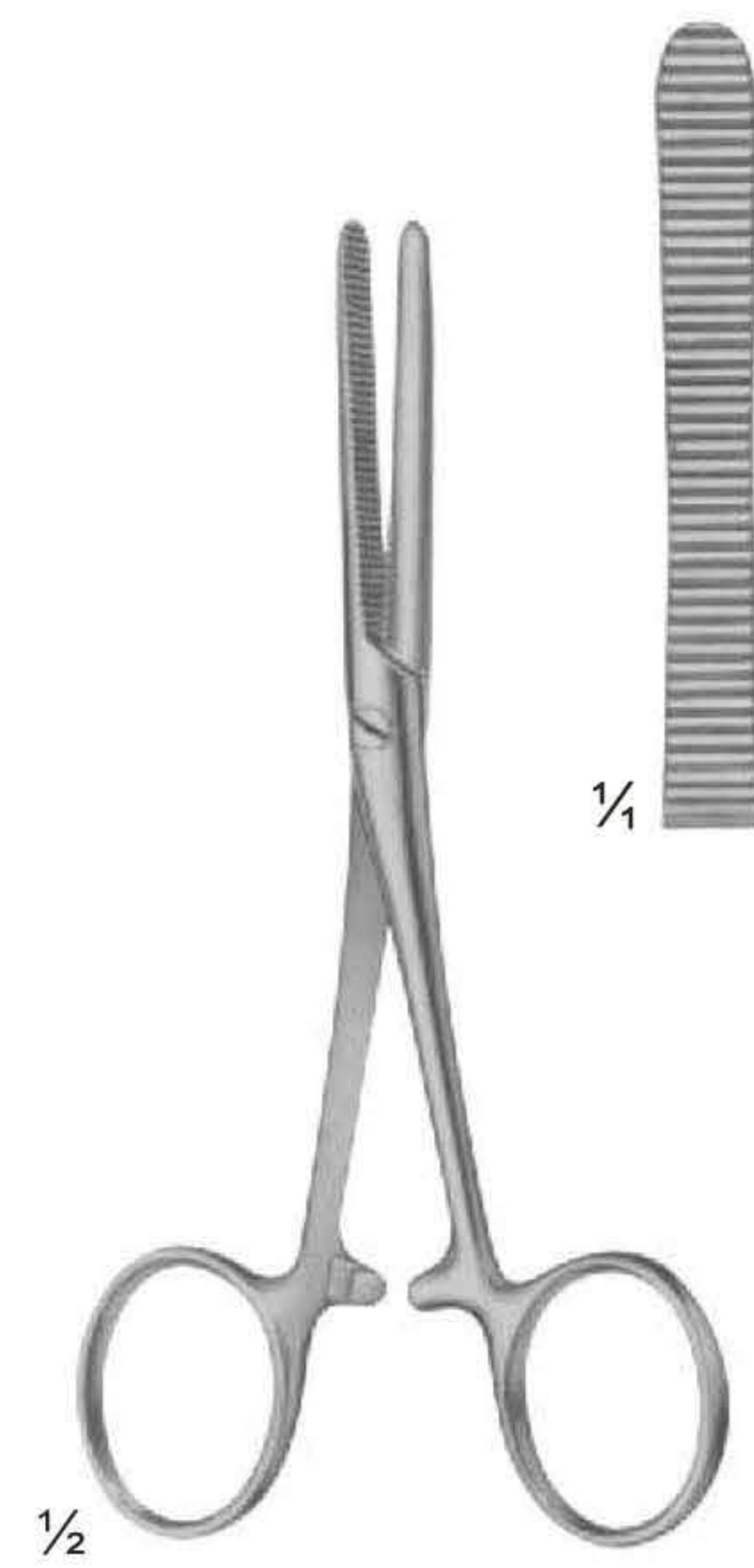

UG-604
PEAN
125 mm



UG-605
PEAN

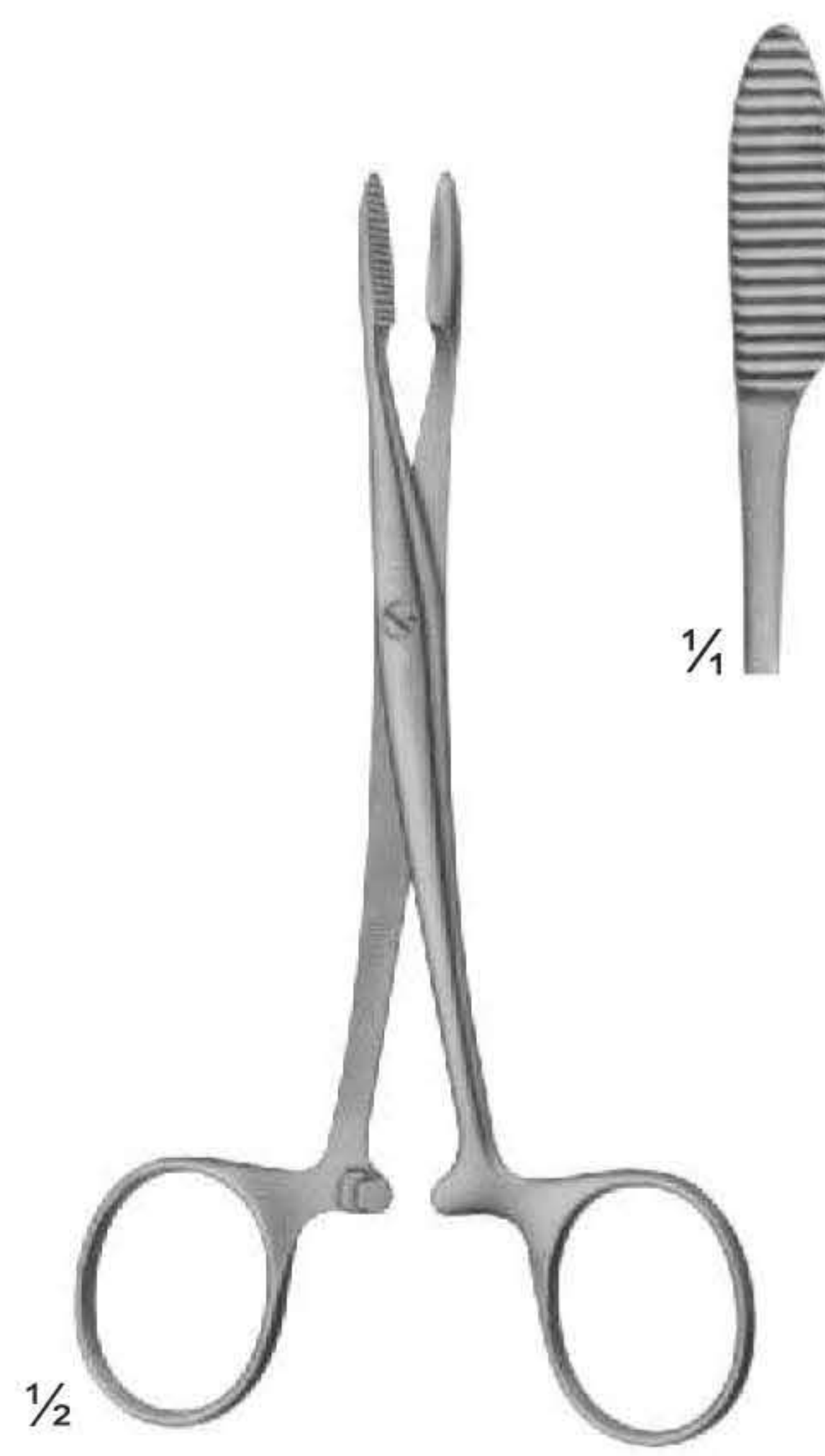

UG-606
PEAN



UG-607
PEAN

Haemostatic Forceps



1/2

UG-608
PEAN
Slender type



1/2

UG-609
SPENCER-WELLS
Slender type



1/2

UG-613
ROCHESTER-PEAN

Haemostatic Forceps



UG-616
PEAN

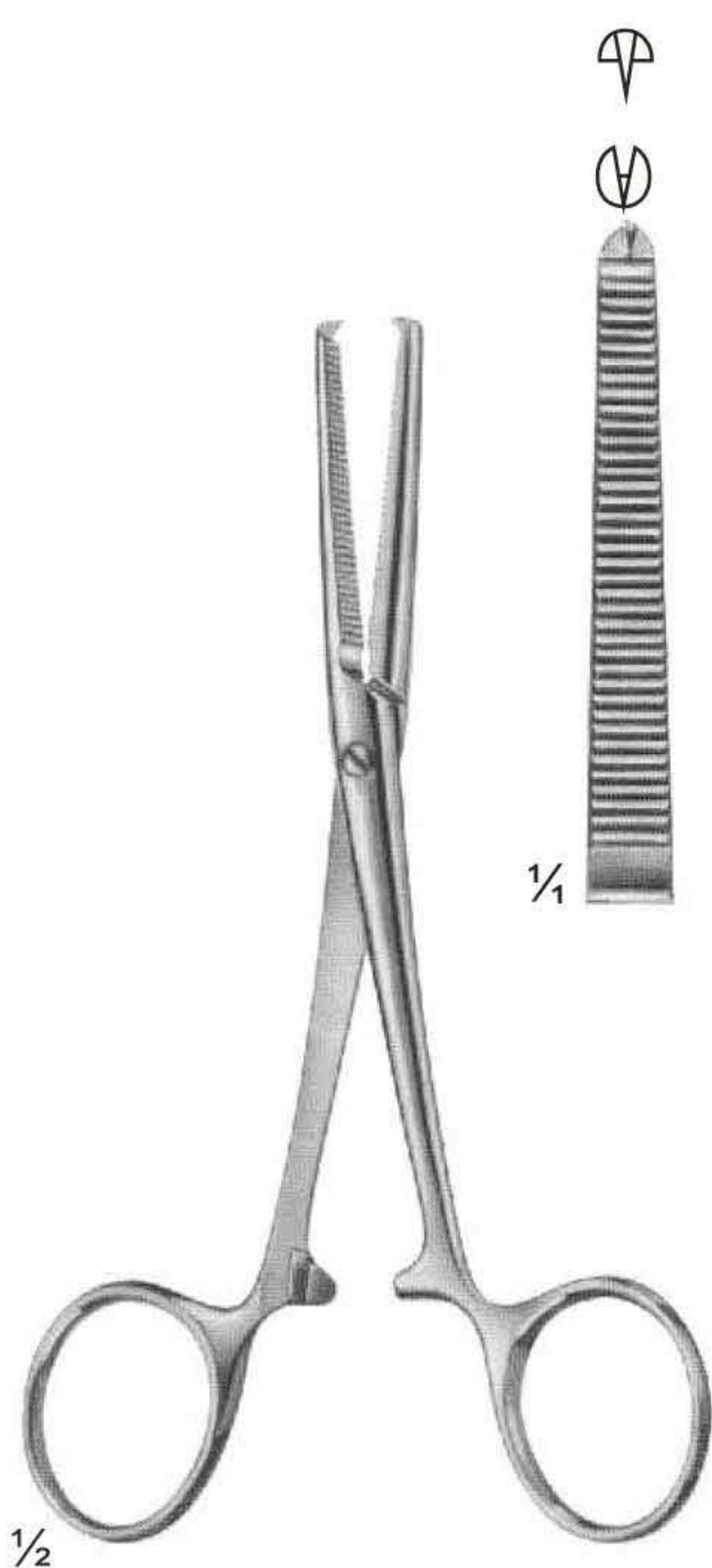

UG-621
KOCHER
Strong Pattern
145 mm



UG-622
KOCHER



UG-625
ROCHESTER-OCHSNER
140 mm

Haemostatic Forceps



UG-627
KOCHER-OCHSNER

Haemostatic Forceps, Special Pattern, Tonsil Forceps



UG-632
ROCHESTER-CARMALT



UG-634
MOYNIHAN



UG-637
PEAN



UG-640
NEGUS
190 mm

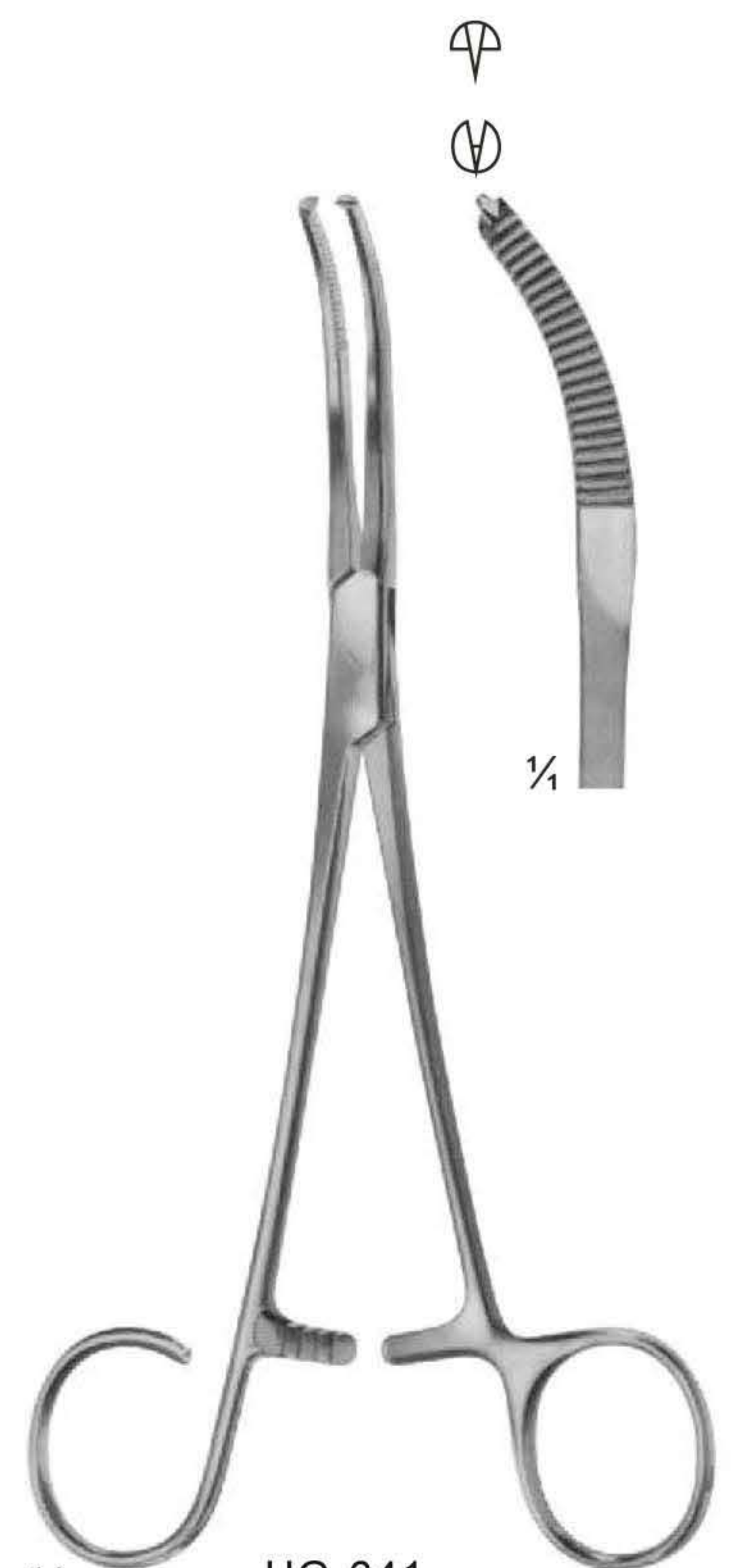

UG-641
MIKULICZ
185 mm

Dissecting- and Ligature Forceps

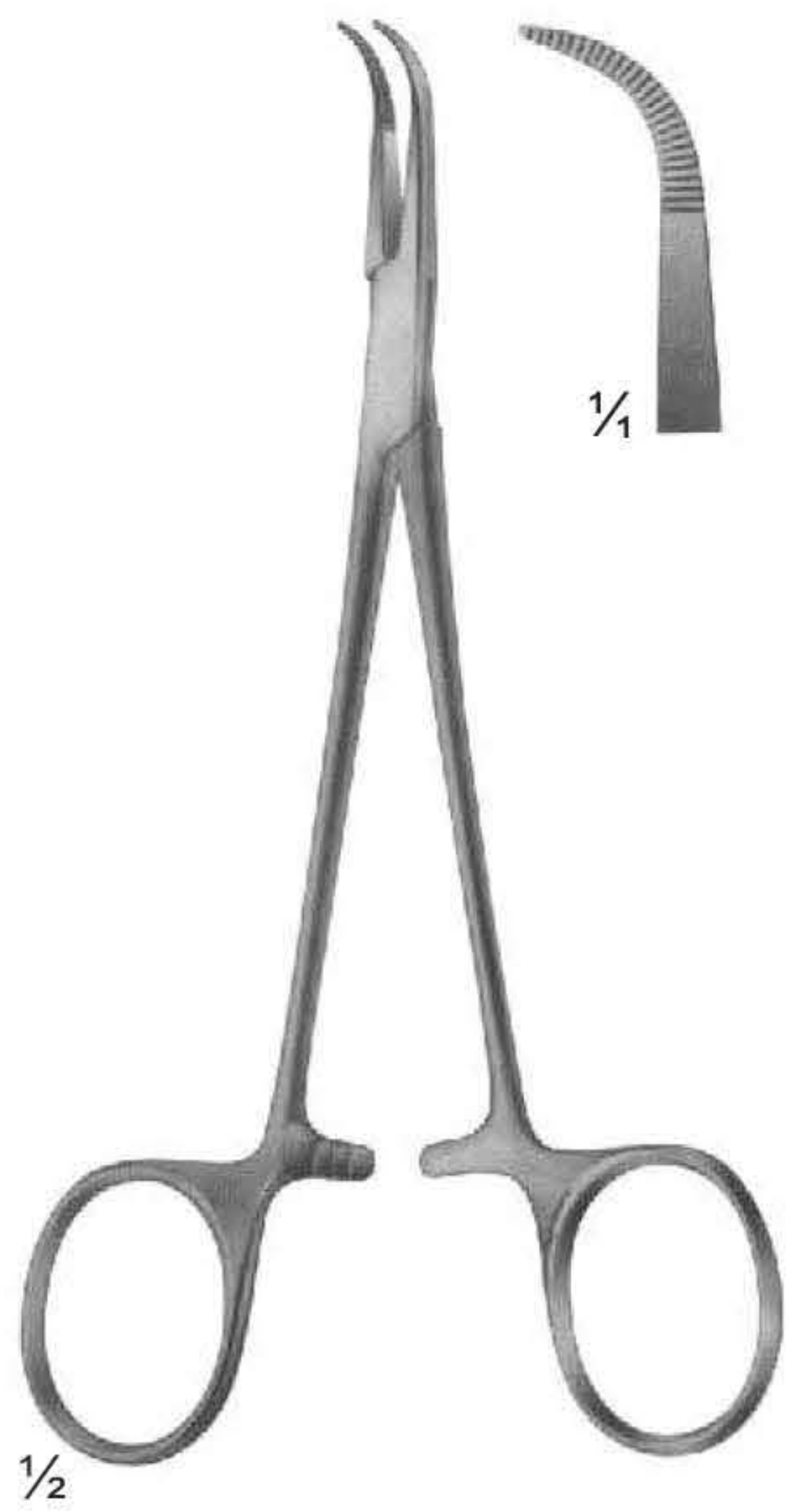

UG-643
MICRO-ADSON
140 mm

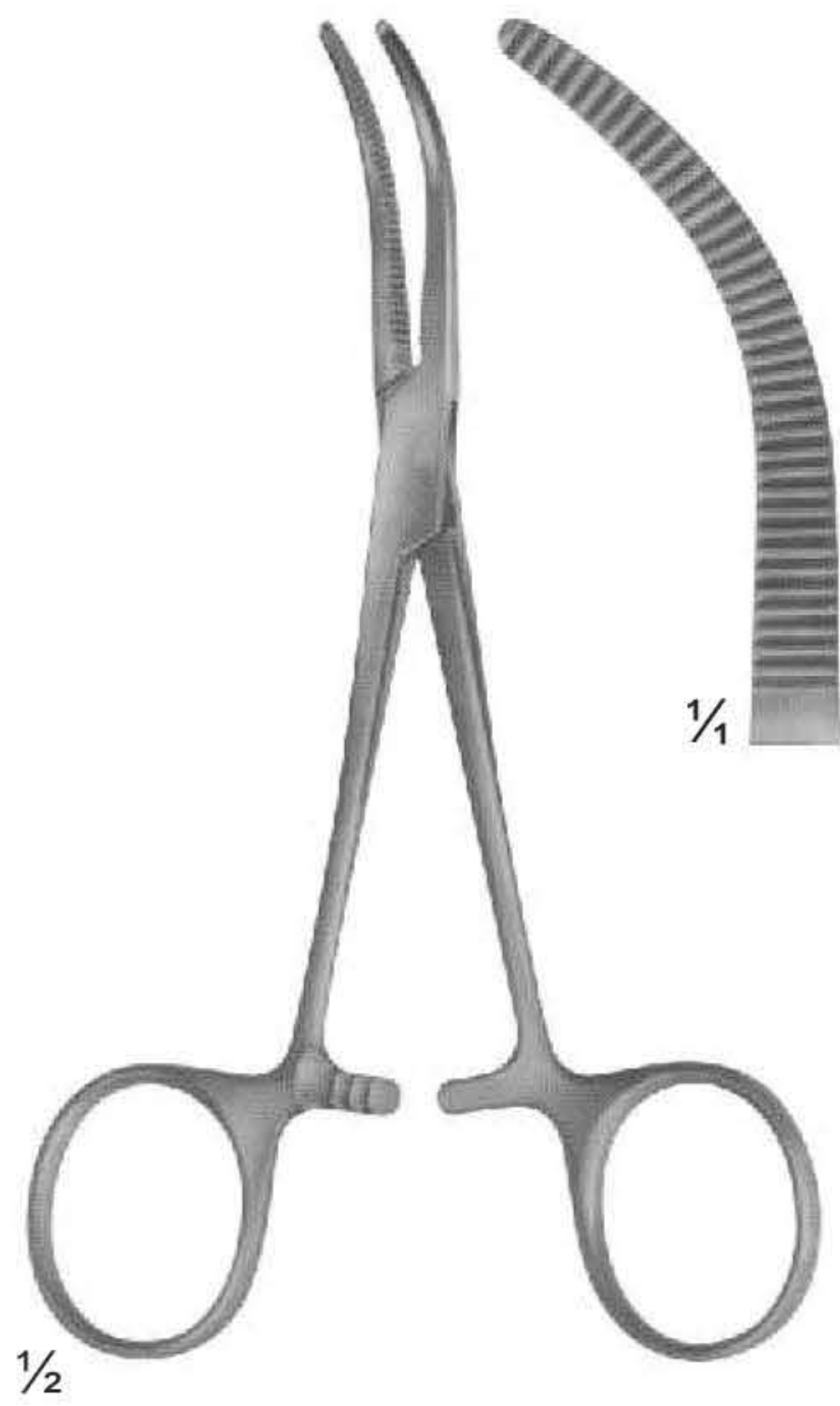

UG-645
BABY-OVERHOLT
135 mm



UG-647
BABY-MIXTER



UG-648
BABY-ADSON

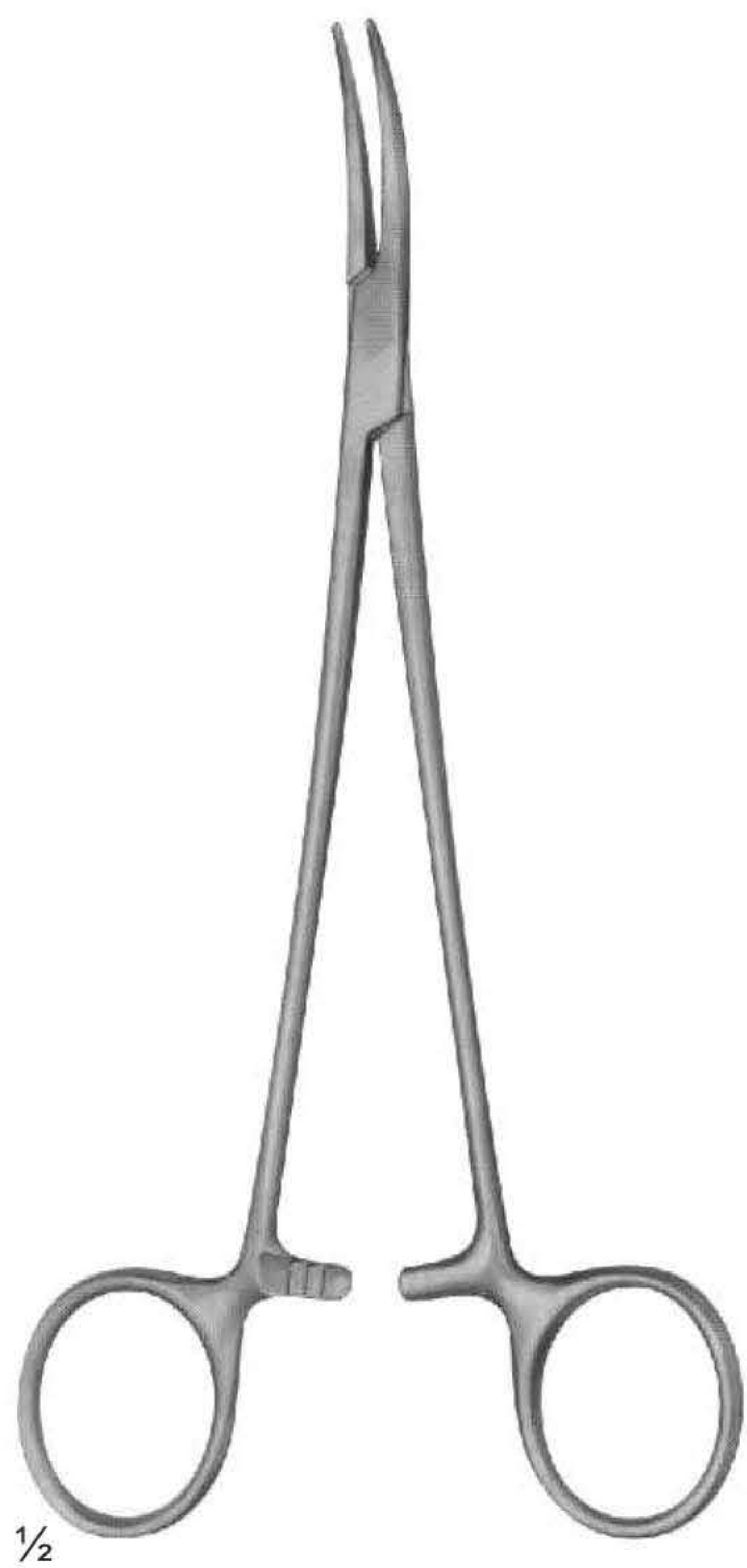

UG-652
NISSEN



UG-653
YASARGIL
195 mm



UG-654
OVERHOLT-MIXTER

Dissecting- and Ligature Forceps



1/2

UG-655
OVERHOLT-GEISSENDOERFER



1/2

UG-663
OVERHOLT
fine pattern

Dissecting- and Ligature Forceps

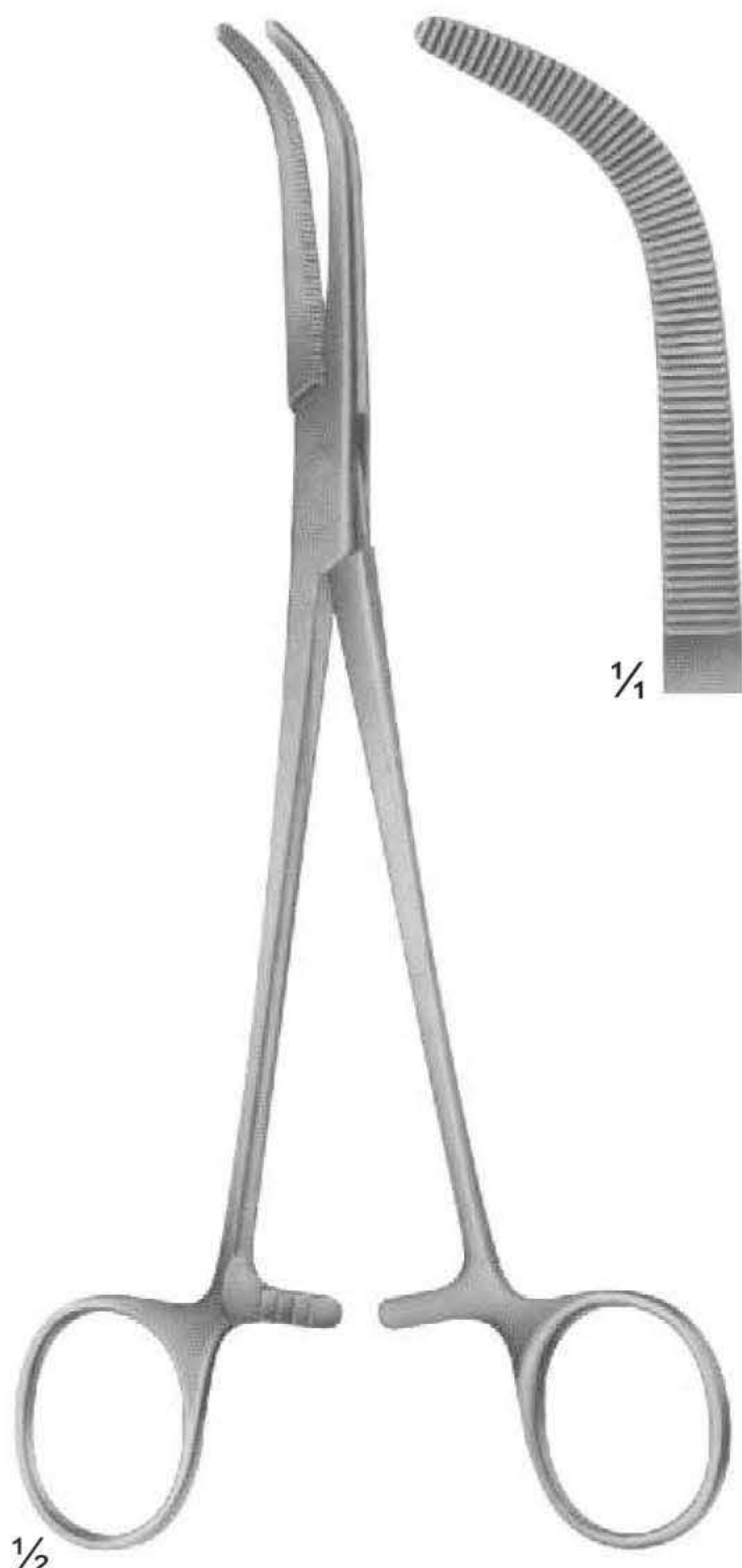

$\frac{1}{2}$
UG-669
MIXTER-O'SHAUGHNESSY
190 mm

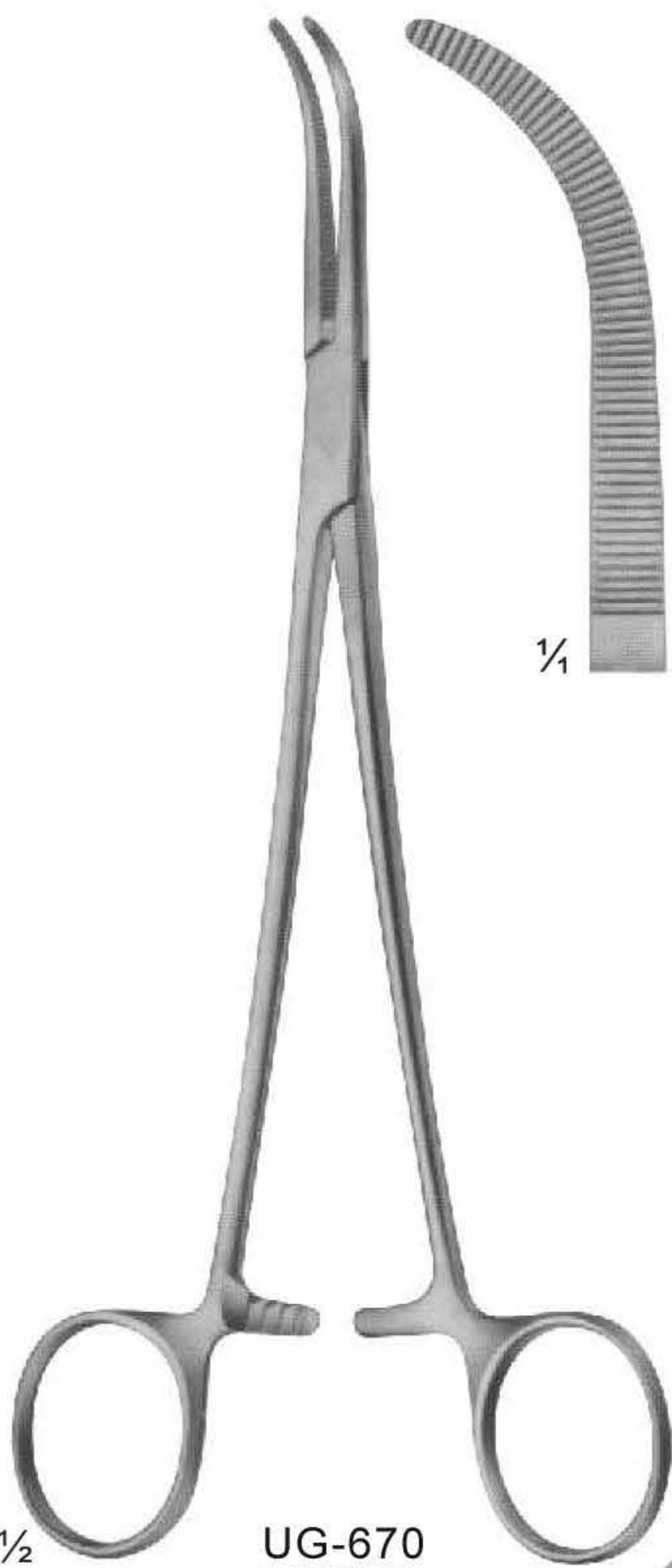

$\frac{1}{2}$
UG-670
HEISS
195 mm



$\frac{1}{2}$
UG-671
RUMEL
240 mm

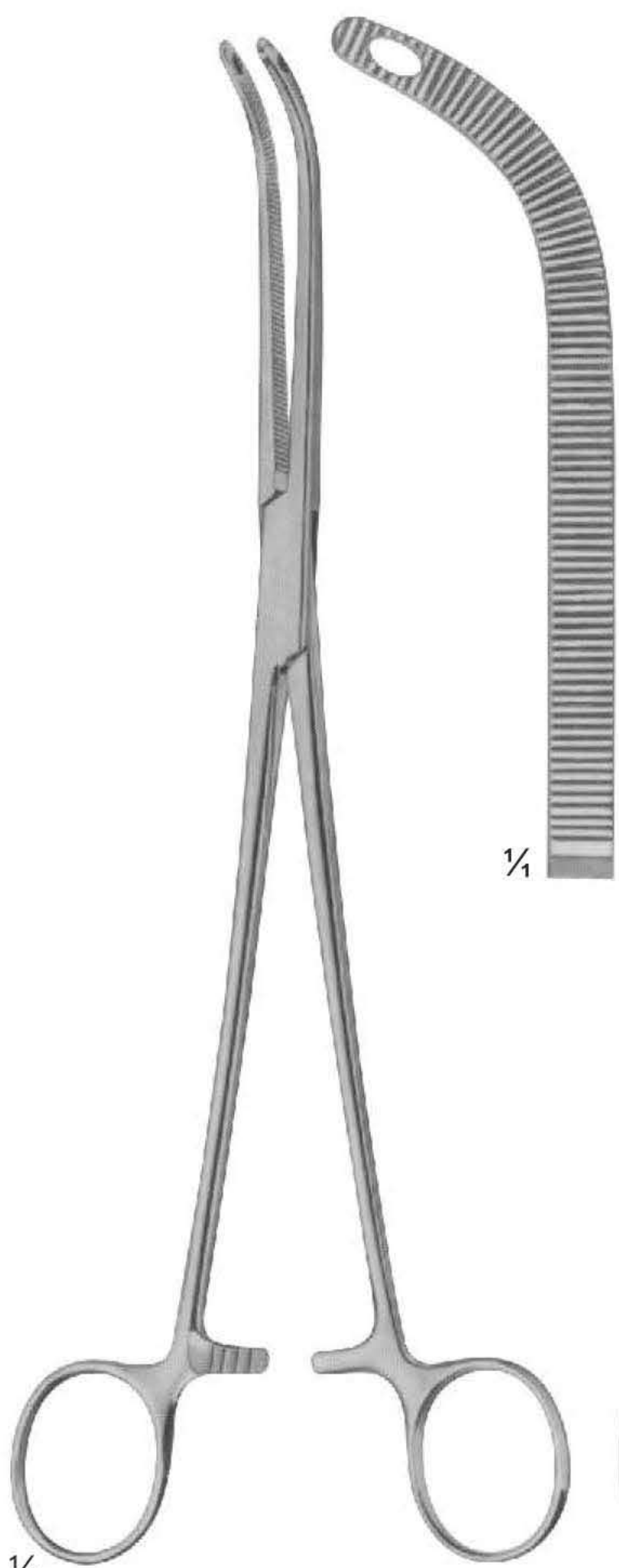

$\frac{1}{2}$
UG-673
FINOCCHETTO
245 mm

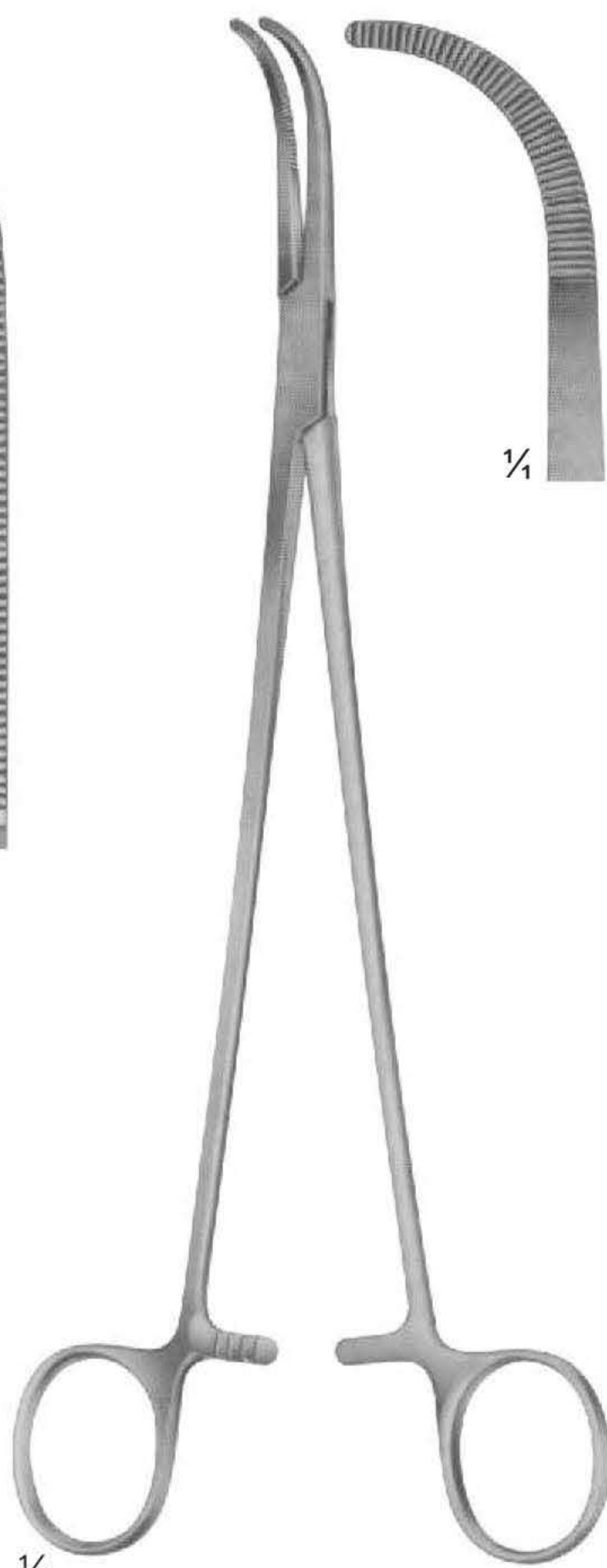

$\frac{1}{2}$
UG-674
MIXTER
230 mm



$\frac{1}{3}$
UG-675
LAWRENCE
270 mm



$\frac{1}{3}$
UG-676
ZENKER

Dissecting- and Ligature Forceps



1/2 UG-679
LOWER



1/2 UG-683
LAHEY (SWEET)



1/2 UG-685
MIXTER

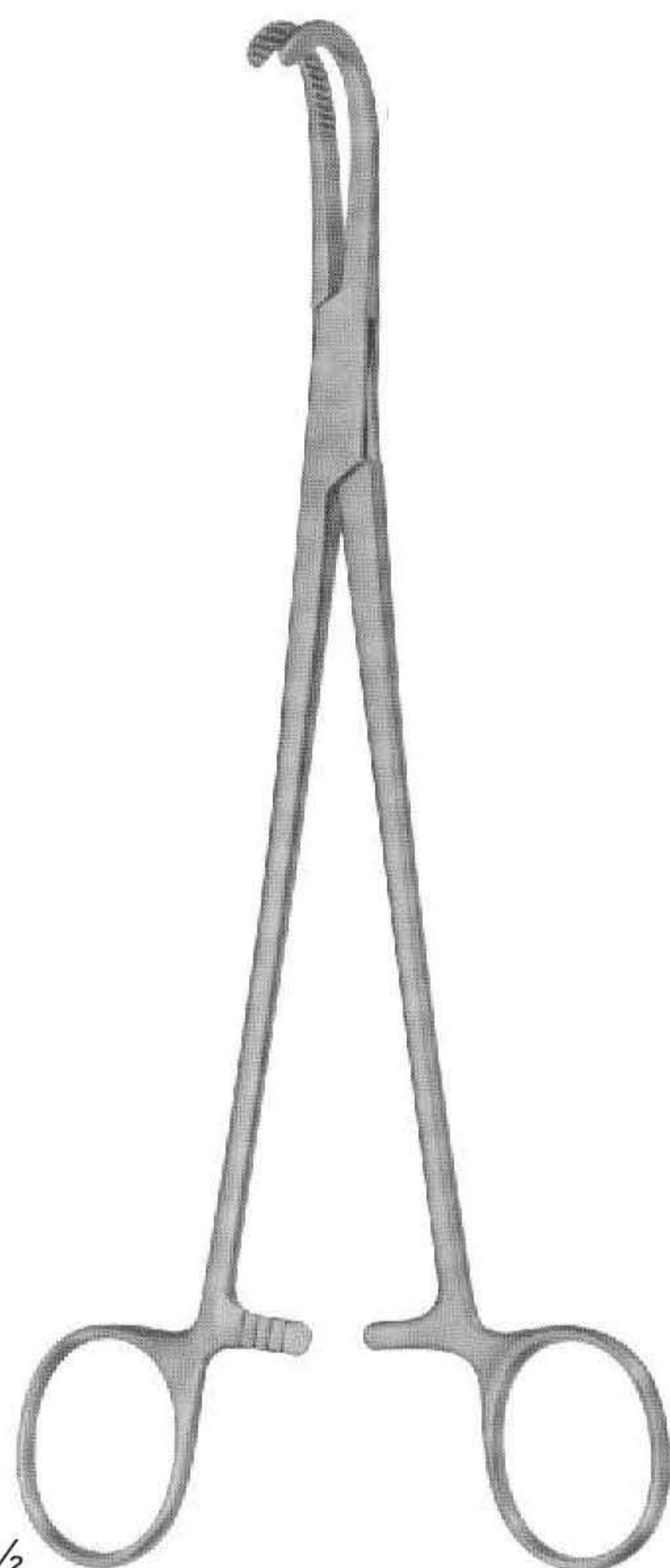

1/2 UG-686
DESJARDINS



1/2 UG-688
GRAY

Peritoneum Forceps

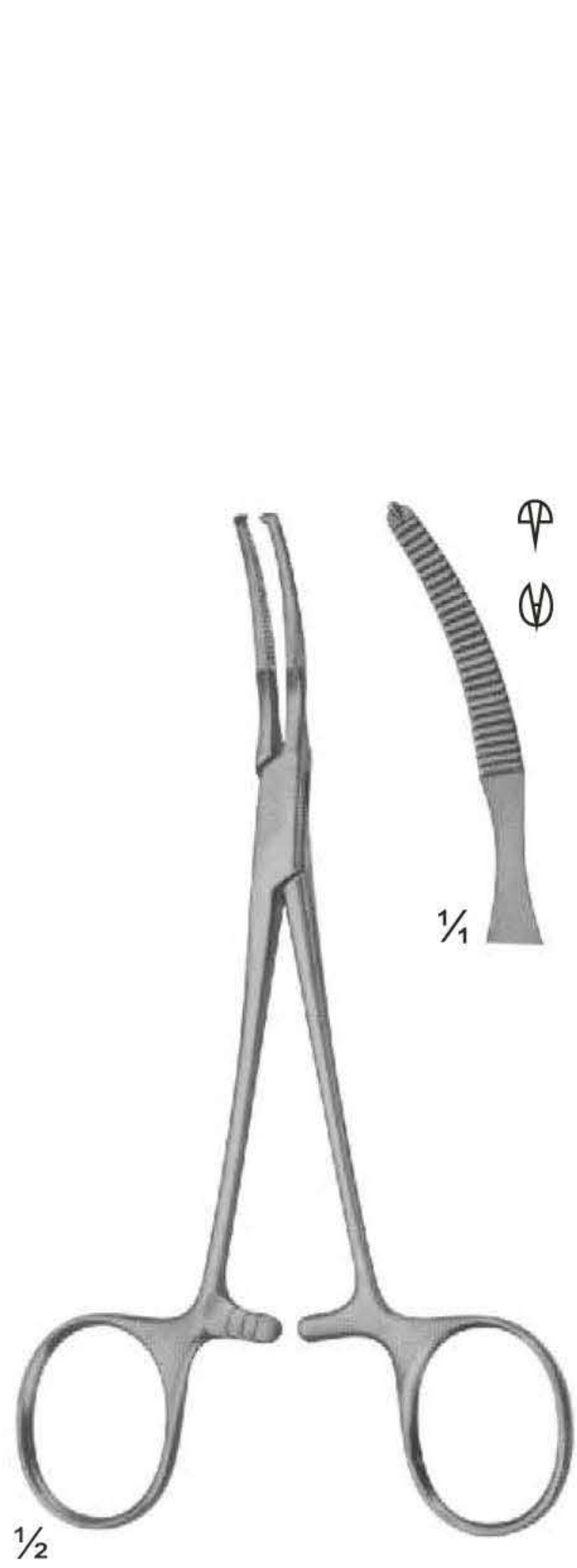

UG-689
BABY-MIKULICZ
140 mm

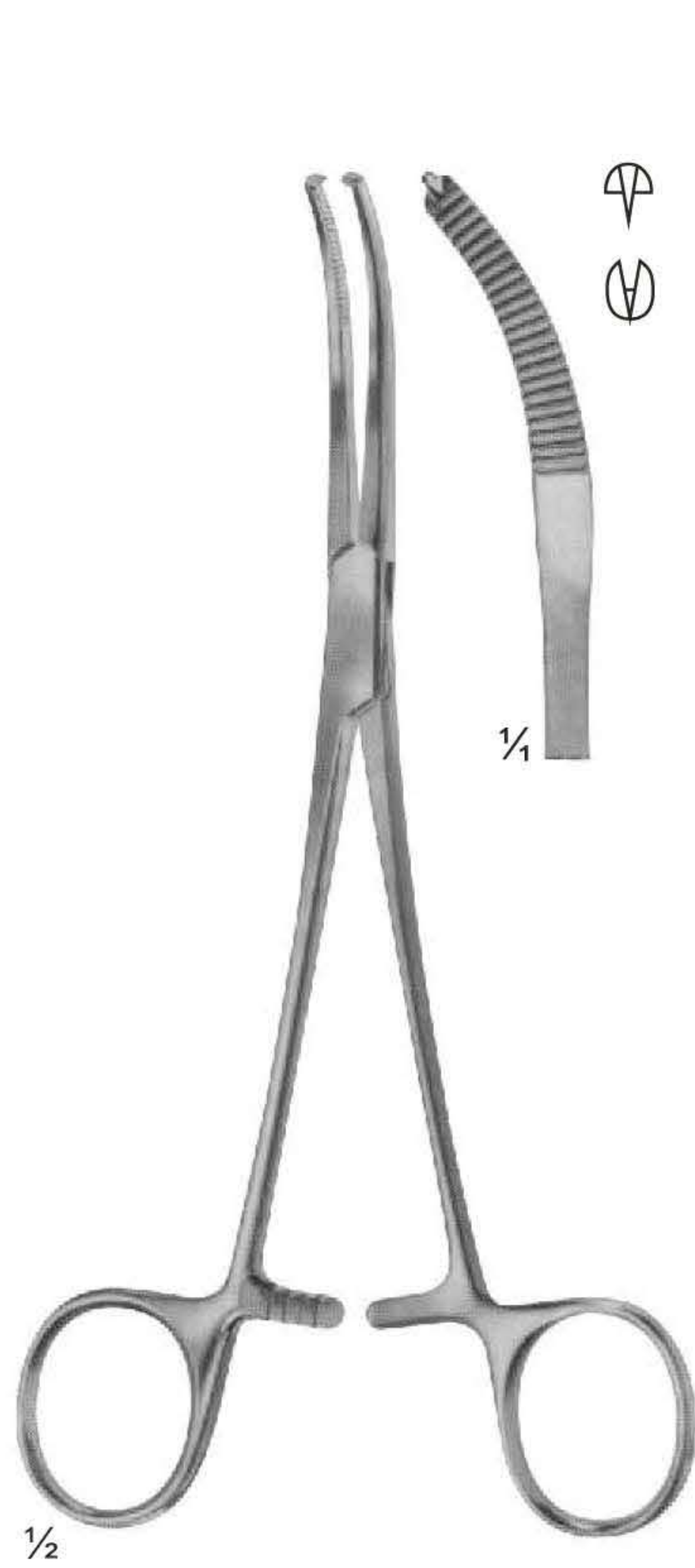

UG-690
MIKULICZ
185 mm

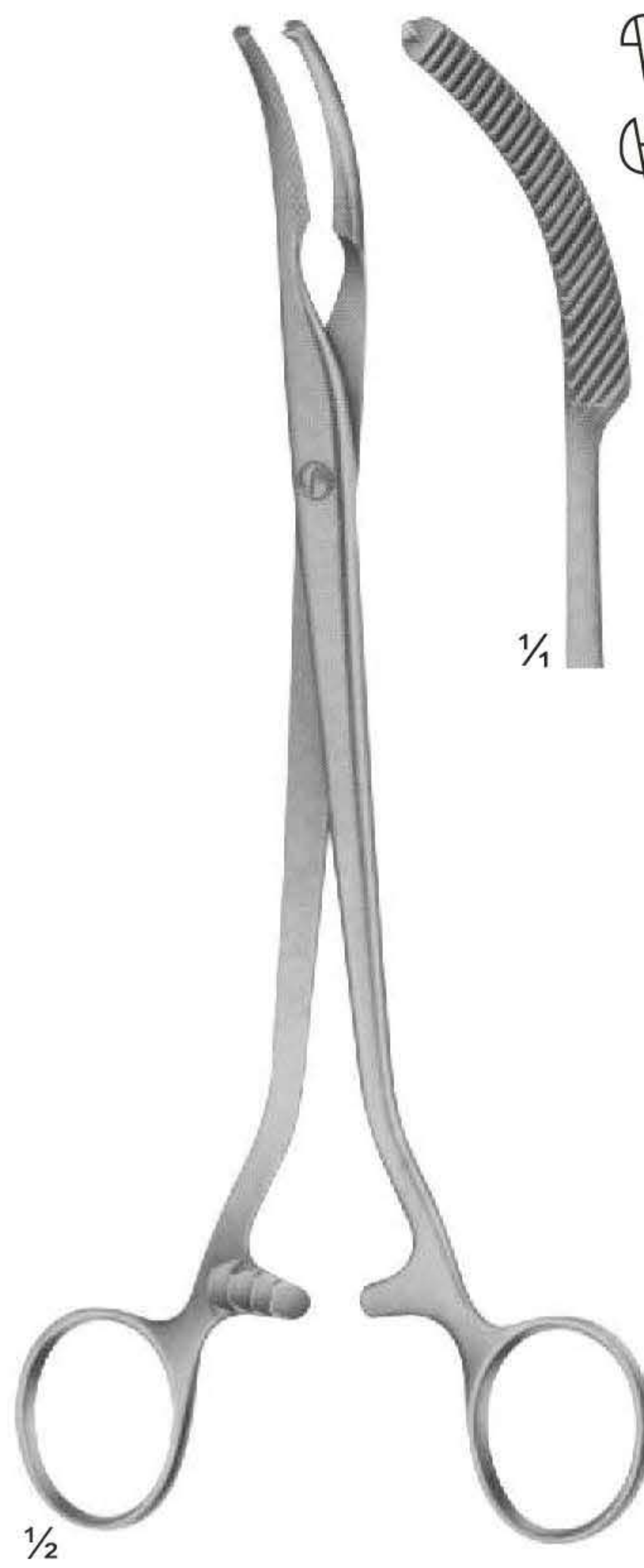

UG-691
MIKULICZ
205 mm

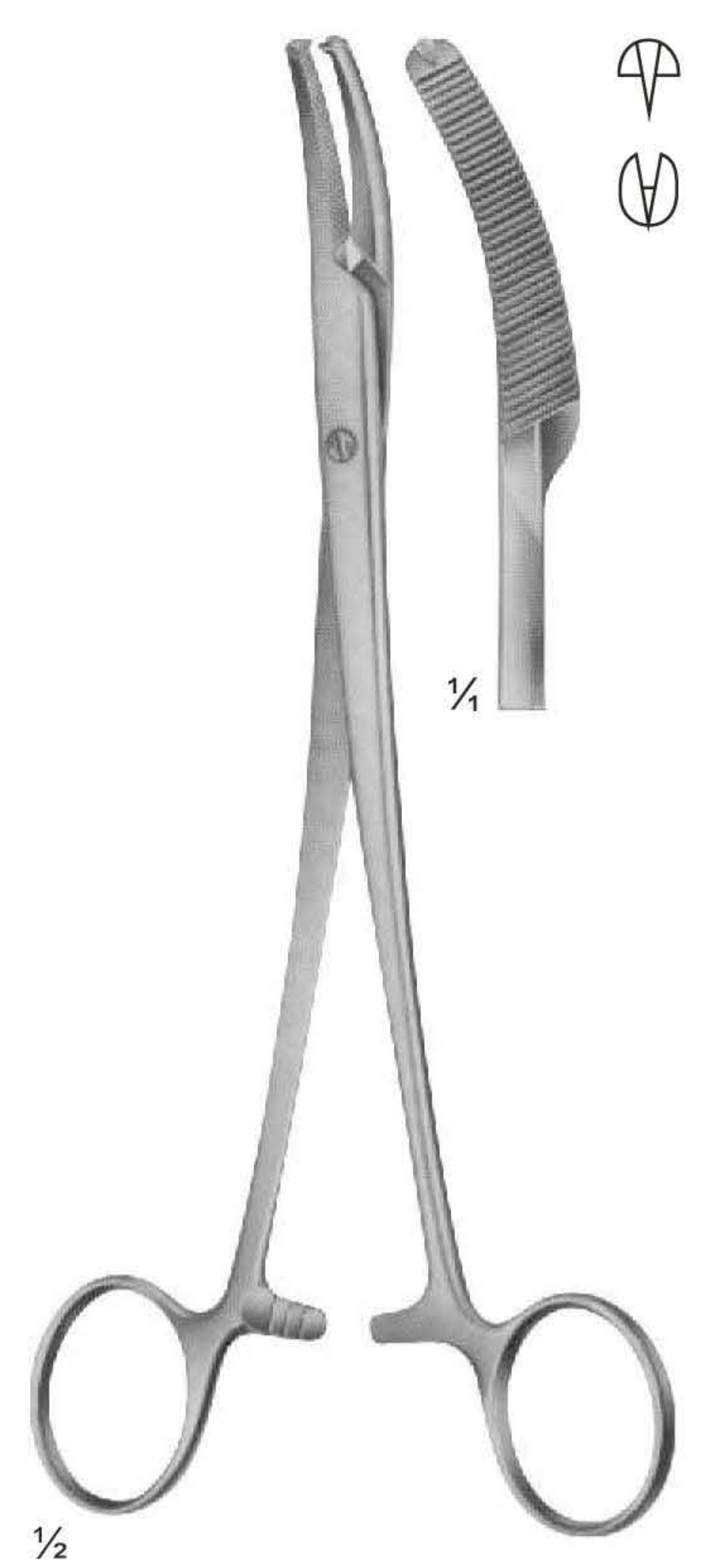

UG-692
MIKULICZ
200 mm

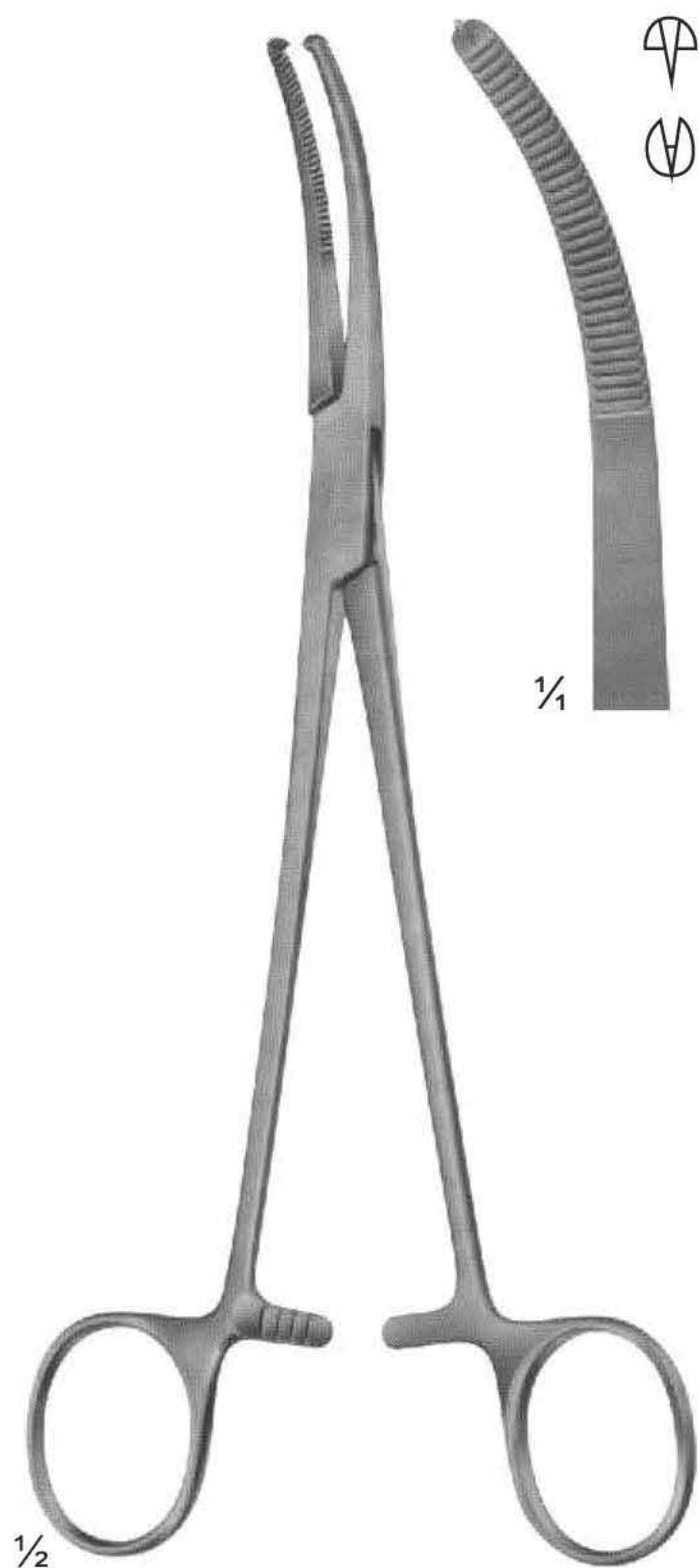

UG-693
MIKULICZ
205 mm

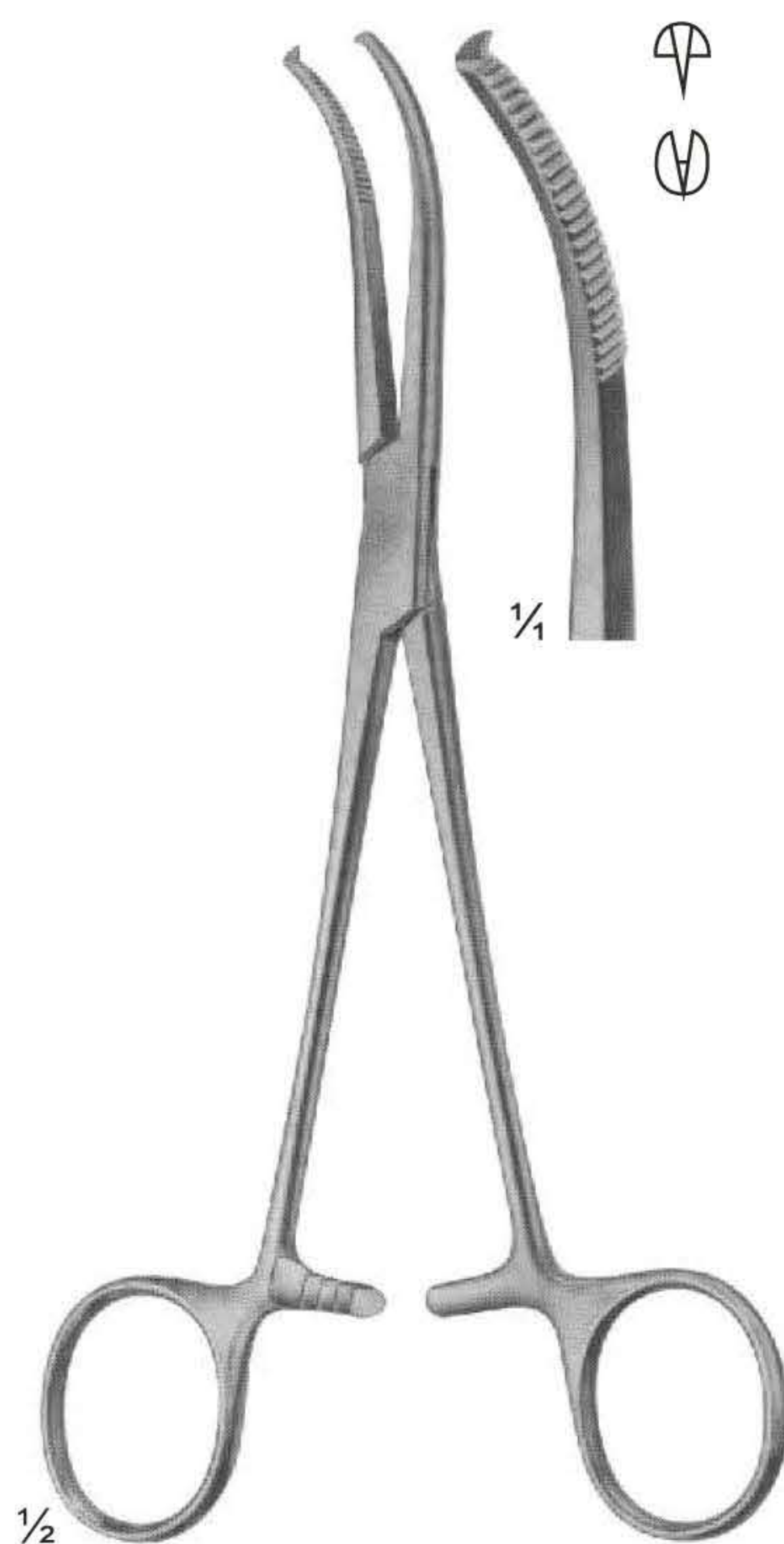

UG-694
MIKULICZ
185 mm



UG-695
FAURE
205 mm

Hysterectomy Forceps



$\frac{1}{2}$
UG-696
PHANEUF



$\frac{1}{2}$
UG-697
HEANEY modif.



$\frac{1}{2}$
UG-698
HEANEY

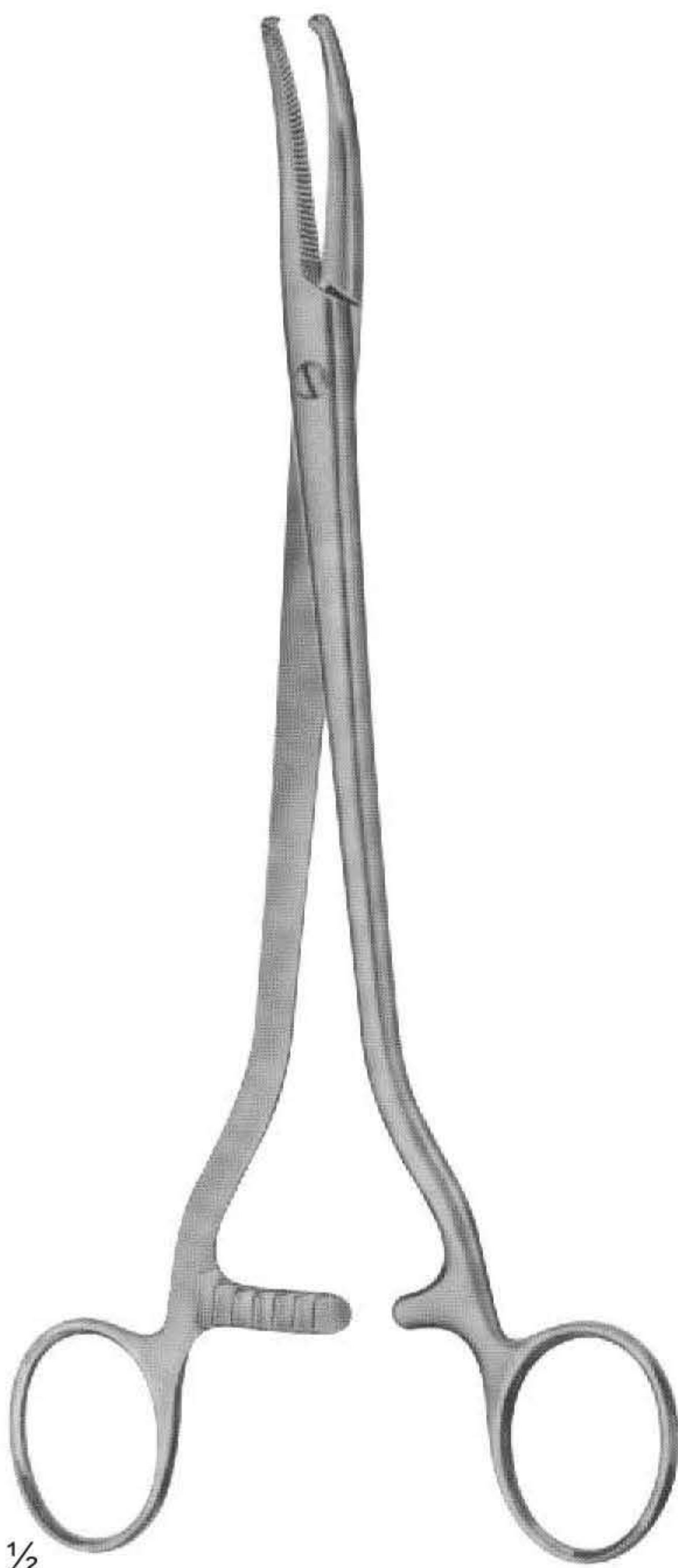

$\frac{1}{2}$
UG-699
WERTHEIM

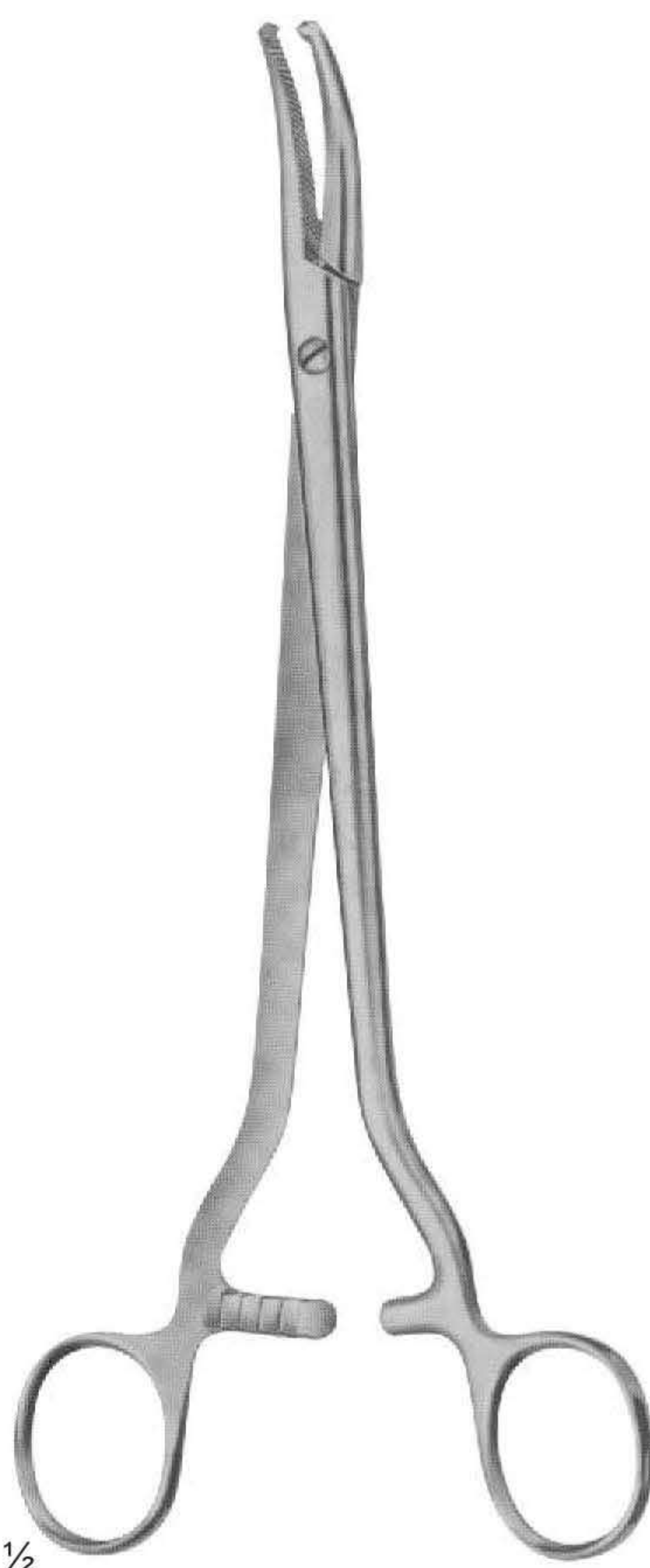

$\frac{1}{2}$
UG-700
WERTHEIM



$\frac{1}{2}$
UG-701
WERTHEIM

Hysterectomy Forceps and Vaginal Clamps



Hysterectomy Forceps and Vaginal Clamps and Compression Forceps



UG-704
WERTHEIM
Hysterectomy Forceps
255 mm

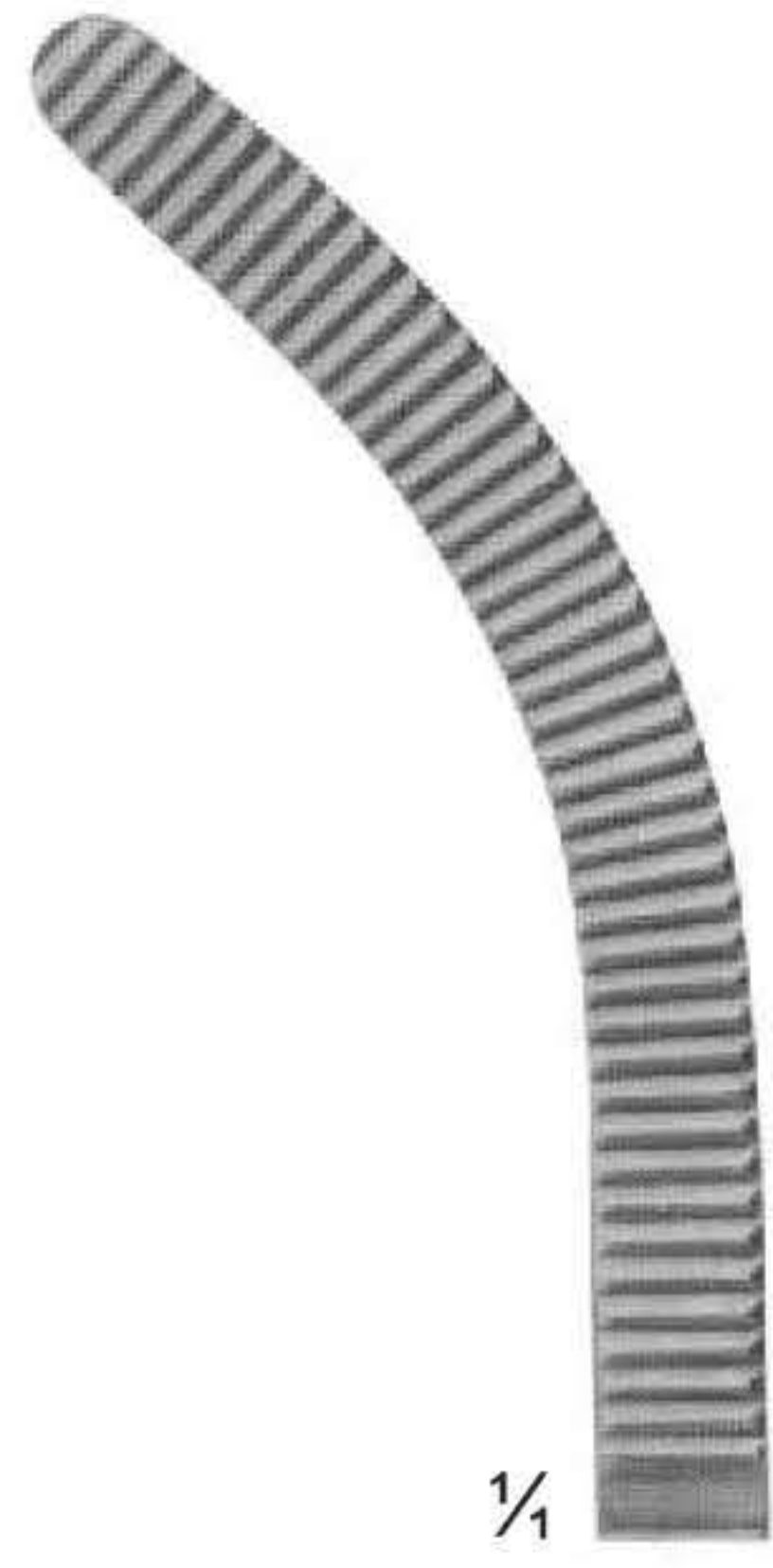

1/4

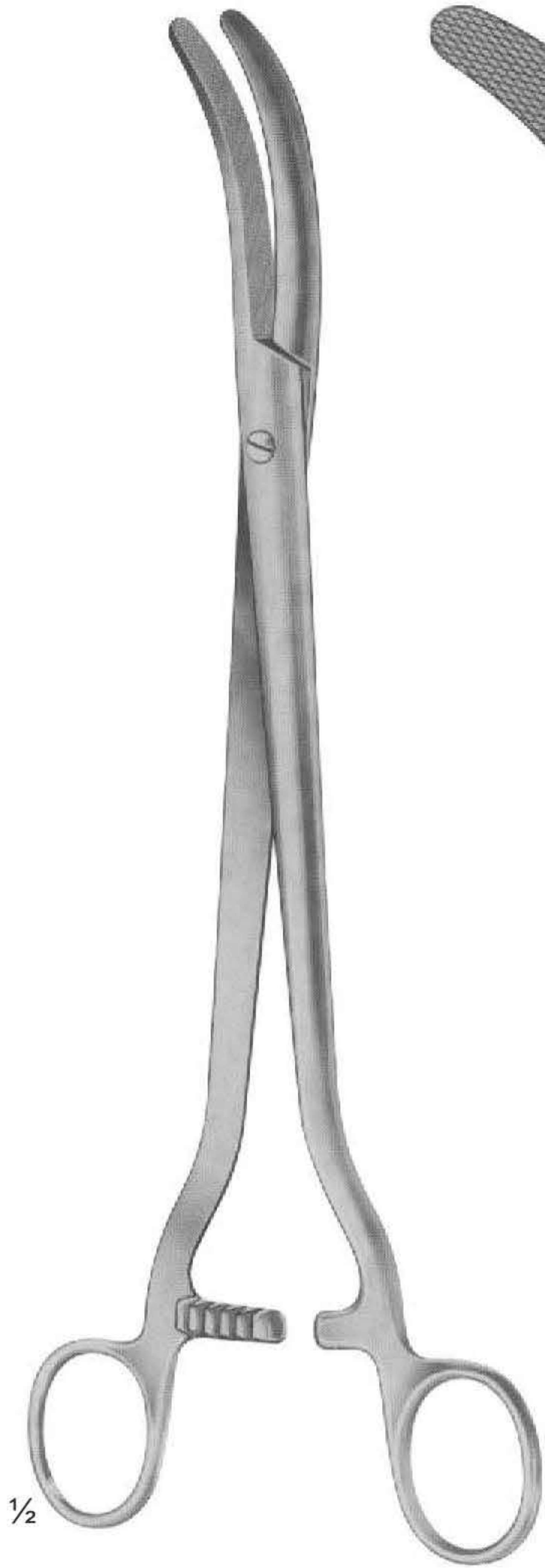

UG-705
WERTHEIM
Parametrium Clamp
260 mm



1/4

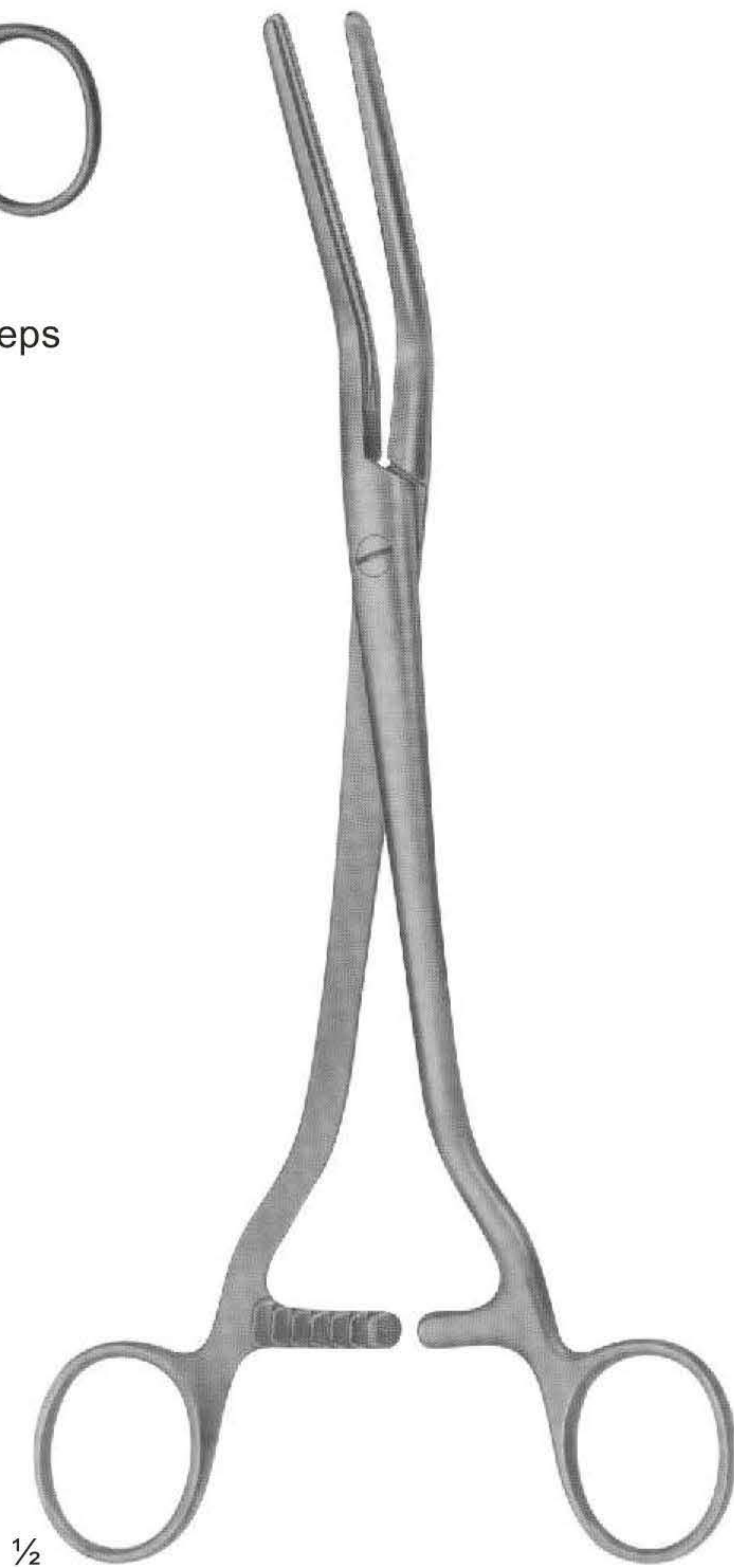

UG-706
DICK

1/2

Hysterectomy Forceps and Vaginal Clamps and Compression Forceps



Needle Holders For Micro Surgery



UG-242
ROHRSCHEIDER
With copper inserts
100 mm



UG-243
KALT
With catch
135 mm

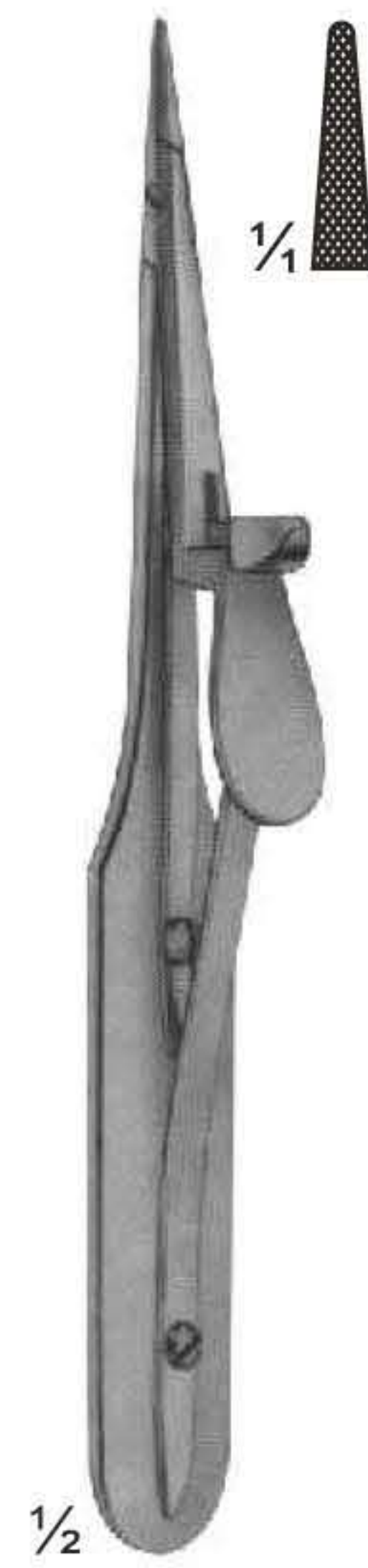

UG-244
ARRUGA
With catch
135 mm



UG-245
CASTROVIEJO
With catch
145 mm



UG-246
CASTROVIEJO
With Catch
160 mm

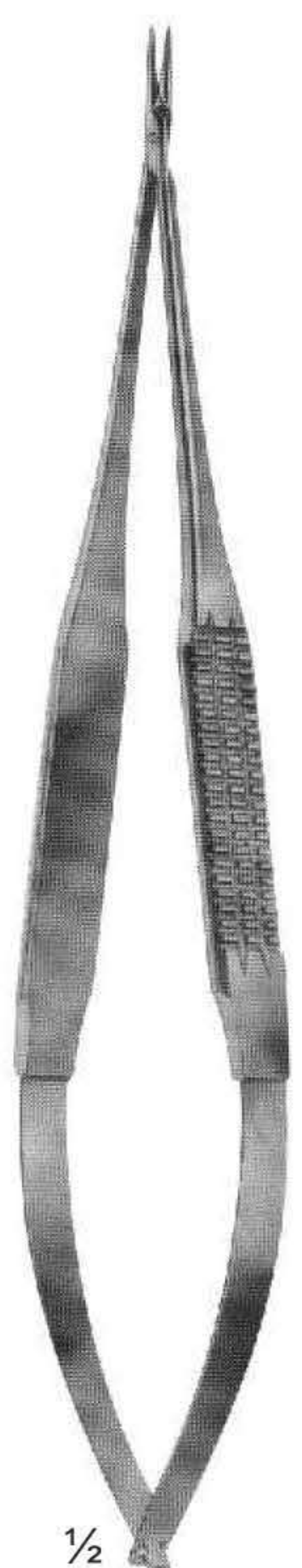

UG-261
Without catch
185 mm

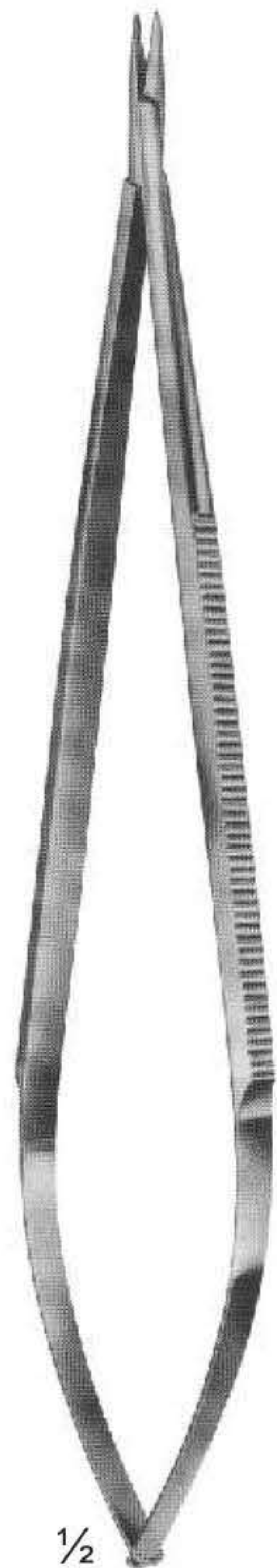

UG-263
JACOBSON
185 mm

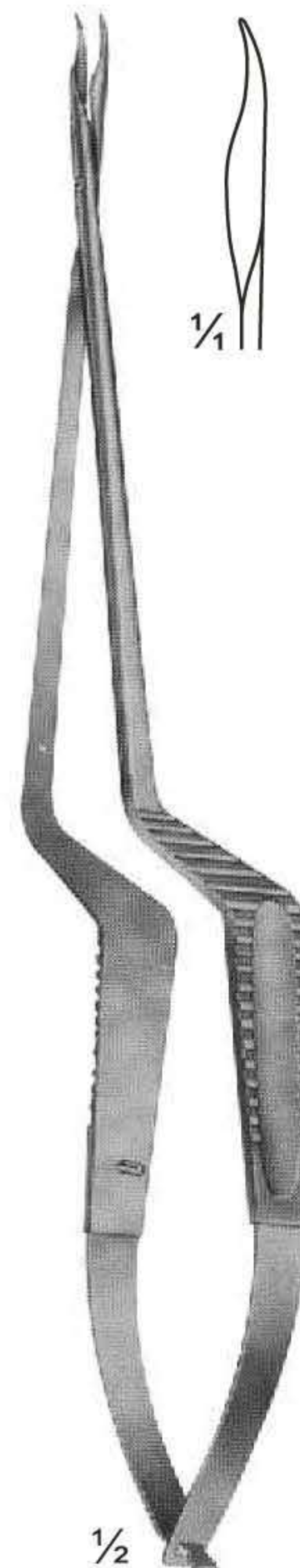

UG-264
Without catch
195 mm



UG-265
YASARGIL
With catch
200 mm

Micro Needle Holders With Round Handles



1/2
UG-267
 BARRAQUER
 Without catch



1/2
UG-268
 BARRAQUER
 Without catch
 120 mm



1/2
UG-269
 BARRAQUER
 With catch
 120 mm



1/2
UG-271
 BARRAQUER
 With Catch
 150 mm



1/4
UG-273
 MULLER
 With Locking
 Mechanism
 145 mm



1/2
UG-275
 BROCK
 Without catch
 150 mm



1/2
UG-277
 YASARGIL
 200 mm



1/2
UG-279
 YASARGIL
 225 mm



1/2
UG-280
 YASARGIL
 245 mm

Needle Holders

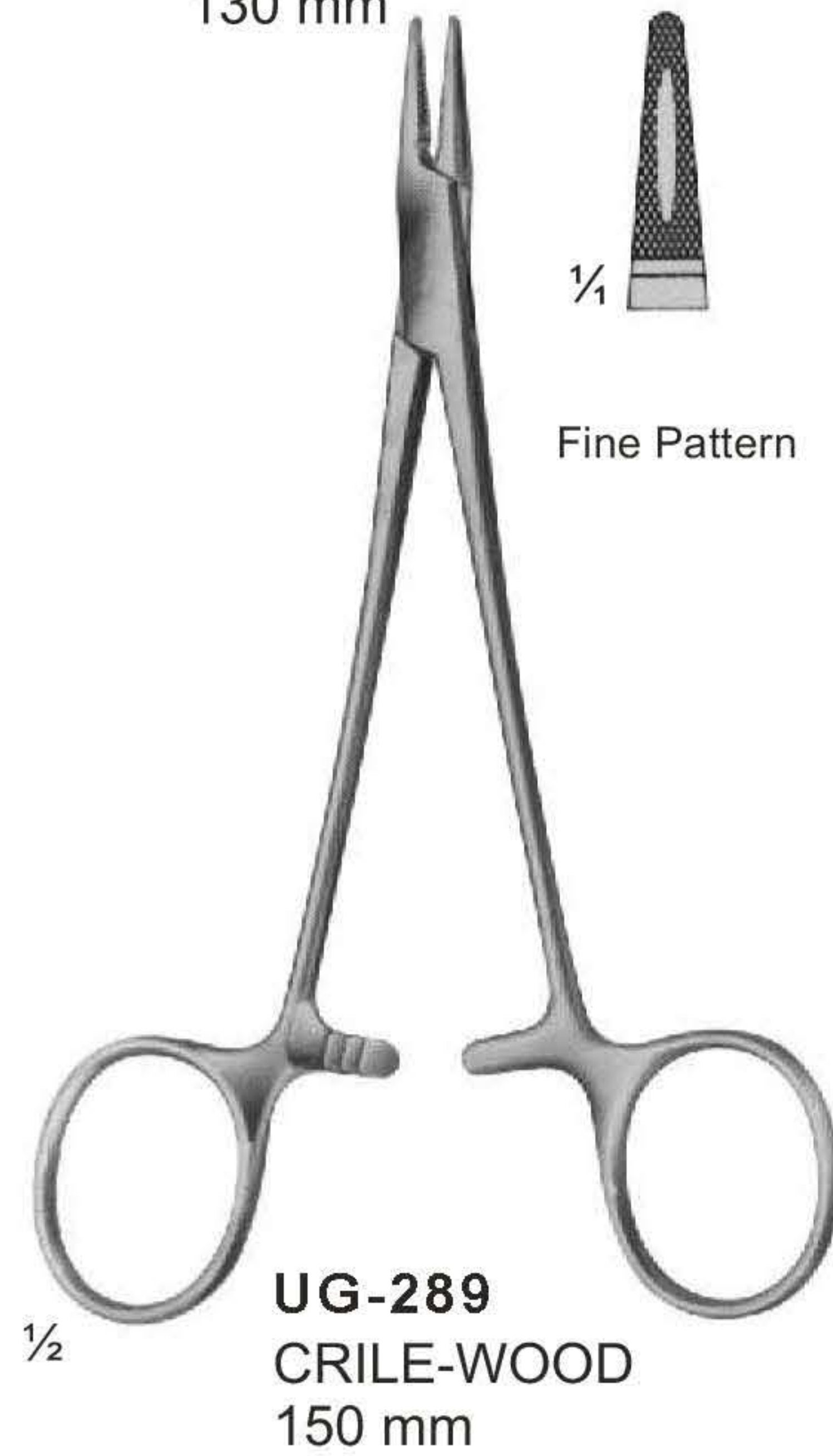
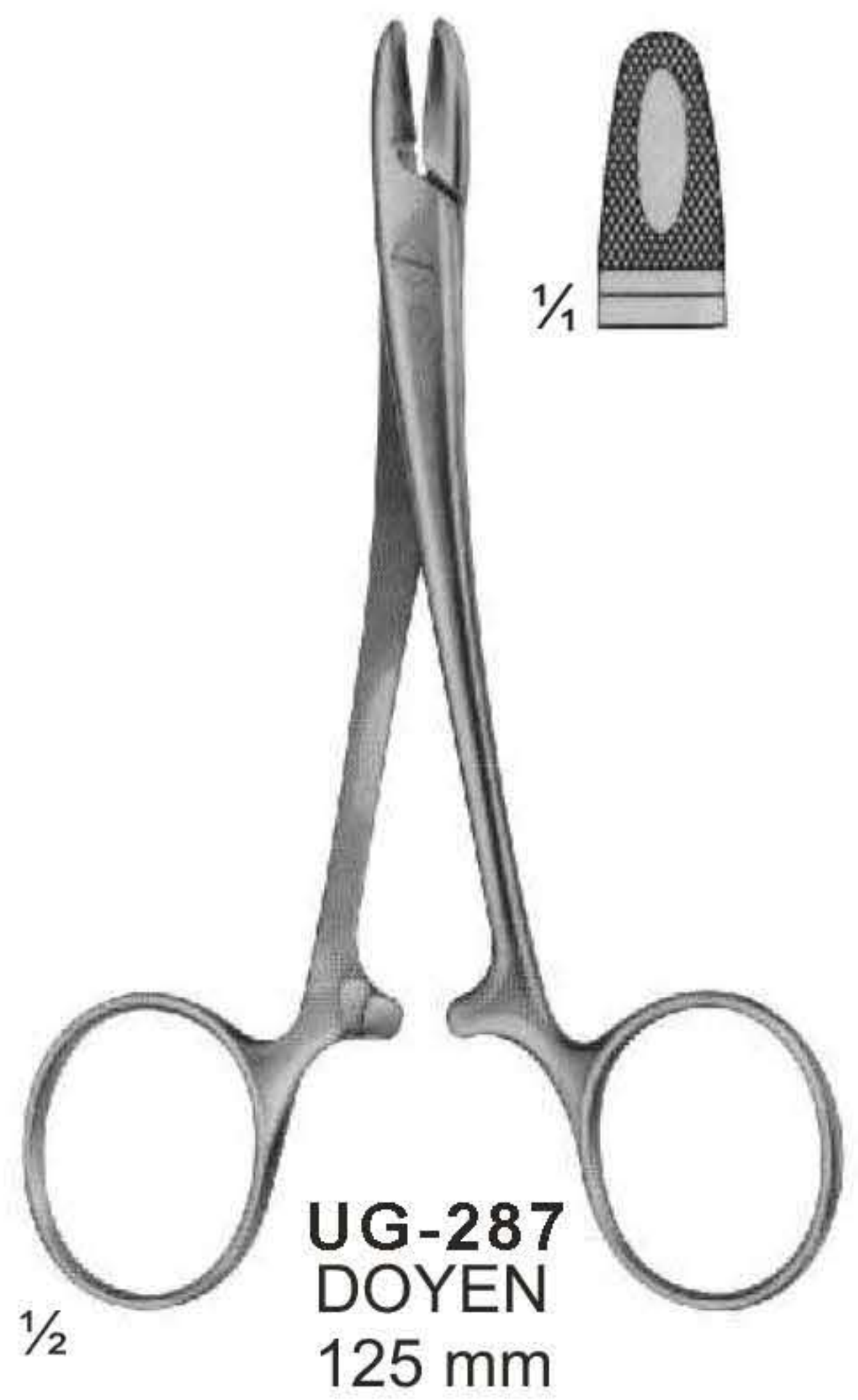
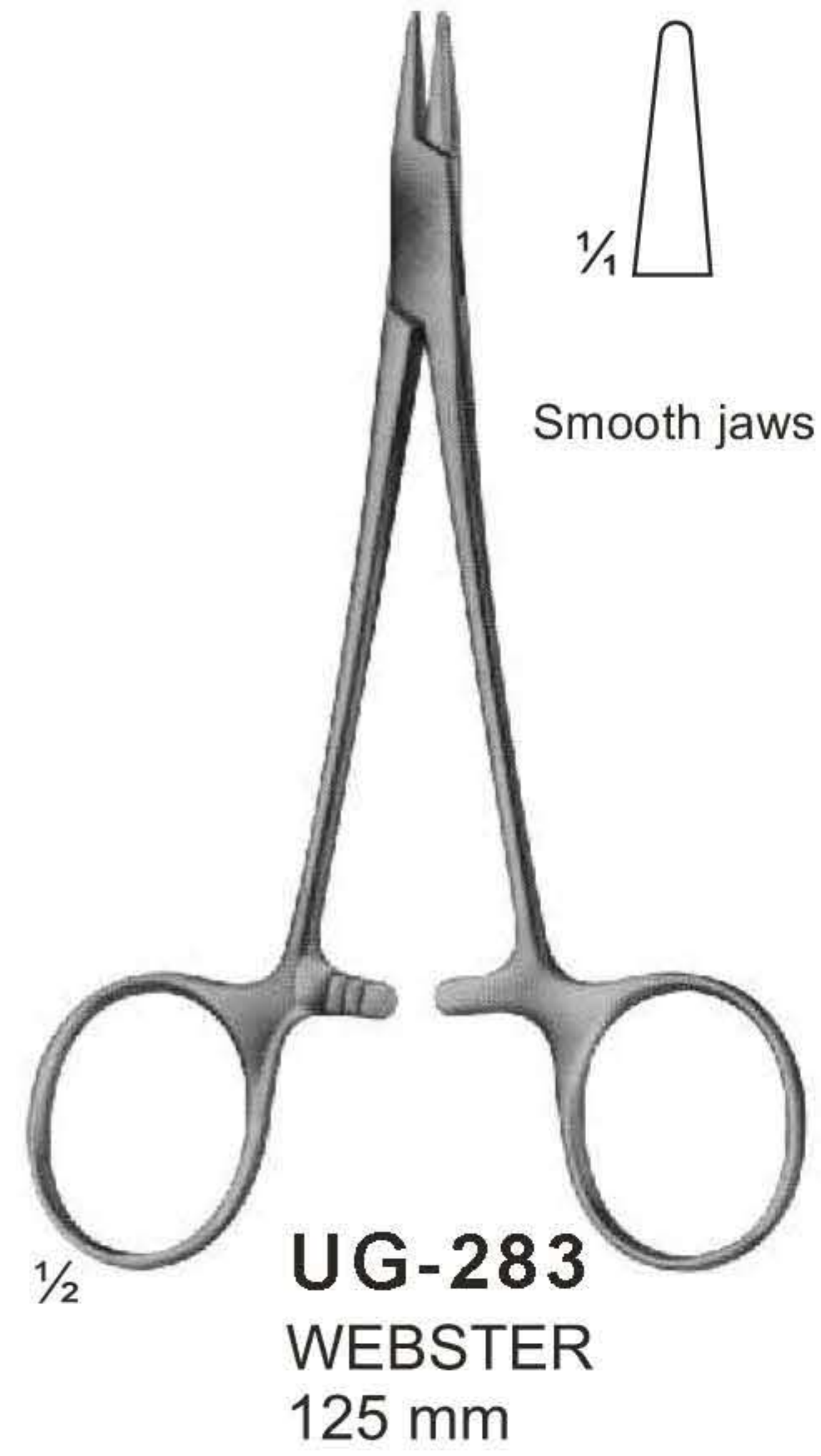

Needle Holders



UG-295
MAYO-HEGAR
Medium fine patterns



UG-298
HEGAR
Heavy Patterns



UG-301
HEANEY (HEGAR)
200 mm



UG-302
JAMESON
230 mm



UG-304
WANGENSTEEN
275 mm



UG-305
MASSON
265 mm

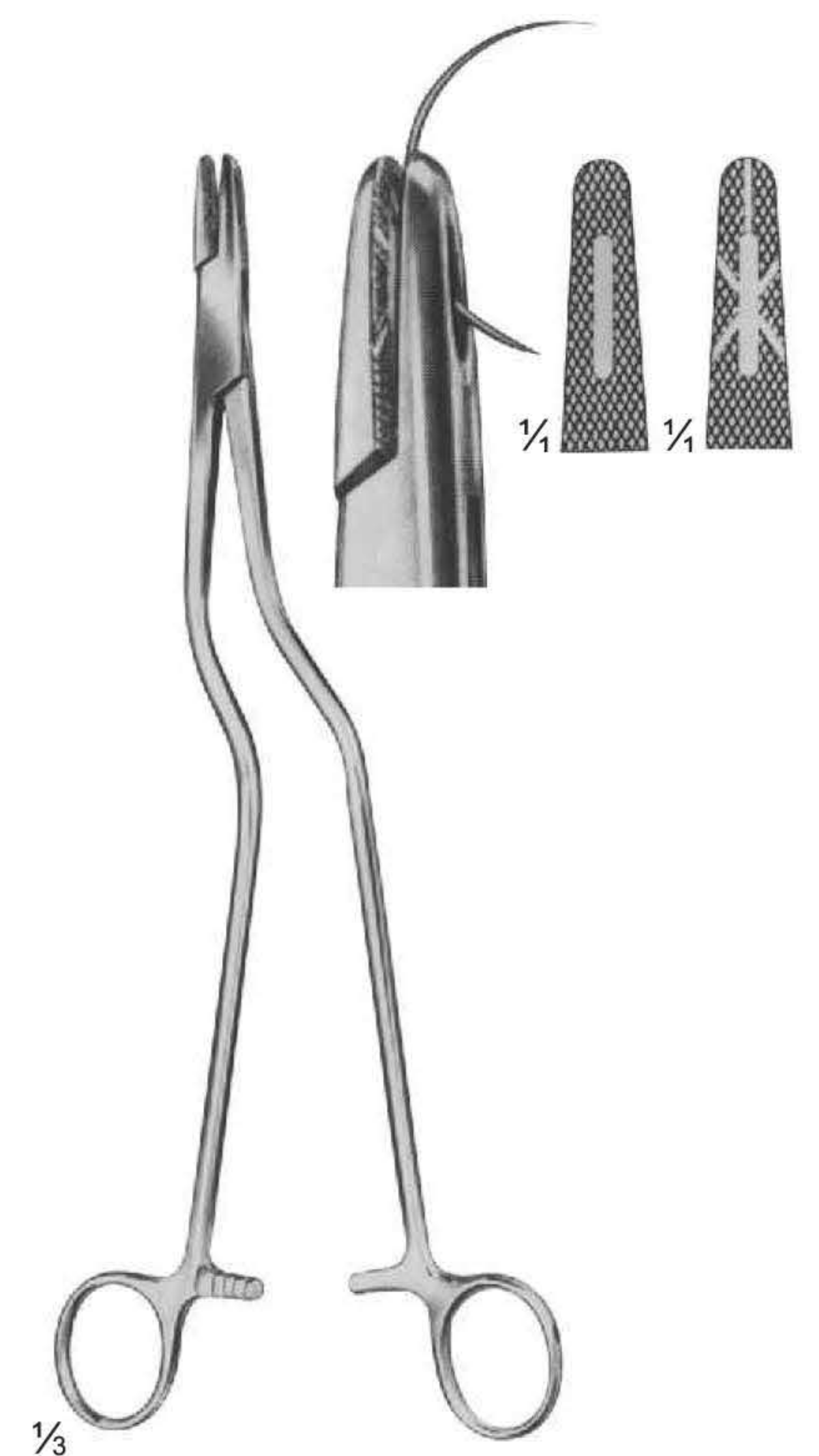

UG-307
MASSON-LUETHY
255 mm

Needle Holders



UG-309
HEGAR-OLSEN
255 mm

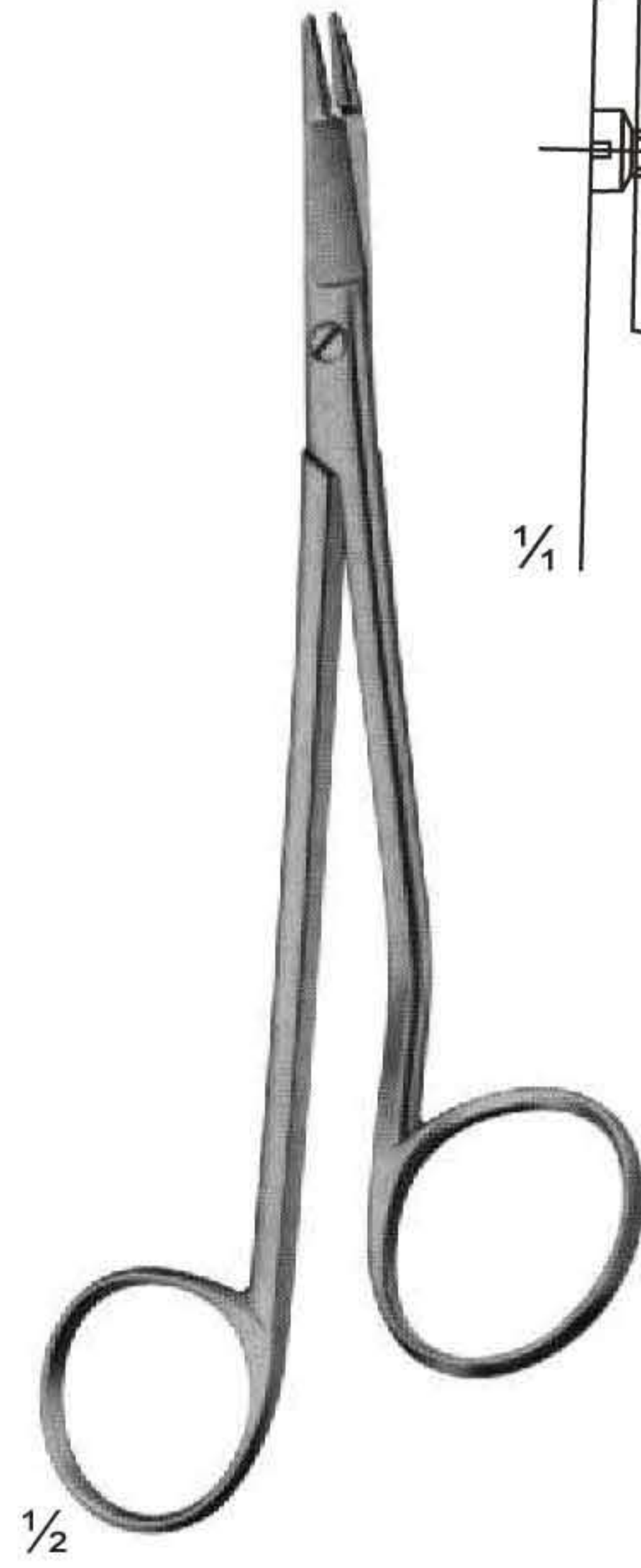
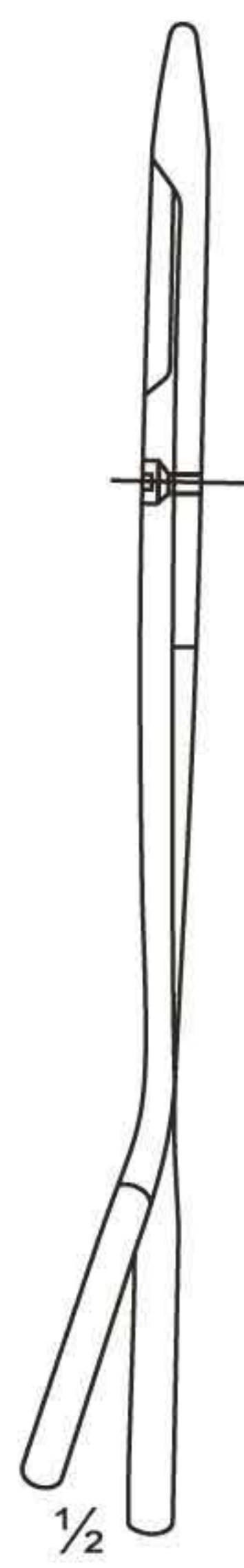

UG-310
GILLIES
150 mm

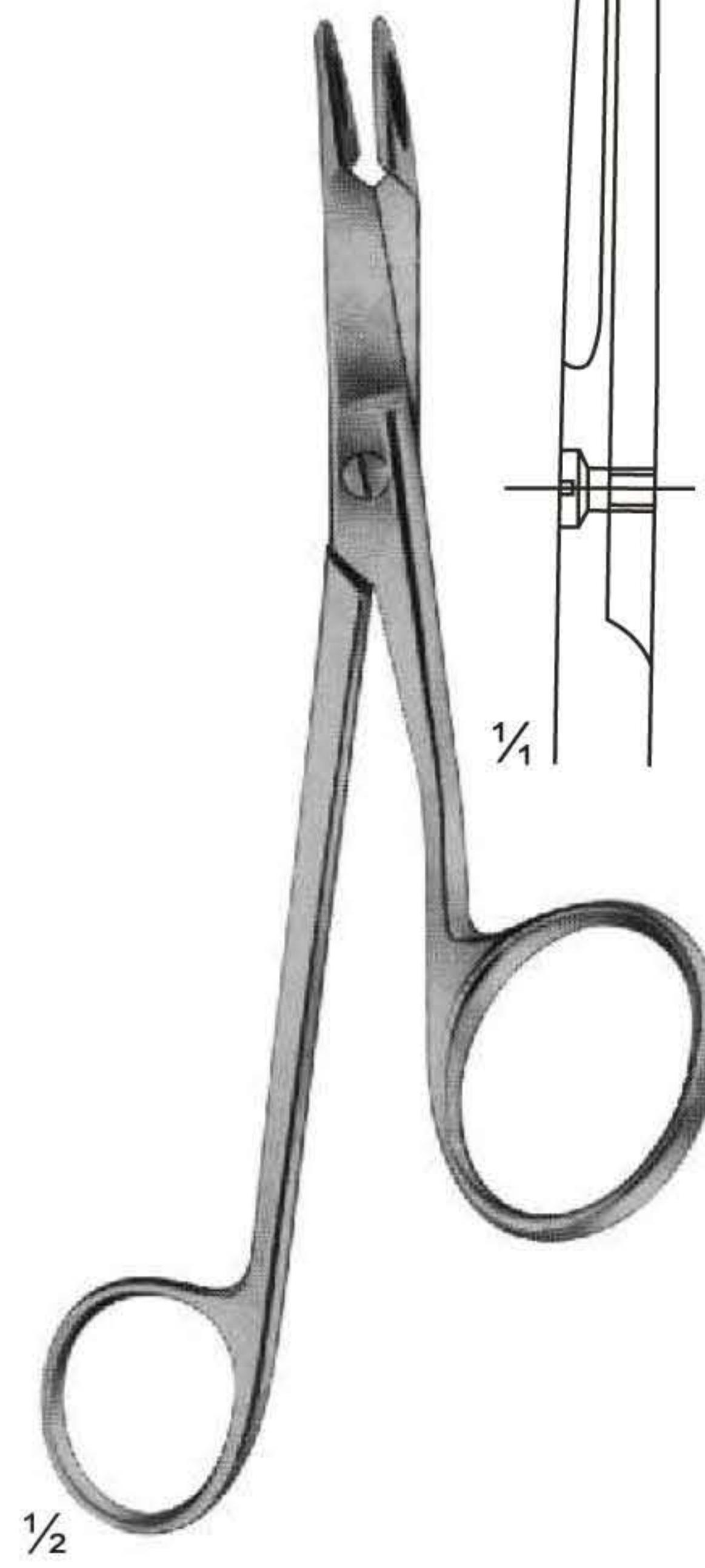
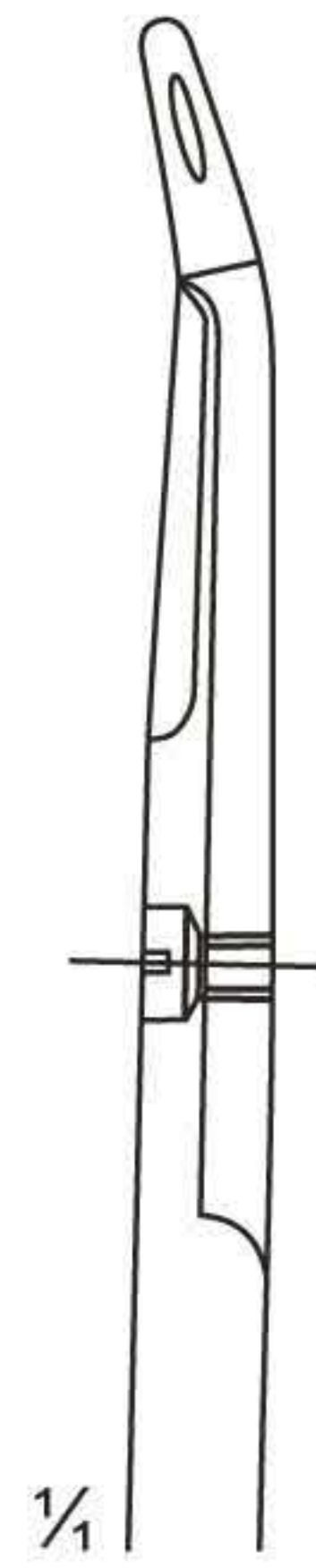

UG-312
GILLIES
160 mm

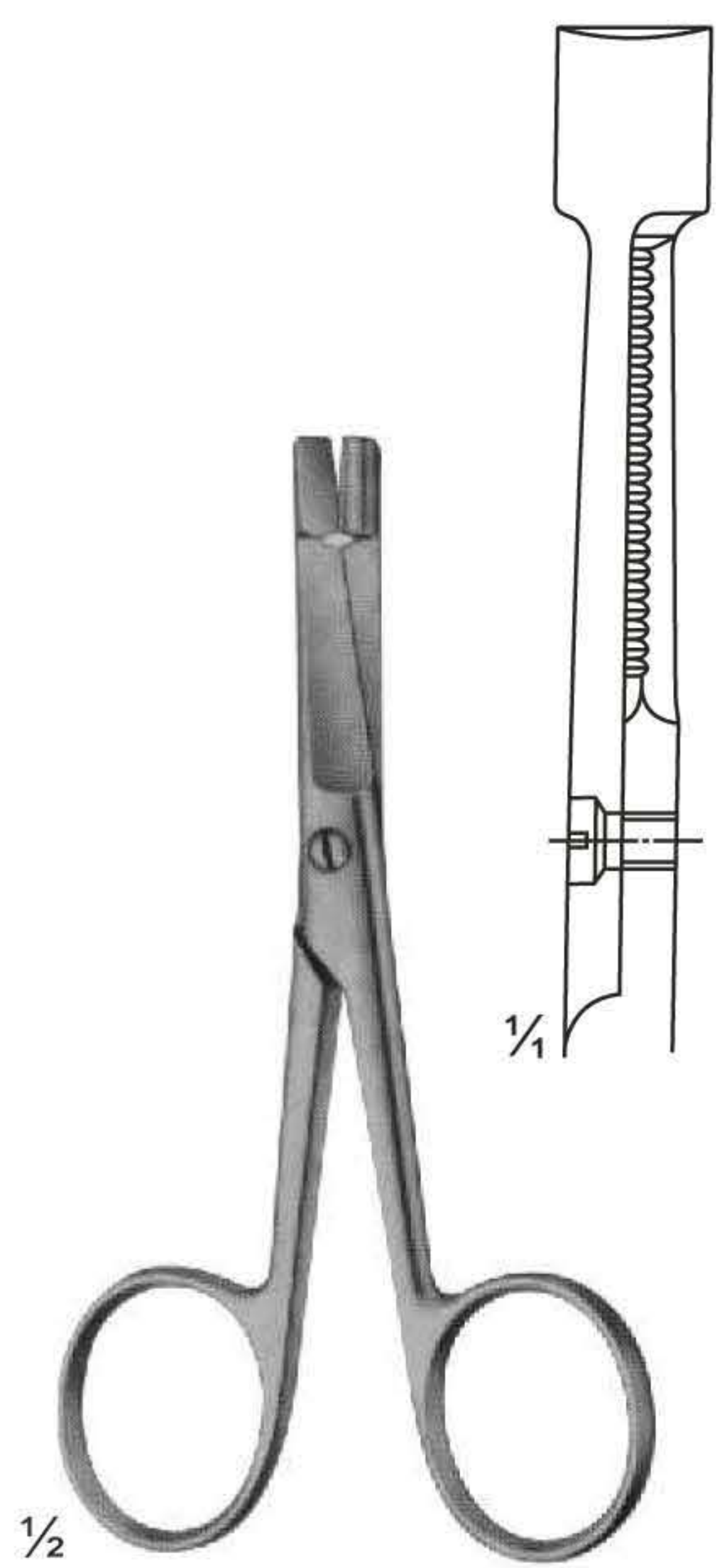
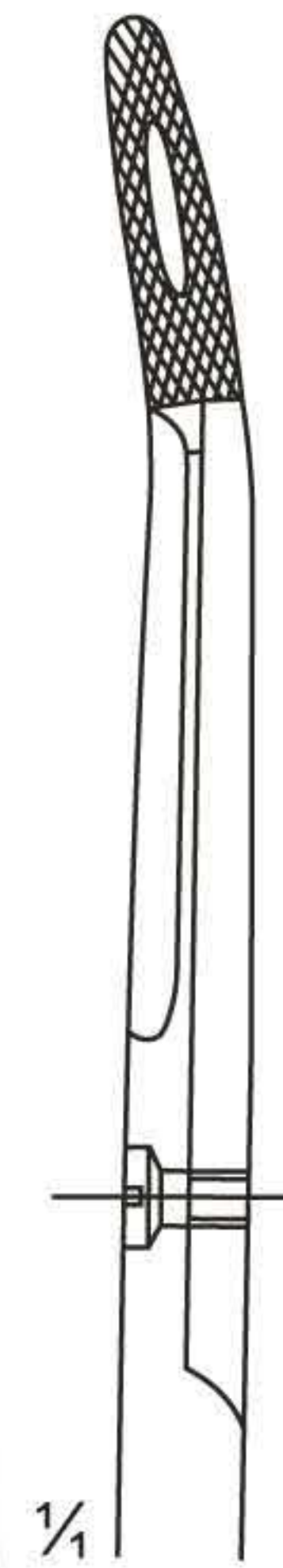

UG-313
EISELSBERG
115 mm

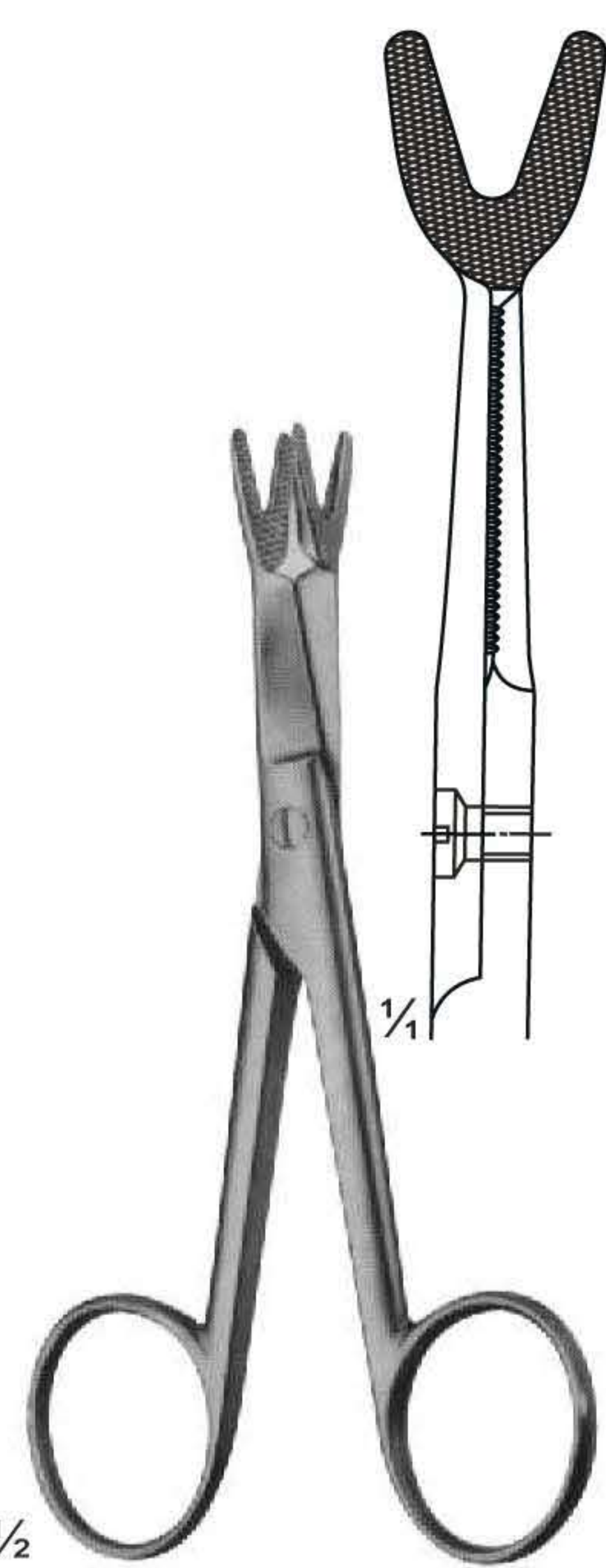
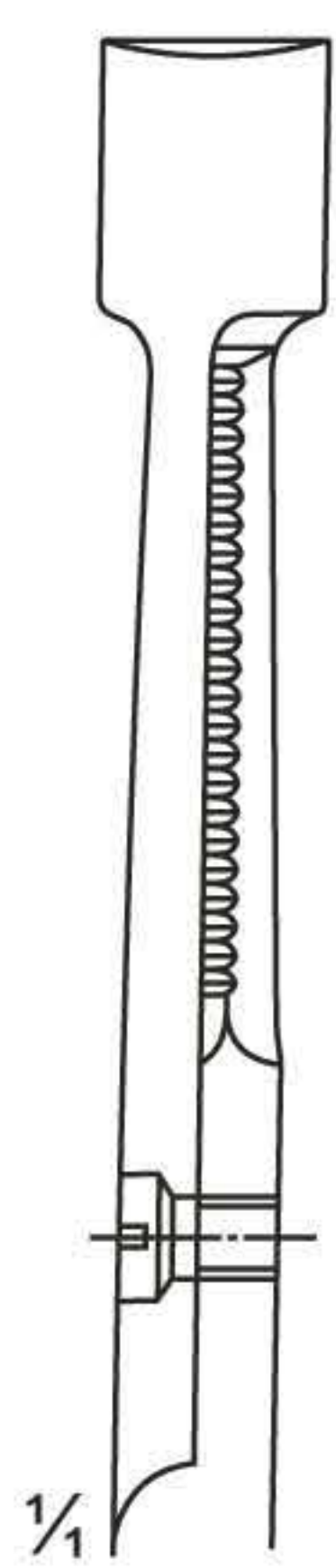

UG-314
SCHOEMAKER-LOTH
125 mm



UG-315
CRILE
150 mm



UG-317
TONNIS
Elastic pattern for
dura-or intestinal suture
180 mm



Needle Holders



UG-318
MATHIEU



UG-320
BOYNTON
125 mm



UG-321
EISELSBERG-MATHIEU
For palate suture
195 mm



UG-322

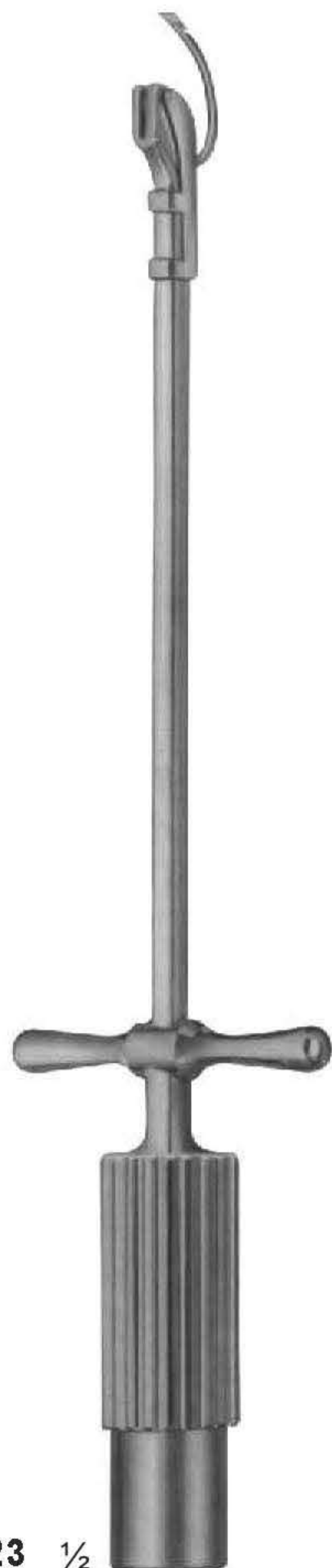

UG-323 1/2
YOUNG-HRYNTSCHAK
With 1 needle
240 mm



UG-325 1/2
YOUNG-MILLIN
With 1 needle
200 mm



UG-327
MILLIN
Ligature holding forceps
245 mm

Kidney Clamps

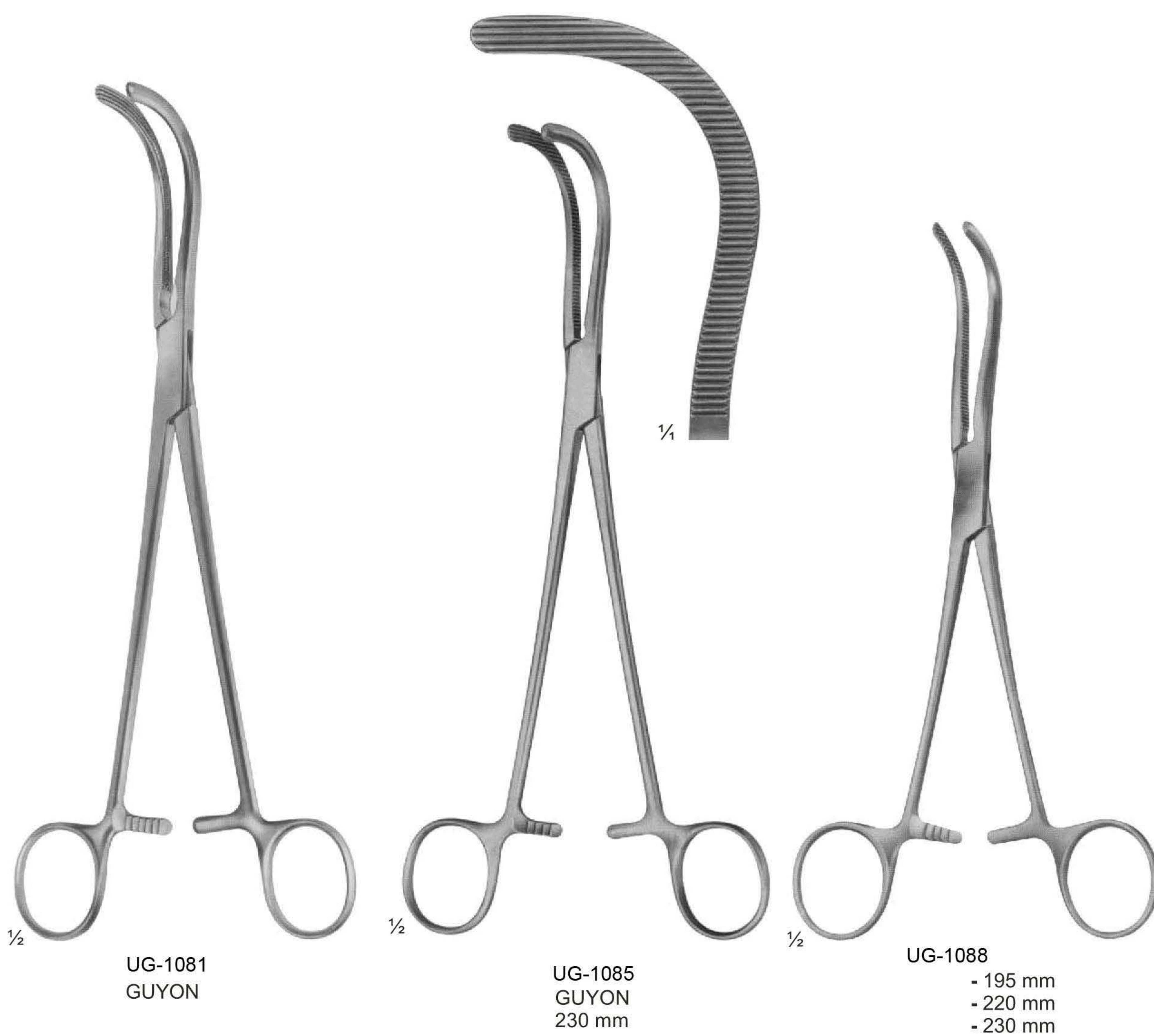

Kidney Clamps

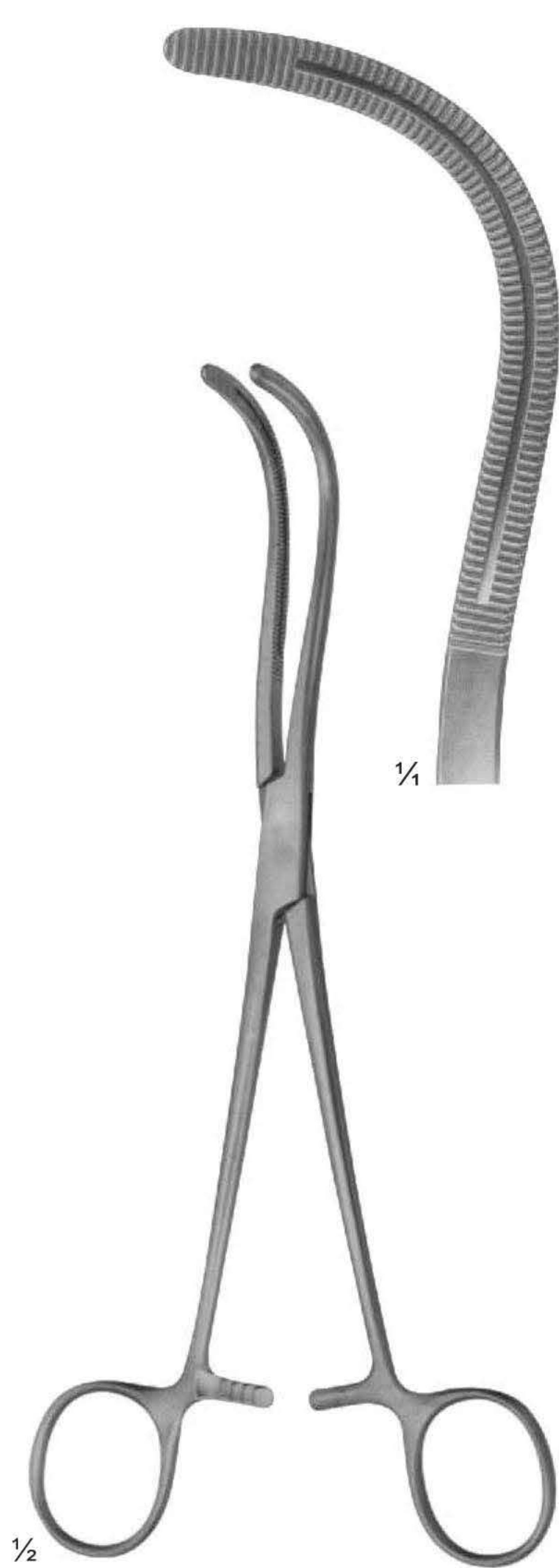

UG-1093
STILLE
220 mm

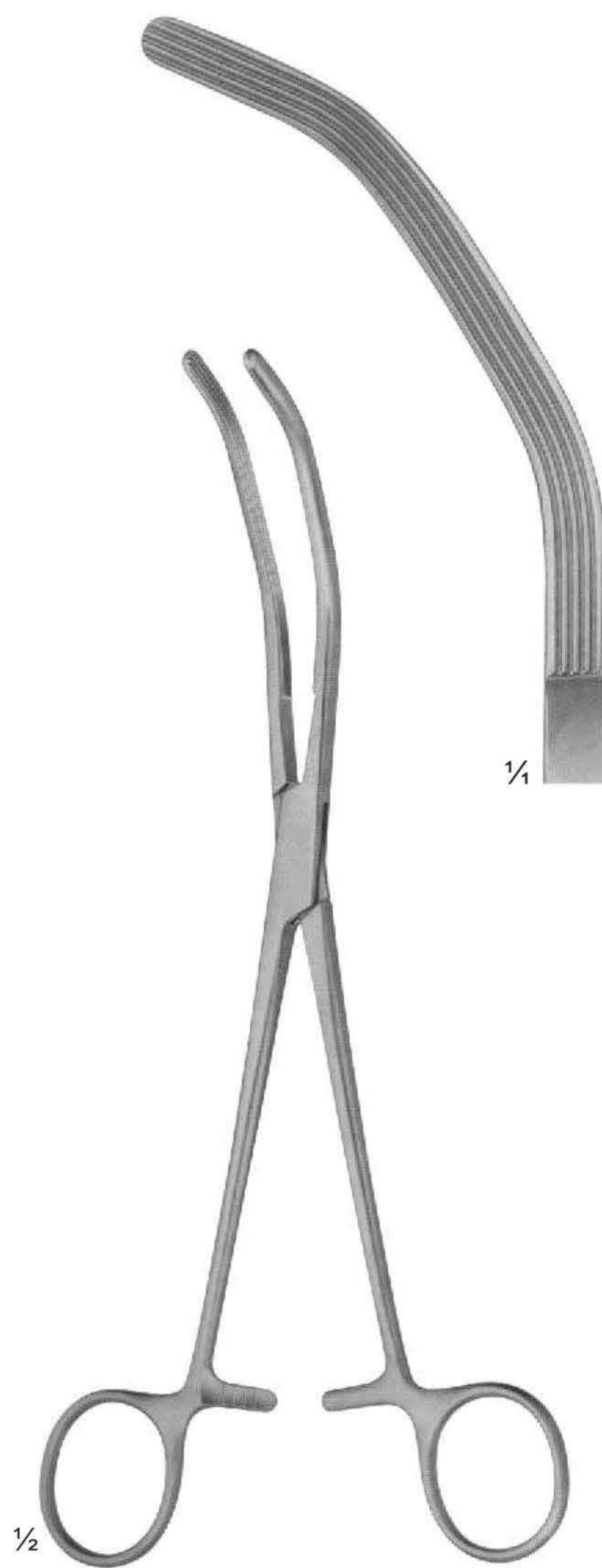

UG-1095
HERRICK
225 mm

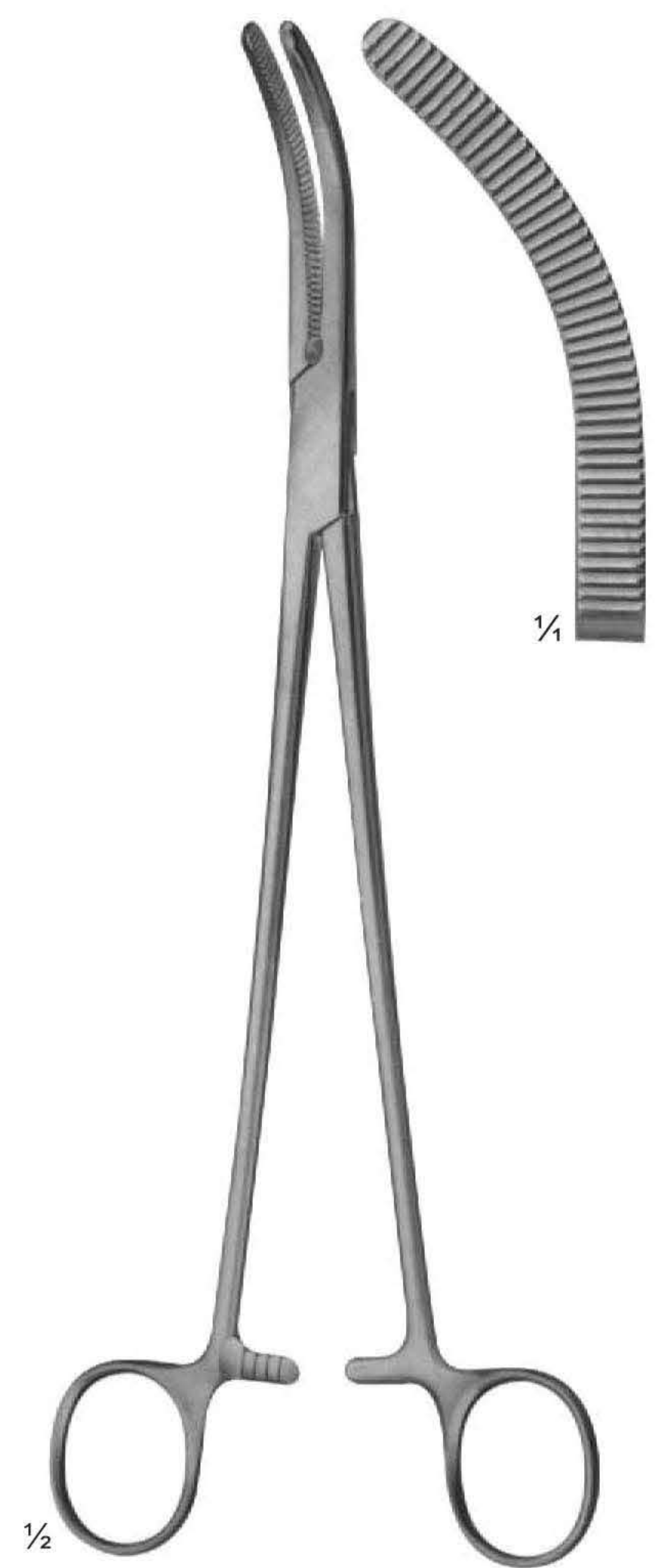

UG-1097
WERTHEIM
225 mm

Kidney Elevating Forceps



UG-1101
COLLIN
285 mm

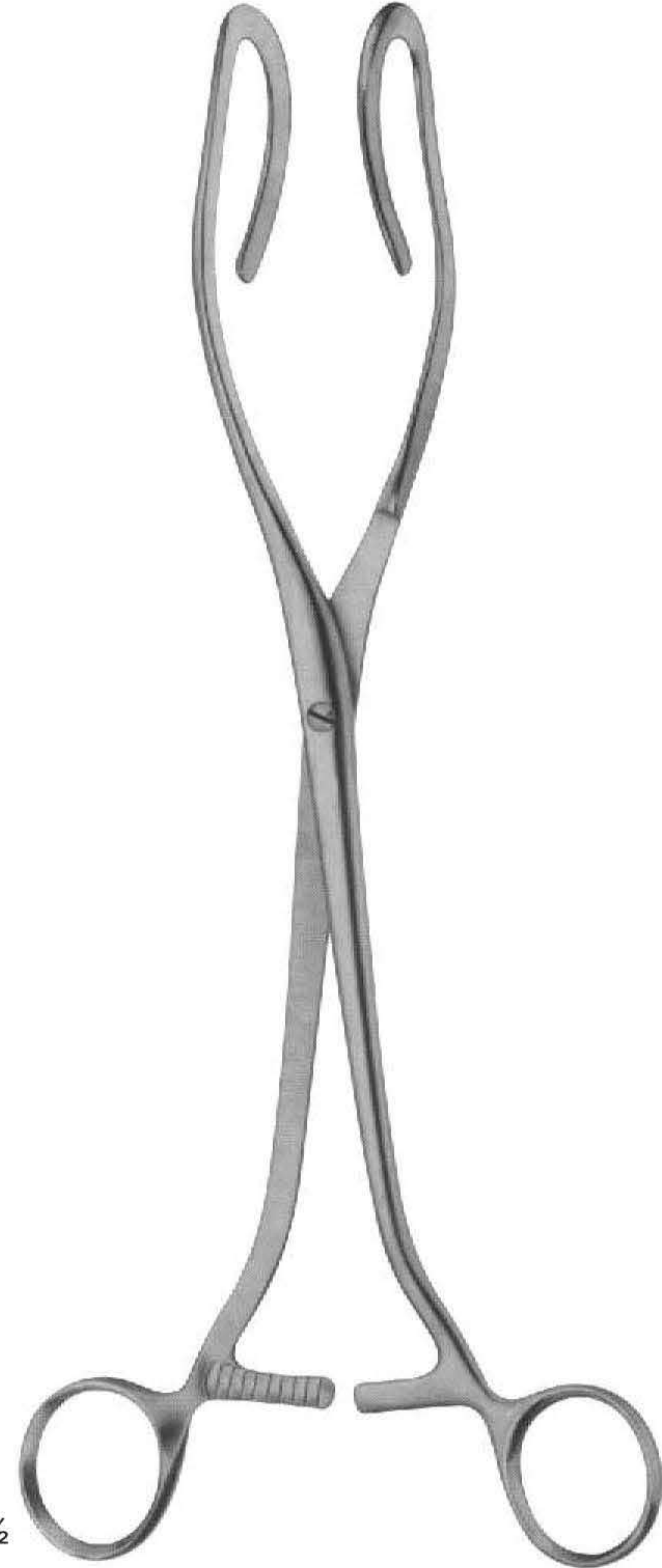

UG-1102
DARTIGUES
255 mm

Kidney Stone Forceps



UG-1105
RANDALL
225 mm

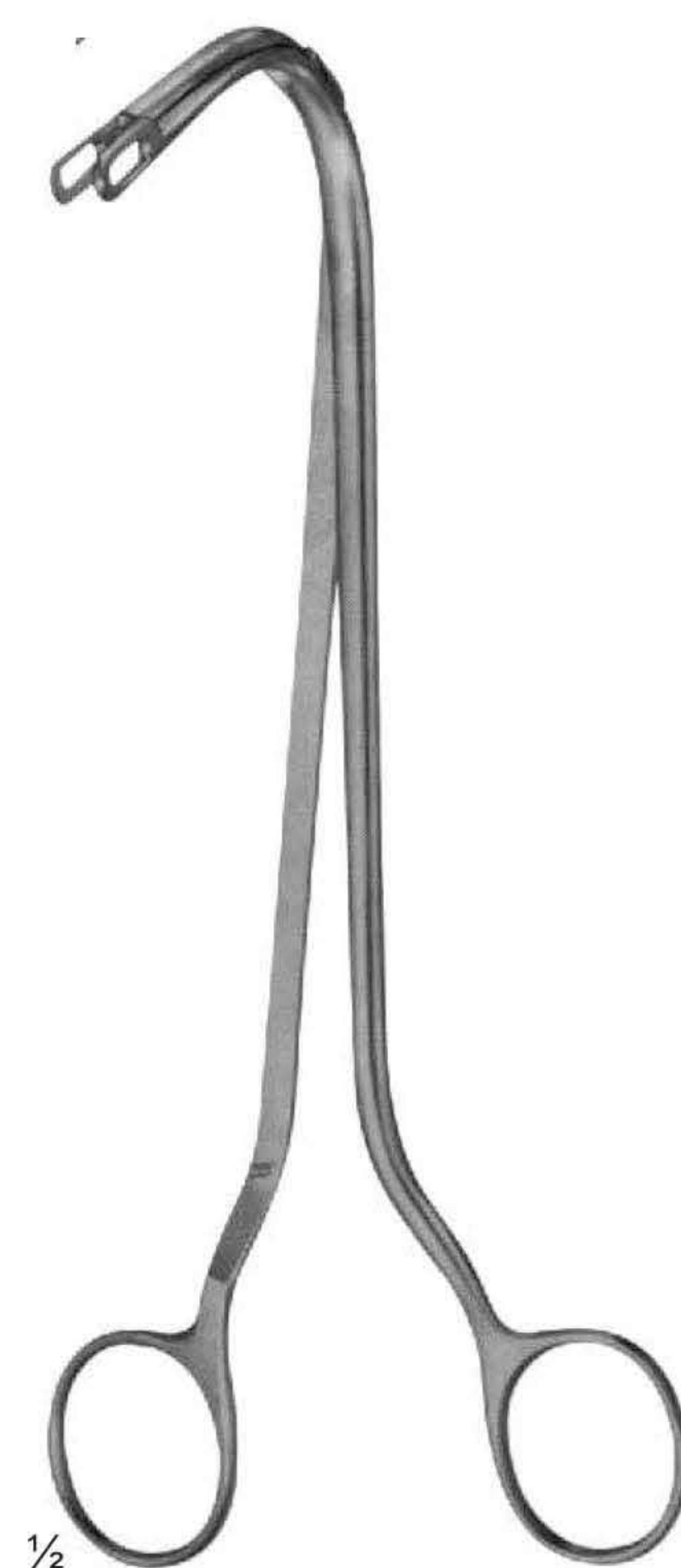

UG-1106
RANDALL
190 mm

Bladder Retractors

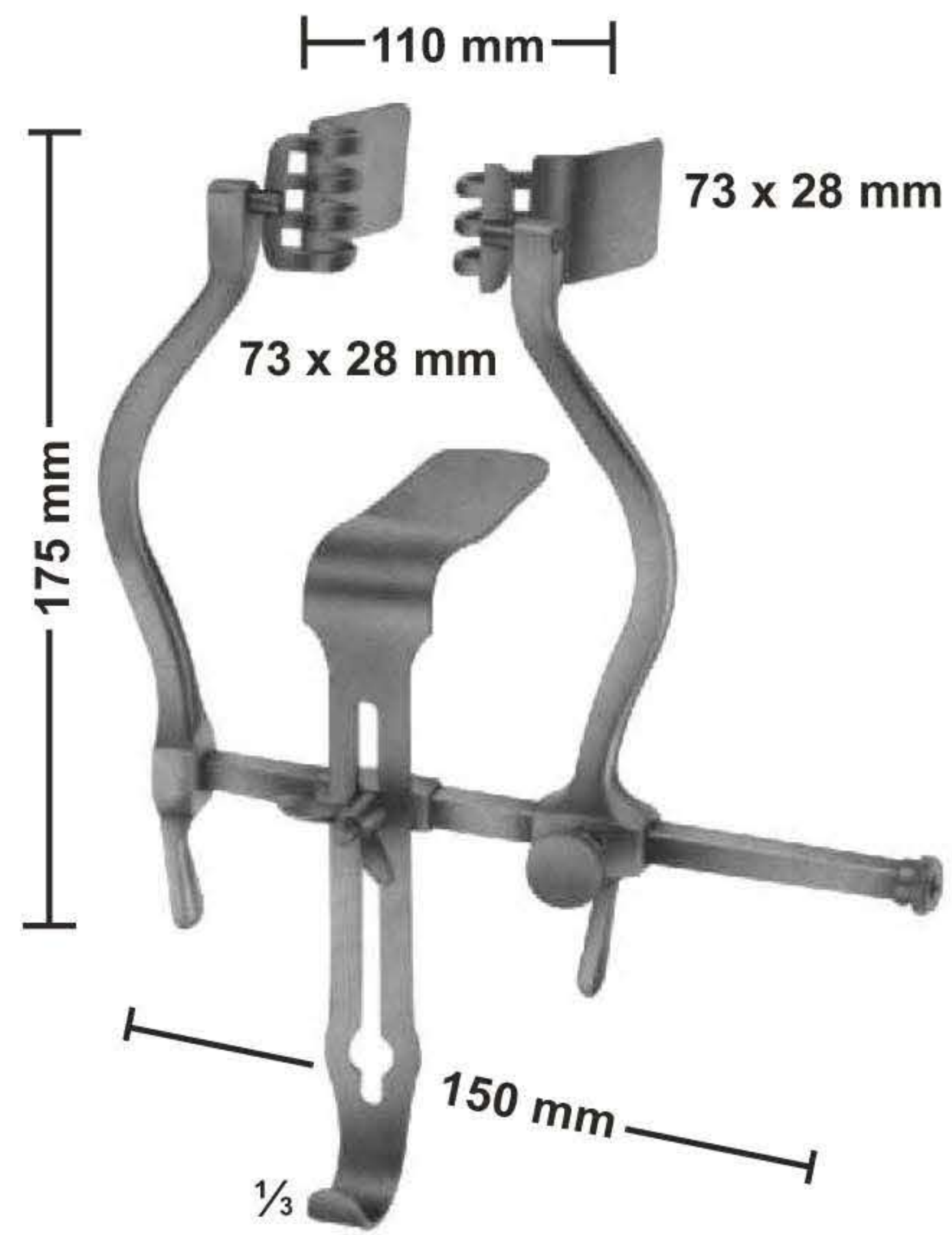

UG-1108
JUDD-MASSON
Bladder-and suprapubic
retractor



UG-1109
MILLIN
Bladder retractor
105X45 mm



UG-1111
LEGUEU
Bladder retractor
Center blade
80 x 31 mm

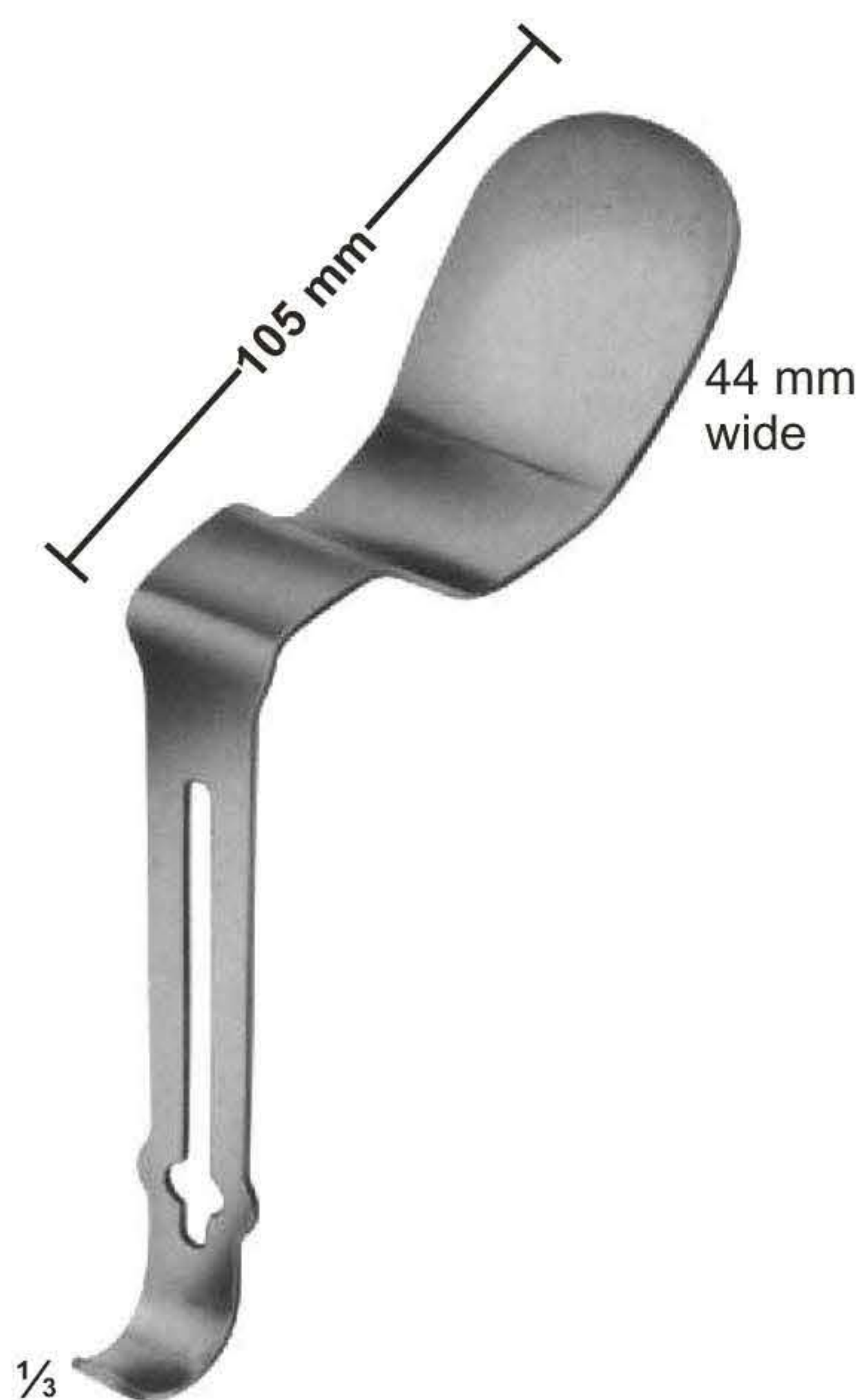

UG-1112
MILLIN
Center bladder for
retro pubic prostatectomy

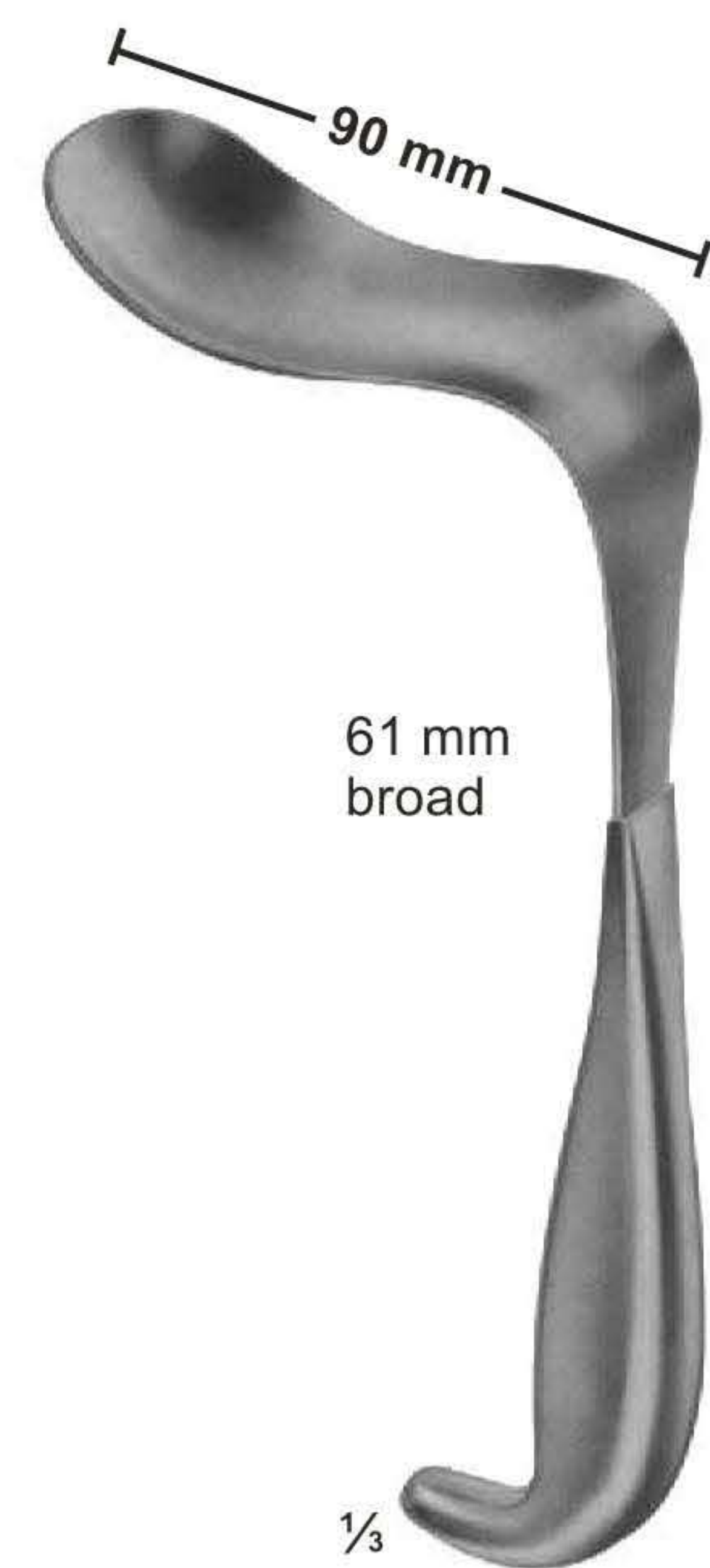

UG-1113
KOCHER
Bladder spatula
235 mm

Genito-Urinary Instruments-Prostatectomy



UG-1114
MATHIEU
Foreign body forceps
Length of shaft
190 mm

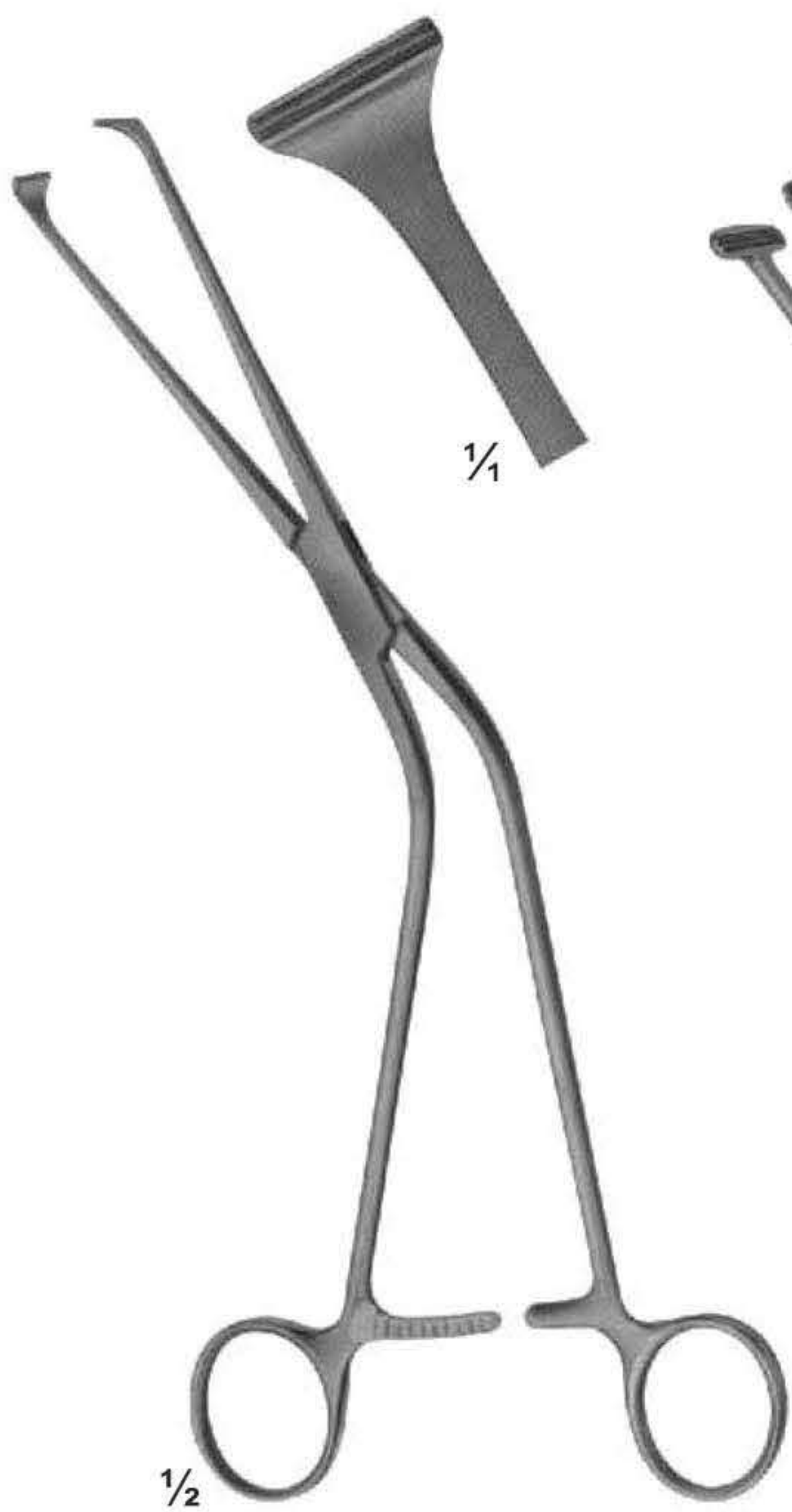

UG-1115
MILLIN
Lobe grasping
forceps
245 mm

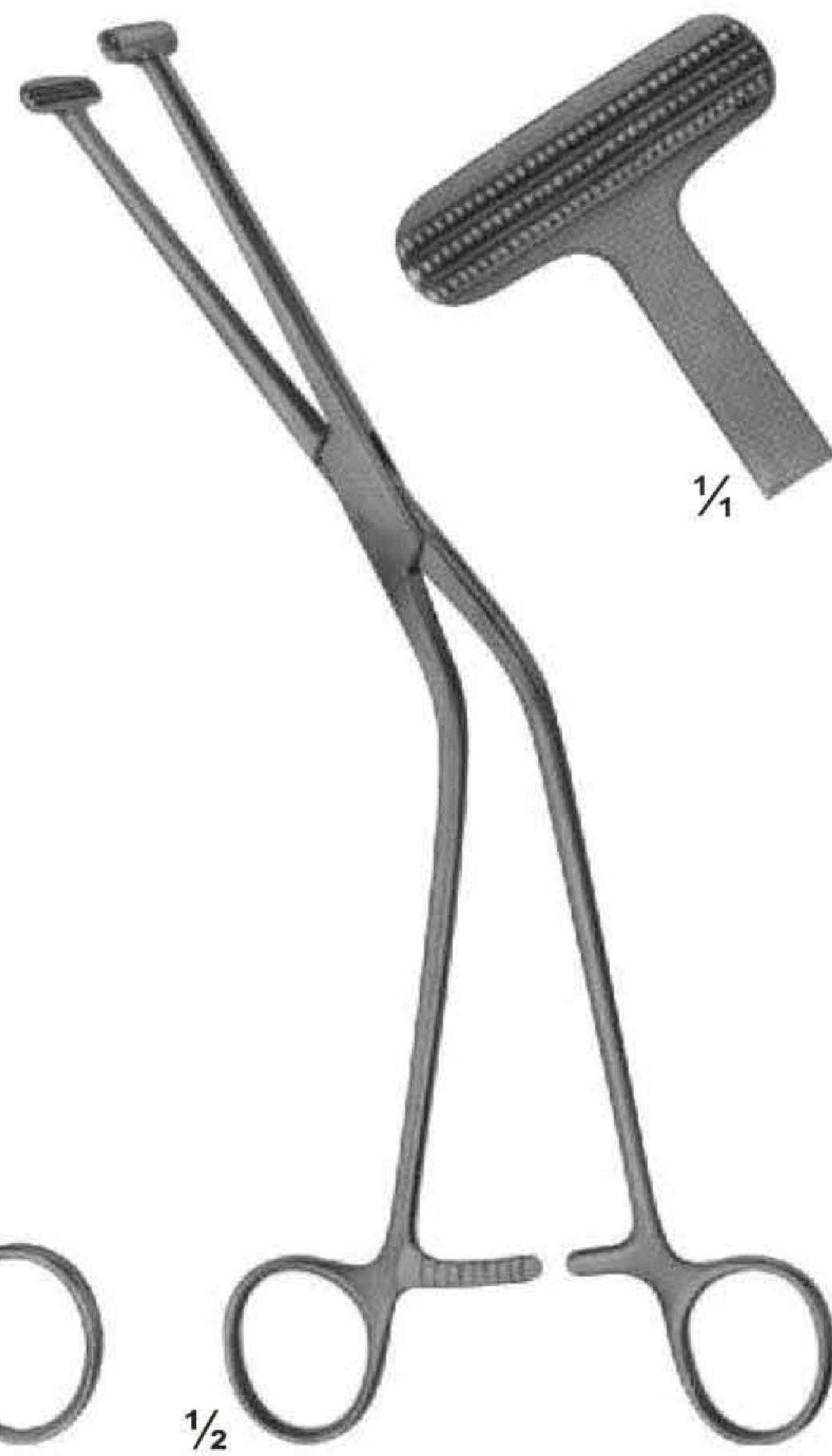

UG-1117
MILLIN
Lobe grasping
forceps
235 mm



UG-1118
MILLIN
Bladder neck spreader
285 mm

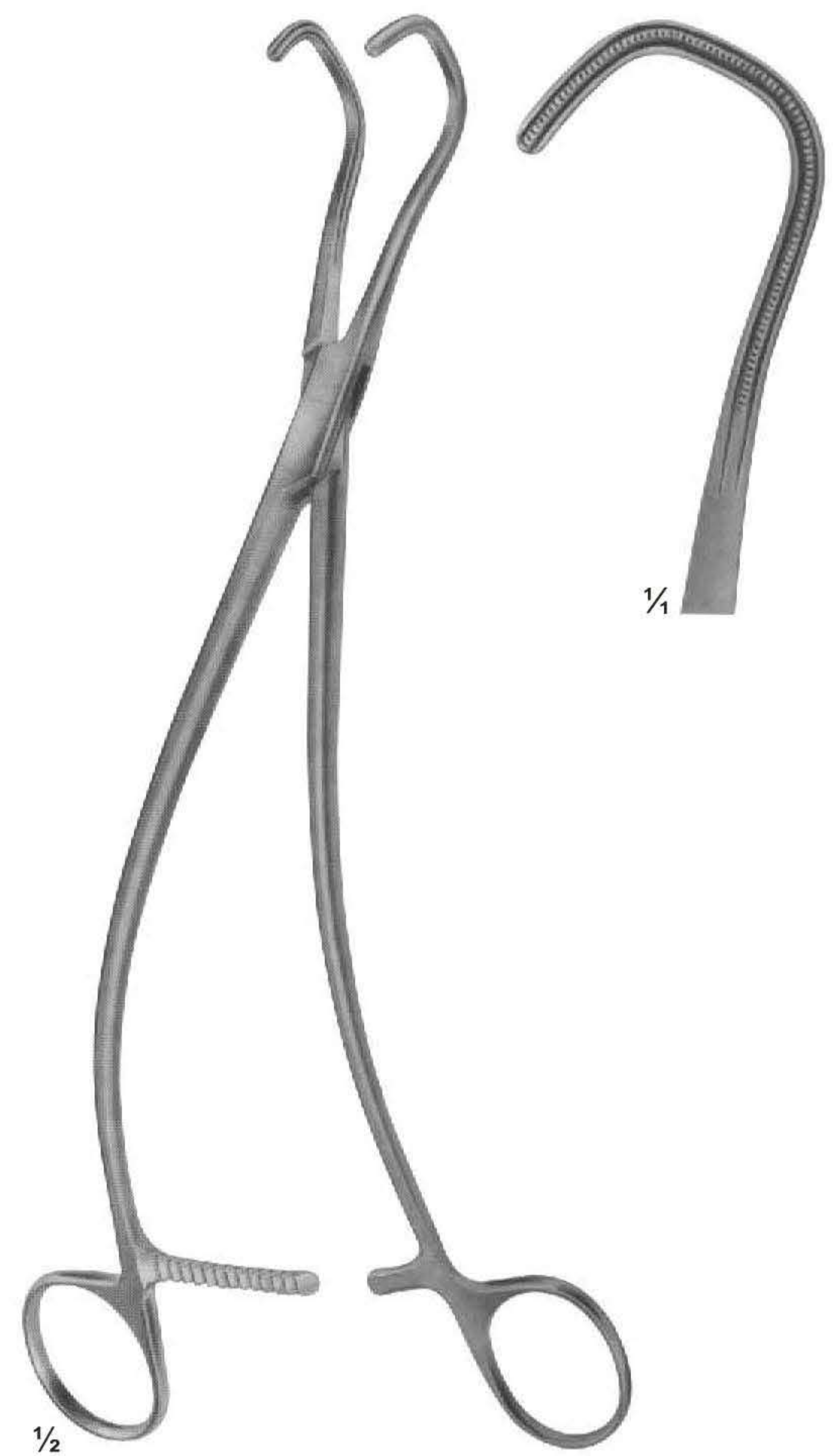

UG-1119
Ureter forceps
240 mm

Trocars

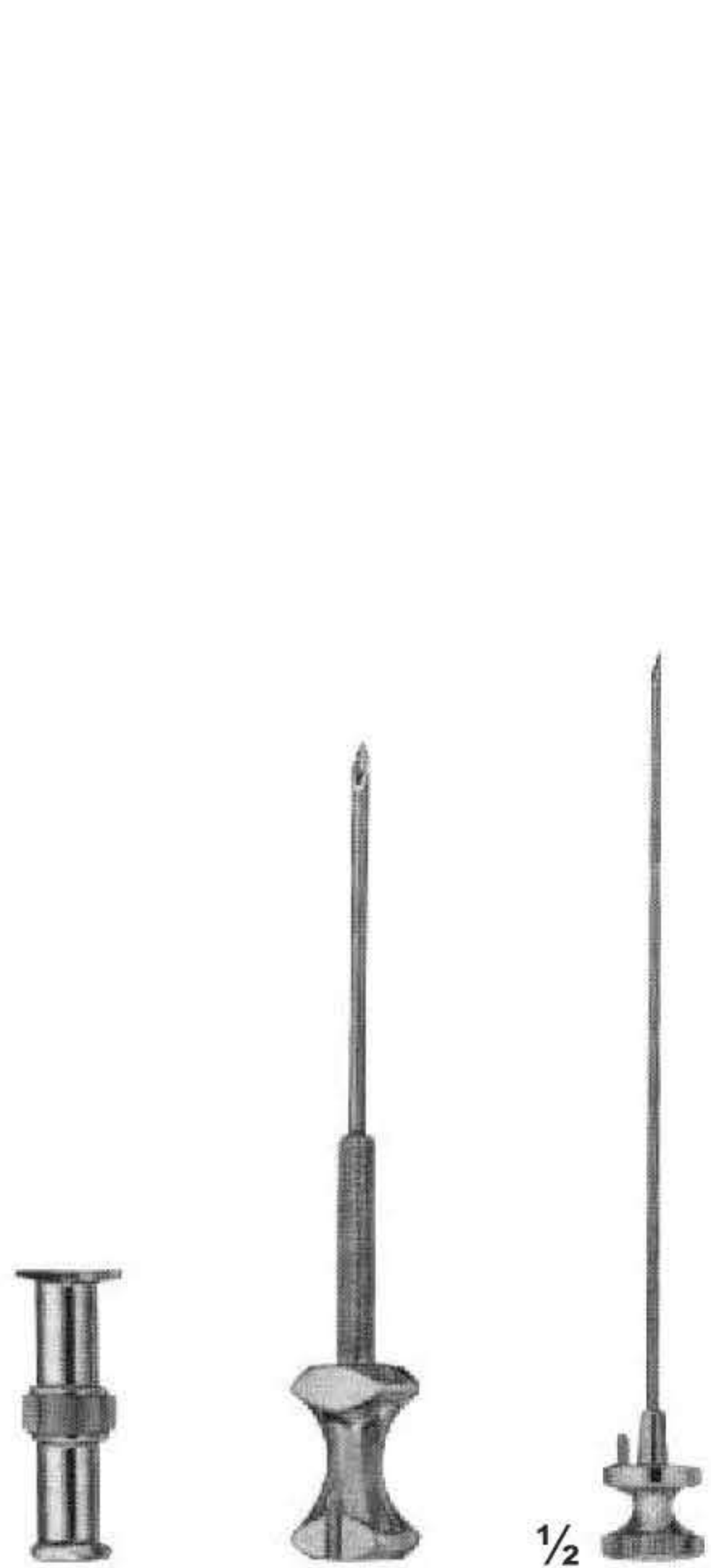

UG-116
KLIMA ROSEGGER
35 X 1,8 mm
Sternal puncture needle



UG-1168
Universal trocar
with 4 tips

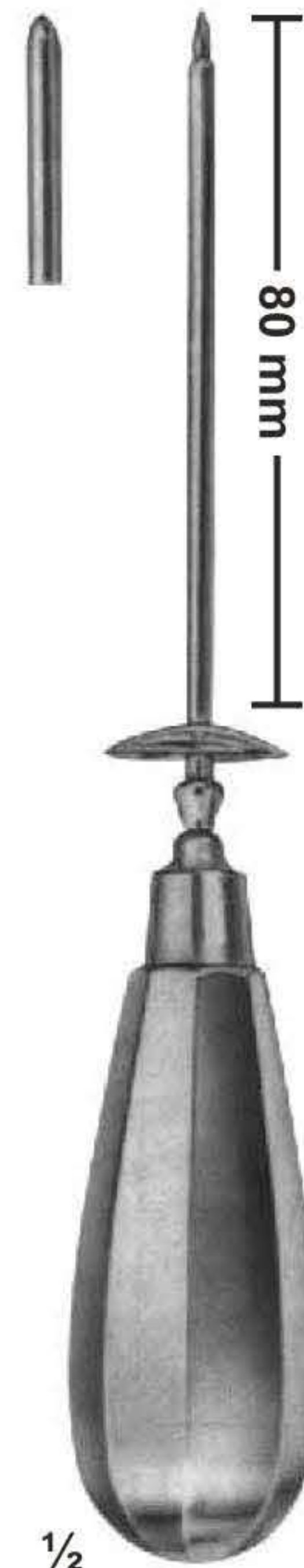

UG-1170
Inside dime. Outside dime
2,2 mm 3,0 mm
3,0 mm 4,0 mm
4,0 mm 5,0 mm
5,0 mm 6,0 mm
5,5 mm 6,5 mm
for hydrocele and abdominal
puncture



UG-1173
Inside dime. Outside dime
2,2 mm 3,0 mm
3,0 mm 4,0 mm
4,0 mm 5,0 mm
5,0 mm 6,0 mm
for abdominal puncture,
with stop-cock and lateral
drain

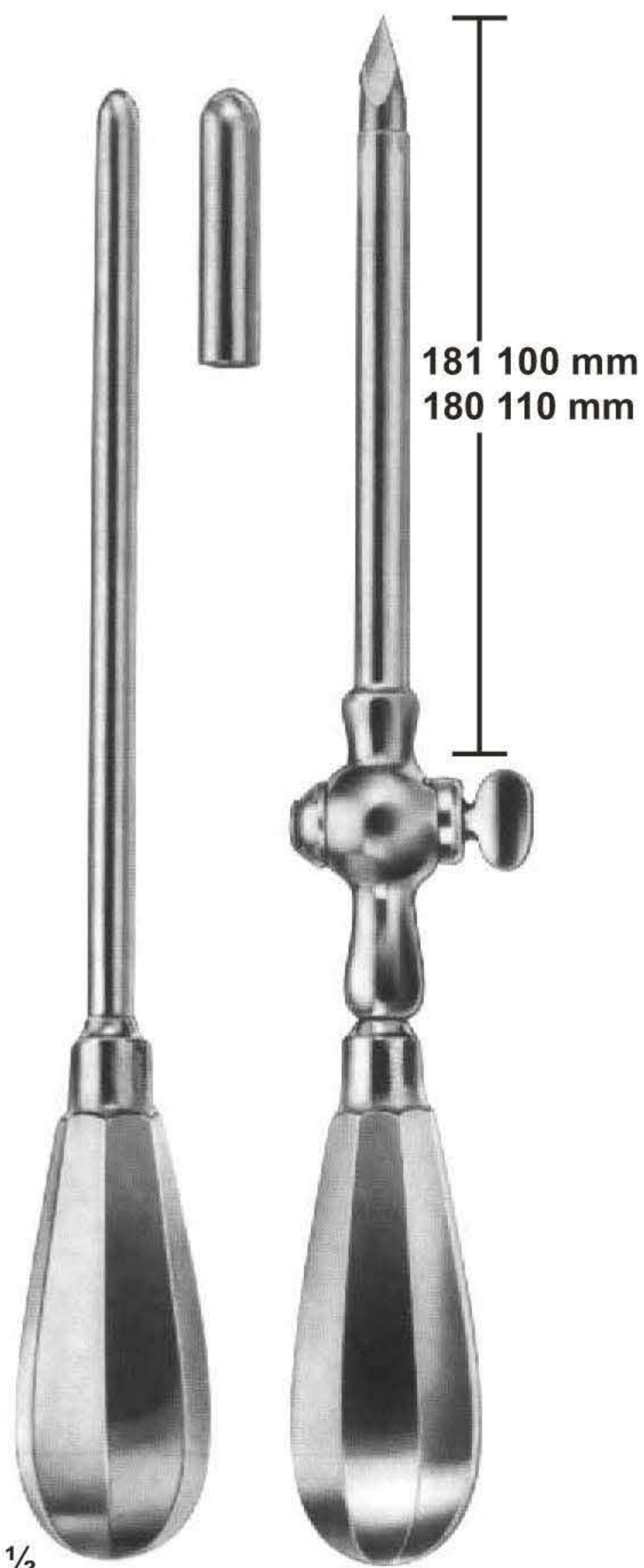

UG-1176
Inside dime. Outside dime
6,5 mm 8,0 mm
9,0 mm 10,0 mm
Empyema trocar

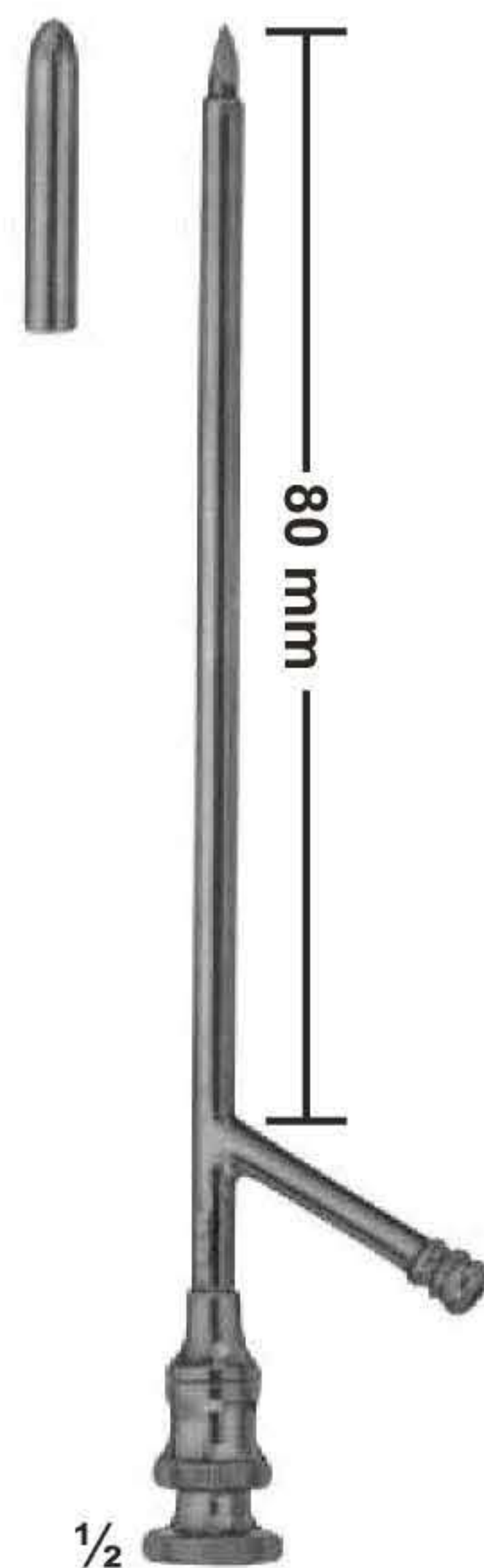

UG-1177
Inside dime. Outside dime
3,0 mm 4,0 mm
3,6 mm 4,6 mm
4,3 mm 5,3 mm
5,0 mm 6,0 mm
Gall bladder trocars



UG-1180
PIERCE
Antrum trocar
4,0 mm



UG-1181
COAKLEY
Antrum trocar
3,0 mm

Genito-Urinary Instruments & Circumcision Clamps



UG-1163
GUYON
Set of urethral bougies and dilating sounds,
in metal case, with lift out rack and bottom
rack, containing 21 urethral and dilating sounds.

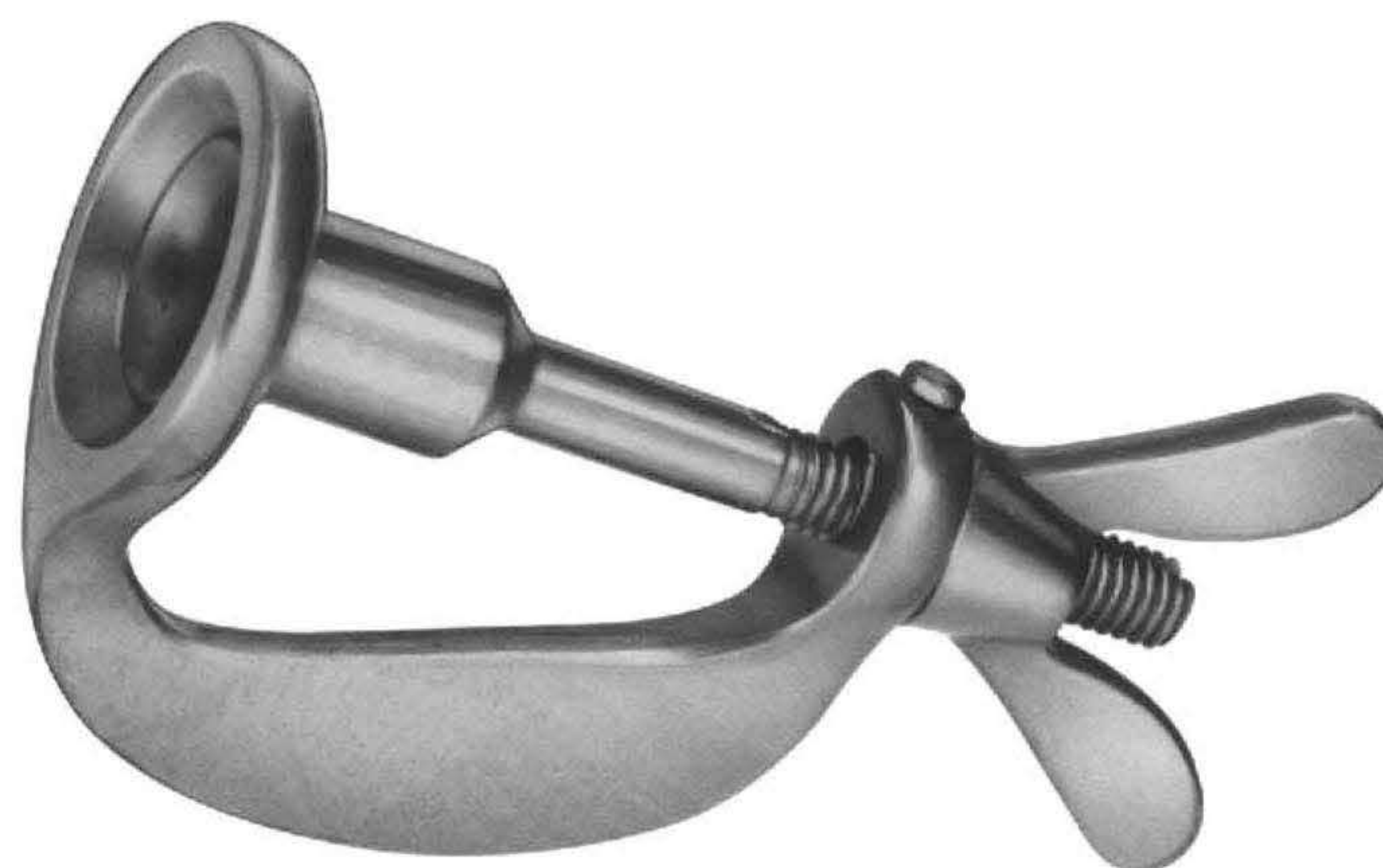

UG-1164
WINKELMANN
Circumcision Clamps
12 mm / 16 mm / 20 mm

Trocars

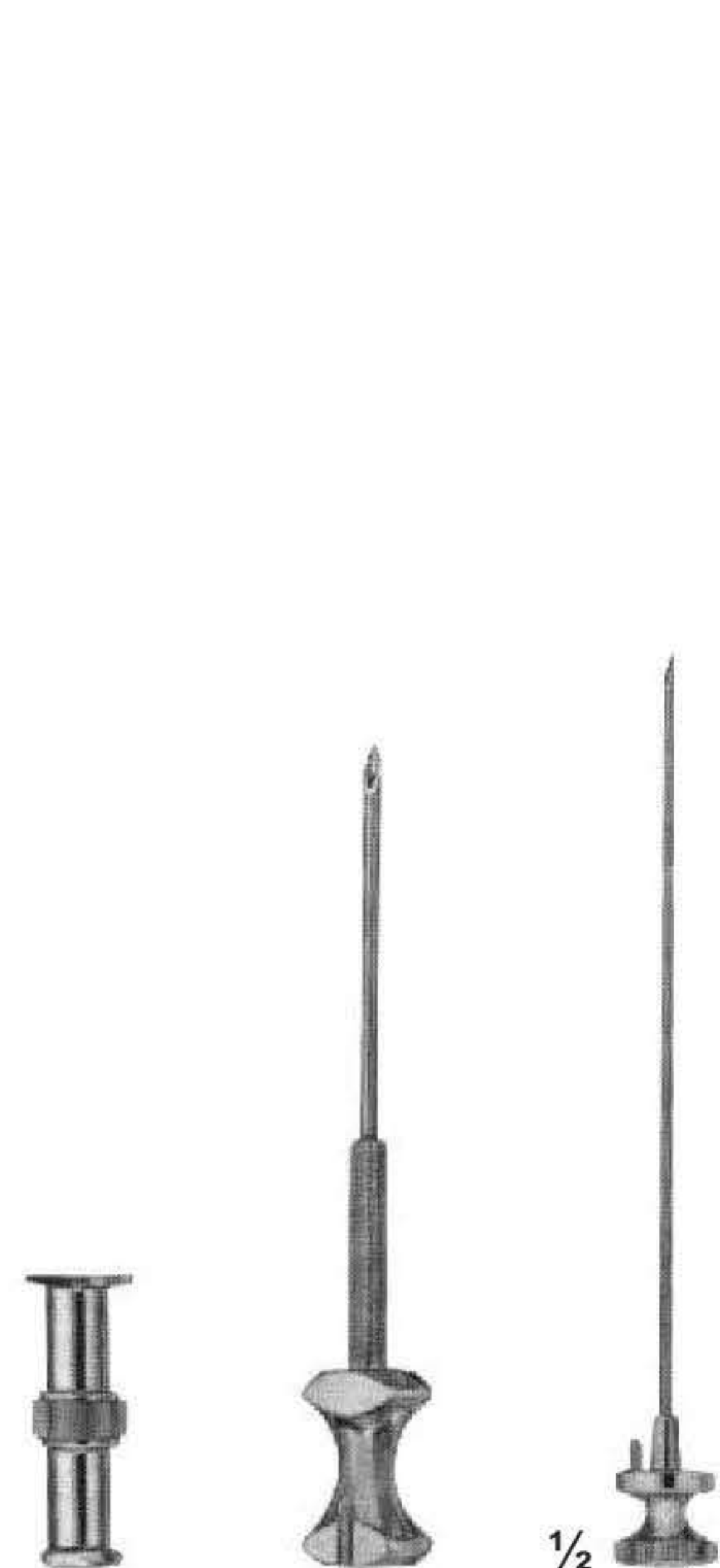

UG-116
KLIMA ROSEGGER
35 X 1,8 mm
Sternal puncture needle



UG-1168
Universal trocar
with 4 tips



UG-1170
Inside dime. Outside dime
2,2 mm 3,0 mm
3,0 mm 4,0 mm
4,0 mm 5,0 mm
5,0 mm 6,0 mm
5,5 mm 6,5 mm
for hydrocele and abdominal
puncture



UG-1173
Inside dime. Outside dime
2,2 mm 3,0 mm
3,0 mm 4,0 mm
4,0 mm 5,0 mm
5,0 mm 6,0 mm
for abdominal puncture,
with stop-cock and lateral
drain

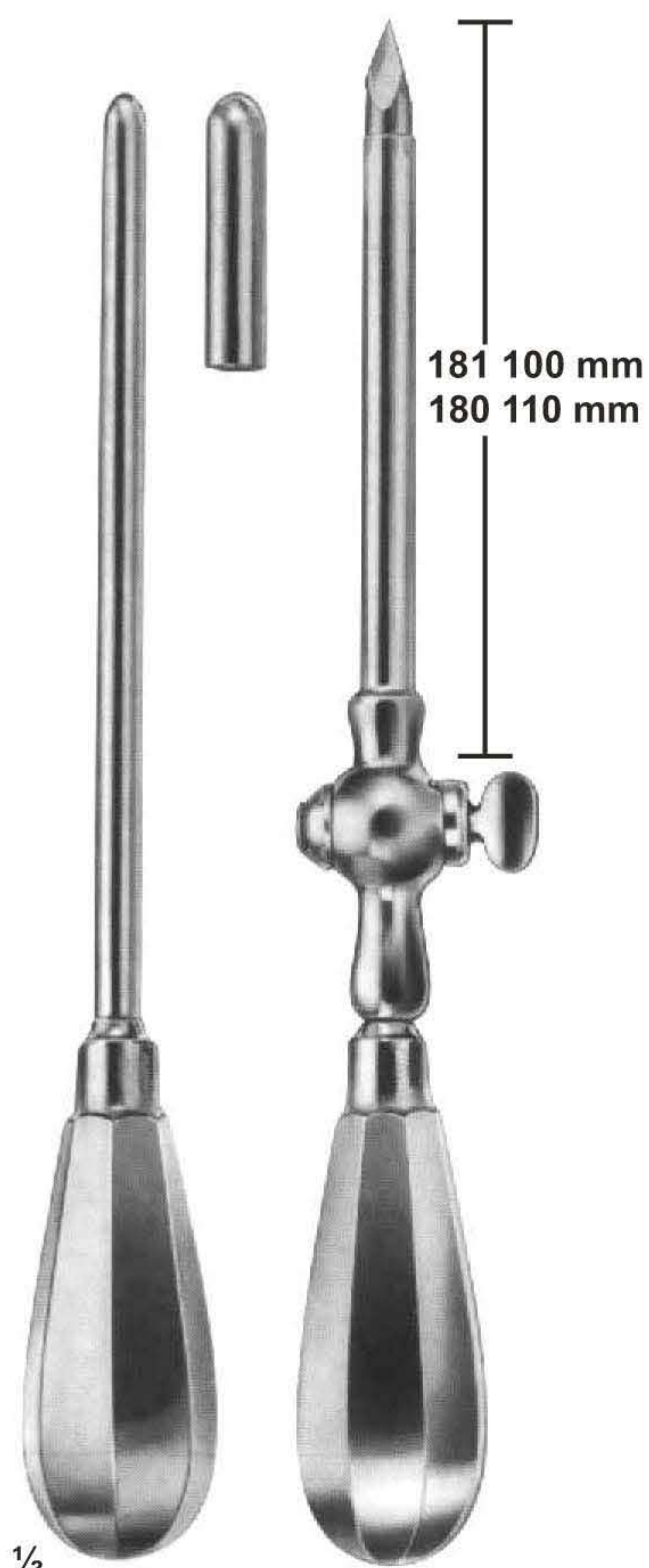

UG-1176
Inside dime. Outside dime
6,5 mm 8,0 mm
9,0 mm 10,0 mm
Empyema trocar

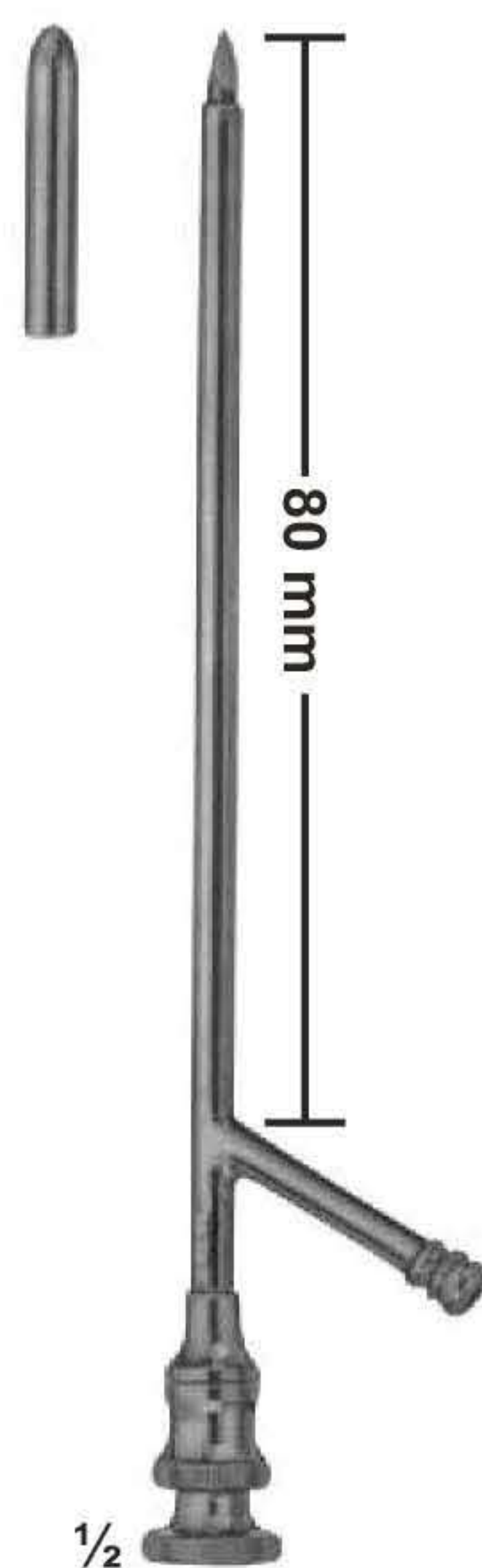

UG-1177
Inside dime. Outside dime
3,0 mm 4,0 mm
3,6 mm 4,6 mm
4,3 mm 5,3 mm
5,0 mm 6,0 mm
Gall bladder trocars



UG-1180
PIERCE
Antrum trocar
4,0 mm



UG-1181
COAKLEY
Antrum trocar
3,0 mm

Vaginal specula

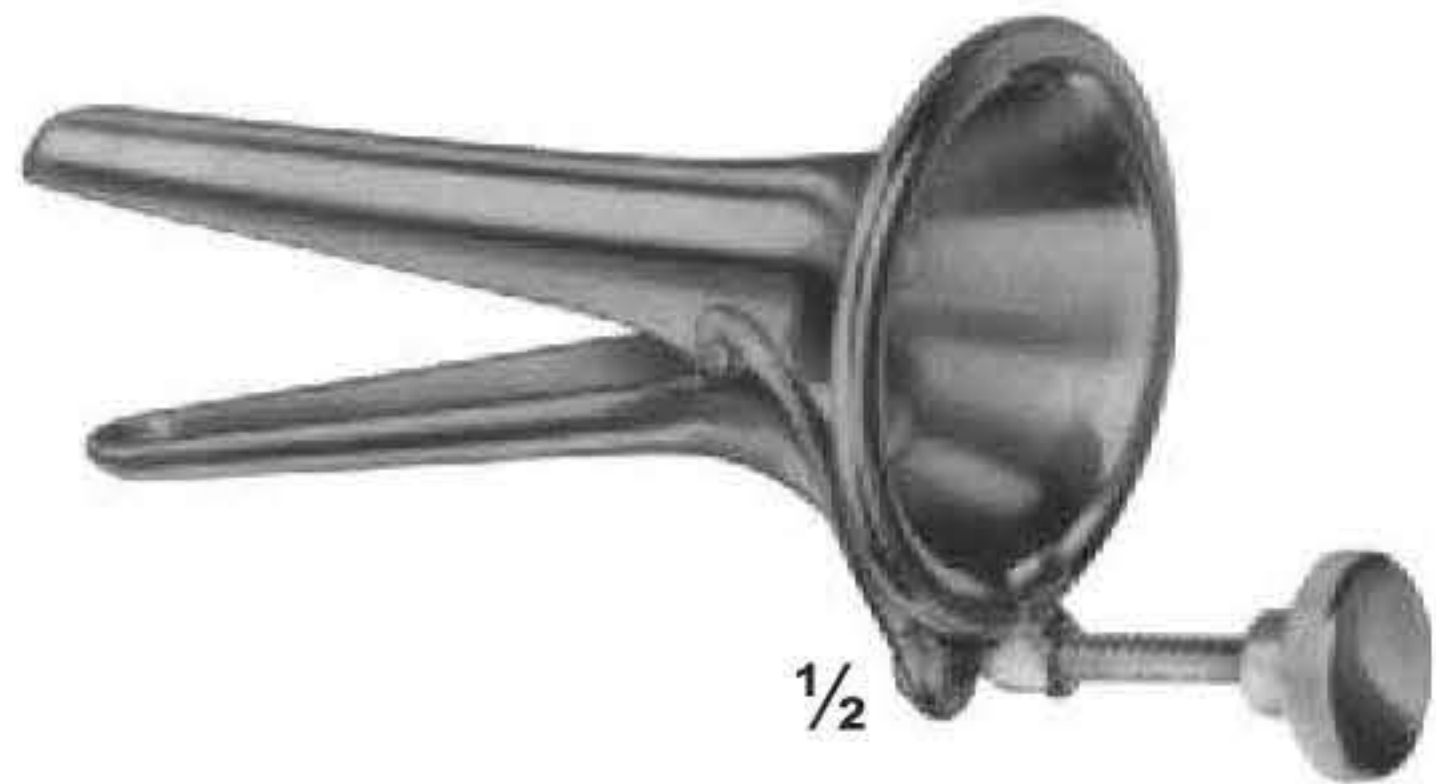

UG-835
COLLIN
for children
53 x 10 mm

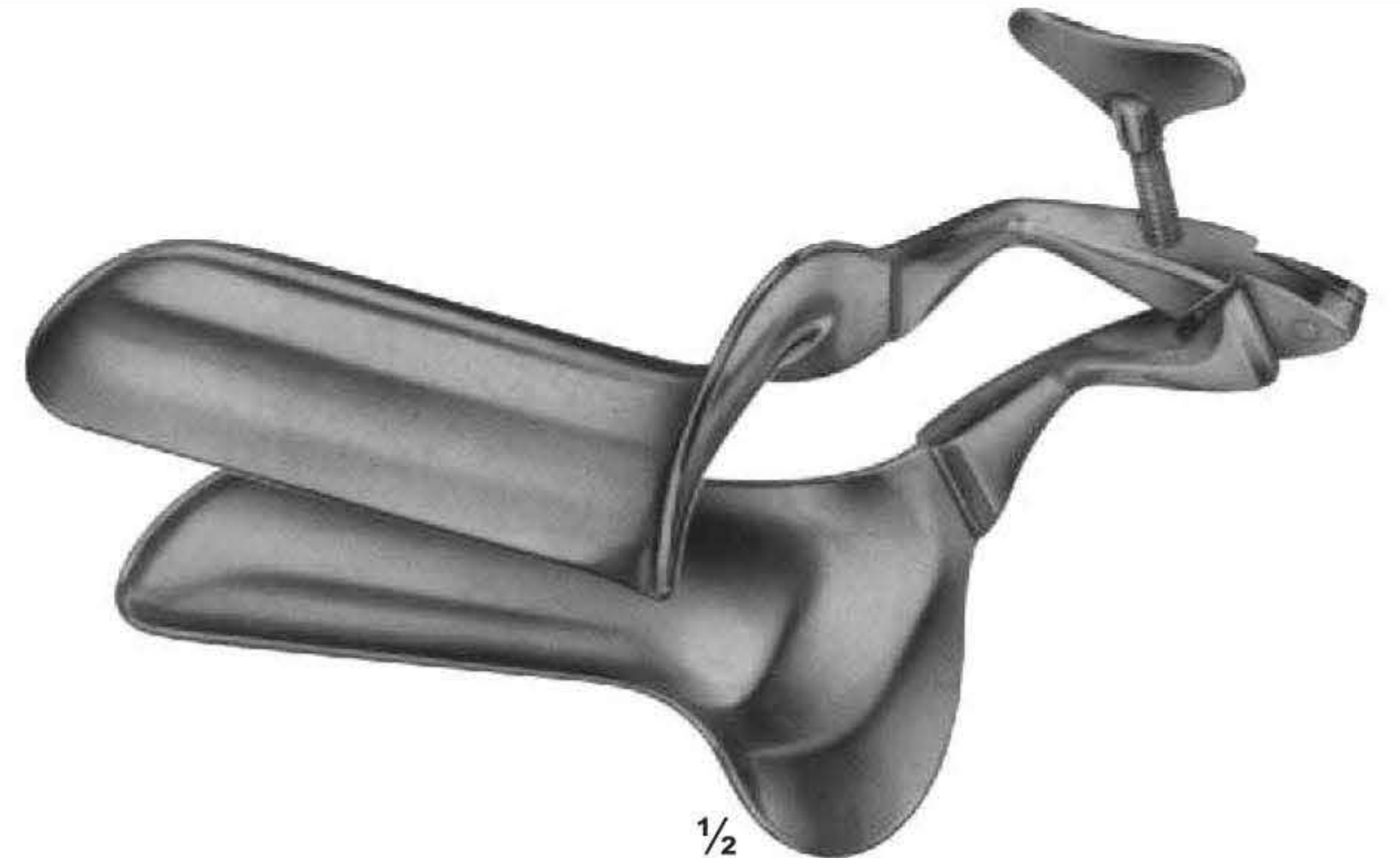

UG-837
COLLIN

100/90mm	28 mm
100/90mm	32 mm
105/95mm	35 mm
115/105mm	40 mm

Total length/working
length width

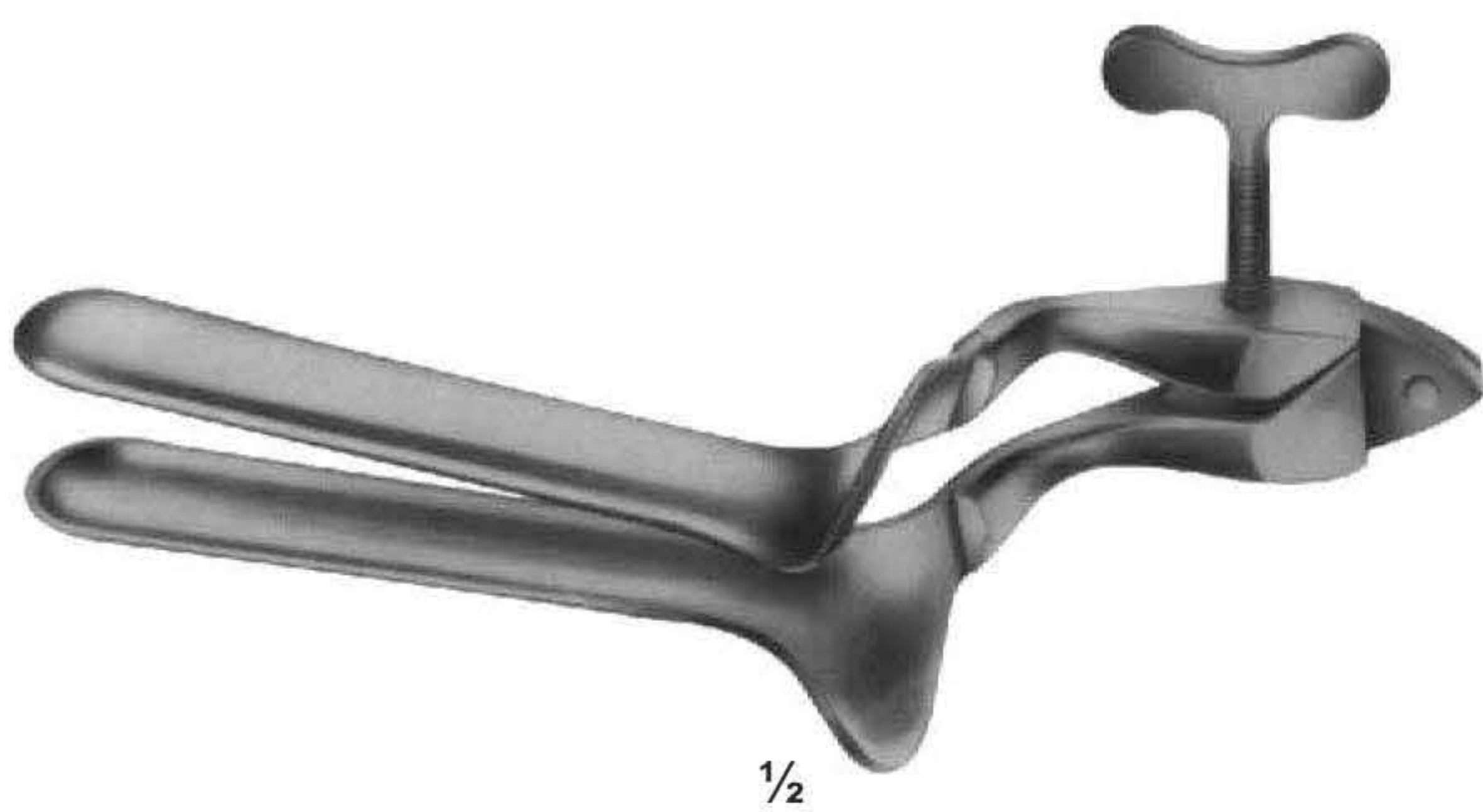

UG-843
COLLIN
for virgins
95/85 x 18 mm



UG-846
CUSCO
for virgins
75 x 17 mm



UG-847
CUSCO
for virgins
75 x 17 mm



UG-849
CUSCO

92X23-25 mm
100x25-27 mm
110x27-30 mm

Vaginal Specula



1/2

UG-851
CUSCO
STANDARD
80X24 mm
80X32 mm
90X36 mm
110X37 mm

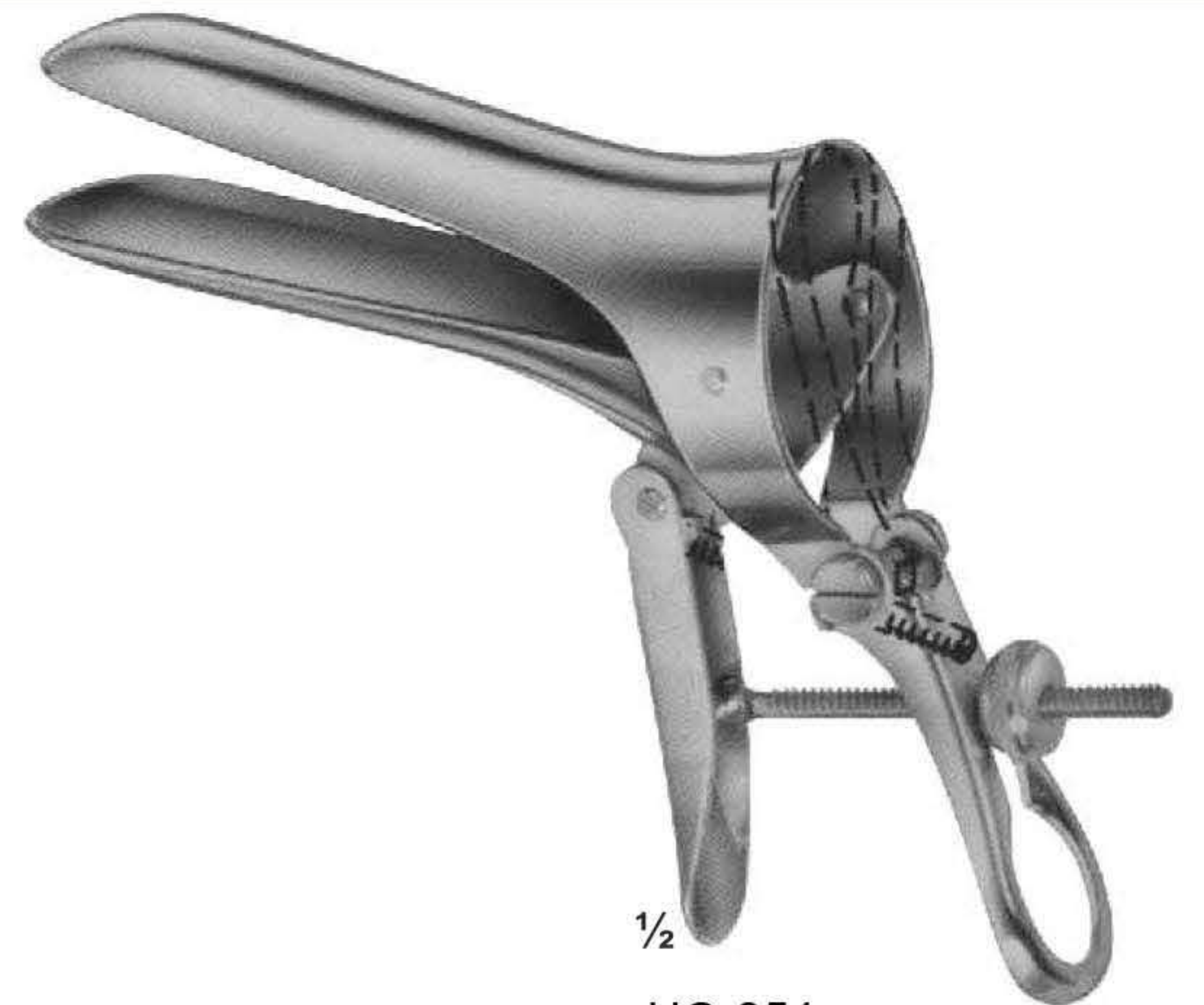

1/2

UG-854
CUSCO
80X24 mm
80X32 mm
90X36 mm
110X37 mm



1/2

UG-858
CUSCO
80X24 mm
80X32 mm
115X36 mm



1/2

UG-863
SEYFFERT
100X24 mm
110X32 mm
230 mm



1/2

UG-864
SEMM
for children
and virgins
180 mm

Vaginal Specula, Sets, Upper & Lower Blades

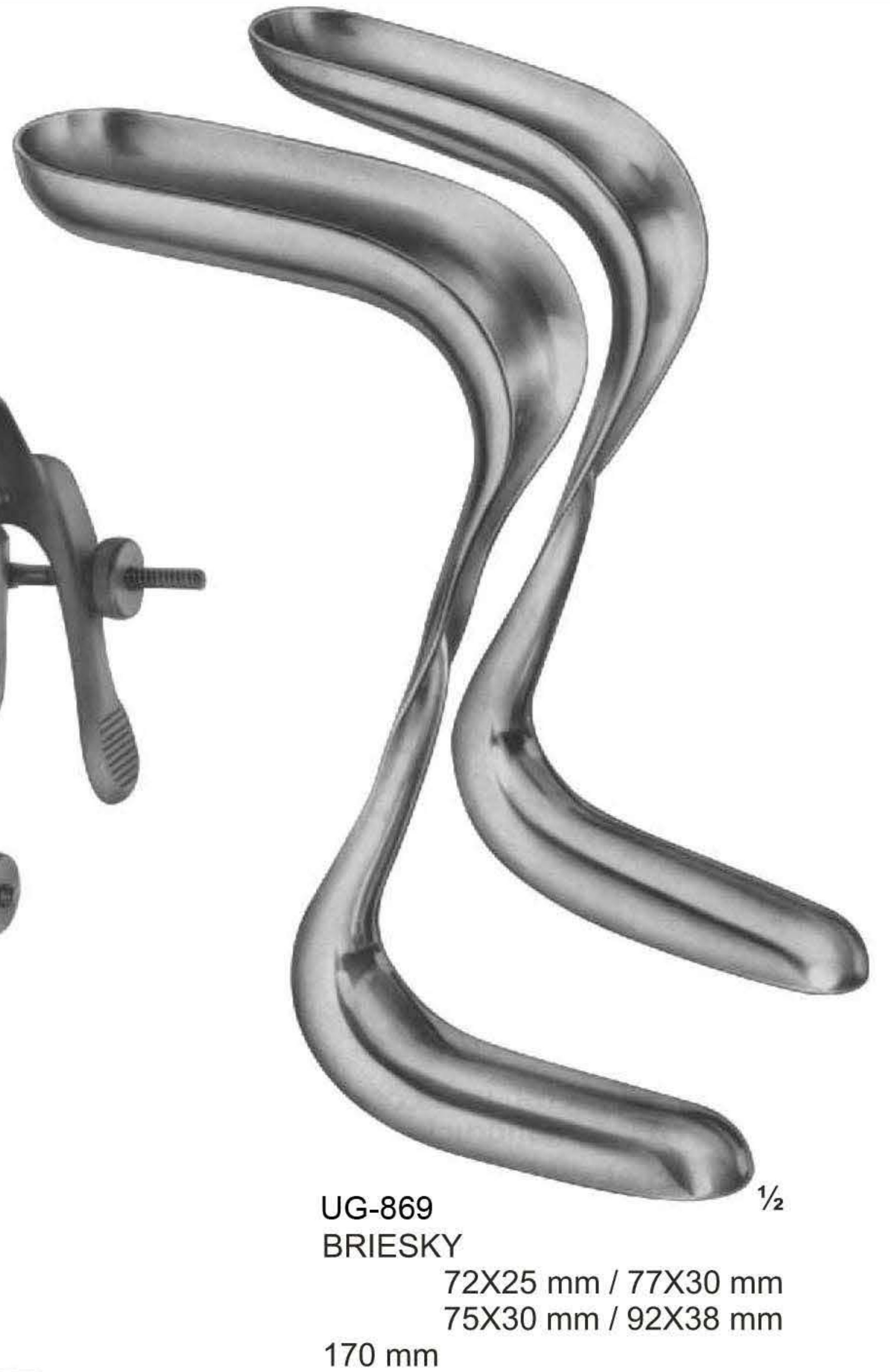

Vaginal Specula-Sets, upper and lower blades



UG-891
KRISTELLER
110X18 mm
110X20 mm
110X27 mm
110X30 mm
110X36 mm
220 mm



UG-892
KRISTELLER
Upper blades



UG-894
KRISTELLER
Lower blades

Vaginal Specula-upper and lower blades



UG-899
KRISTELLER
Upper blades



UG-901
KRISTELLER
Lower blades

Vaginal Specula



1/2

UG-903
KRISTELLER
205 mm



1/2

UG-905
JACKSON
175 mm

Vaginal Specula-for children & virgins / Vario Retractor



56 x 13 mm

1/2

UG-910
BRAUN
180 mm

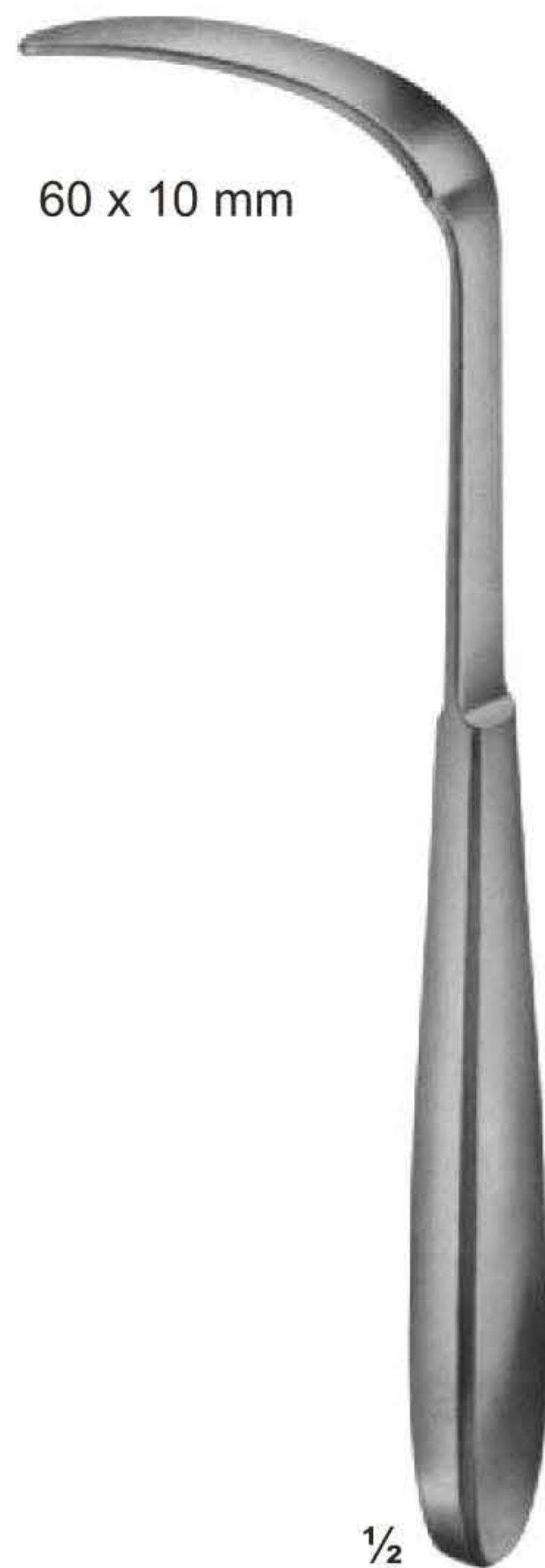

60 x 10 mm

1/2

UG-913
BRAUN
180 mm



95 x 17 - 30 mm

1/2

UG-915
MATHIEU
For children
and virgins
210 mm



95 x 17-26 mm

1/2

UG-919
MATHIEU
for children and
virgins fitting
210 mm



UG-920
Handle with cold light
carrier for upper blades
280 mm

1/2

Vaginal Specula-for children and virgins



1/2

UG-925
DOYEN
235 mm



1/4

1/2

UG-933

Length of blades
60 mm
90 mm
120 mm
160 mm

Width of blades
35 mm 45 mm 60 mm

Width of blades
35 mm 45 mm 60 mm

Vaginal Specula / Retractors



½

UG-941
BREISKY
WIENER MODELL/
VIENNA PATTERN
100 X 20 mm
100 X 25 mm
100 X 30 mm
100 X 35 mm
100 X 40 mm

300 mm



½

UG-943
BREISKY
WIENER MODELL/
VIENNA PATTERN
130 X 20 mm
130 X 25 mm
130 X 30 mm
130 X 35 mm
130 X 40 mm

320 mm



½

UG-948
WEISSBARTH
80 X 28 mm
85 X 42 mm
210 mm



½

UG-951
DOYEN
lateral speculum
80 x 30 mm
250 mm

Vaginal & Wound Retractor / Vaginal Specula



UG-953
SIMON
115 X 22 mm
275 mm



UG-955
AUVARD
65 X 38 mm - 28 mm
1,530 kg
with fixed weight
230 mm



UG-957
AUVARD
75 X 42 mm
(40 mm)
105 X 43 mm
(40 mm)
with detachable wight
230 mm



UG-959
MARTIN
with hook shaped
handle for hanging
in weights
270 mm

Vaginal Retractors



UG-975
JOLL (FRIEDMAN)
155 mm



UG-976
RICHTER
170 mm



UG-979
GELPI
135 mm



UG-982
GELPI
175 mm

Uterine Dilators



1/2

UG-707
HEGAR
with very conical point
185 mm



1/2

UG-711
HEGAR
205 mm

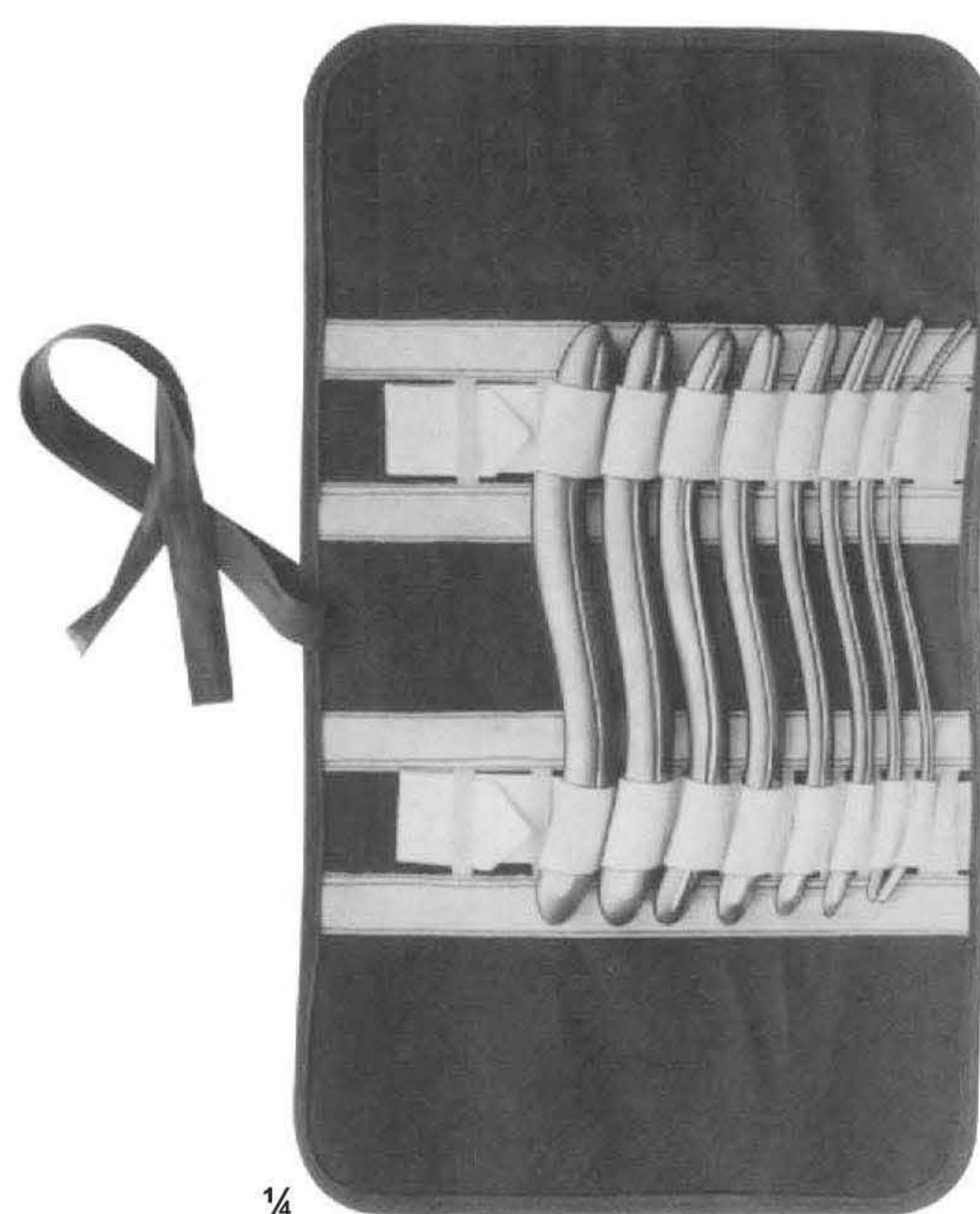

1/4

UG-714
HEGAR
Uterine dilator set, in canvas
roll with 8 dilators.

Uterine Dilators - Complete Sets



UG-723

HEGAR

Dilator set consisting of:

14 Dilators,

1 Rack for dilators (4 - 12 mm)

1 Rack for Dilators (13 - 17 mm)

1 Metal case only,

with hinged lid, stainless 200 X 100 X 35 mm

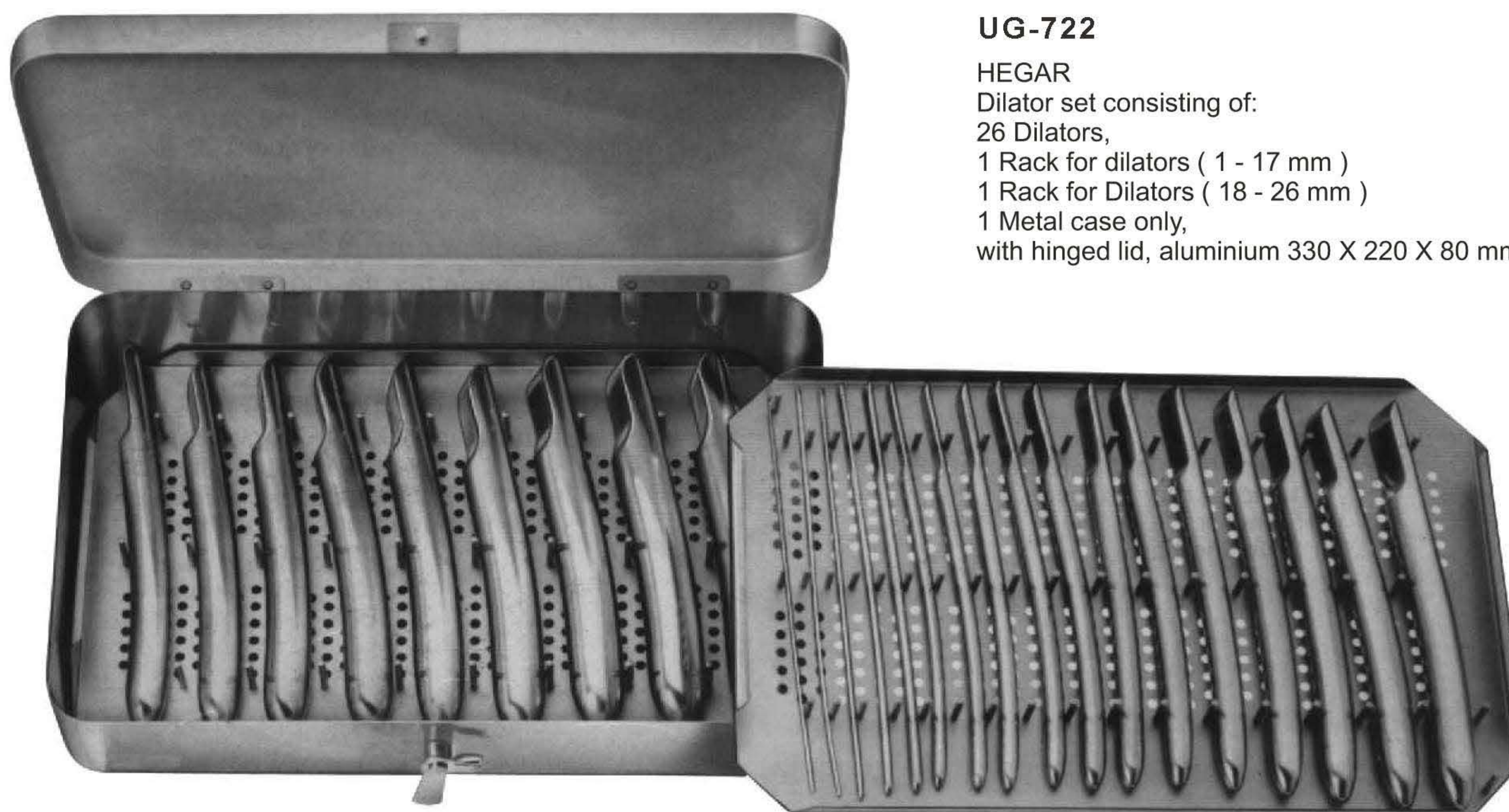

UG-722

HEGAR

Dilator set consisting of:

26 Dilators,

1 Rack for dilators (1 - 17 mm)

1 Rack for Dilators (18 - 26 mm)

1 Metal case only,

with hinged lid, aluminium 330 X 220 X 80 mm

Endospecula For Cervix

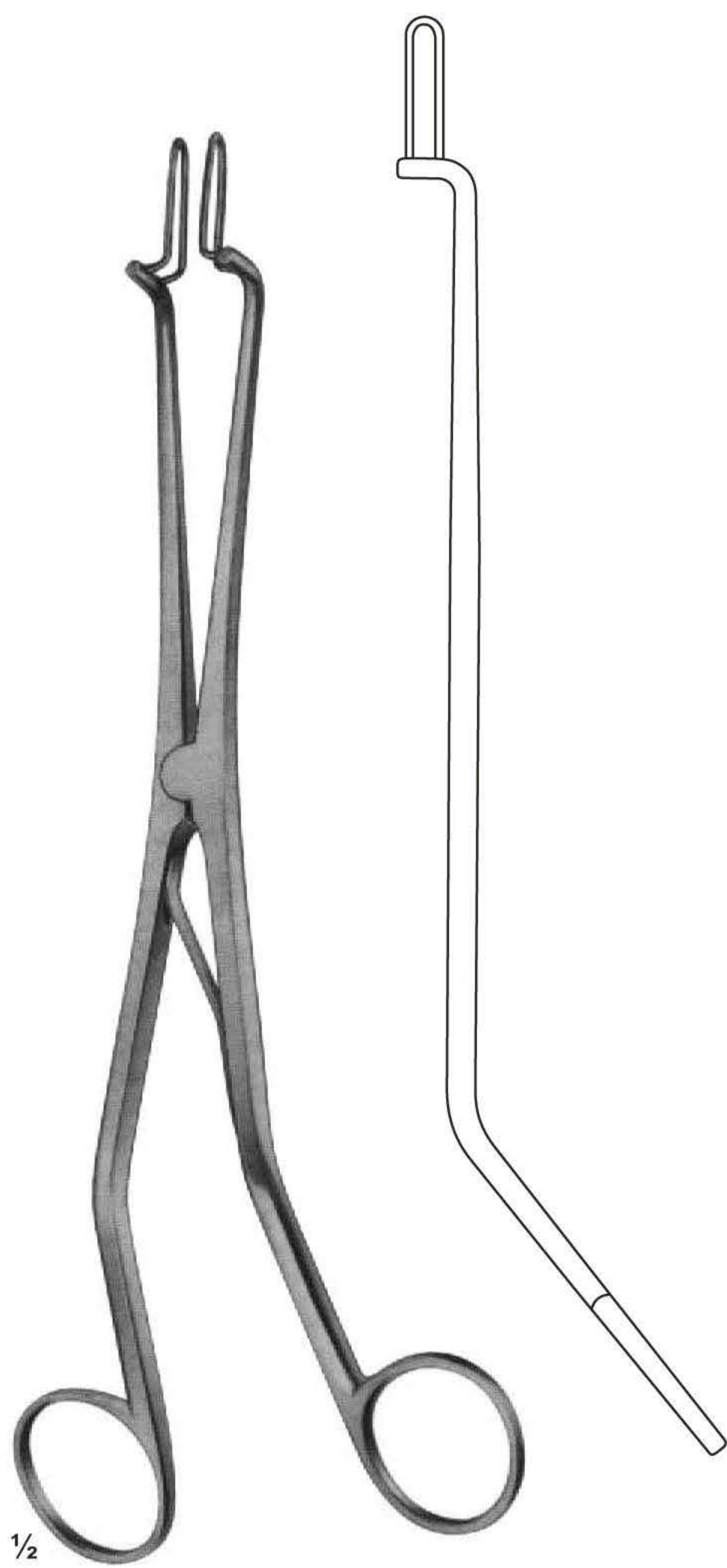

UG-725
KOGAN
Endospecula for cervix
and urethra, without ratchet
SIZE:185mm

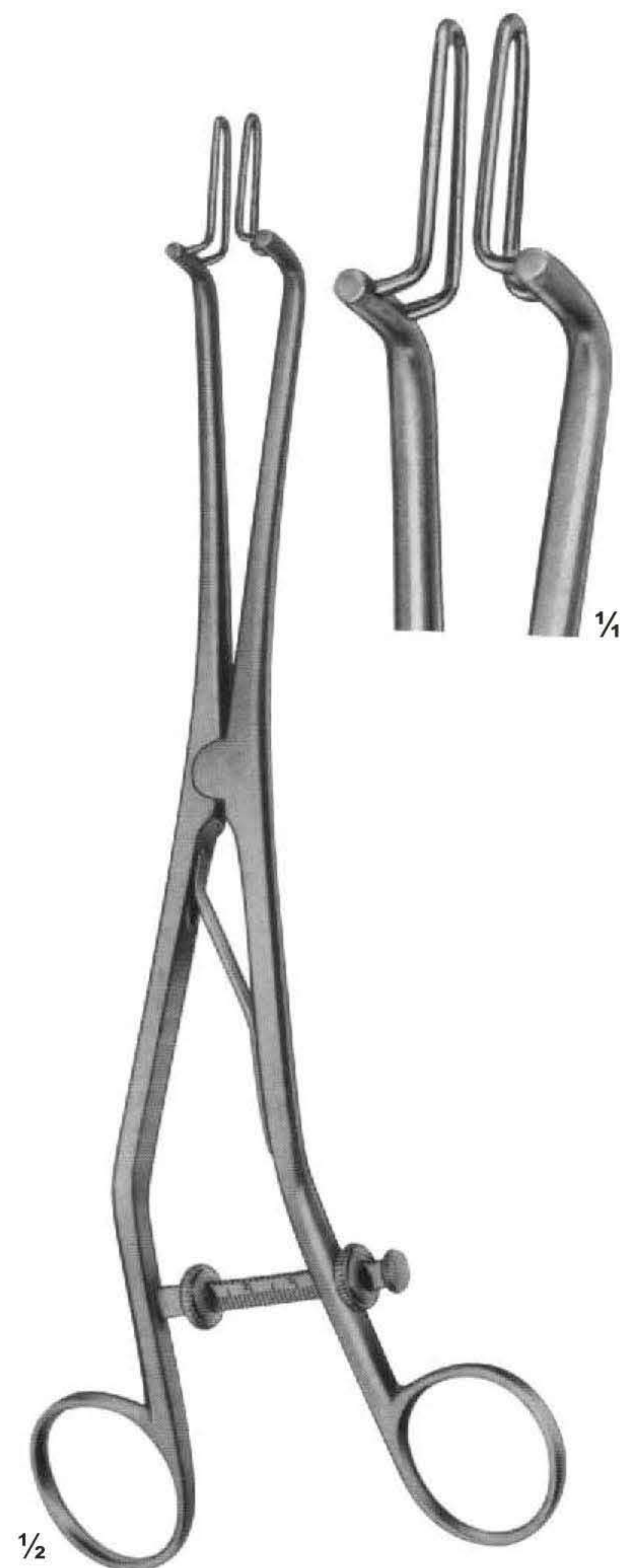

UG-726
KOGAN
Endospecula for cervix
and urethra, with
scale-ratchet and fixing screws
SIZE:205mm

Uterine Probes



UG-729
MAYO
biegsam malleable
330 mm



UG-730
SIMS
biegsam malleable
330 mm

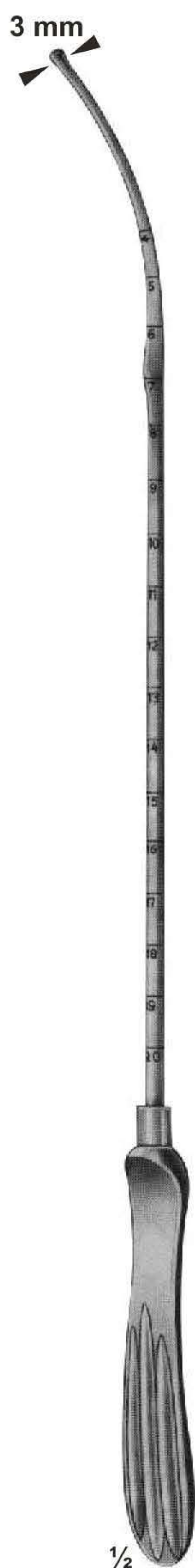

UG-731
MARTIN
330 mm



UG-733
SIMPSON
malleable
silver-plated
290 mm



UG-736
BRAUN
Uterine
depressor
270 mm



UG-739
Cotton
applicator
270 mm

Uterine Dressing Forceps



UG-744
PELKMAN
260 mm

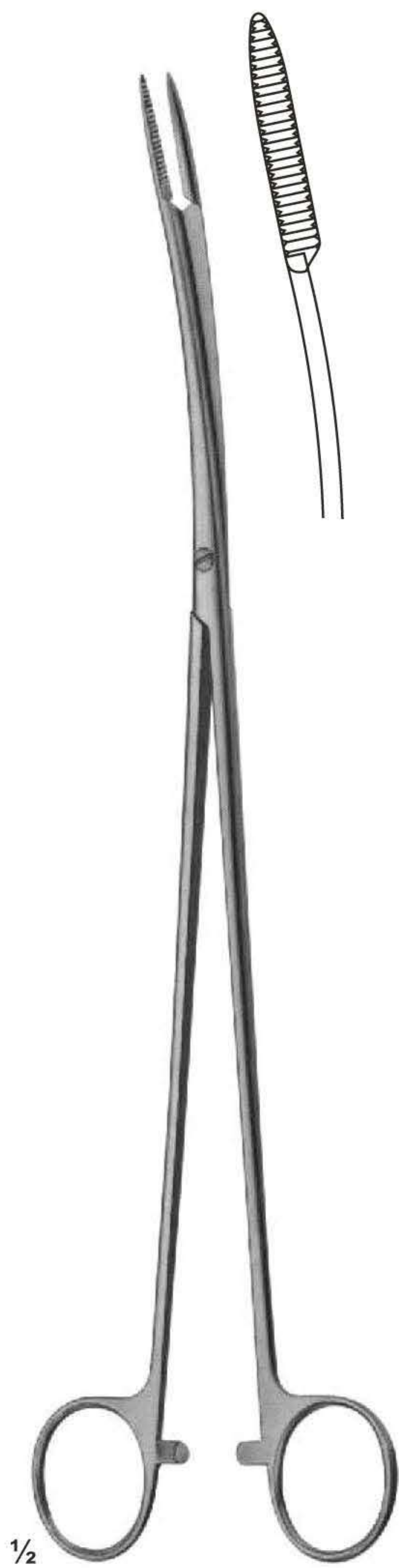

UG-745
PELKMAN
260 mm

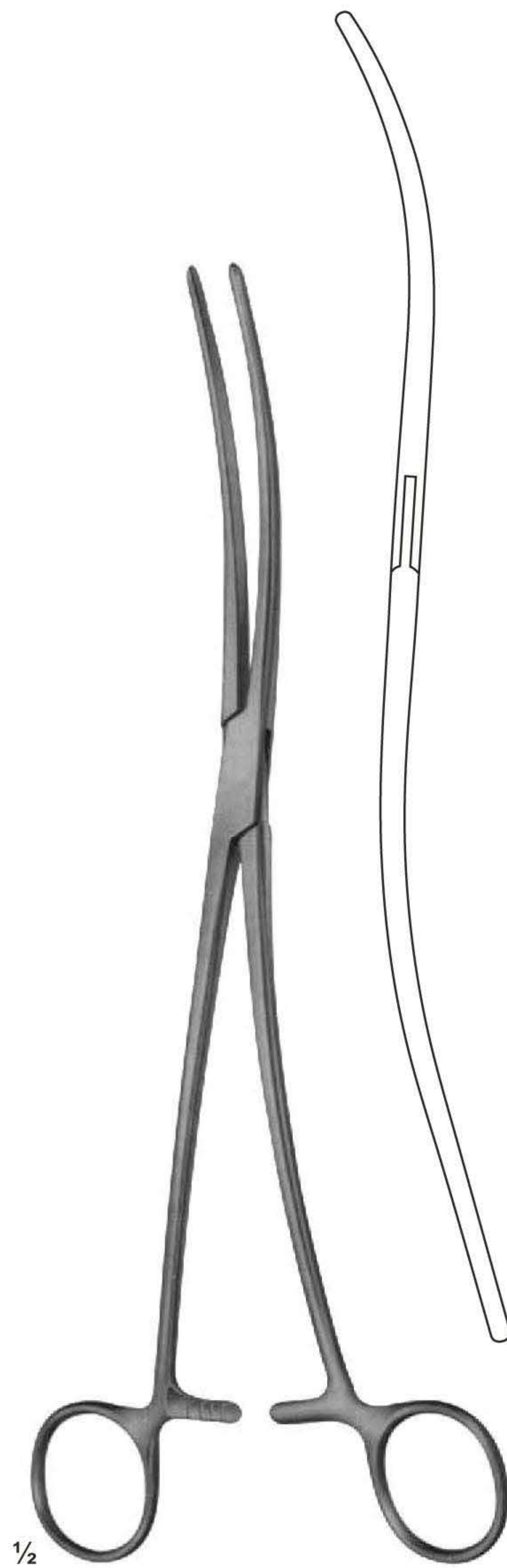

UG-747
BOZEMANN
250 mm

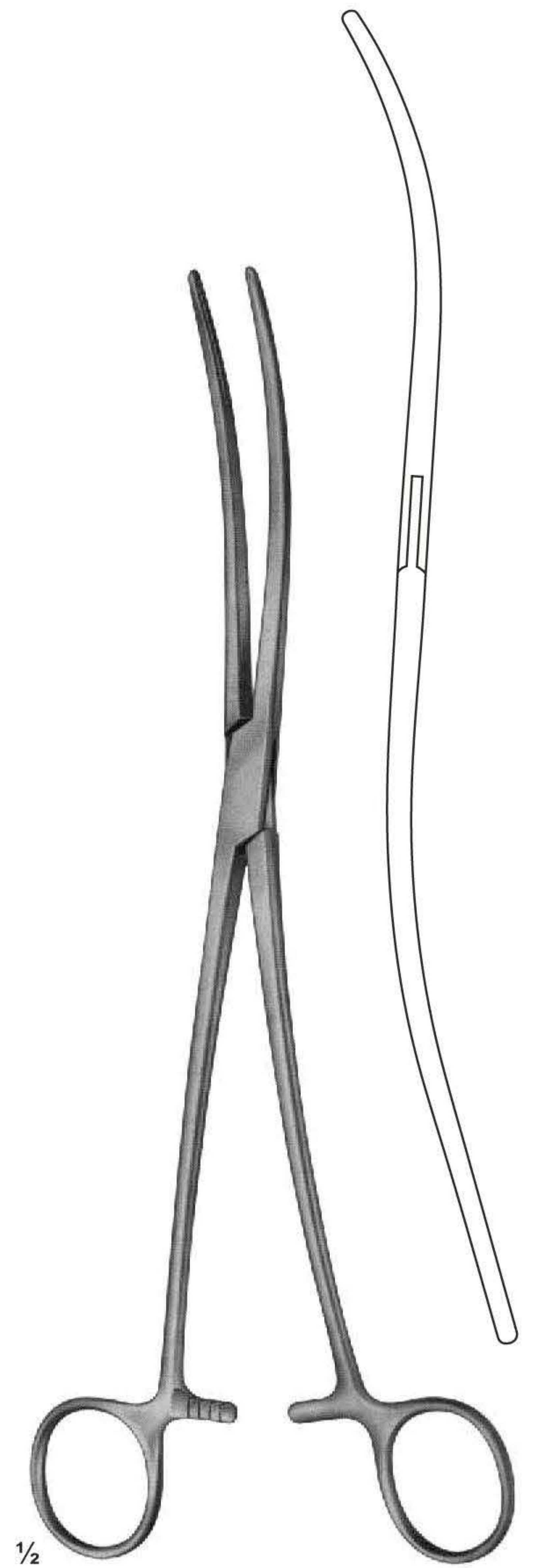

UG-748
BOZEMANN
255 mm

Jaws with longitudinal groove

Uterine Dressing Forceps

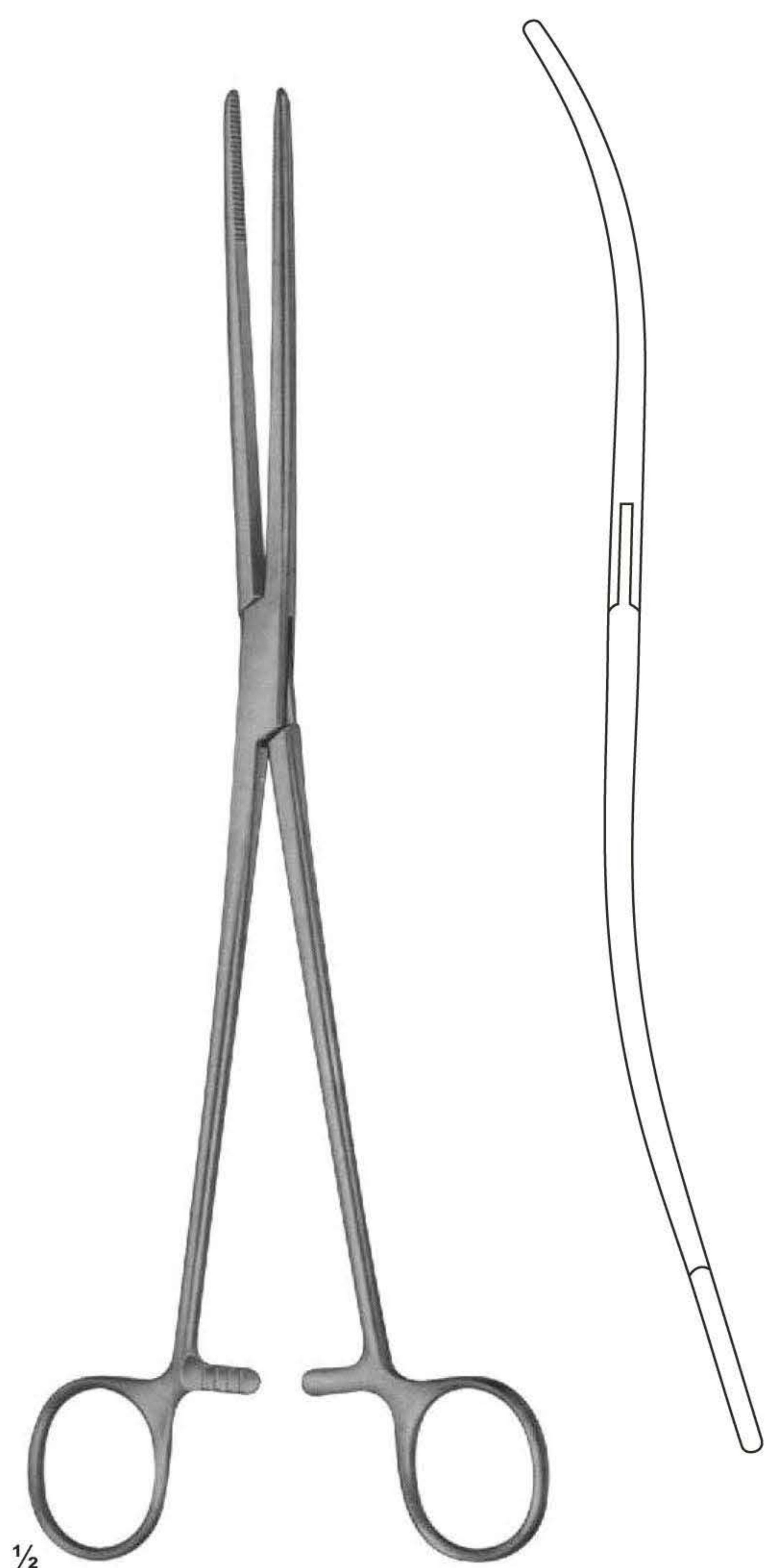

UG-750
BOZEMANN

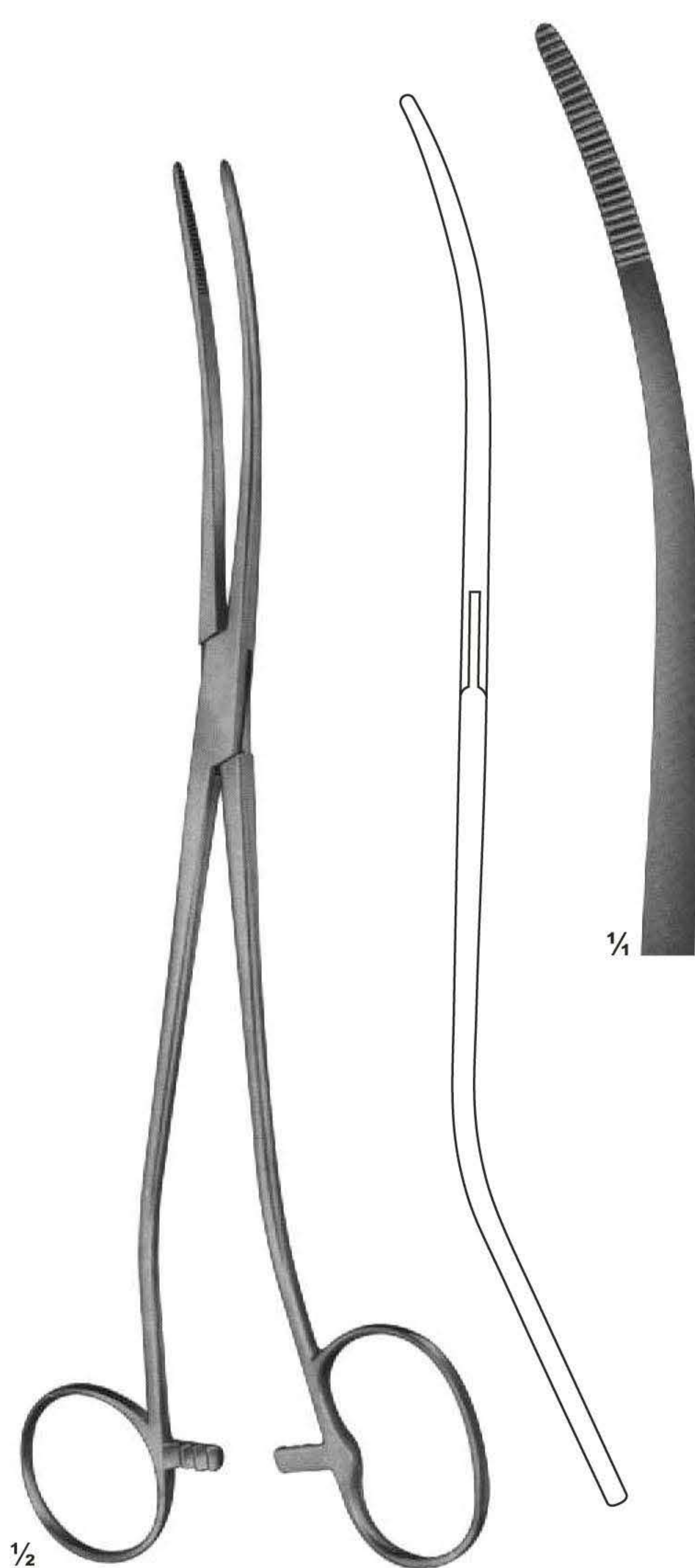

UG-752
BOZEMANN-DOUGLAS
260 mm

Uterine Tenaculum Forceps

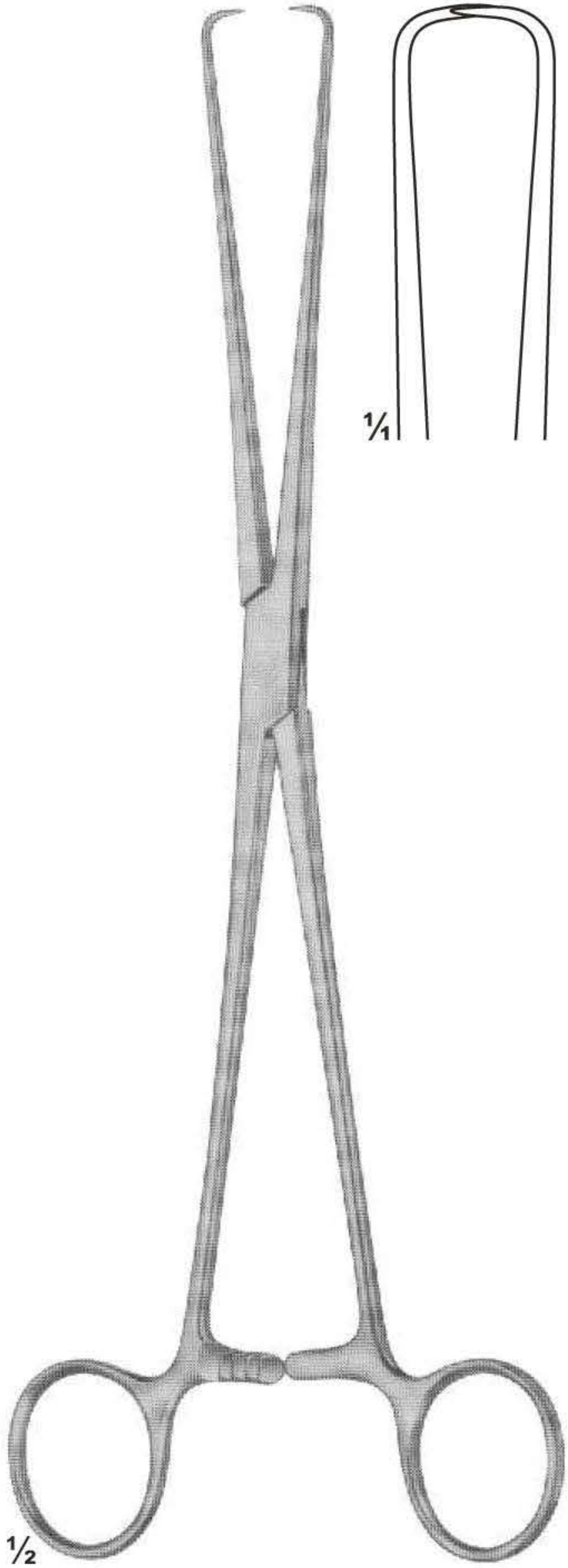

UG-754
BRAUN
slender type
250 mm



UG-755
SCHRODER
250 mm

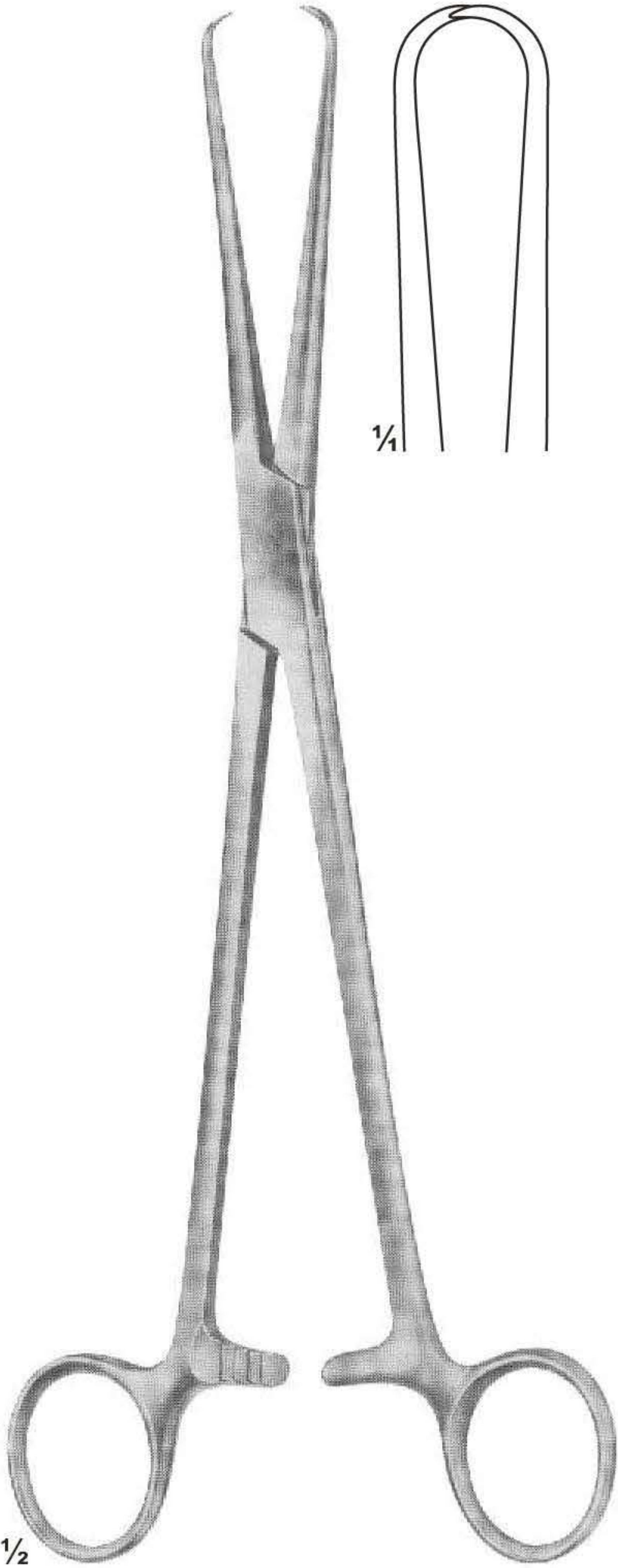

UG-756
POZZI
heavy type
255 mm

Uterine Tenaculum Forceps

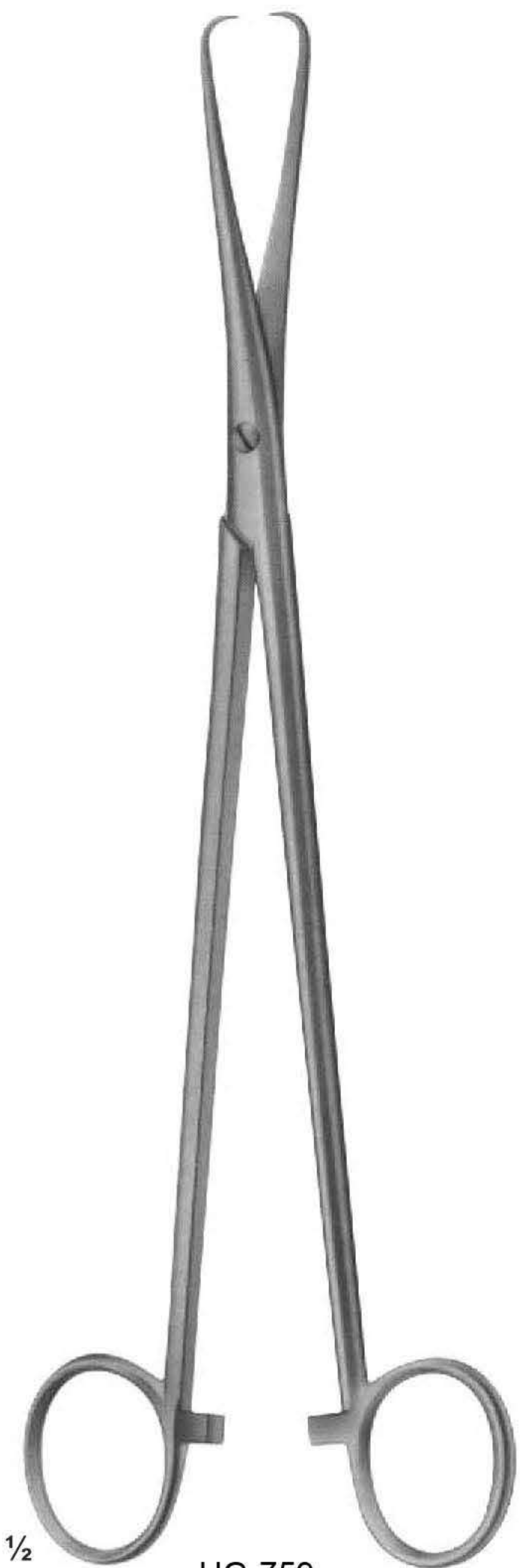

UG-759
265 mm

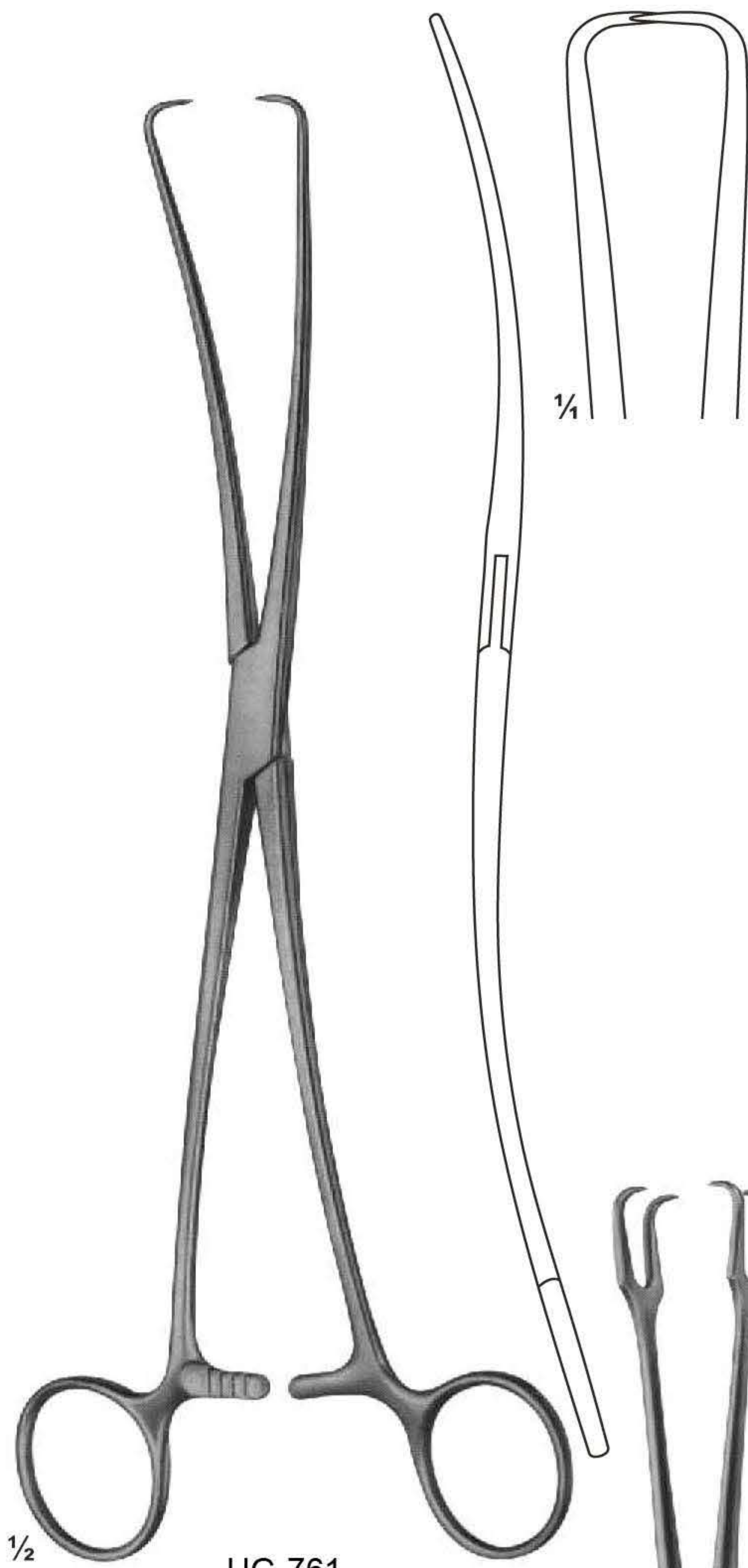

UG-761
DUPLAY
250 mm

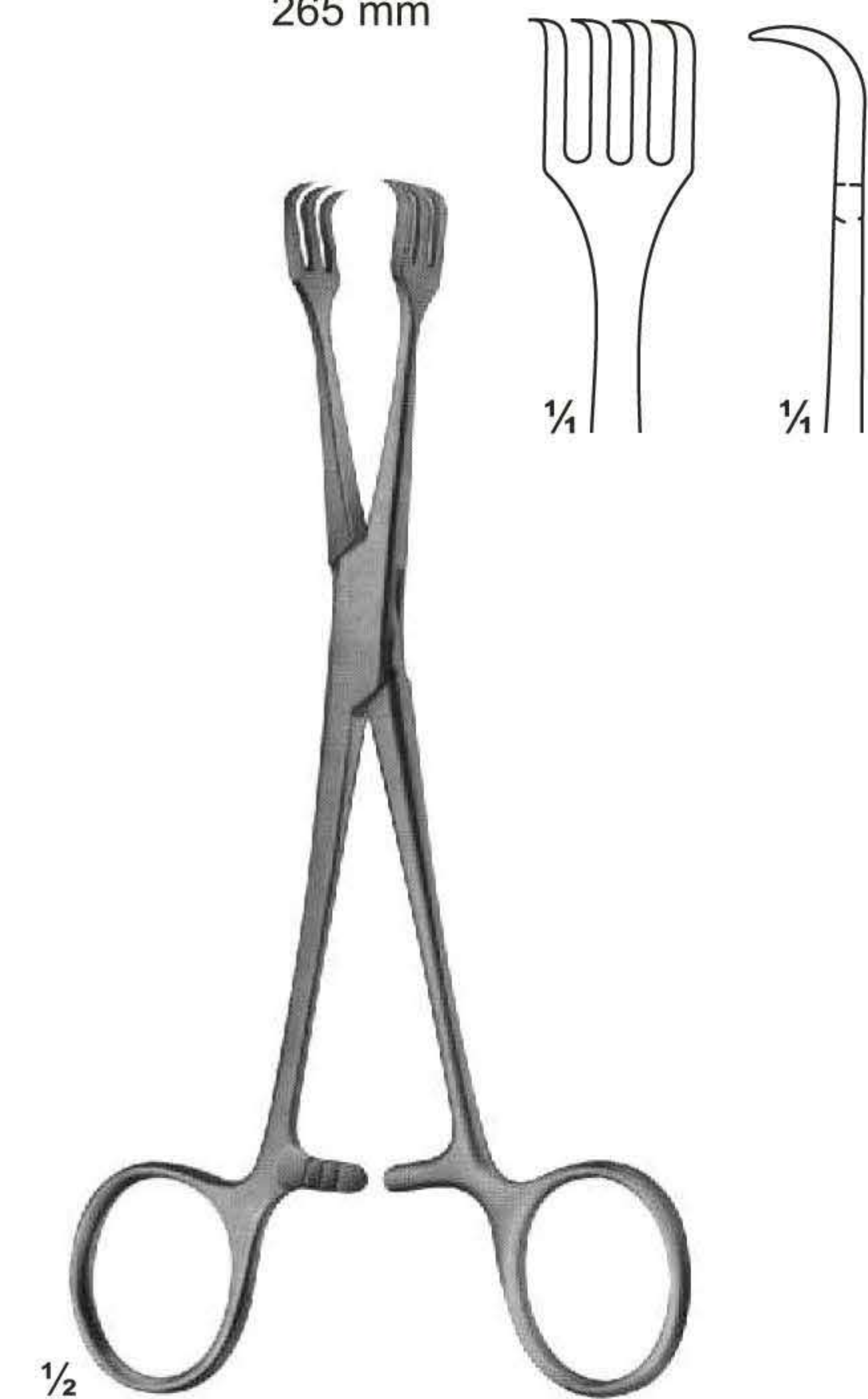

UG-762
LAHEY
155 mm



UG-764
SCHRODER
250 mm

Uterine Tenaculum Forceps

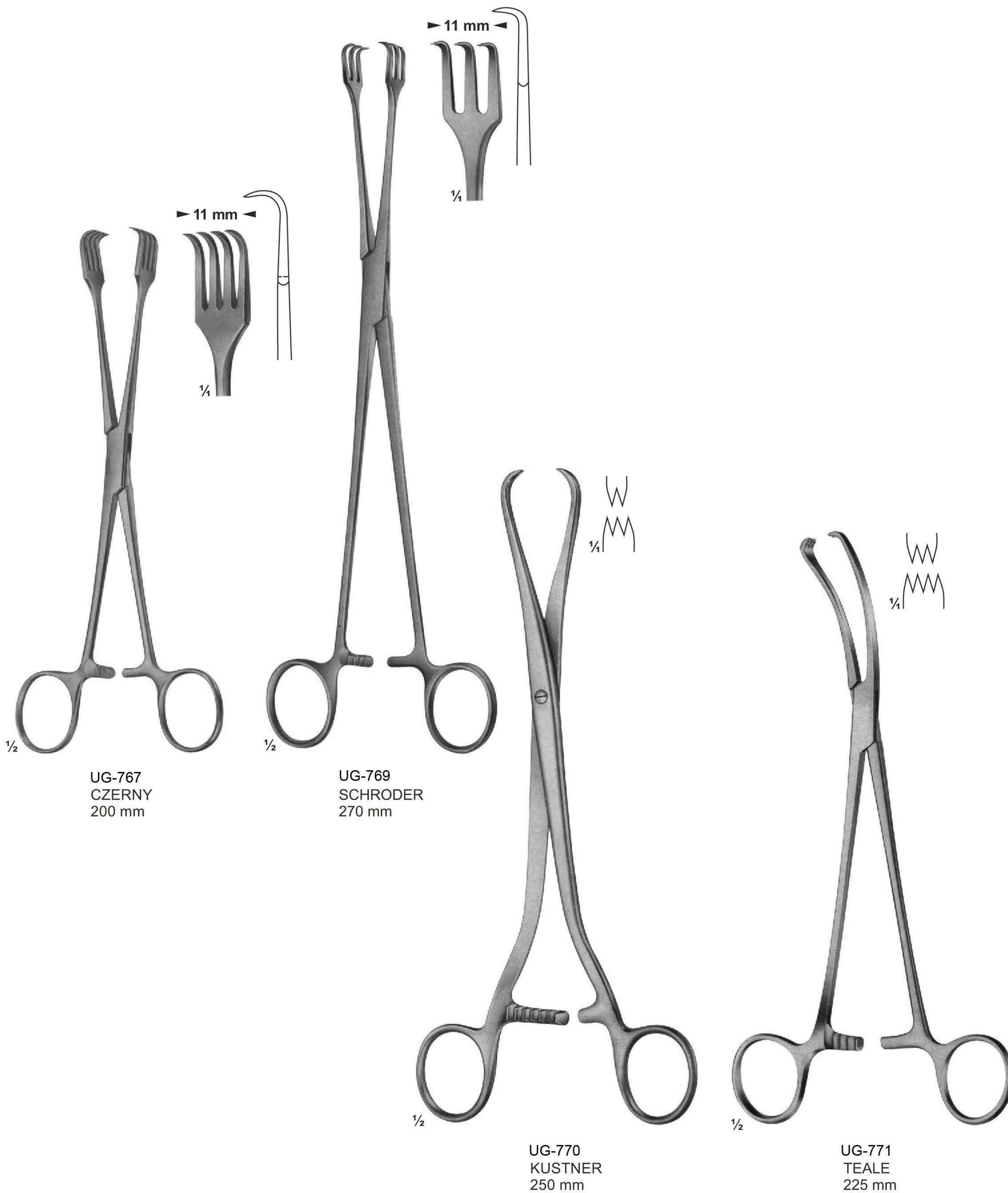

Uterine Tenaculum Forceps

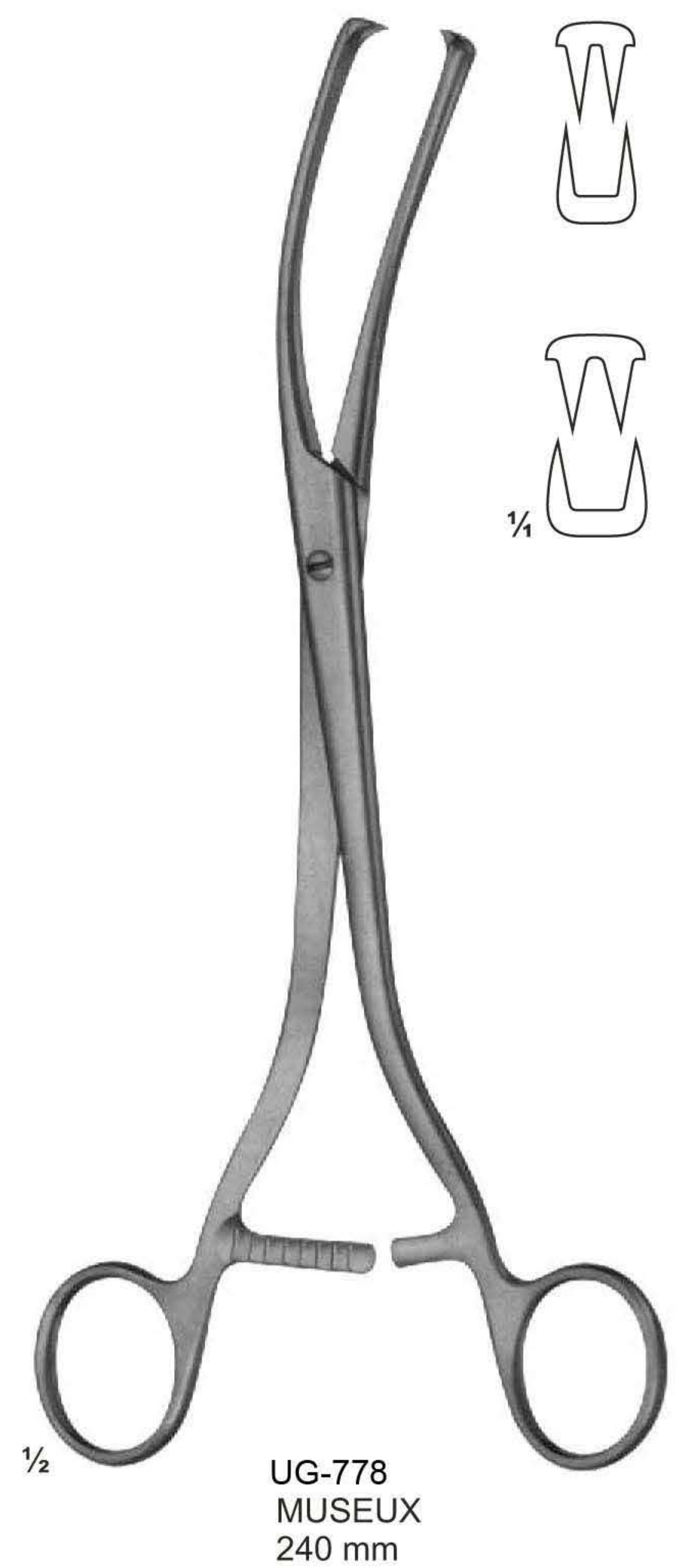
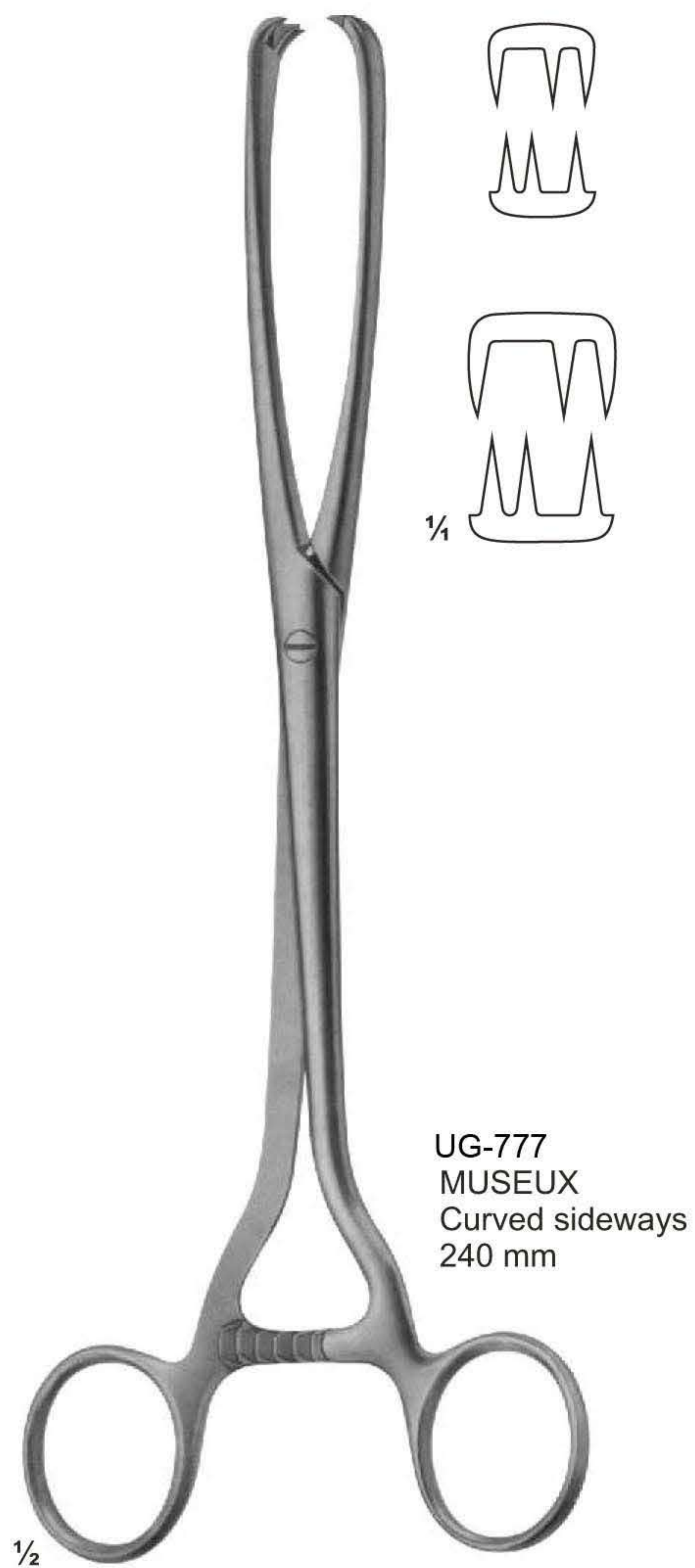
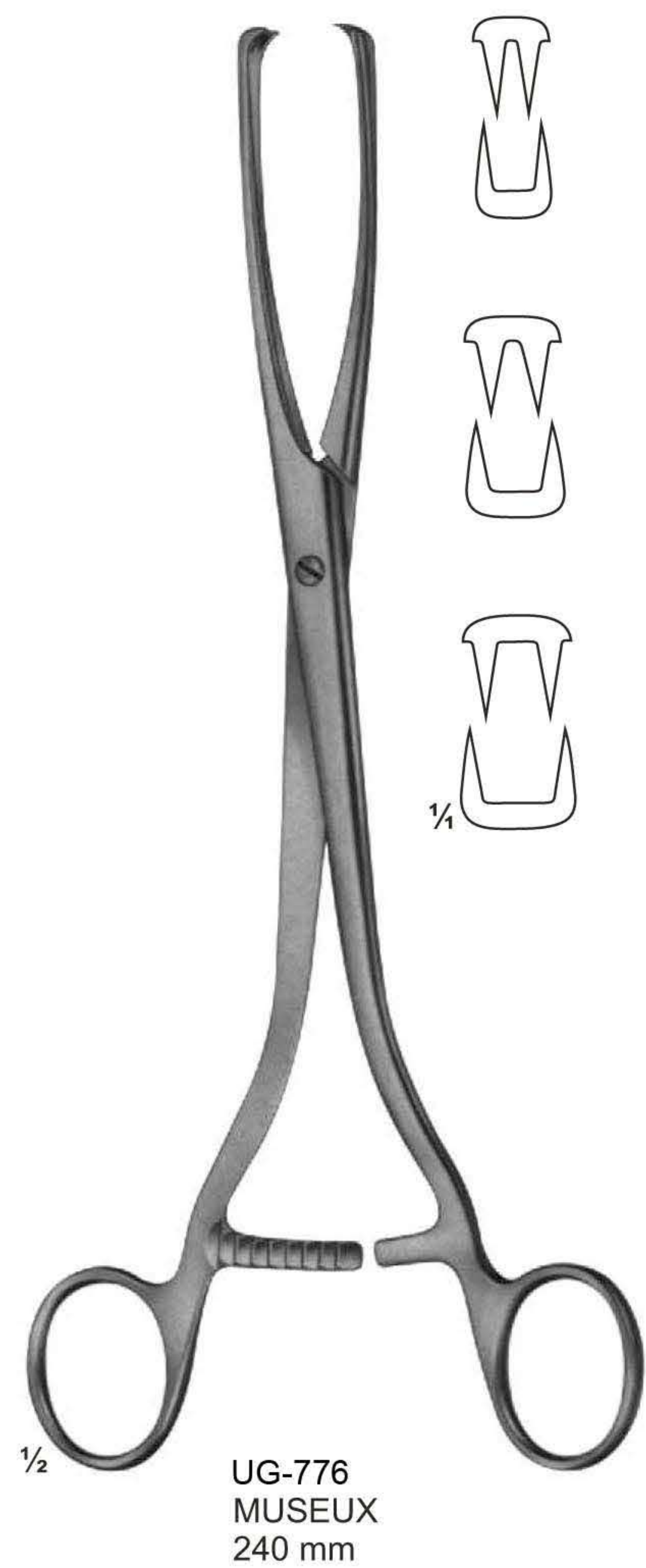

Polypus-and Ovum Forceps

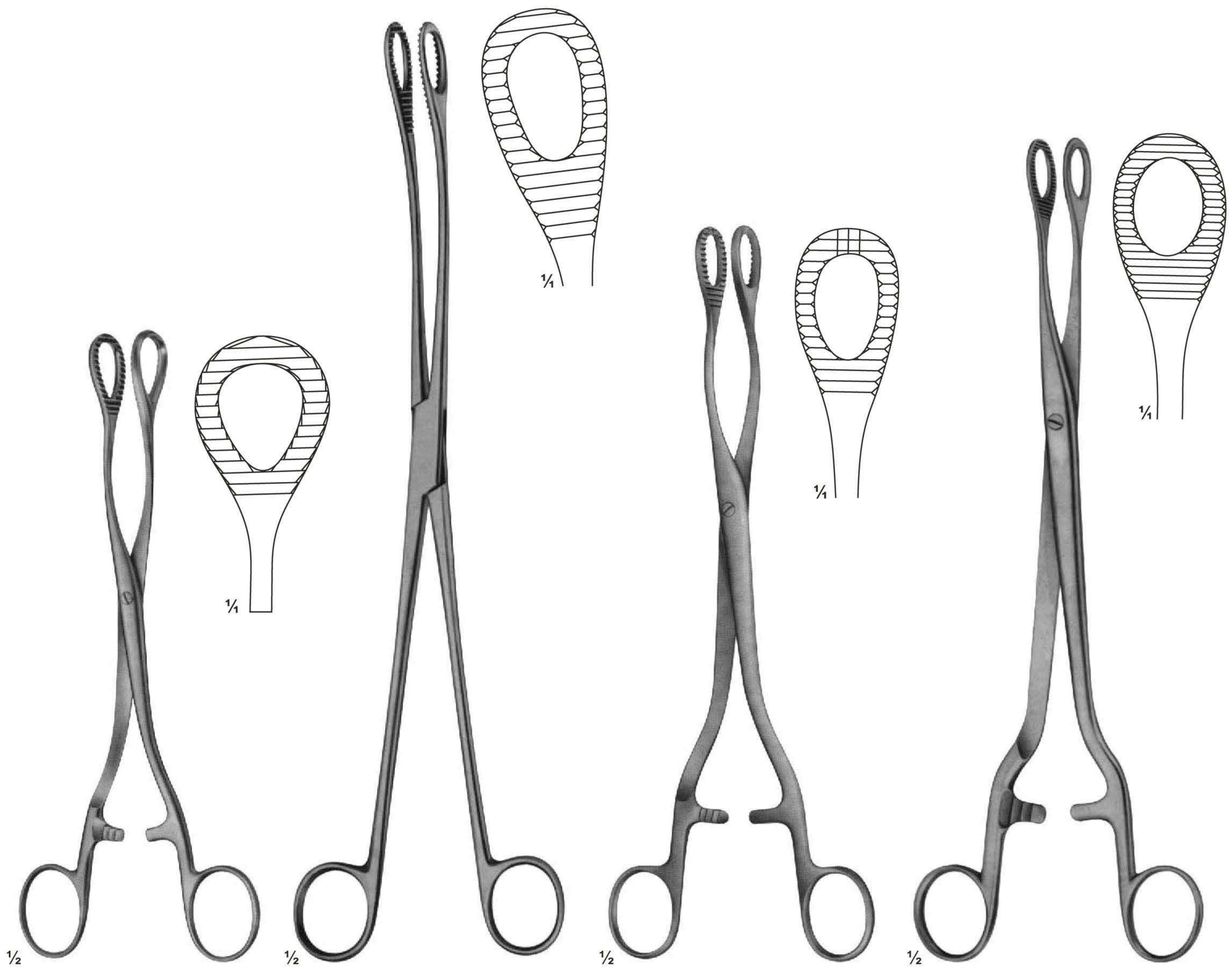

UG-779
HEYWOOD-SMITH
200 mm

UG-780
KELLY
320 mm

UG-781
HEYWOOD-SMITH
250 mm

UG-782
NOTO
280 mm

Polypus and Ovum Forceps

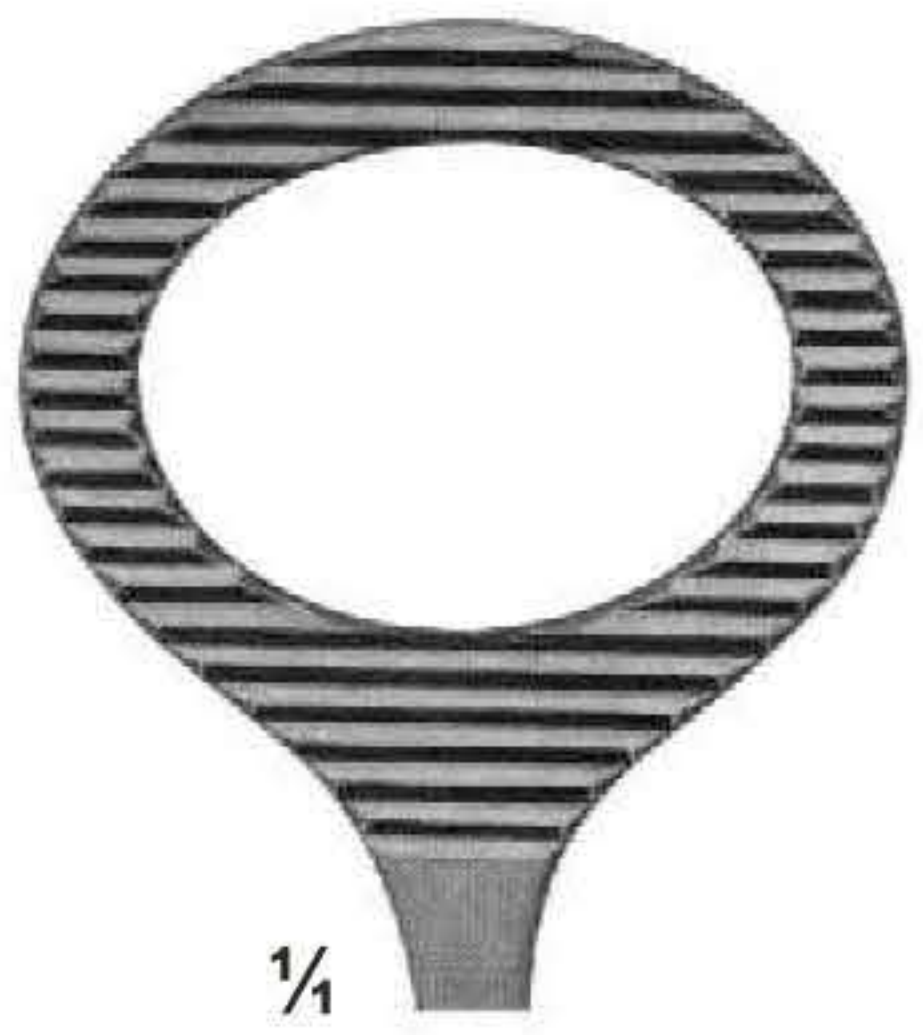

UG-786
DOYEN
185 mm



UG-788
250 mm 270 mm



UG-790
BUMM
280 mm

Uterine Elevating Forceps

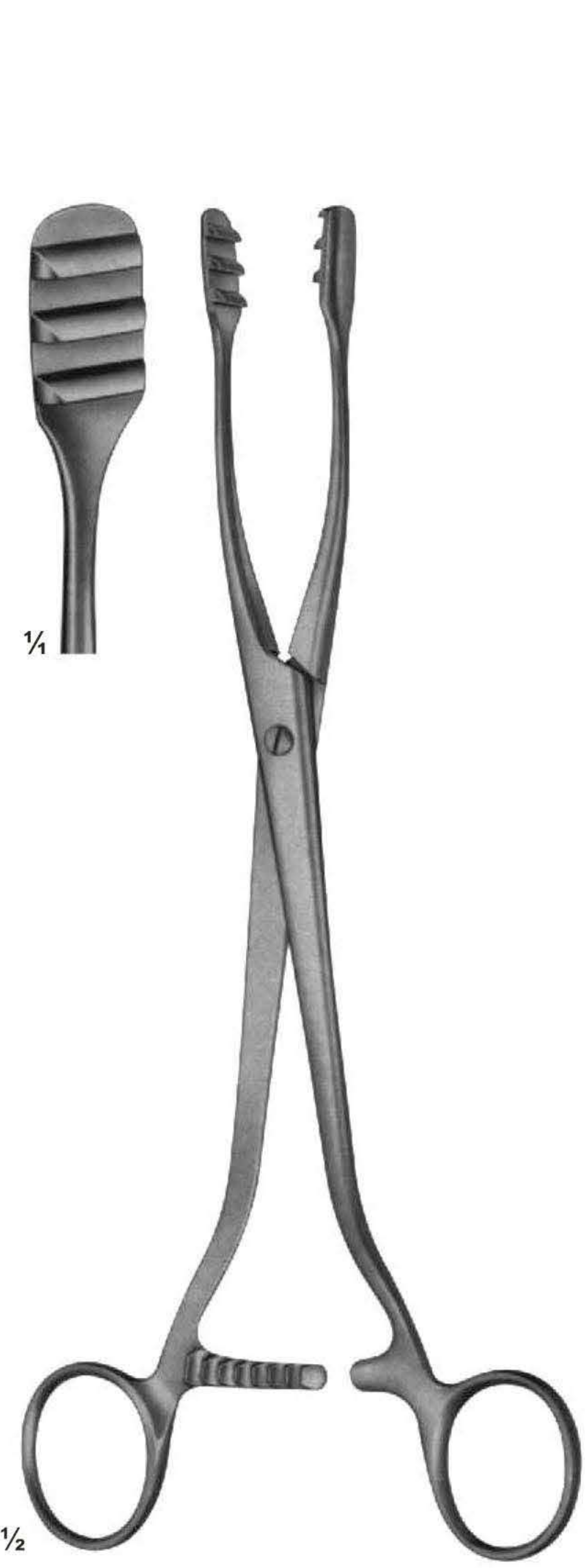

UG-791
COLLIN
250 mm



UG-792
COLLIN
285 mm



UG-793
DARTIGUES
255 mm

Uterine Elevating Forceps



UG-795
SOMER
235 mm



UG-796
STRASSMANN
260 mm

Uterine Elevating Forceps

With movable jaws

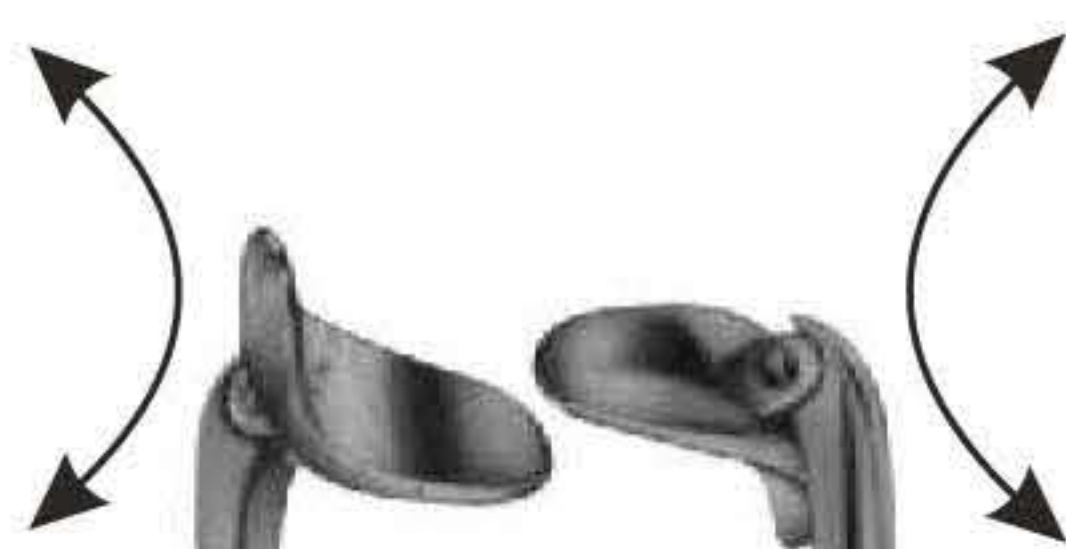

UG-797
COLLIN
265 mm

With movable jaws

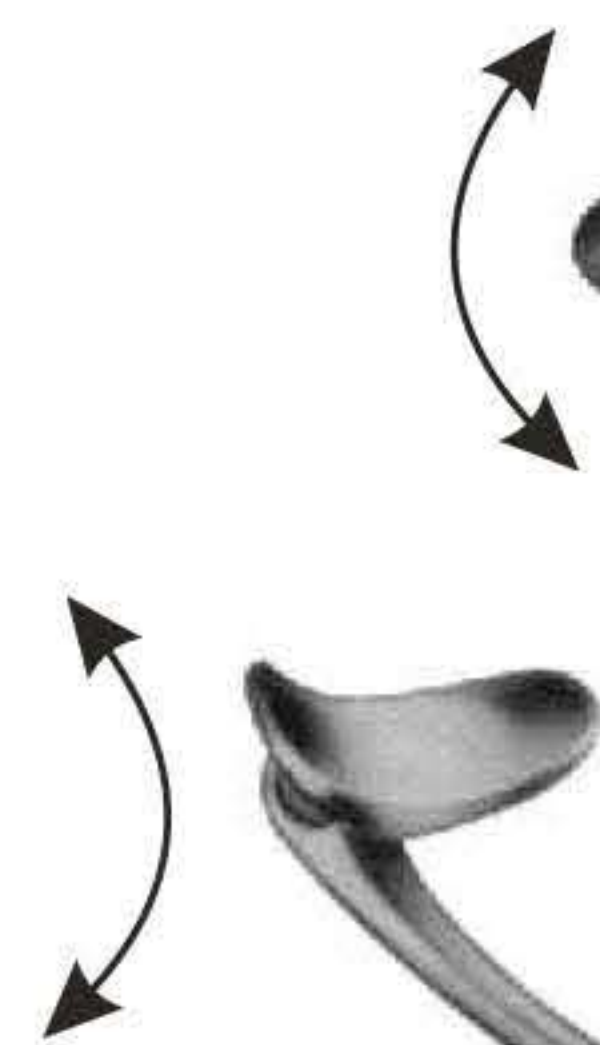

UG-799
260 mm

Myoma Instruments



UG-801
SEGOND
Myomatome
270 mm



UG-802
DOYEN
Myoma screw
150 mm



UG-804
DOYEN
Myoma screw
190 mm



UG-806
NEUBUSER
Tubal seizing forceps
200 mm

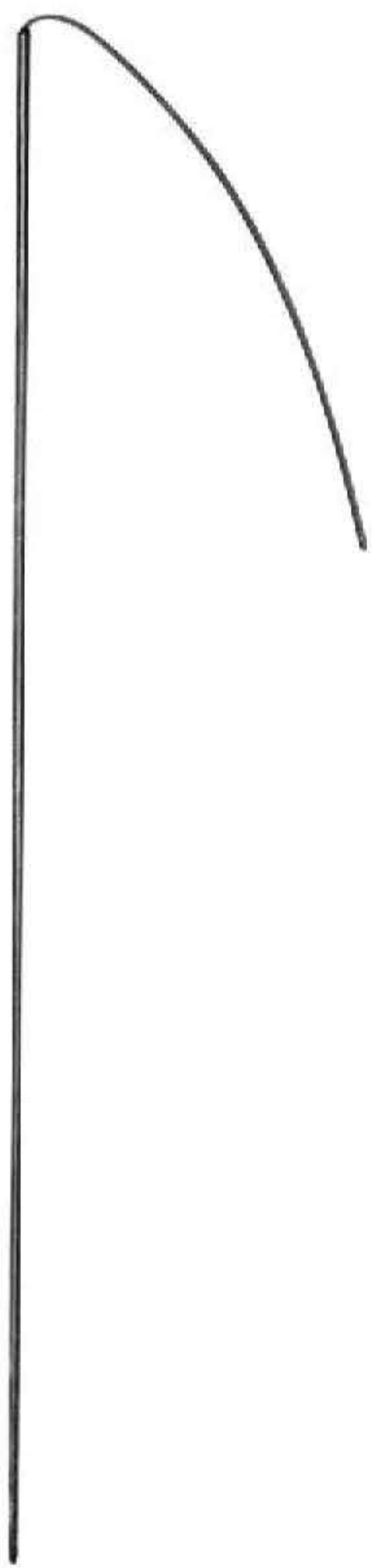

UG-808
Splint guide
with thread



UG-810
Splint guide with
round handle
180 mm



UG-812
Angled glass rods
Set . 3 pieces

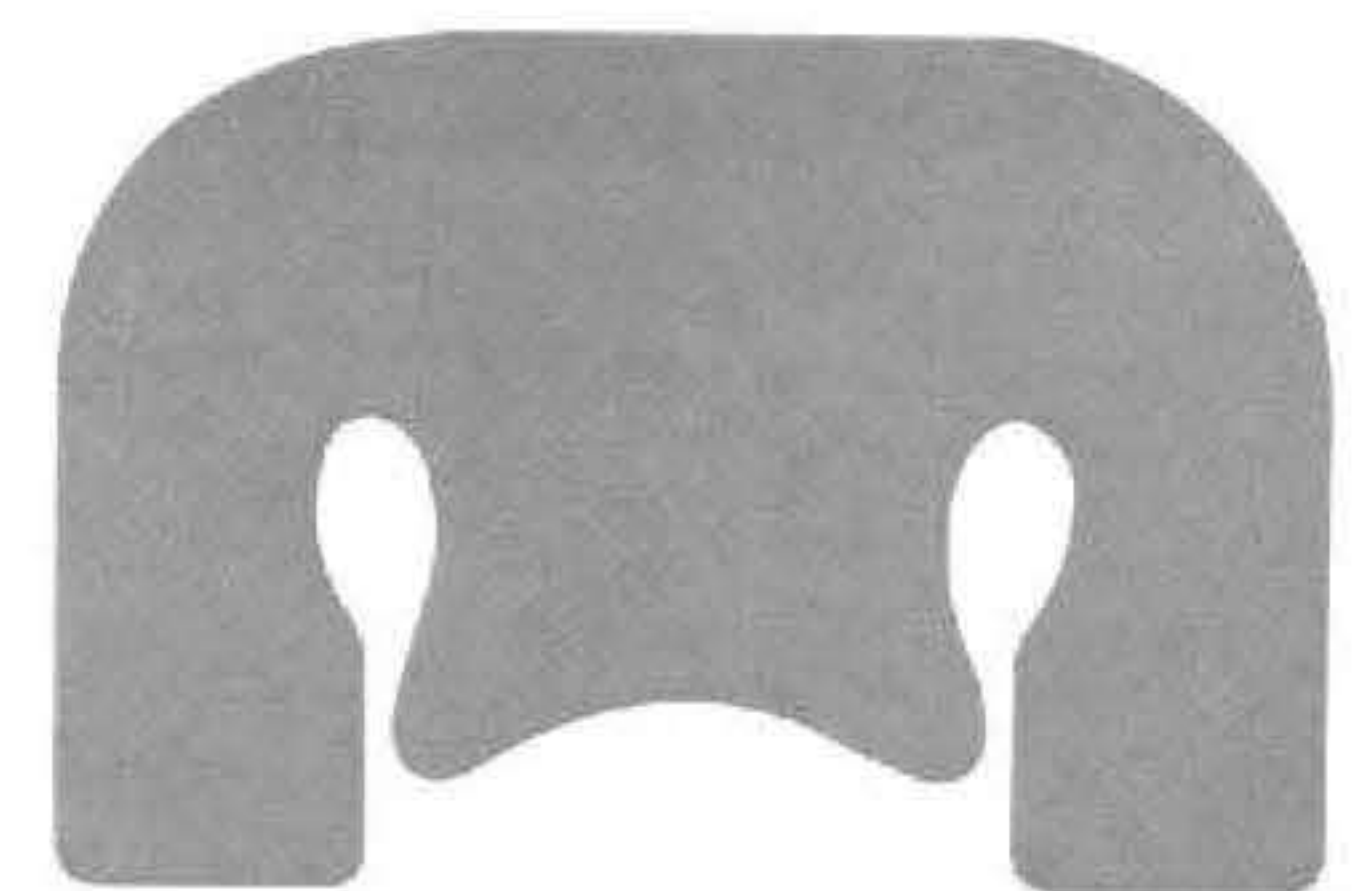

UG-813
Silicon operating pad
pre-cut

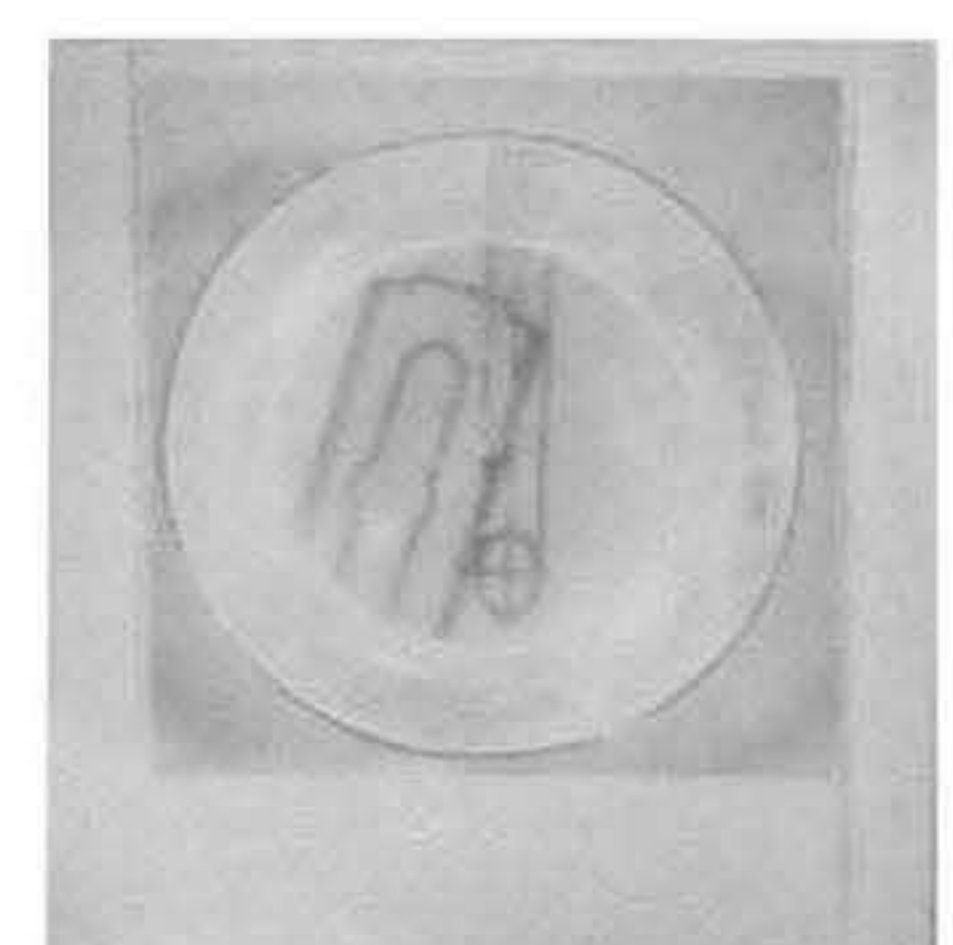

UG-814
Polyethylene splint material
soft-sterile
0.45 mm

Biopsy Currettes

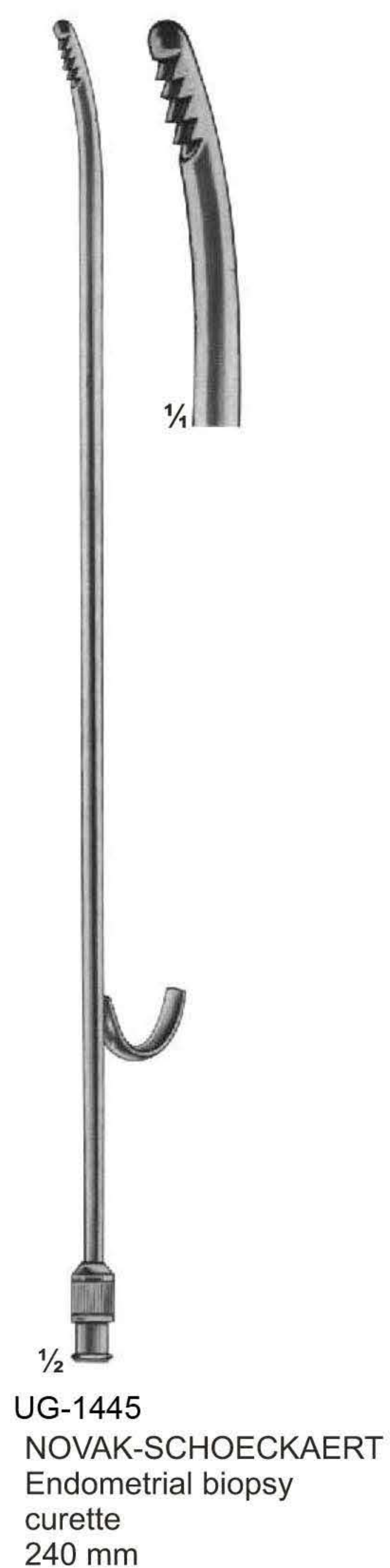
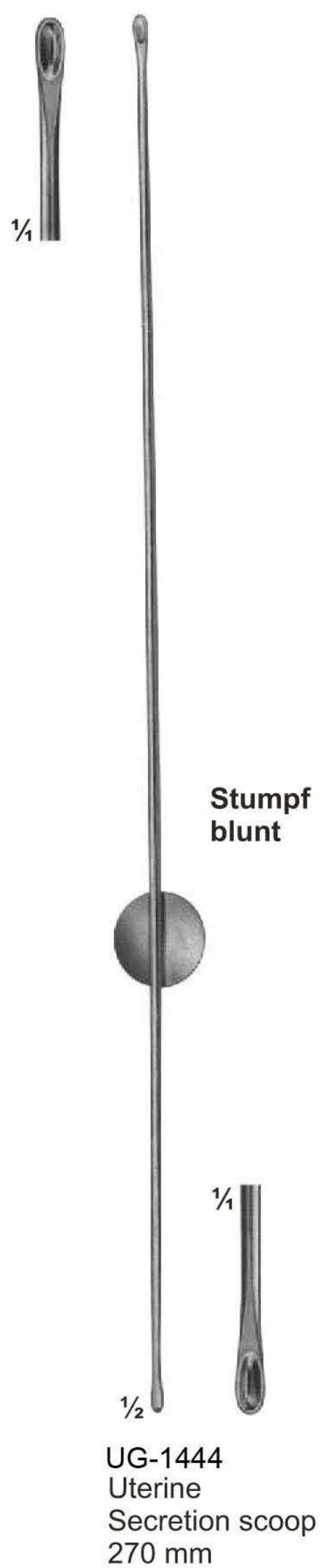

Biopsy Forceps

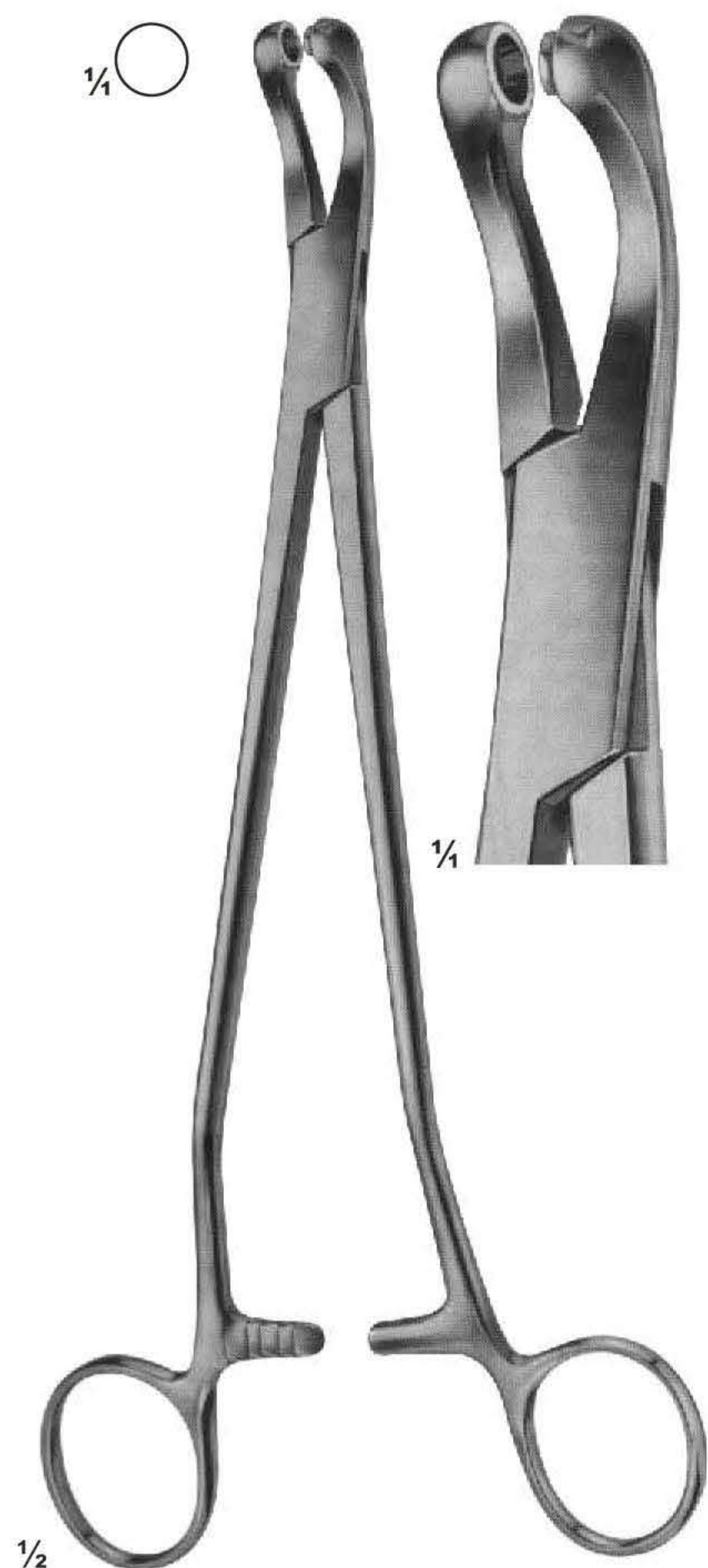

UG-1447
THOMS-GAYLOR
240 mm

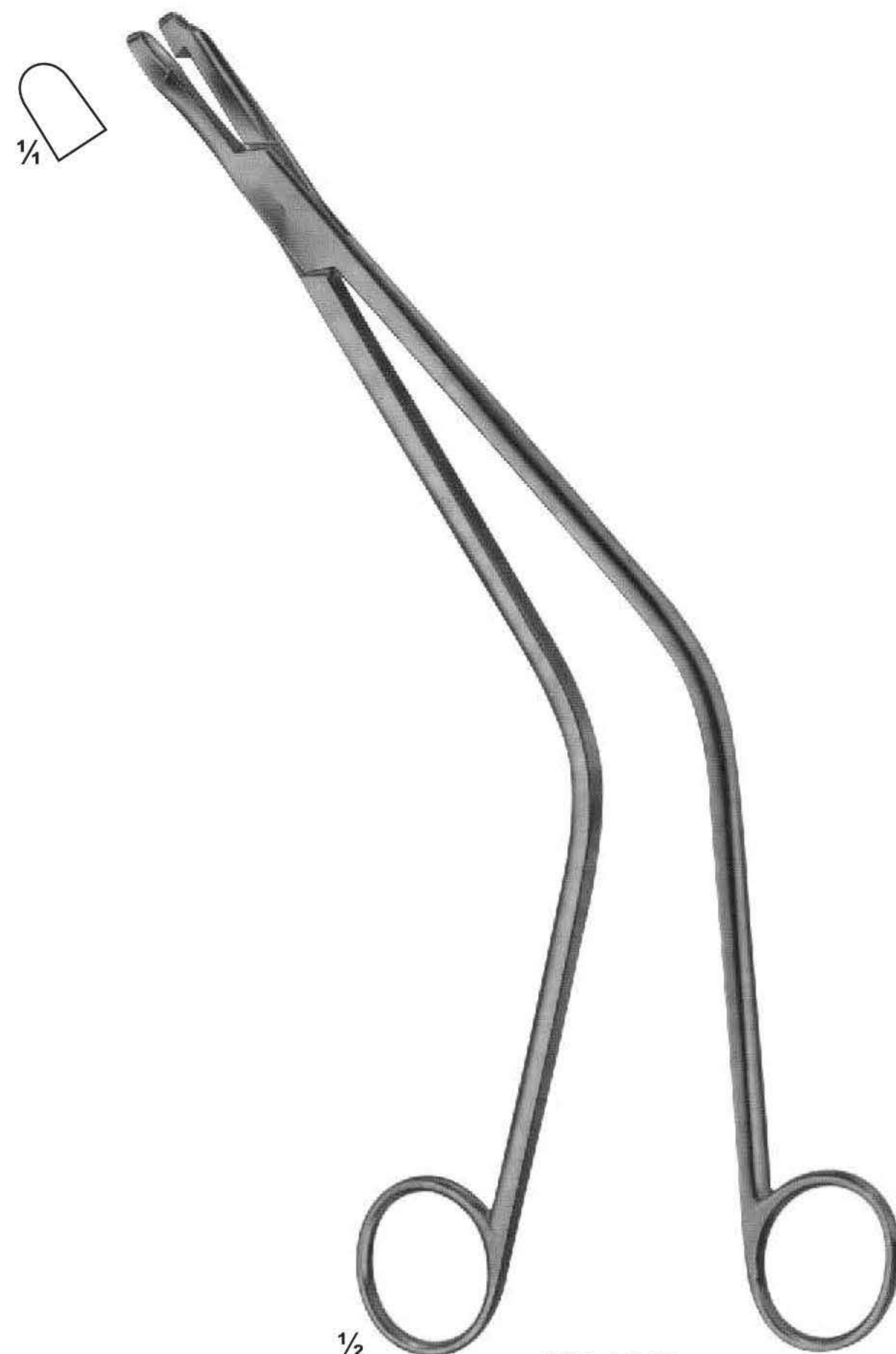

UG-1448
SCHUBERT
260 mm

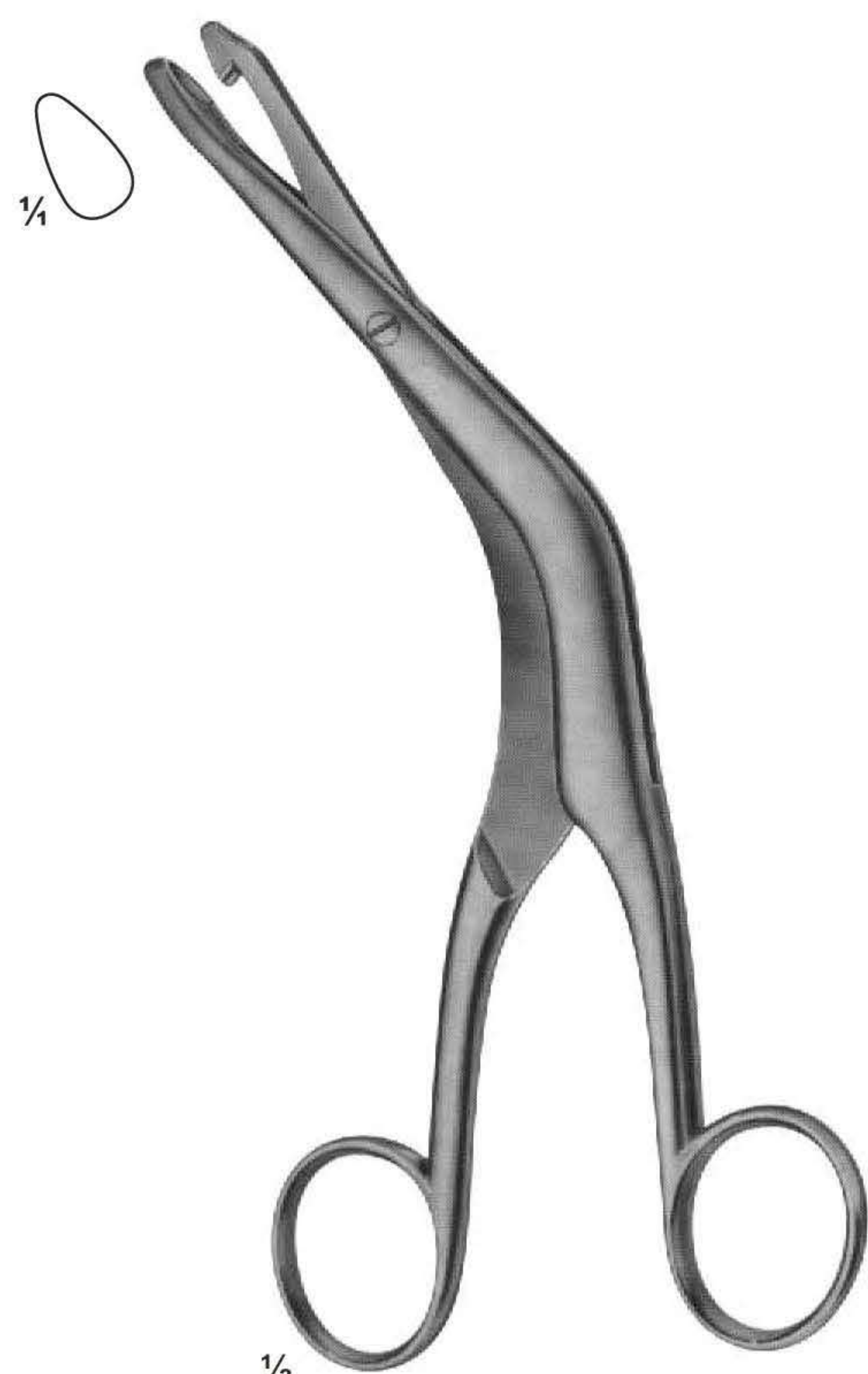

UG-1449
FAURE
210 mm

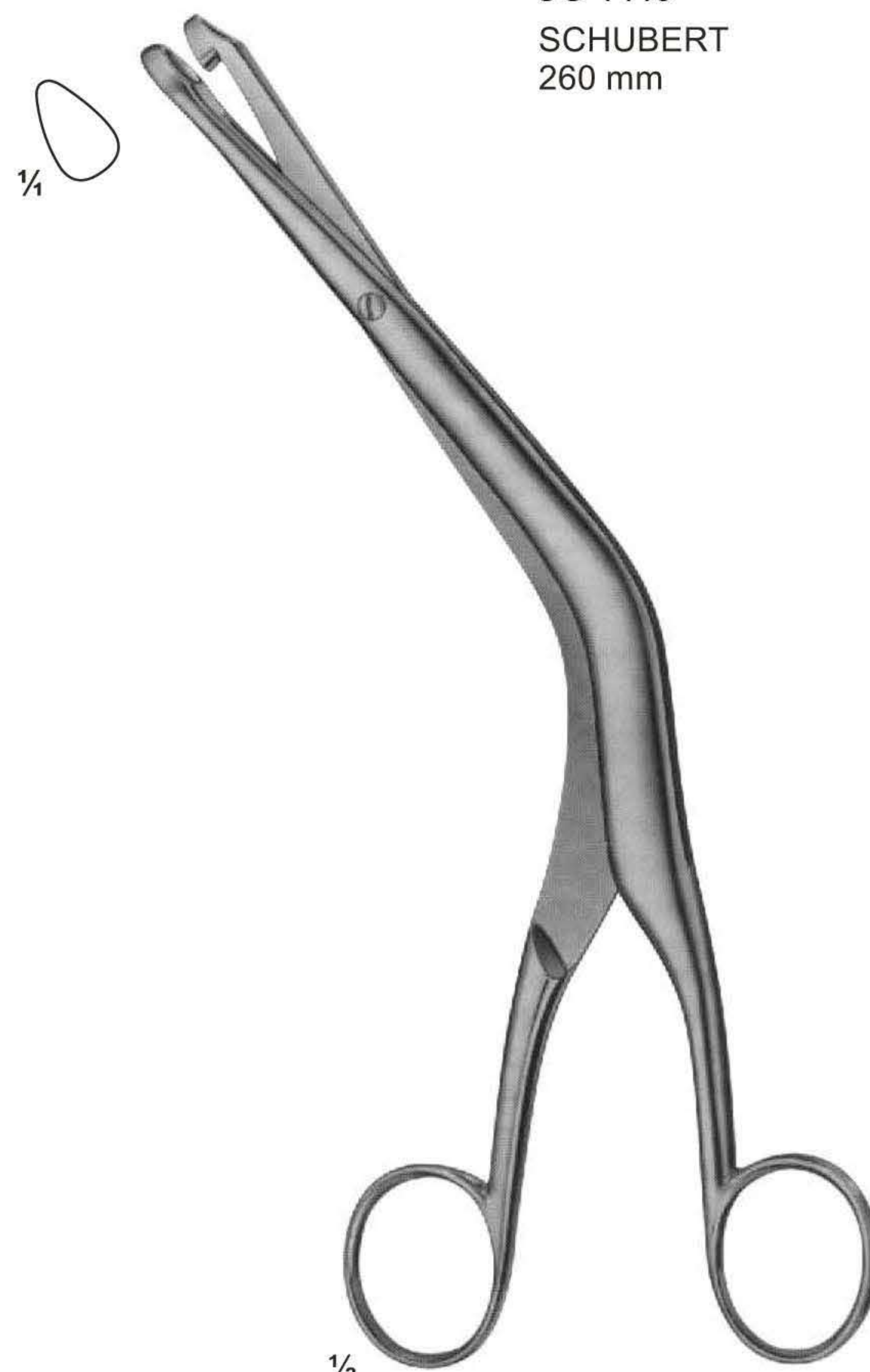

UG-1450
FAURE
240 mm

Biopsy Forceps

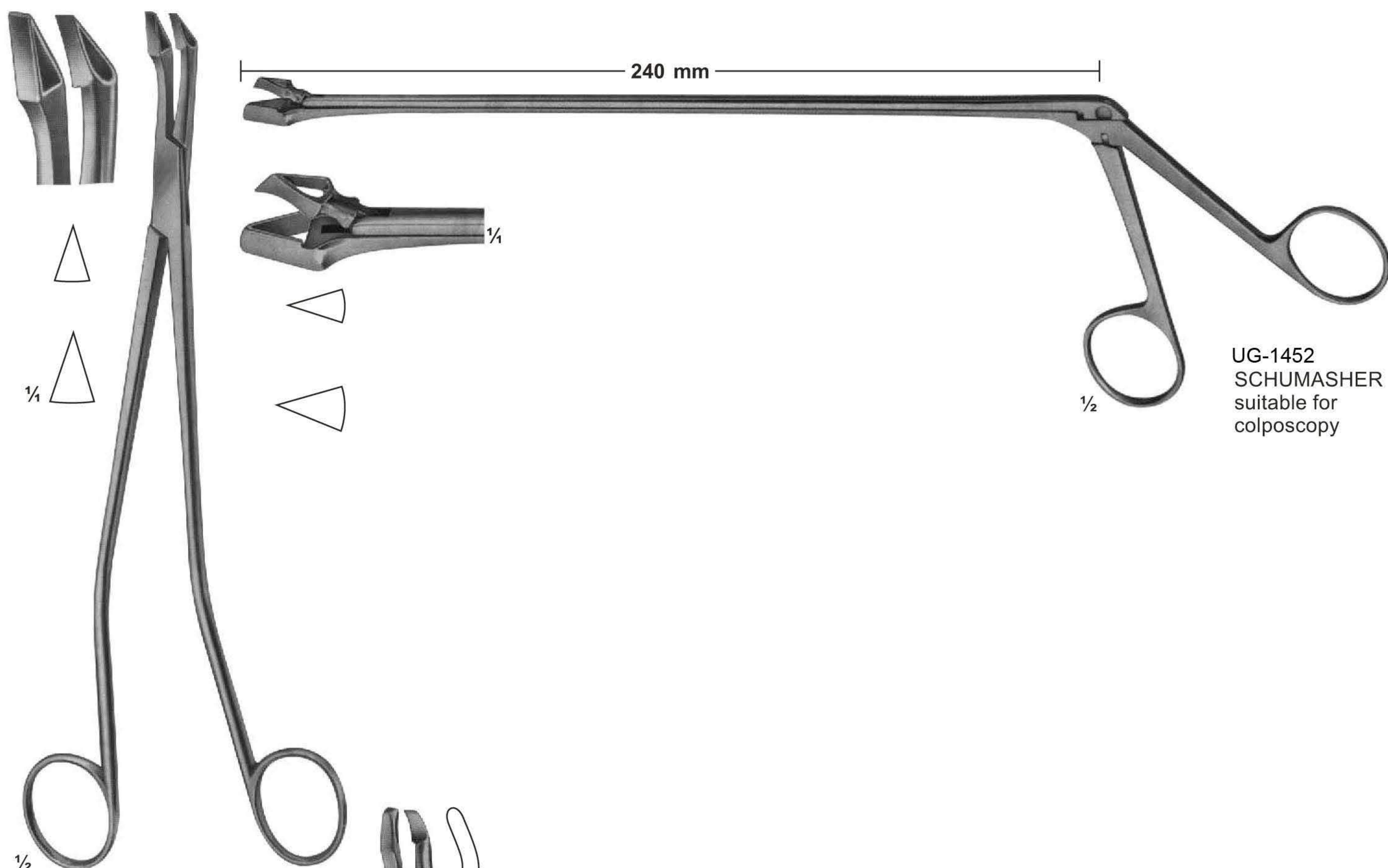

UG-1451
SCHUMASHER
240mm

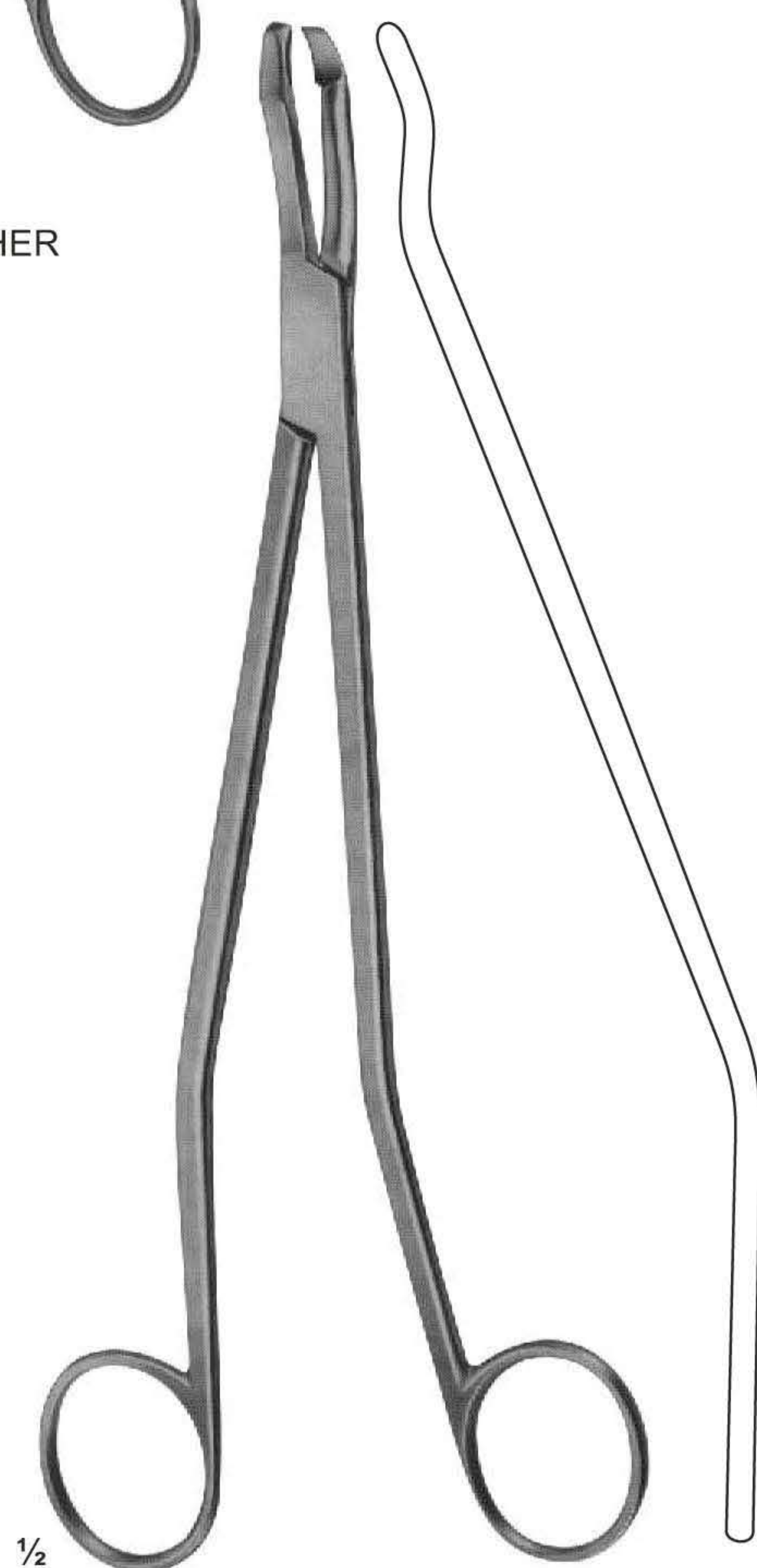

UG-1453
SEIDL DBP
Biopsy forceps, bayonet shaped
for portio, vagina and vulva
240mm

UG-1452
SCHUMASHER
suitable for
colposcopy

Biopsy Forceps

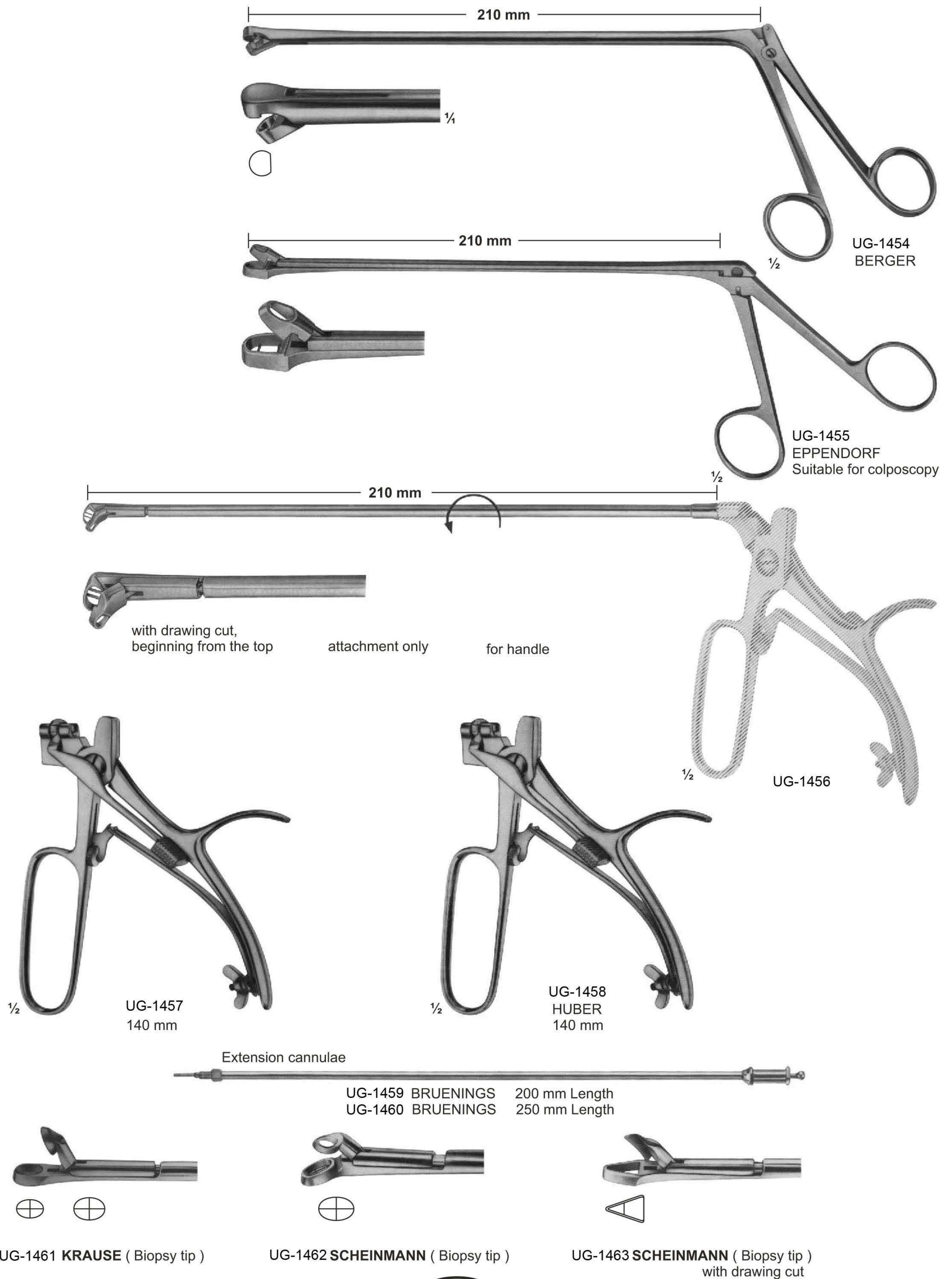

Uterine Scoops



$\frac{1}{2}$
UG-1464
SIMON
240 mm



$\frac{1}{2}$
UG-1465
SCHRODER
310 mm



$\frac{1}{2}$
UG-1466
RECAMIER
300 mm

Uterine Curettes



UG-1467
SIMS
255 mm



UG-1468
BUMM
blunt-malleable
290 mm



UG-1469
BLAKE
275 mm

Placenta-and Ovum Curettes



1/2
UG-1470
COLLIN
300 mm



1/2
UG-1471
RECAMIER
blunt-rigid
360 mm

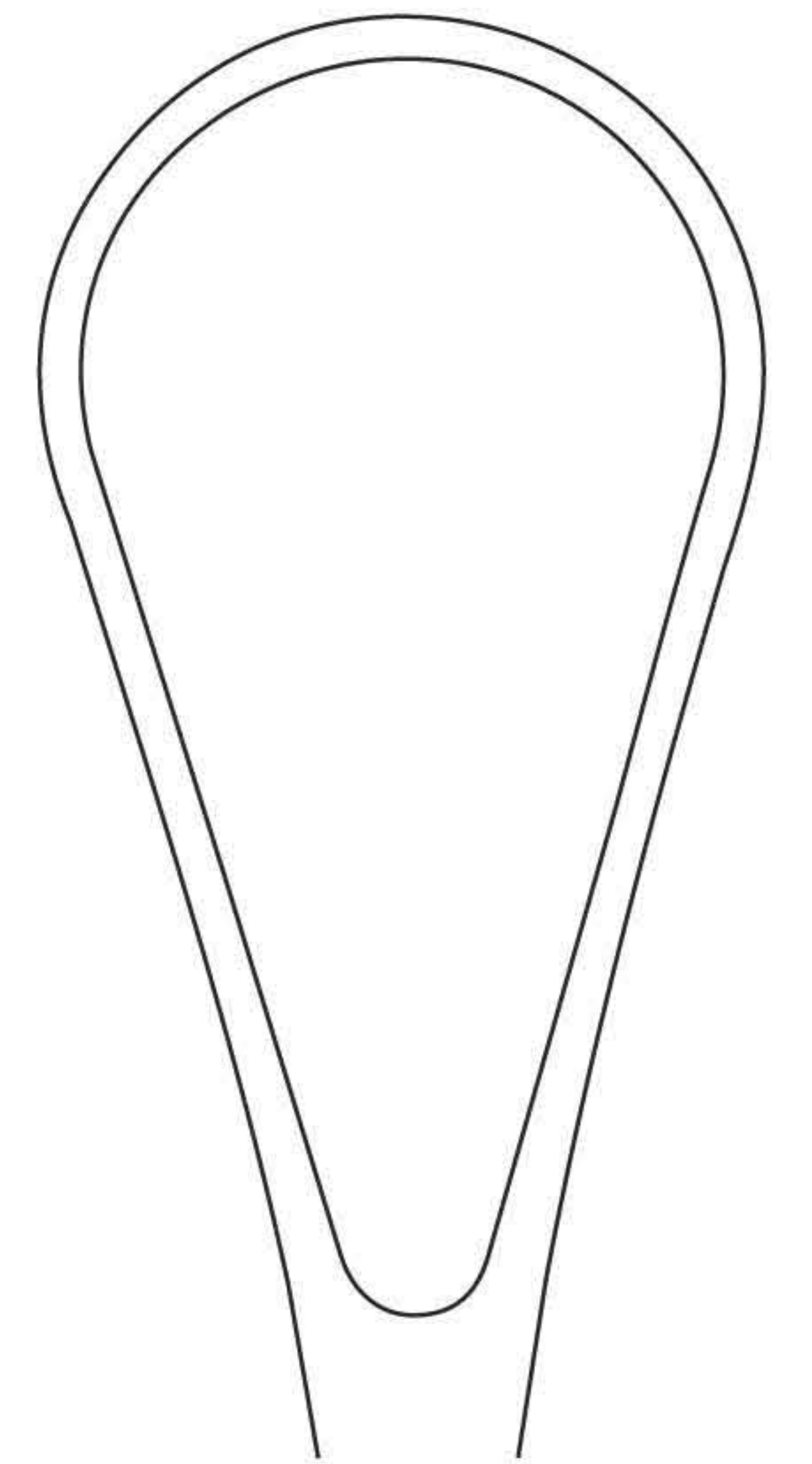
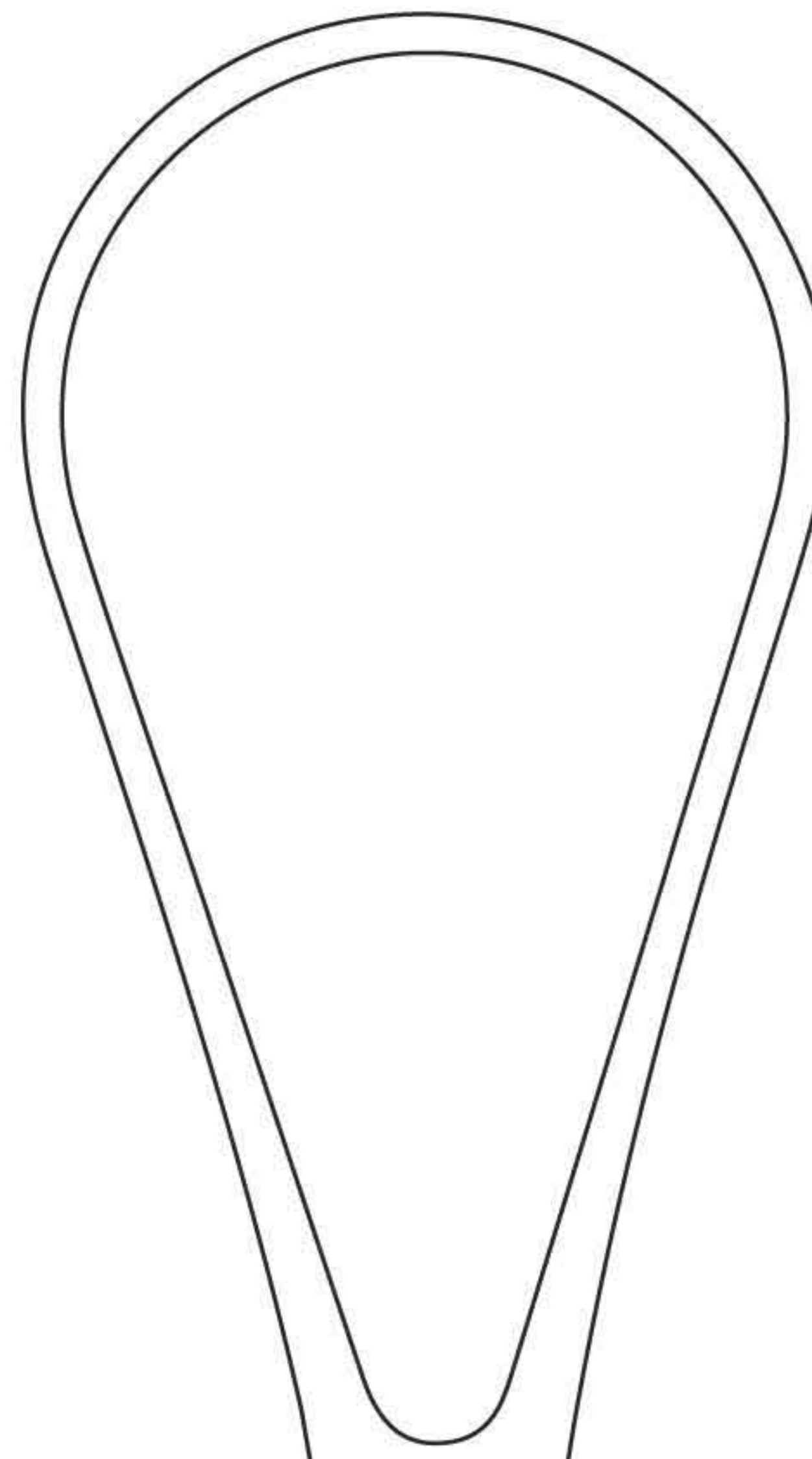

Fig:1



1/4

Fig:2



1/2
UG-1472
BUMM
310 mm

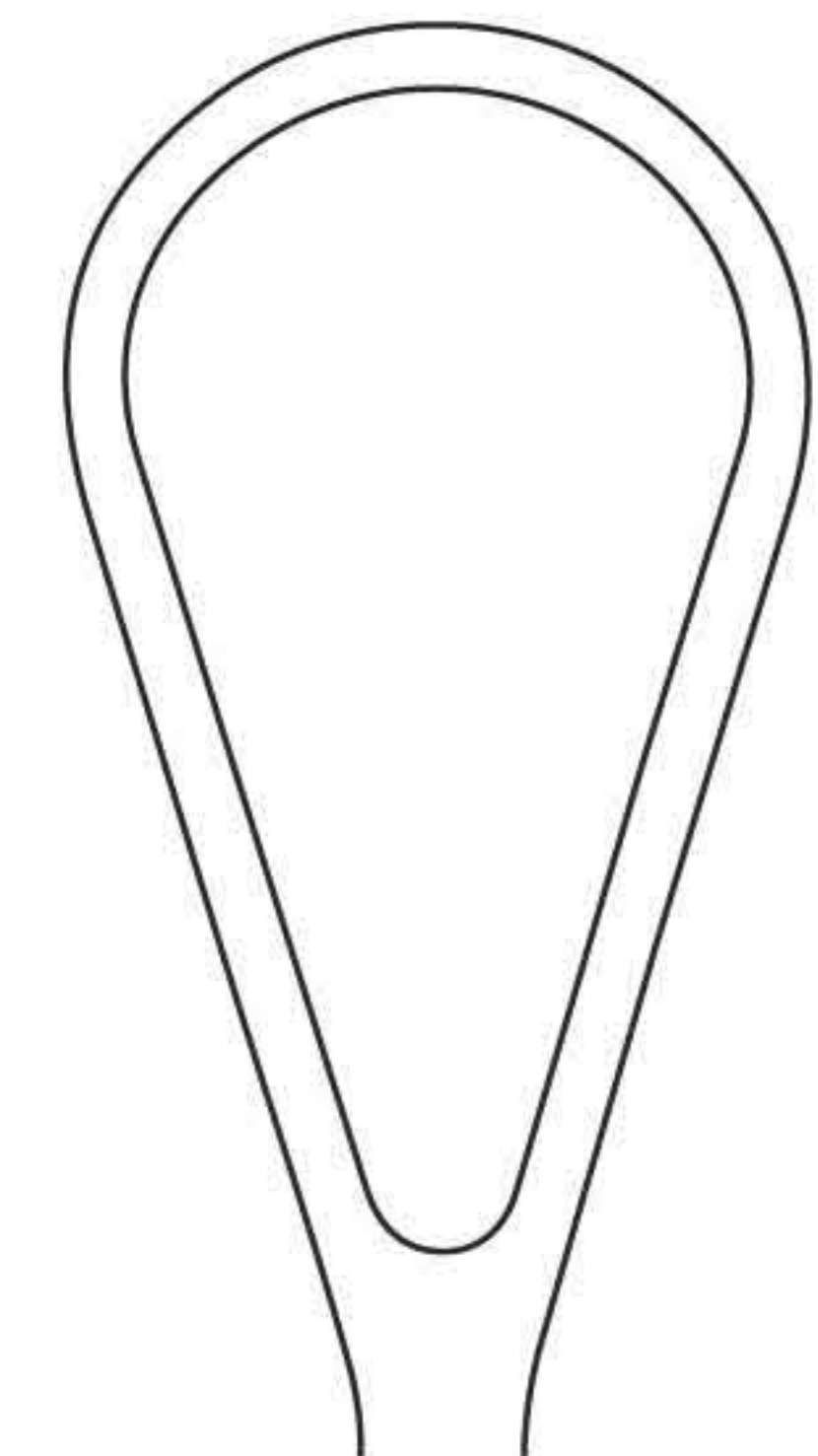

Fig:1

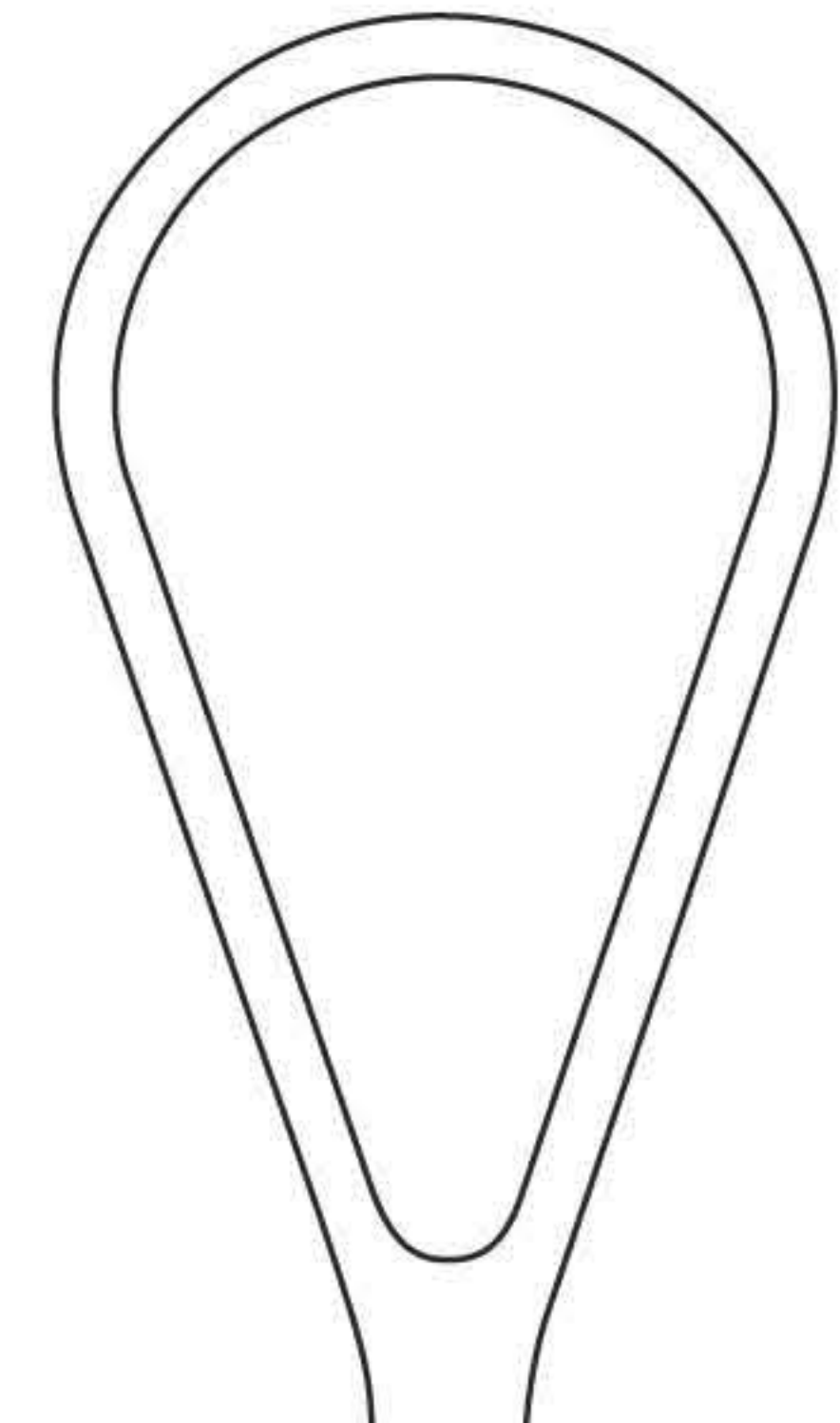
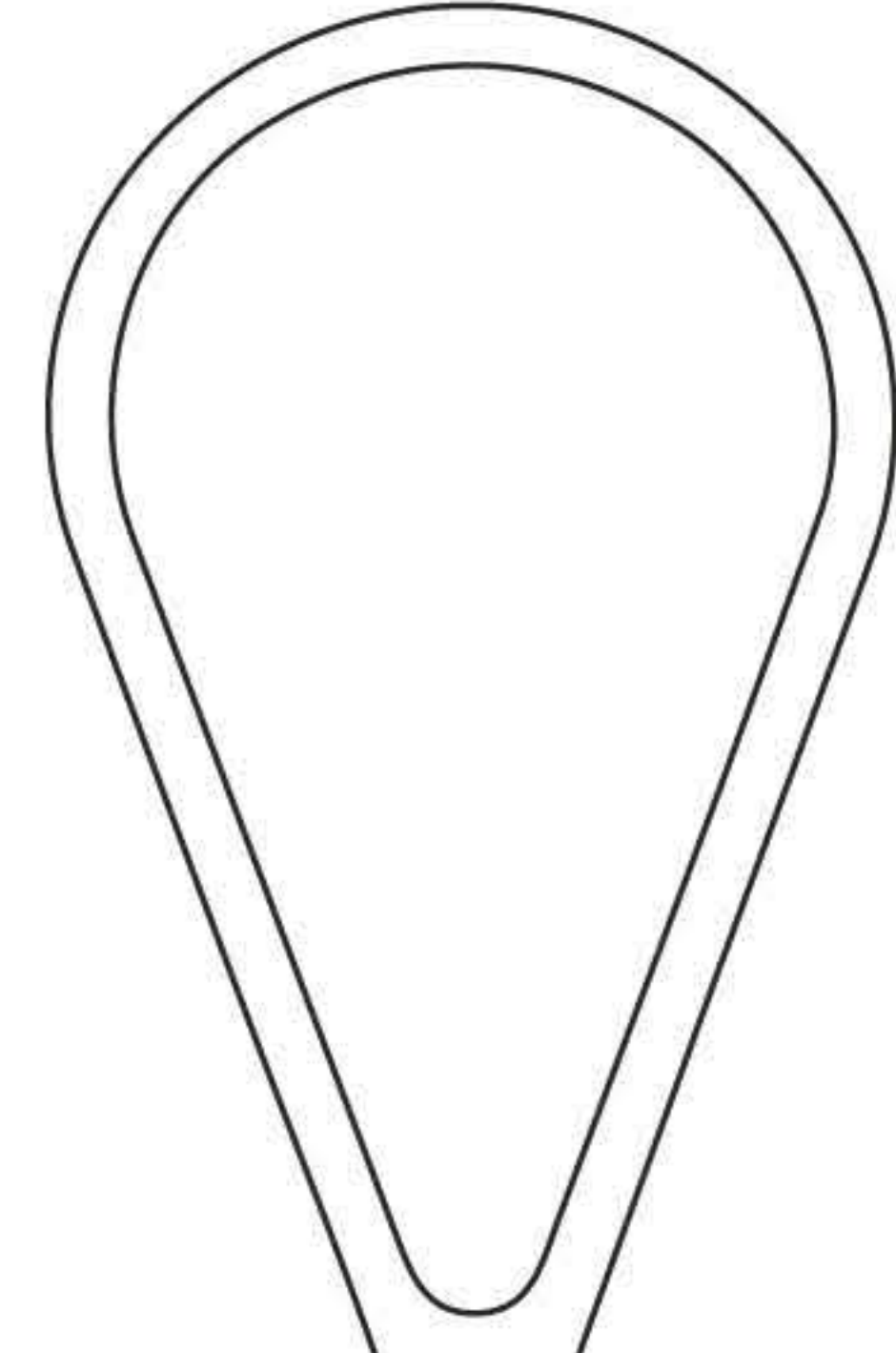

Fig:2



1/4

Fig:3

Vacuum Curettes

UG-1473

Suction curettes, stainless steel, fitting hose connection.

Working tips are smoothly rounded of, therefore no danger of perforation.



UG-1474

Hose connection inside diam. 11 mm curved stainless steel.

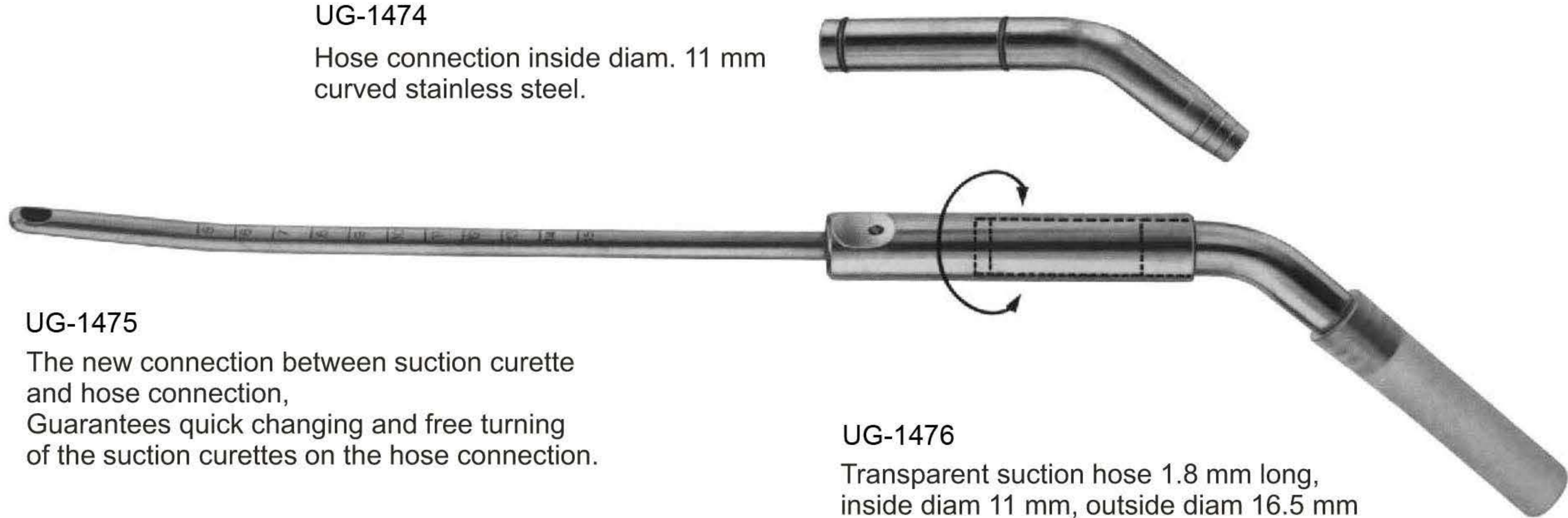

UG-1475

The new connection between suction curette and hose connection, Guarantees quick changing and free turning of the suction curettes on the hose connection.

UG-1476

Transparent suction hose 1.8 m long, inside diam 11 mm, outside diam 16.5 mm can be sterilized in an autoclave at 1 bar overpressure (120 C)

UG-1477

Strainer for tissues, plastic, for single use only, to be used for histopathological examination.



Gynaecological Instruments

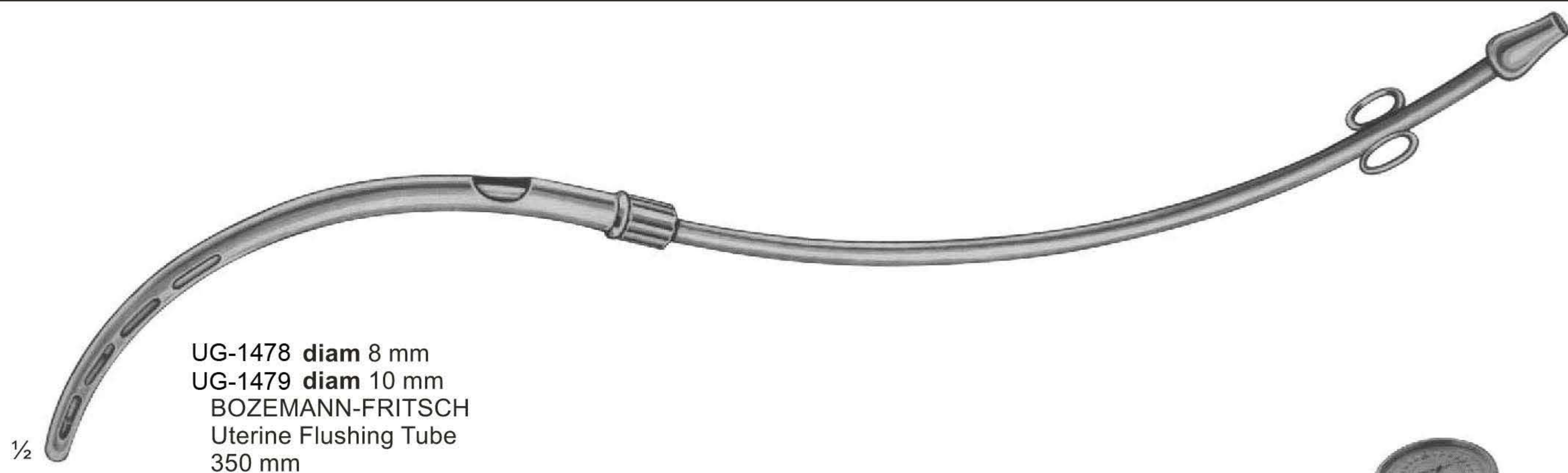

UG-1478 diam 8 mm
 UG-1479 diam 10 mm
 BOZEMANN-FRITSCH
 Uterine Flushing Tube
 350 mm

1/2

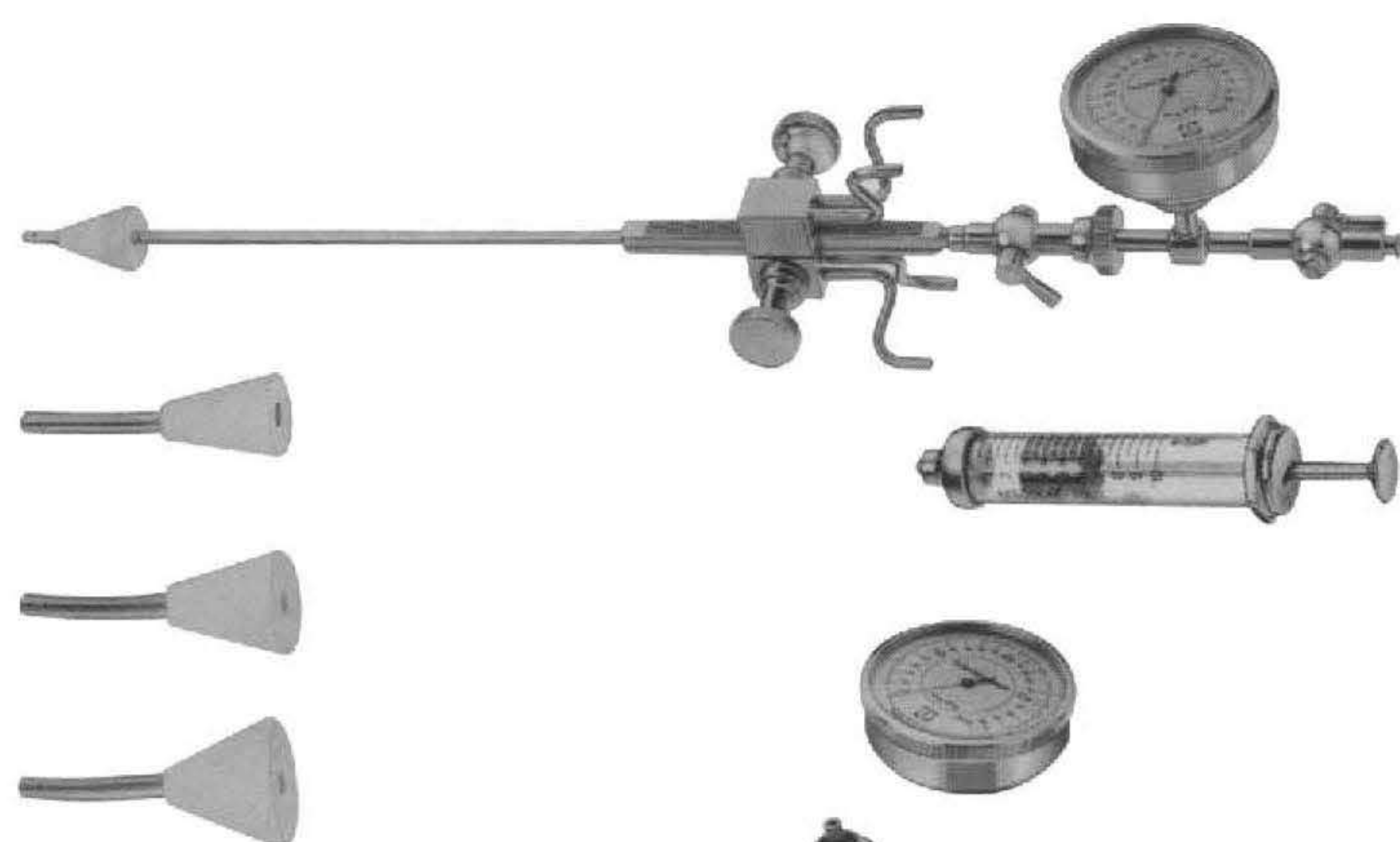

UG-1480
 SCHULZE
 Salpingograph, for utero-salpingography
 in wooden case, consisting of:
 Manometer, Connection, Uterine canulla
 with tap, Cone S.M.L.,
 Record Syringe 10 cc, Luer lock mount.



UG-1481
 SCHULZE
 Salpingograph, equipment
 without manometer.

Obstetrics-Pelvimeters

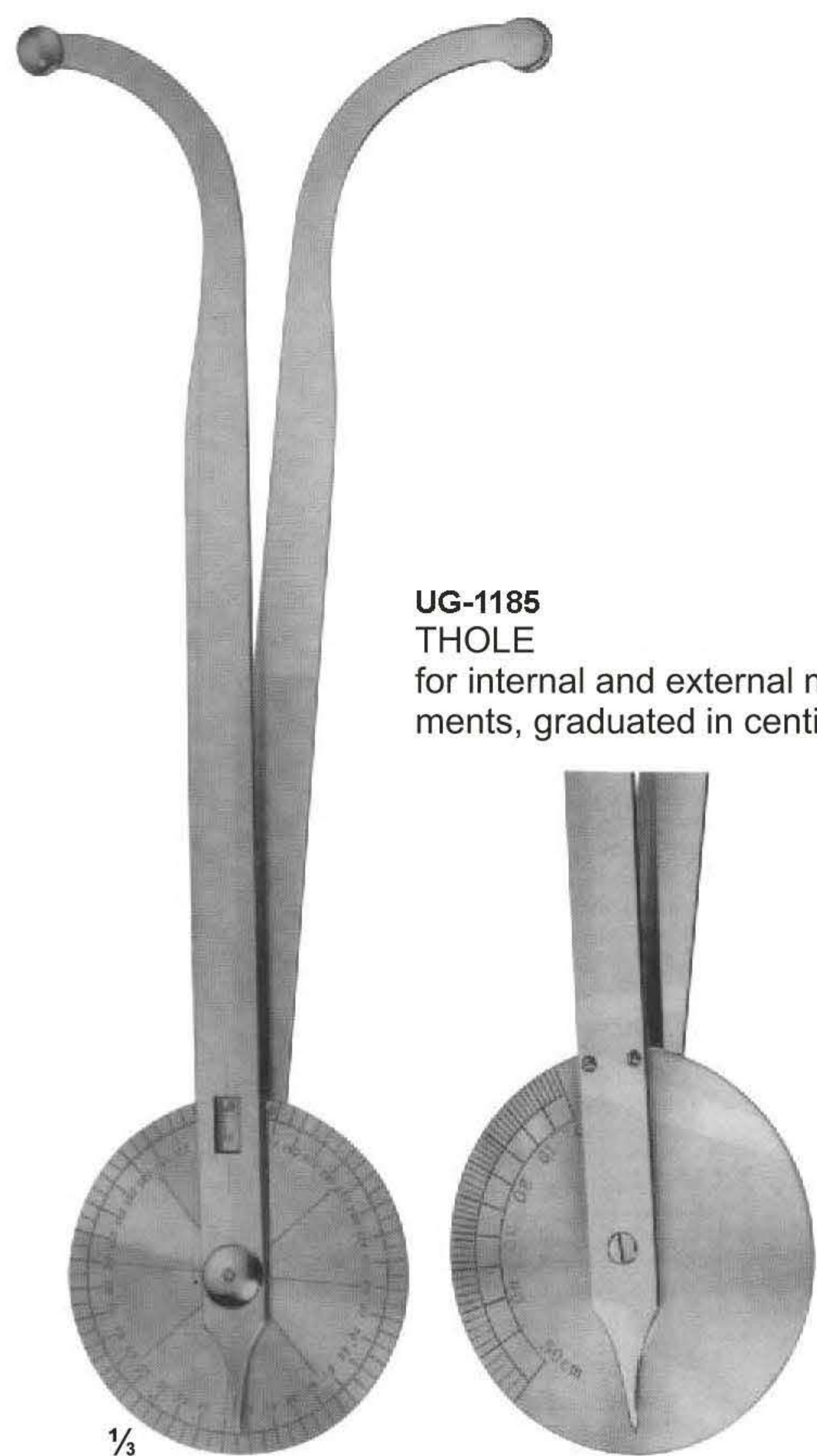

**UG-1185
THOLE**
for internal and external measurements, graduated in centimeters

1/3

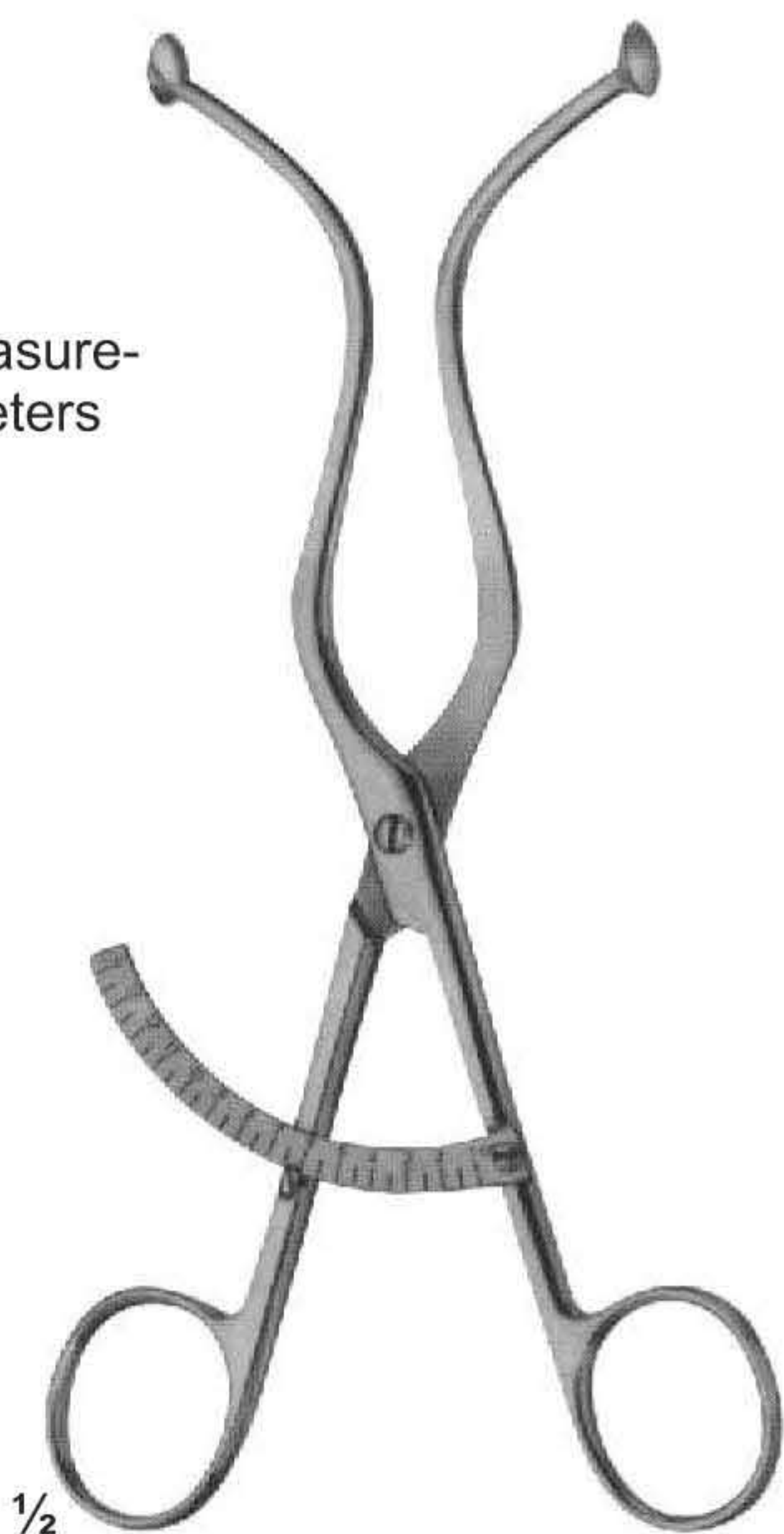

**UG-1186
DE LEE**
graduated in centimeters and inches

1/2



**UG-1187
COLLIN**
graduated in centimeters

1/3

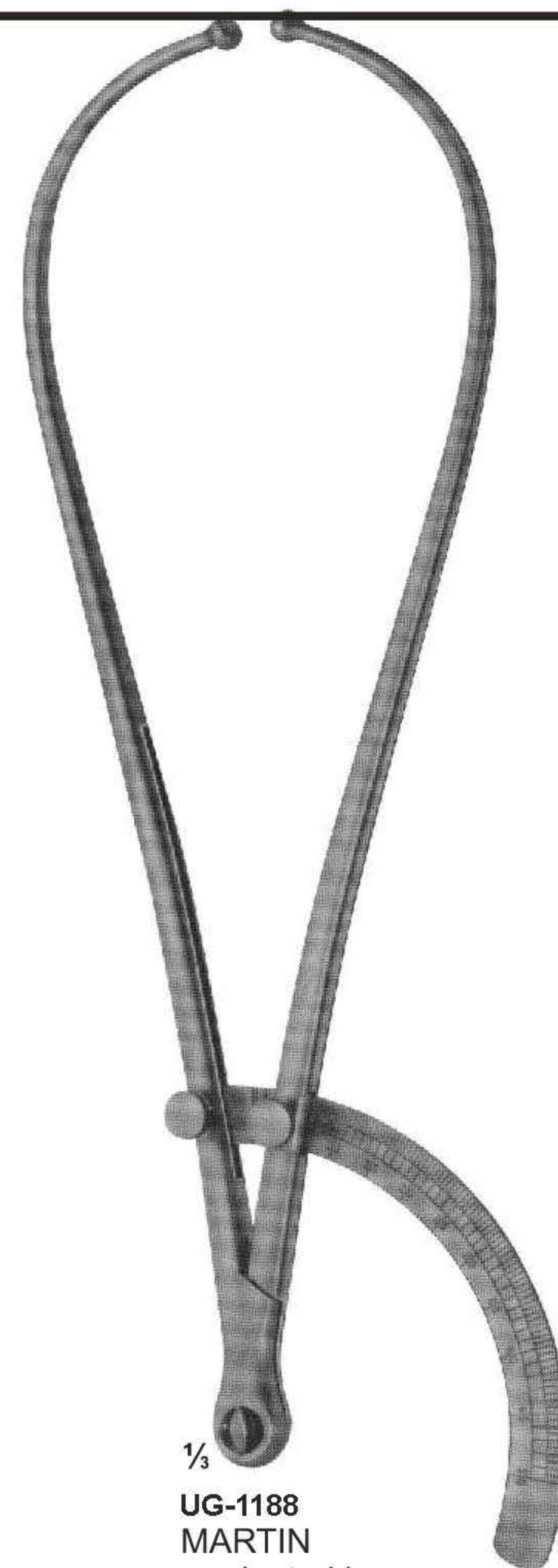

**UG-1188
MARTIN**
graduated in centimeters

1/3



1/3



**UG-1190
COLLIN**
graduated in centimeters

for internal measurements between symphysis and promontory

The additional straight arm can be replaced. The pelvimeter with straight arm is used for localisation of the portio vaginalis uteri and of vaginal metastasis.



1/3

**UG-1191
BREISKY**
graduated in centimeters

Obstetrics-Pelvimeters

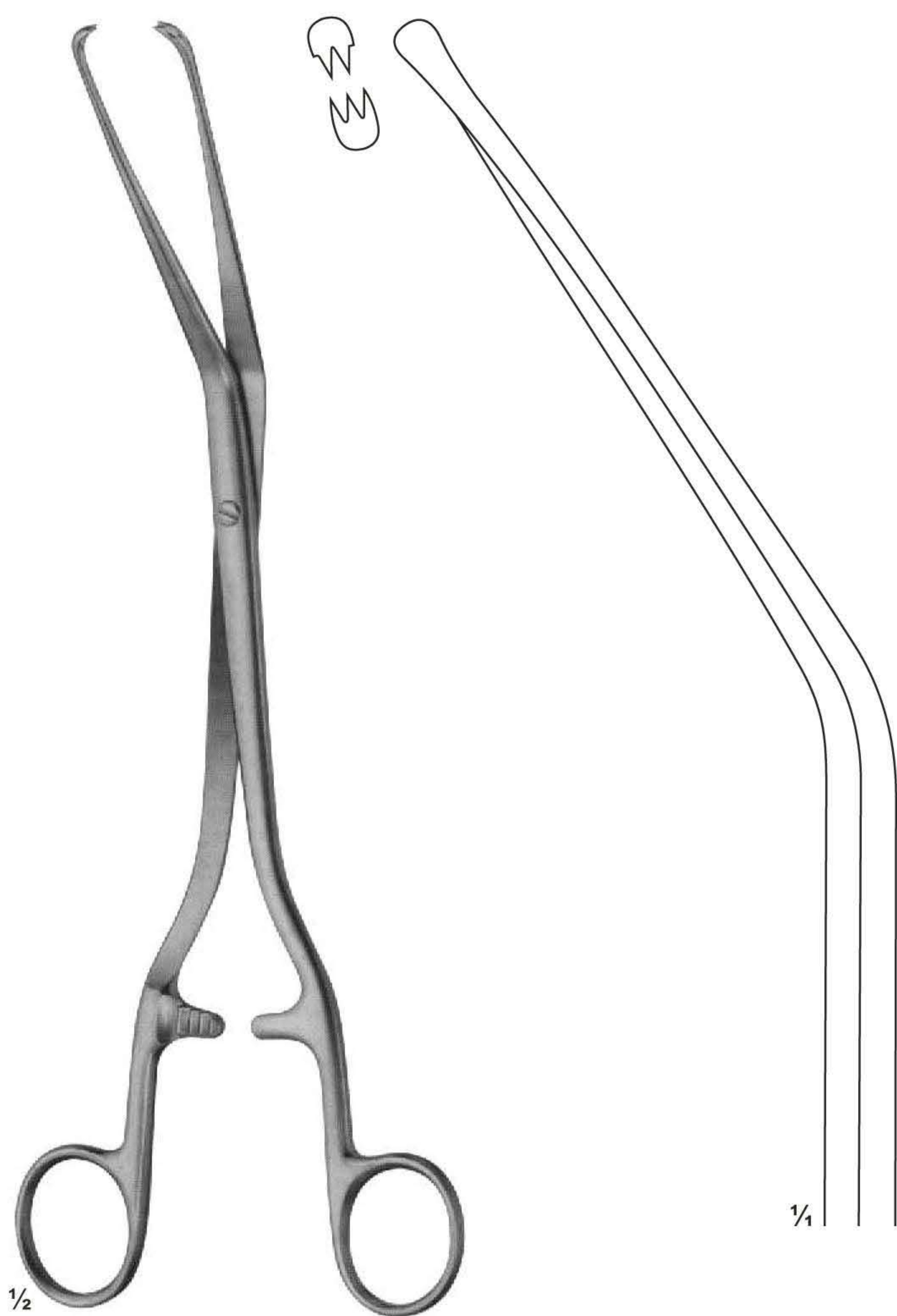

UG-1193
HERFF
puncturing forceps
225 mm



UG-1194
IOWA
puncturing forceps
260 mm

Scissors of Obstetrics, Umbilical cord clamp



1/2
UG-1197
SCHUMACHER
 Umbilical cord
 scissors
 155 mm



1/2
UG-1198
 Umbilical cord
 scissors
 105 mm



1/2
UG-1200
BRAUN-STADLER
 Episiotomy Scissors

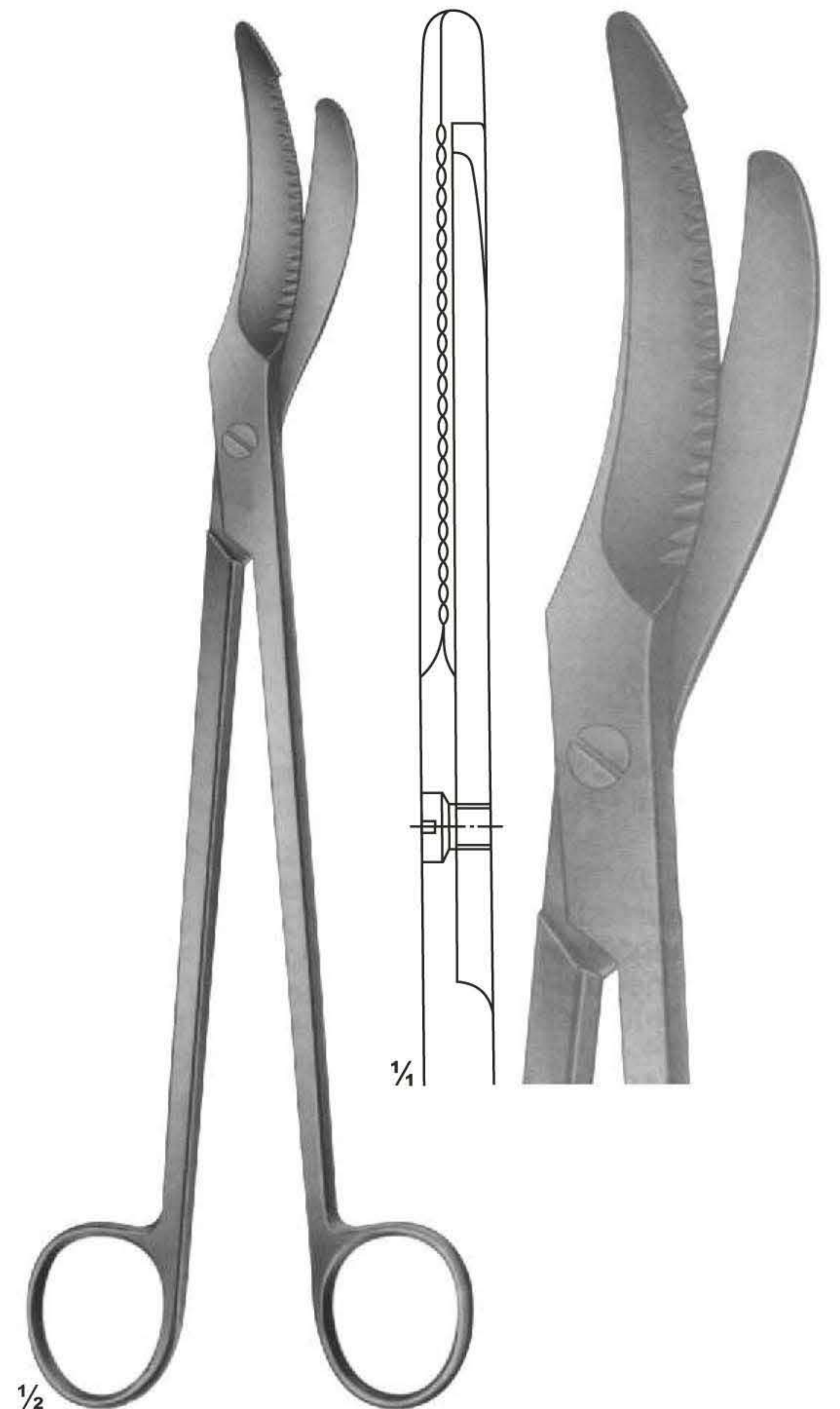

1/2
UG-1202
 Episiotomy Scissors
 240 mm

Obstetrics Forceps

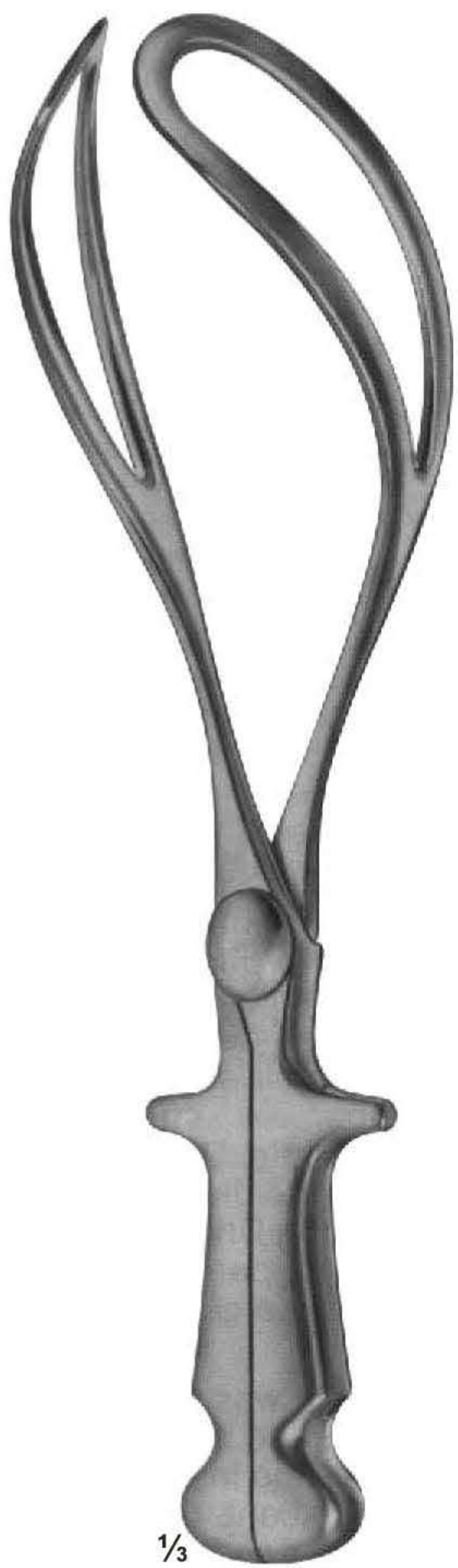

UG-1203
Obstetrics Forceps

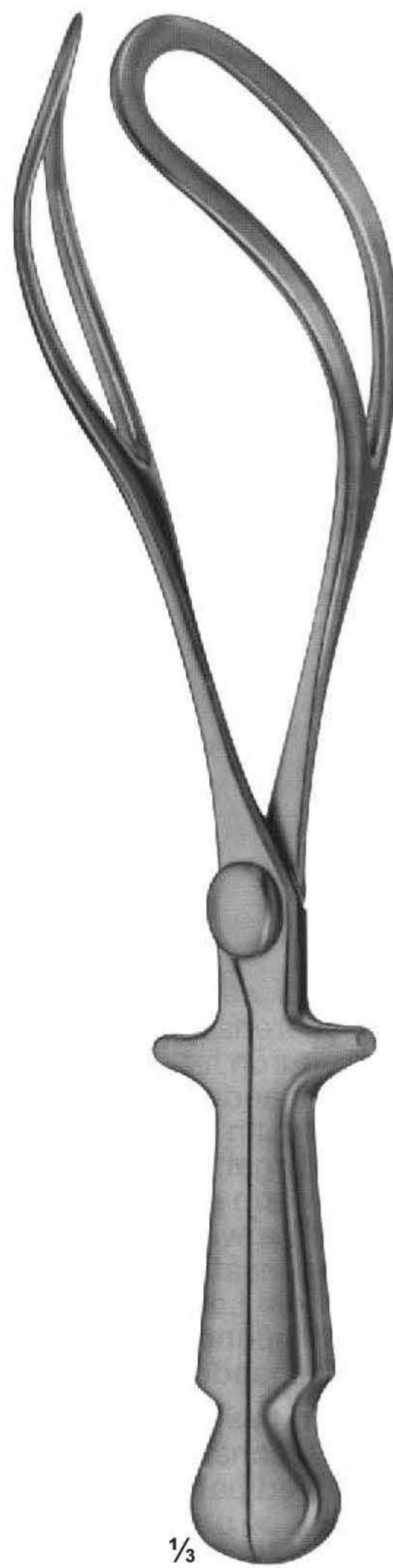

UG-1204
Obstetrics Forceps



UG-1206
SIMPSON-BRAUN

Obstetrics Forceps



UG-1208
SIMPSON-BRAUN

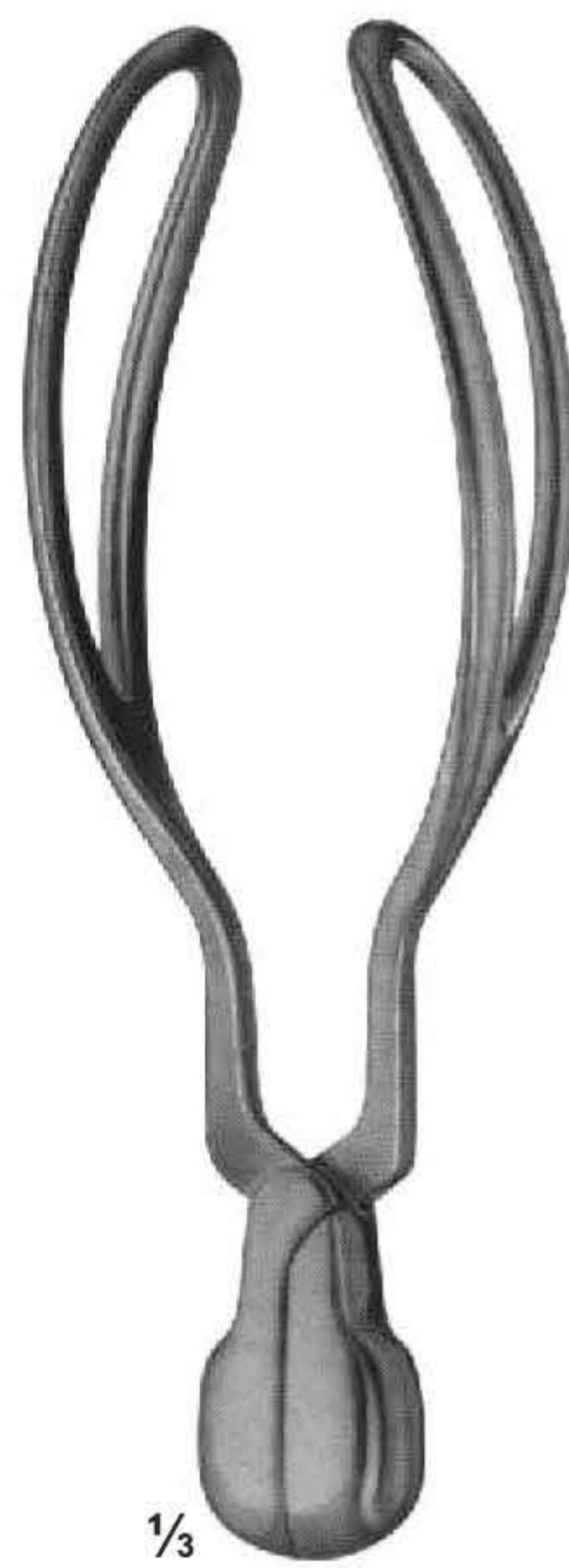

UG-1210
SIMPSON

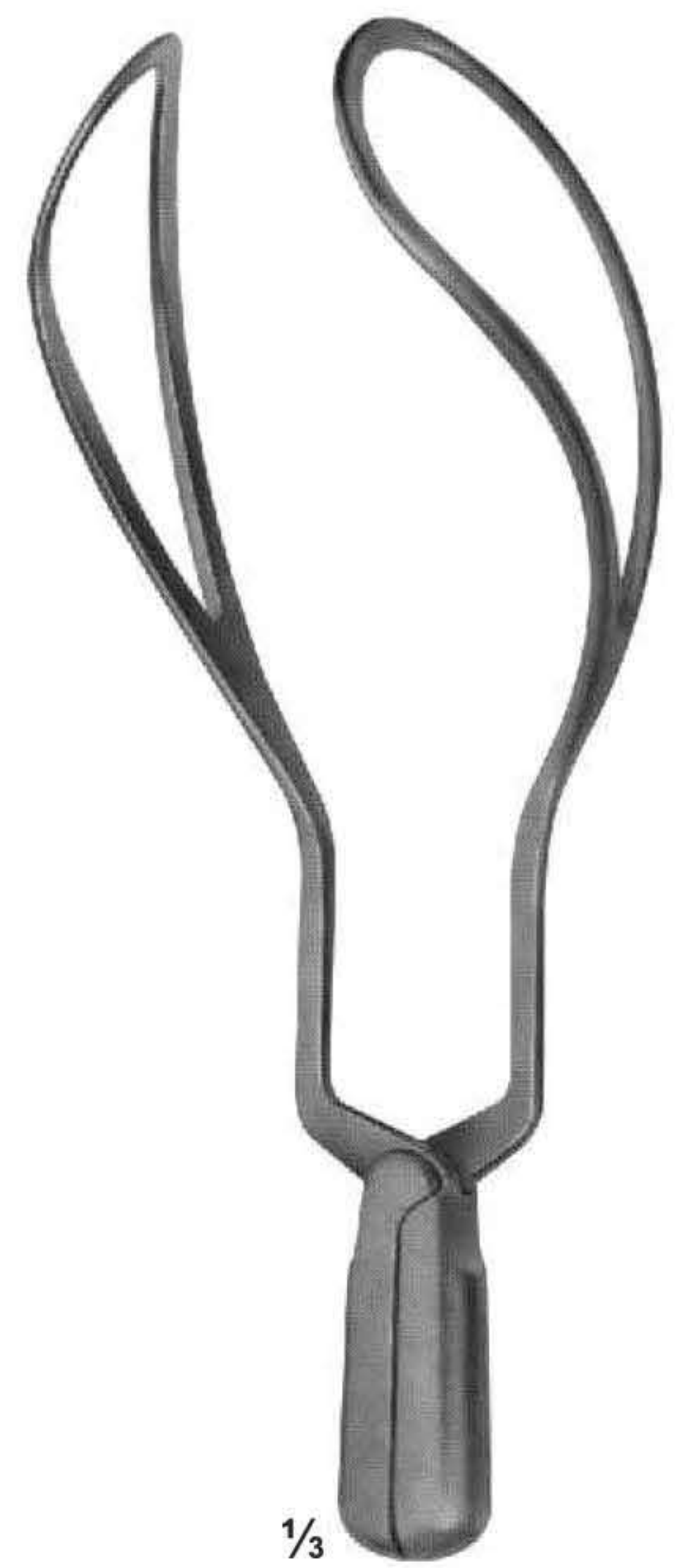

UG-1211
WRIGLEY

Obstetrics Forceps

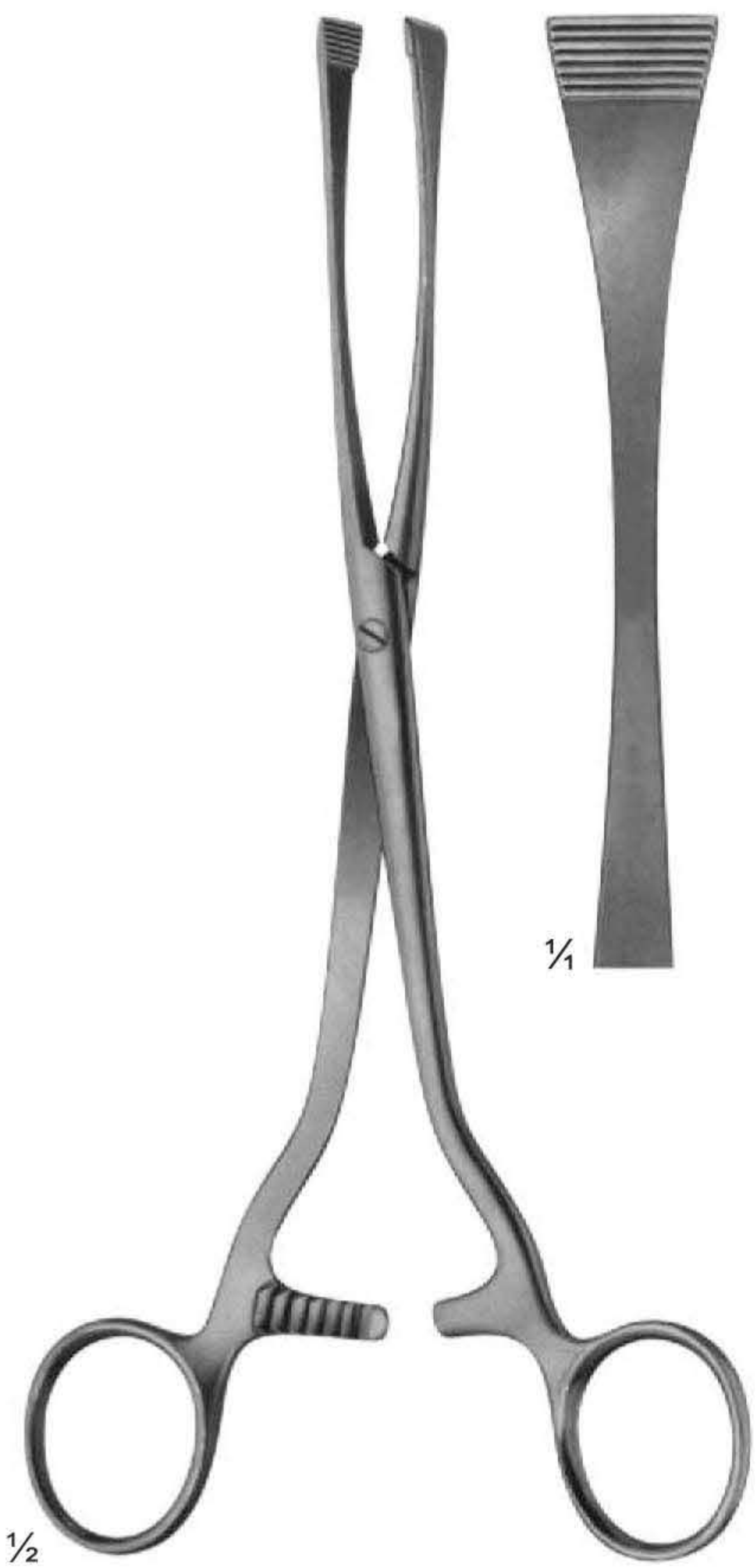

UG-1214
GREEN-ARMYTAGE
 Caesarean section haemostatic
 forceps, for edges of the transverse
 incision in the lower segment

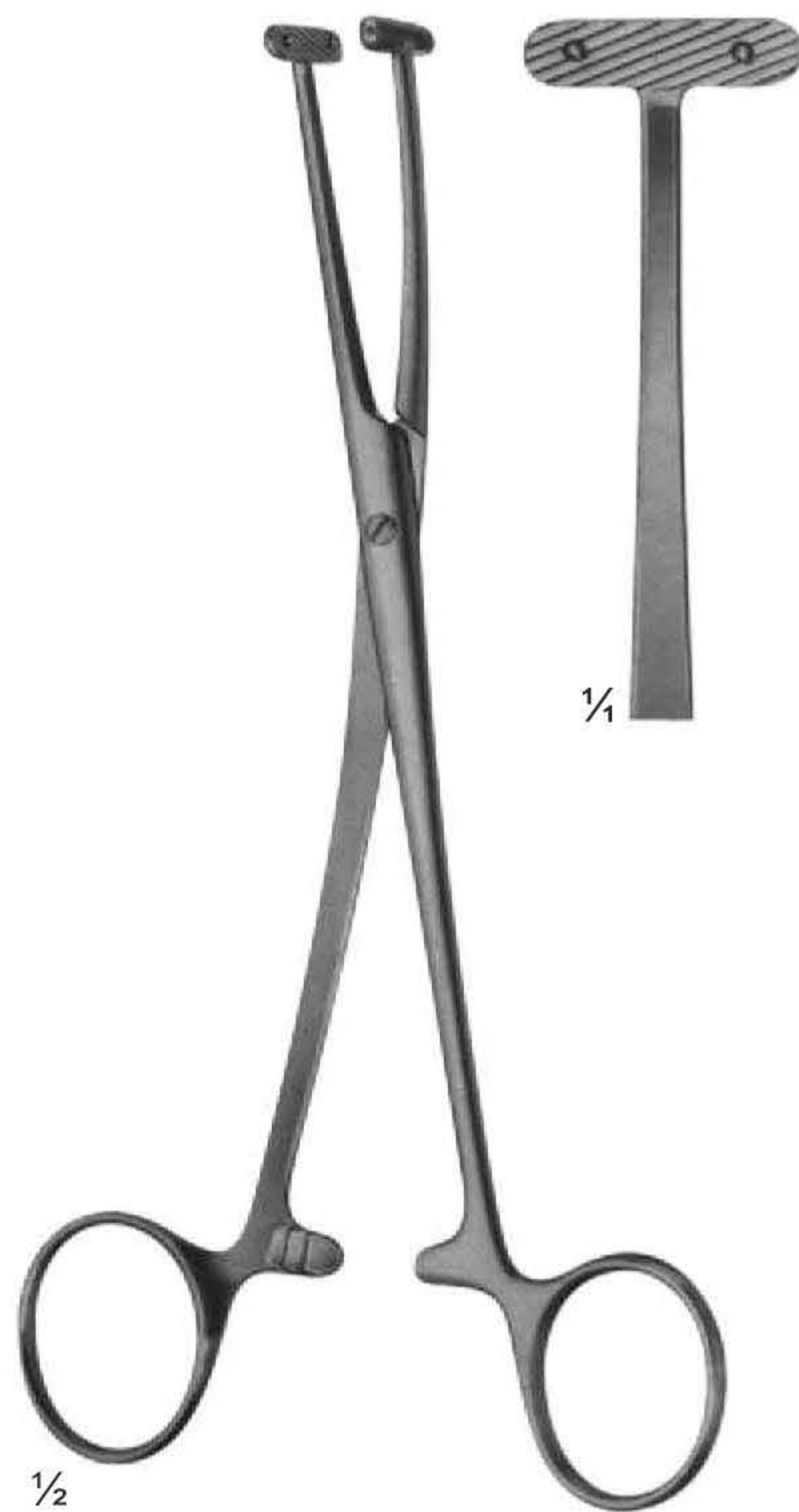

UG-1216
WILLETT
 Scalpel Flap forceps

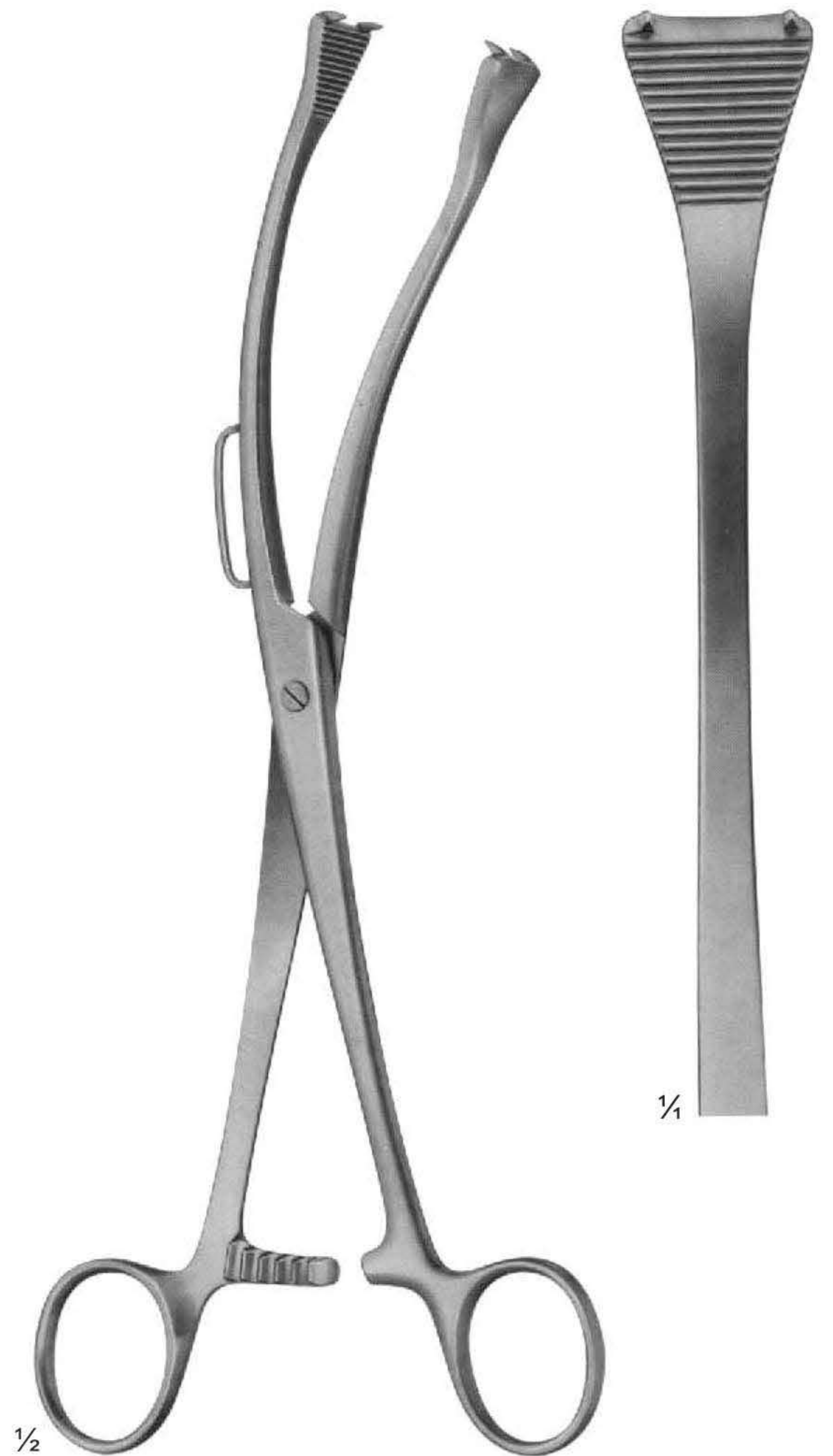

UG-1217
GAUSS
 Scalpel Flap forceps

Obstetrics-Placenta and Ovum Forceps

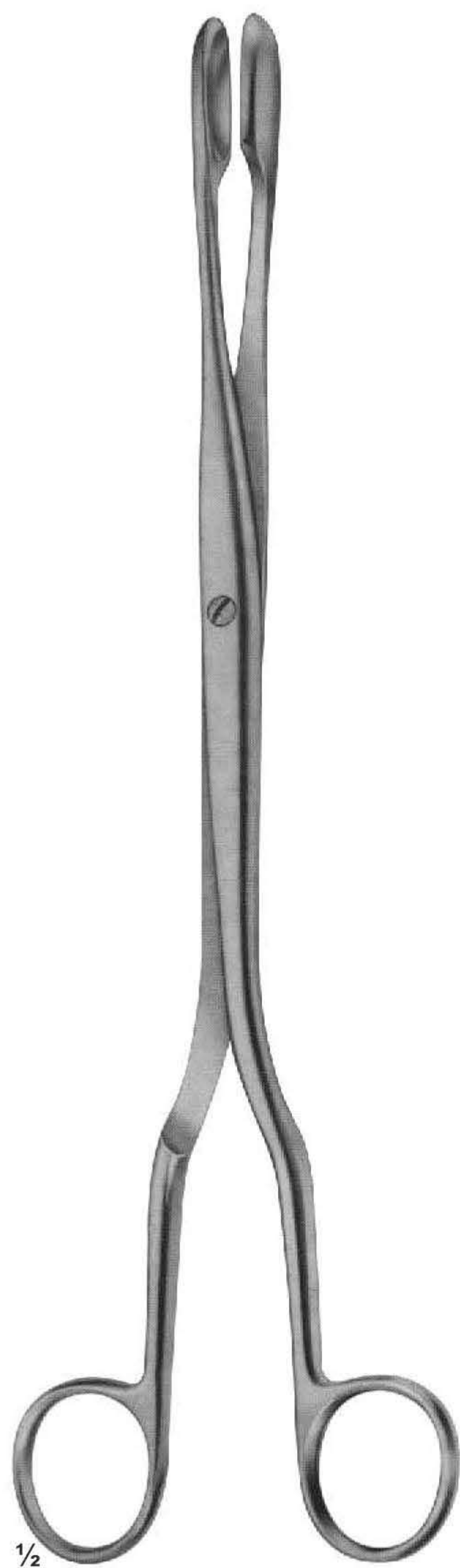

UG-1220
WINTER



UG-1222
WINTER

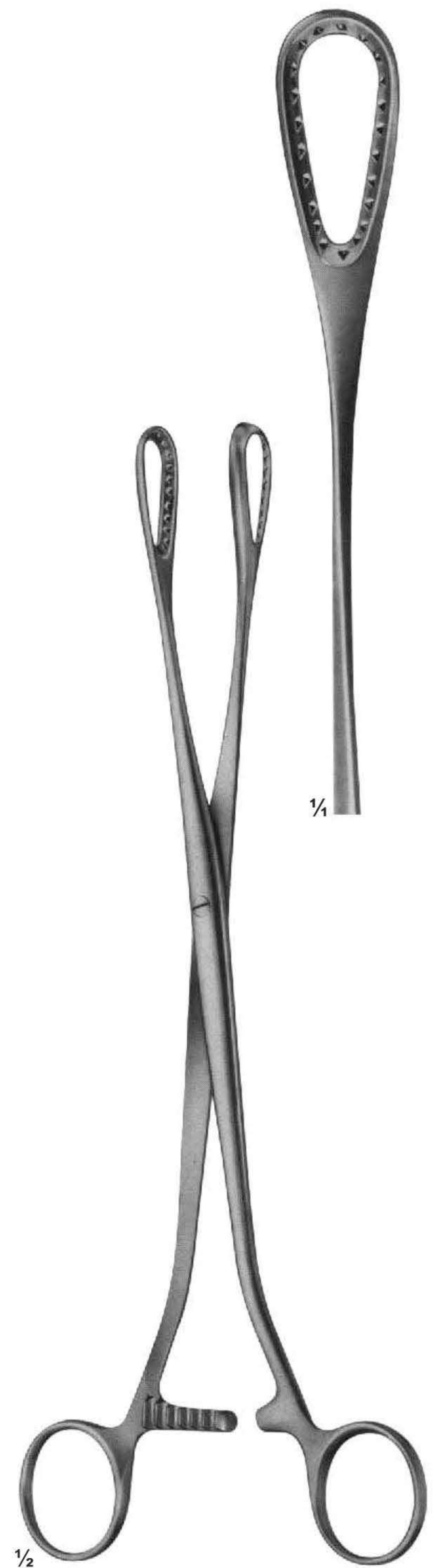

UG-1227
SAENGER

Obstetrics-Placenta and Ovum Forceps

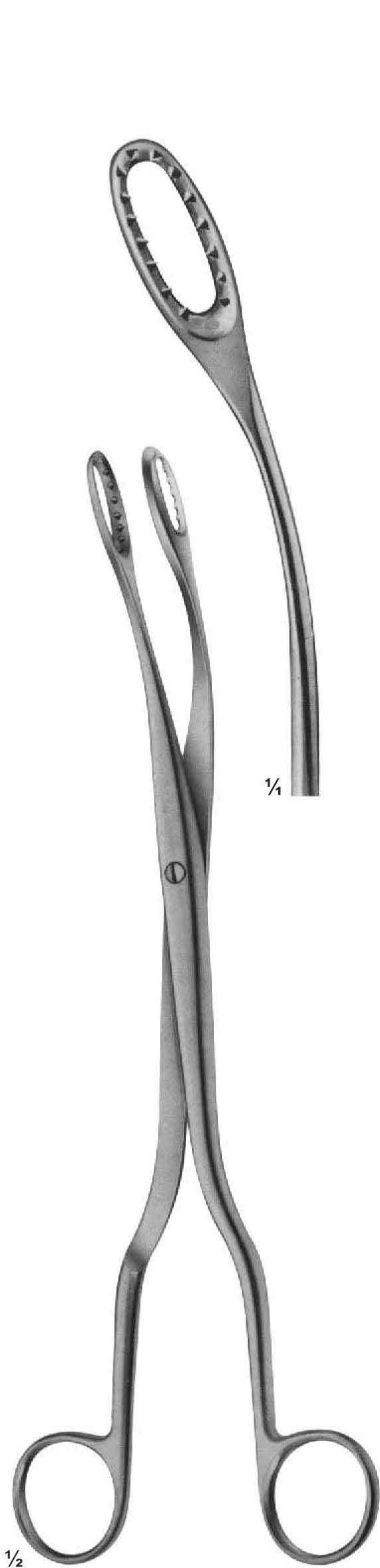

UG-1228
SAENGER
285 mm

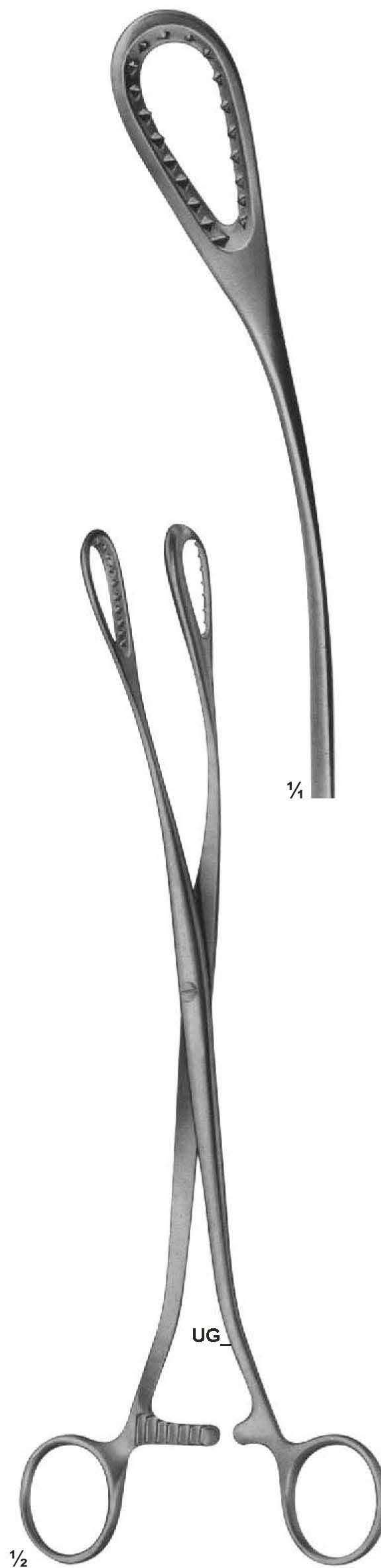

UG-1229
SAENGER
285 mm

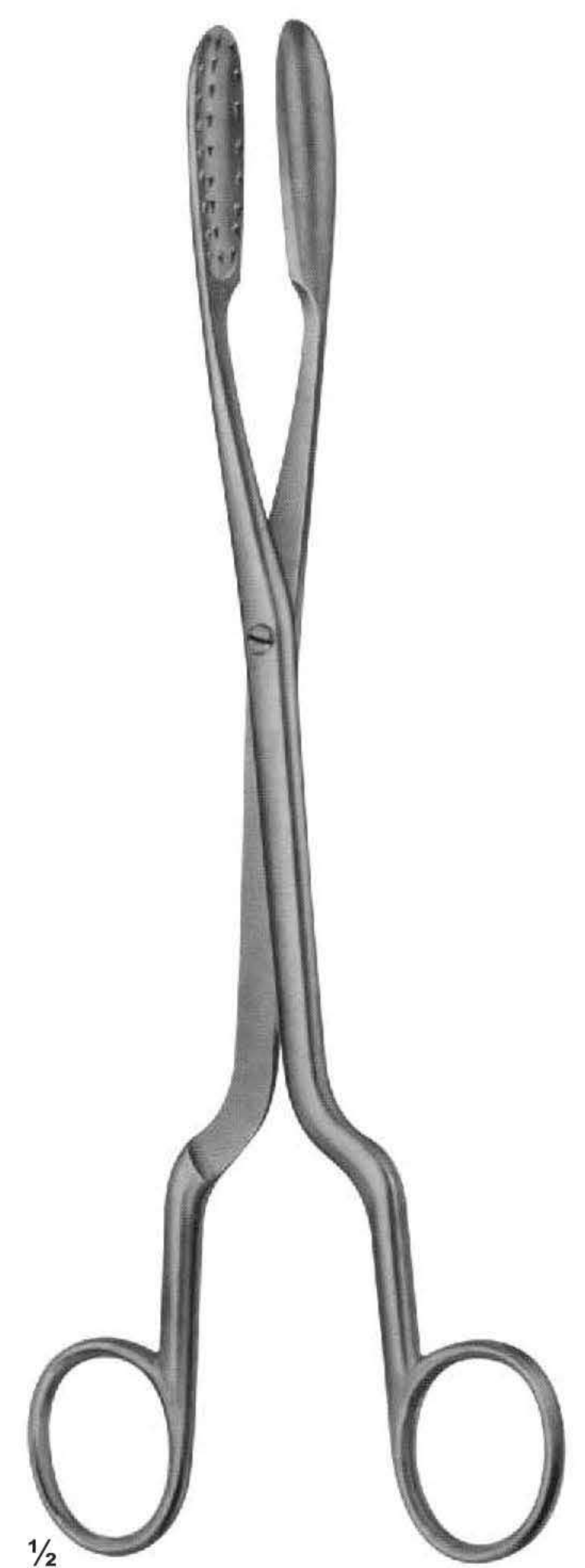

UG-1230
LEWKOWIZ
245 mm

Obstetrics-Placenta, Ovum and Cranioclast, Basiotribe Forceps

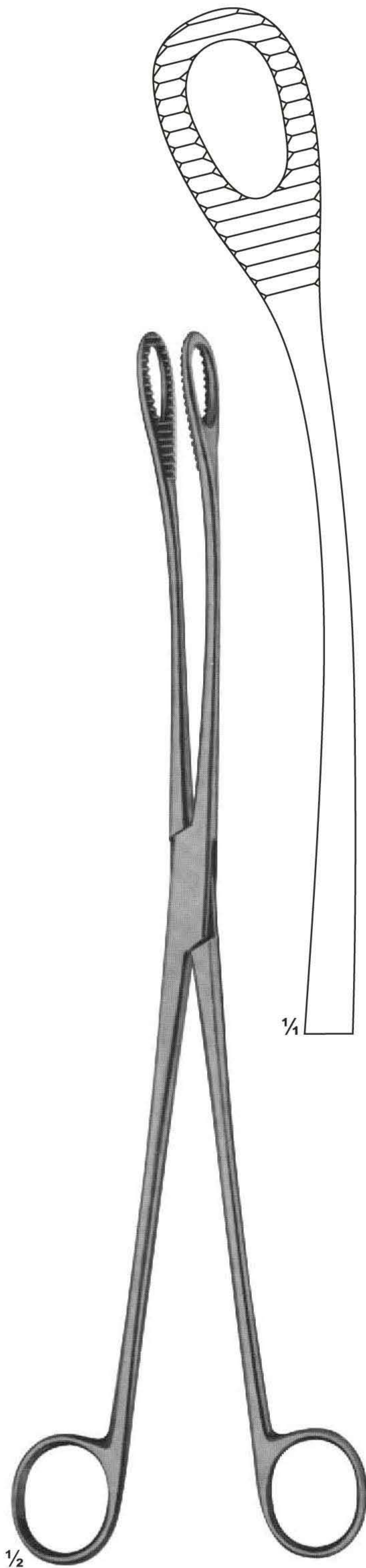

UG-1233
KELLY
320mm



UG-1234
SMELLIE
Perforator
270mm



UG-1235
BRAUN
Cranioclast
420mm

Tracheal Tubes with inner tubes



1/2

UG-1236
UECKERMANN-DENKER
Cryothyrotomy trocar
with silver cannula
130mm

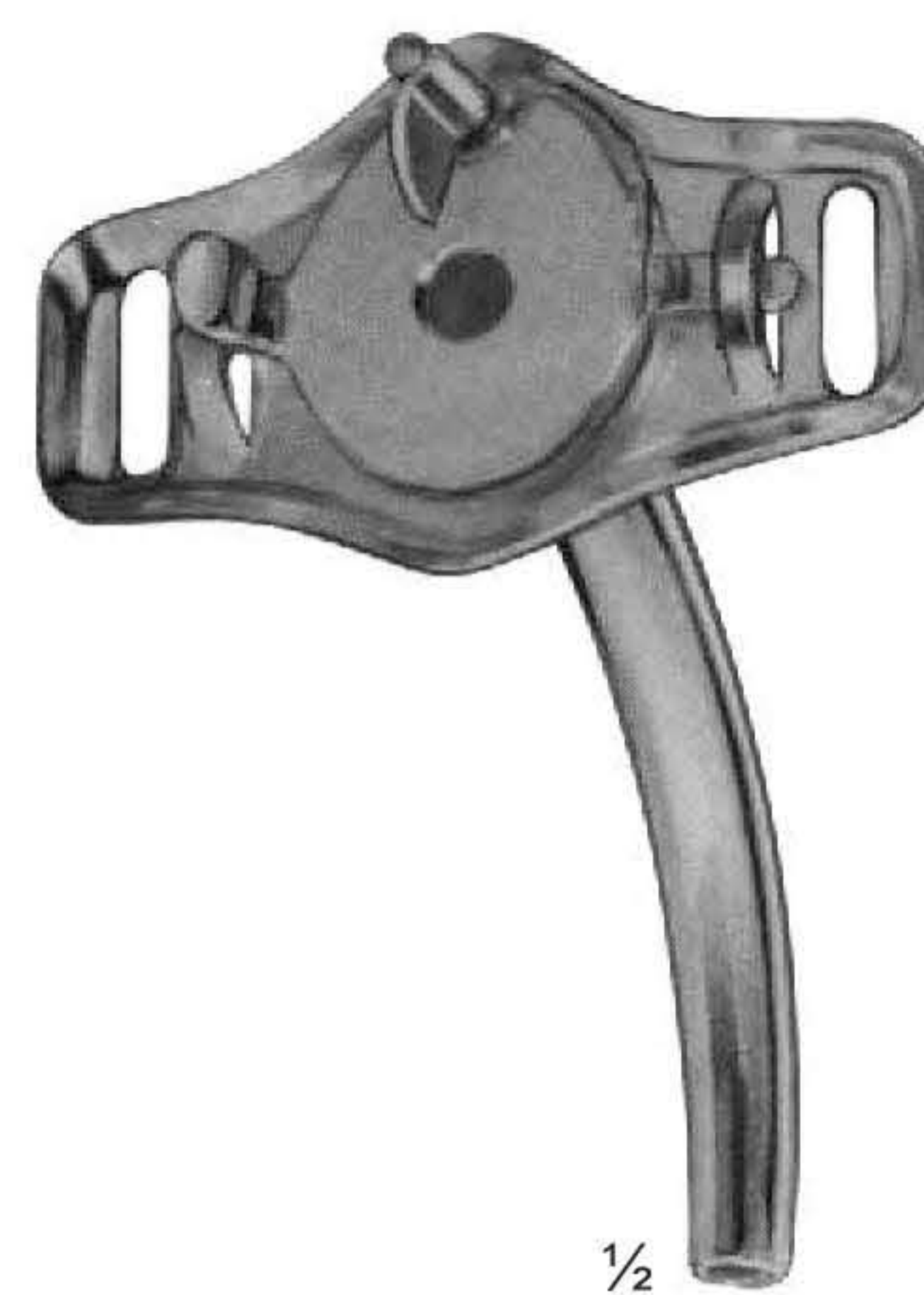

1/2

UG-1237
LUER
German silver



1/2

UG-1238
JACKSON
German Silver



1/2

UG-1244
JACKSON
German Silver

Tound-and Tracheal Hooks and Dilators



UG-1259
BOSE
165 mm



UG-1260
BOSE
165 mm



UG-1261
180 mm

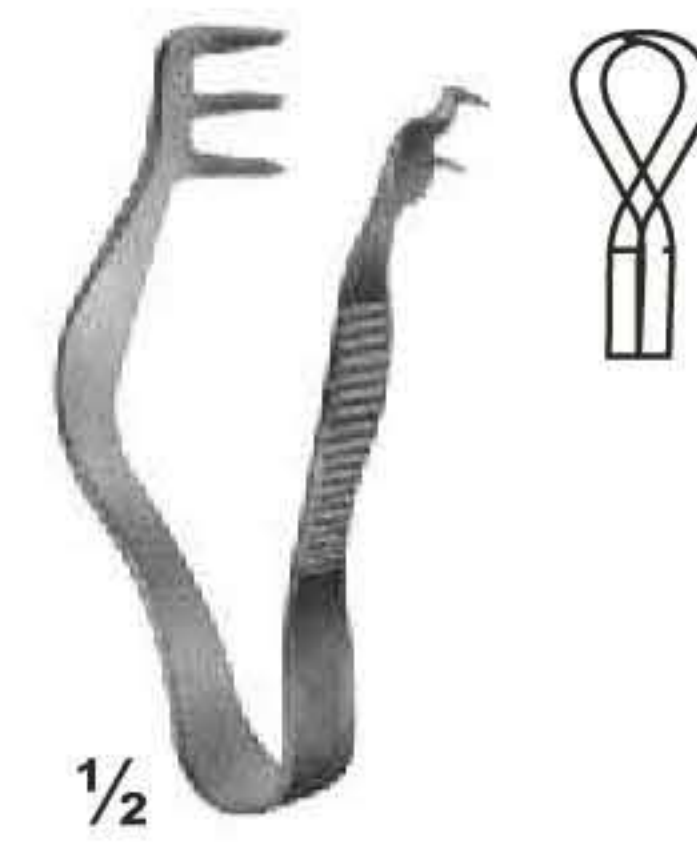

UG-1270
FINSEN
50 mm

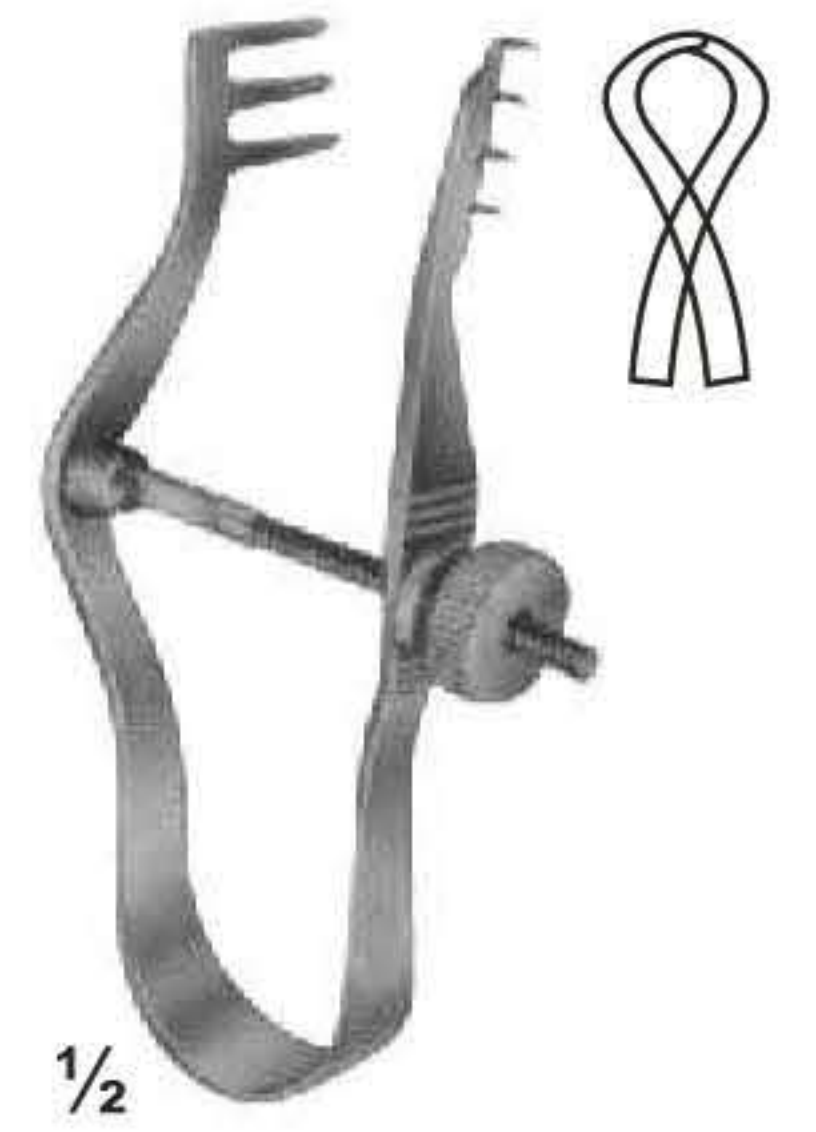

UG-1271
FINSEN
70 mm



UG-1273
TROUSSEAU
120 mm



UG-1274
LABORDE
125 mm

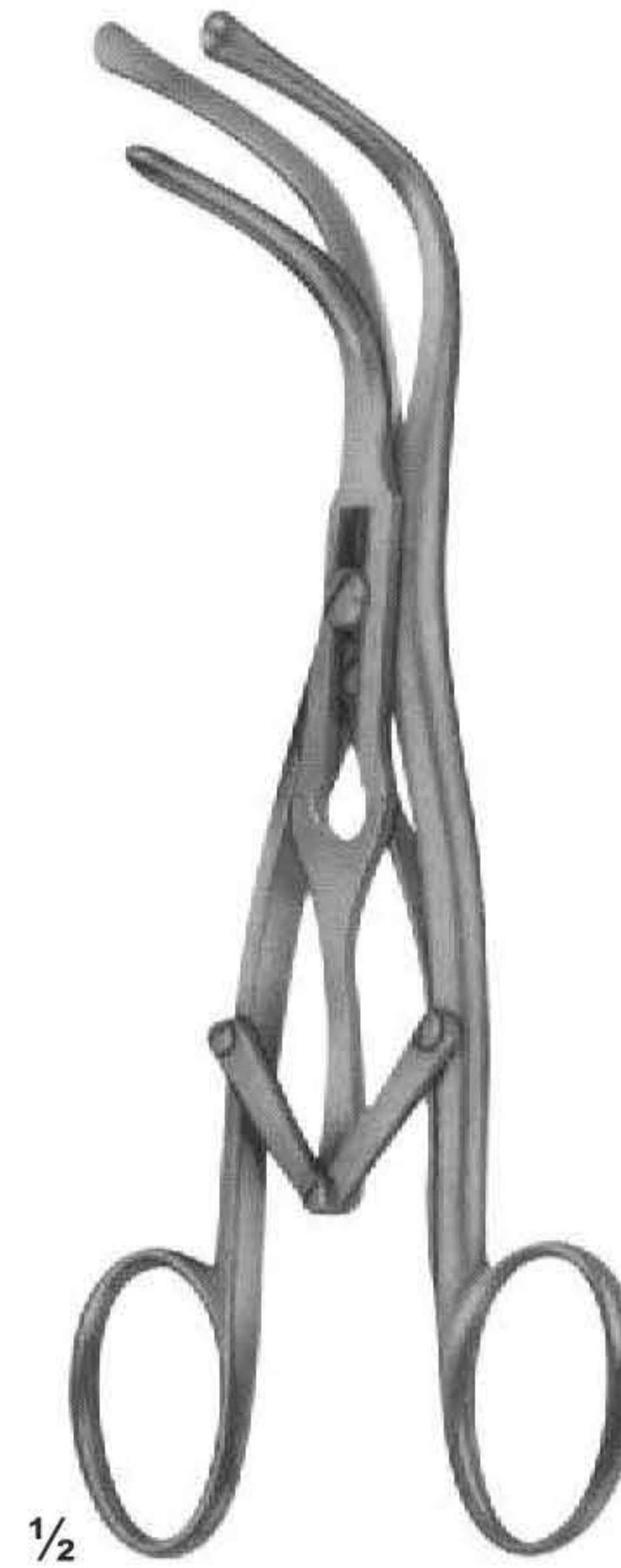

UG-1275
LABORDE
strong pattern
135 mm



UG-1276
Cleaning Brush
for tracheal tubes
285 mm

Irrigating Cannulae, Embolus Grasping Forceps, Dilators



UG-1279
SCHMID
Vessel irrigating cannulae,
malleable, silver plated
150 mm

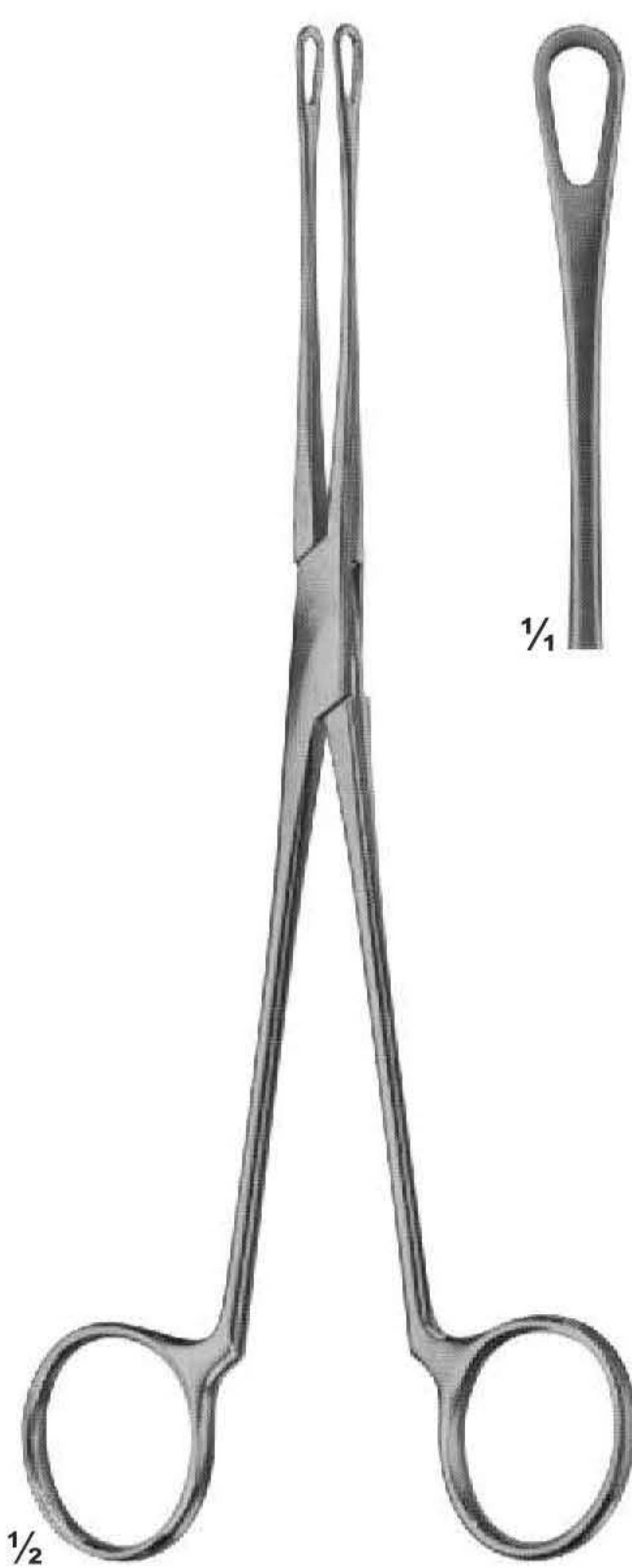

UG-1281
BLAKE
Embolus grasping
forceps
205 mm



UG-1283
DE BAKEY
Vascular dilators,
malleable
190 mm

Irrigating Cannulae, Embolus Grasping Forceps, Dilators

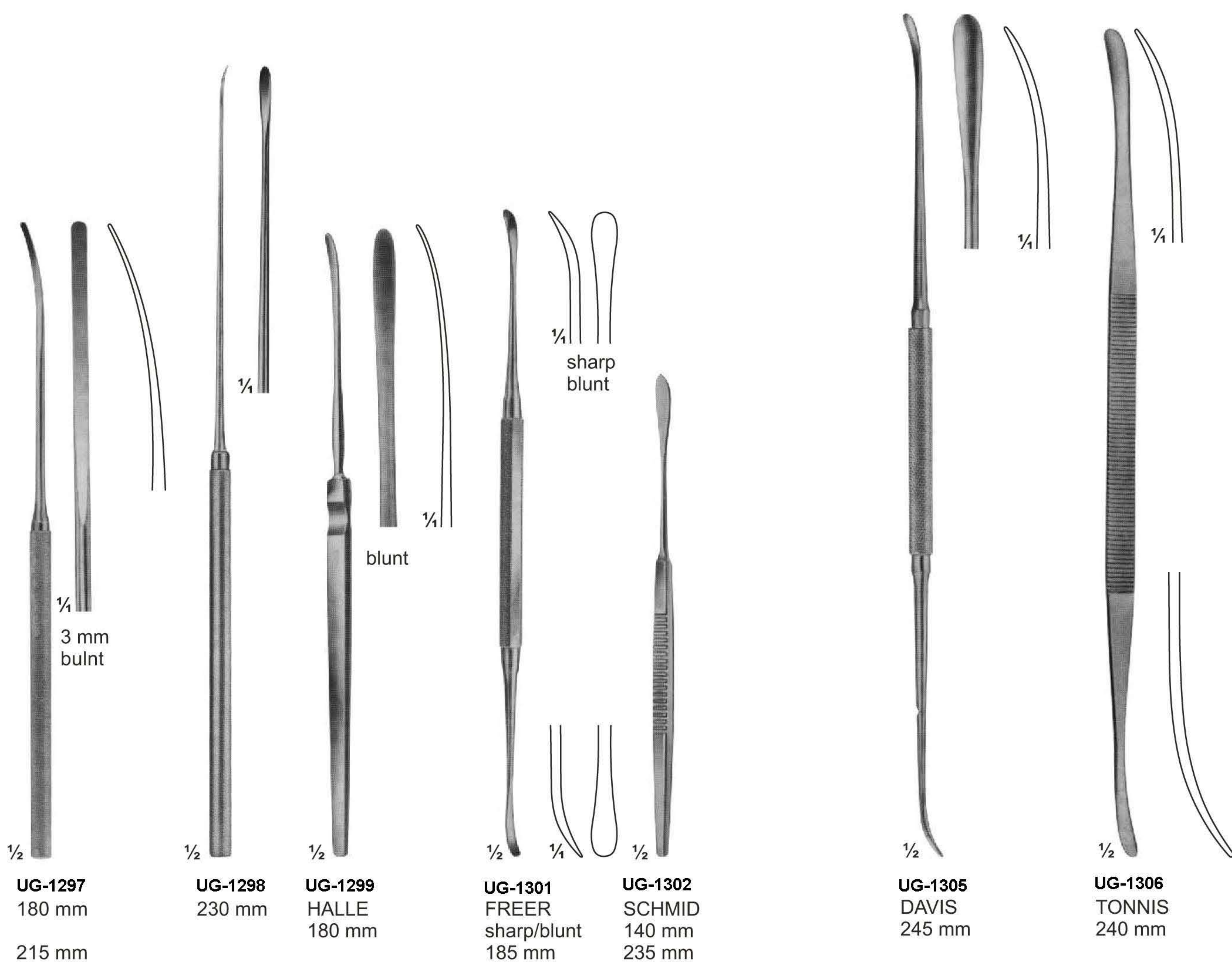

Irrigating Cannulae, Embolus Grasping Forceps, Dilators



1/2

UG-1307
Endarterectomy strippers
550 mm



1/2

UG-1308
Handle for
110 mm



1/2

UG-1309
RUMEL-BELBONT
325 mm

UG-1310
Guide only

Biopotome and Aortic Dilators

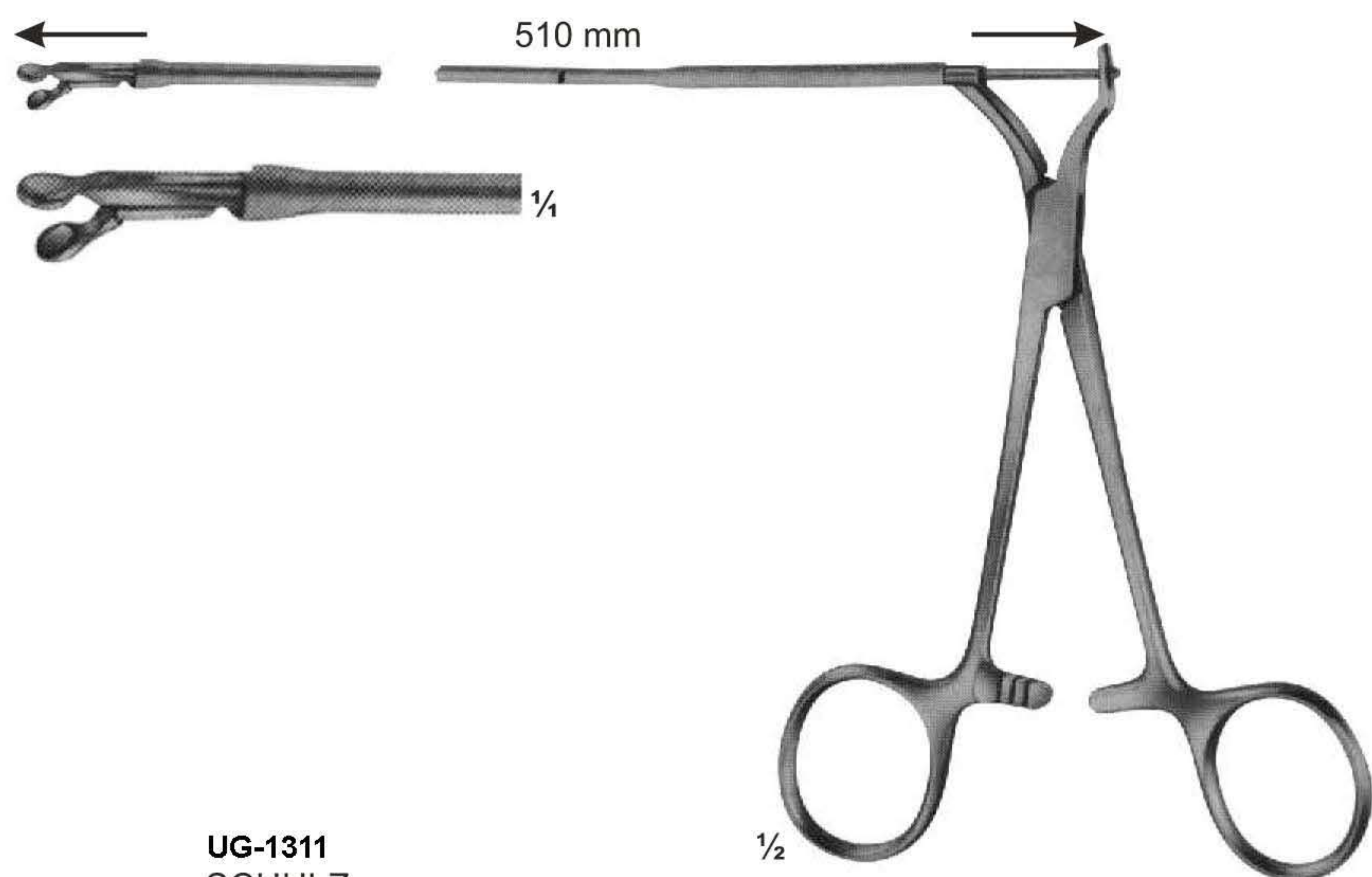

UG-1311
SCHULZ
 Biopotome, mit flexiblem Schaft, 510 mm lang,
 with round jaws 3 mm diam.

Biopsy forceps, for biopsy from the right atrium
 through cava juglaris, prior to heart implantations.

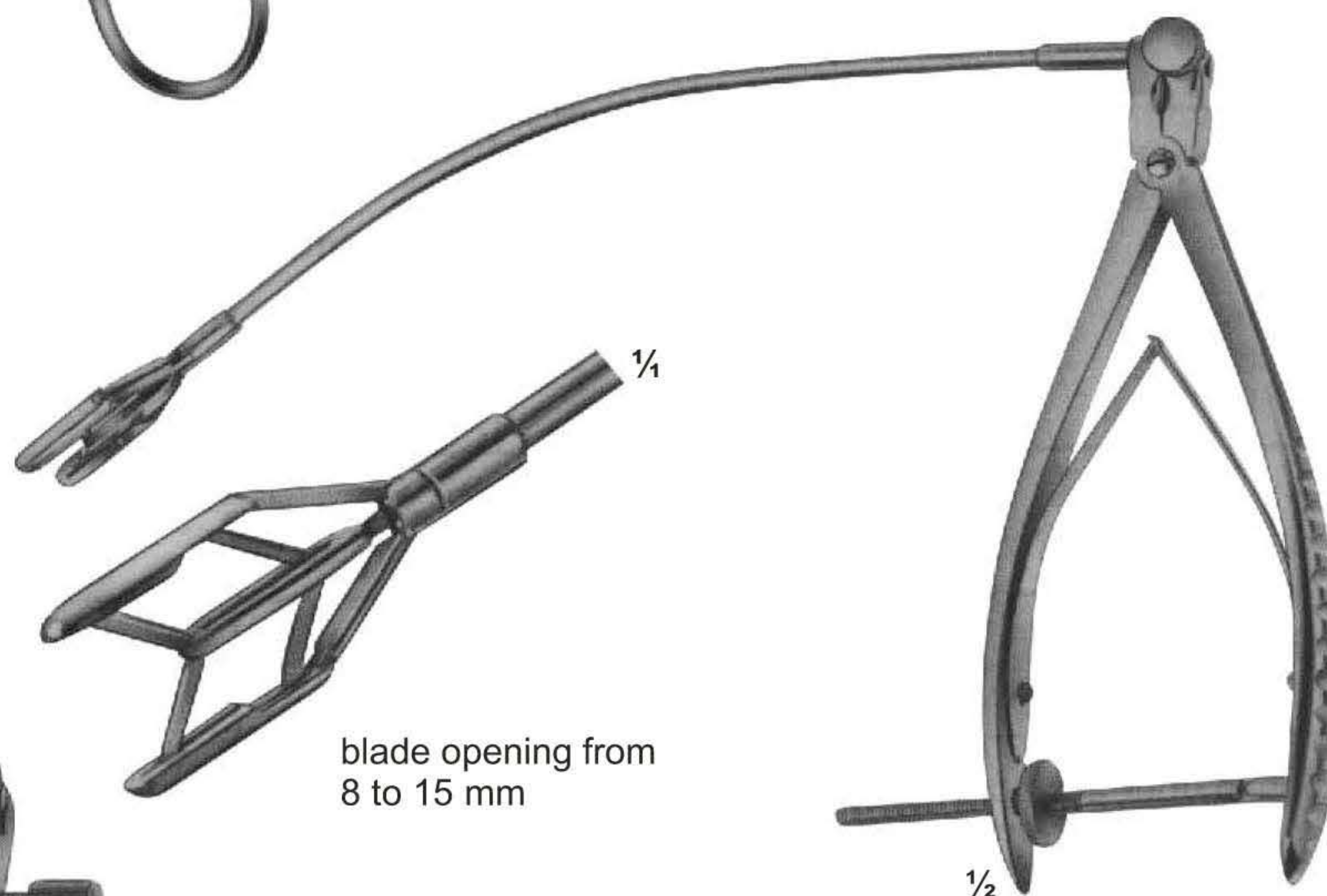

UG-1313
COOLEY
 Dilator for
 mitral valve
 for children

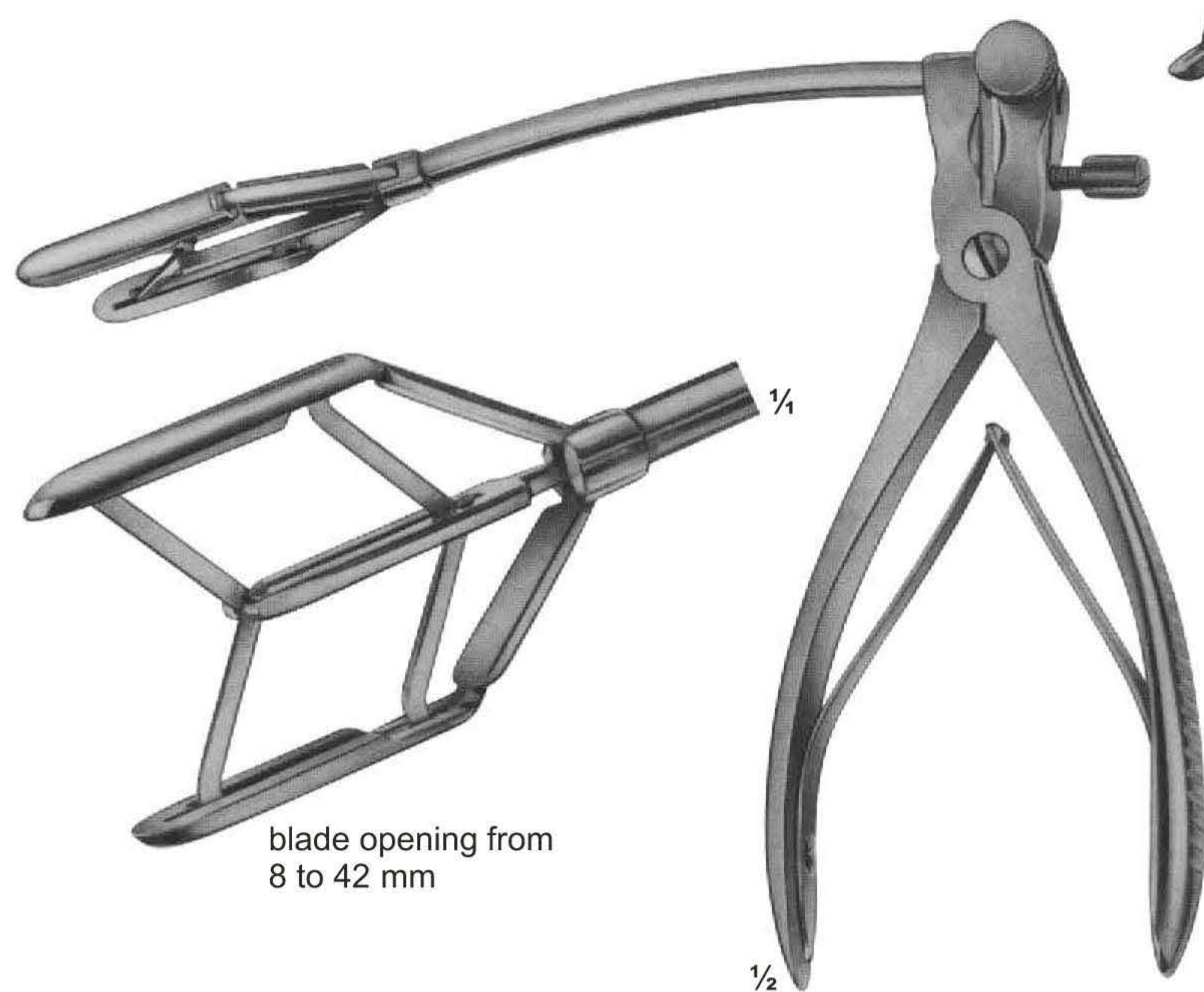

UG-1312
TUBBS
 Dilator for
 mitral valve

Biopotome and Aortic Dilators

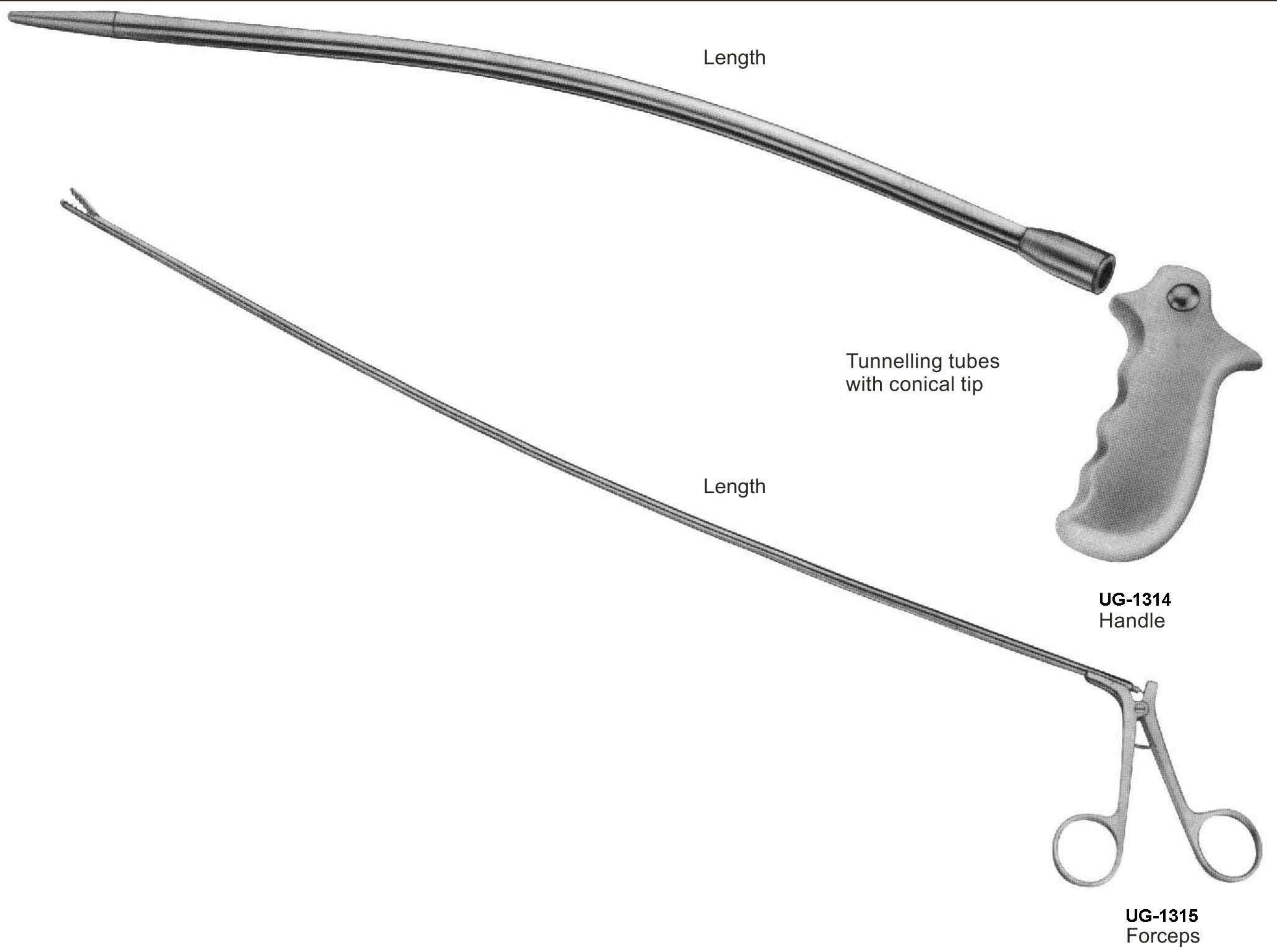

Ultra-Light-Forceps

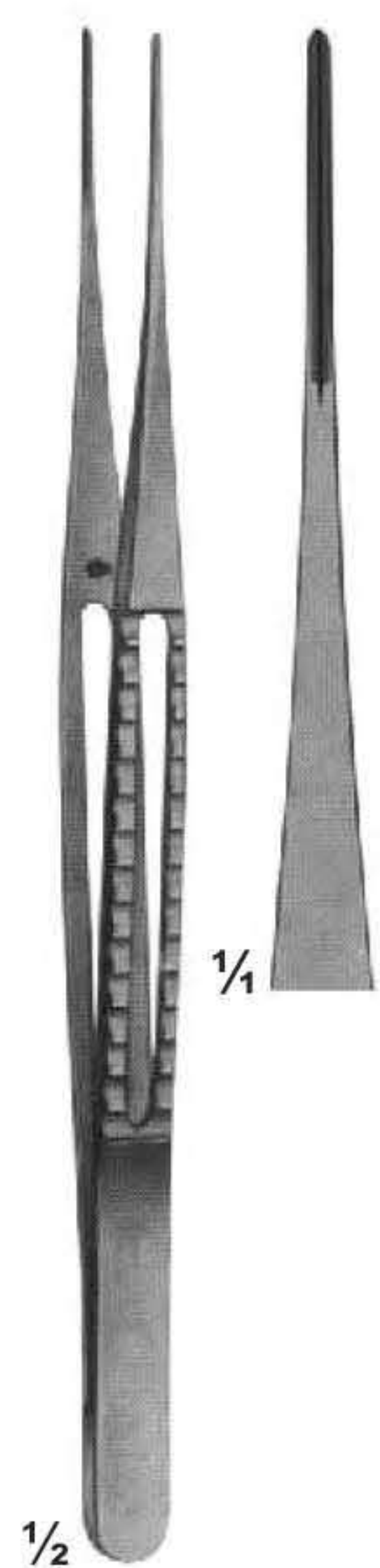

$\frac{1}{2}$
UG-1318
 Width of jaws
 1,5 mm
 Length
 150mm

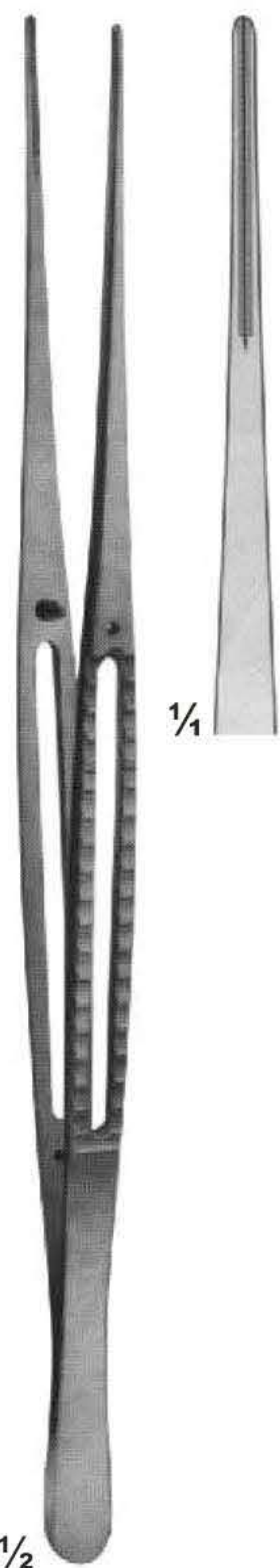

$\frac{1}{2}$
UG-1319
 1,5 mm
 200 mm



$\frac{1}{2}$
UG-1320
 1,5 mm
 240 mm



$\frac{1}{2}$
17-154
 1,5 mm
 300 mm

Ultra-Light-Forceps



UG-1322
DE BAKEY
150 mm
300 mm



UG-1323
DE BAKEY
150 mm 200 mm
300 mm 240 mm



UG-1325
DE BAKEY
150 mm 200 mm
300 mm 240 mm

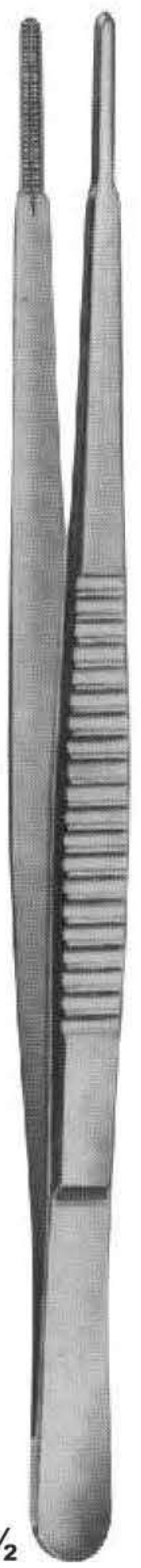

UG-1330
DE BAKEY
200 mm
300 mm 240 mm

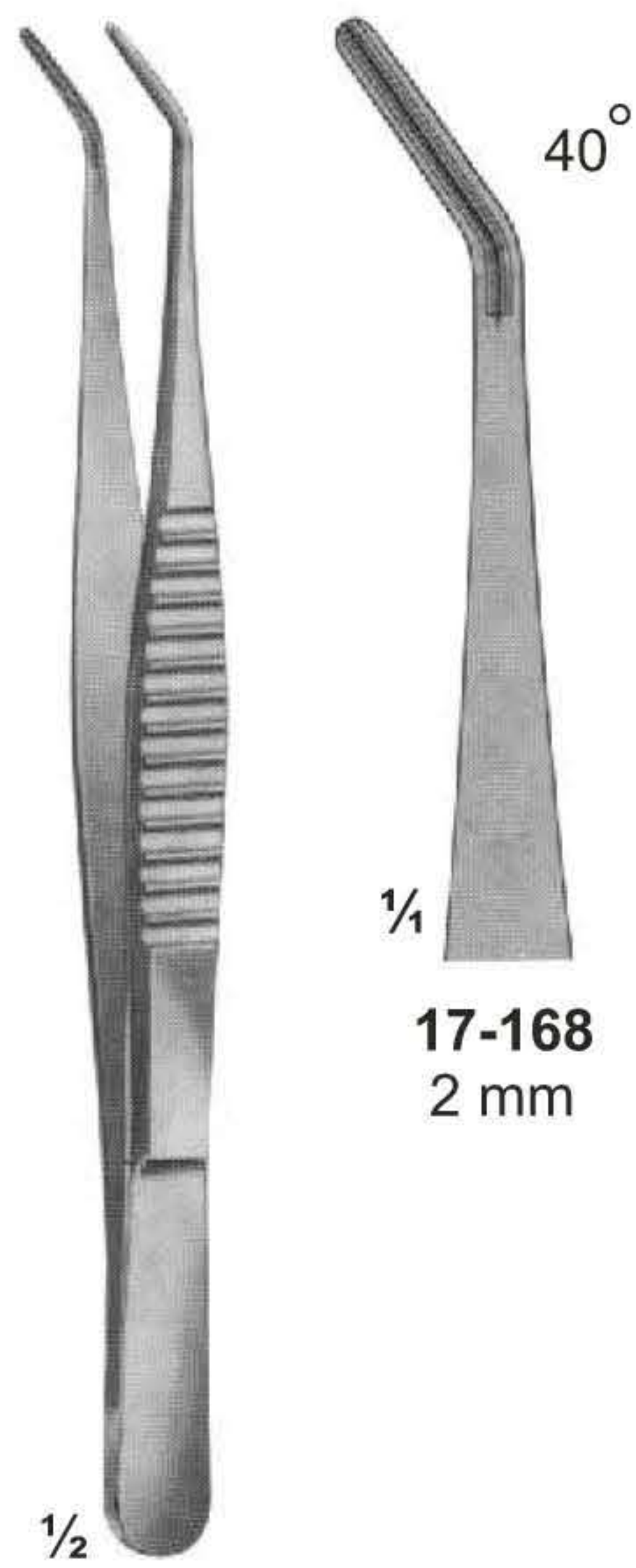

UG-1333
DE BAKEY
150 mm

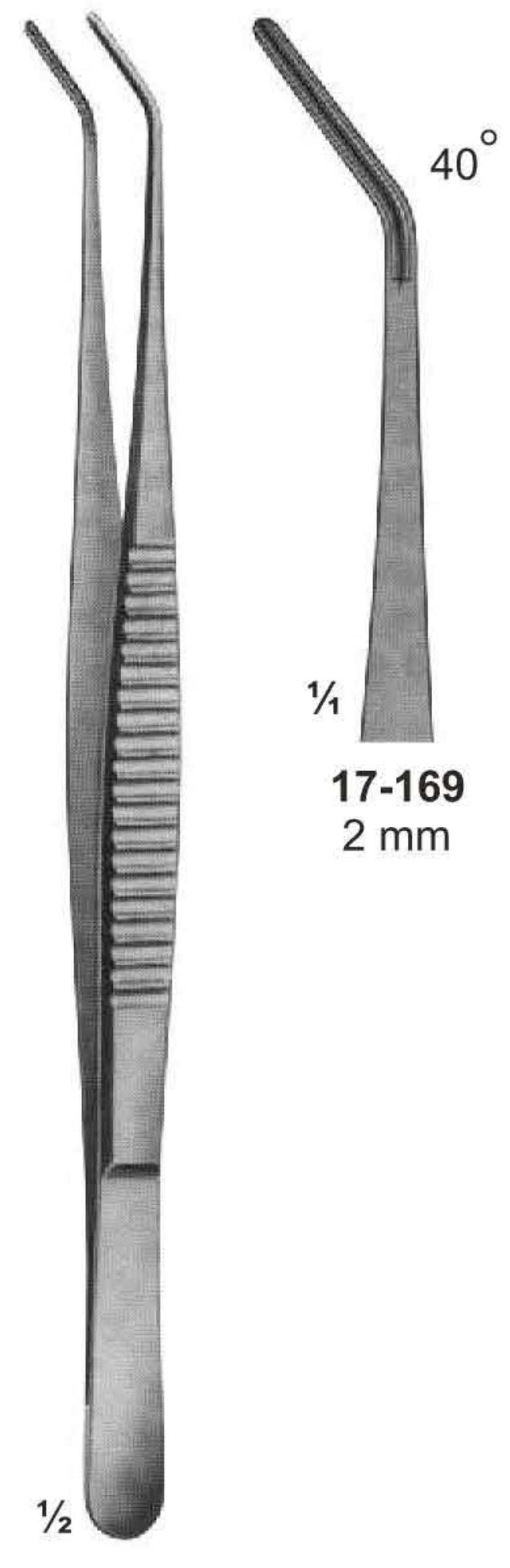

UG-1334
DE BAKEY
200 mm

17-169
2 mm

Ring Handle Bulldog Clamps

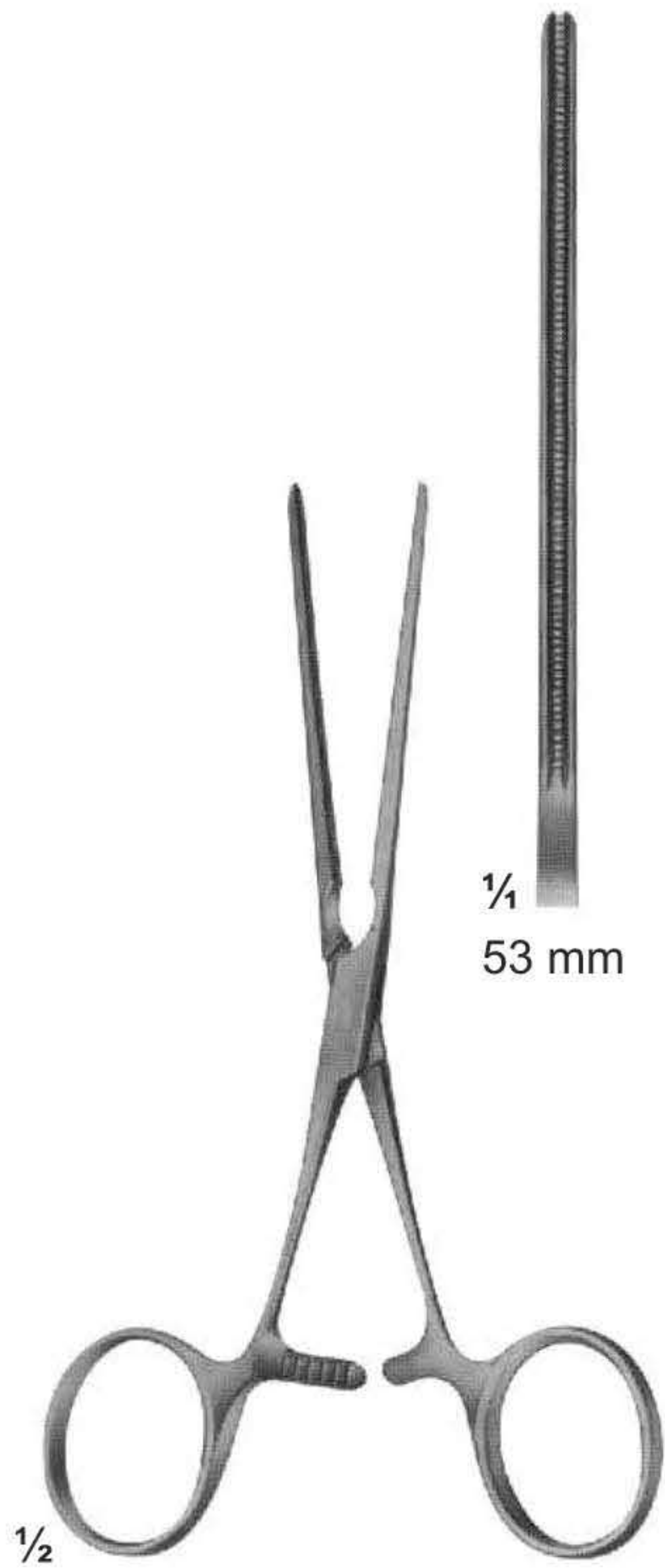

UG-1337
DE-BAKEY
gerade straight
130 mm

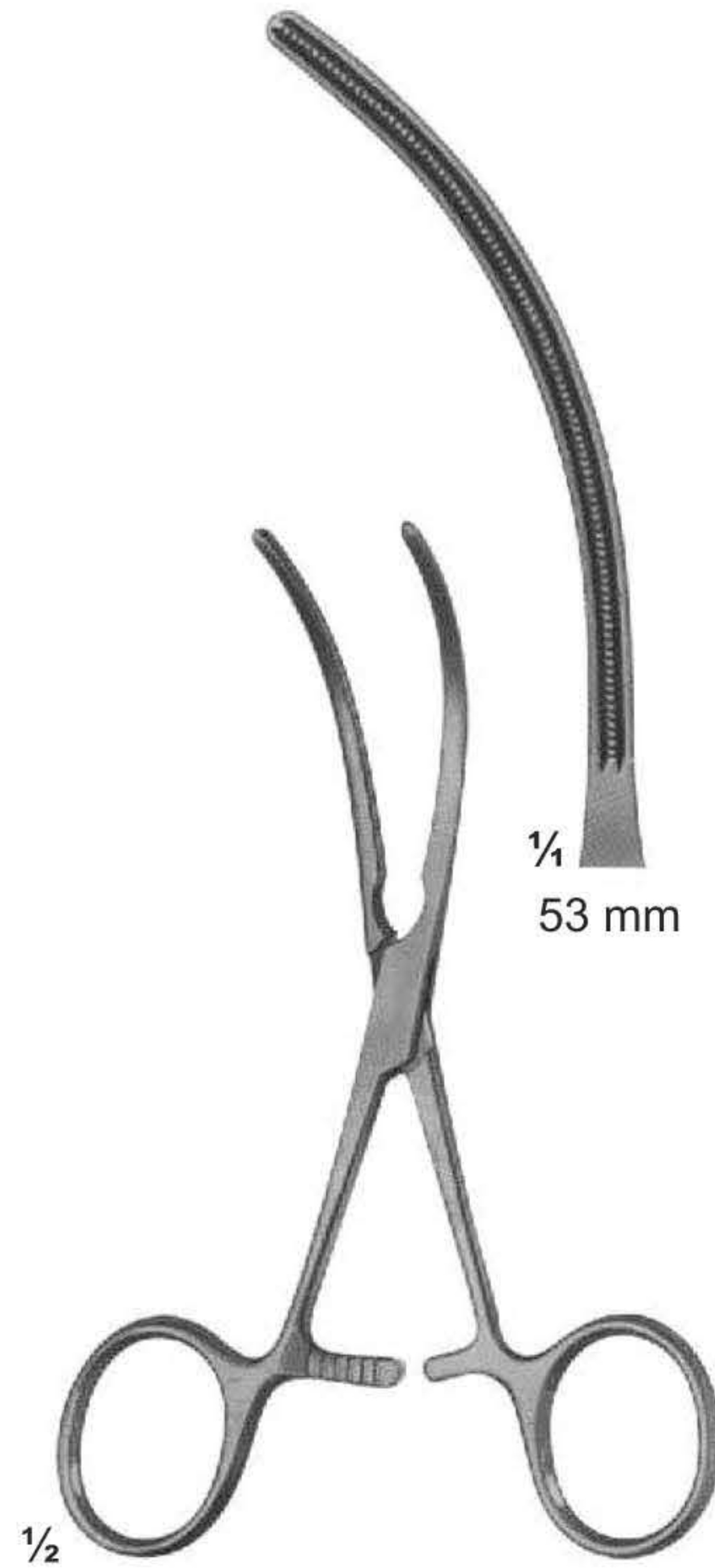

UG-1338
DE-BAKEY
Maul gebogen
curved jaws
125 mm

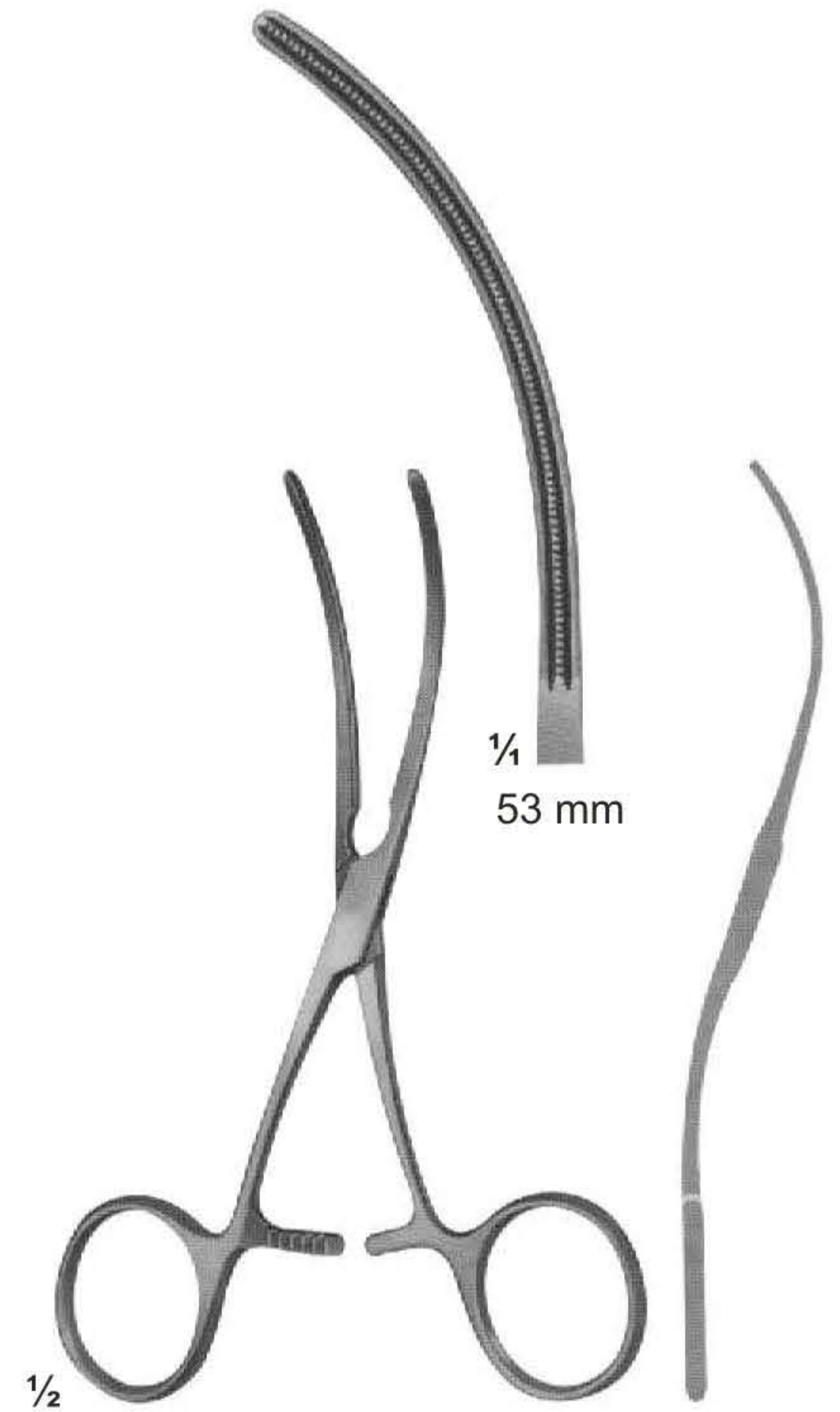

UG-1340
DE-BAKEY
S-shaped curved
125 mm

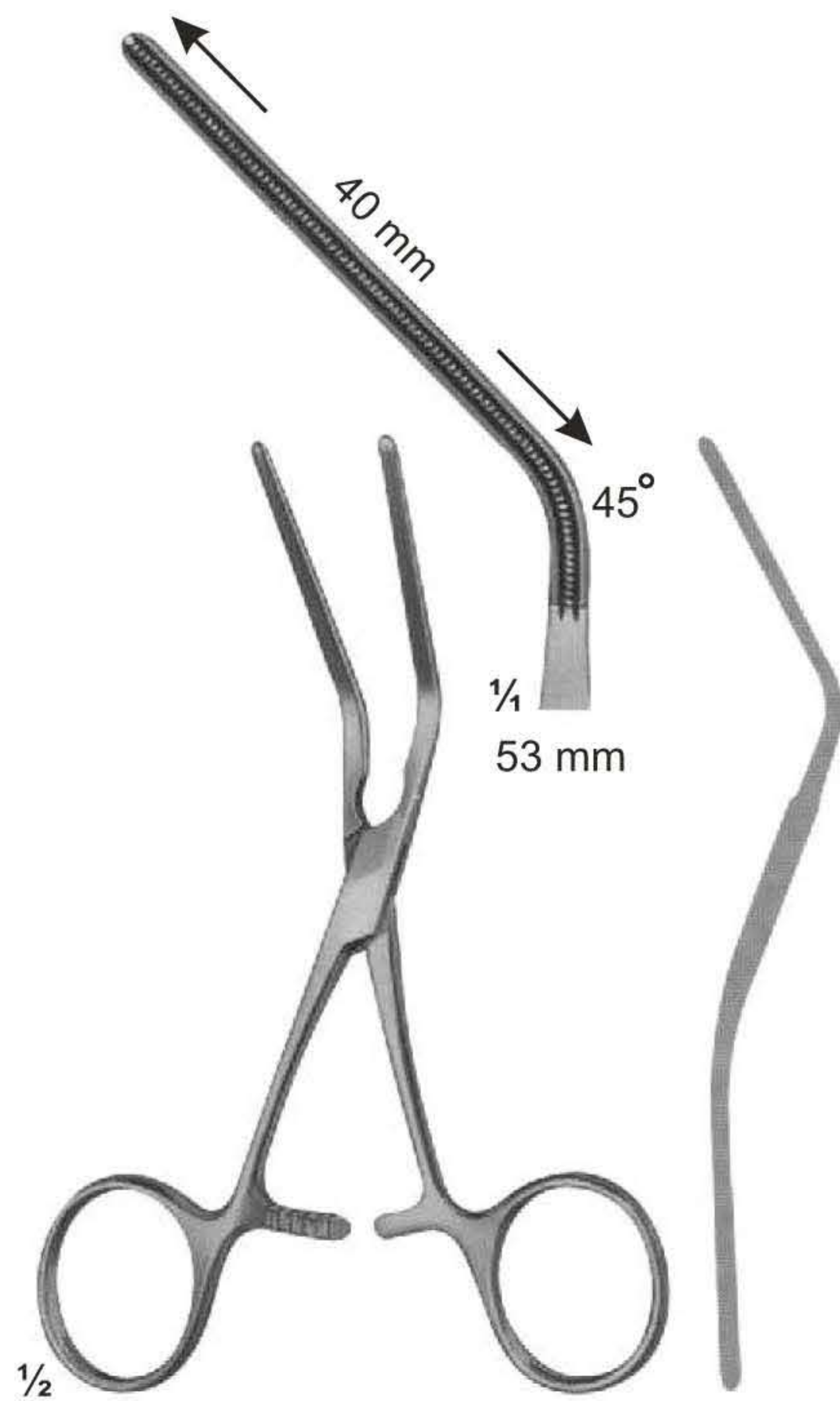

UG-1341
DE-BAKEY
45° winklig gebogen
angled 45°
125 mm

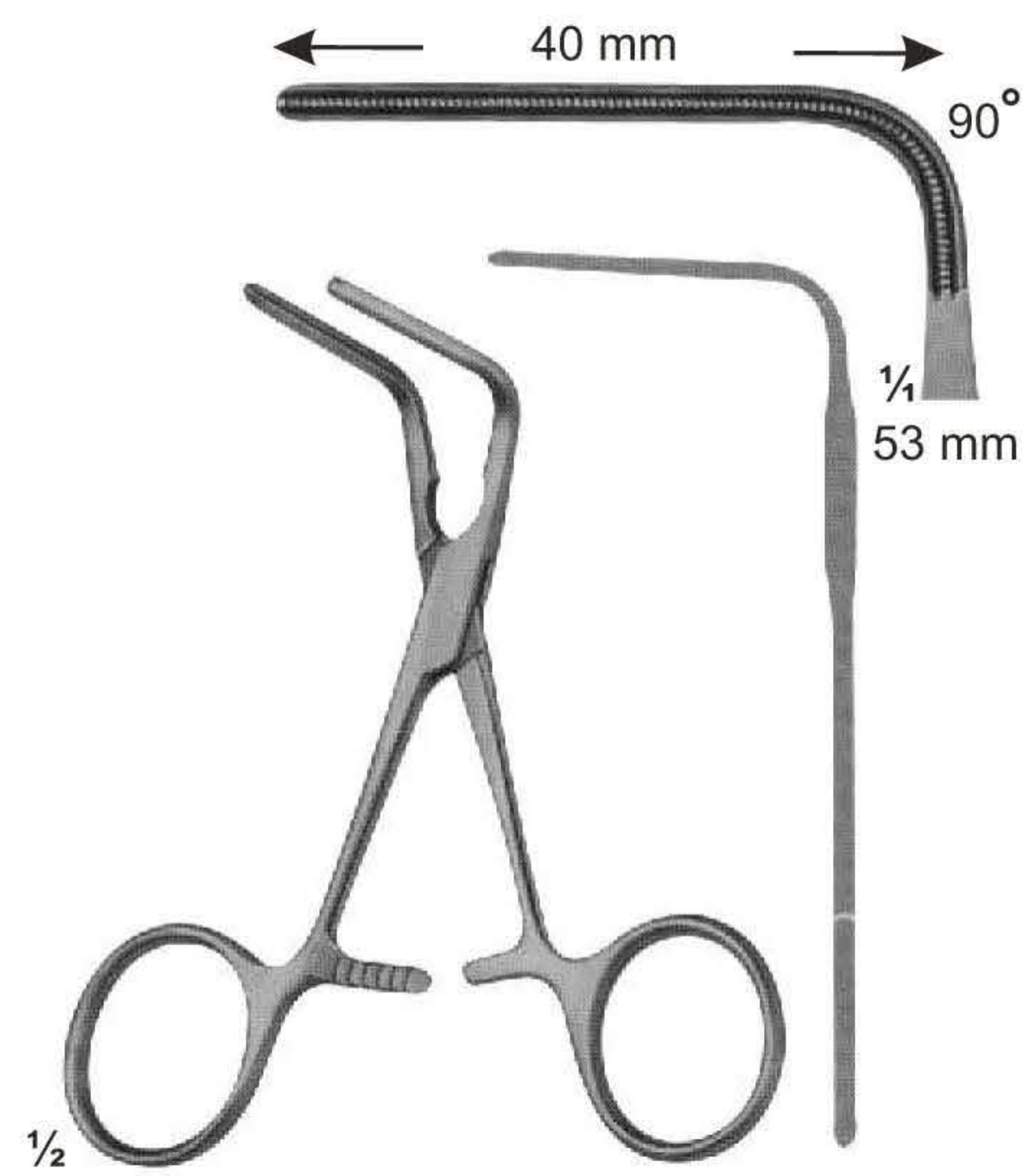

UG-1342
DE-BAKEY
90° winklig gebogen
angled 90°
105 mm

Anastomosis-and Multi-Purpose-Clamps for Neonatales



Anastomosis-and Multi-Purpose-Clamps-Pediatric types



$\frac{1}{2}$
UG-1350
DE BAKEY



$\frac{1}{2}$
UG-1352
COOLEY



$\frac{1}{2}$
UG-1353
DERRA

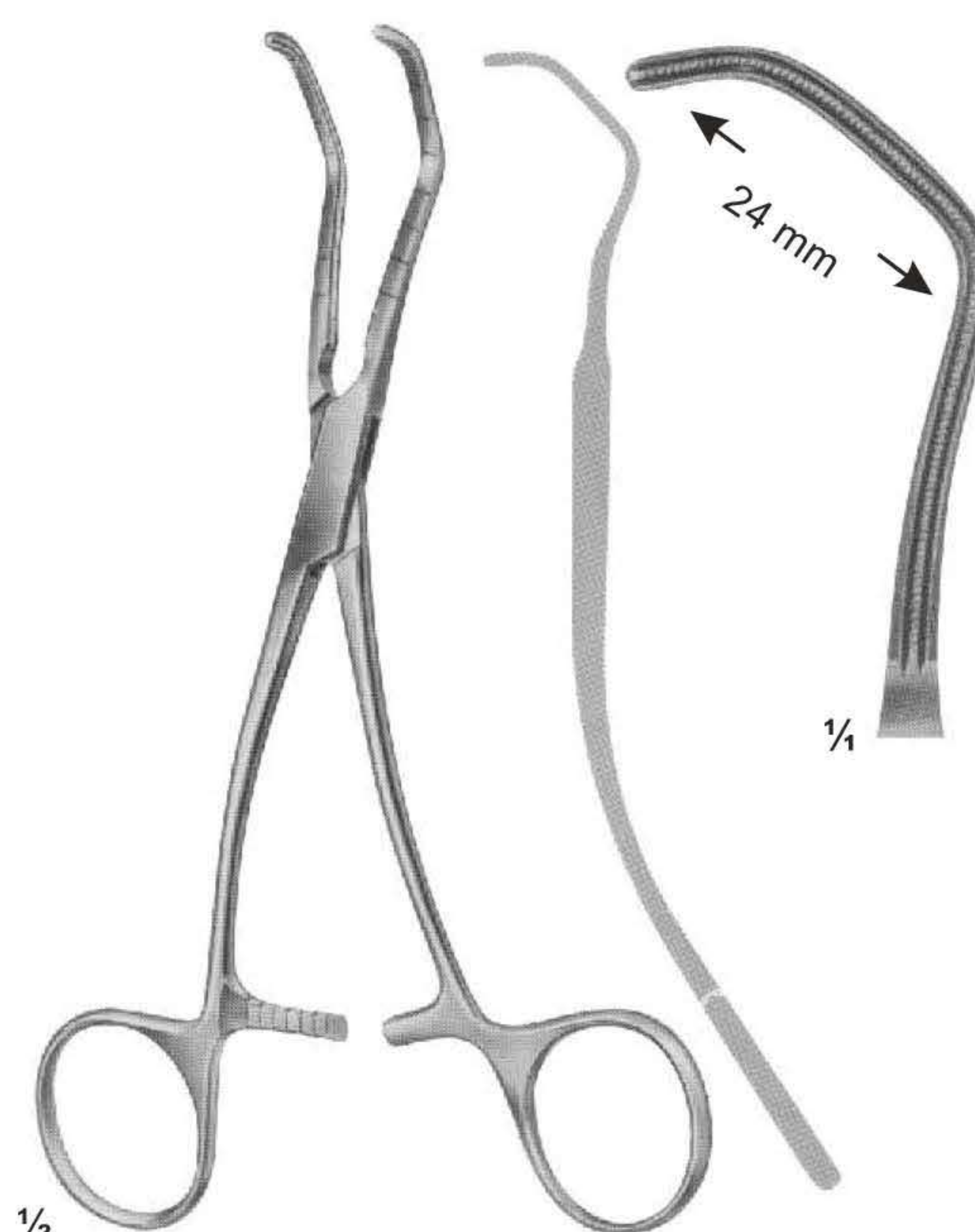

$\frac{1}{2}$
UG-1354
COOLEY

Non-traumatic Haemostatic Forceps



UG-1355
125 mm



UG-1356
165 mm



UG-1357
DE BAKEY-BAINRIDGE
155 mm



UG-1358
DE BAKEY-BAINRIDGE
180 mm

Non-traumatic Haemostatic Forceps



UG-1360
DE-BAKEY-KELLY
140 mm



UG-1361
PEAN
155 mm



UG-1364
DE-BAKEY-PEAN

Anastomosis Clamps

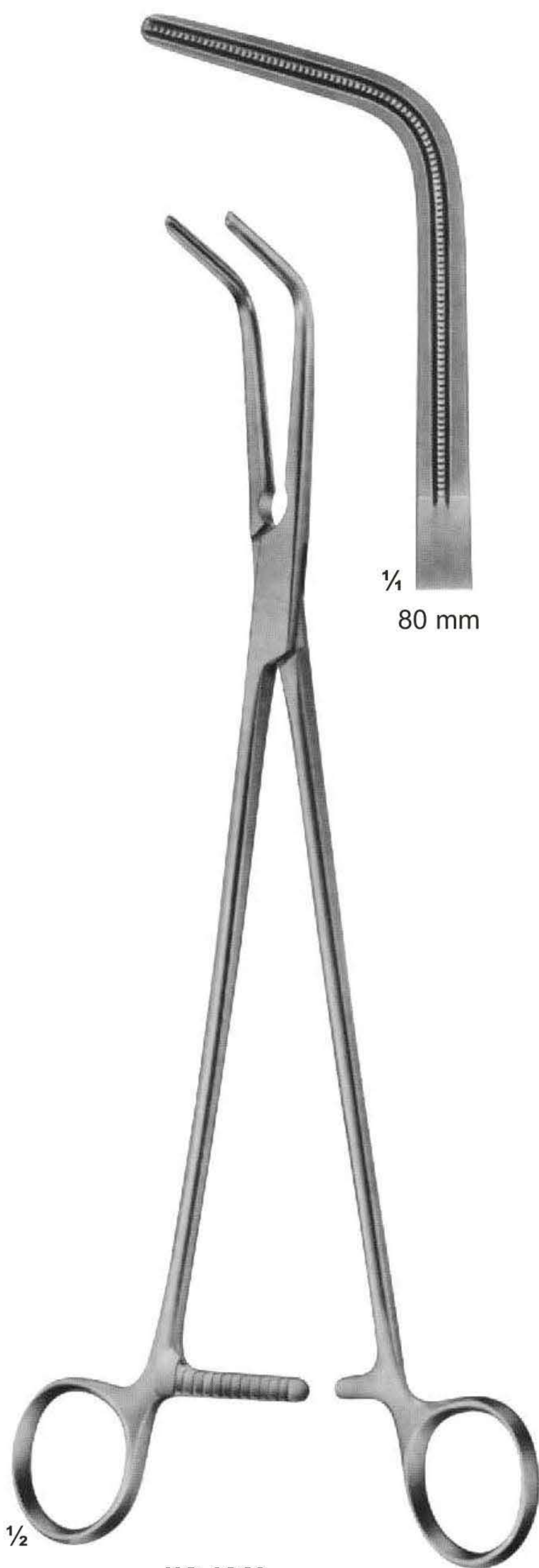

UG-1369
DE-BAKEY-MIXTER
285 mm



UG-1371
GLOVER
245 mm

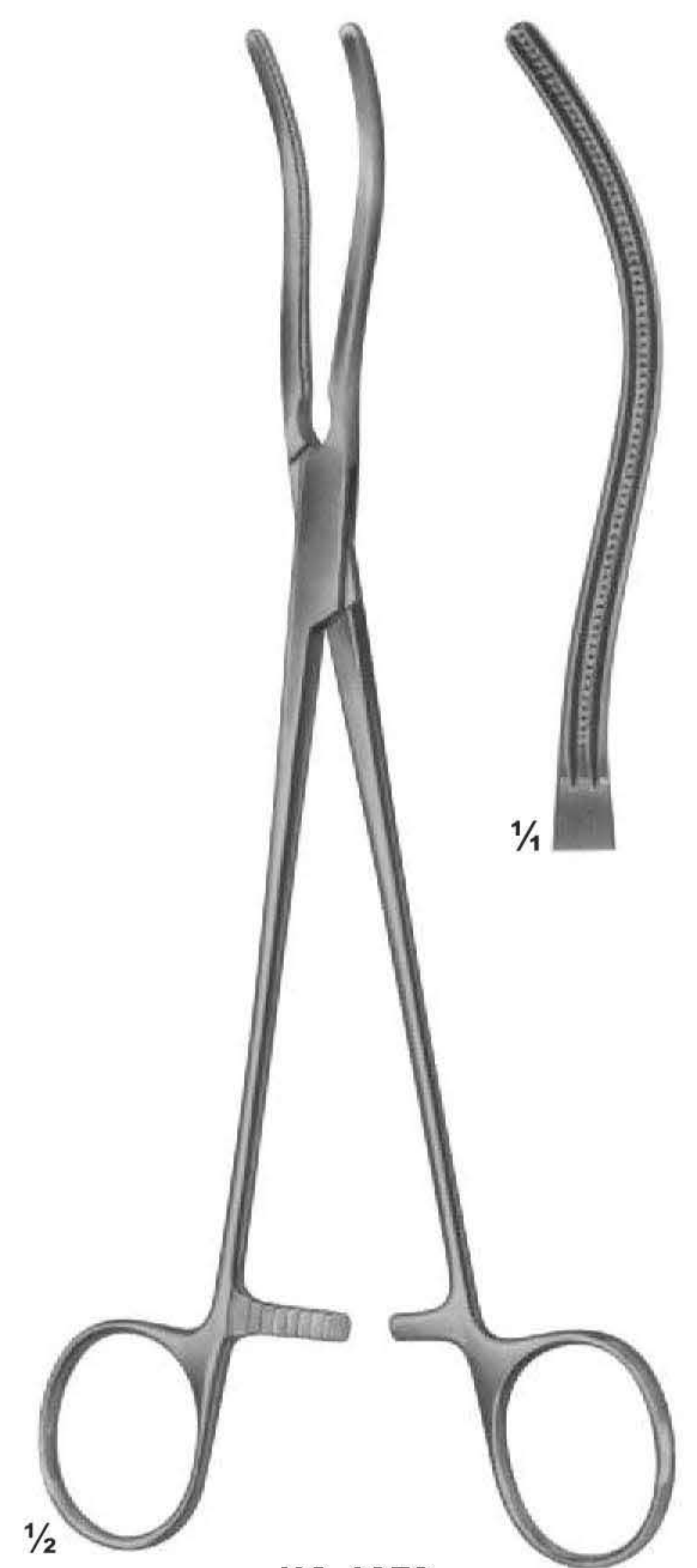

UG-1373
GLOVER
220 mm

Vena-Cava Clamps

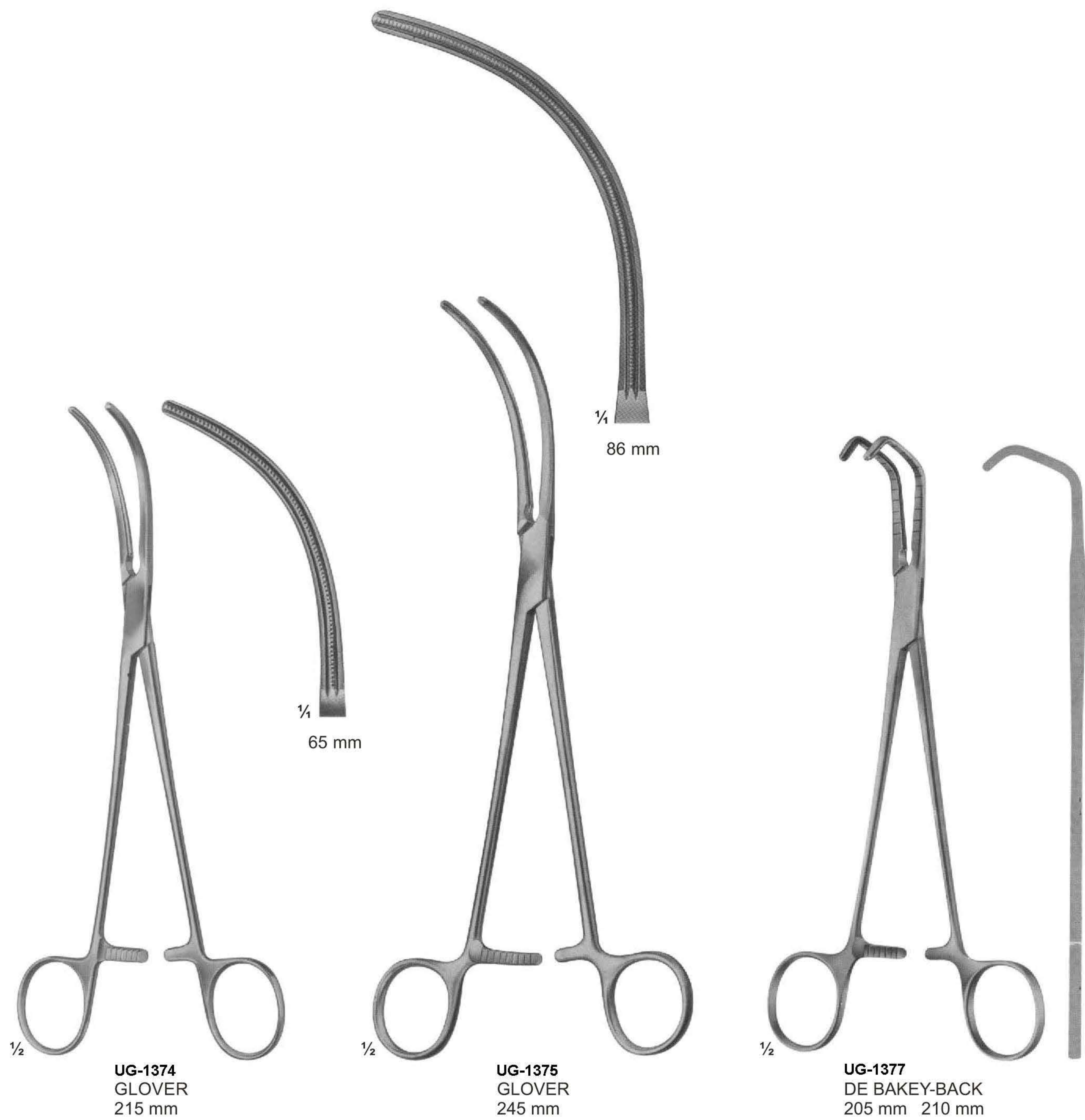

Vena-Cava Clamps



1/2

UG-1379
DE BAKEY-HARKEN



1/2

UG-1381
DE BAKEY

Vena-Cava Clamps

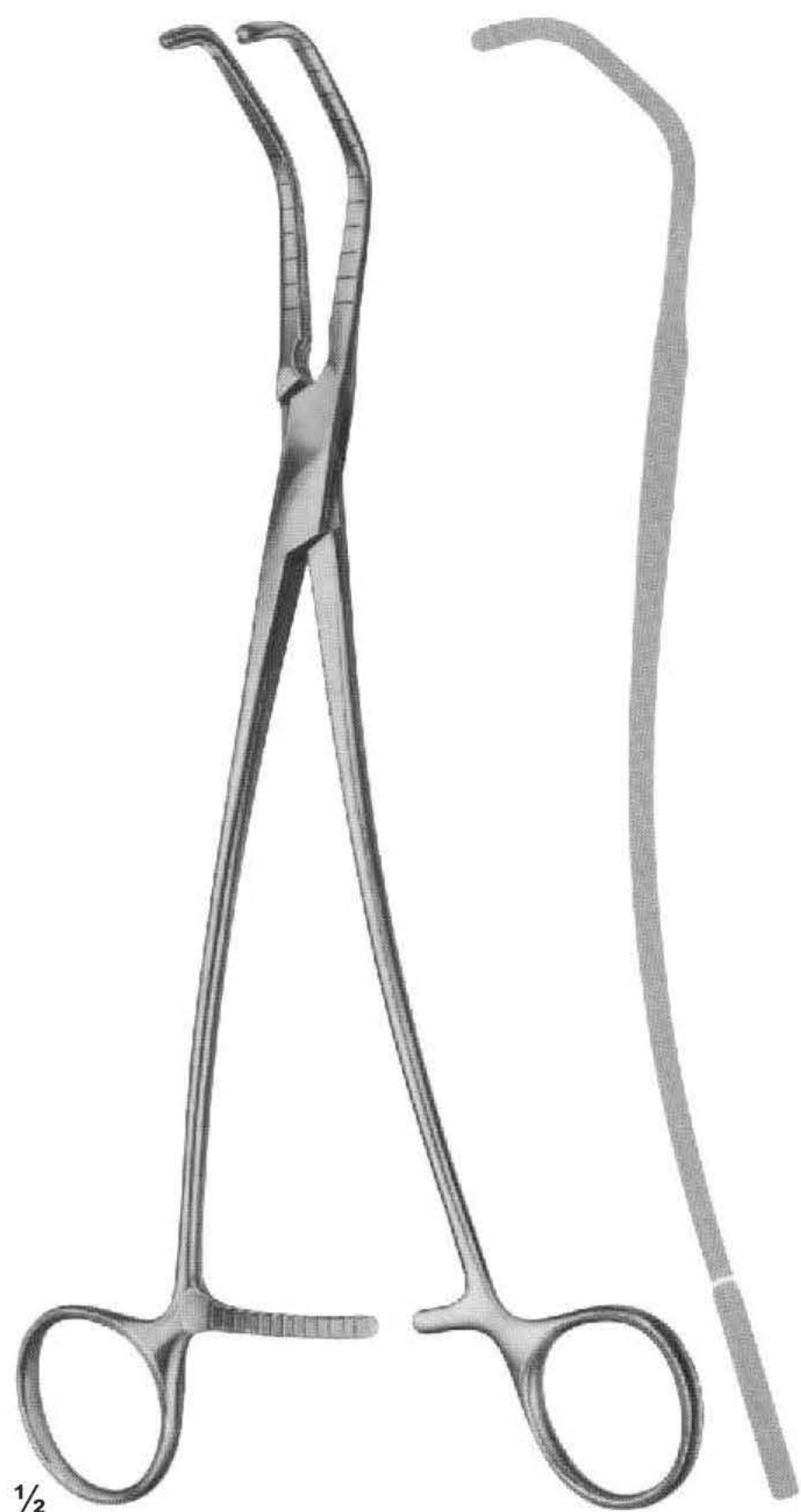

UG-1384
DE BAKEY-SATINSKY
235 mm, 240 mm, 245 mm



UG-1386
DE BAKEY
170 mm, 165 mm

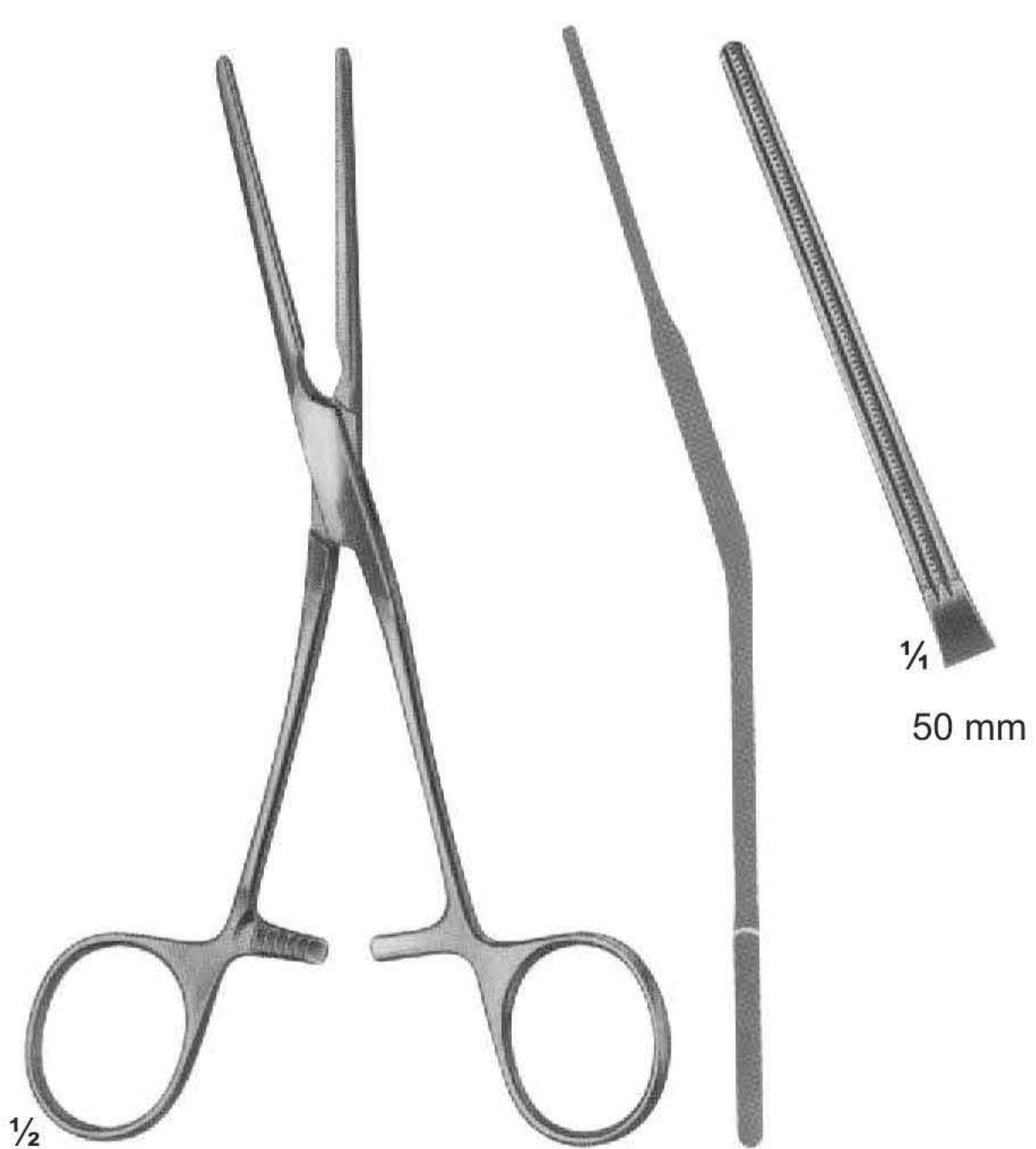

UG-1388
DE BAKEY
165 mm

Vena-Cava Clamps



UG-1392
DE BAKEY
205 mm, 225 mm, 240 mm



UG-1405
DE BAKEY
200 mm, 225 mm, 240 mm

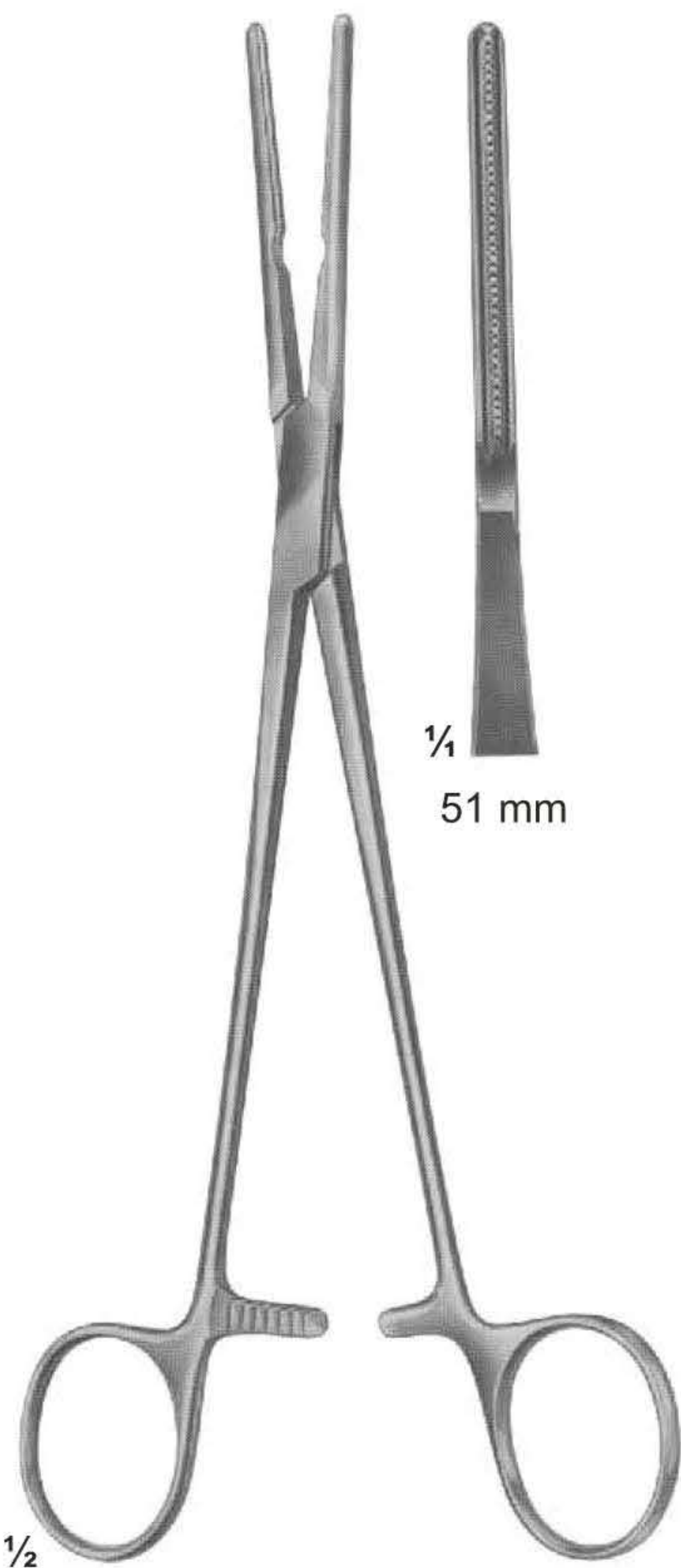

UG-1407
DE BAKEY
210 mm

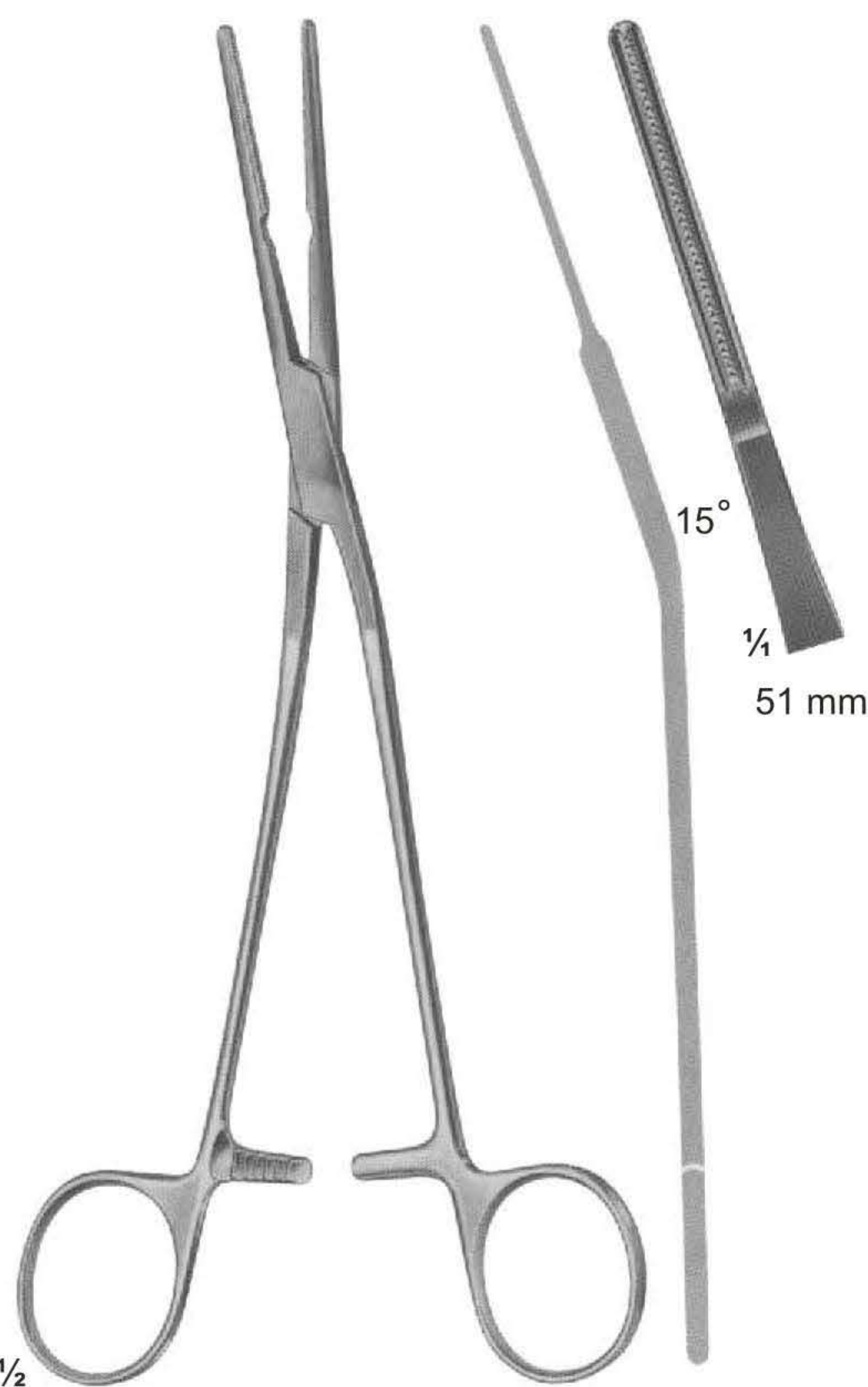

UG-1408
DE BAKEY
210 mm

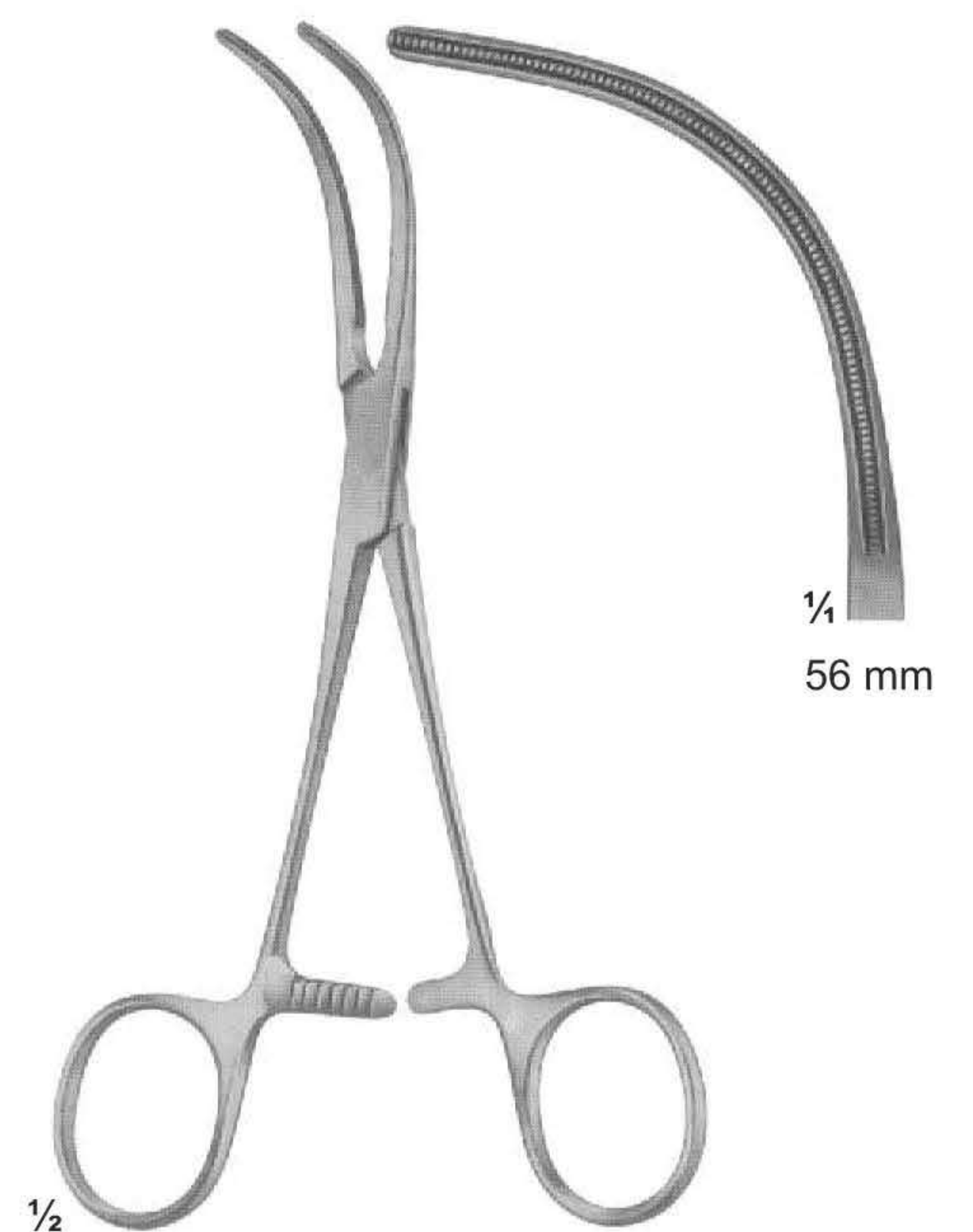

UG-1409
DE BAKEY
160 mm

Vena-Cava Clamps

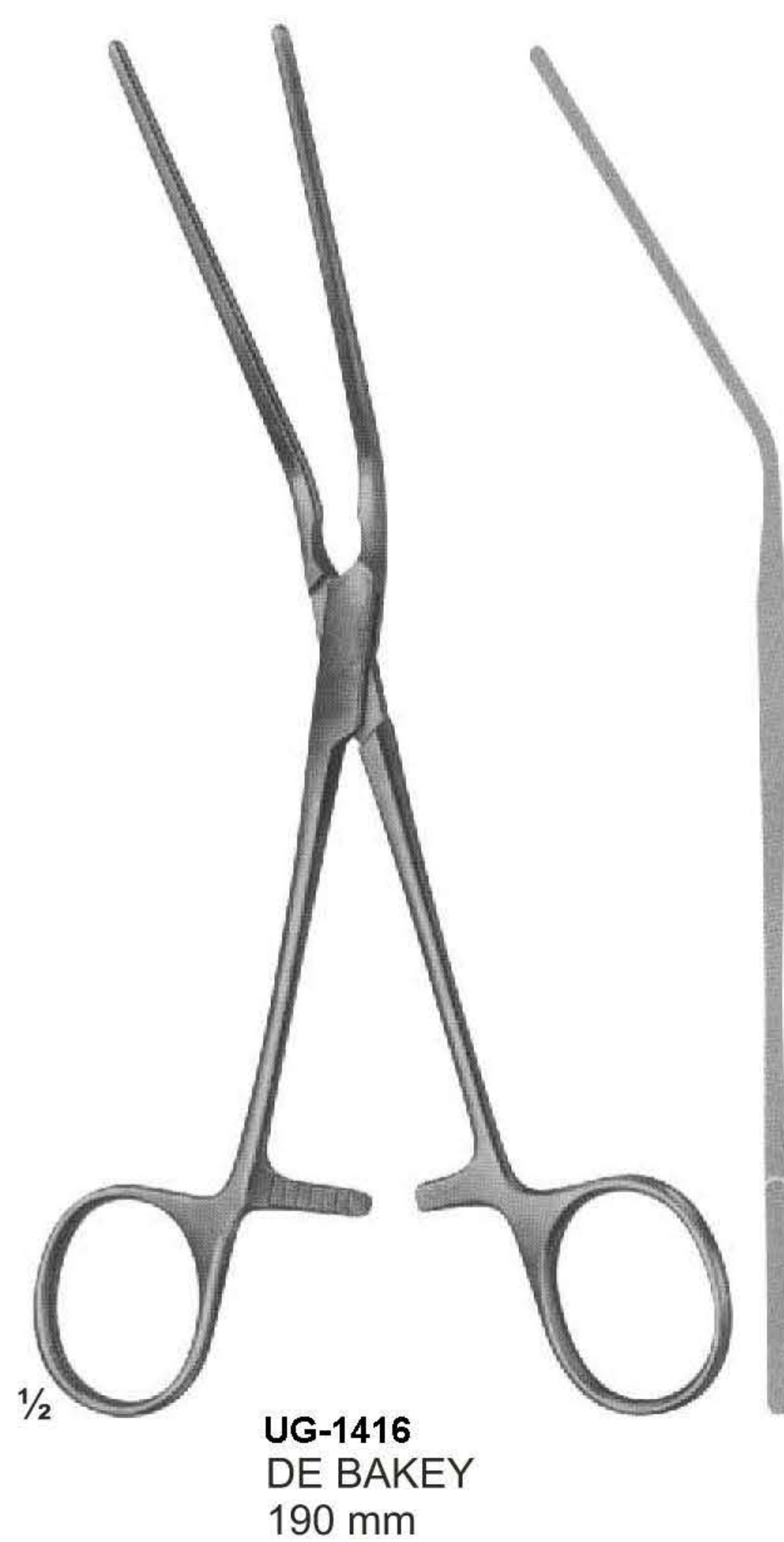
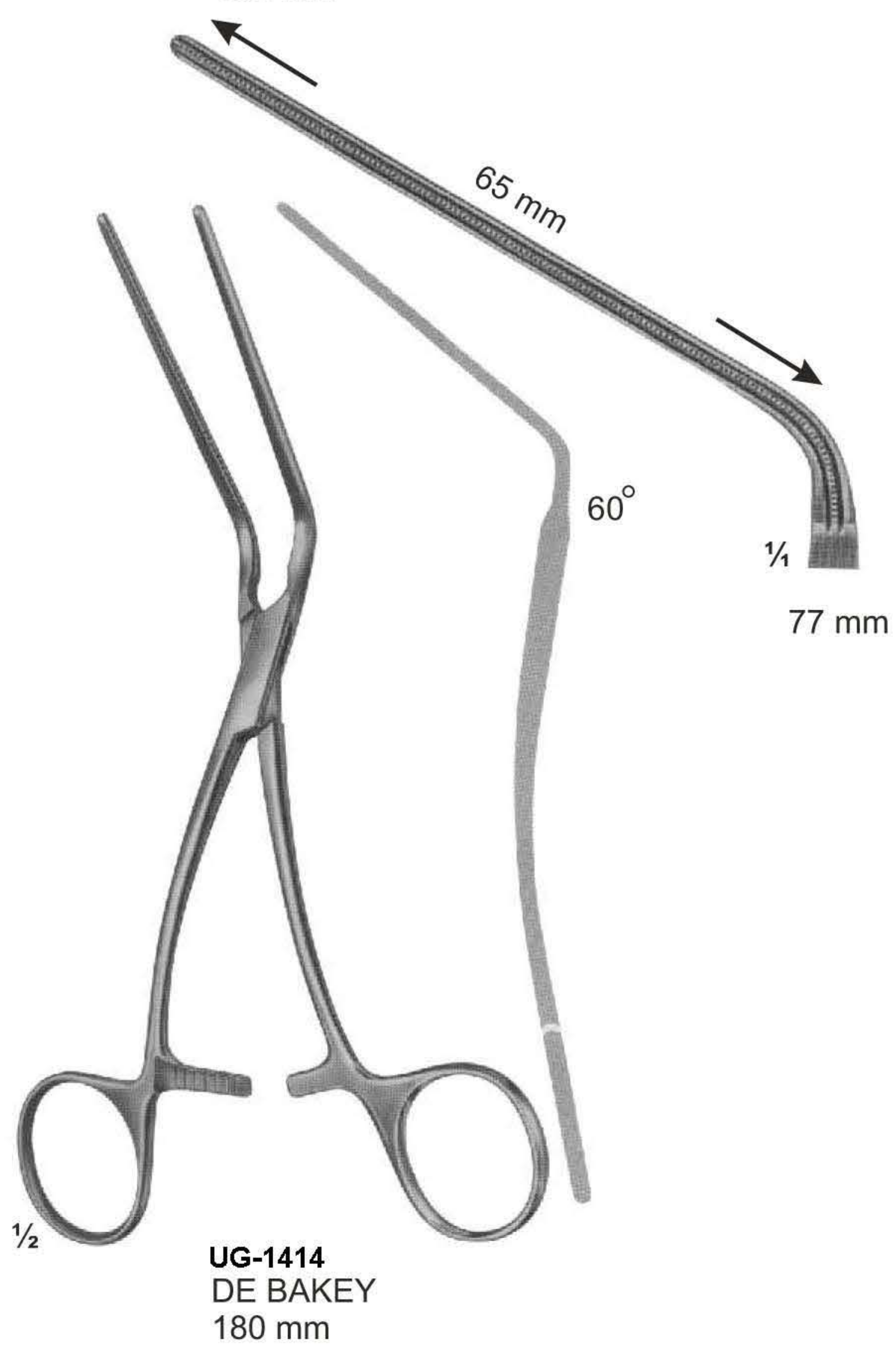
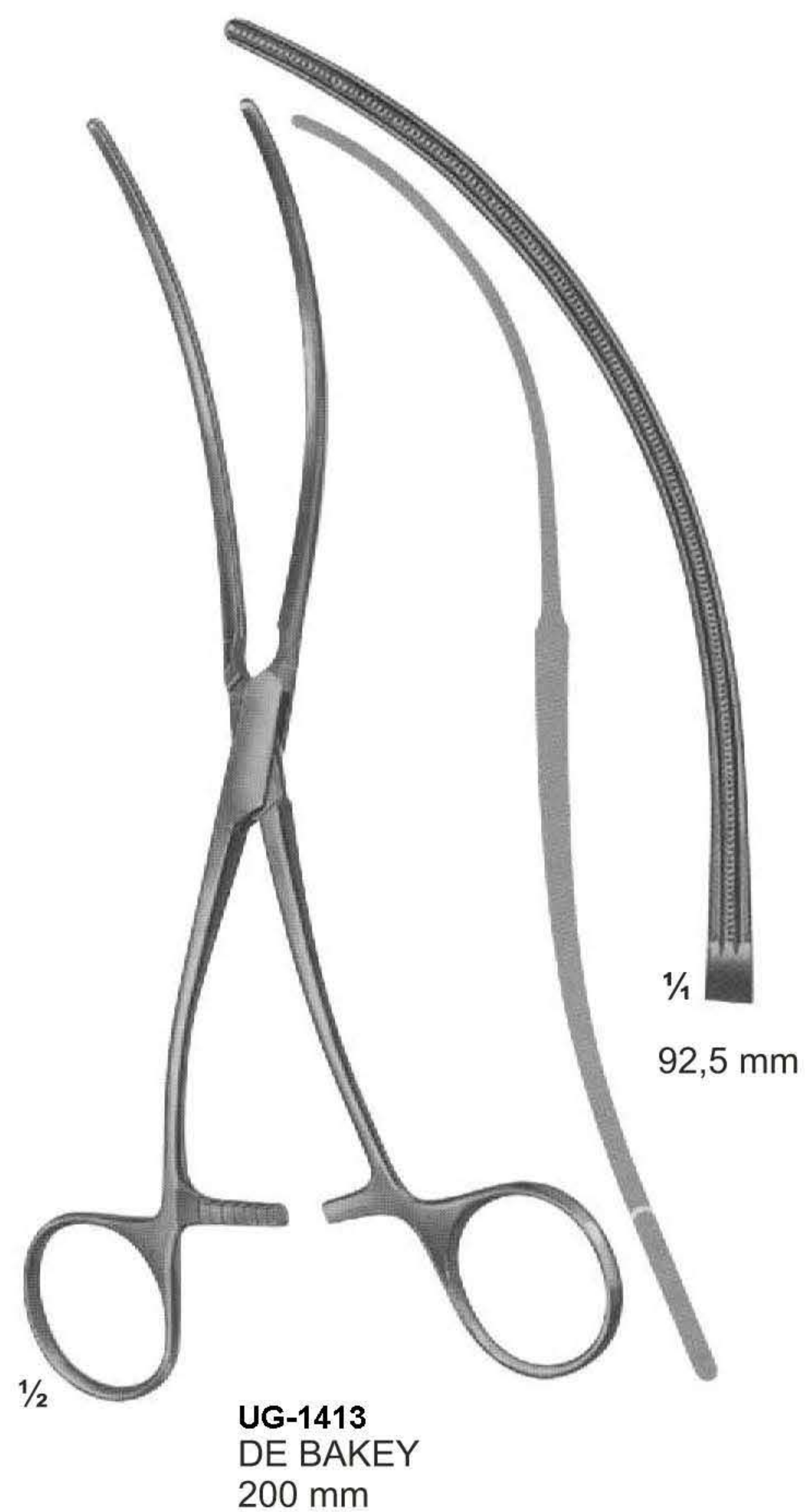
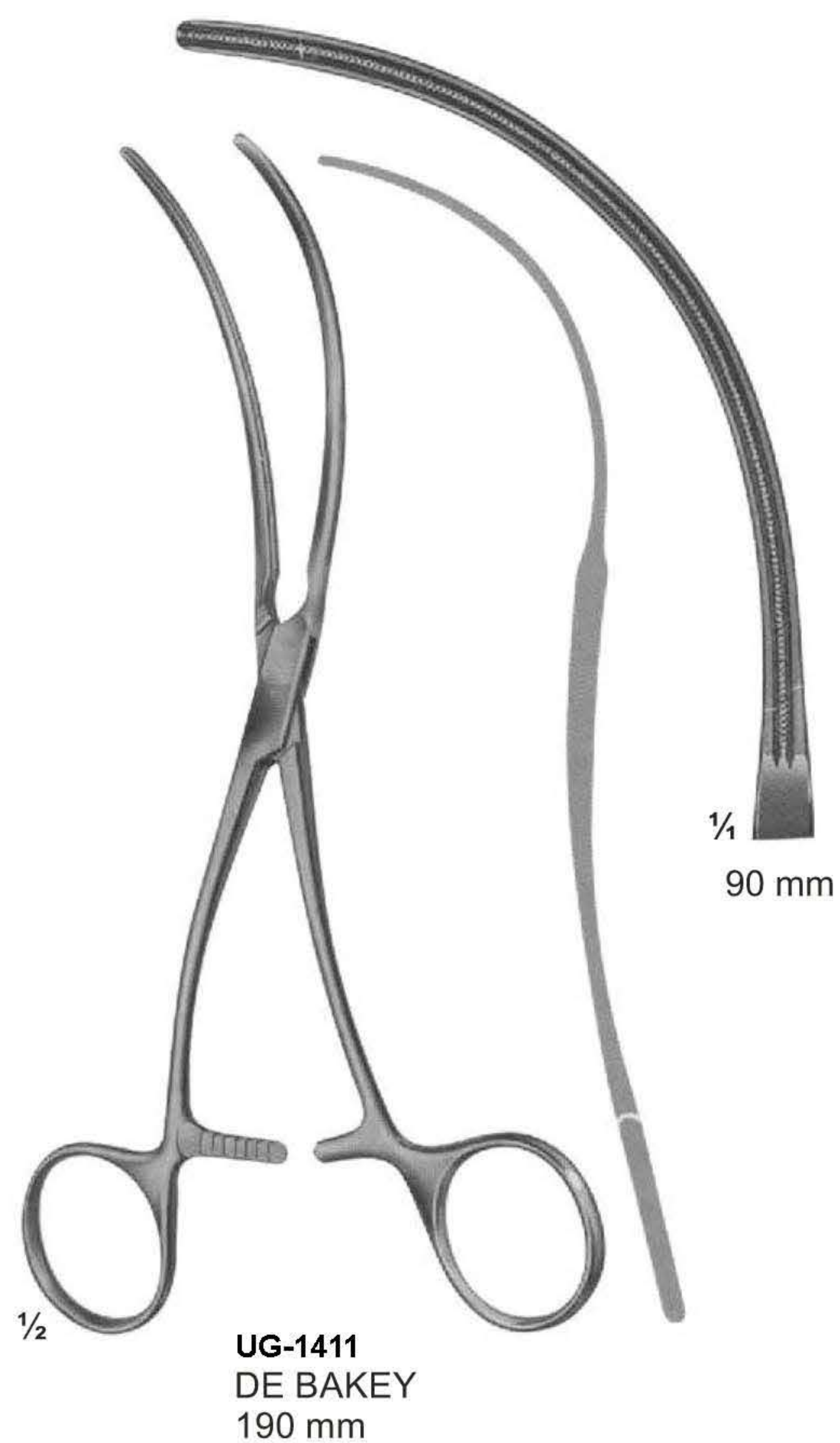

Vena-Cava Clamps



UG-1419
LELAND-JONES
195 mm



UG-1420
DE BAKEY
200 mm

iliac clamp



UG-1421
WERTHEIM
250 mm

Aorta-Anastomosis Clamps

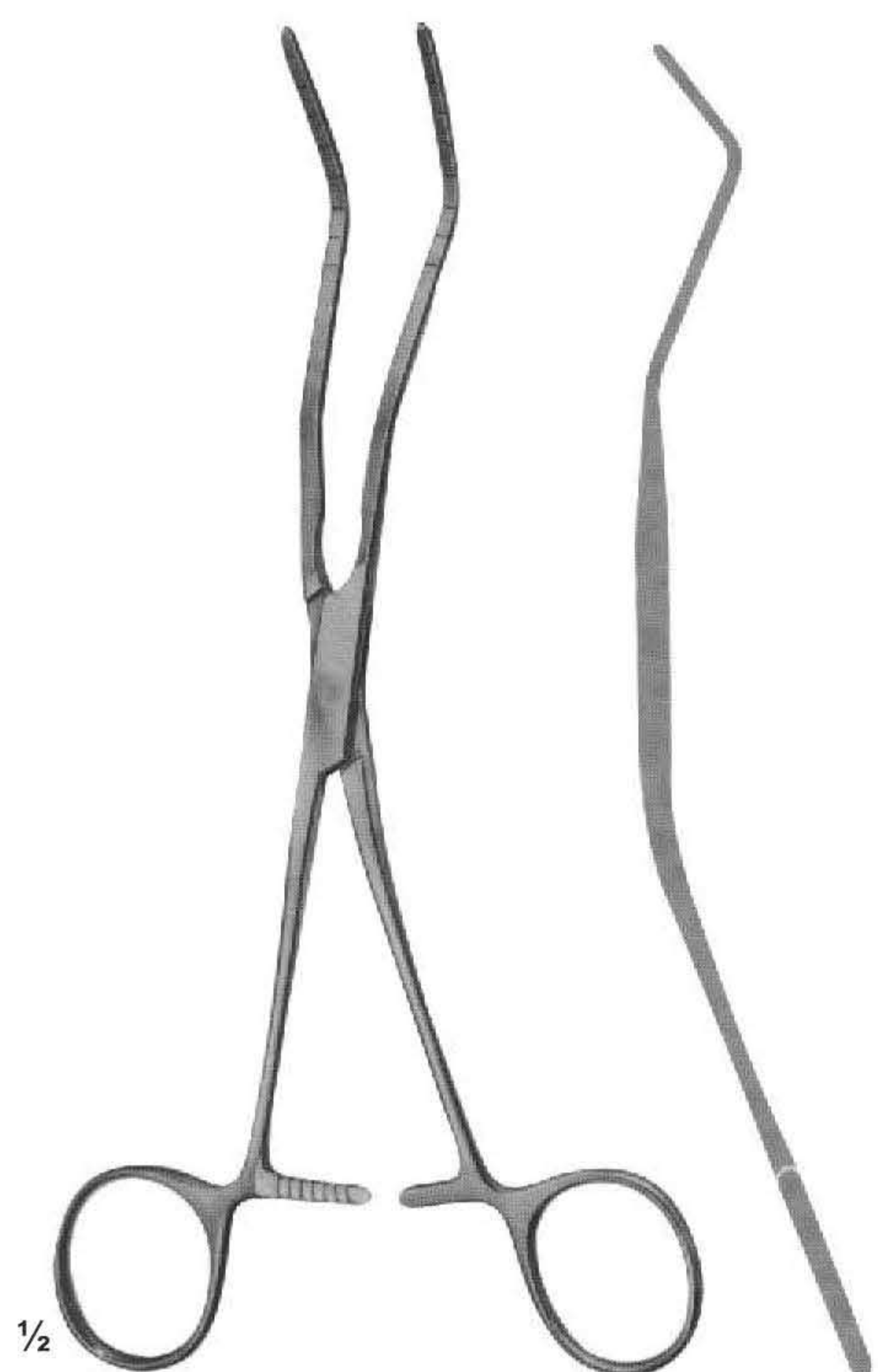

UG-1436
COOLEY



UG-1437
COOLEY
260 mm

108 mm



UG-1438
COOLEY

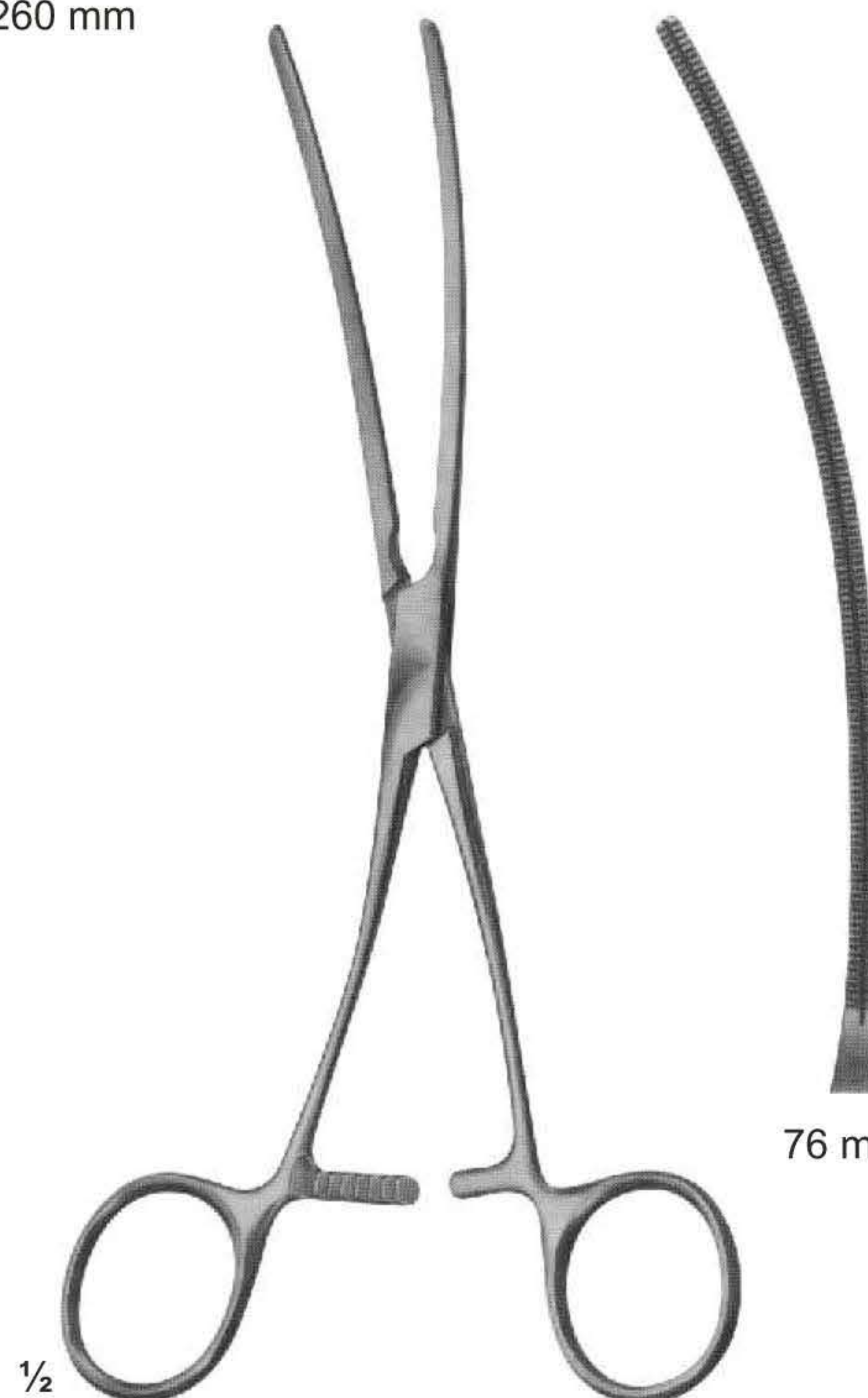

UG-1439
COOLEY
190 mm

76 mm

Aorta-Anastomosis Clamps

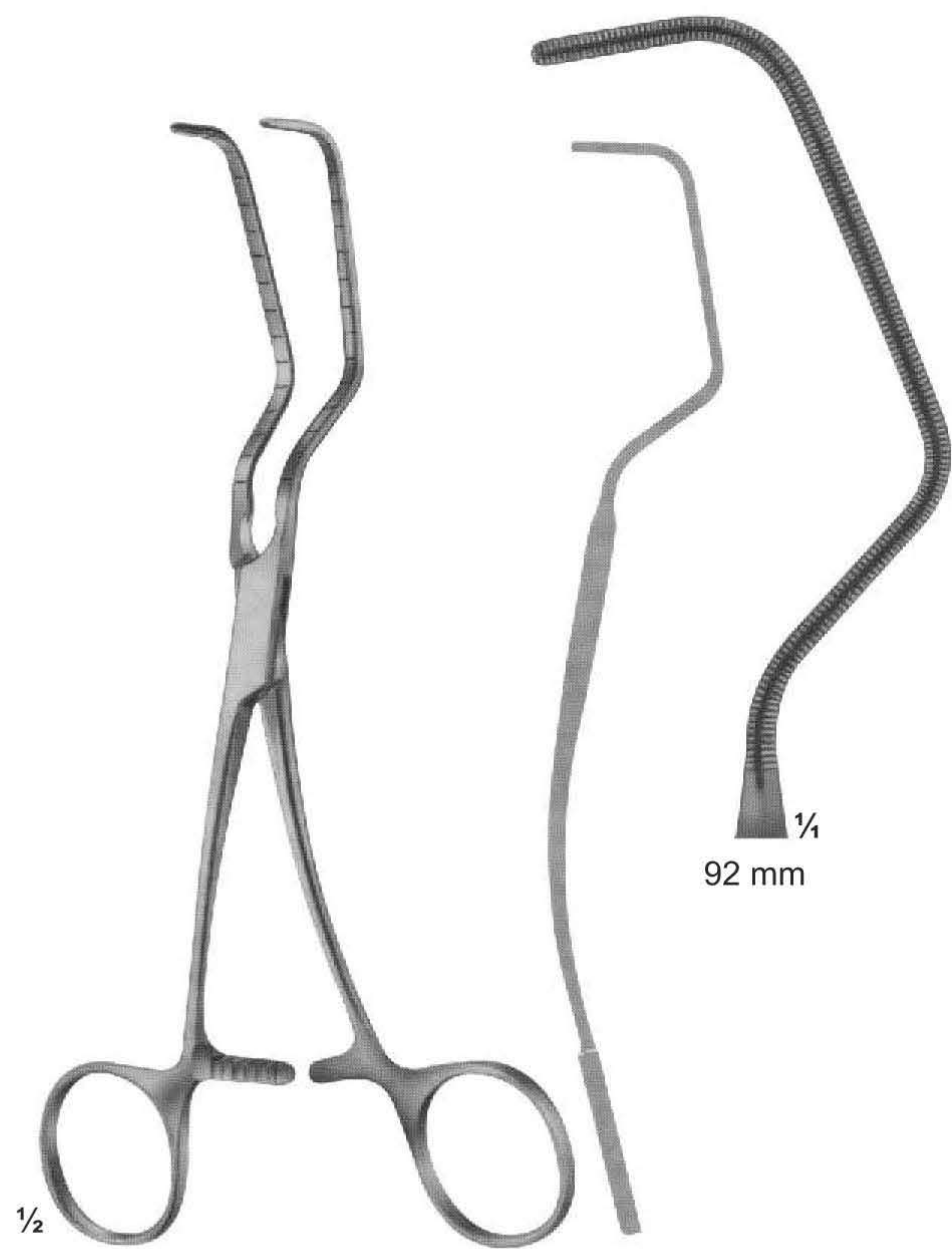

$\frac{1}{2}$
UG-1440
PARRY-COOLEY
185 mm



$\frac{1}{2}$
UG-1441
COOLEY
160 mm, 170 mm, 180 mm

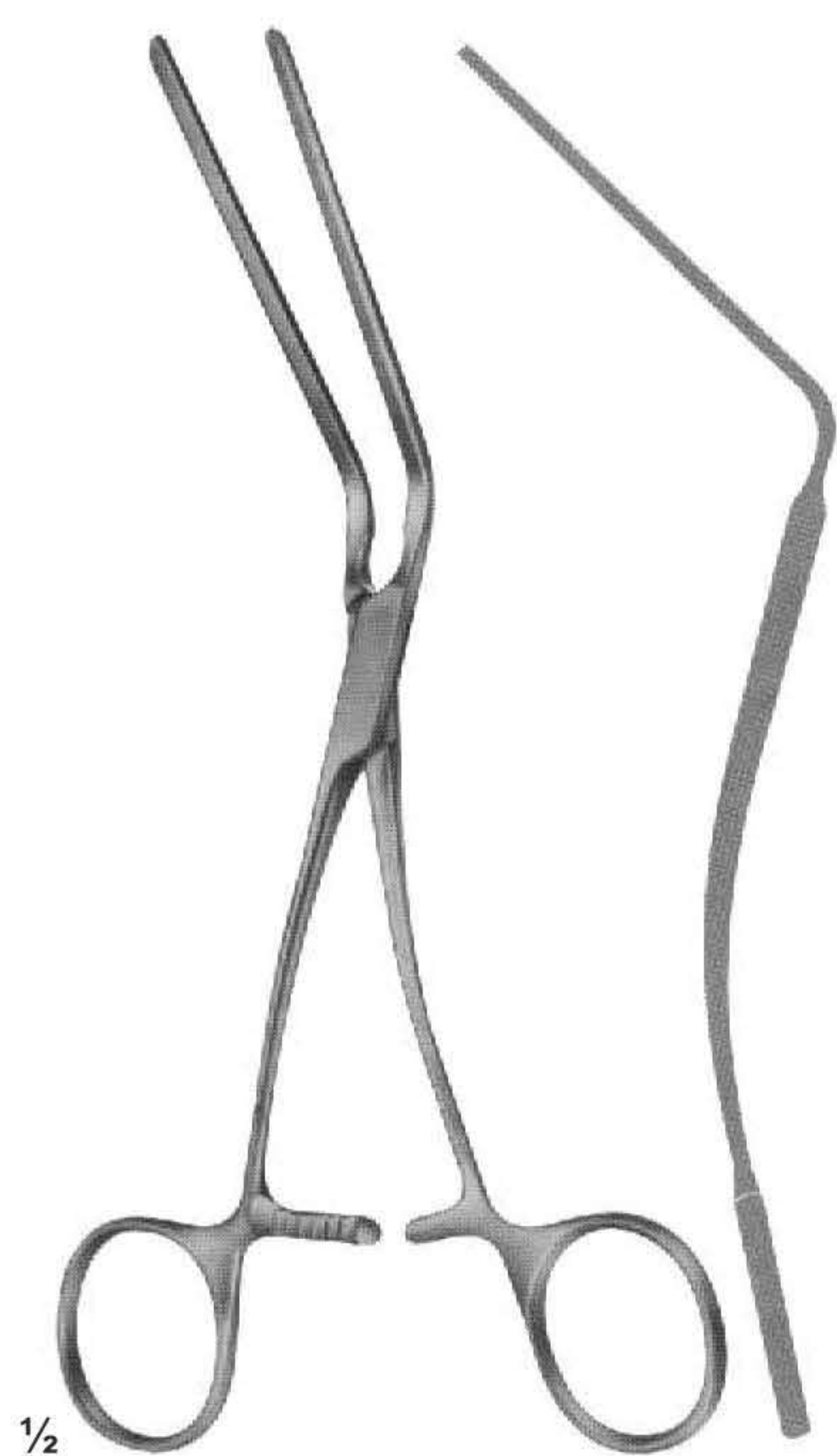

$\frac{1}{2}$
UG-1442

Multi-Purpose Clamps



$\frac{1}{2}$
UG-1435
DARDIK

Multi-Purpose Clamps

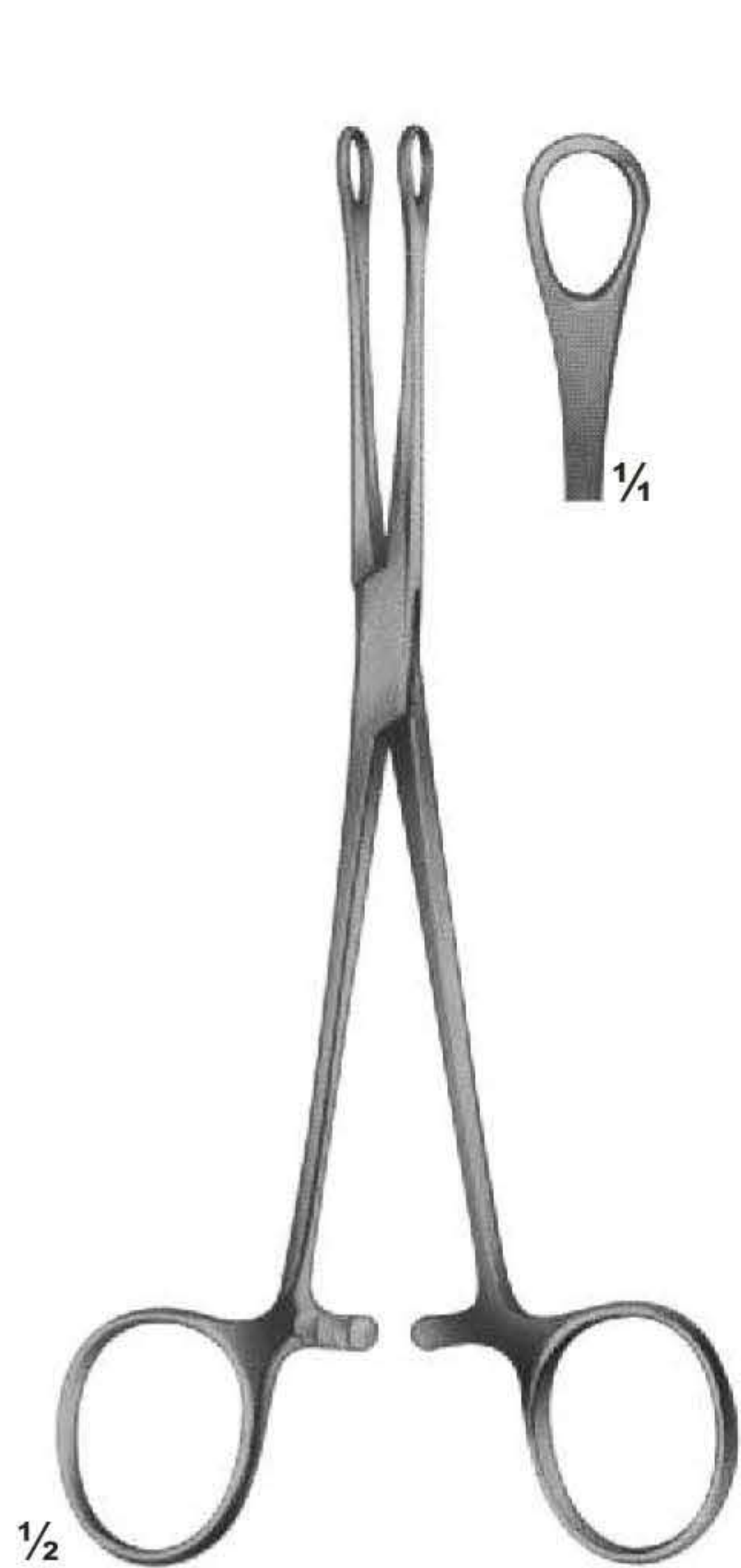

UG-1434
WILLIAMS
160 mm



UG-1433
TUTTLE
230 mm



UG-1432
NELSON
230 mm

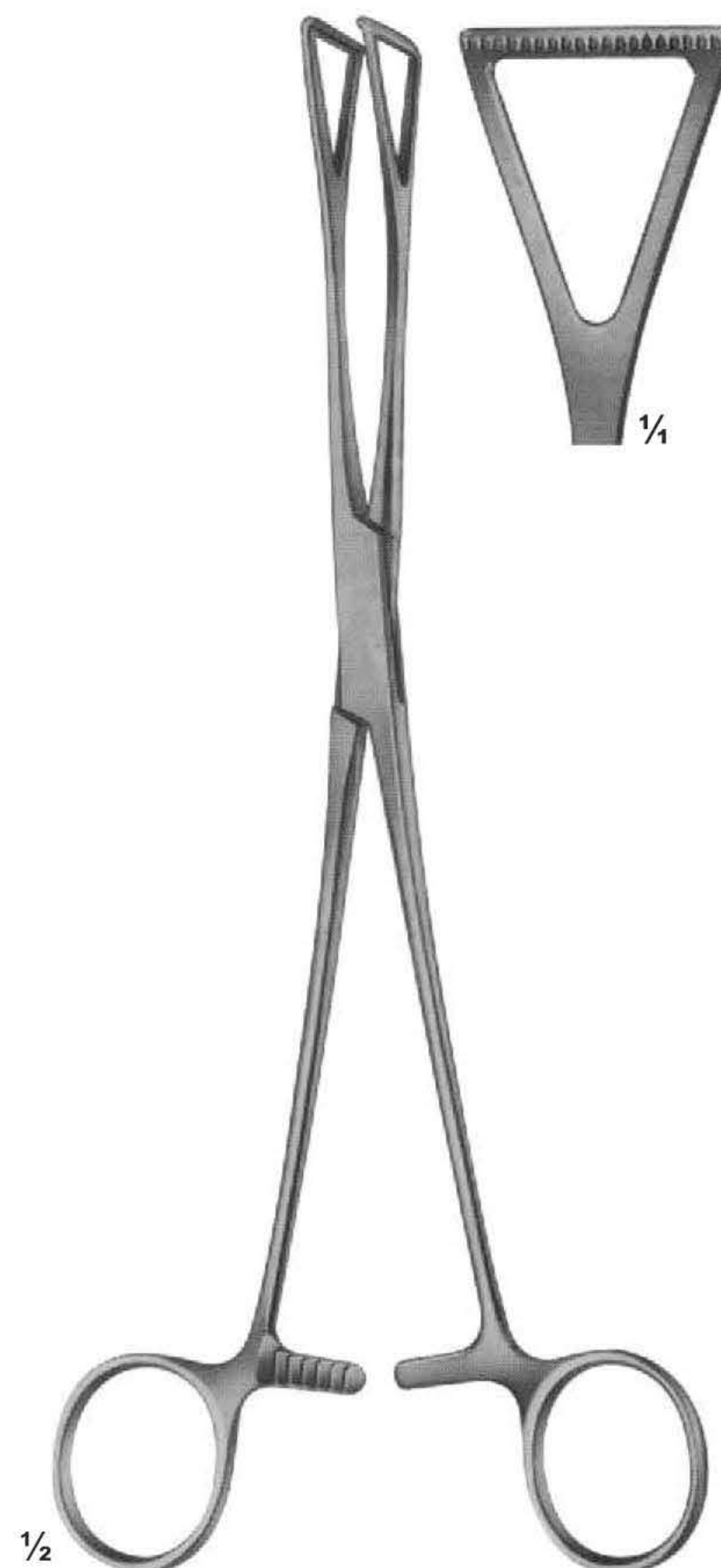

UG-1431
DUVAL
230 mm

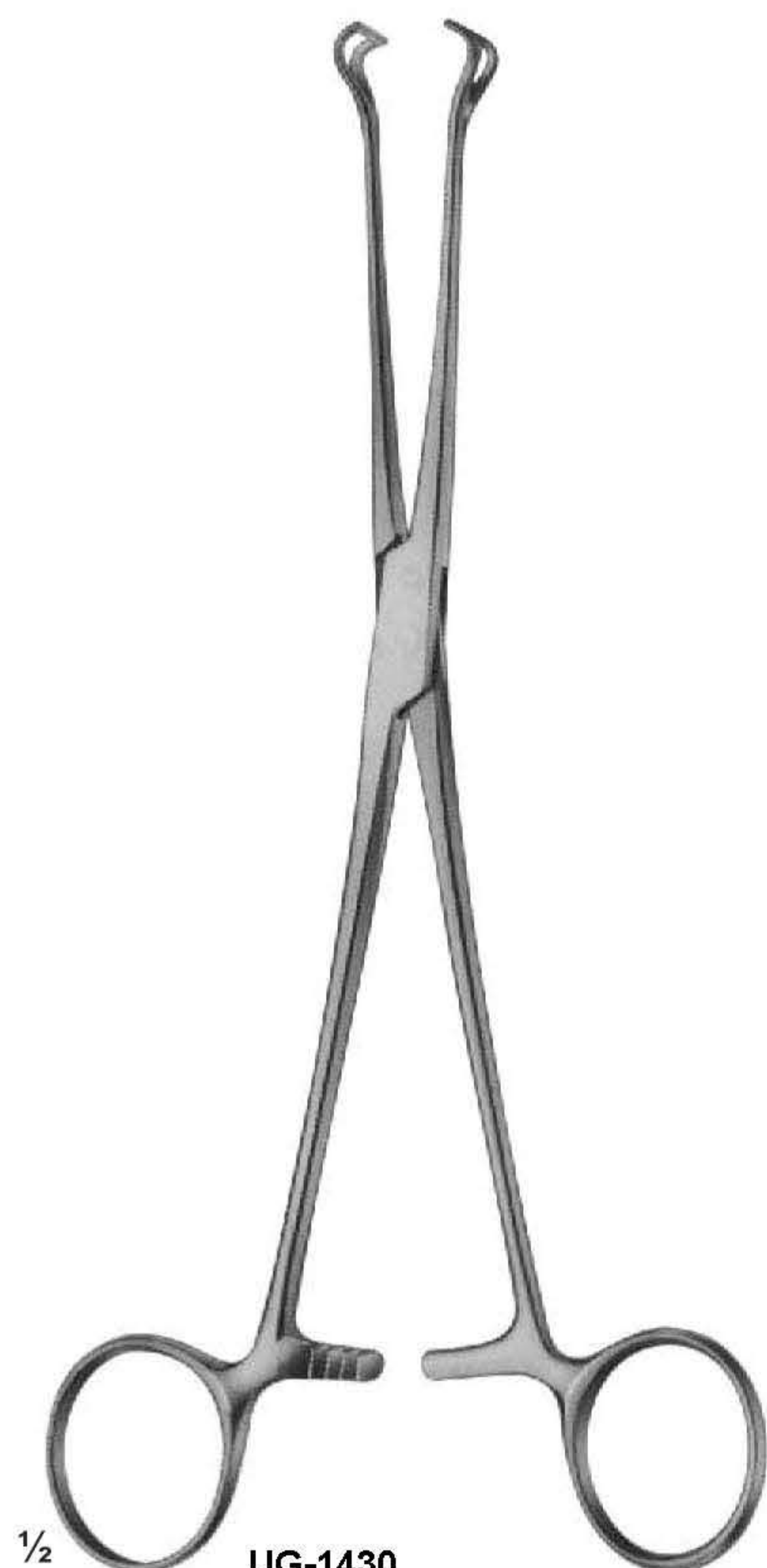

UG-1430
BABCOCK



UG-1429
ALLIS
220 mm

Multi-Purpose Clamps

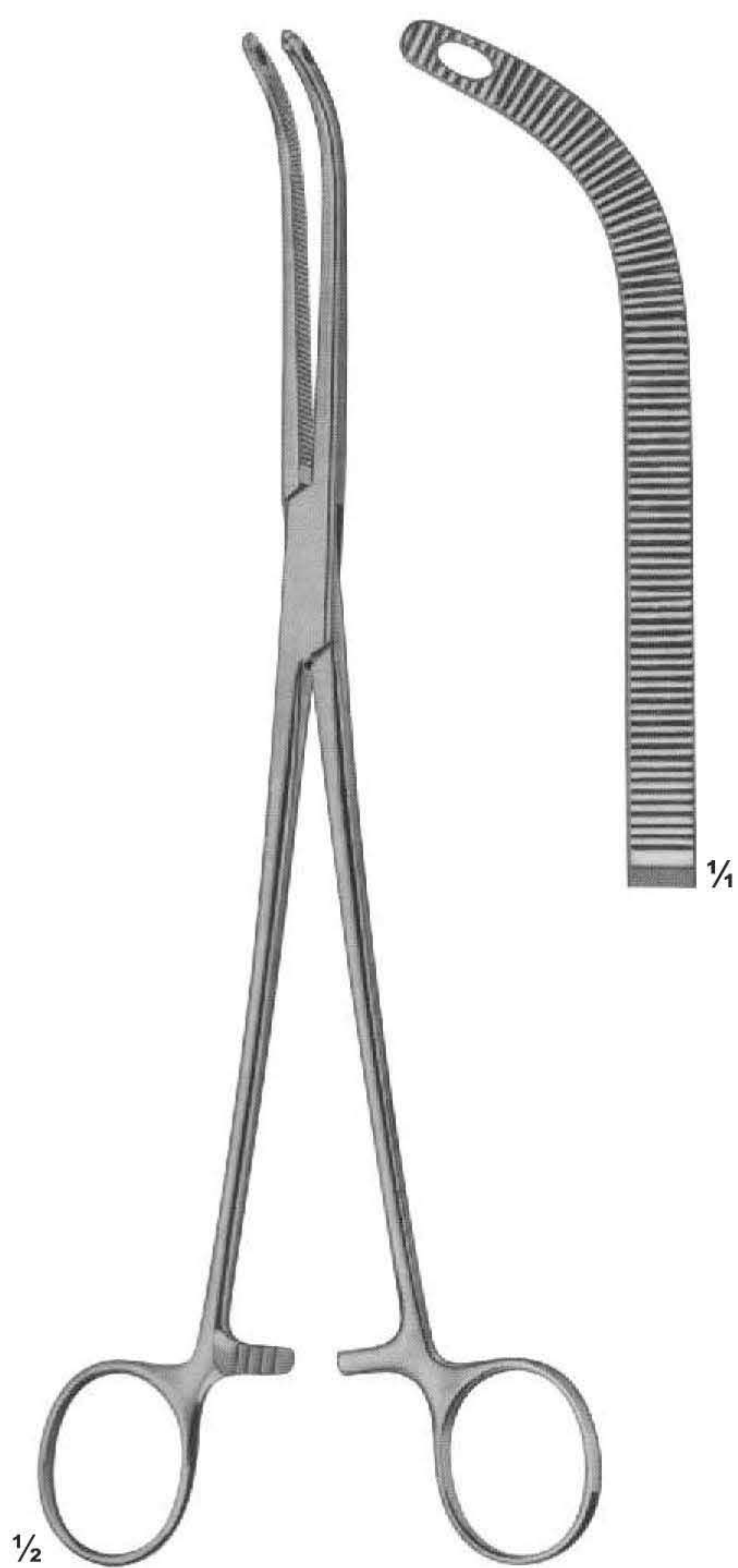

UG-1425
FINOCHIETTO
245 mm



UG-1426
SEMB
244 mm

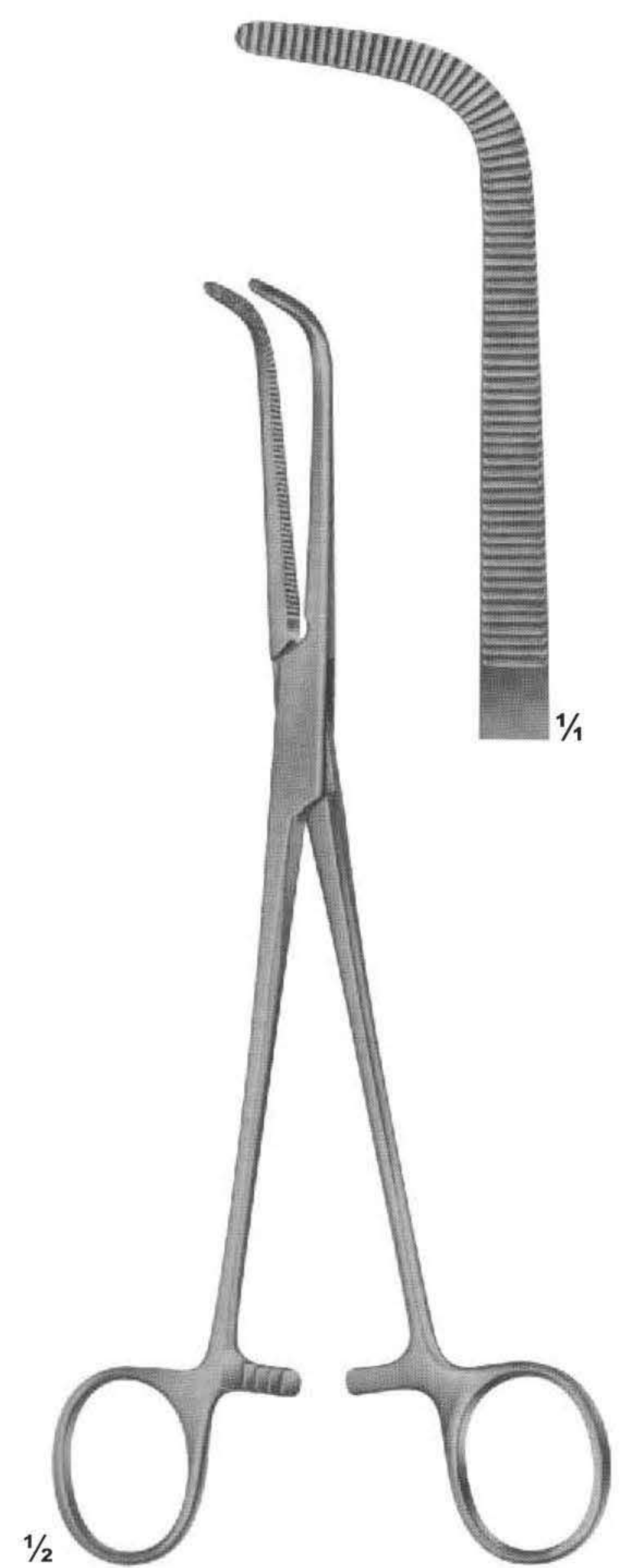

UG-1425
WIKSTROEM
205 mm

Multi-Purpose Clamps

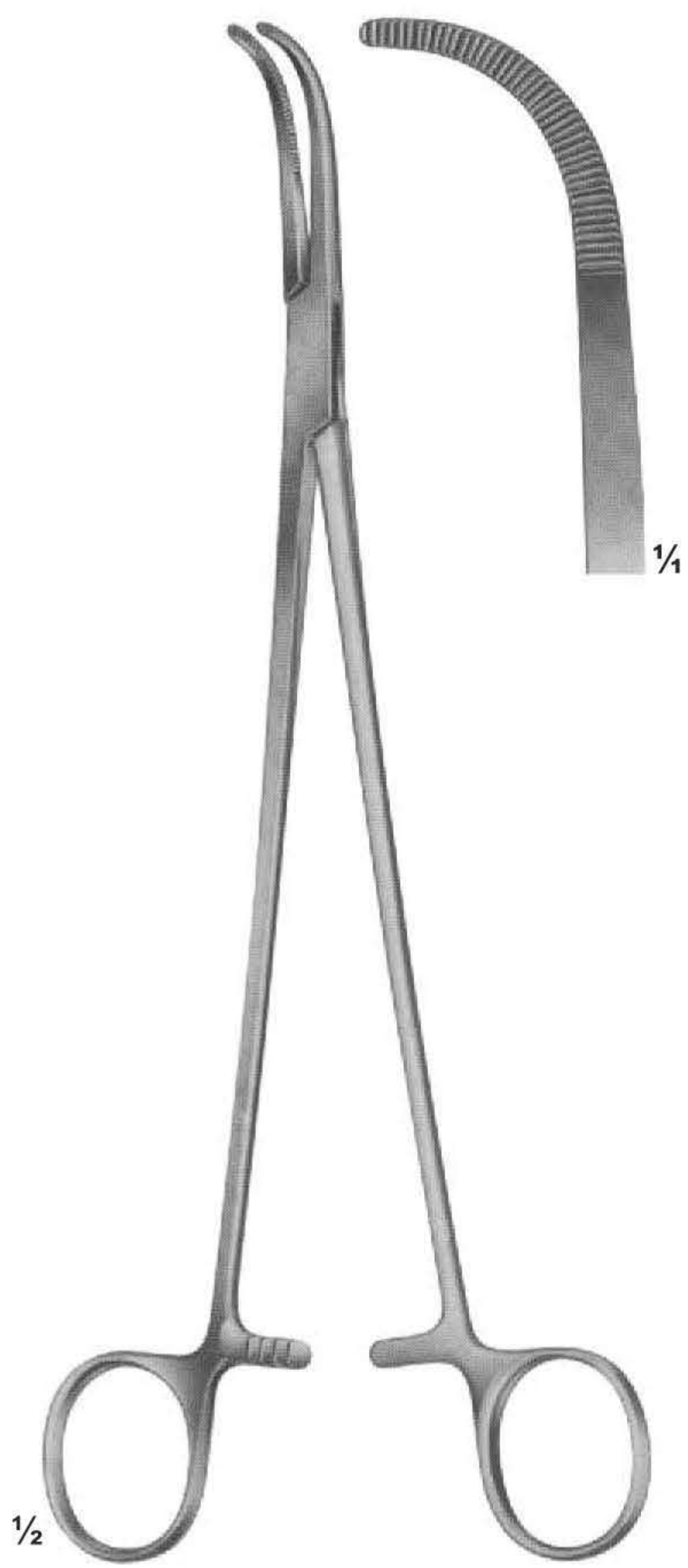

UG-1424
MIXTER
230 mm



UG-1423
MIXTER

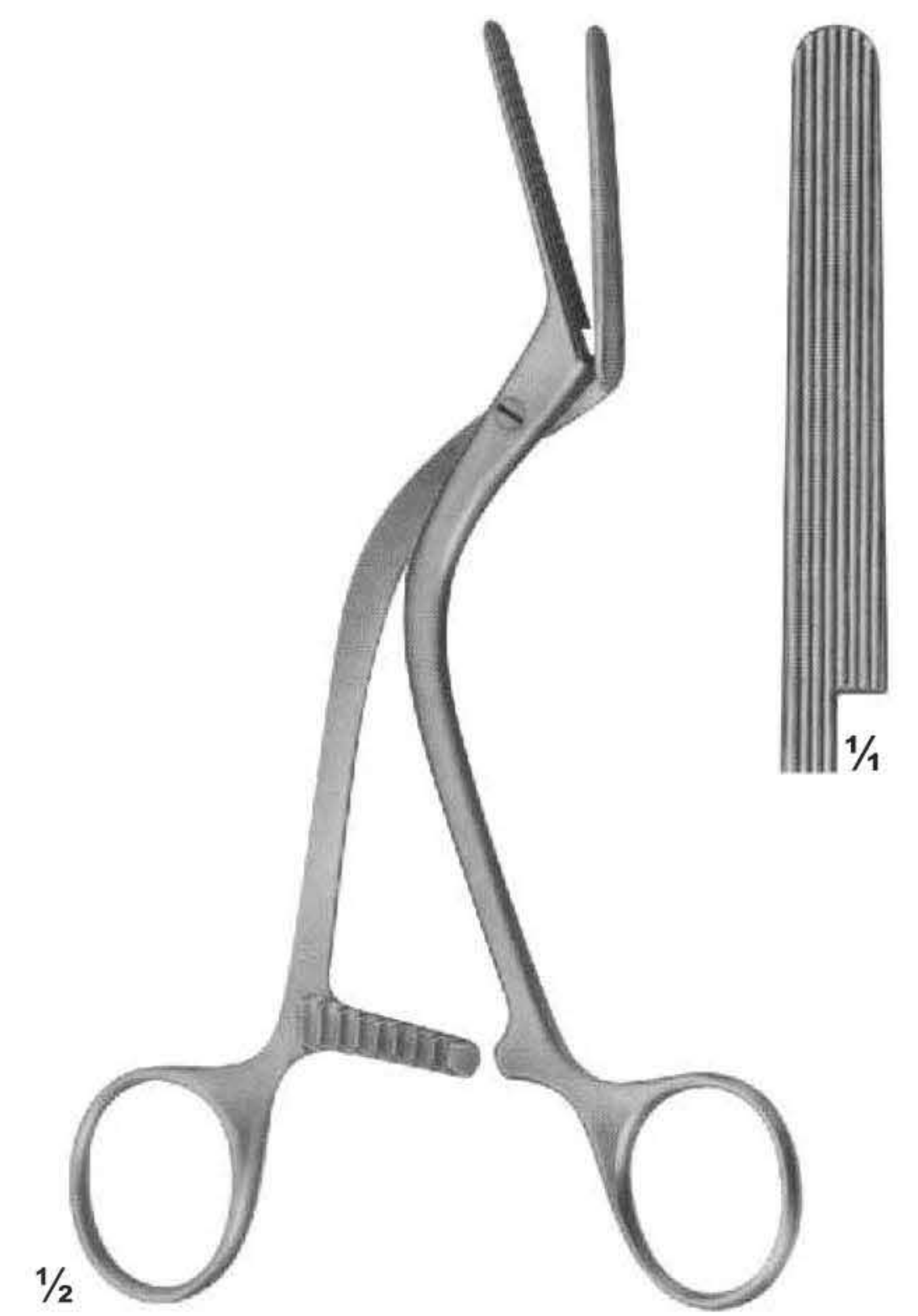

UG-1422
HOPFNER
160 mm

Multi-Purpose Clamps

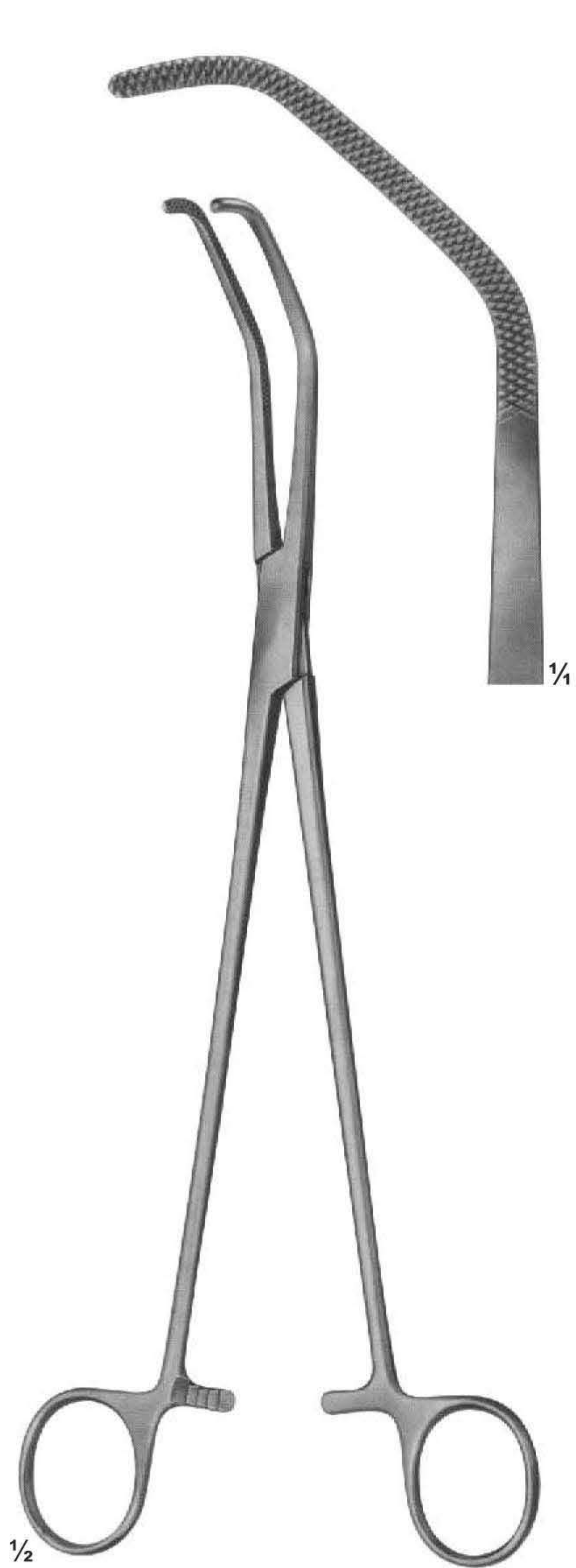

UG-1418
SATINSKY
265 mm



UG-1417
SATINSKY
265 mm

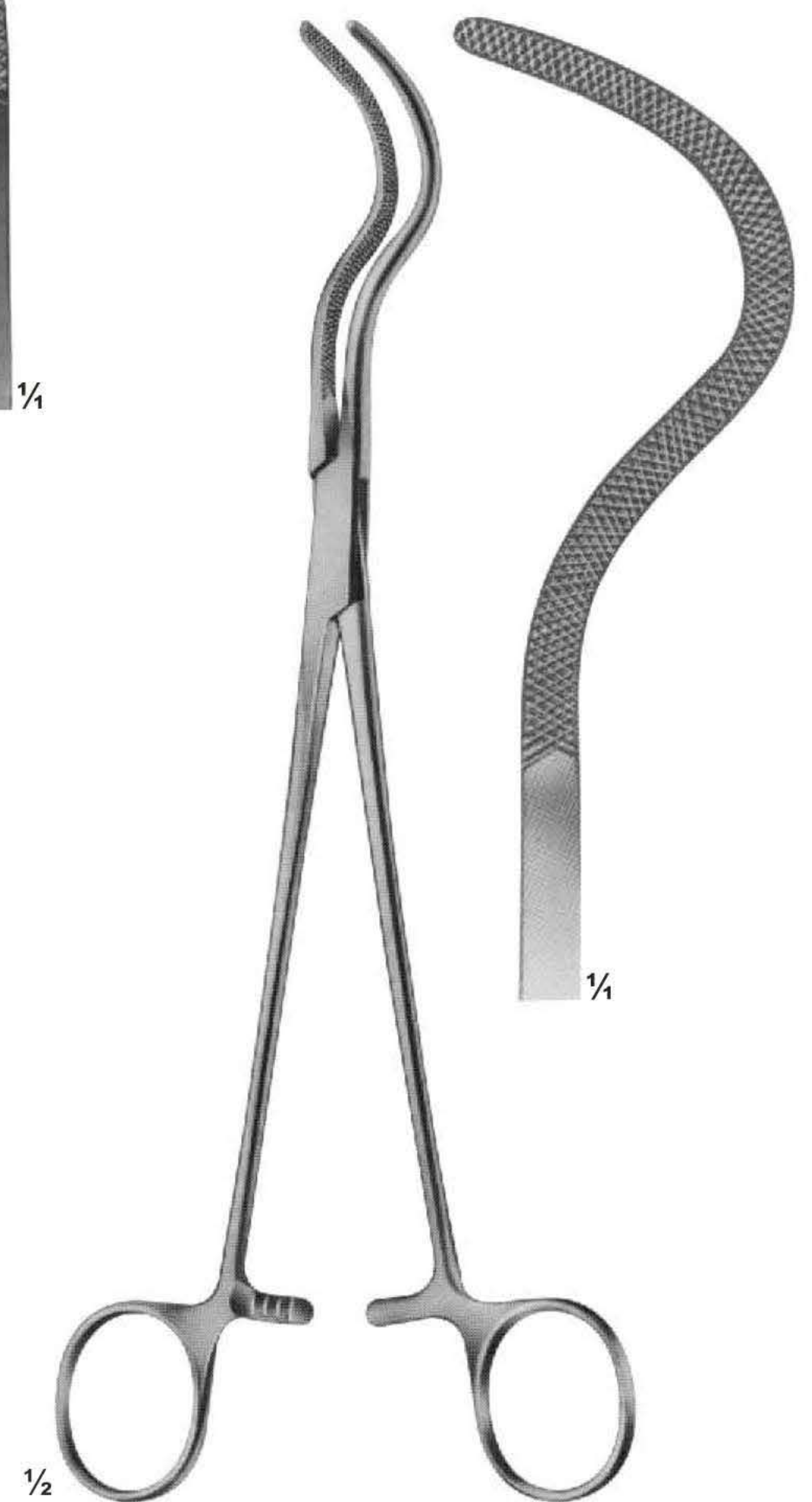

UG-1415
HARKEN
240 mm

Multi-Purpose Clamps



UG-1412
PERTUISET
Carotid Clamp
90 mm

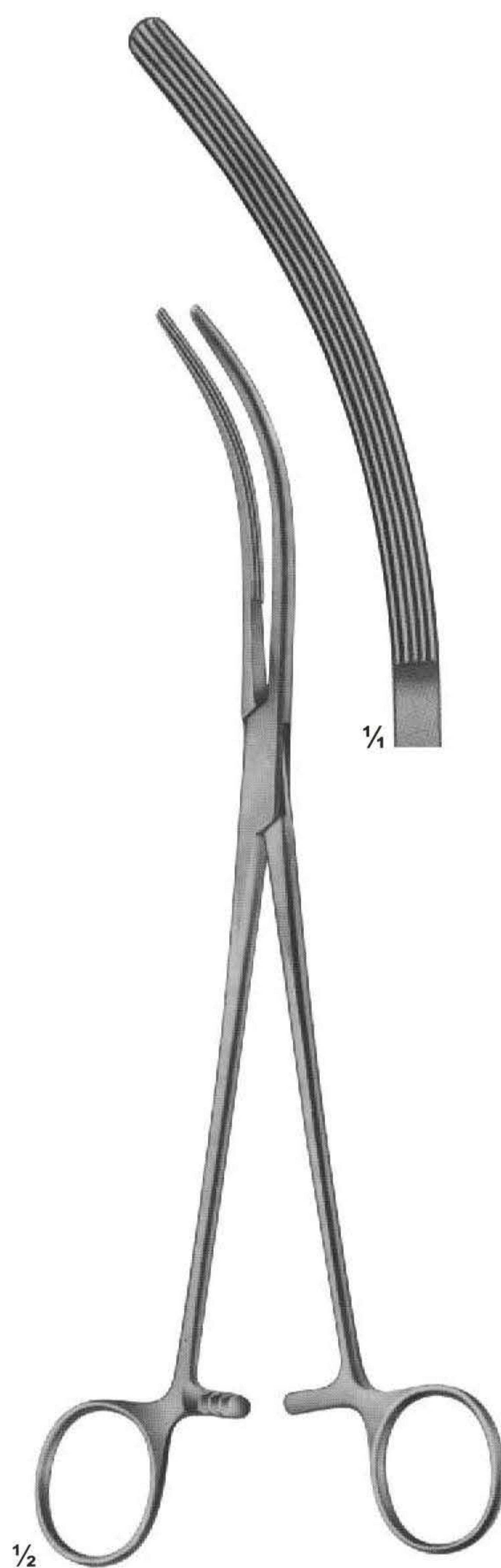

UG-1410
CRAFOORD-SELLORS
240 mm



UG-1406
CRAFOORD
240 mm

Multi-Purpose Clamps



UG-1403
PRICE THOMAS
225 mm

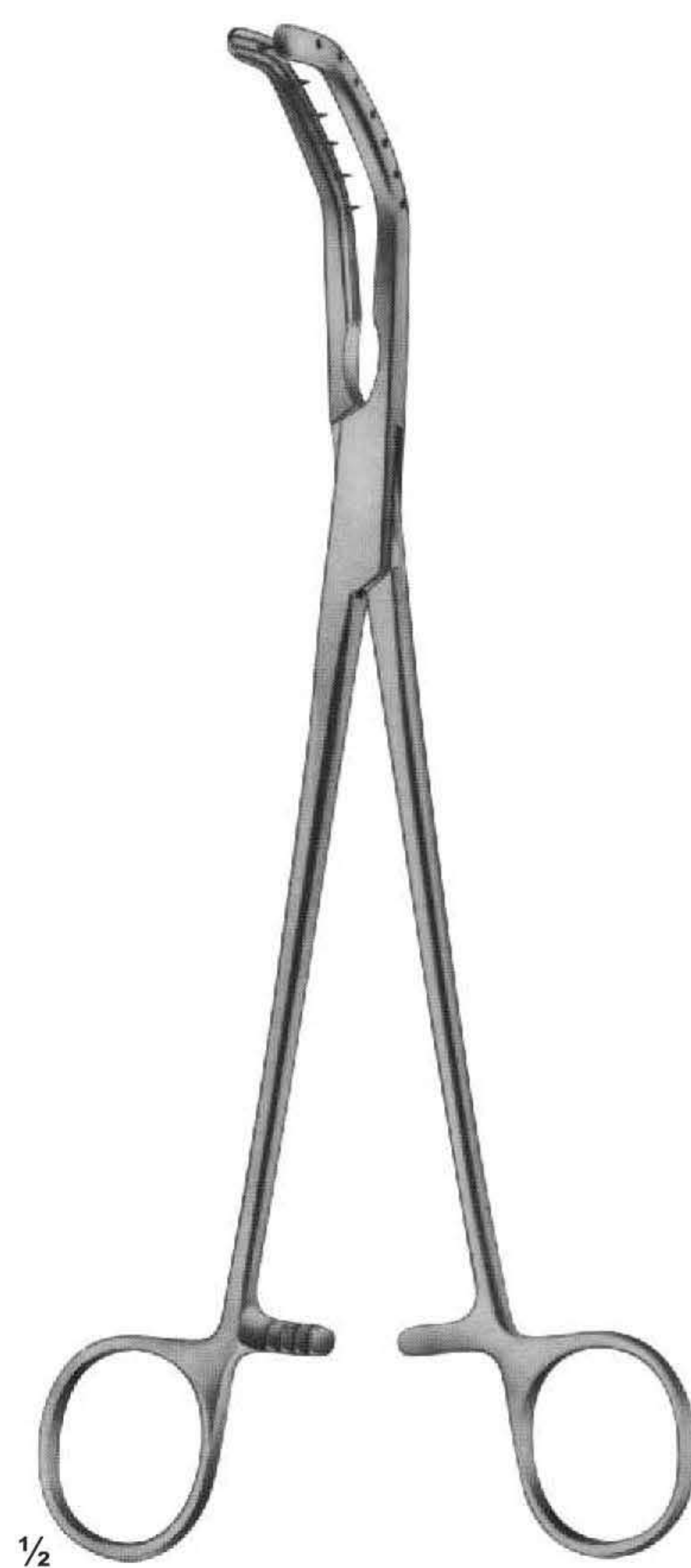

UG-1404
PRICE THOMAS
225 mm

Rib Shears



UG-1402
SCHUMACHER
Sternum shears
210 mm



UG-1401
LEBSCHKE
Sternum chisel
200 mm



UG-1399
COLLIN
195 mm

UG-1400
230 mm



UG-1397
GLUCK
190 mm



UG-1396
BRUNNER
Universal Pattern
340 mm



UG-1395
GIERTZ-STILLE
250 mm

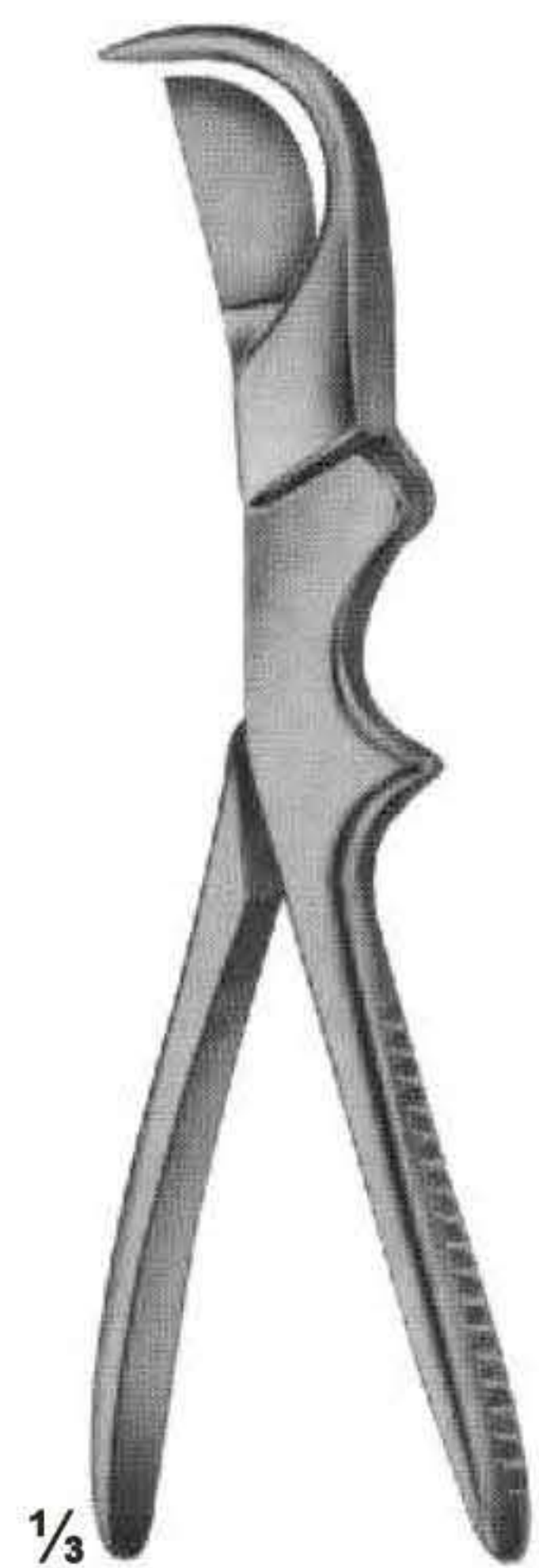

UG-1398
GLUCK
190 mm

Rib Holding Forceps, Bone Cutting Forceps



1/3

UG-1394
SEMB
Rib-and Bone
Holding forceps
190 mm



1/3

UG-1393
SEMB
Rib-and Bone
Holding forceps
190 mm



1/3

UG-1391
LISTON-STILLE
265 mm

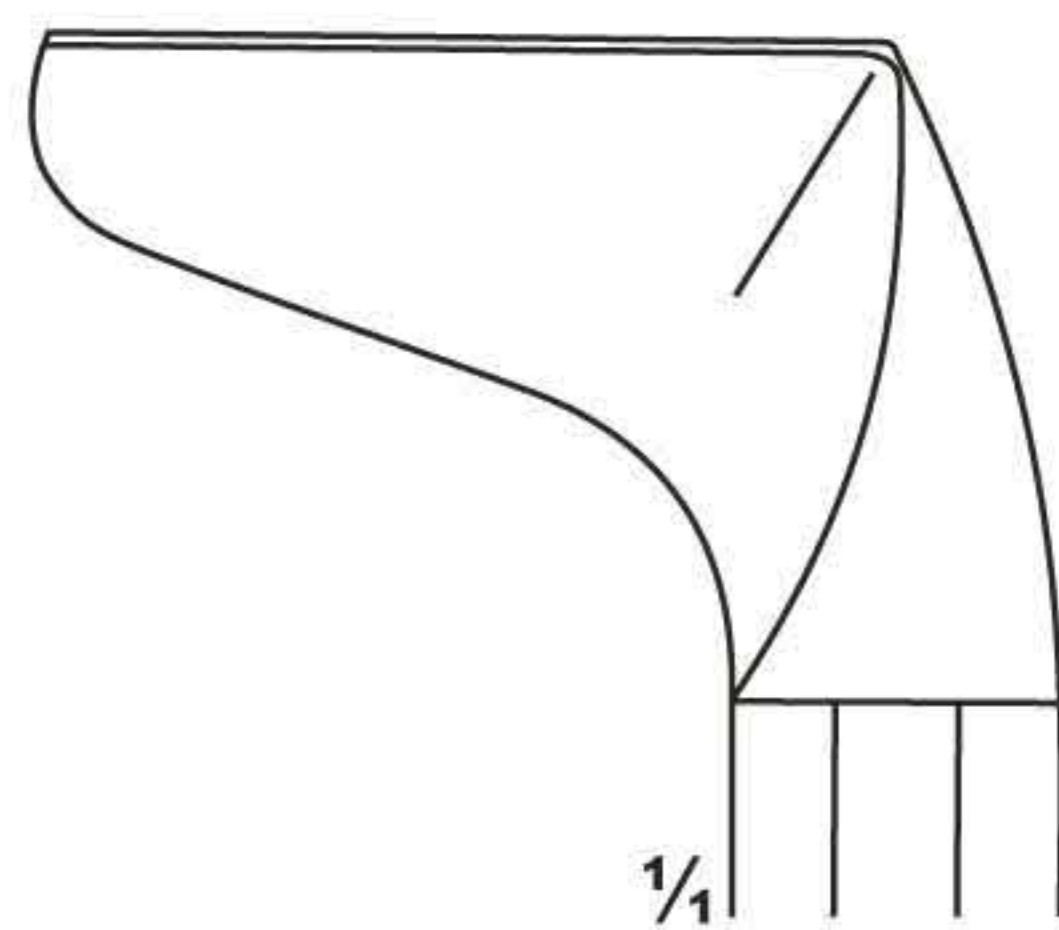

1/4

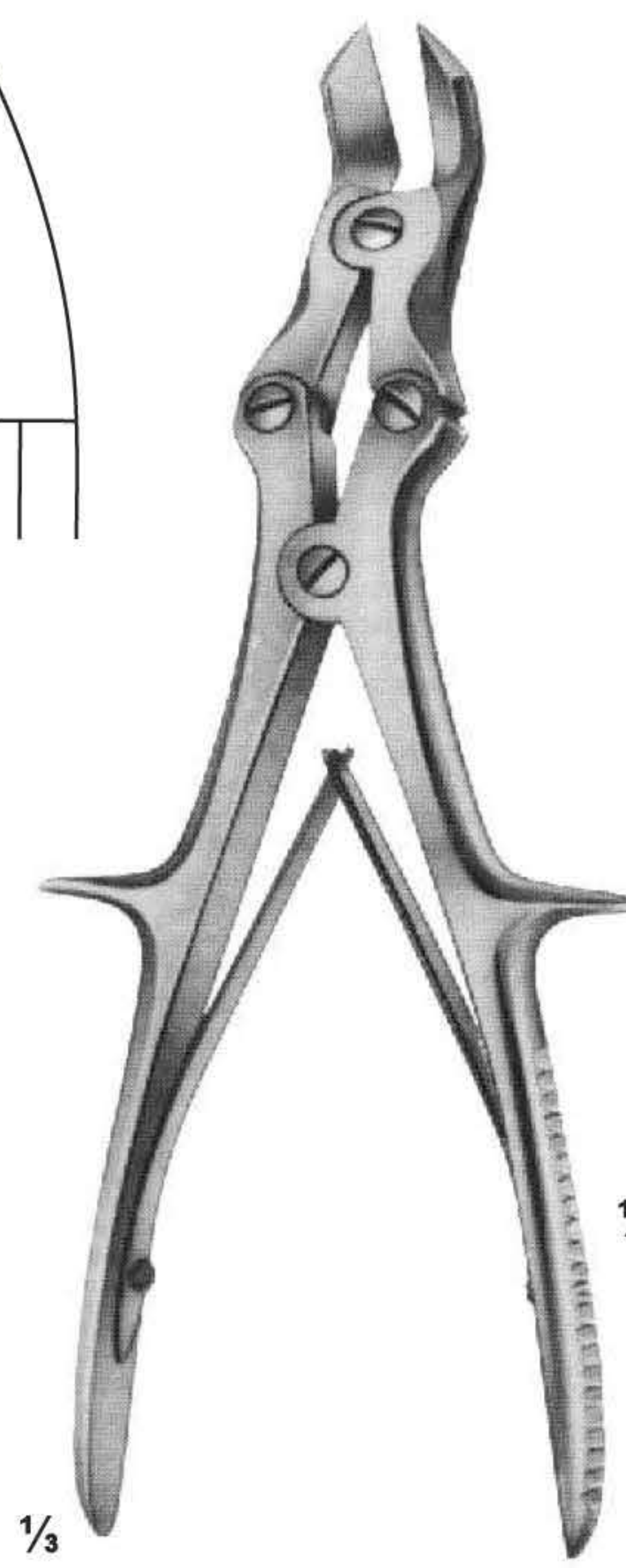

1/3

UG-1390
LISTON-KEY-HORSLEY
255 mm

1/4

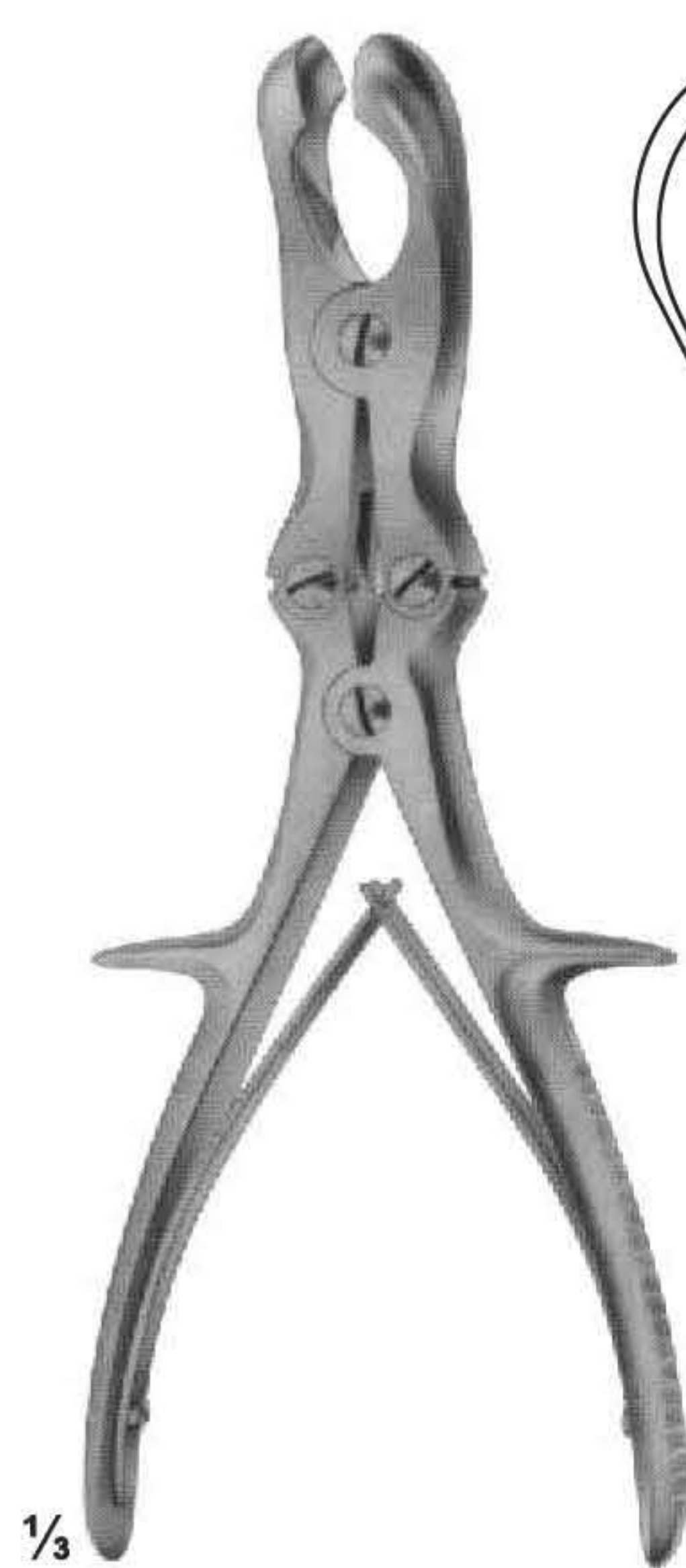
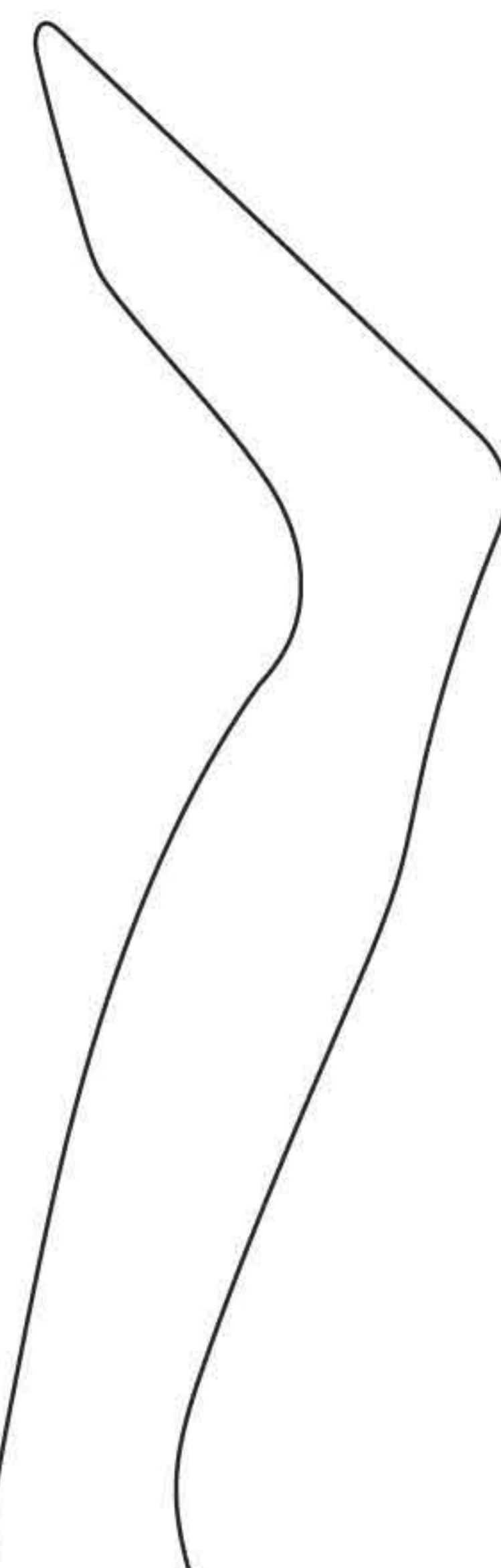

1/3

UG-1389
SEME
Rib Rongeur to shorten
the rib stumps
240 mm

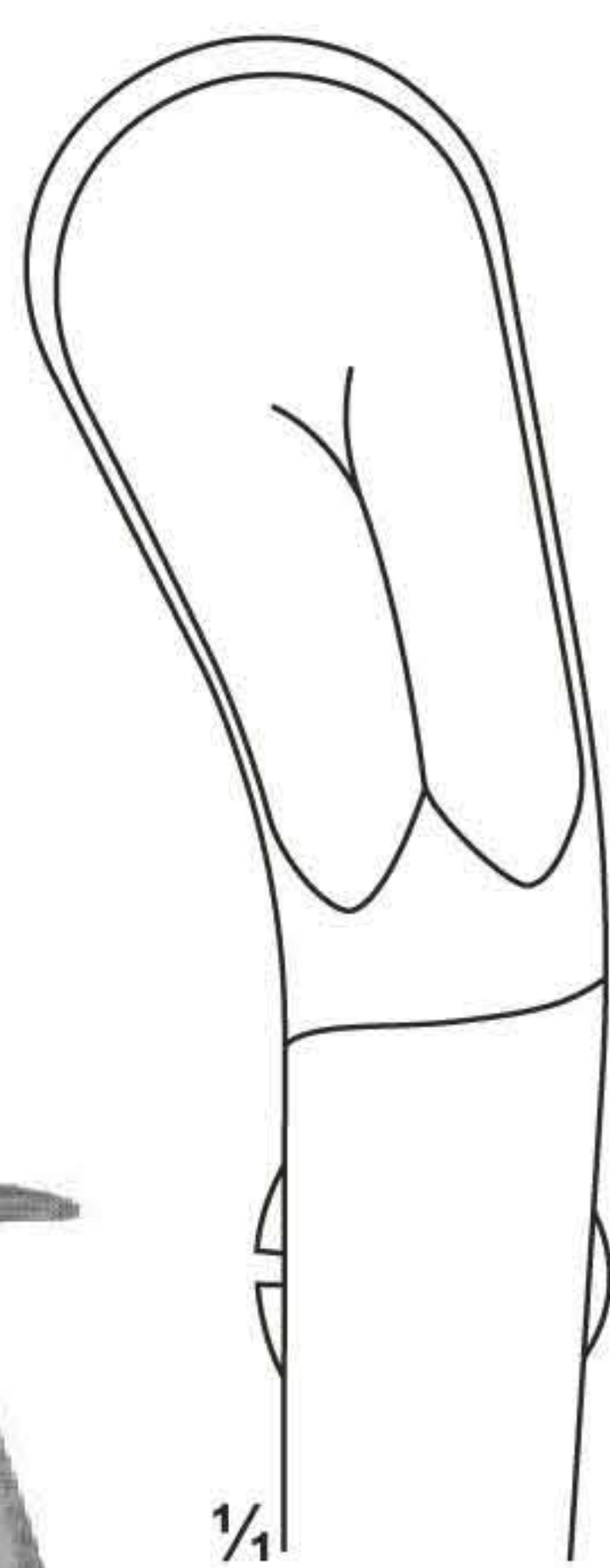

1/4



1/3

UG-1387
SAUERDRUCH-CORYLLOS
Rib rongeurs to shortn
the rib stumbes
310 mm



1/3

UG-1385
MARKWALDER
Rib Rongeur to Round
the rib stumps
190 mm

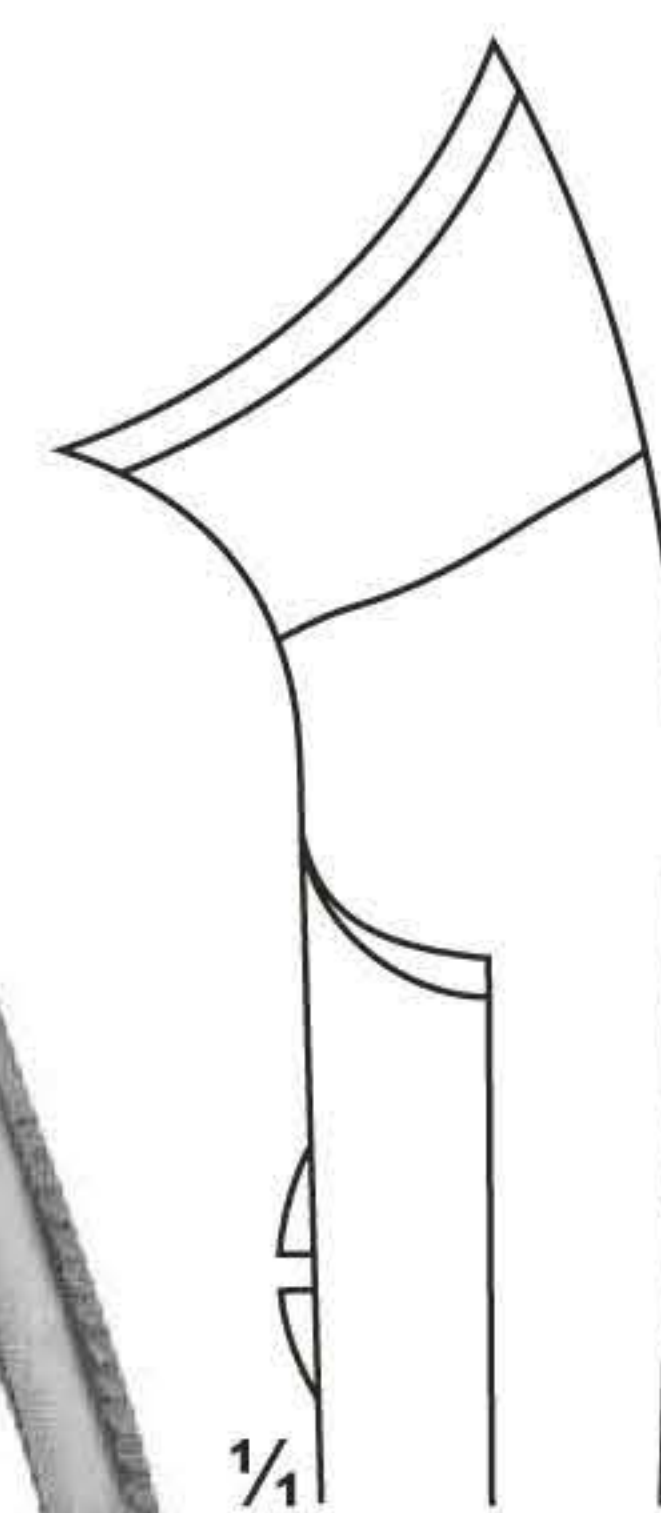

1/4

Rib Raspatories



UG-1383
DOYEN
for children
175 mm



UG-1382
DOYEN
for adults
175 mm



UG-1380
DOYEN
240 mm

Rib Raspatories



1/2
UG-1378
 SEMB
 230 mm

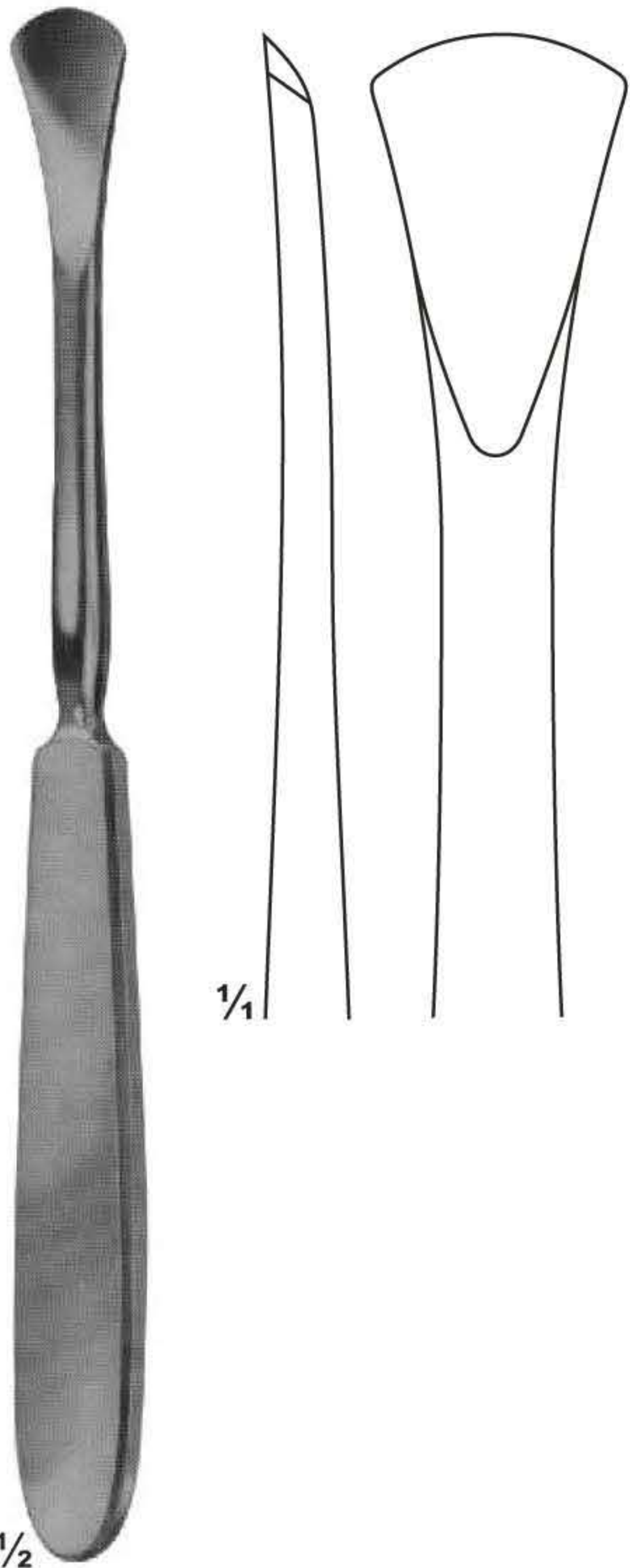

1/2
UG-1376
 LANGENBECK
 190 mm

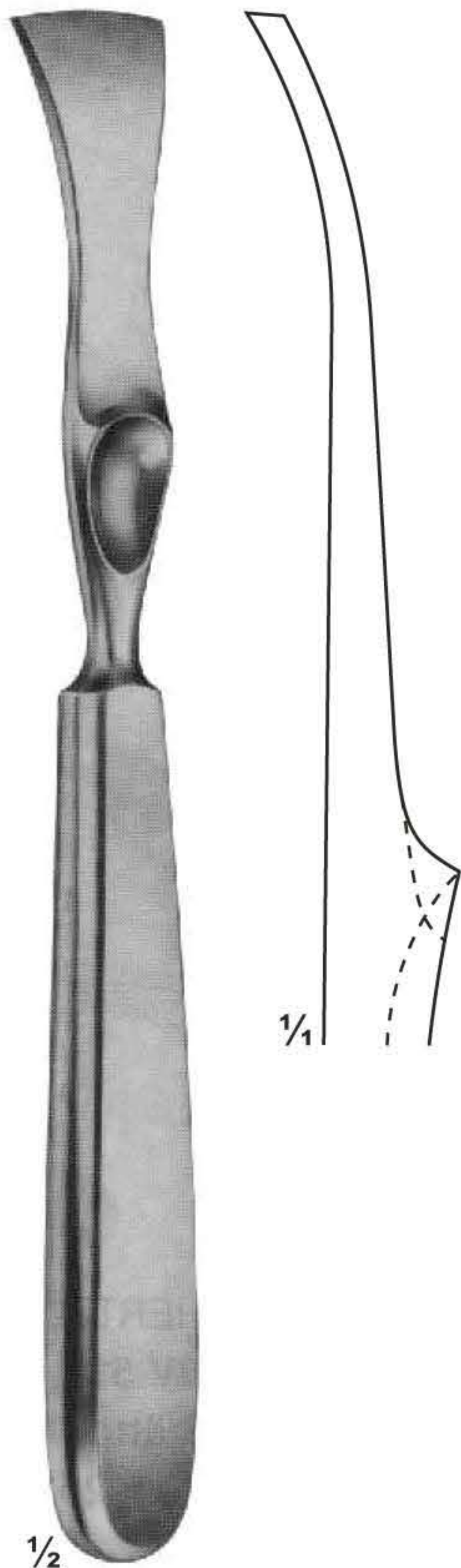

1/2
UG-1372
 LAMBOTTE
 215 mm

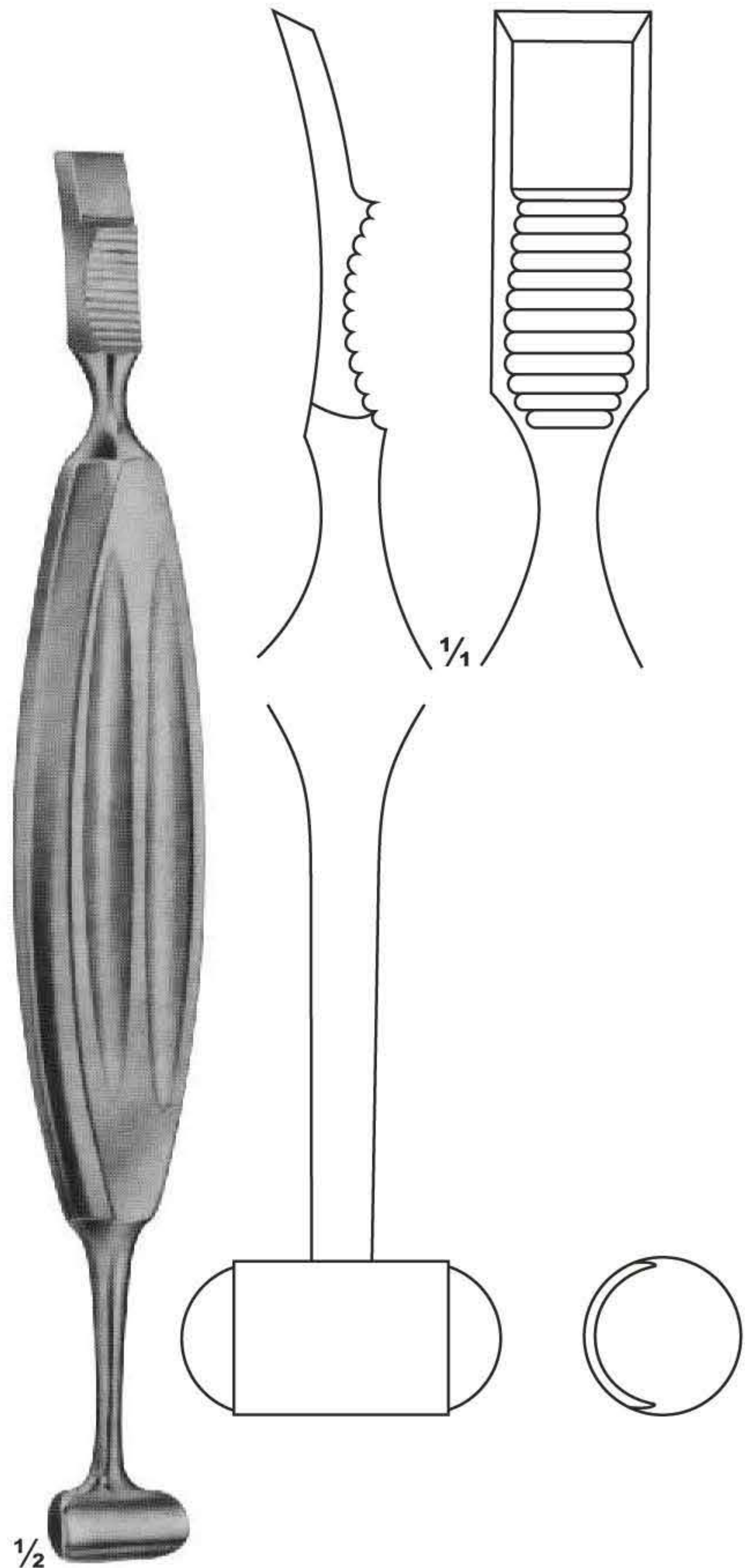

1/2
UG-1370
 ALEXANDER
 210 mm

Rib Spreaders

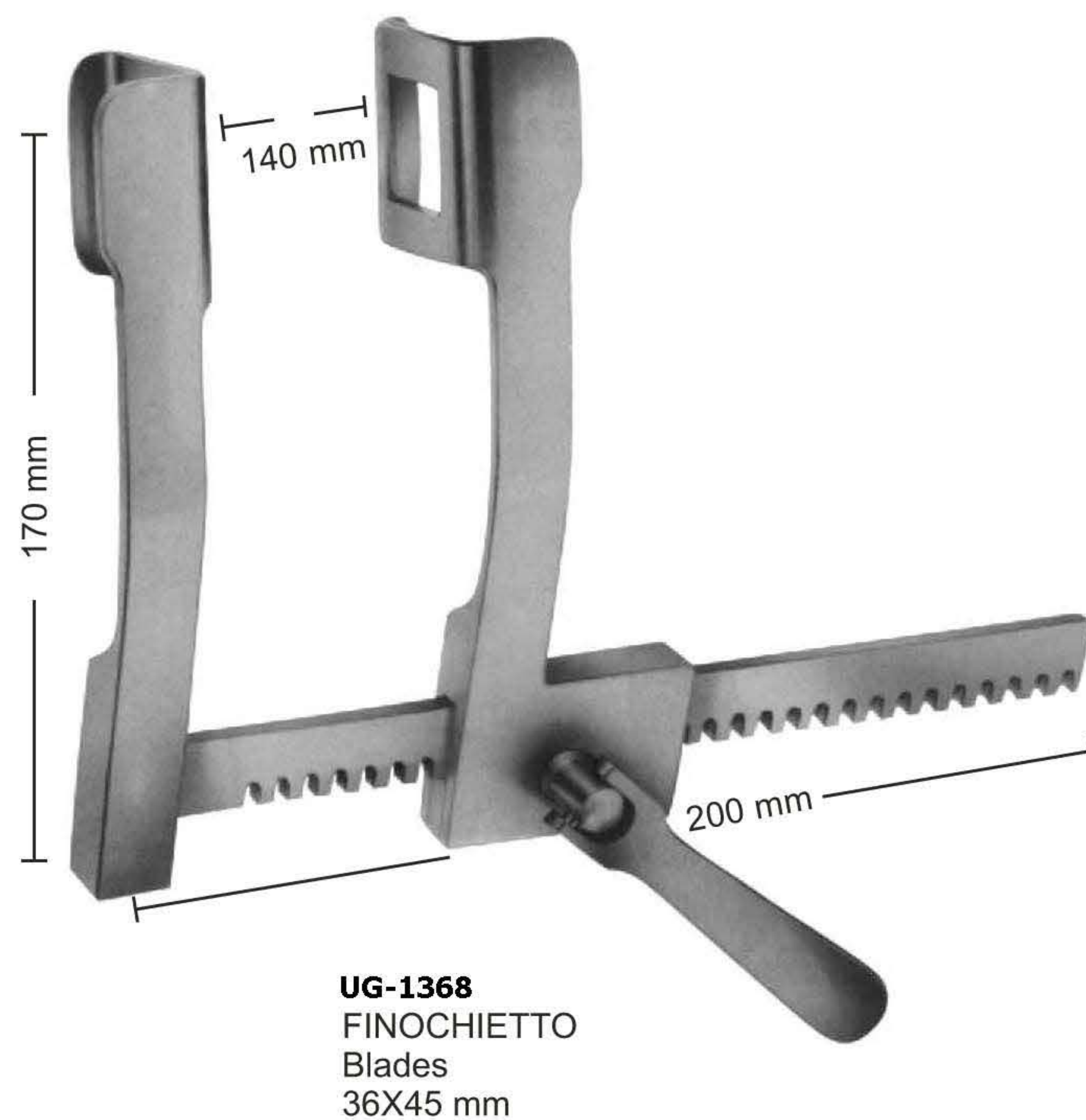
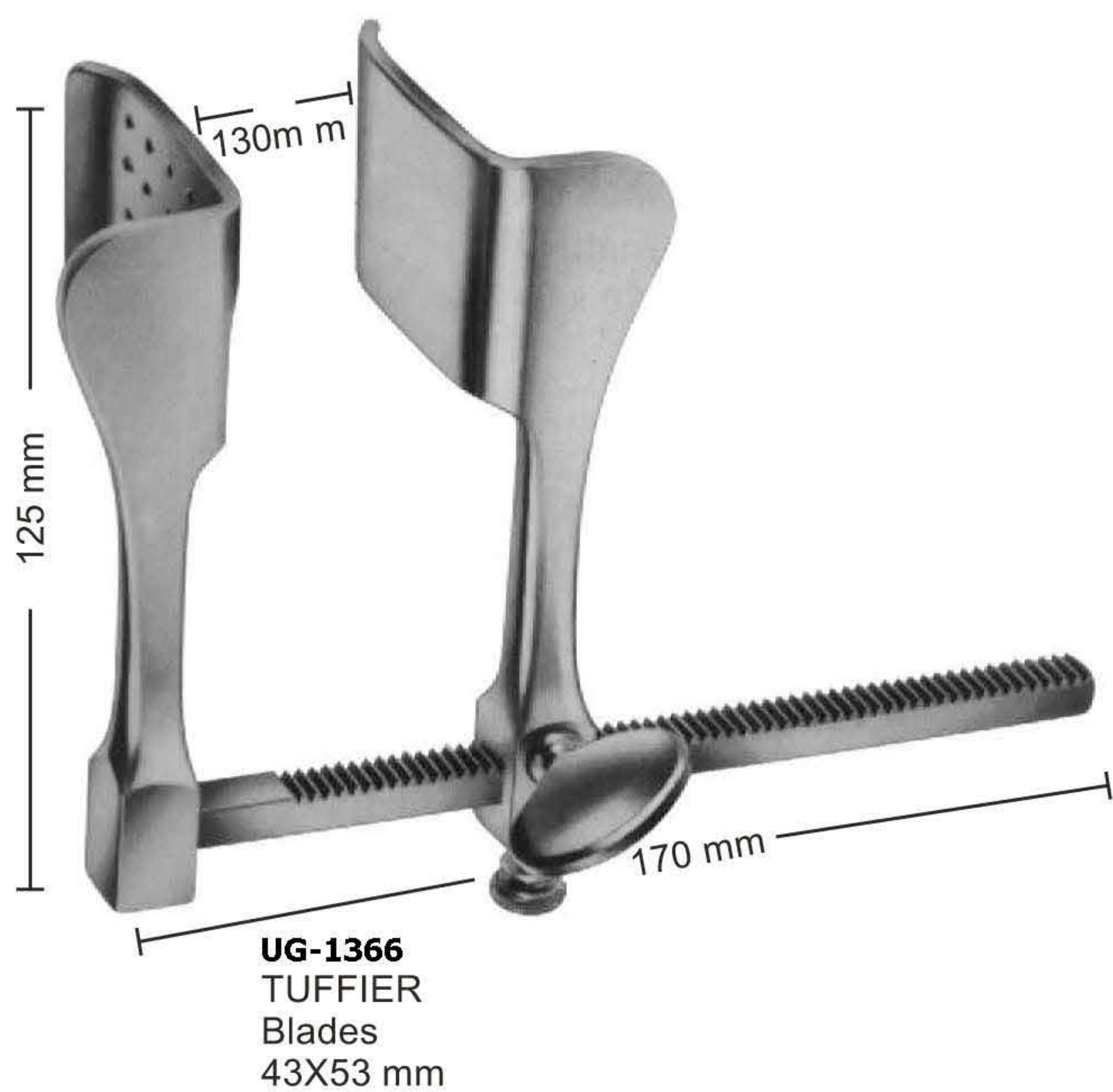
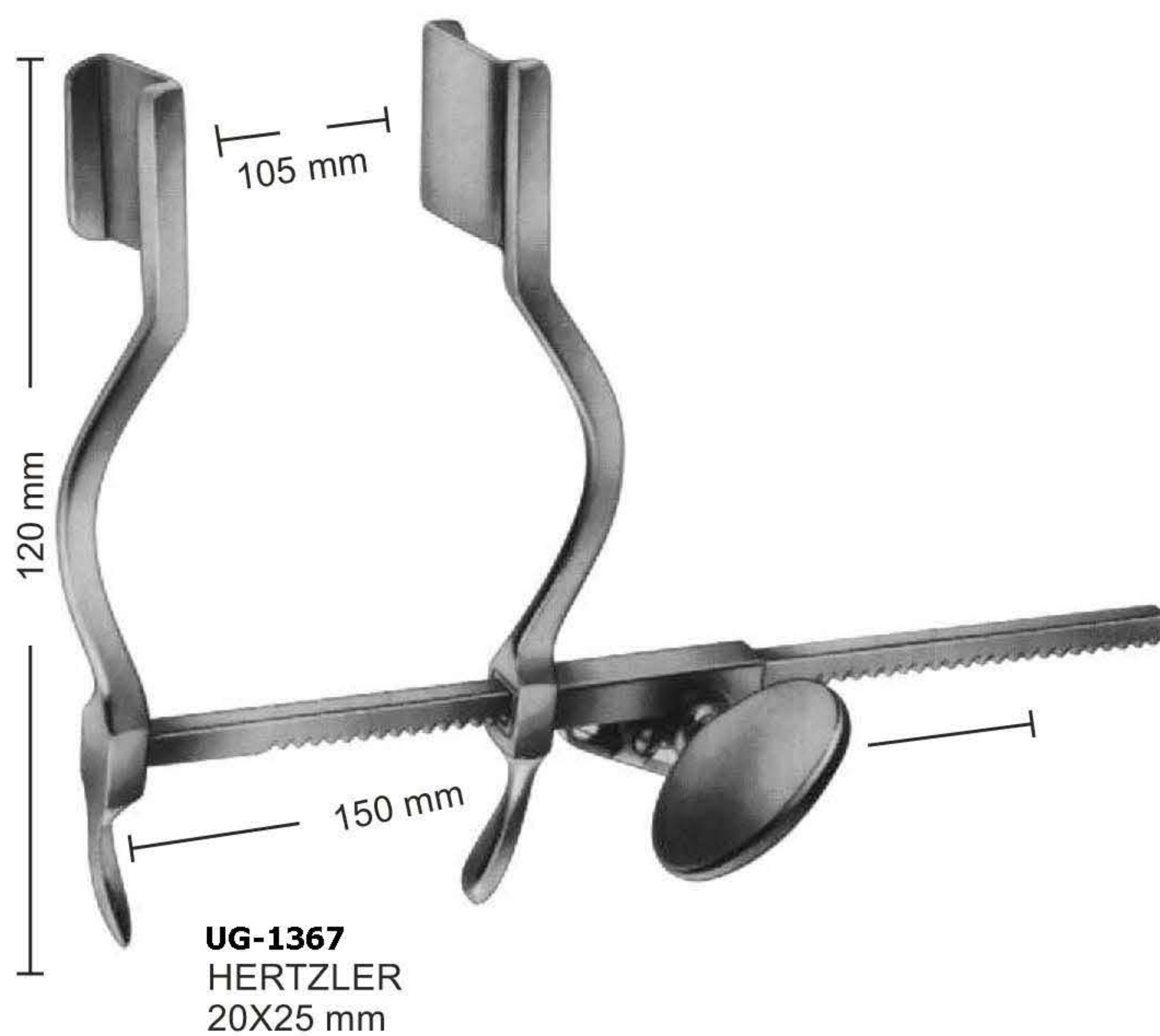
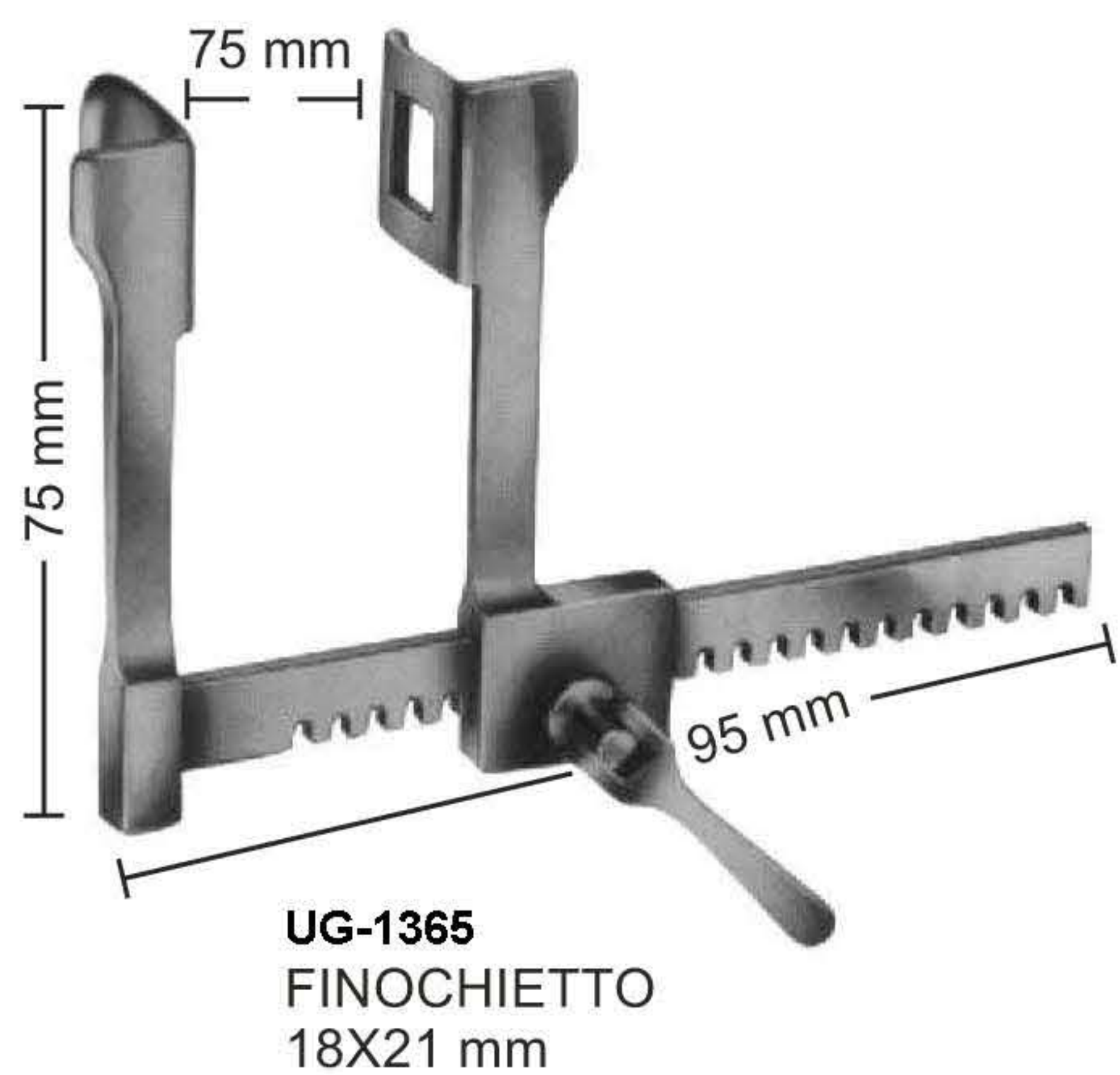

Rib Spreaders

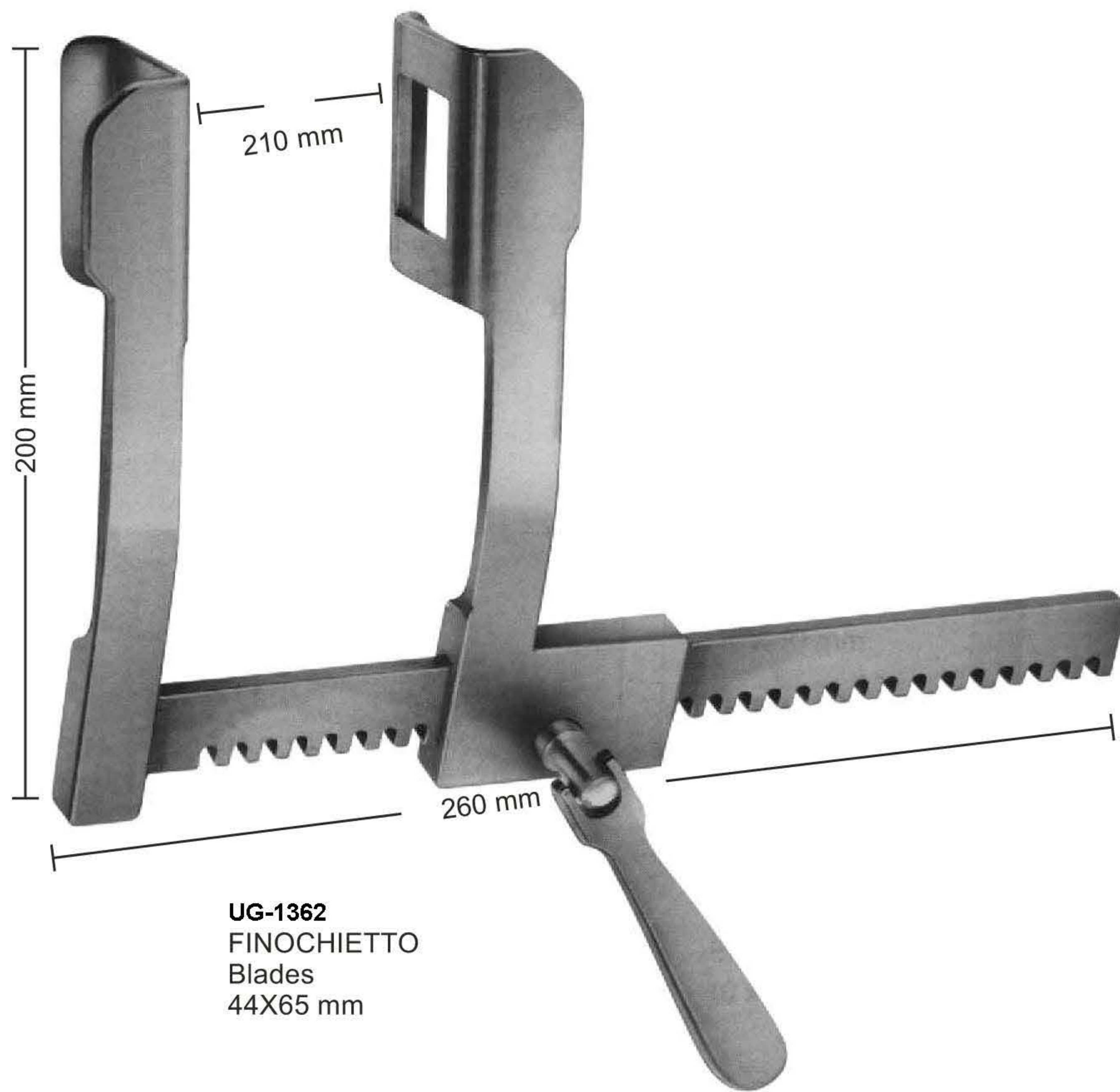

UG-1362
FINOCHIETTO
Blades
44X65 mm

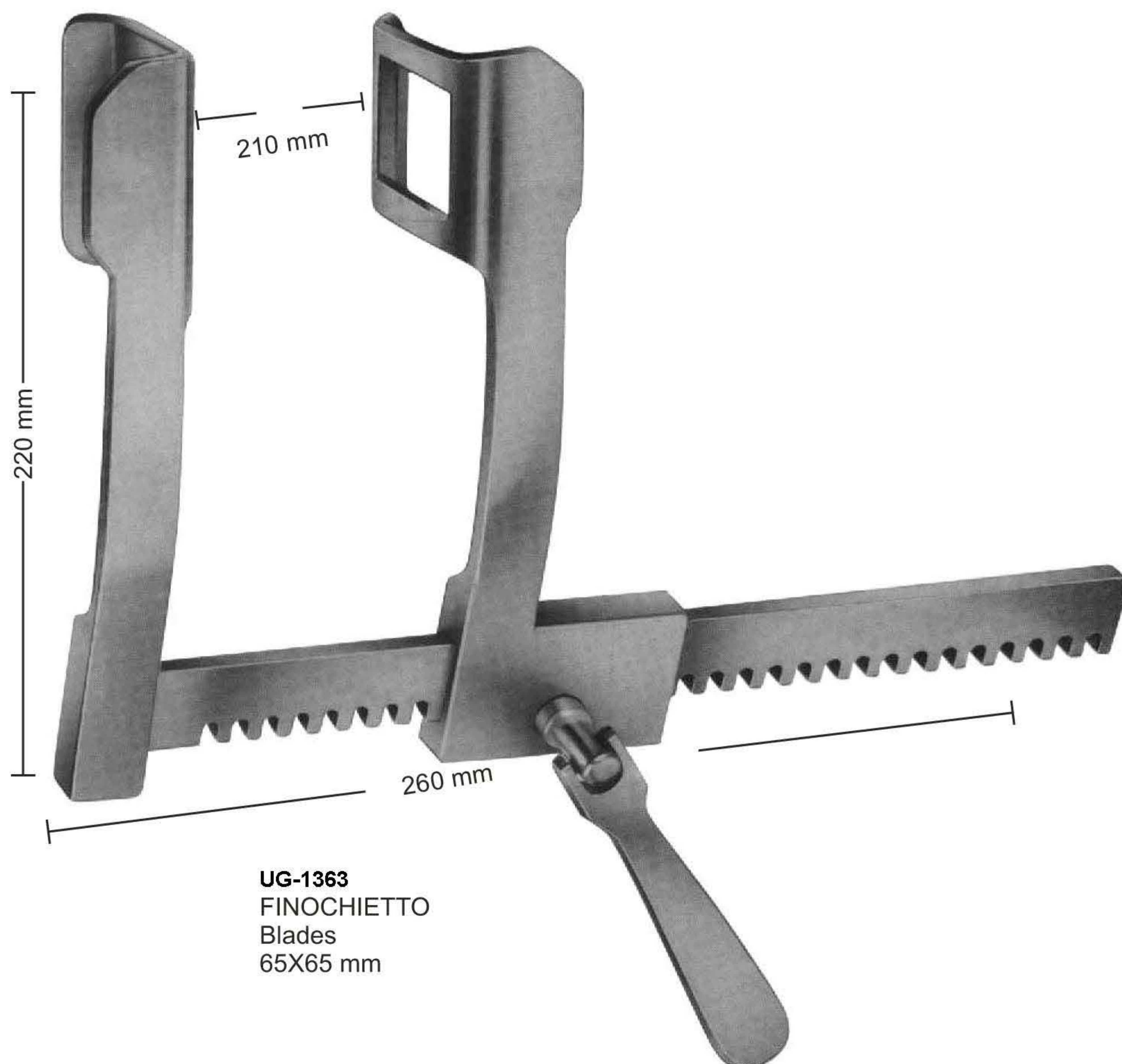

UG-1363
FINOCHIETTO
Blades
65X65 mm

Rib Spreaders

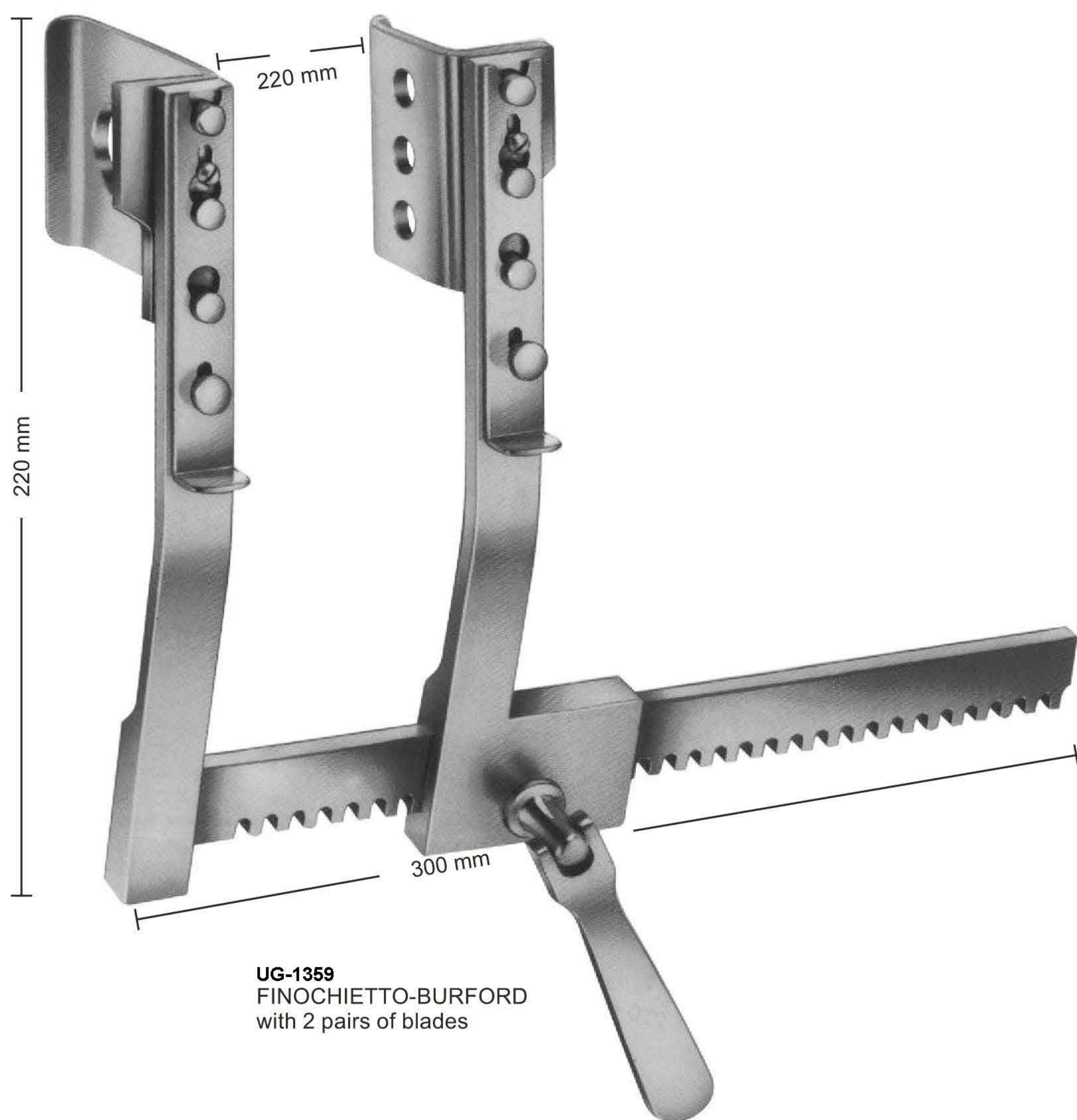

Rib Spreaders

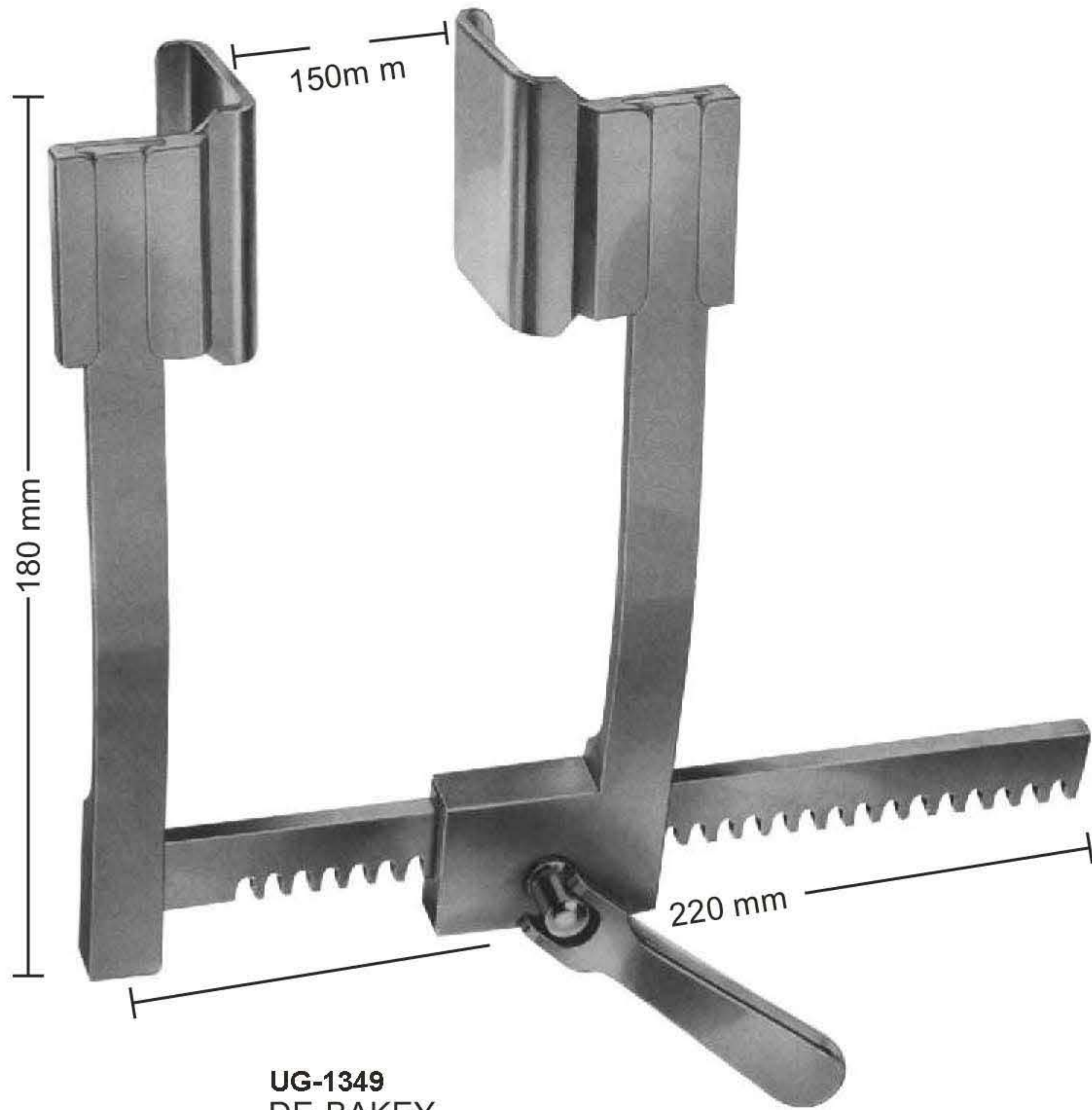

UG-1349
DE-BAKEY
with 3 pairs of blades

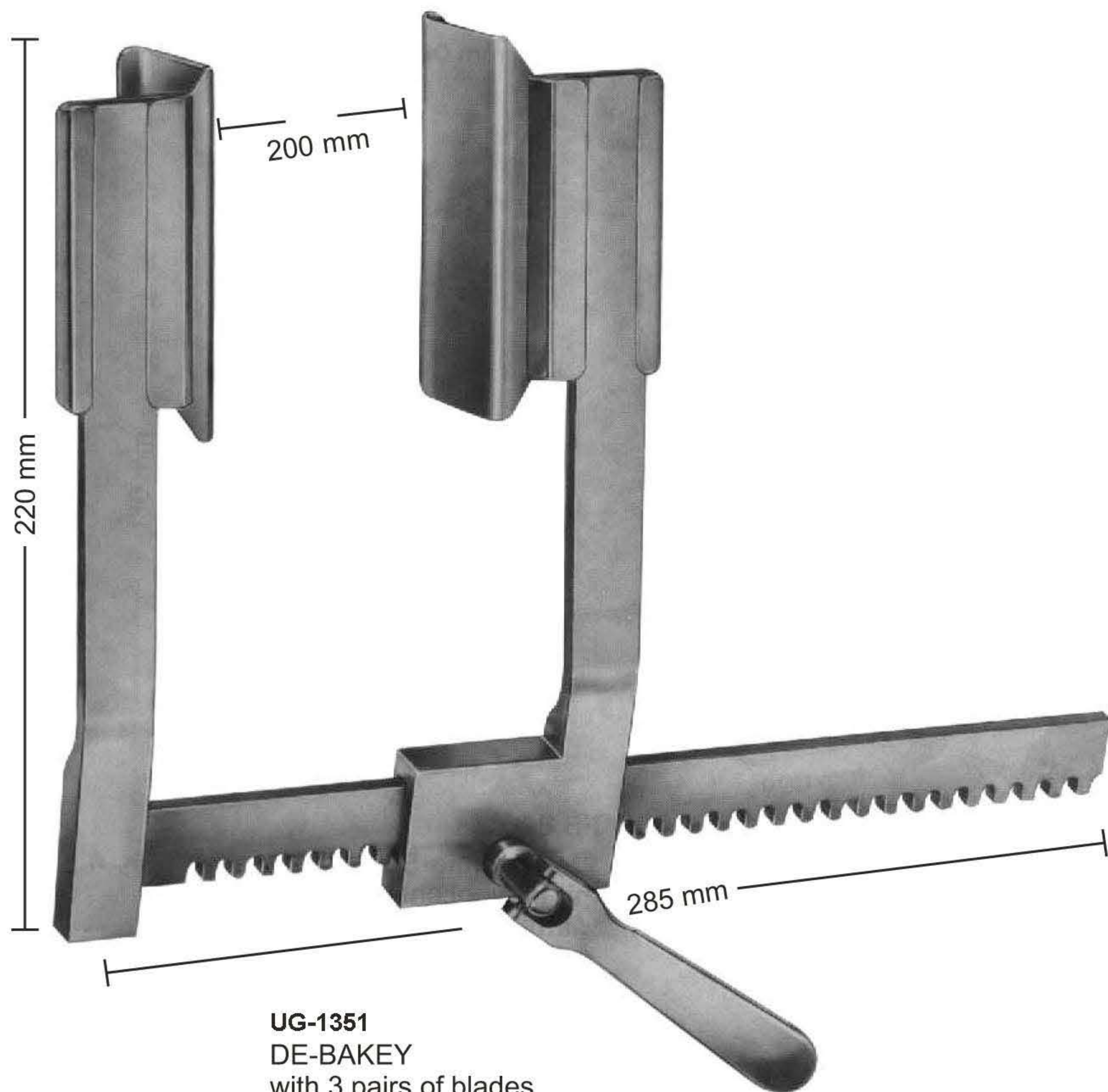

UG-1351
DE-BAKEY
with 3 pairs of blades

Sternotomy Spreaders

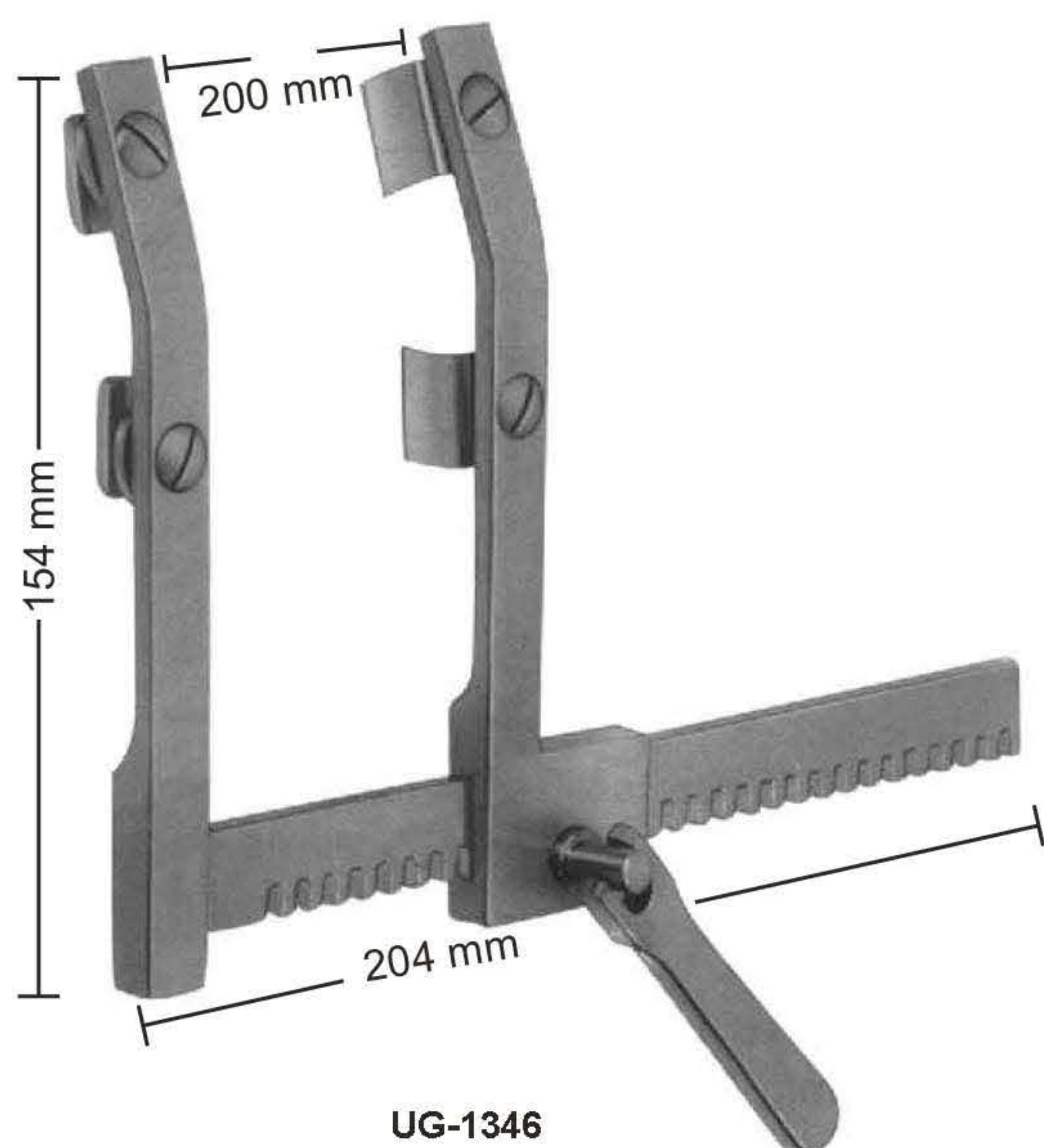

UG-1346
MORSE
Sternotomy spreader
for children, with moveable
double, each blade
12x20 mm

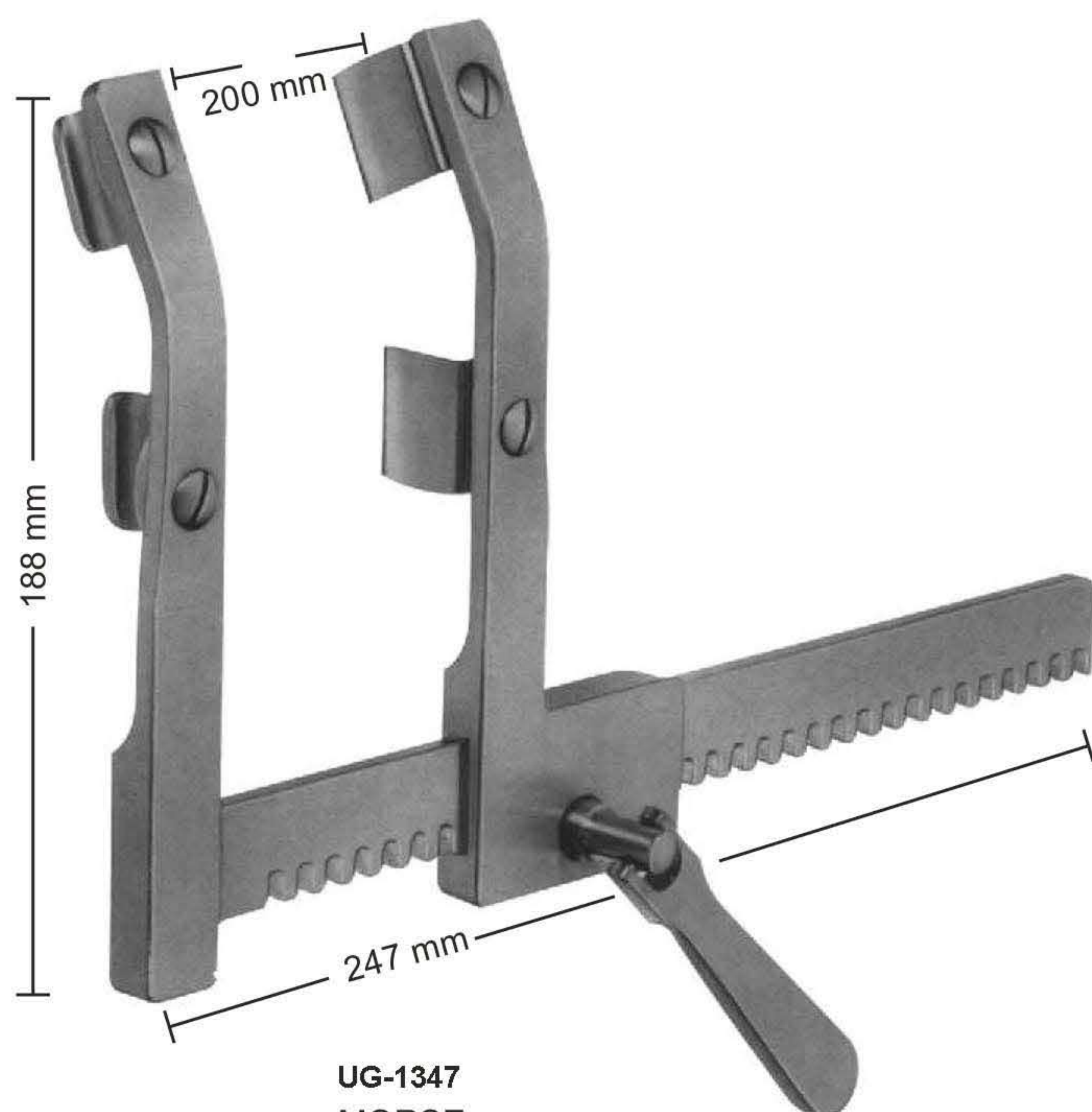

UG-1347
MORSE
Sternotomy spreader
for adults, with moveable
double, each blade
19x19 mm

Sternotomy- Spreaders

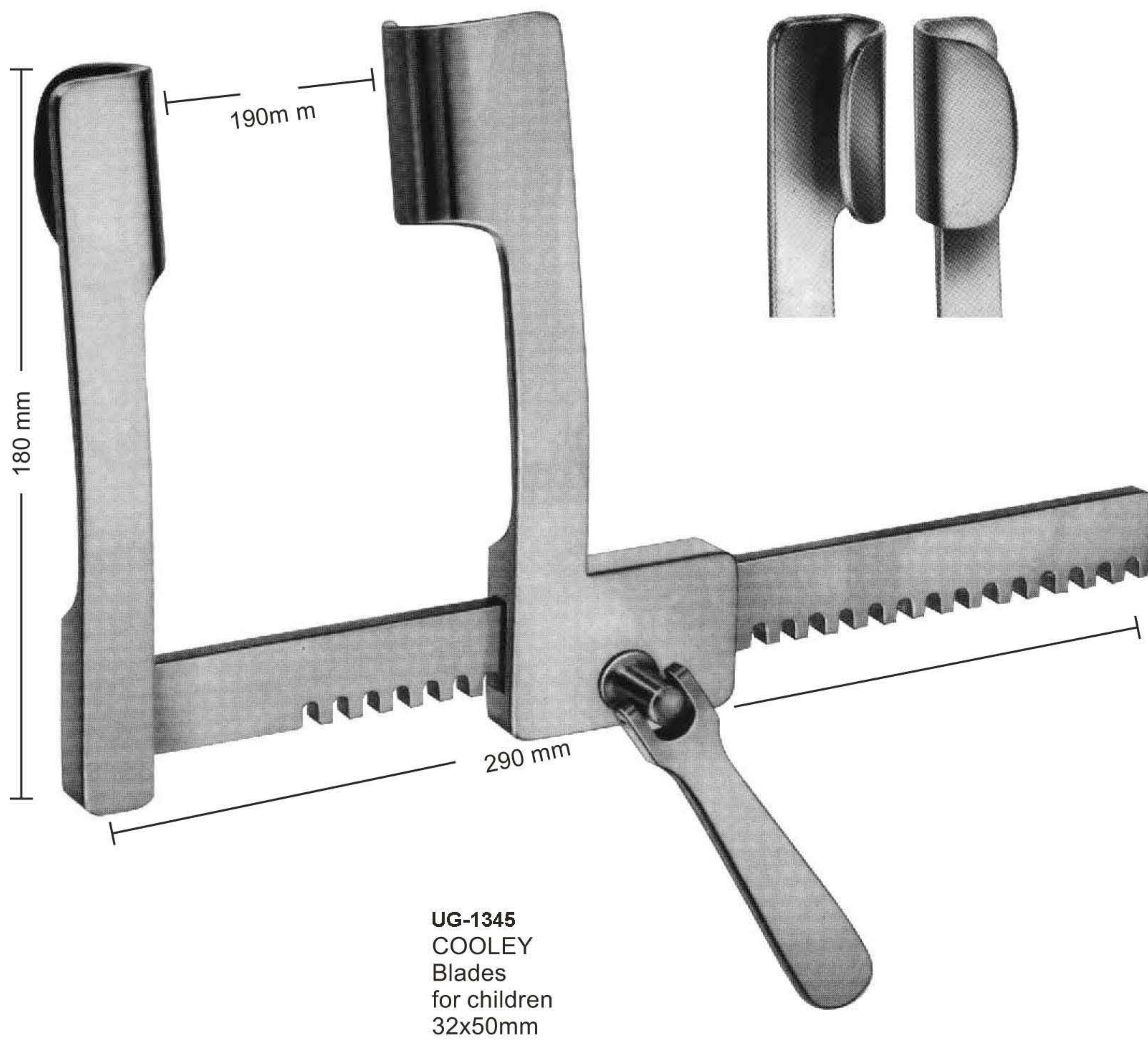
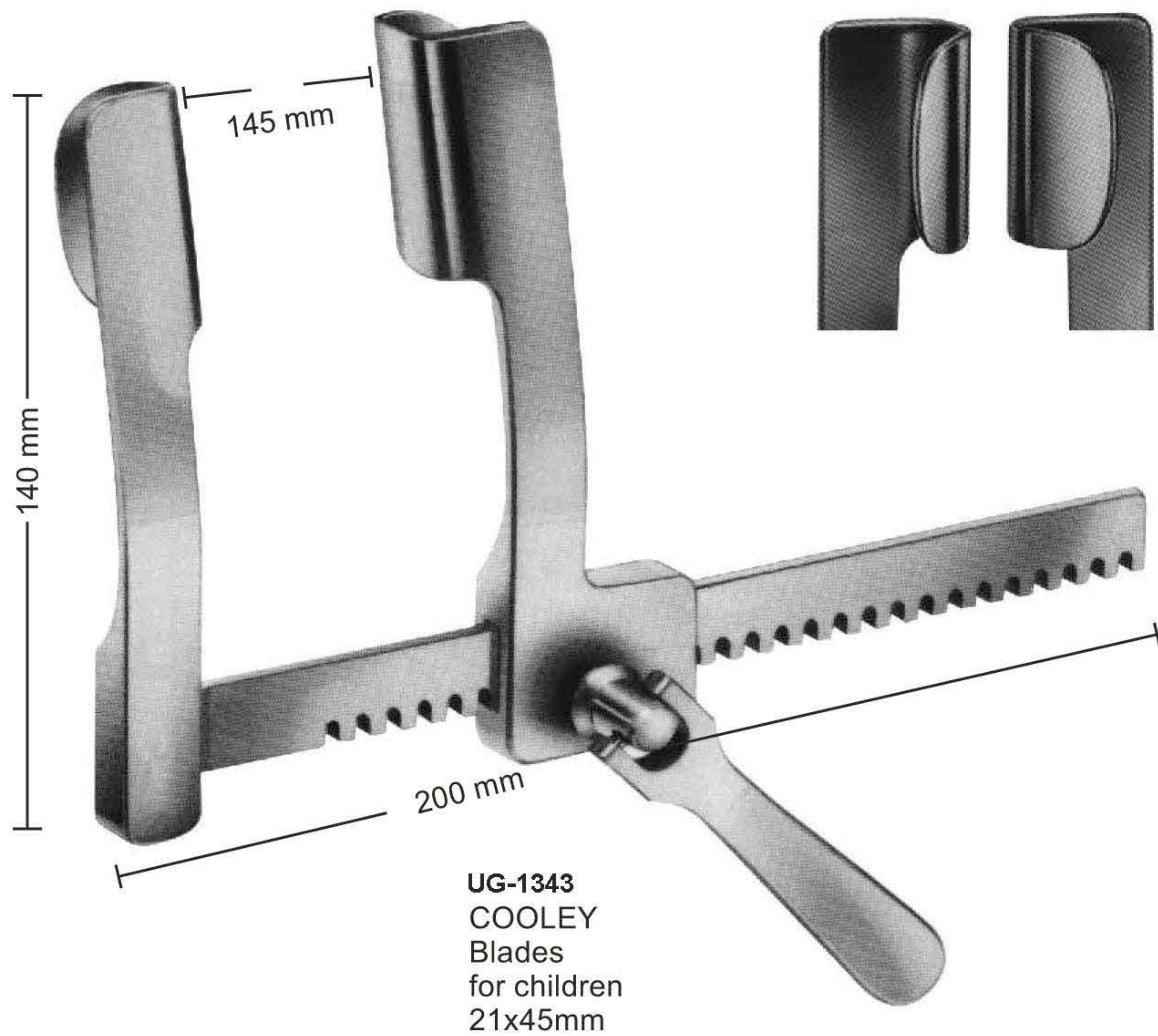

Thoracic Retractors



UG-1339
Thoraxsperrer (Mercedes-Sperrer)
complete consisting of:
17-413 Retractor only
17-414 1 Pair of blades 42x65 mm
17-415 1 Pair of blades 75x75 mm

Rib Spreaders-and Contractors



UG-1332
SELLORS
Rib spreader and contractor
with swivel blades
200 mm



UG-1335
BAILEY
150 mm



17-418
for children

UG-1336
BAILEY
200 mm

Rib Spreaders-and Contractors

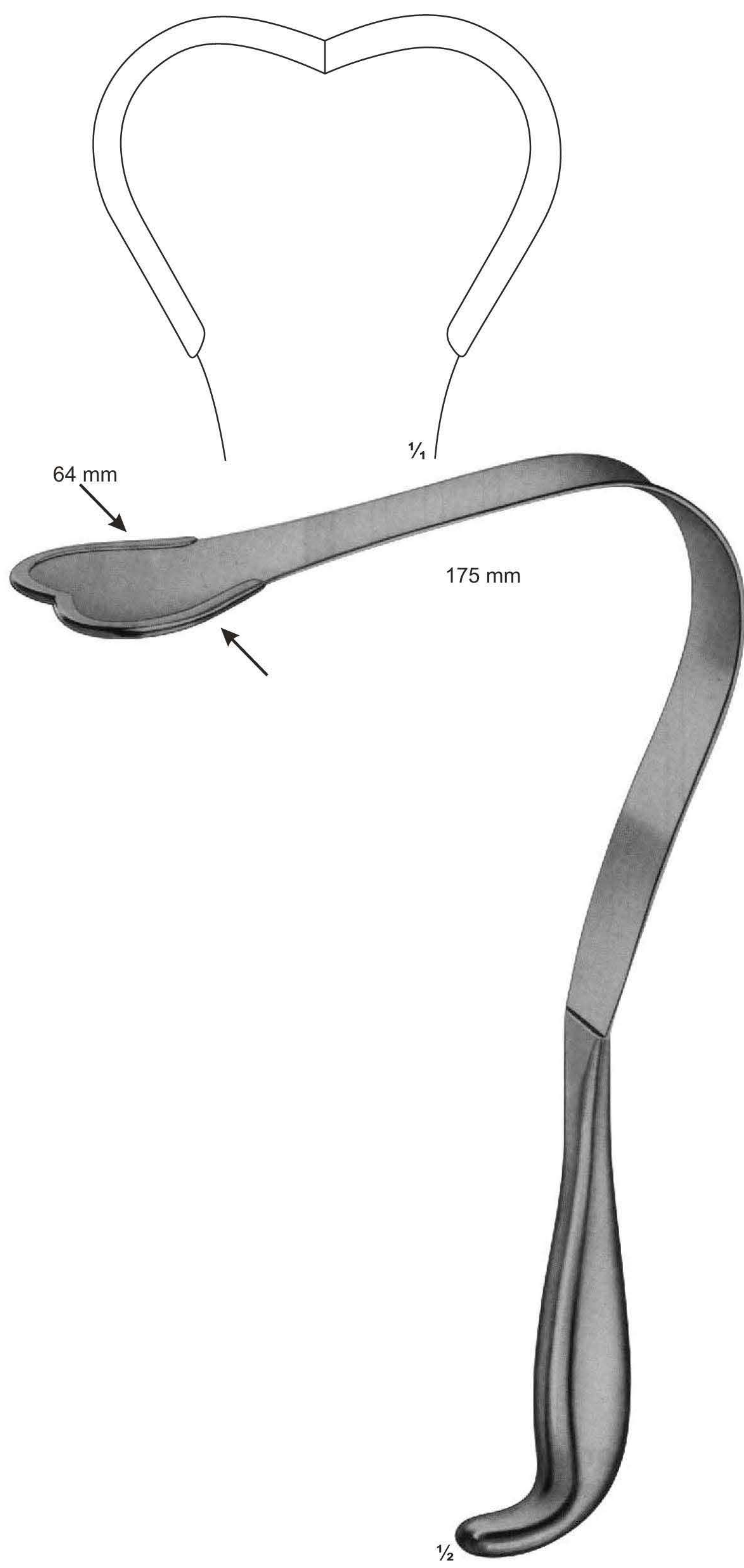

UG-1329
HARRINGTON-PEMBERTON
federnd/flexible
295 mm

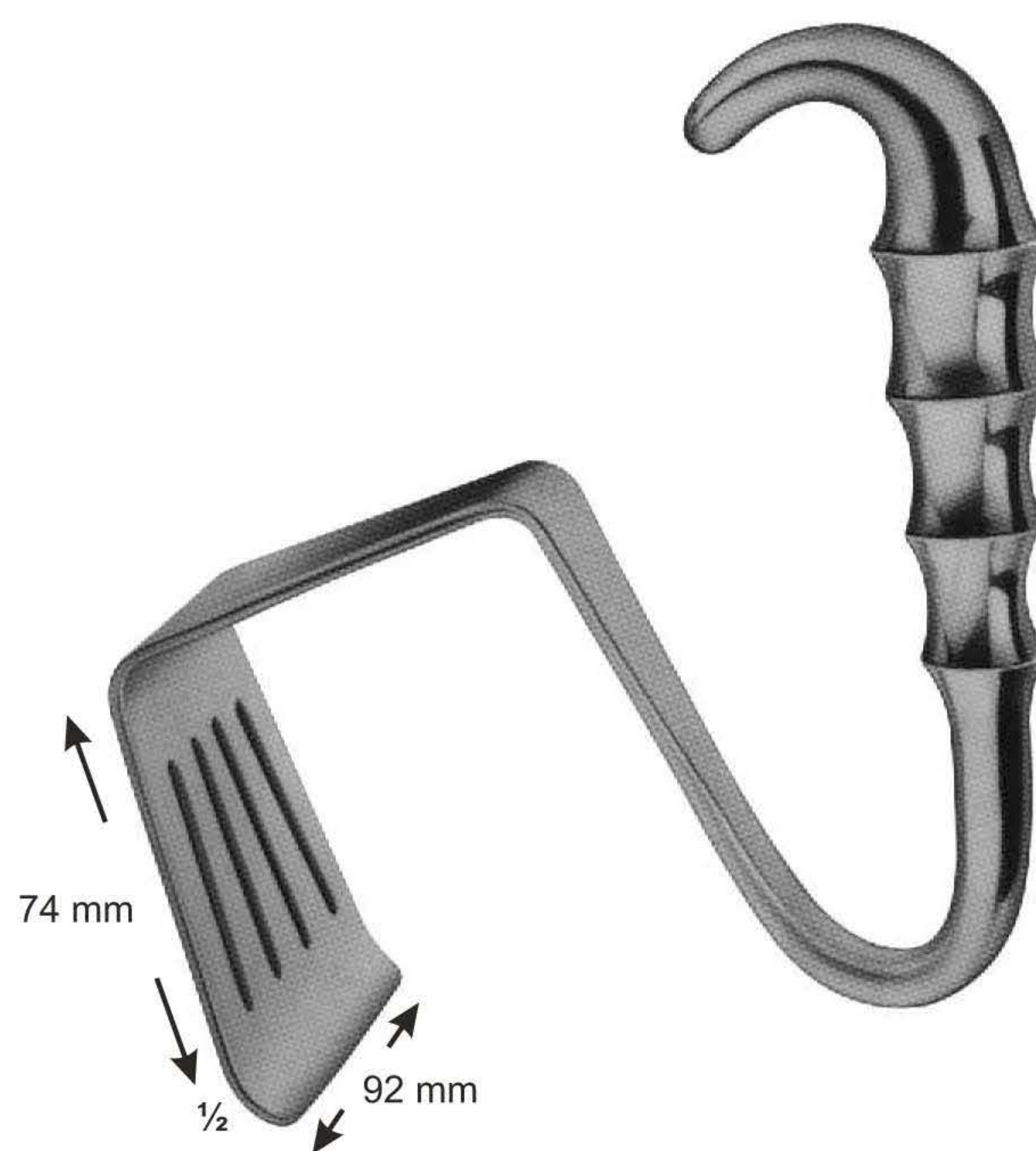

UG-1331
DAVIDSON
Scalpel haken

Rib Spreaders-and Contractors



UG-1324
ALLISON
255 mm



UG-1326
ALLISON
320 mm



ϕ 6-10 mm
 $\frac{1}{2}$

UG-1327
DE BAKKEY
With central bore,
3.0mm diam.
with lateral slots
275 mm



ϕ 7-9 mm
 $\frac{1}{2}$

UG-1328
YANKAUER
With central bore,
2.0mm diam.
285 mm

Punches

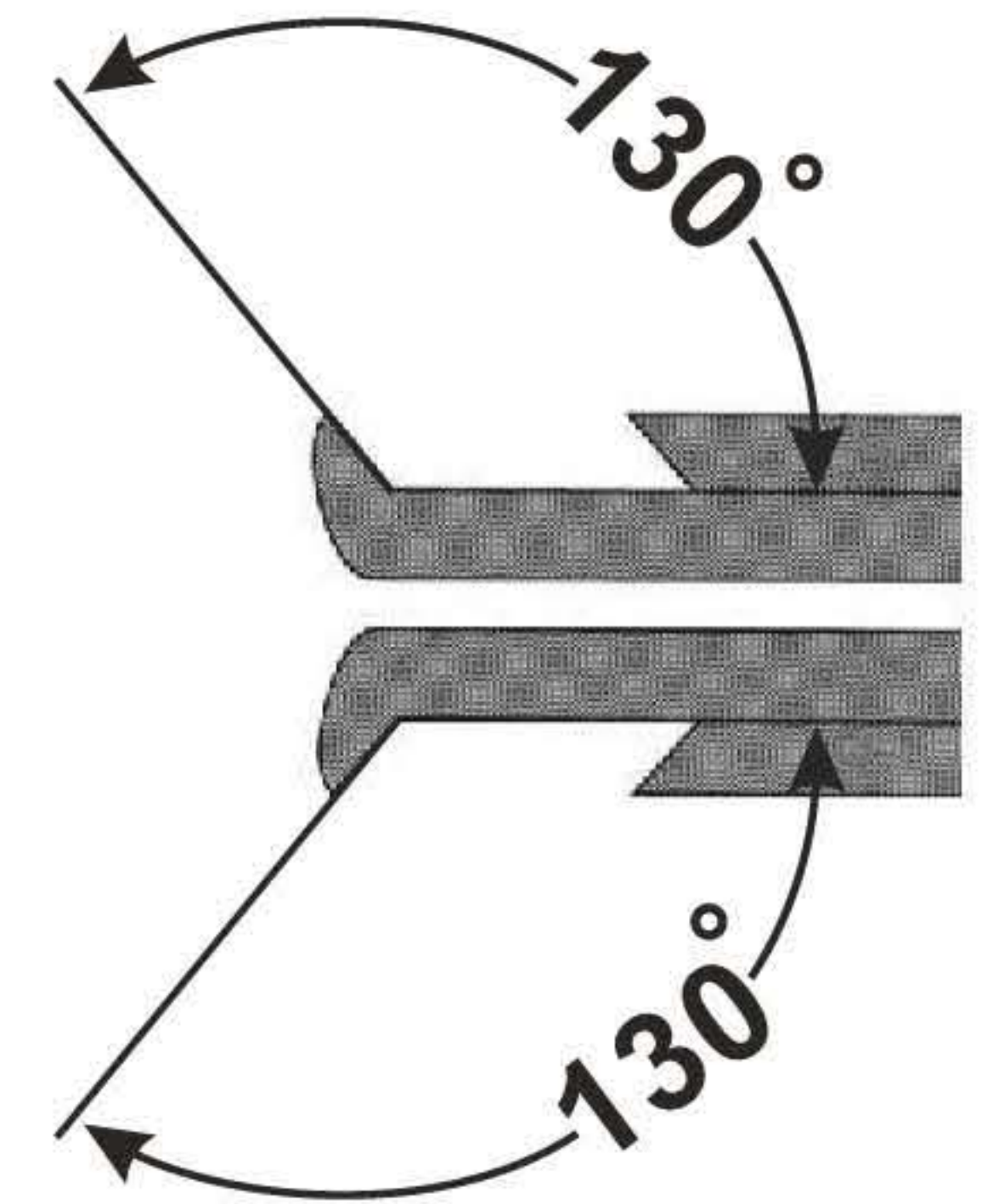
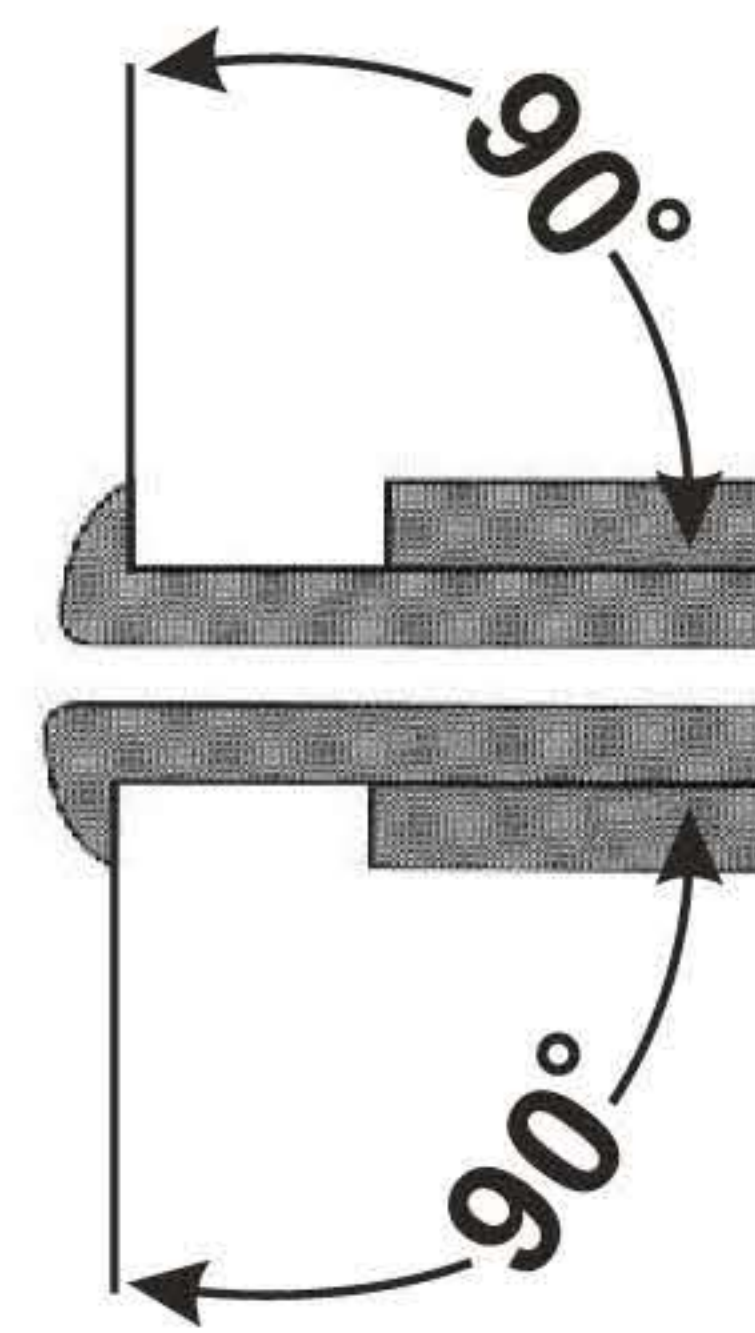
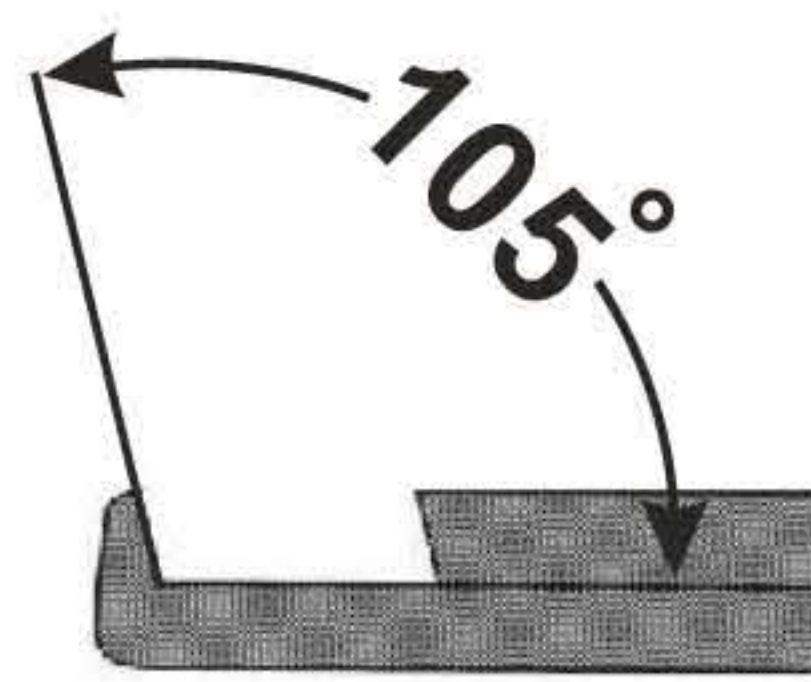

90° upwards cutting



UG-1482
CITELLI
2 mm, 3,5 mm

90° upwards cutting

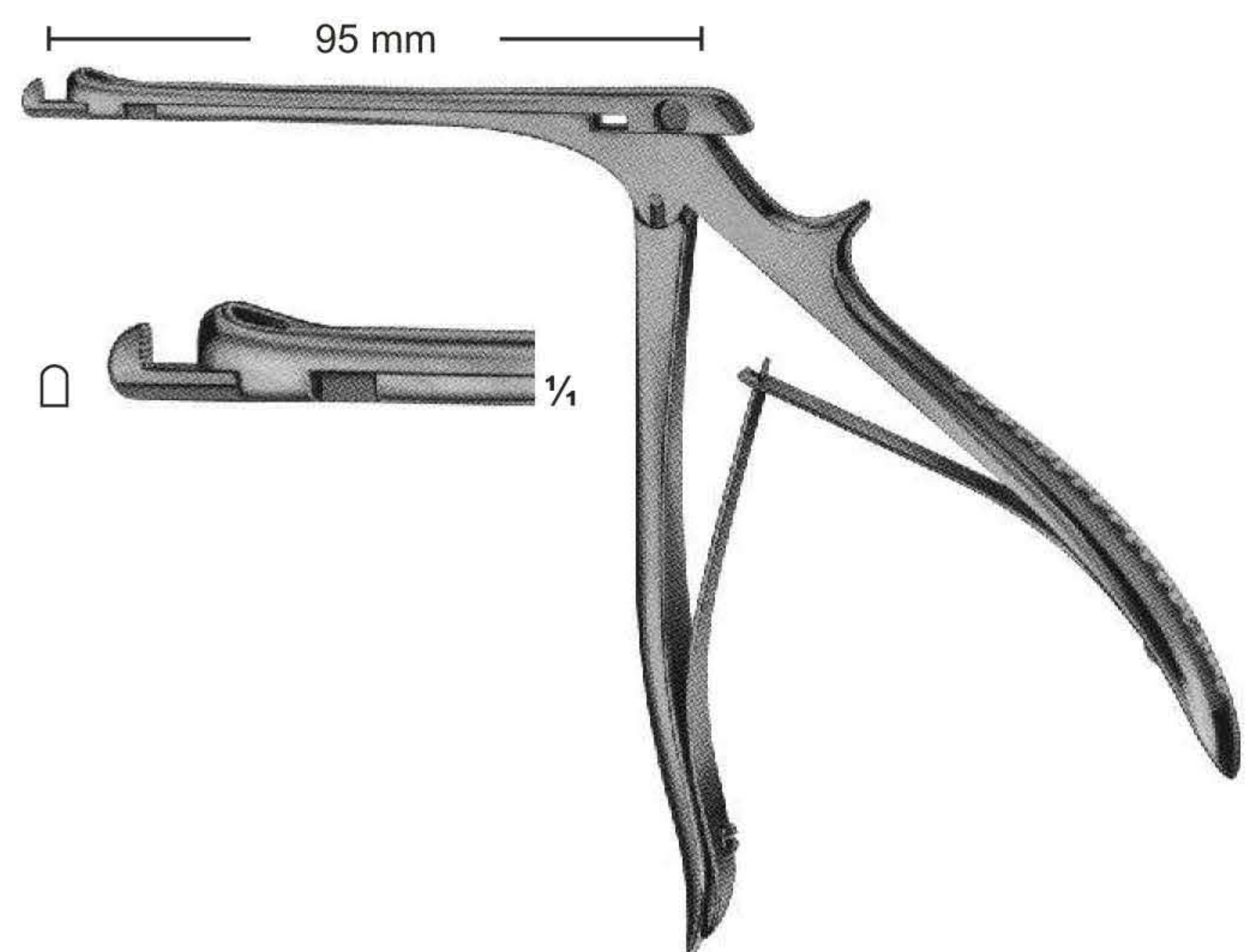

UG-1483
CITELLI- BEYER
1,8 mm

Punches

90° upwards cutting



UG-1484
KERRISON

90° upwards cutting

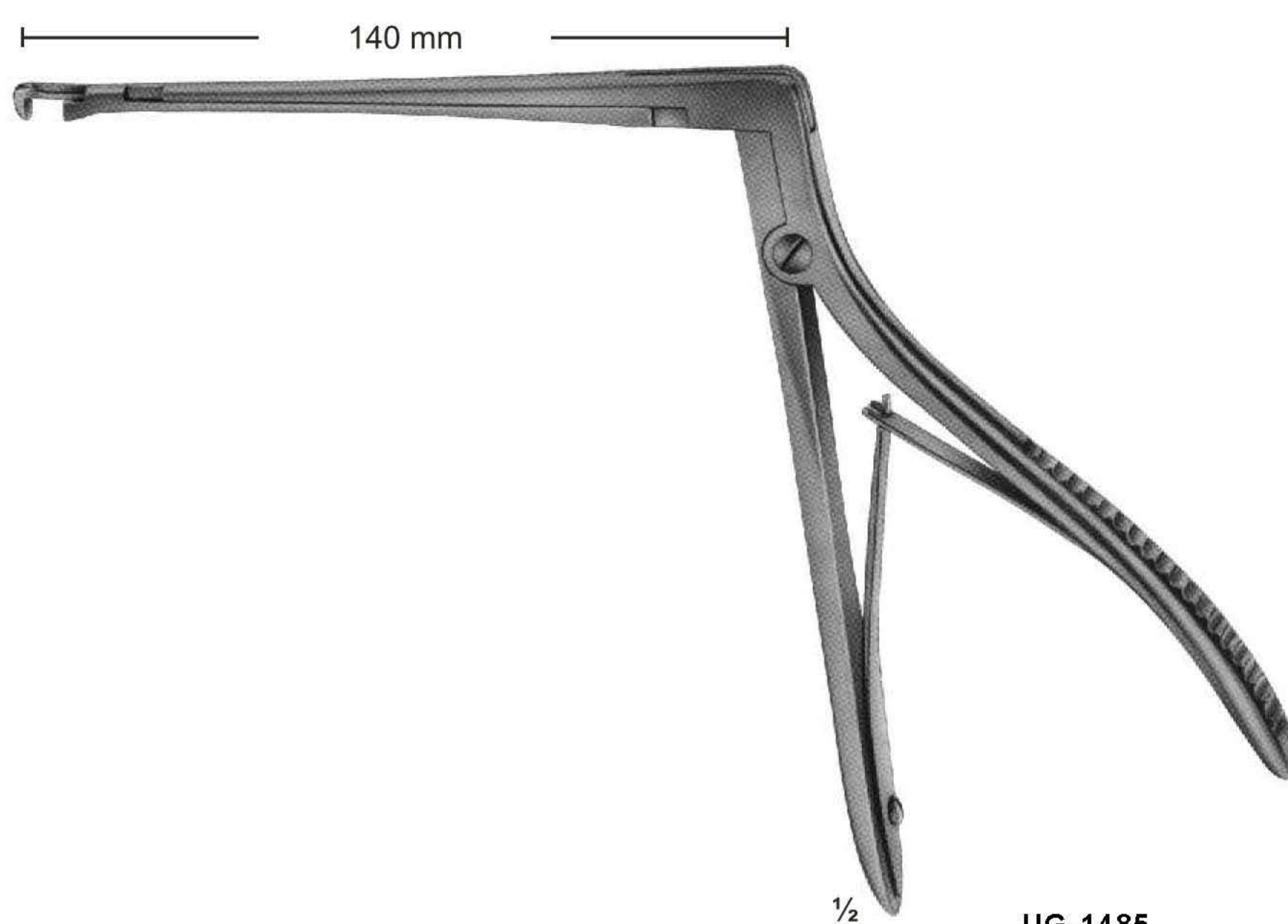

UG-1485
HAJEK-KOFLER

Punches

130° upwards cutting

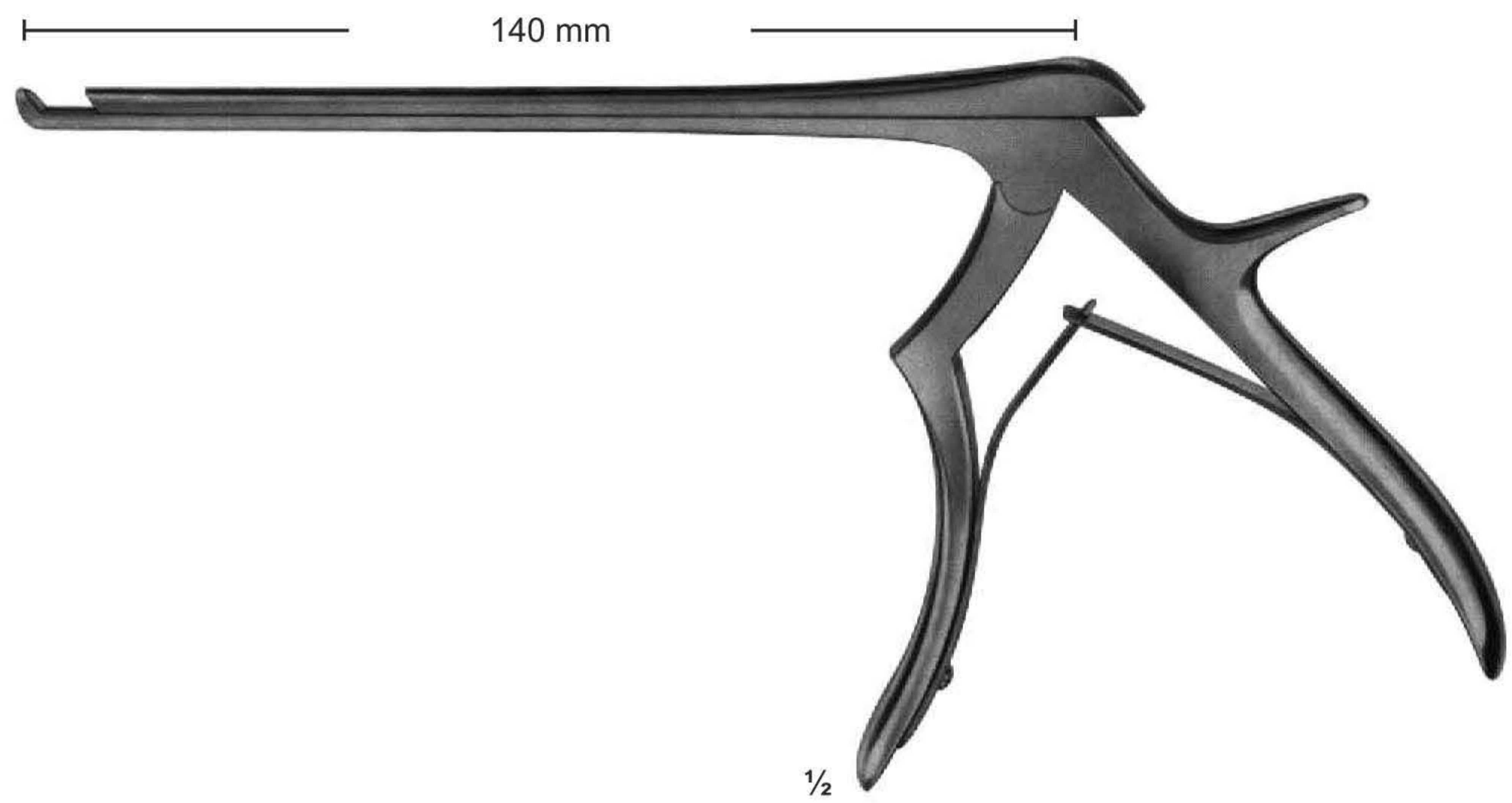

UG-1486
KERRISON-JACOBY

90° upwards cutting

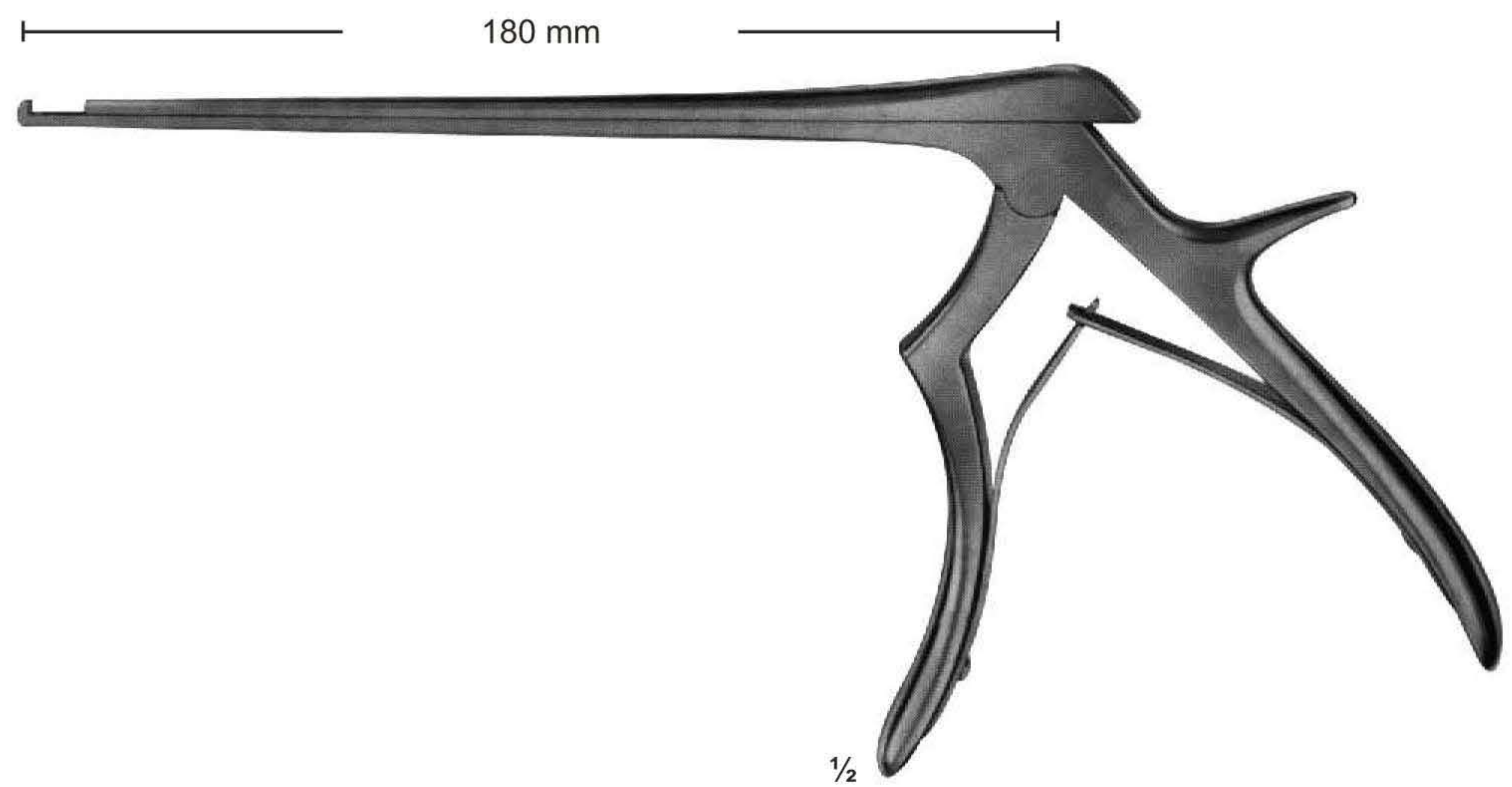

UG-1487
KERRISON-JACOBY

Rongeurs

Angled positions for rongeurs

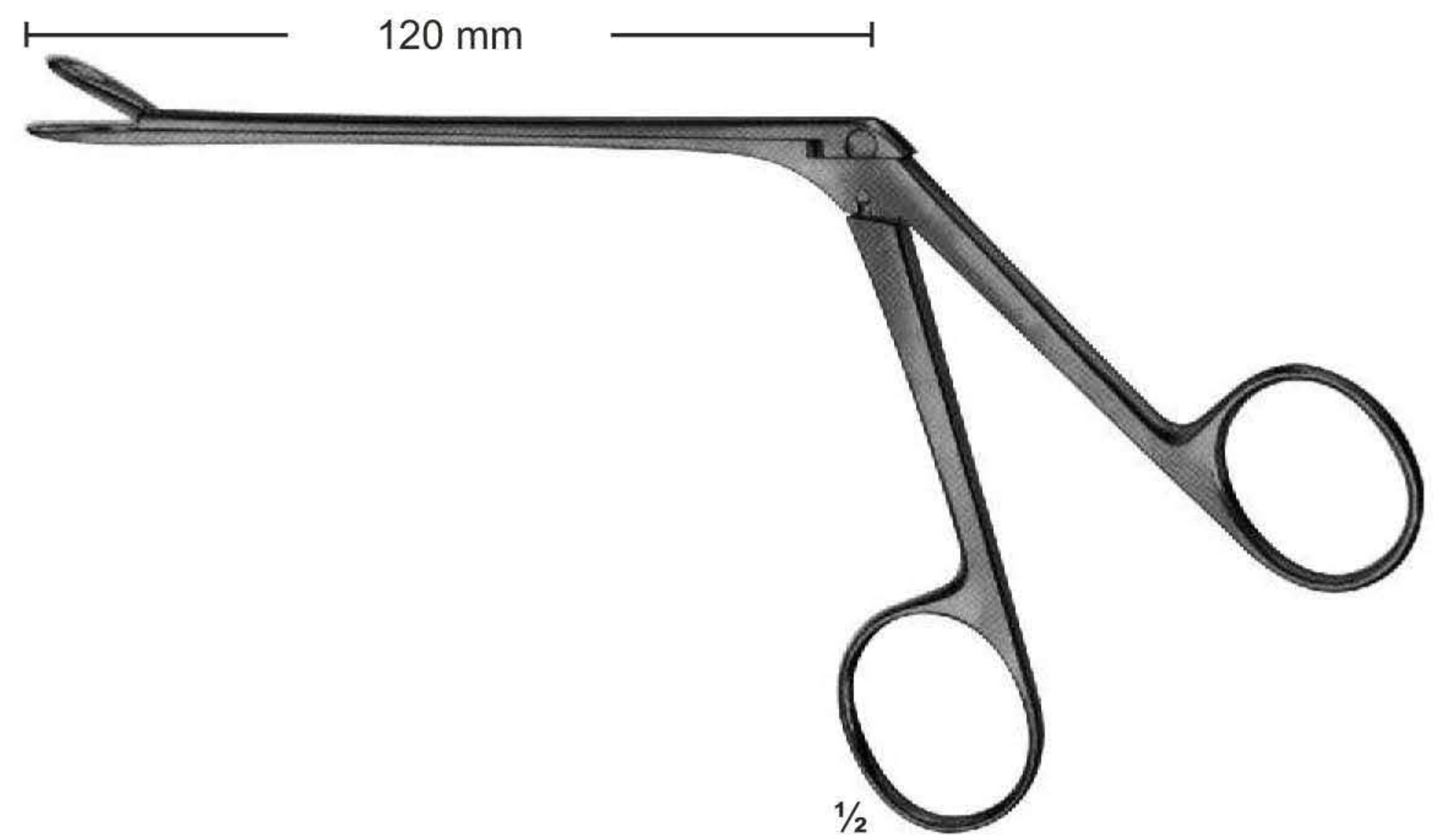

UG01488
WEIL-BLAKESLEY

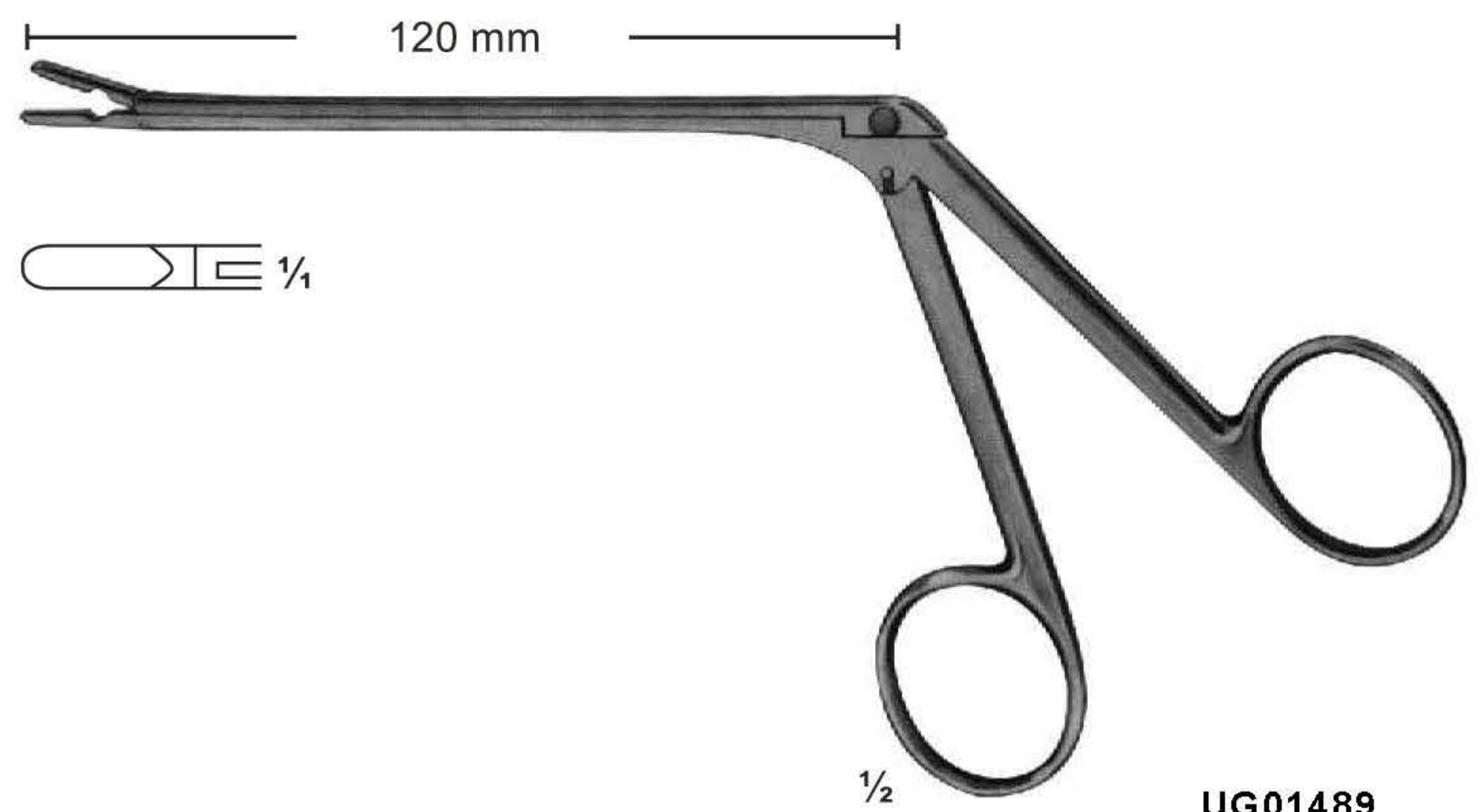

UG01489
TAKAHASHI
3 mm

130°

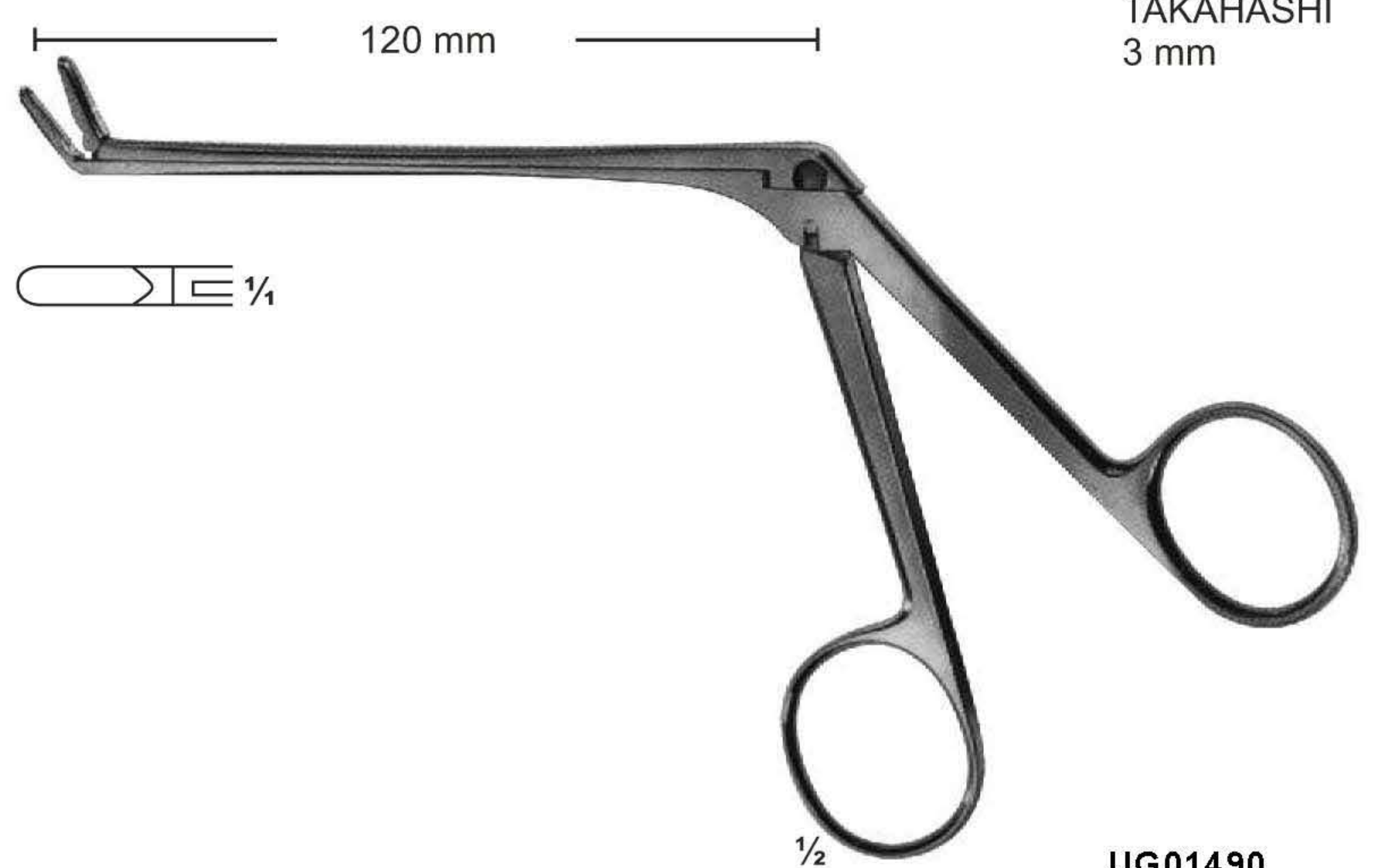

UG01490
TAKAHASHI
3 mm

Rongeurs

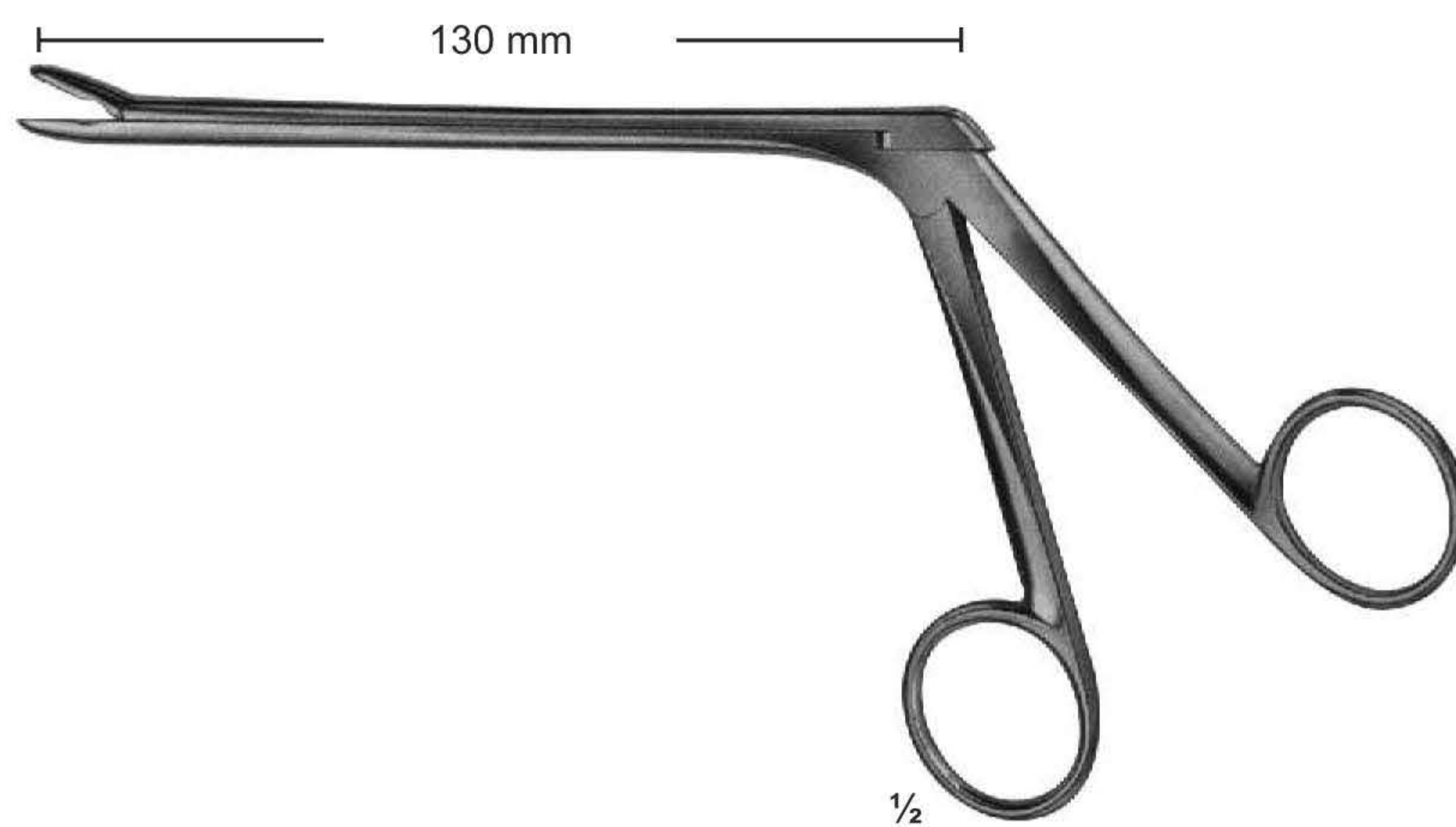

UG-1491
LOVE-GRUENWALD

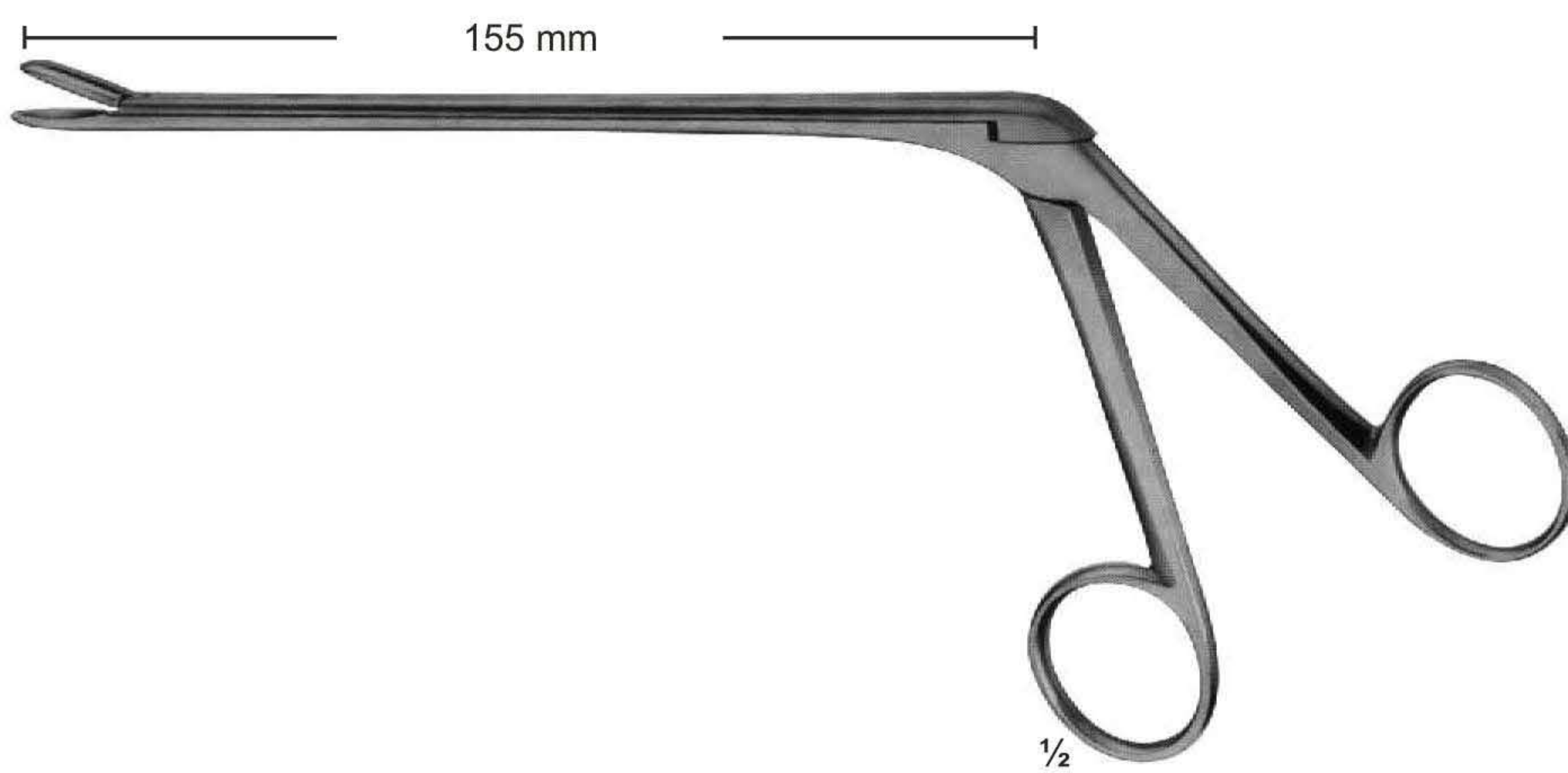

UG-1492
CASPAR

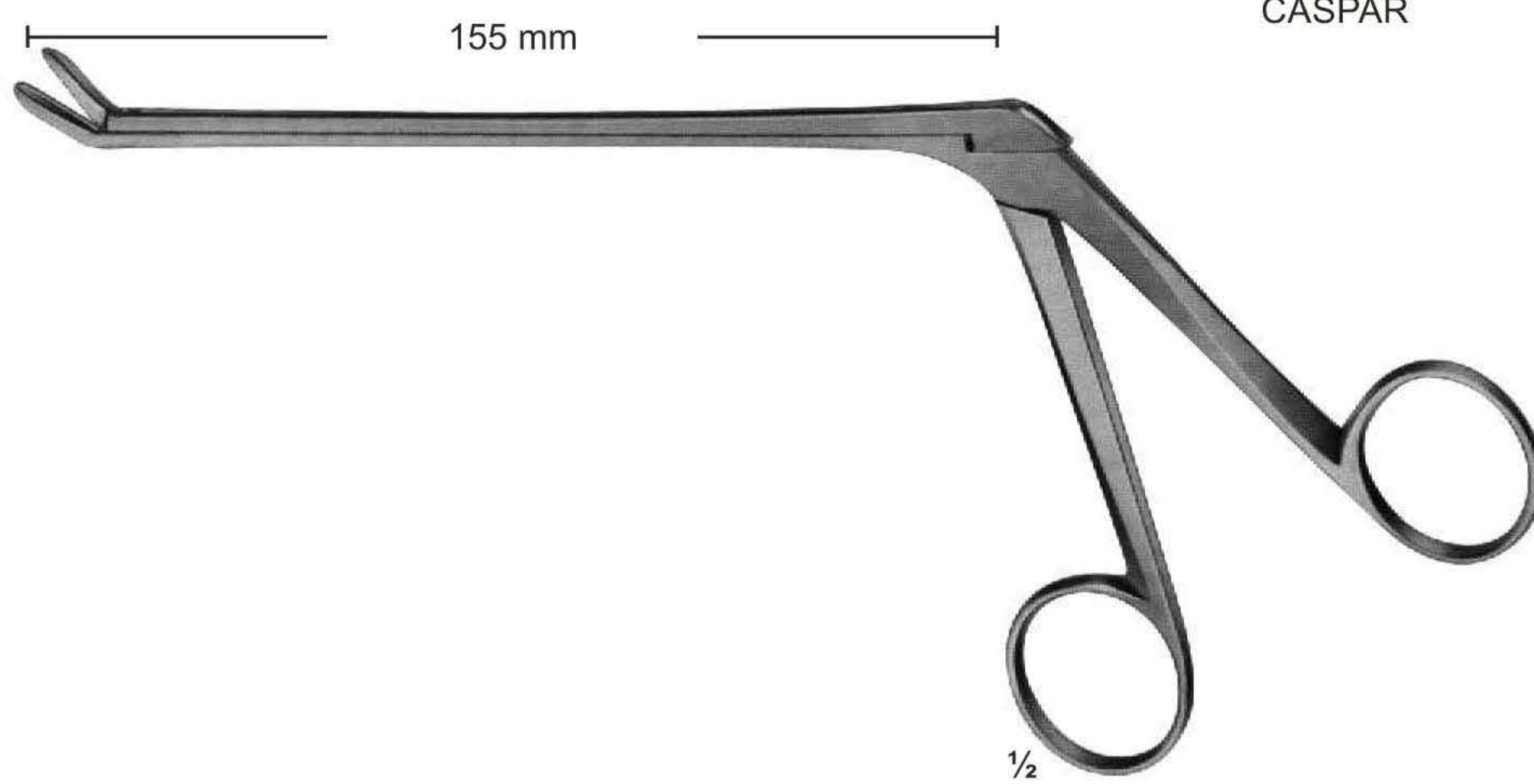

UG-1493
CASPAR

Rongeurs

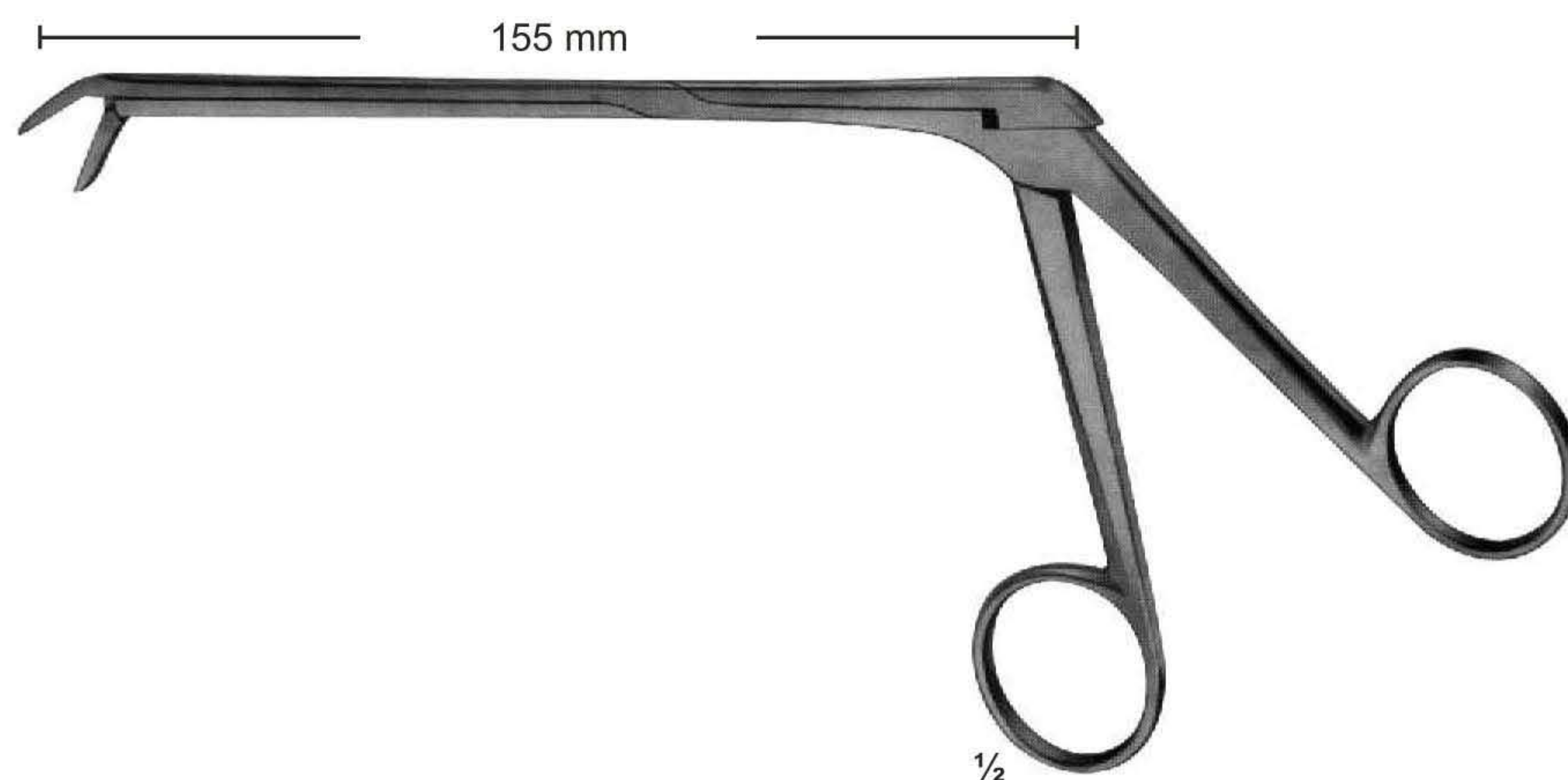

UG-1494
CASPAR

Length of shaft
140 mm

Length of shaft
160 mm

Length of shaft
185 mm

size of jaws

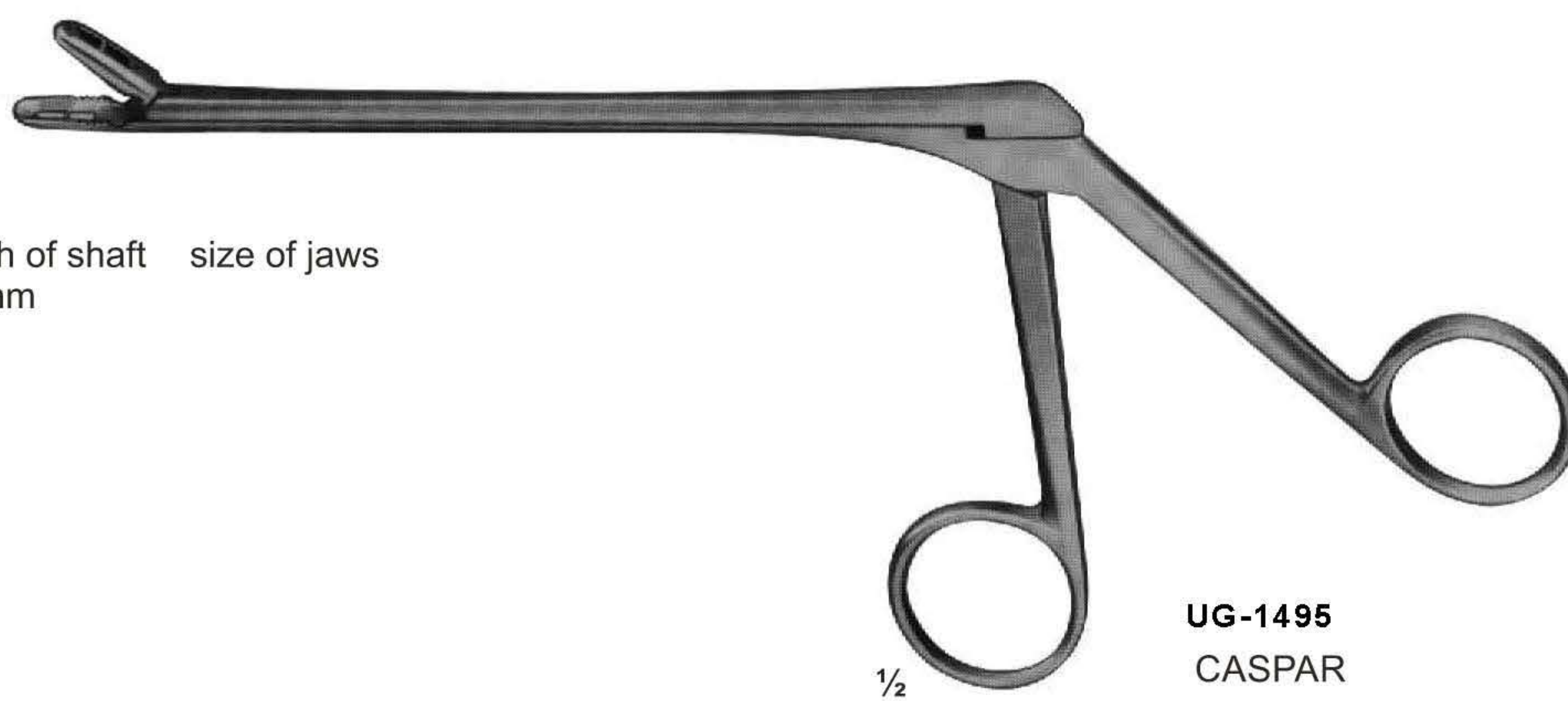

UG-1495
CASPAR

Length of shaft
140 mm

Length of shaft
160 mm

Length of shaft
185 mm

size of jaws

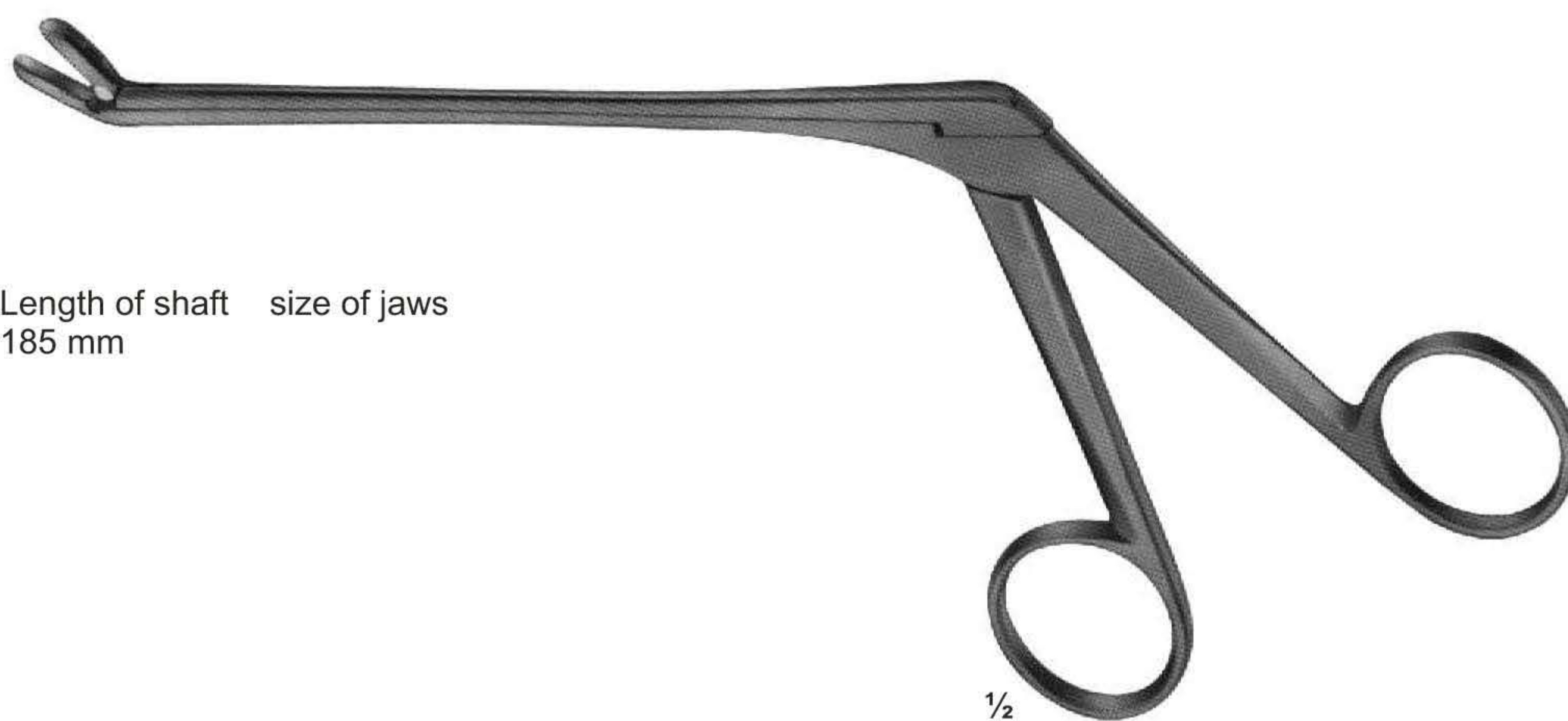

UG-1496
CASPAR

Rongeurs



UG-1497
GUSHING

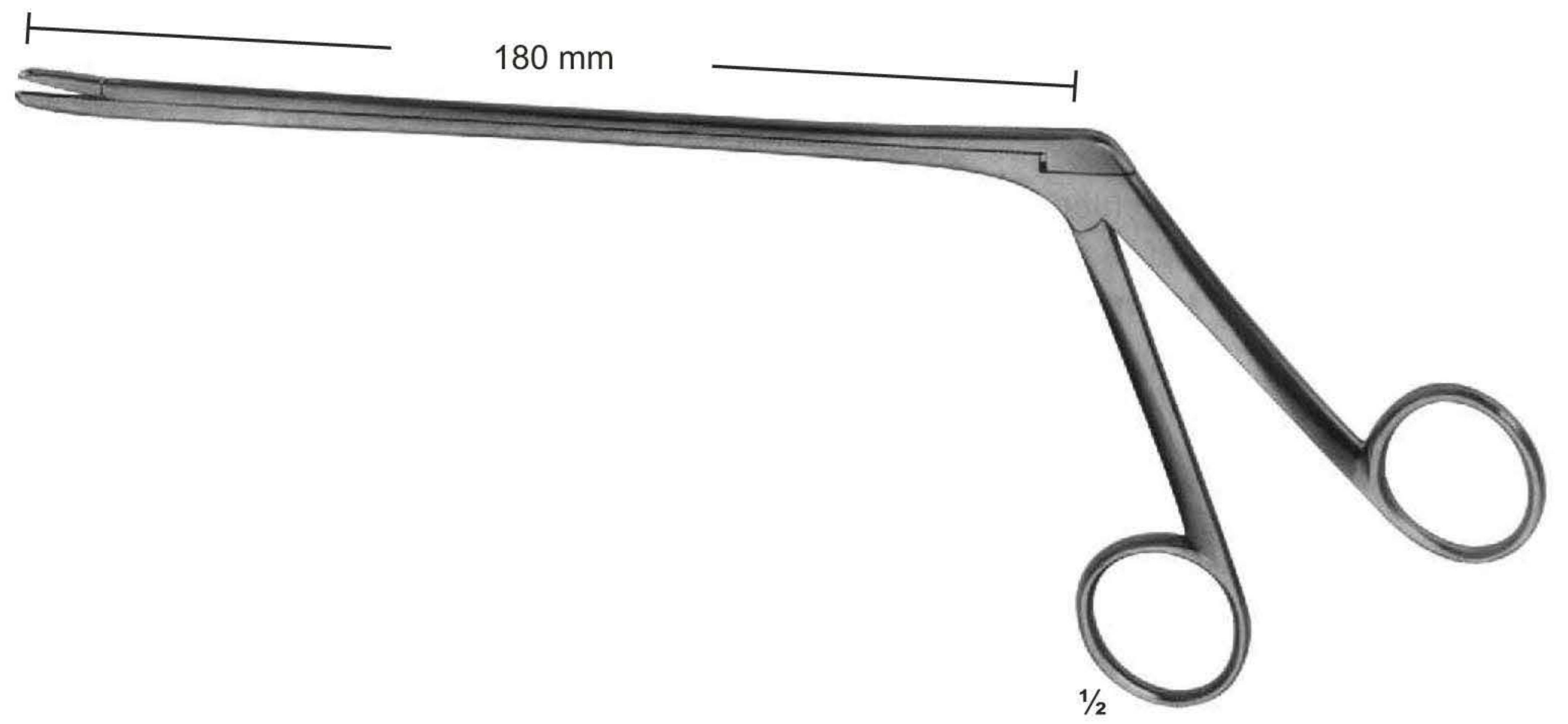

UG-1498
LOVE-GRUENWALD

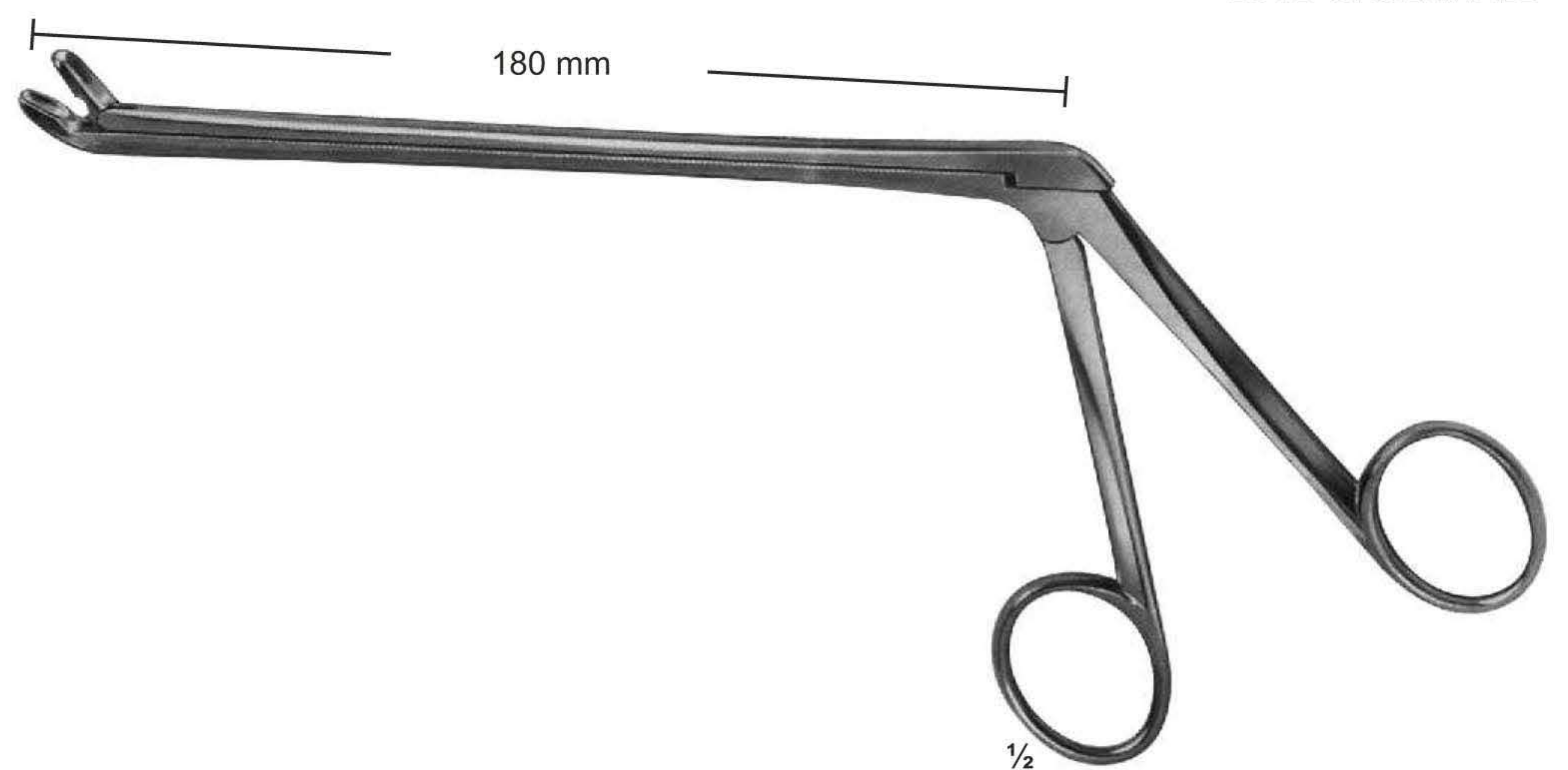

UG-1499
LOVE-GRUENWALD

Rongeurs

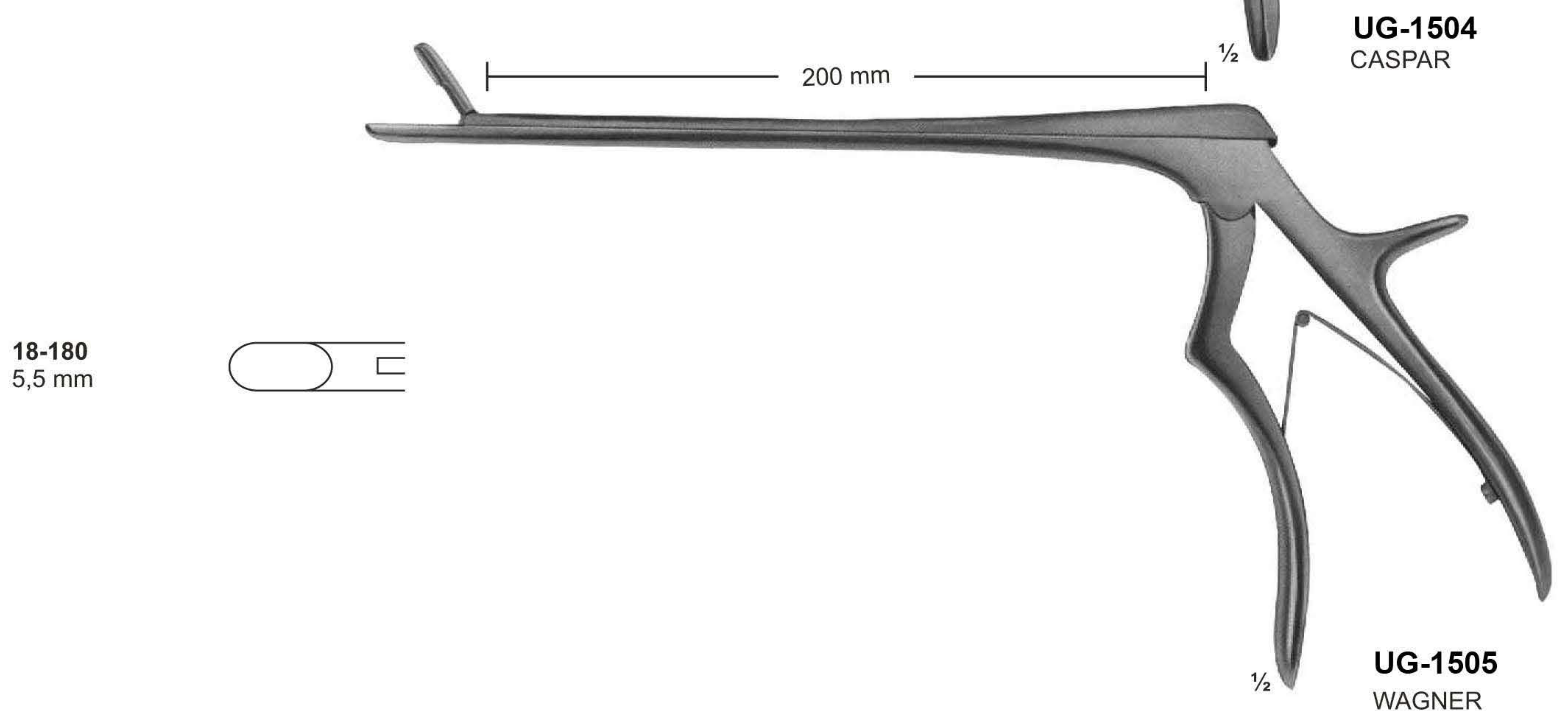
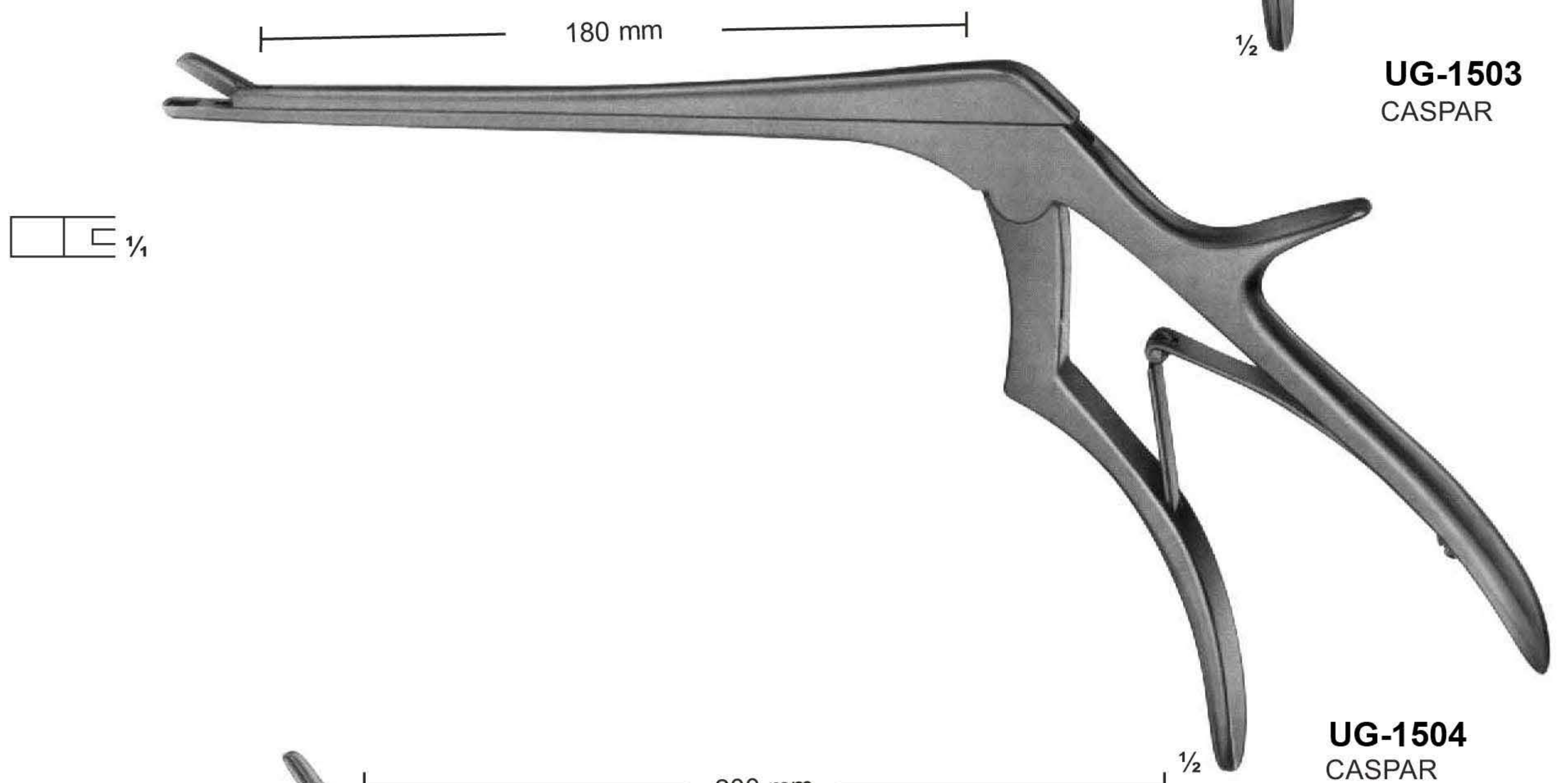
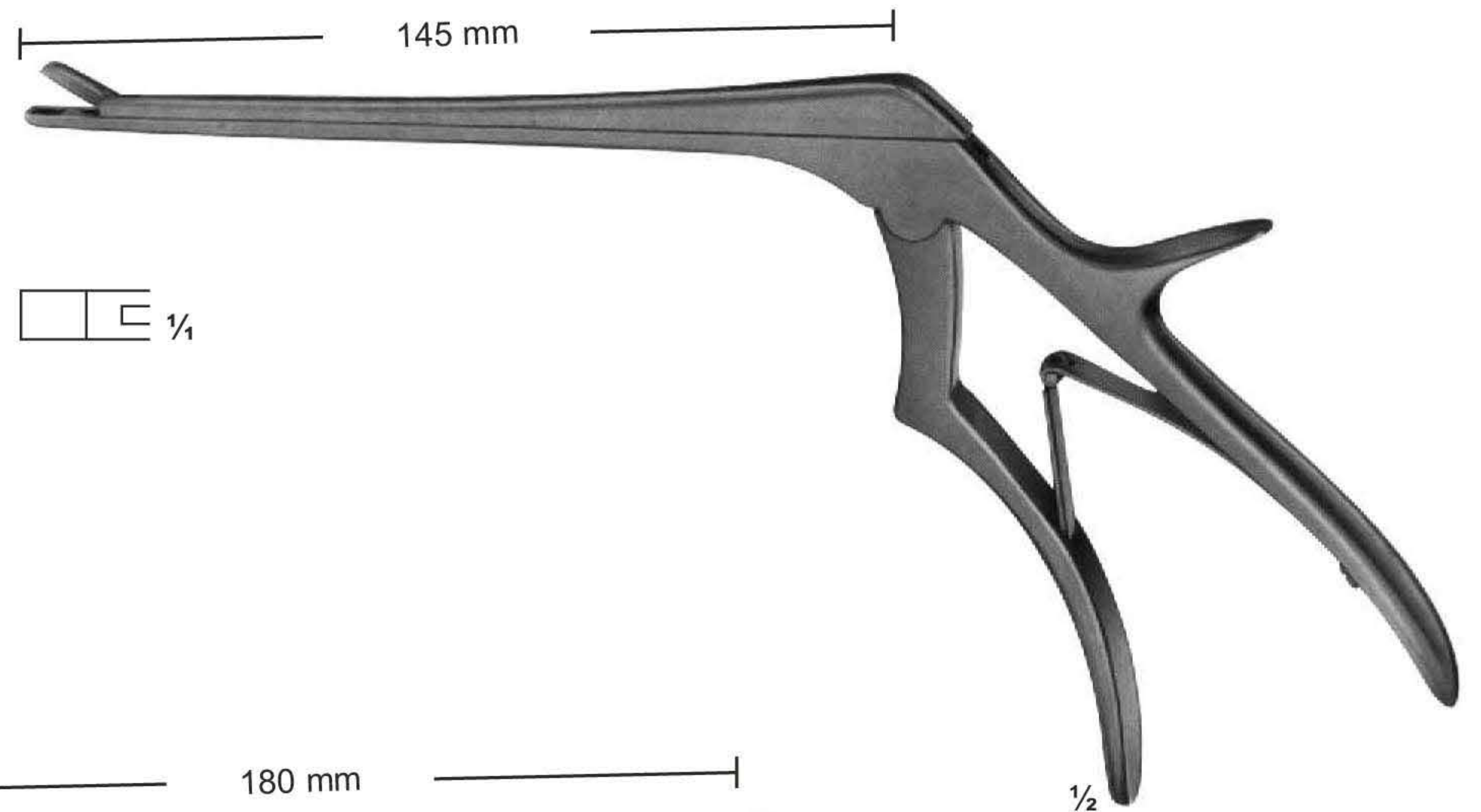

Amputation

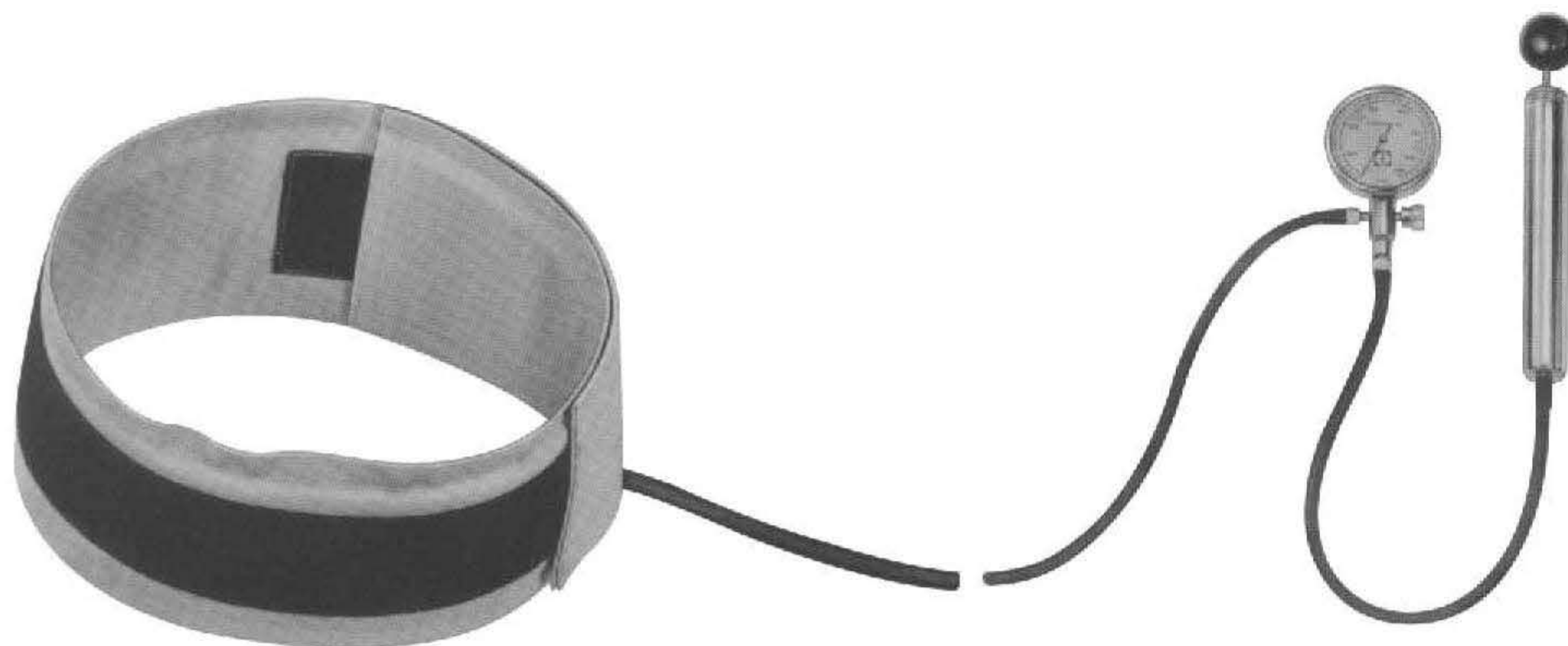

Comprimeter. Compression apparatus for producing exsanguination in the extremities. Manometer registers up to 600 mm Hg. Complete, consisting of:
UG-1506 2 Pump with manometer
UG-1507 3 Cuff for the leg
UG-1508 14 Cuff for the upper arm

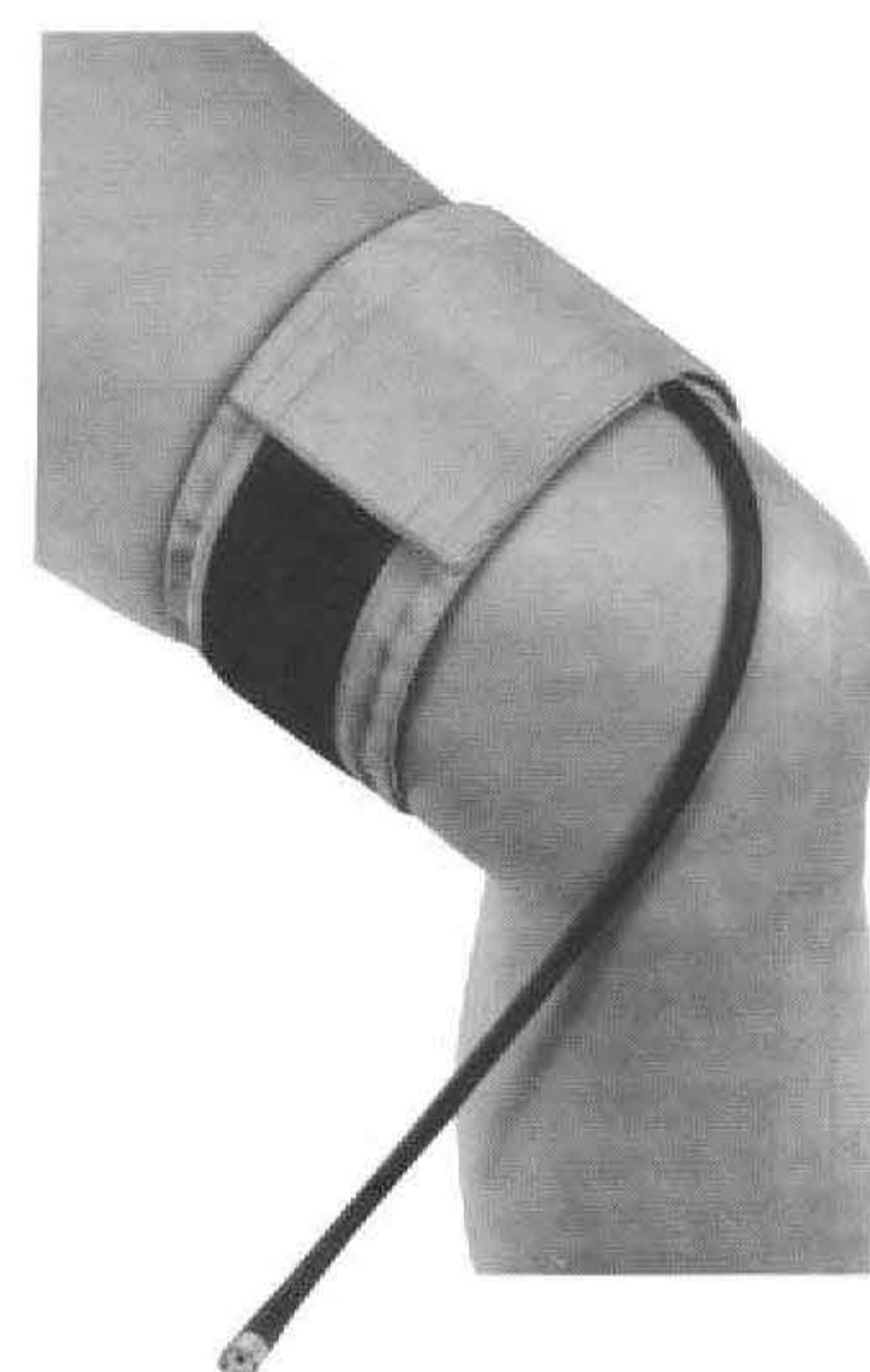
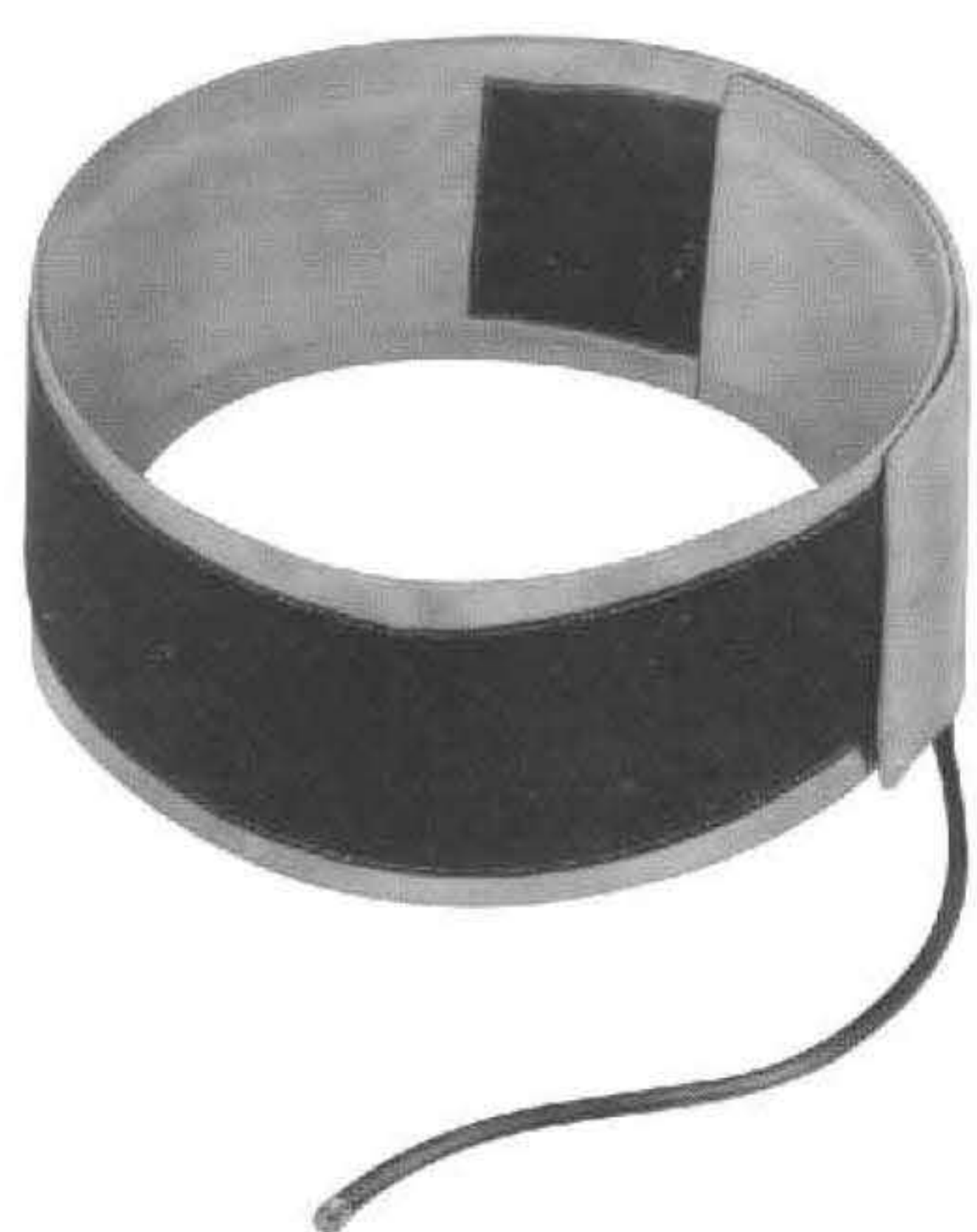

UG-1509 3 Cuff for the leg
UG-1510 4 Cuff for the lower arm
UG-1511 5 Cuff for children
UG-1512 14 Cuff for the upper arm



UG-1513
 ESMARCH
 Staubinde
 Compression bandage
 5 m lang/long
 6 cm breit/wide



UG-1514
 ESMARCH
 Stauschlauch
 Compression tube
 1 m lang/long

Amputation and Resection Knives



1/2

UG-1515
Length of blades
Phalangeal knife
105 mm



1/2

UG-1516
Length of blades
Interosseous knife
110 mm



1/2

UG-1517
Length of blades
Periosteum knife
with raspatory
65 mm



1/2

UG-1518
LANGENBECK
Length of blades
Resection knives
55 mm

Amputation Retractors

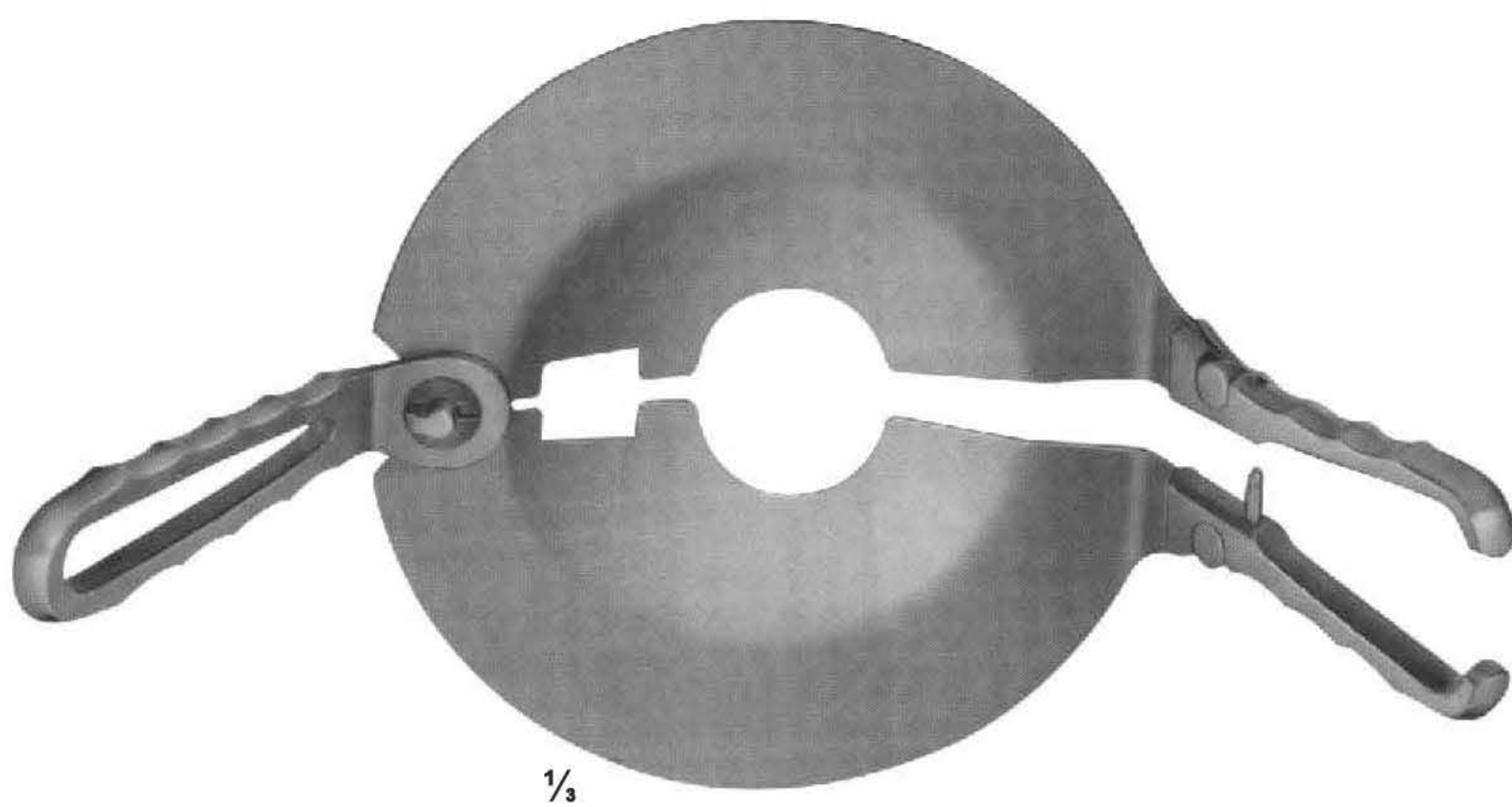

UG-1519
PERCY
removeable handles

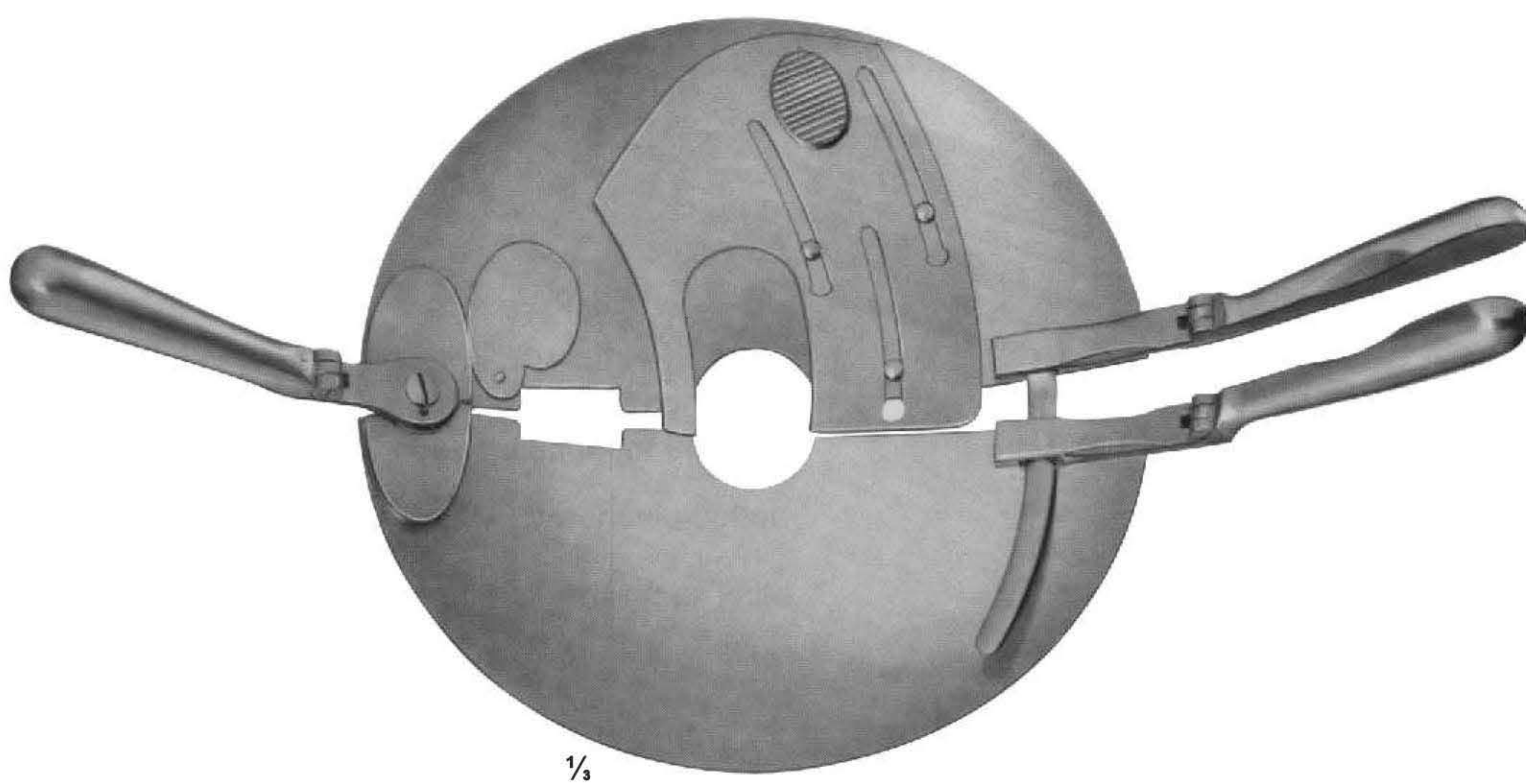

UG-1520
PERCY
reversible handles

Amputation Saws



1/3

UG-1521
CHARRIEER
 Length of blade
 215 mm
 complete with one saw
 blade each
 350 mm
 Spare saw blades, carbon steel
UG-1522 12 mm
UG-1523 20 mm

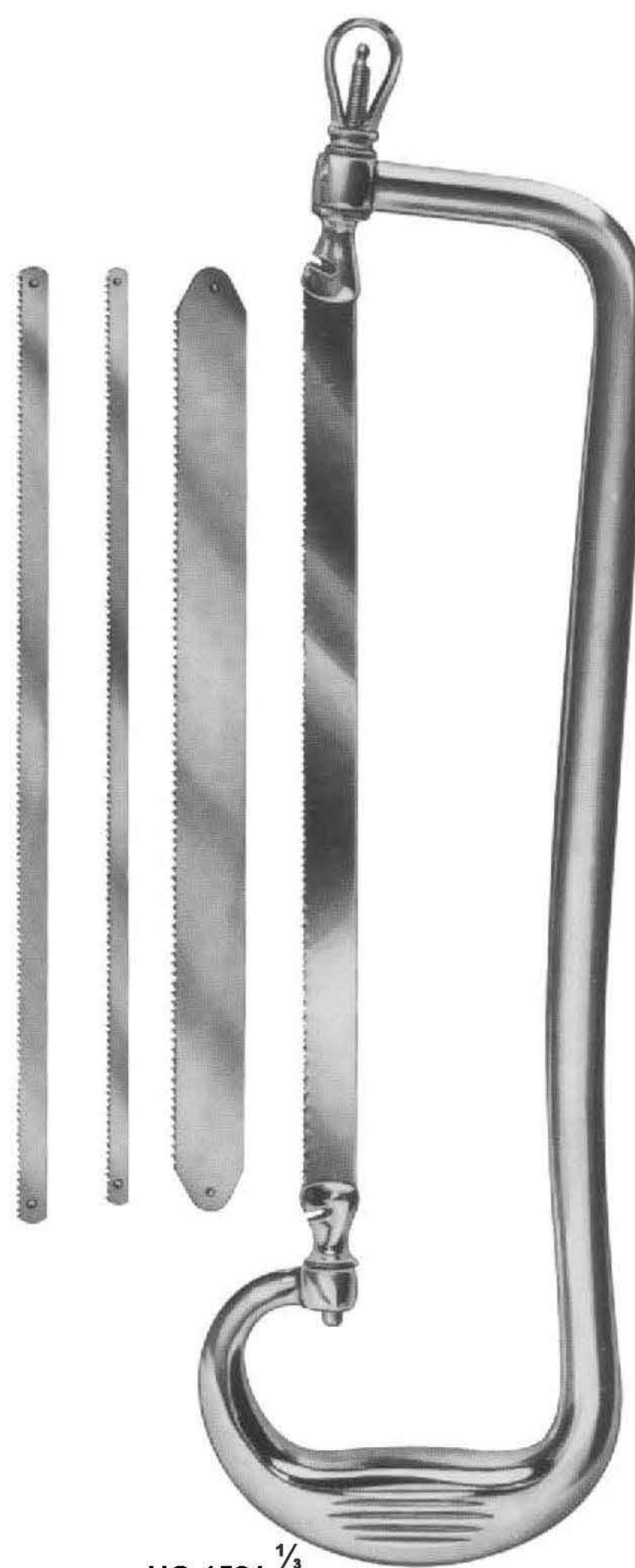

1/3

UG-1524
RUST
 Length of blade
 235 mm
 complete with one saw
 blade each
 390 mm
UG-1525 Bow only
 Spare saw blades, carbon steel
UG-1526 6 mm
UG-1527 8 mm
UG-1528 12 mm
UG-1529 20 mm

Amputation Saws

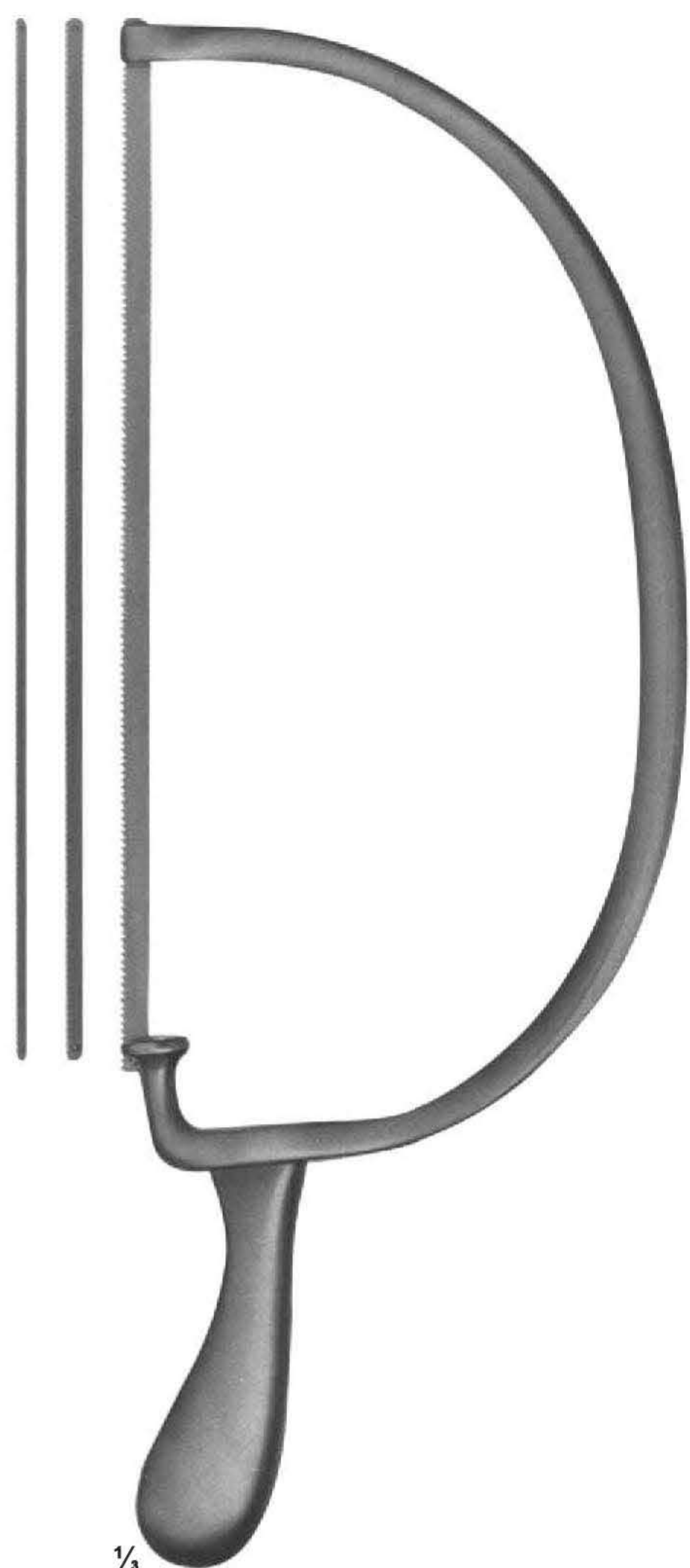

1/3

UG-1530
BIER
 Length of blade
 270 mm
 complete with one saw
 blade each
 420 mm
 Spare saw blades, carbon steel
UG-1531 4 mm
UG-1532 6 mm
UG-1533 8 mm



1/3

UG-1534
CHARRIERE
 Length of blade
 180 mm
 Spare saw blades,
 carbon steel
 270 mm

UG-1535
CHARRIERE
 Length of blade
 240 mm
 Spare saw blades,
 carbon steel
 340 mm



1/3

UG-1536
SATTERLEE
 Length of blade
 200 mm
 Spare saw blades,
 carbon steel
 290 mm



1/3

UG-1537
LANGENBACK
 Length of blade
 115 mm
 Metacarpal saw
 235 mm

Wire Saws and Conductor

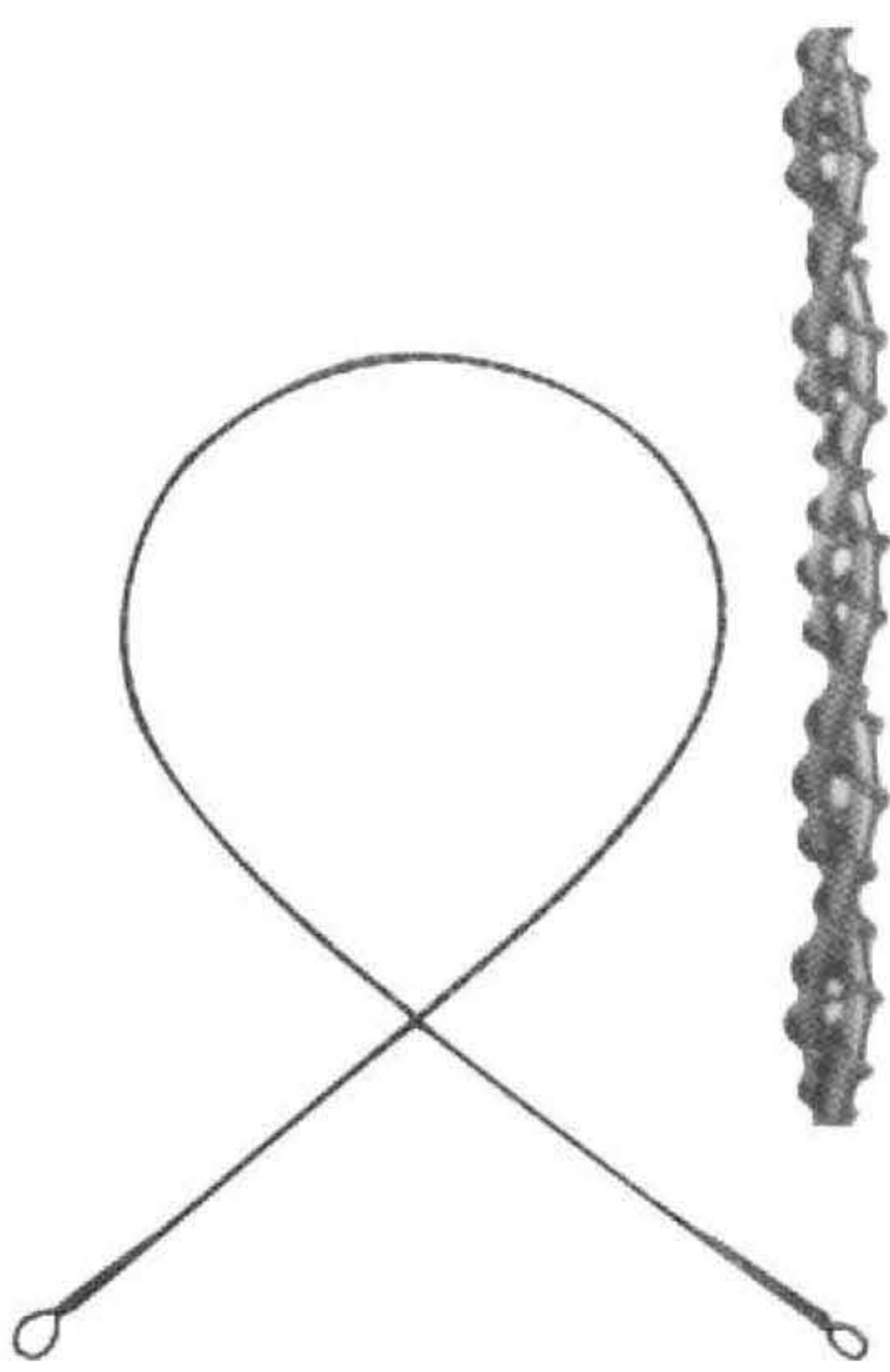

OLIVECRONA
UG-1538 300 mm
UG-1539 400 mm
UG-1540 500 mm
UG-1541 700 mm

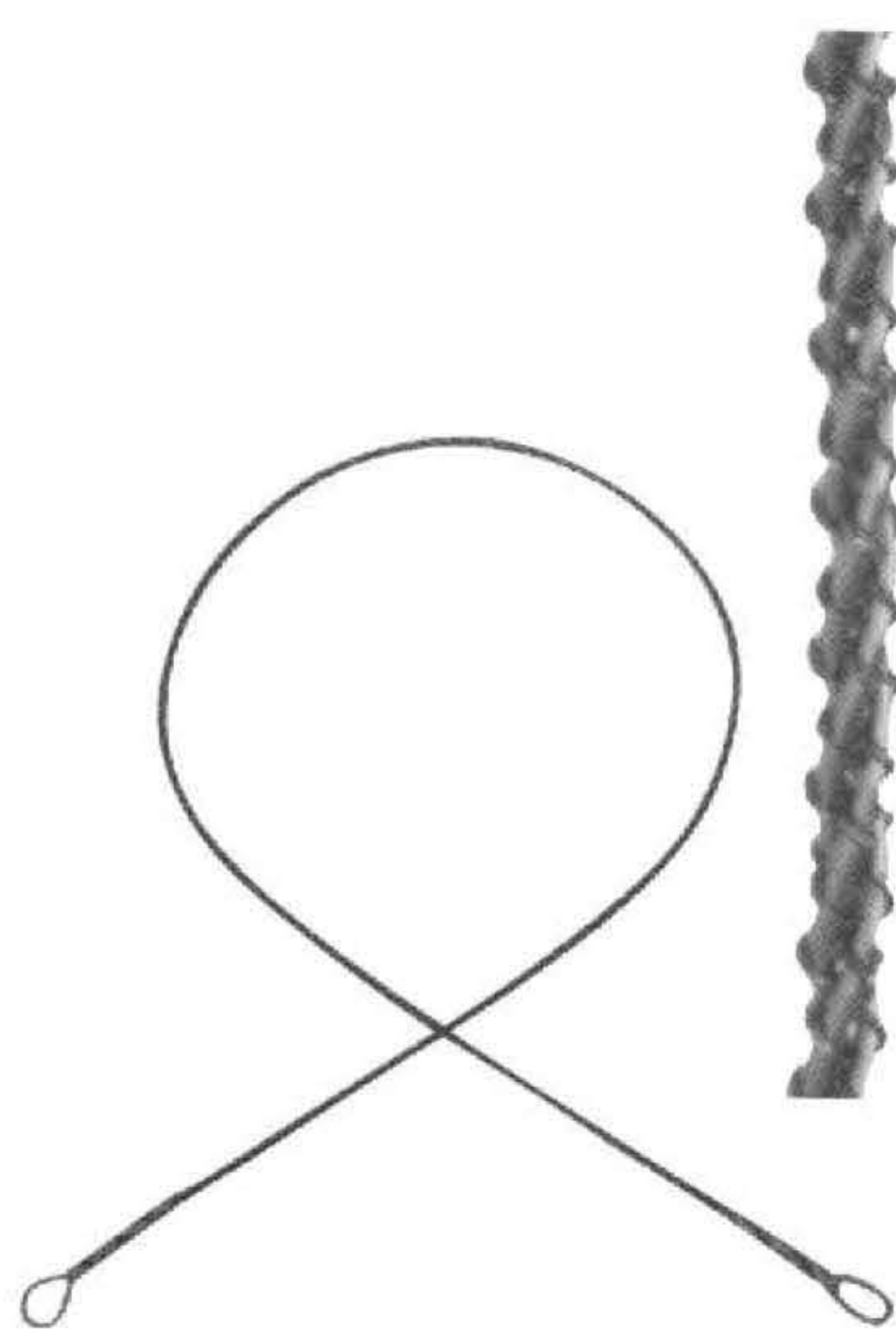

GIGLI
UG-1542 300 mm
UG-1543 400 mm
UG-1544 500 mm
 fine, 6 wires twisted
UG-1545
 coares, 4 wires twisted



UG-1546
 GIGLI
 Handle



UG-1547
 LEBSCHE
 Conductor for
 wire saws, malleable
 250 mm

Elevators and Bone Levers



UG-1548
KONIG
155 mm



UG-1549
WILLIGER
165 mm



UG-1550
WILLIGER
170 mm

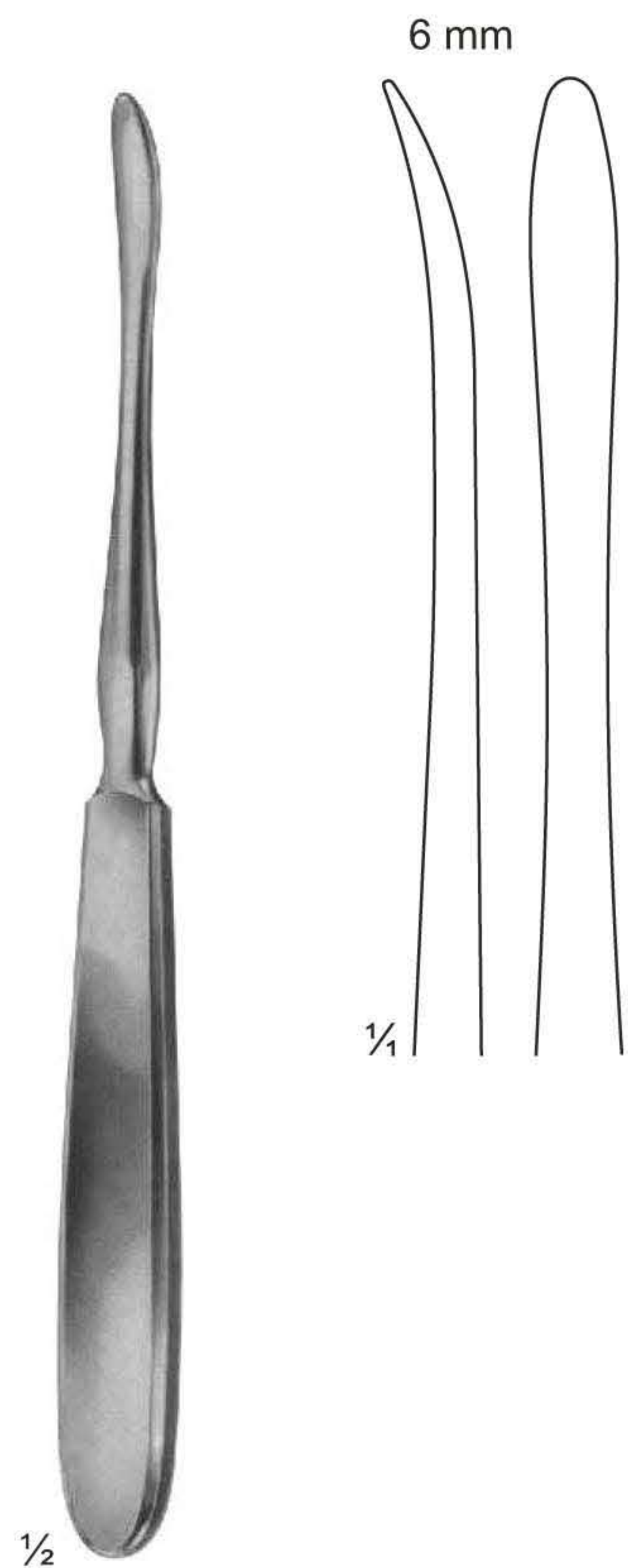

UG-1551
QUERVAIN
195 mm



UG-1552
LANGENBACK
195 mm

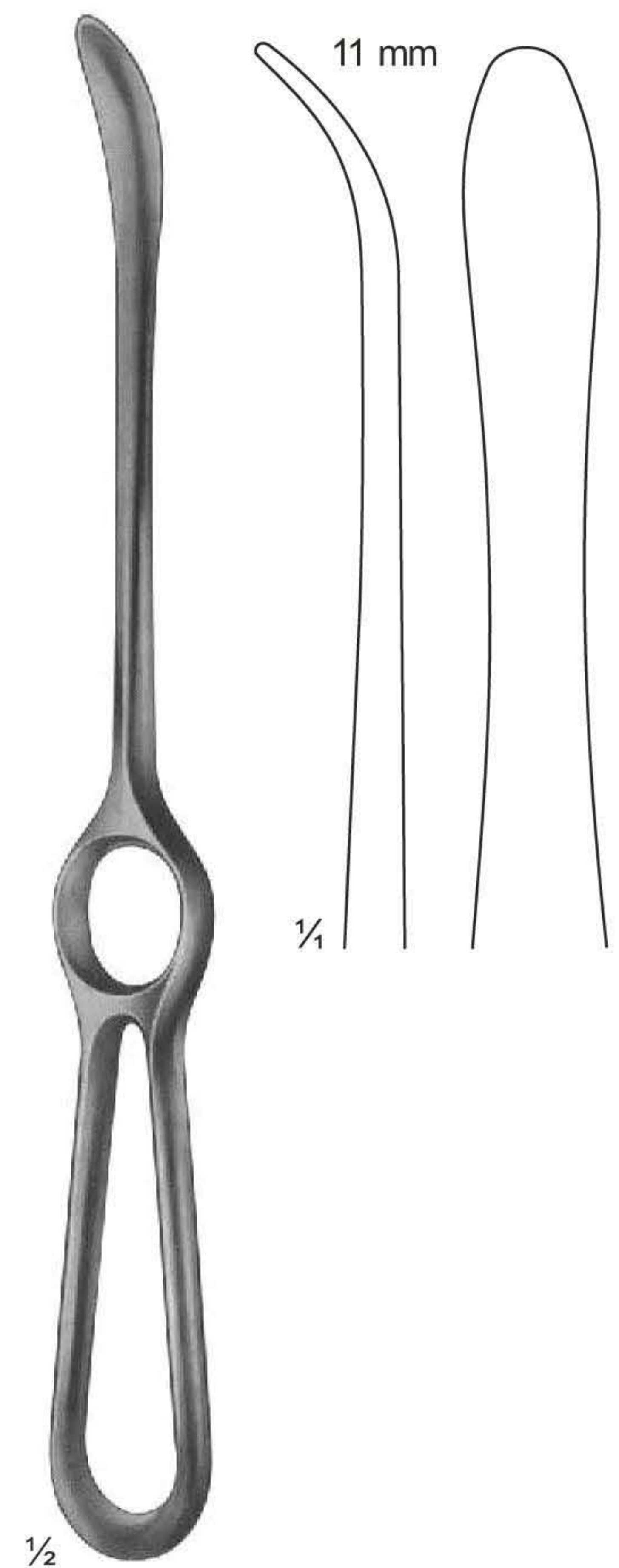

UG-1553
LANGENBACK
230mm

Bone Levers

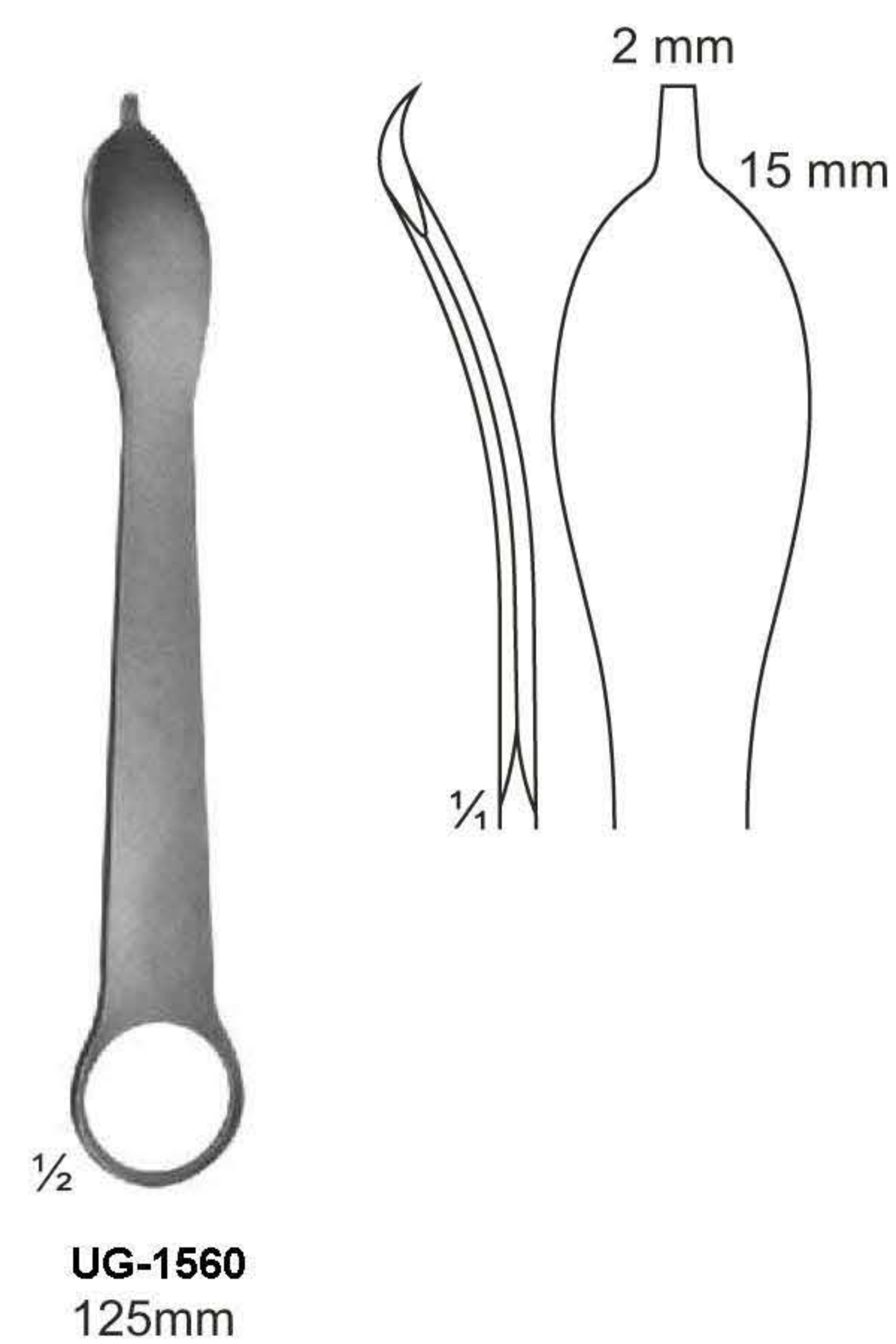
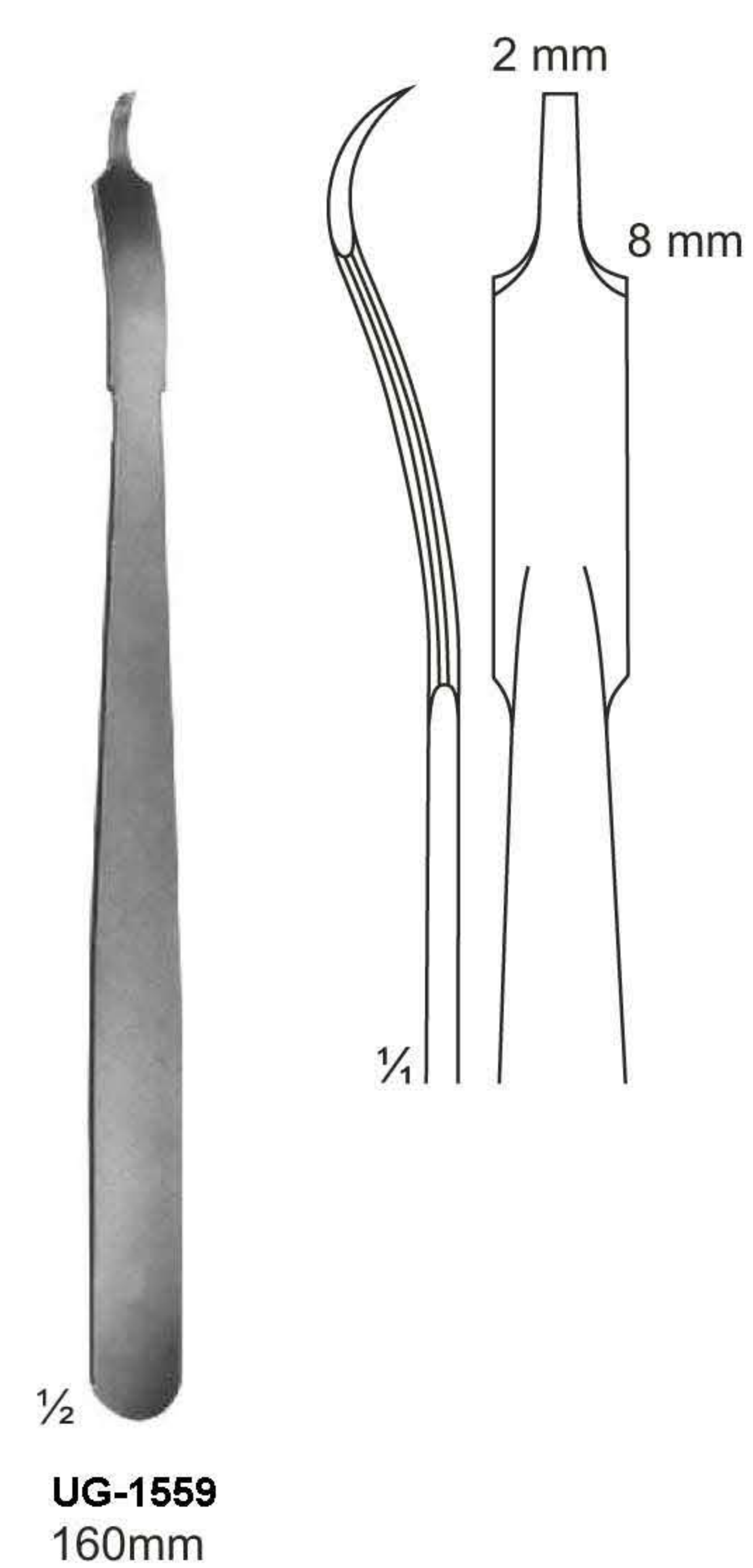
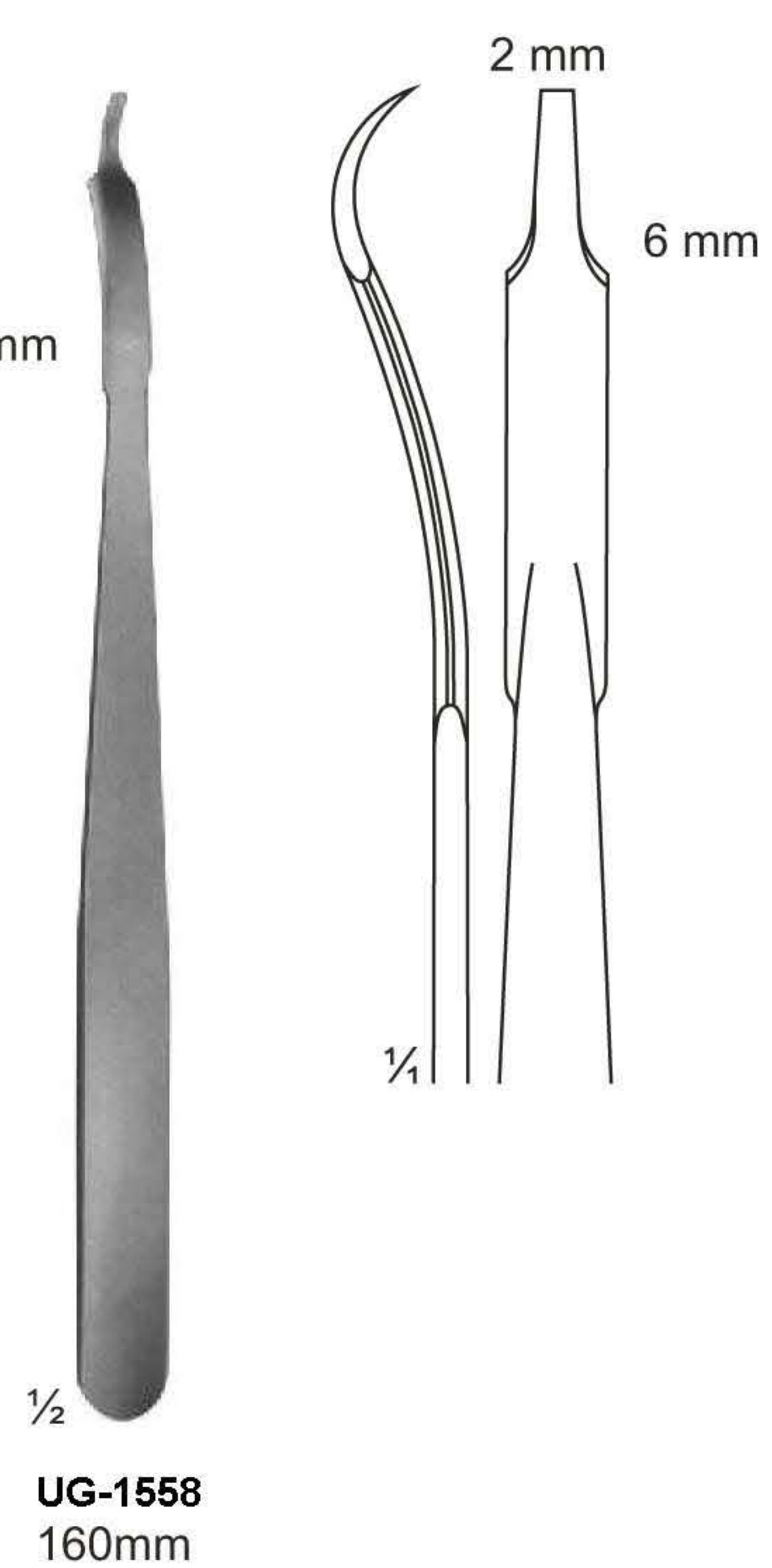
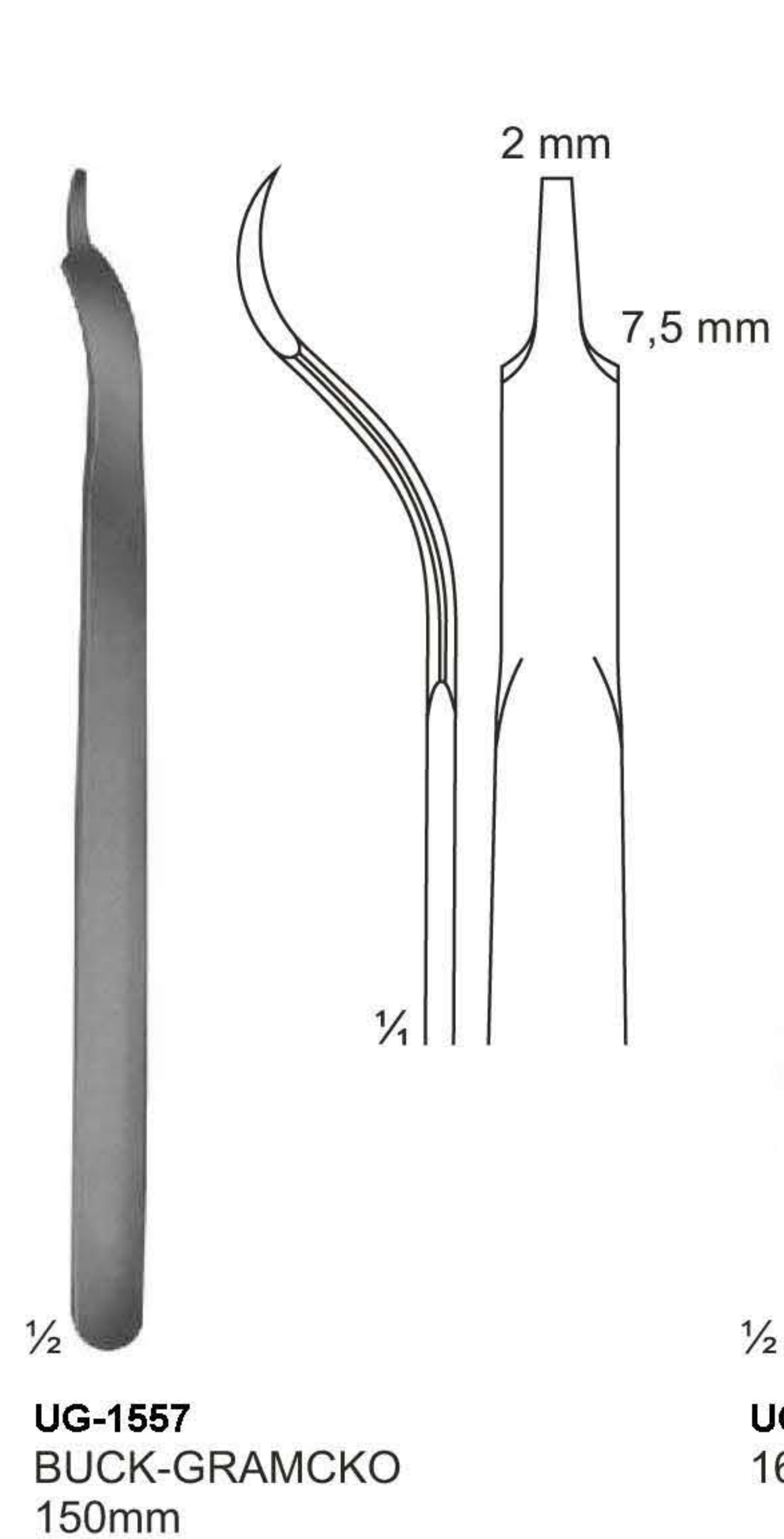
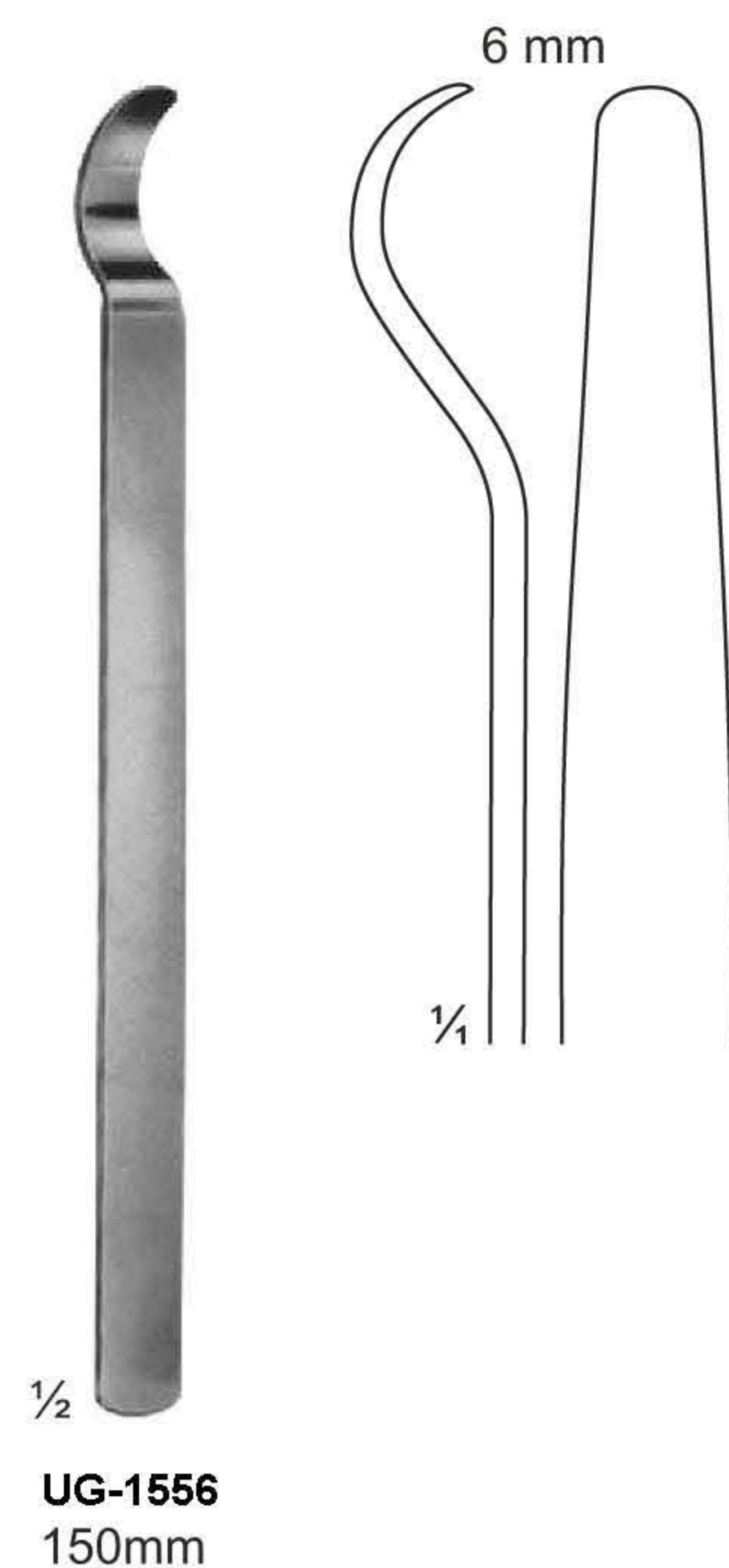
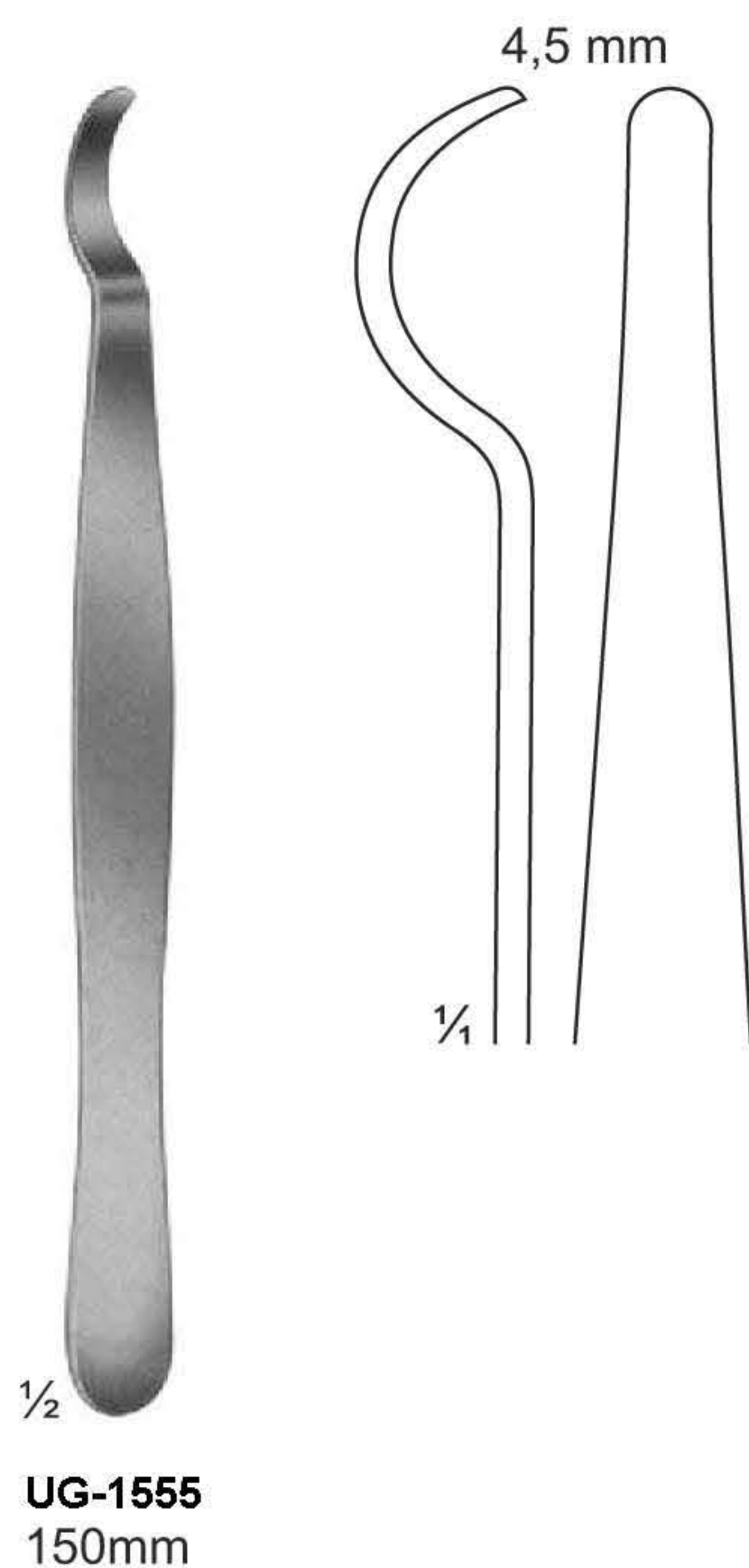
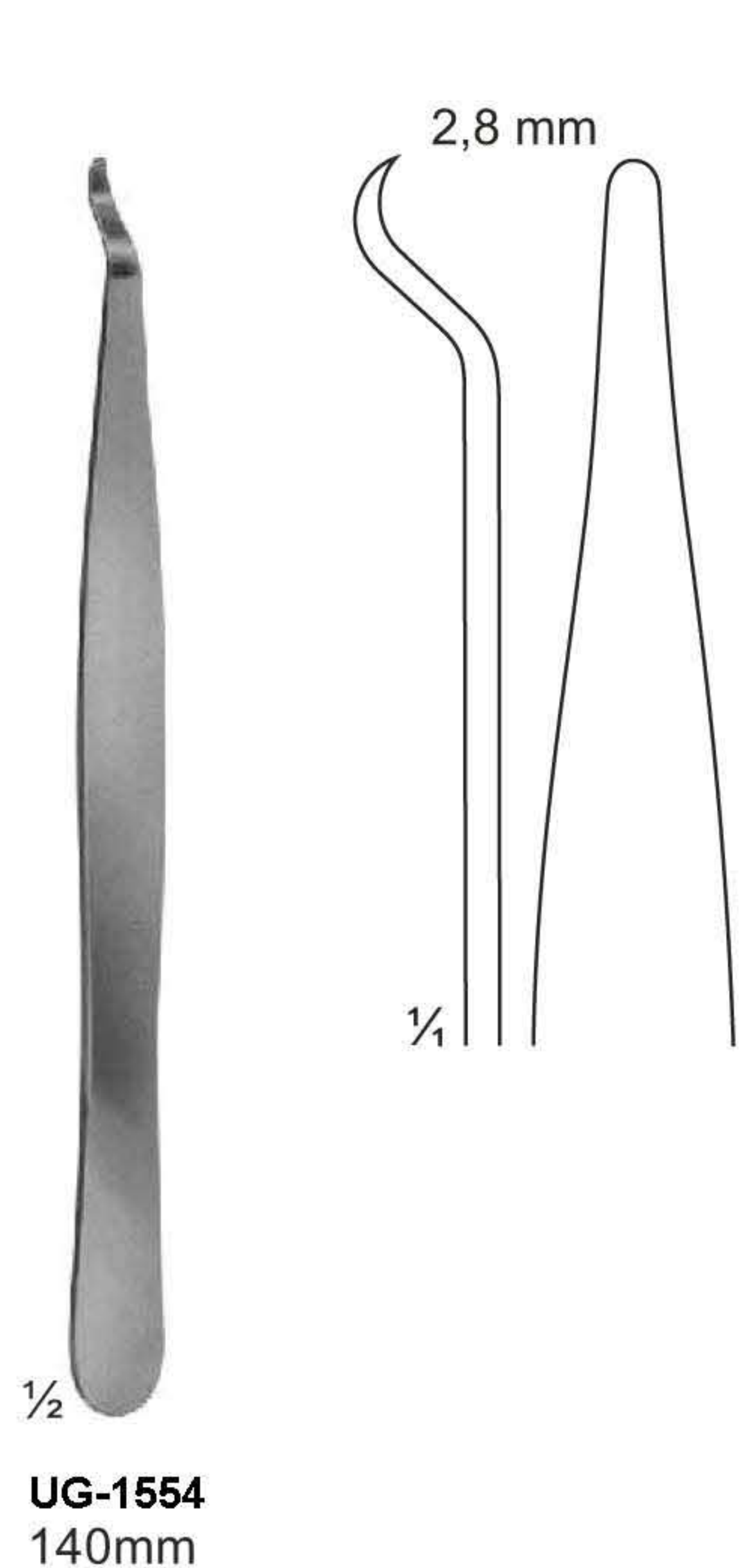

Bone Levers



UG-1561
LANE TRETOWAN
215mm

UG-1562
LANE
255mm

UG-1563
LANGE-HOHMANN
250mm

UG-1564
LANGE-HOHMANN
UG-1565 265mm
280mm

Bone Levers

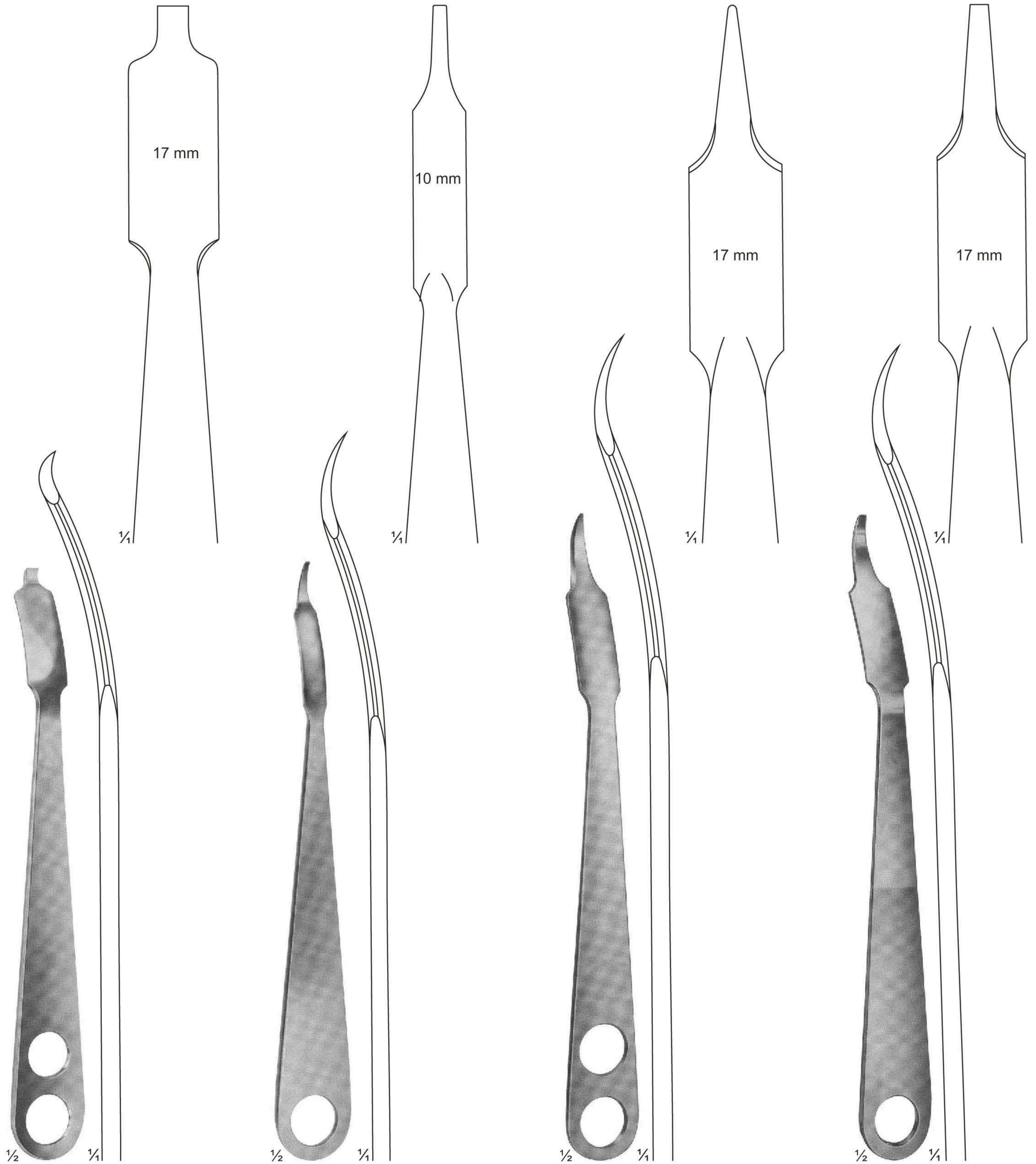

UG-1566
WAGNER
220 mm

UG-1567
220 mm

UG-1568
240 mm

UG-1569
240 mm

Bone Levers

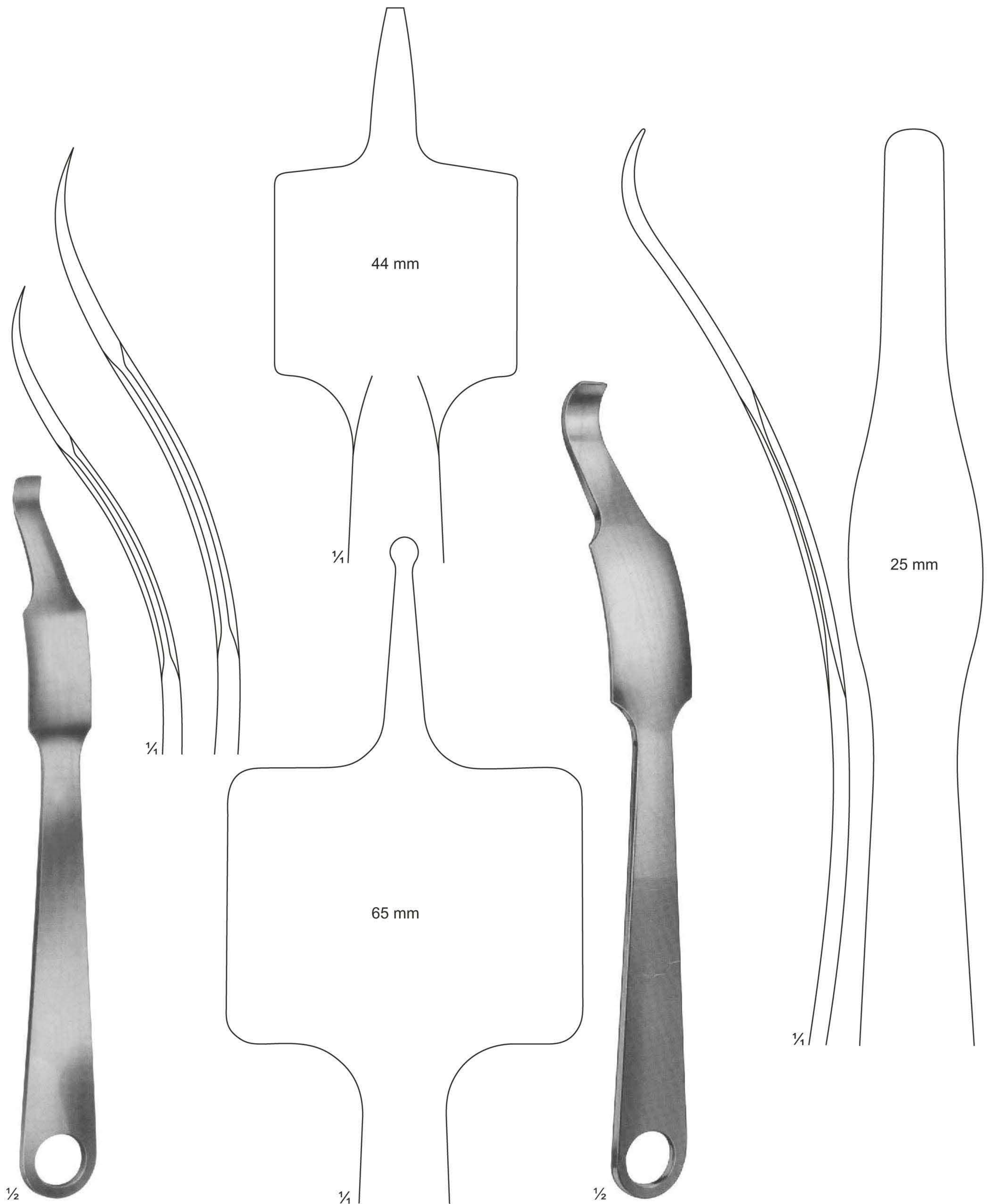

UG-1570
VERBRUGGE-MULLER
UG-1571 240 mm
255 mm

UG-1572
260 mm

Bone Levers

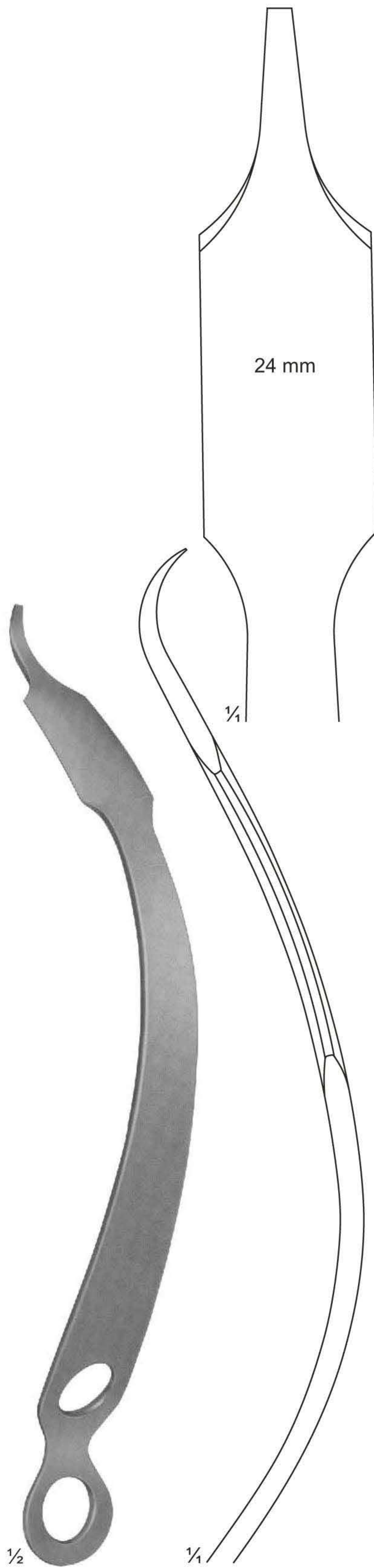

UG-1573
HOHMANN-ALDINGER
270 mm

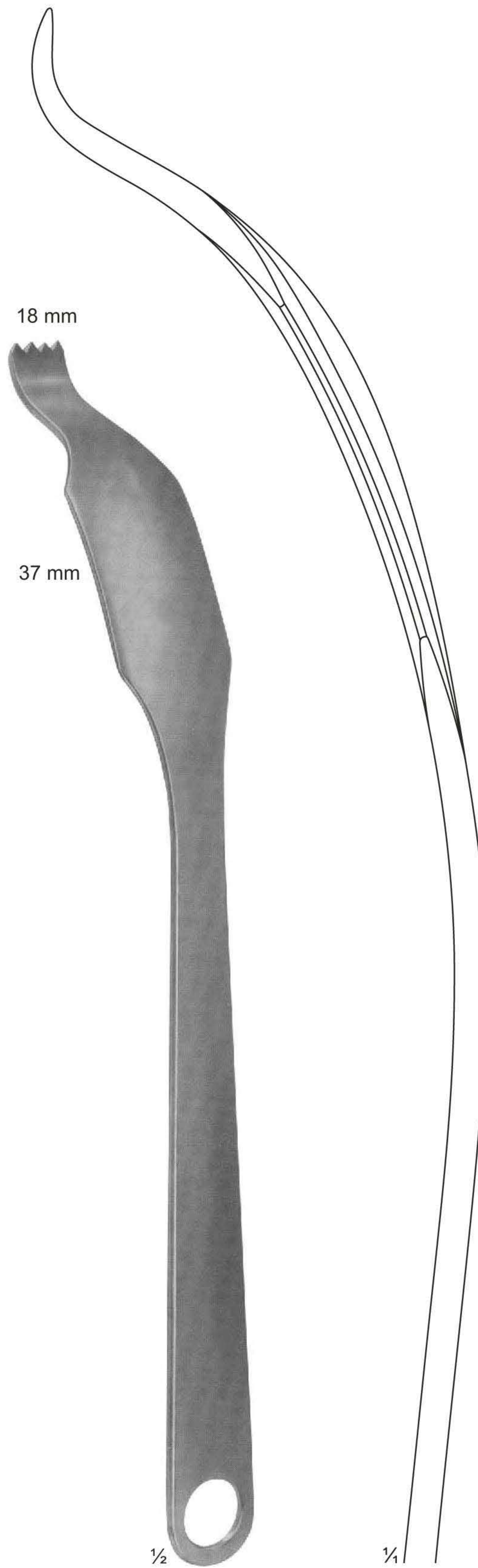

UG-1574
SCHUMACHER mod. WAGNER
345 mm

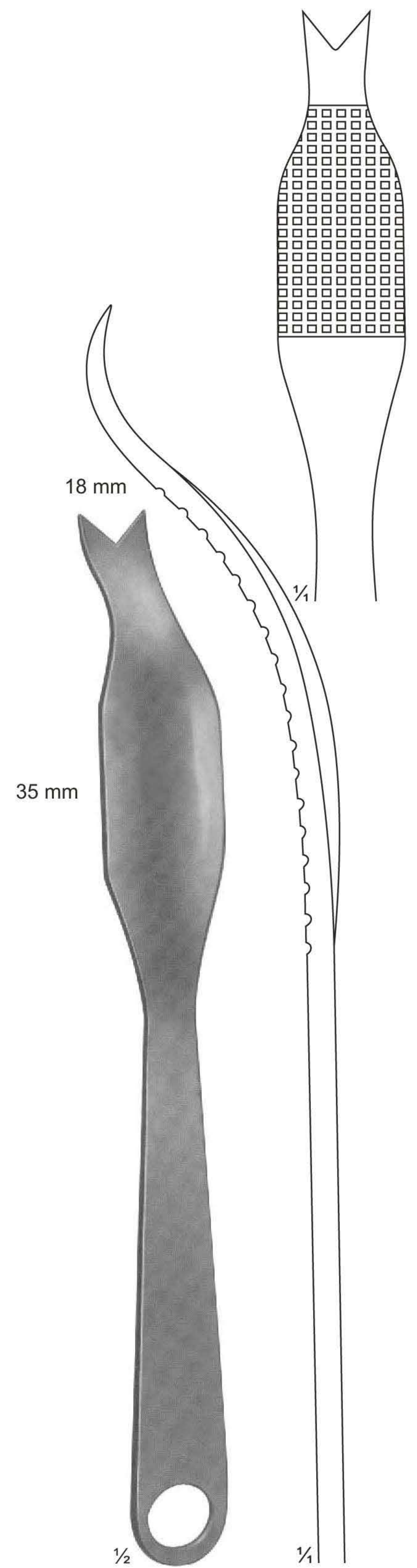

UG-1575
SCHUMACHER
290 mm

Special Bone Levers

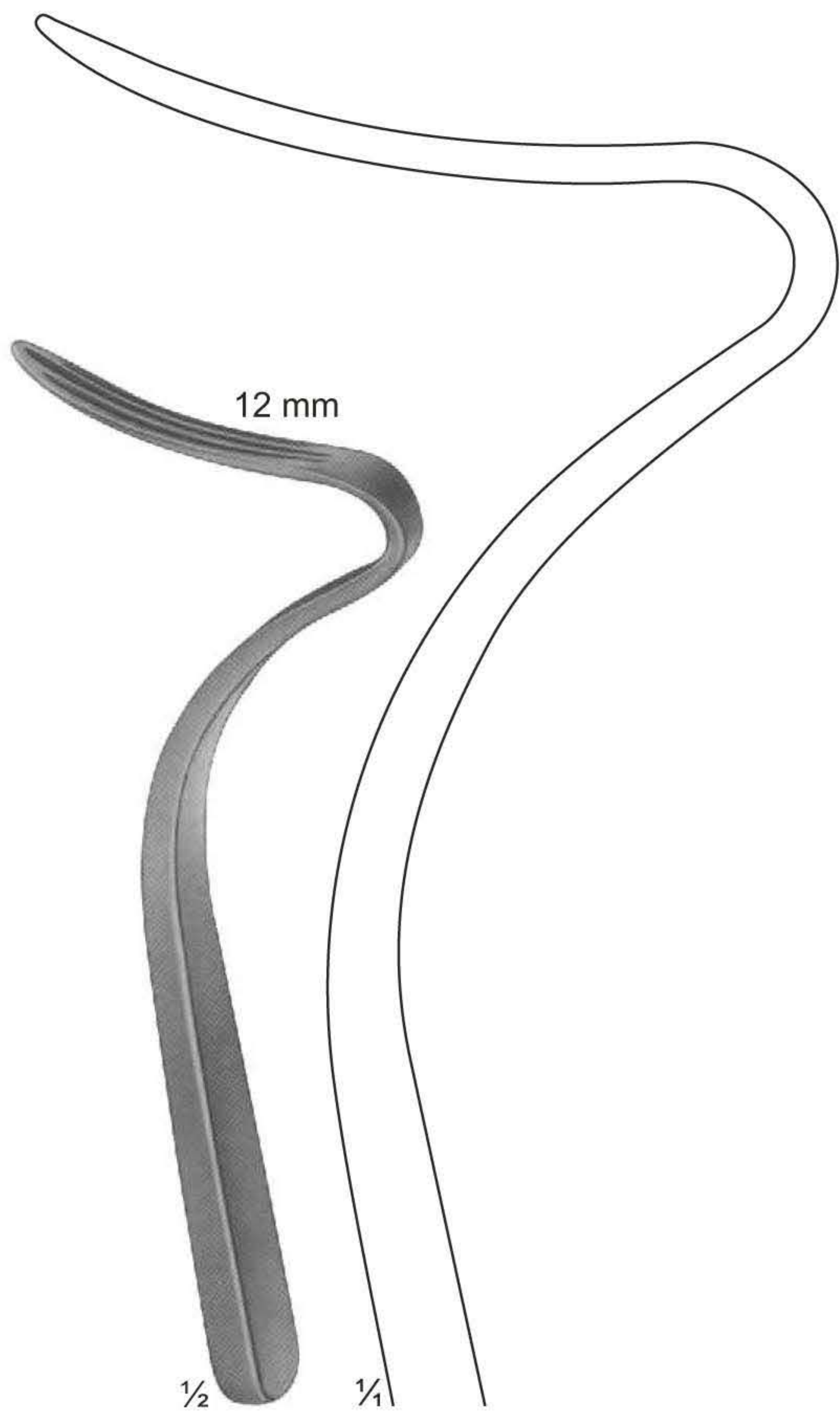

UG-1576
TAGER
 Bone lever for
 angle joint operations
 175 mm

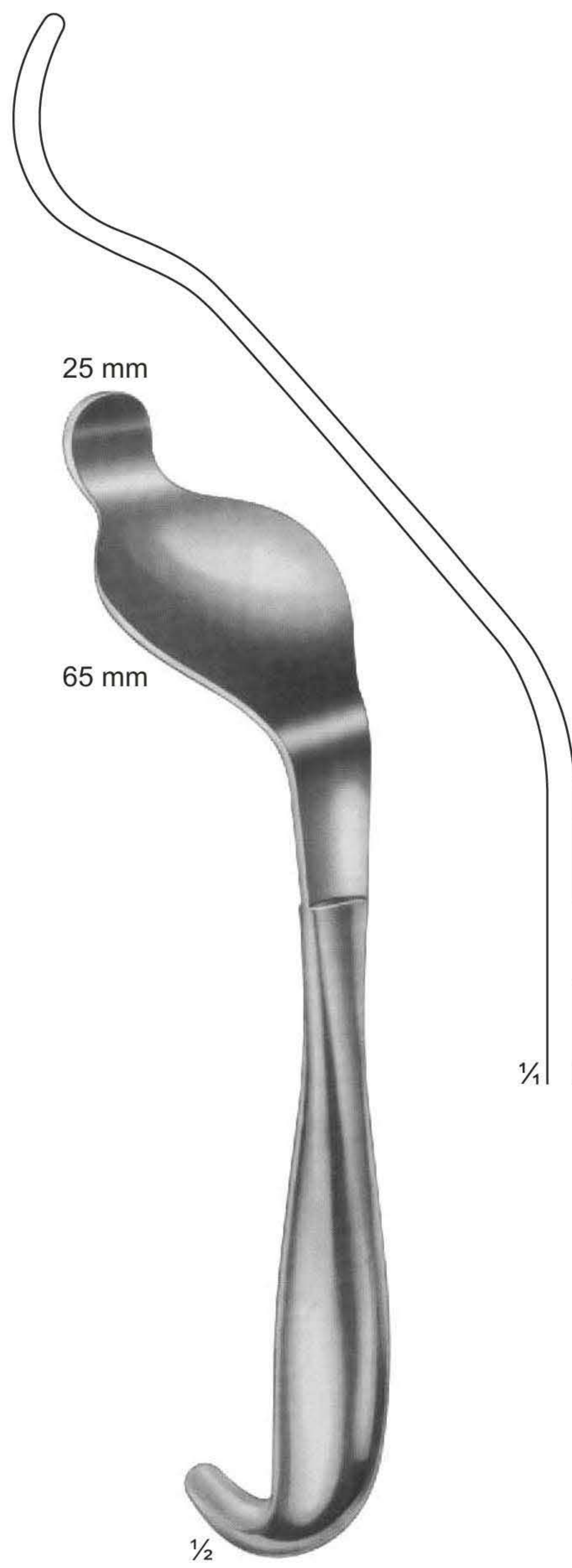

UG-1577
BENNETT
 235 mm

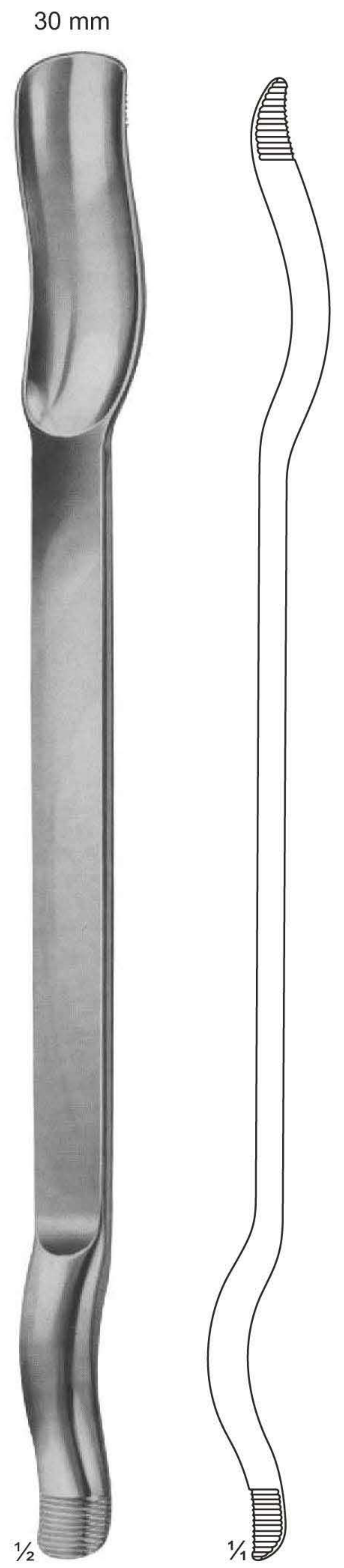

UG-1578
MURPHY-LANE
 Luxation lever
 340 mm

Raspatories



UG-1579
PARTSCH
150 mm

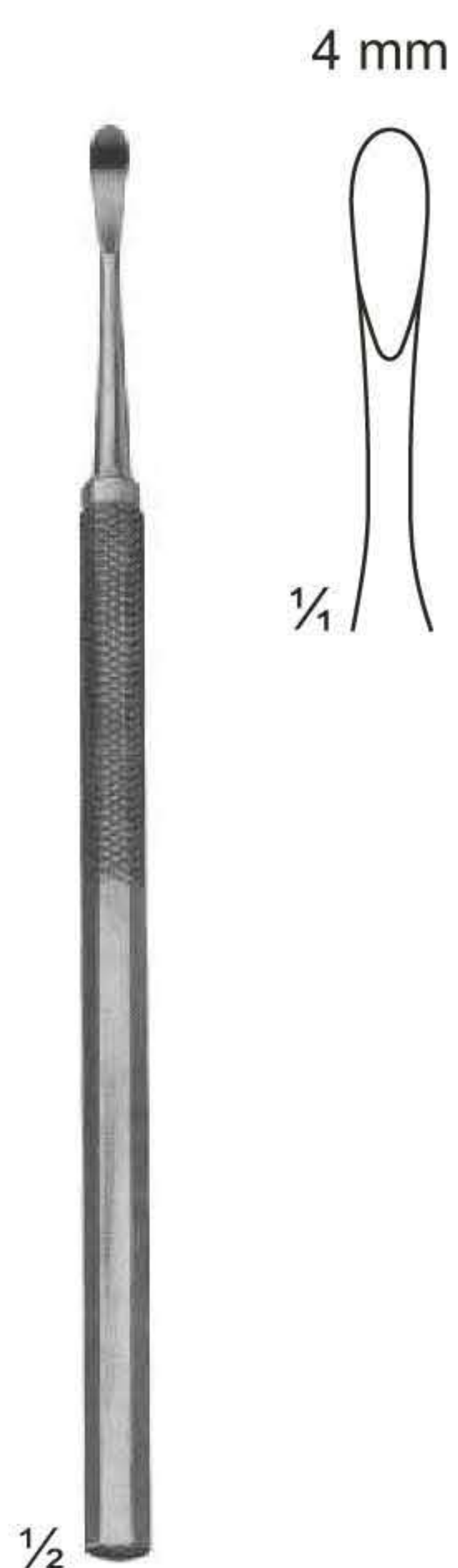

UG-1580
PARTSCH mod. LANGE
145 mm

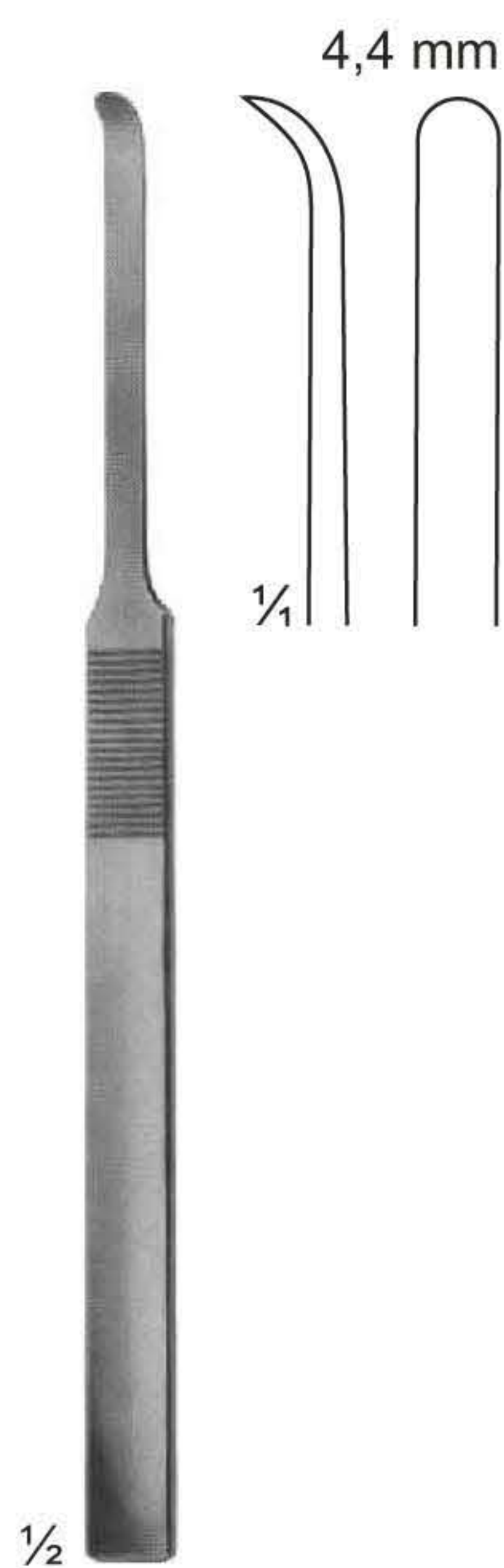

UG-1581
MC KENTY
155 mm

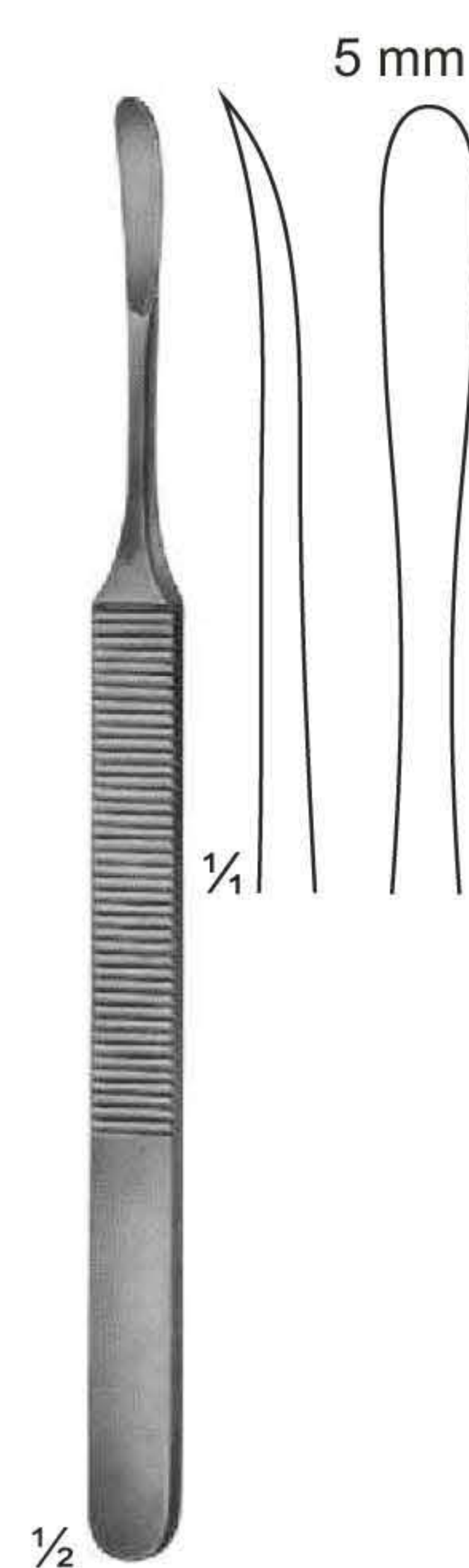

UG-1582
KONIG
155 mm

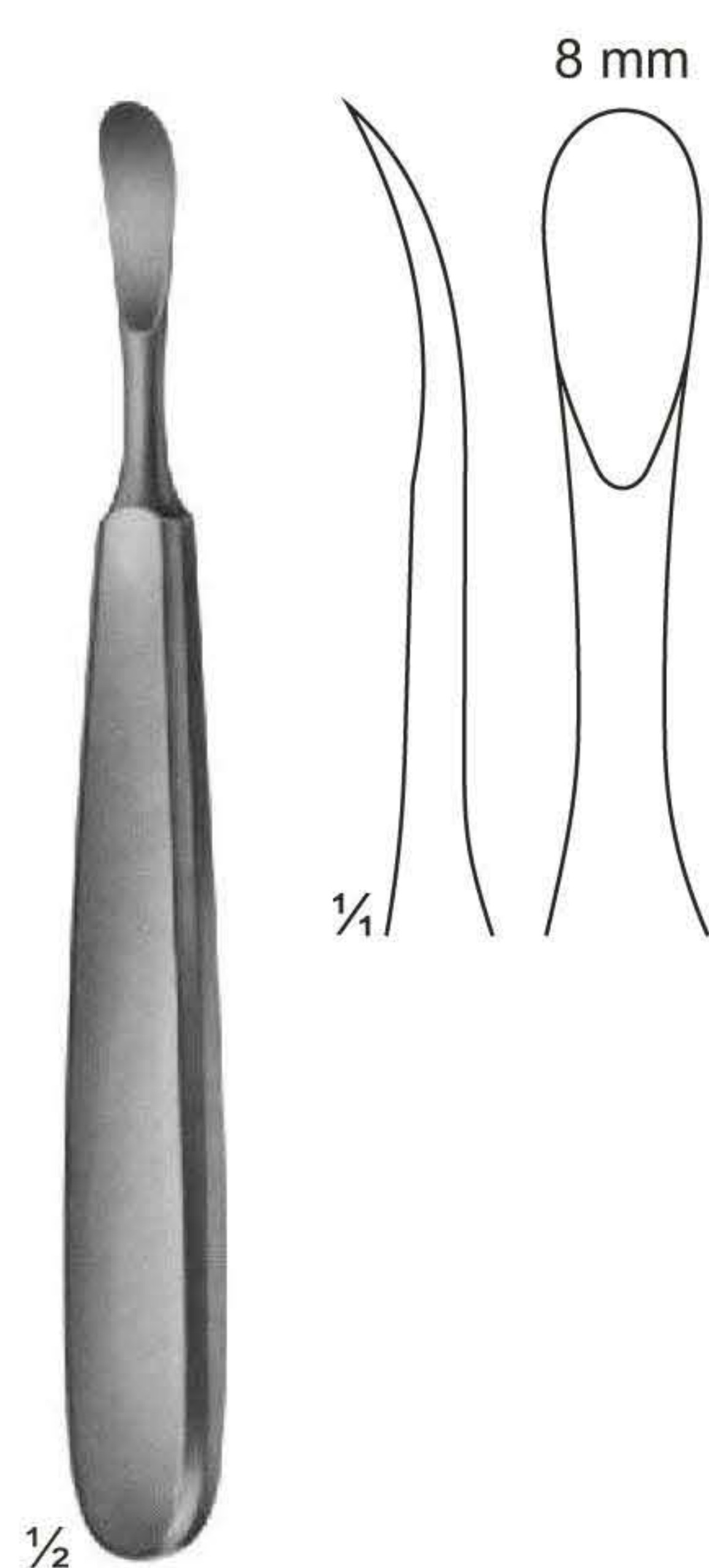

UG-1583
TRELAT
150 mm

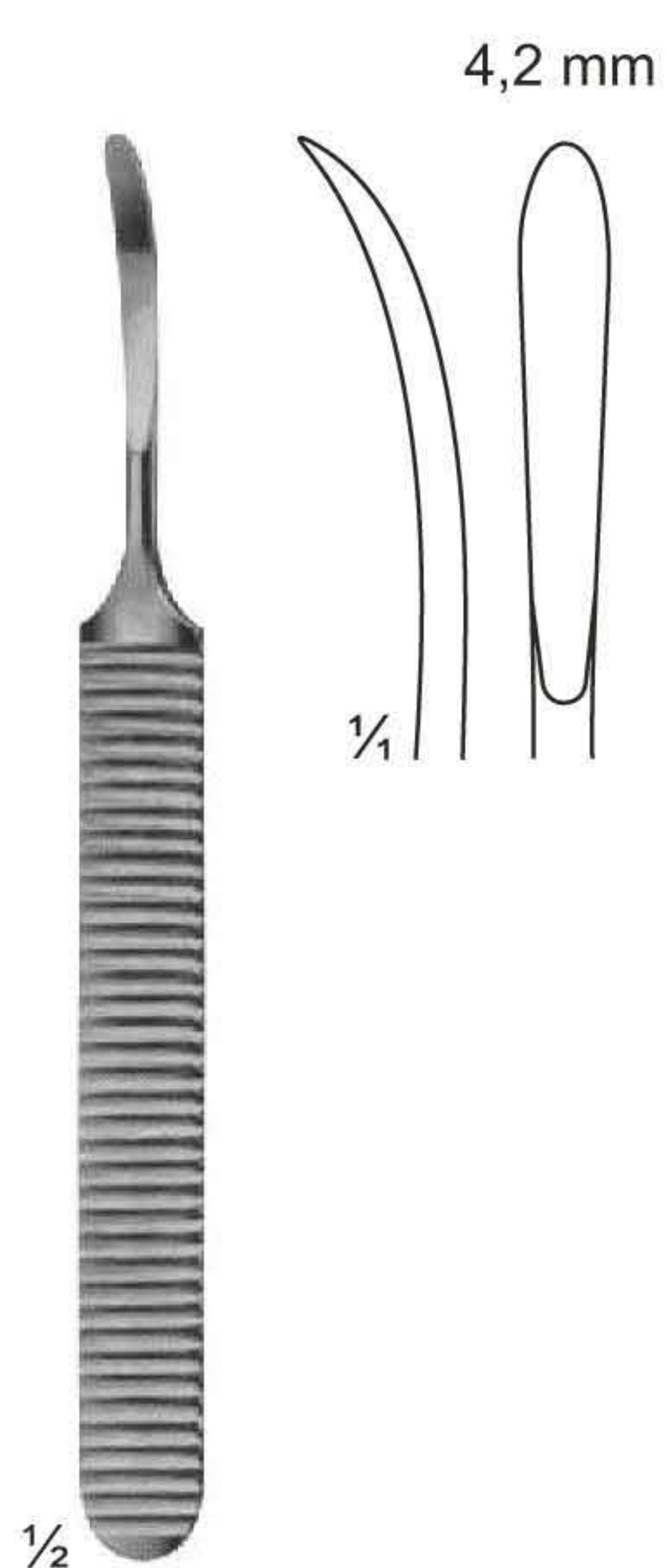

UG-1584
WILLIGER
140 mm

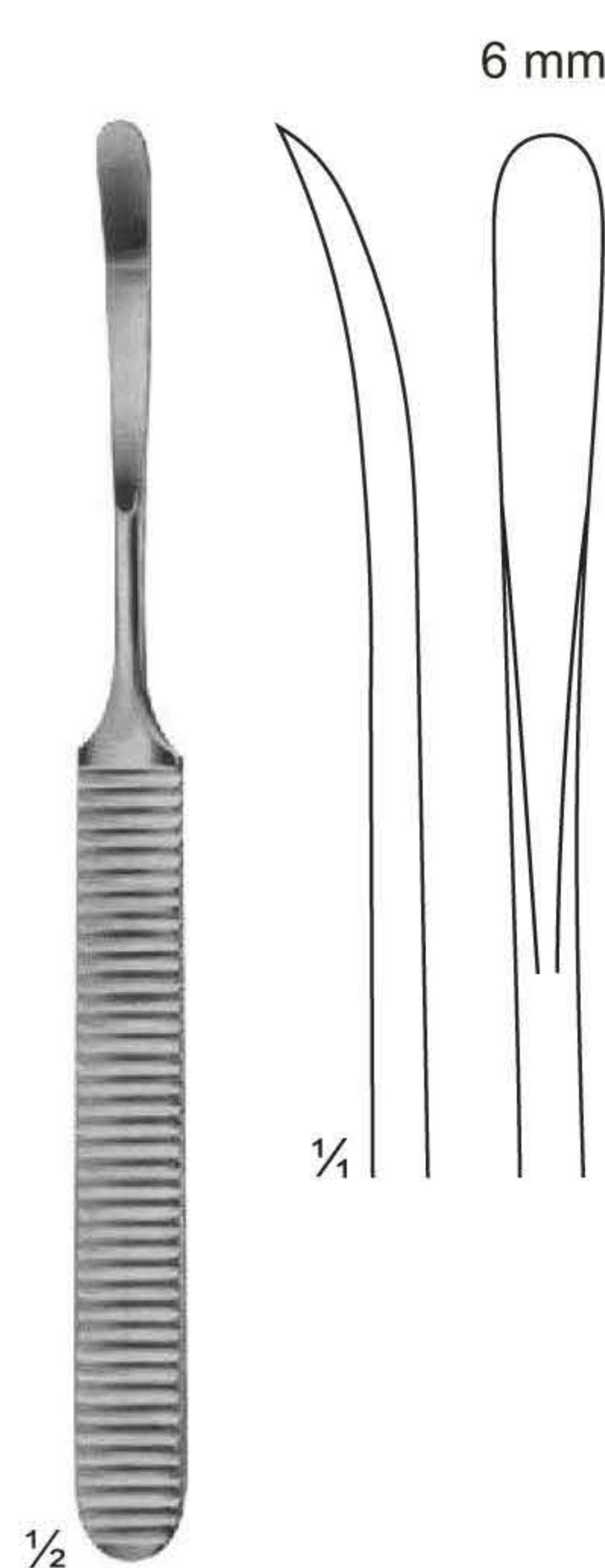

UG-1585
WILLIGER
160 mm

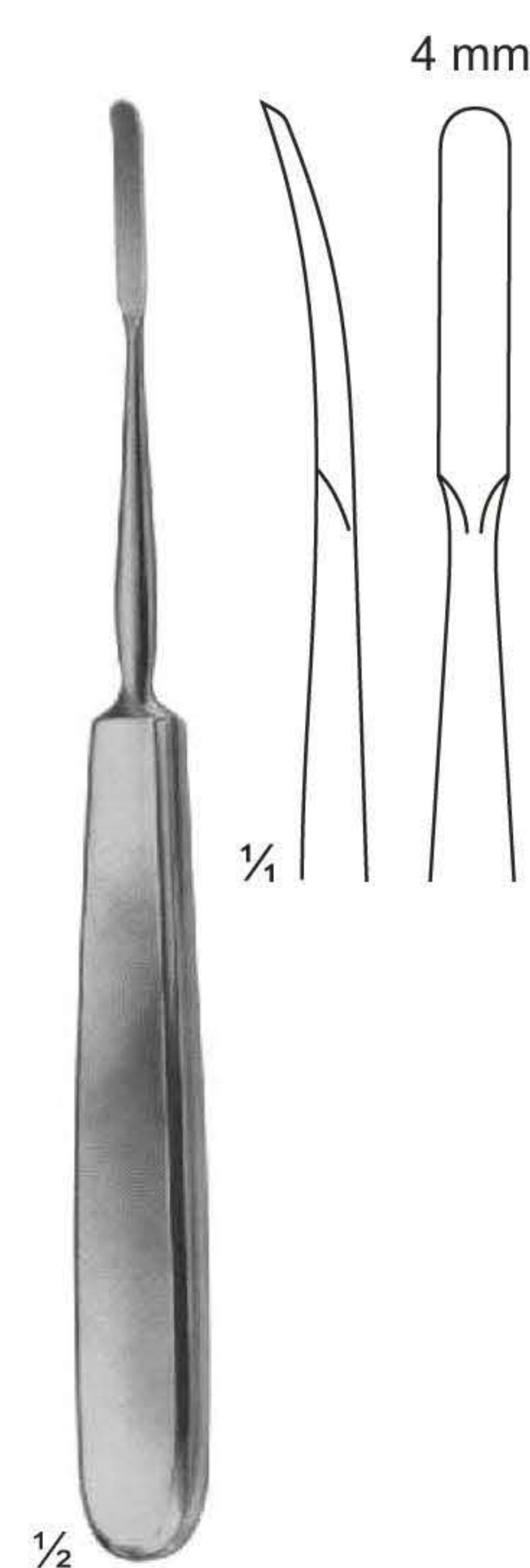

UG-1586
JOSEPH
170 mm

Raspatories

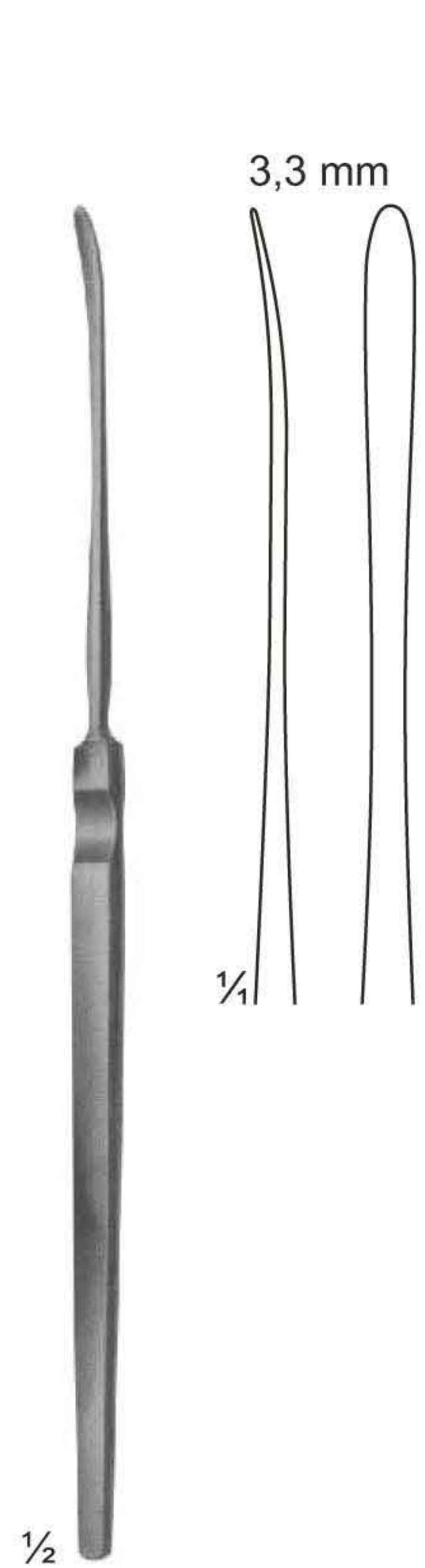

UG-1587
HALLE
stumfp/blunt
180 mm



UG-1588
FREER
stumfp/blunt
190 mm

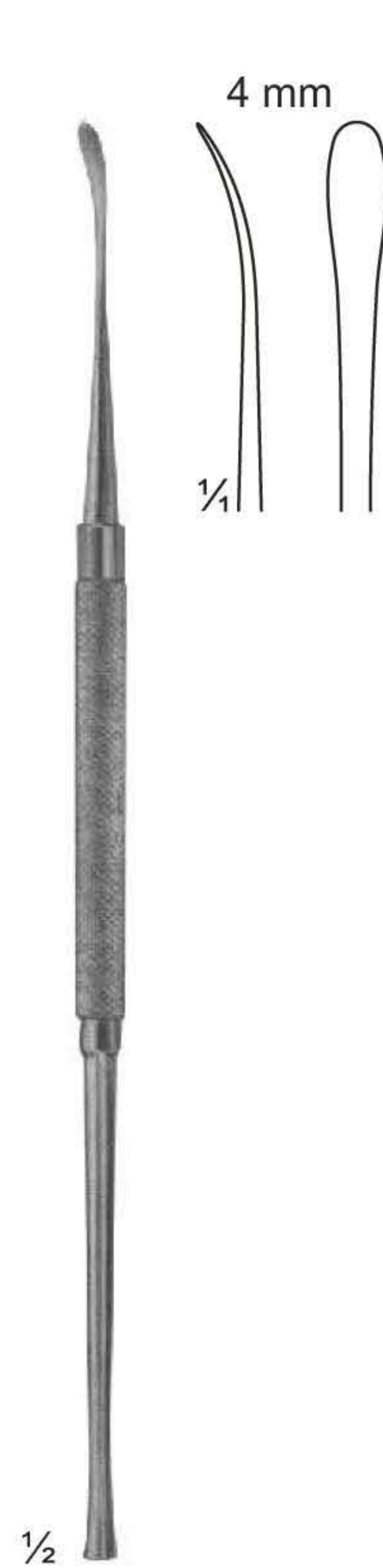

UG-1589
FREER
stumfp/sharp
190 mm



UG-1590
SEWALL
stumfp/blunt
190 mm



UG-1591
PAULSEN
205 mm



UG-1592
PAULSEN
205 mm

Raspatories

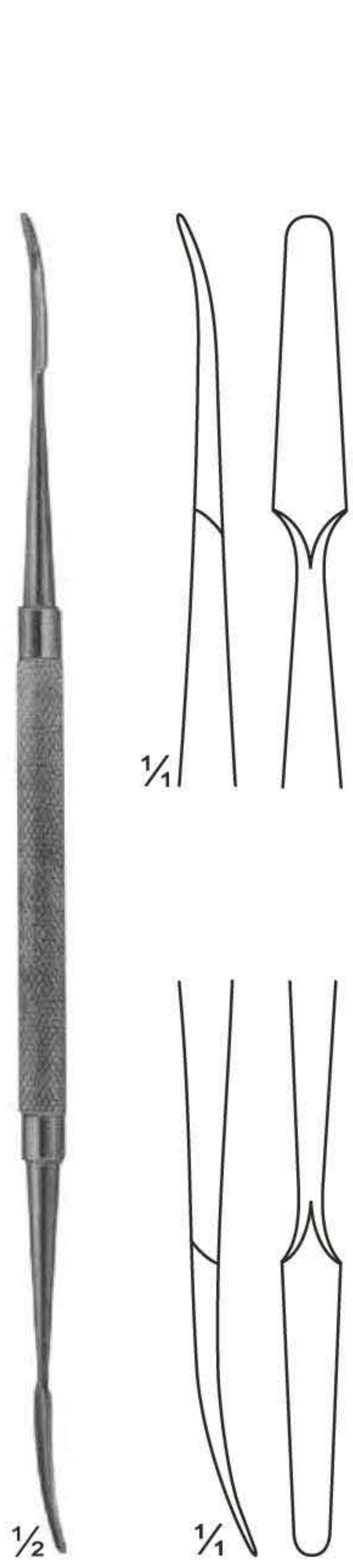

UG-1593
KILLIAN
sharp/blunt
185 mm

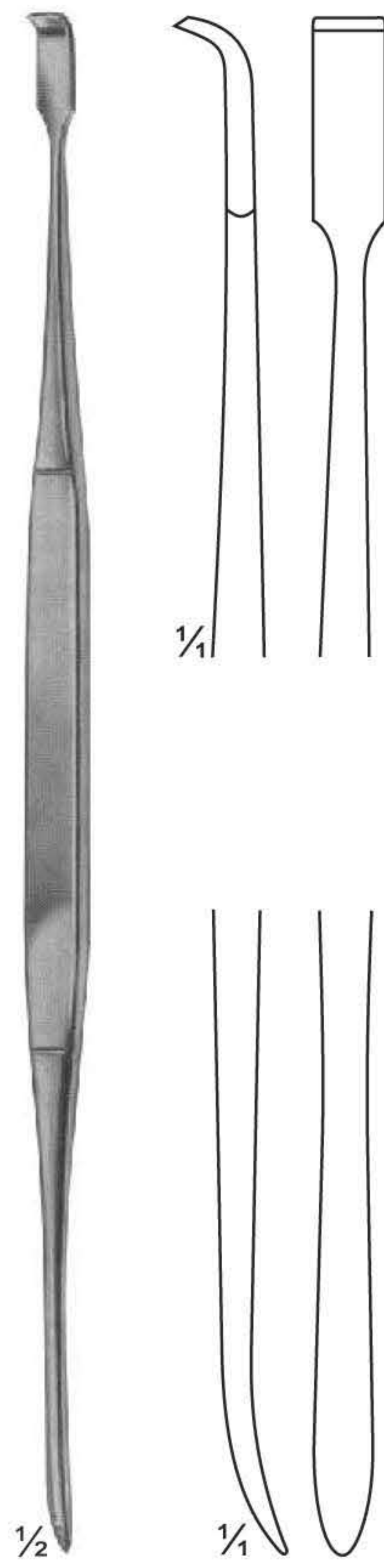

UG-1594
HOWARTH
sharp/blunt
215 mm

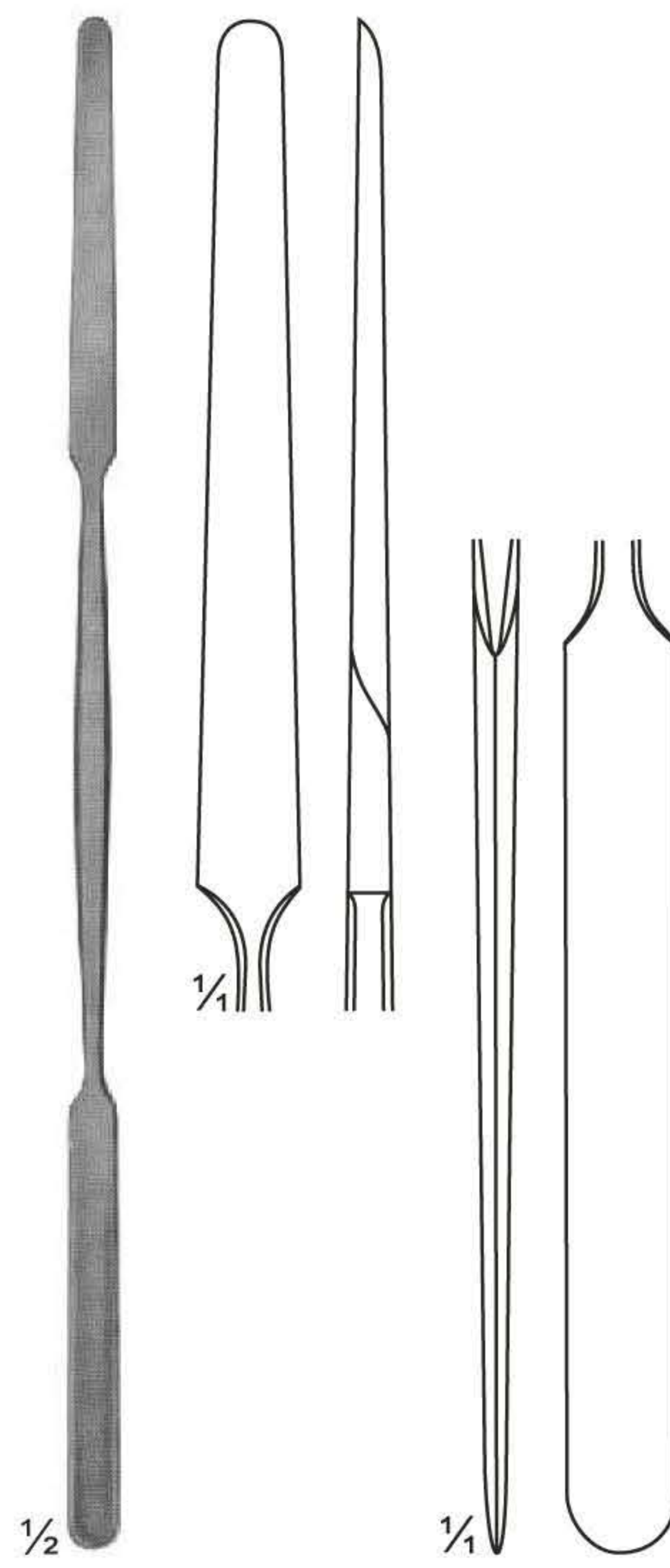

UG-1595
KILLIAN
sharp/blunt
185 mm

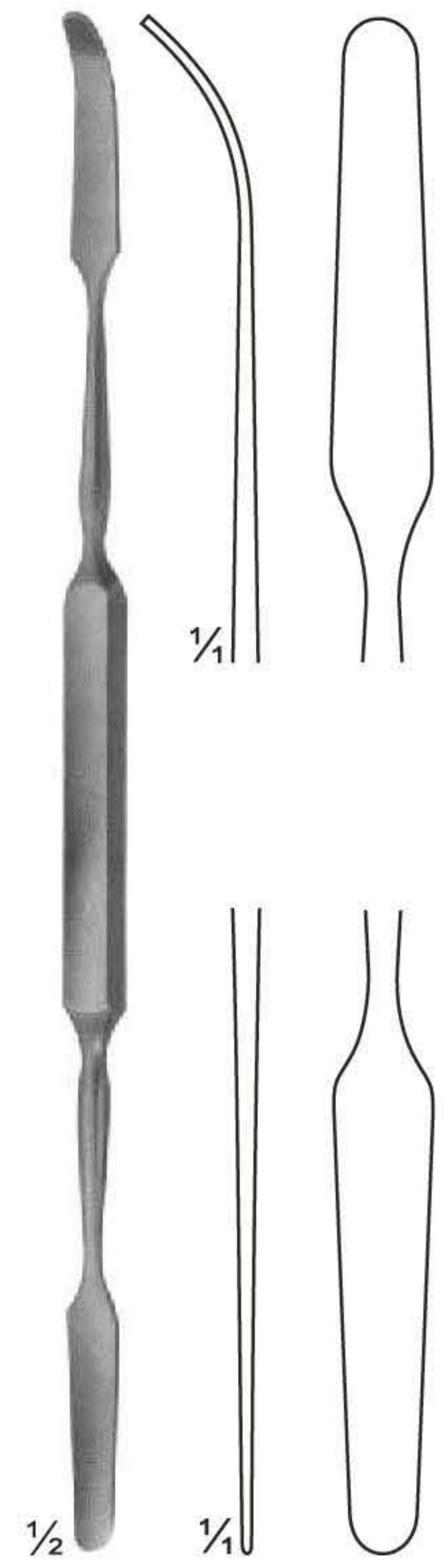

UG-1596
MAC DONALD
blunt/blunt
185 mm

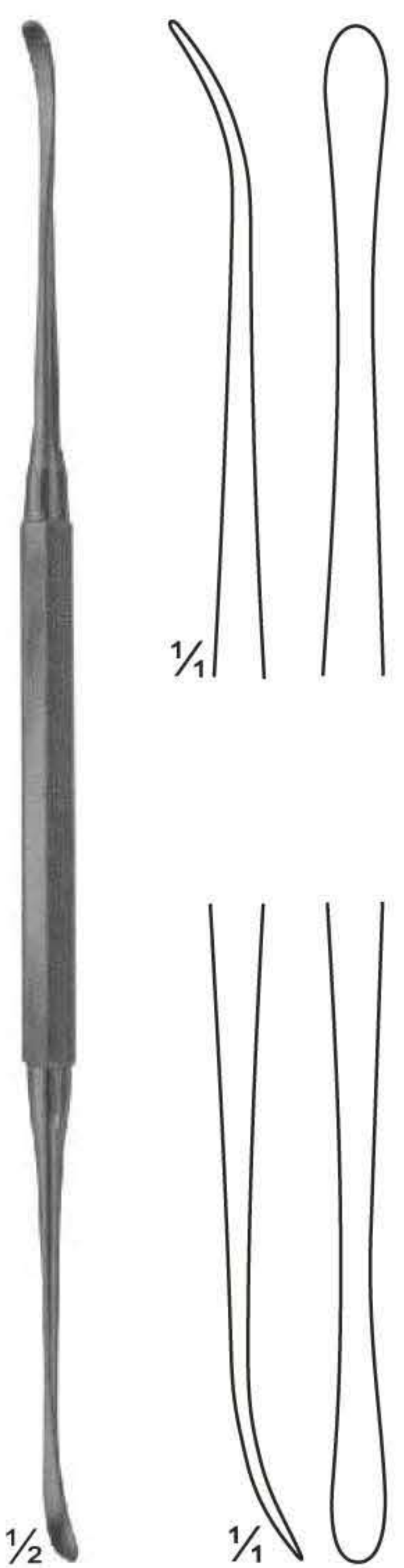

UG-1597
FREER
sharp/blunt
185 mm

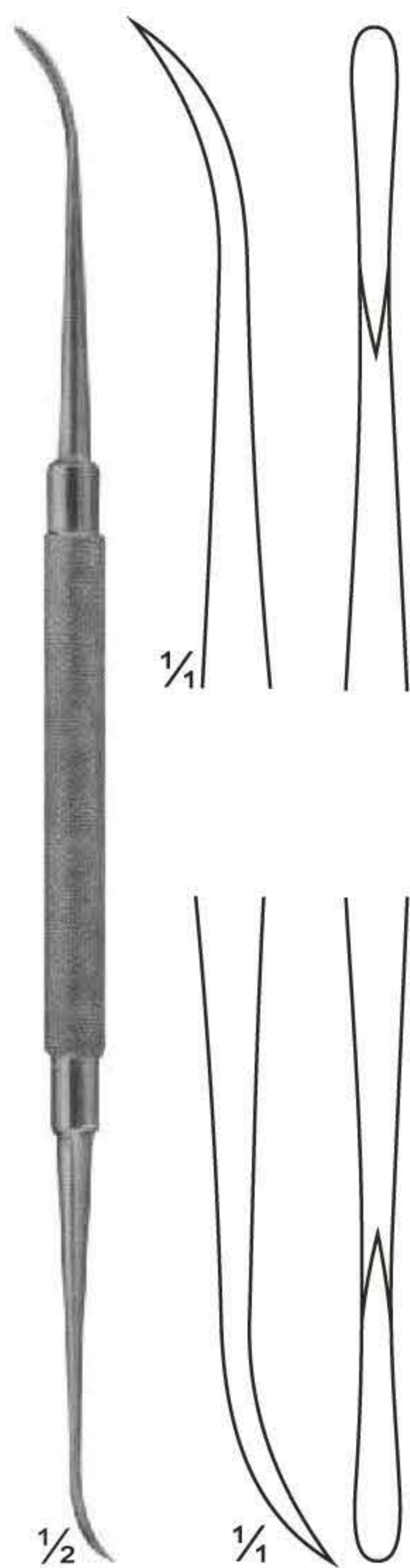

UG-1598
FREER-YASARGIL
sharp/sharp
185 mm

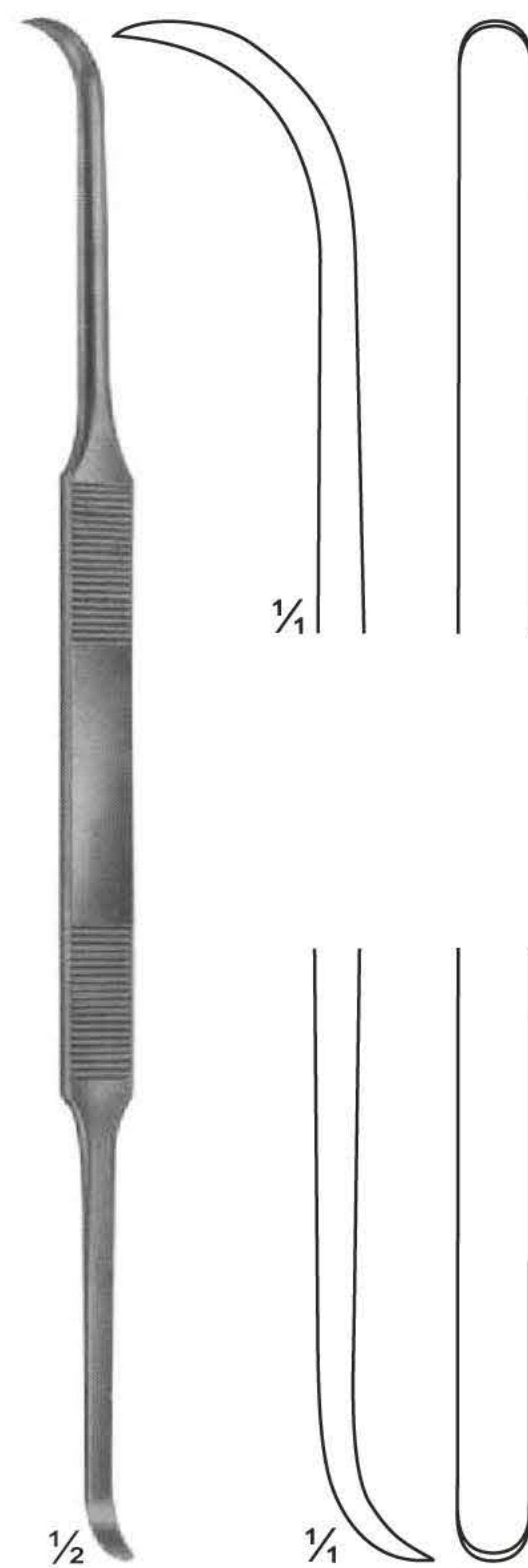

UG-1599
COTTLE
sharp/sharp
200 mm

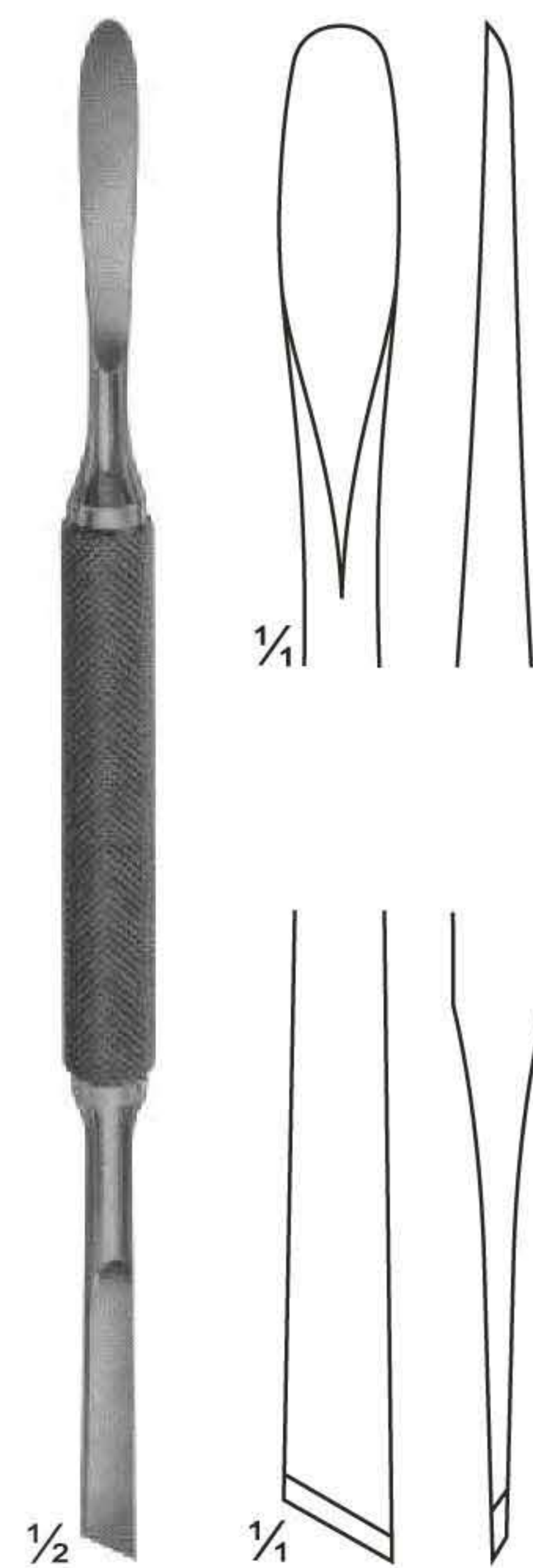

UG-1600
MEAD
sharp/sharp
165 mm

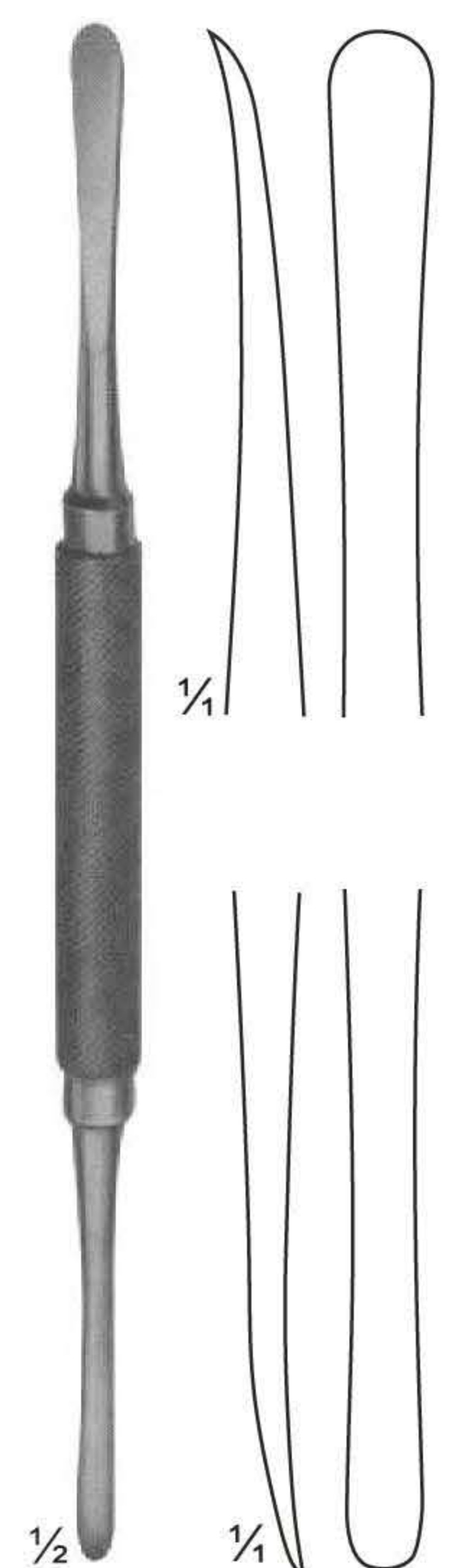

UG-1601
MOLT
sharp/sharp
180 mm

Raspatories



$\frac{1}{2}$
UG-1602
MANNERFET
155 mm



$\frac{1}{2}$
UG-1609
165 mm



$\frac{1}{2}$
UG-1610
ADSON
170 mm

Raspatories



1/2
UG-1611
 MUHLING
 170 mm



1/2
UG-1612
 COTTLE
 175 mm

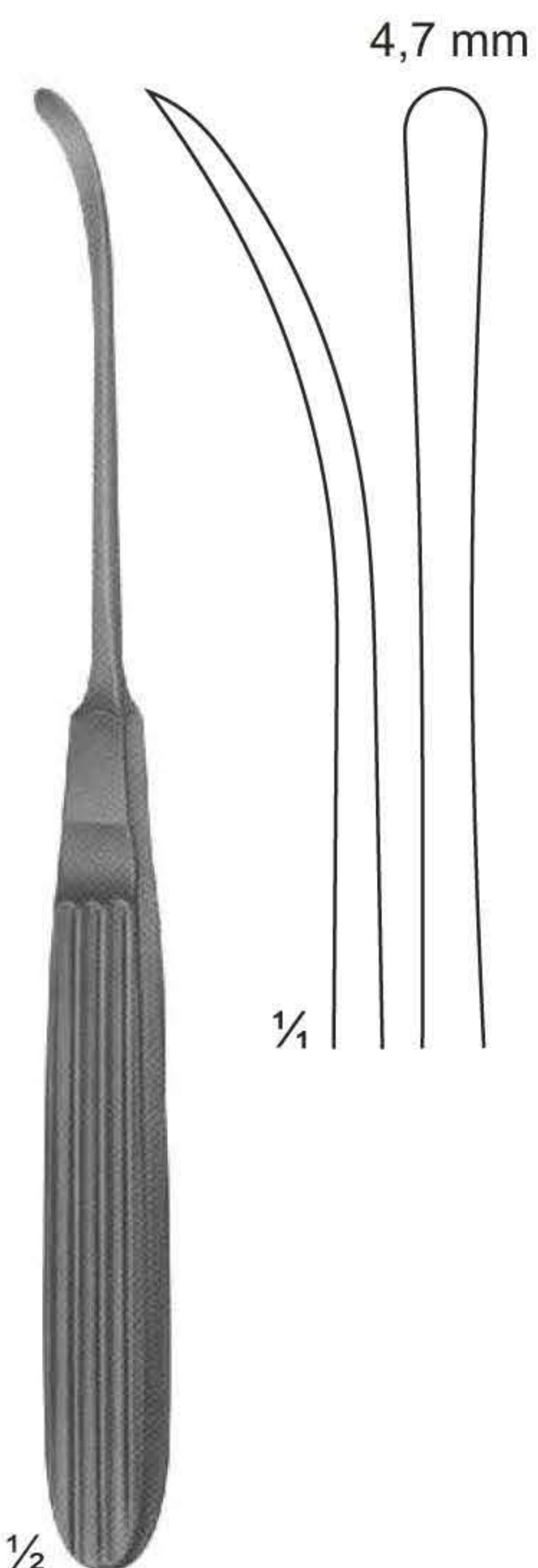
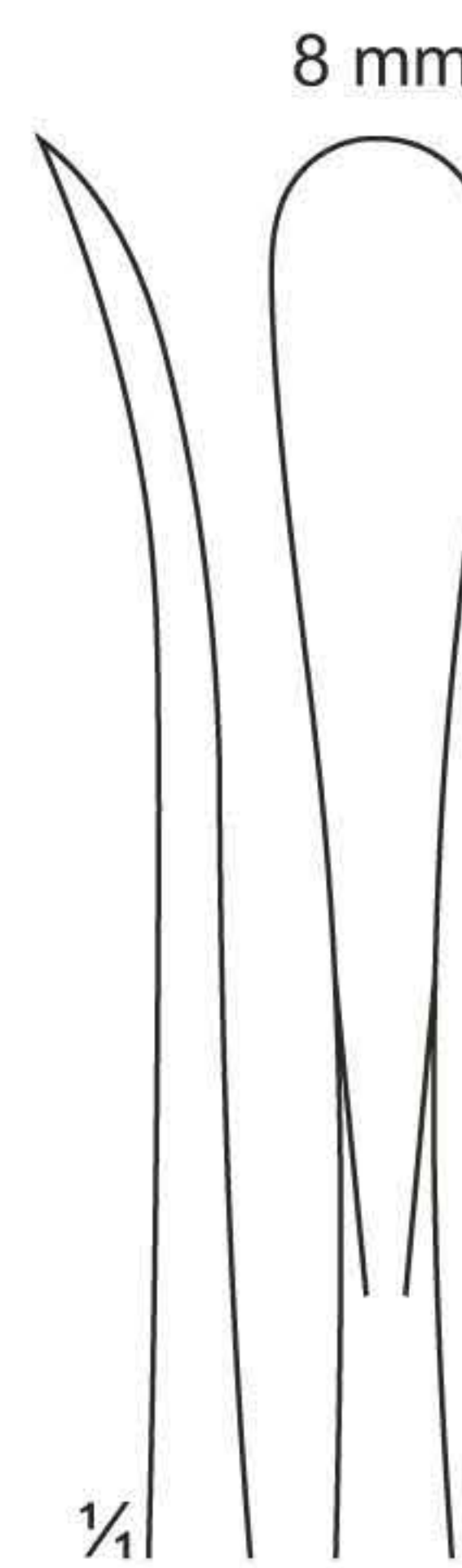

1/2
UG-1613
 LANDOT
 175 mm

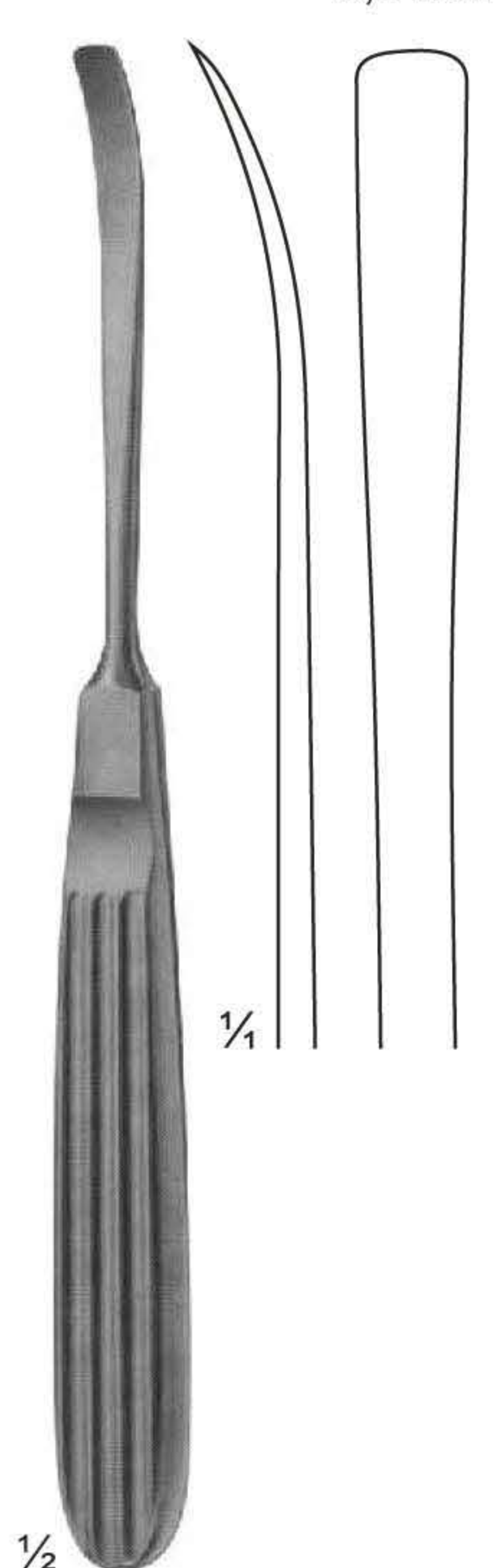
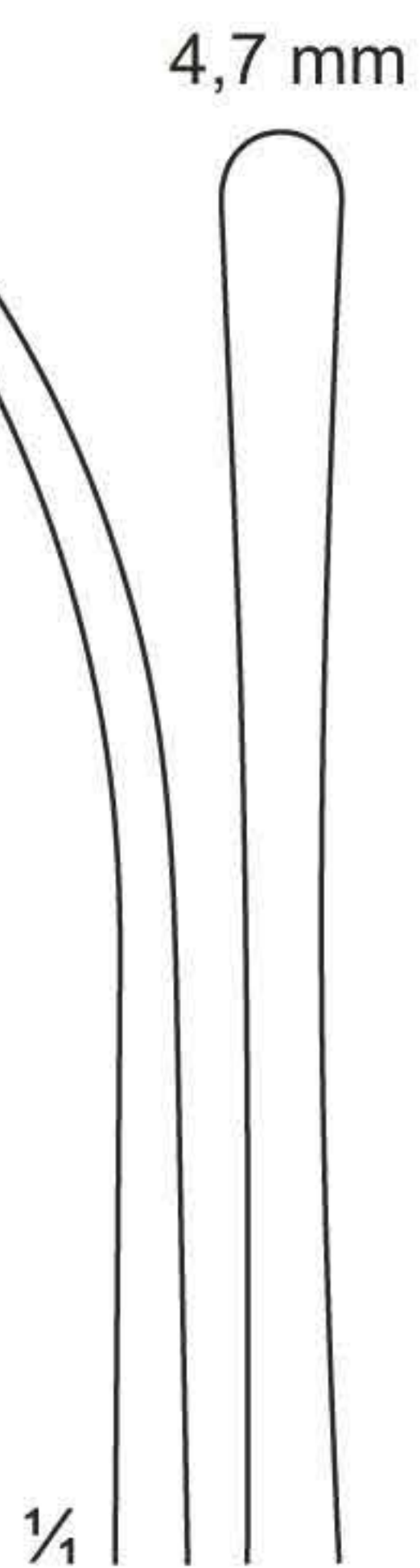

1/2
UG-1614
 CASPER
 180 mm

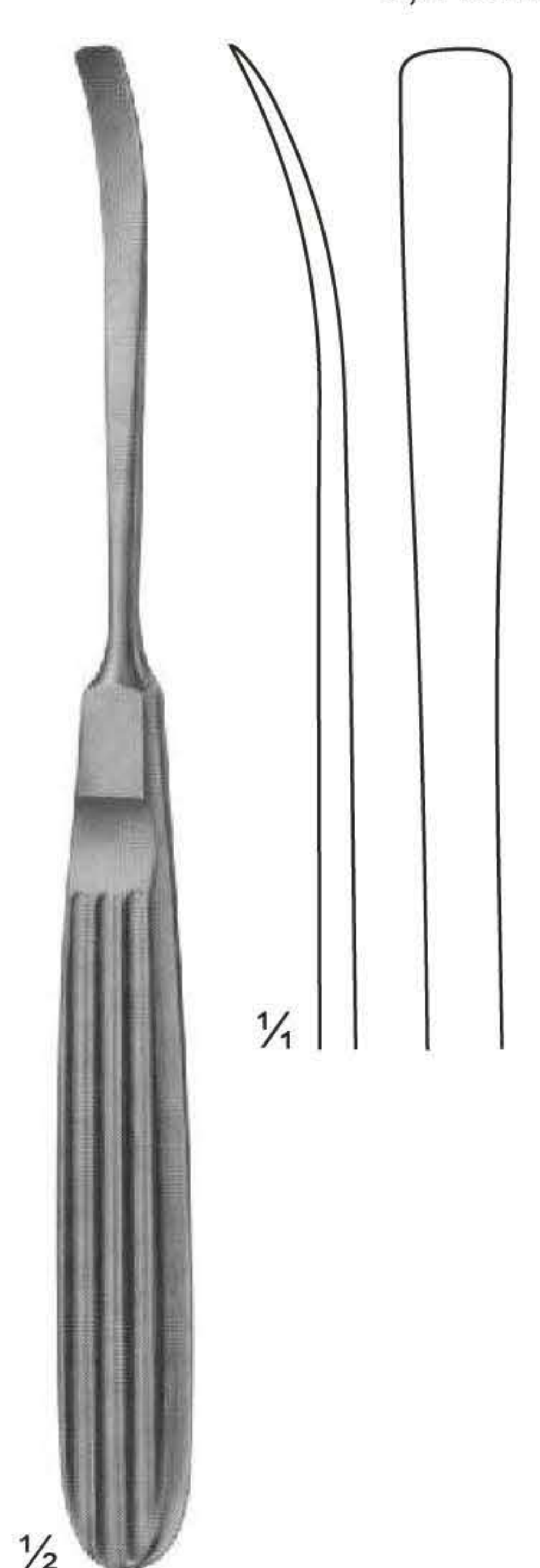
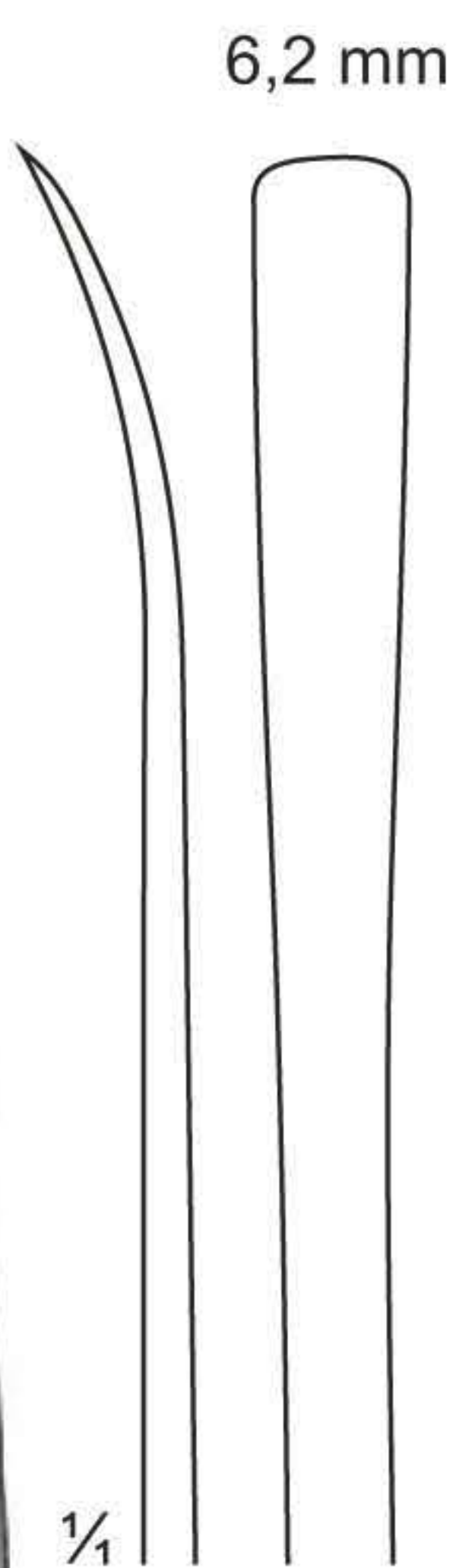

1/2
UG-1615
 CASPER
 180 mm

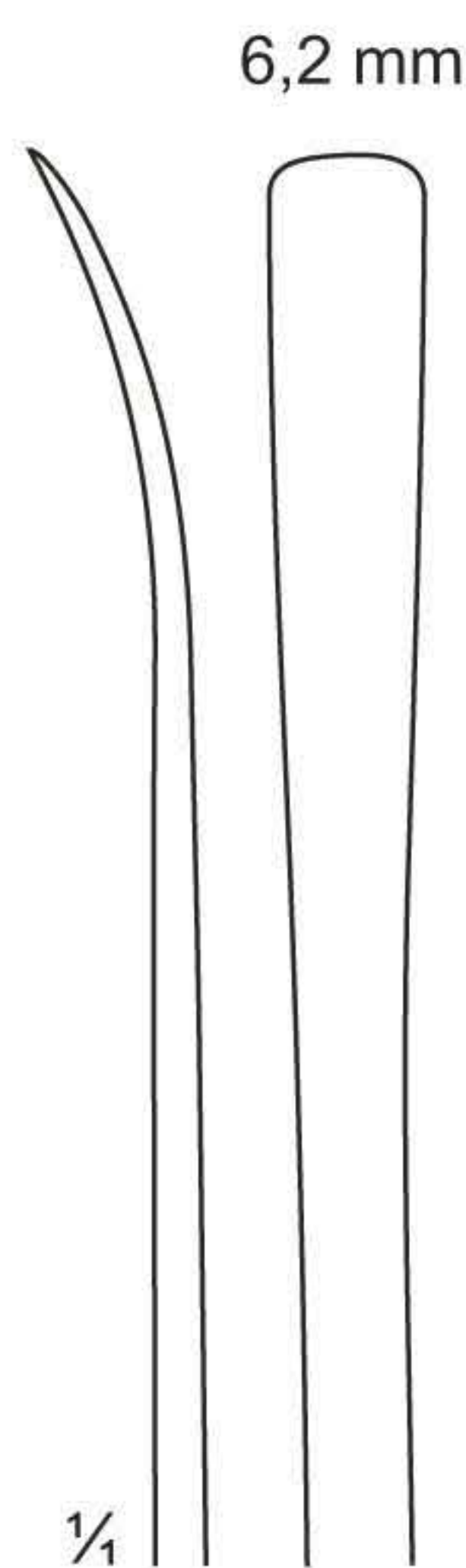

1/2
UG-1616
 170 mm

Raspatories

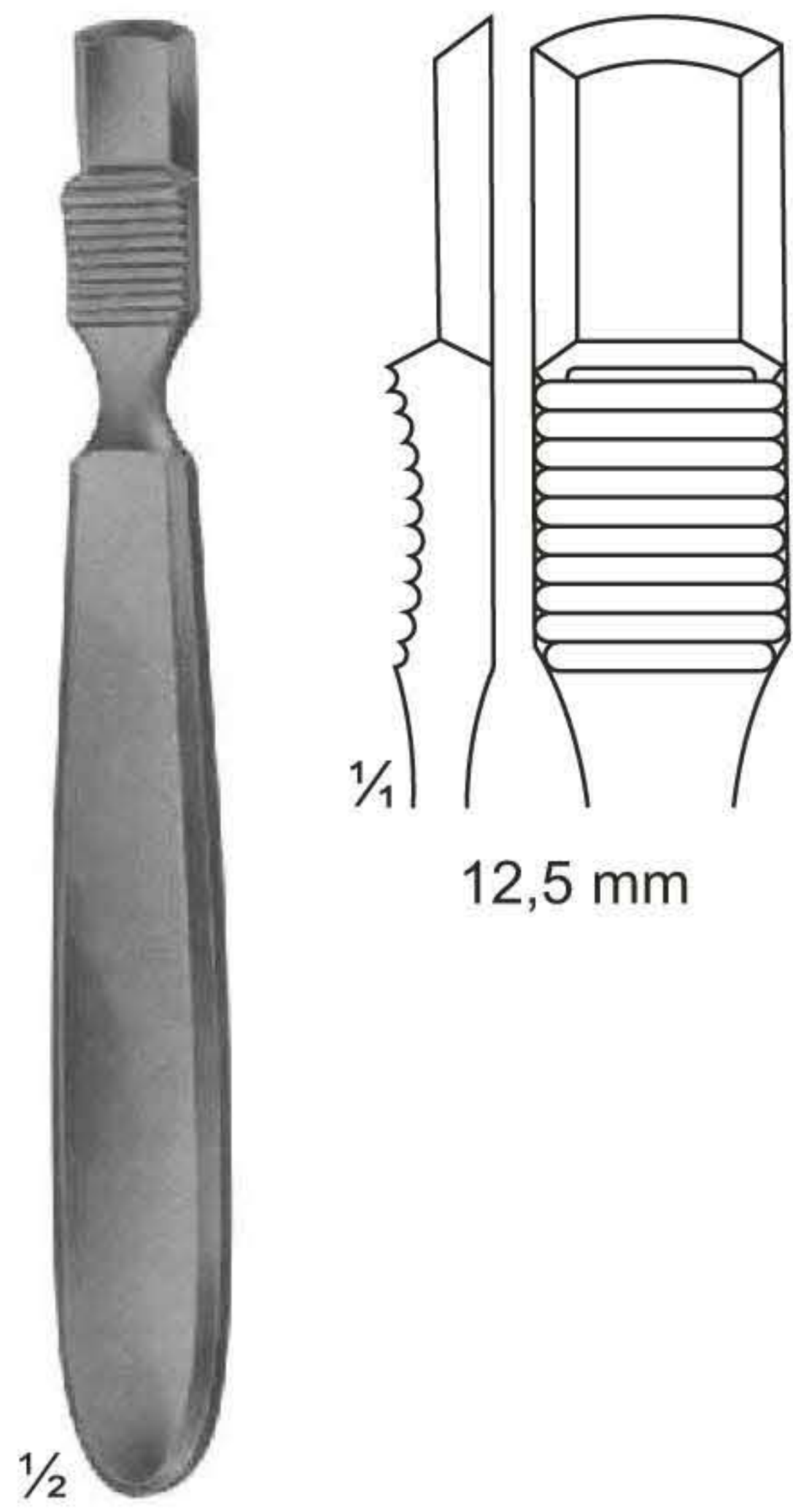

UG-1617
FARABEUF
140 mm

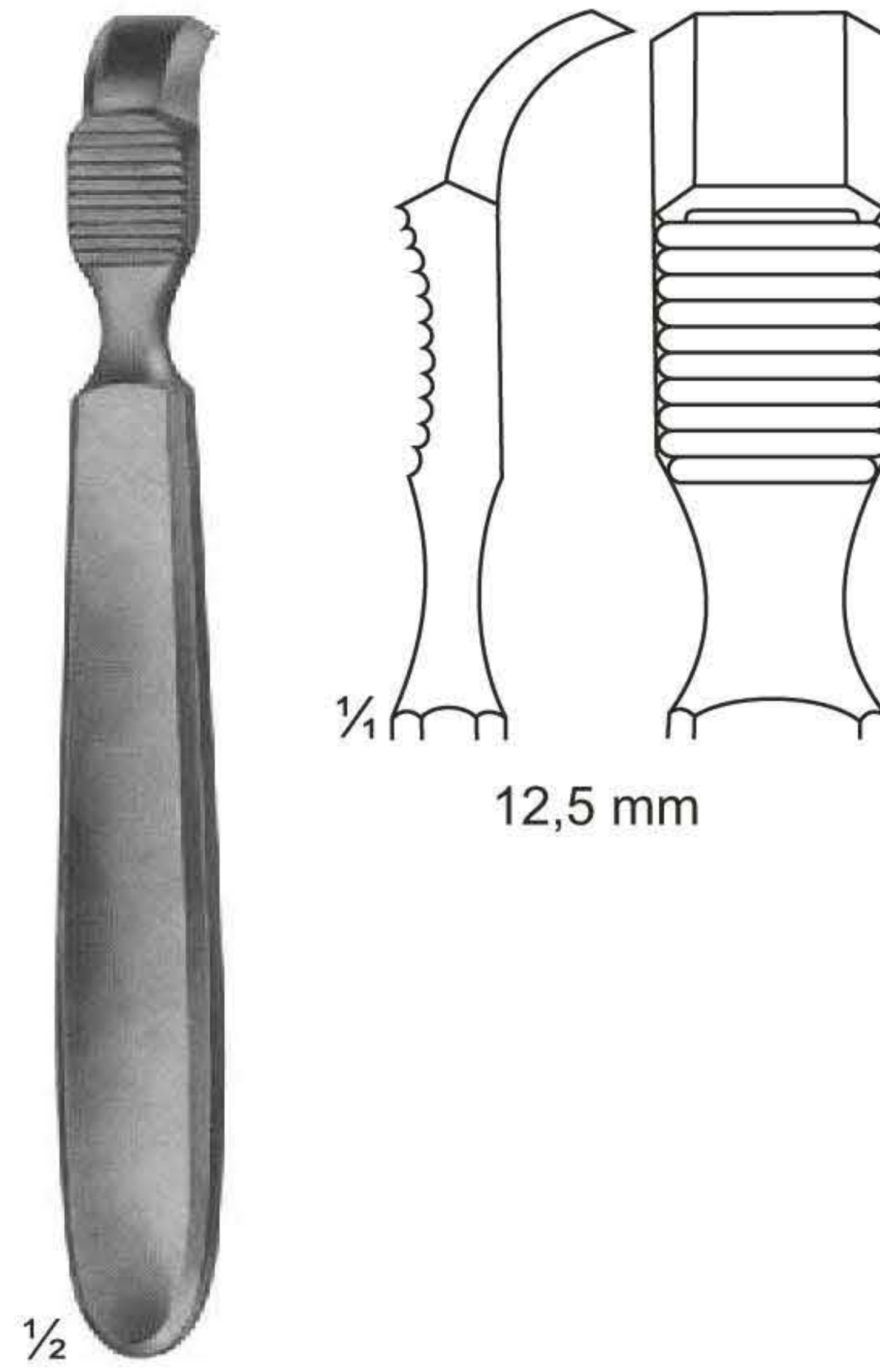

UG-1618
FARABEUF
140 mm

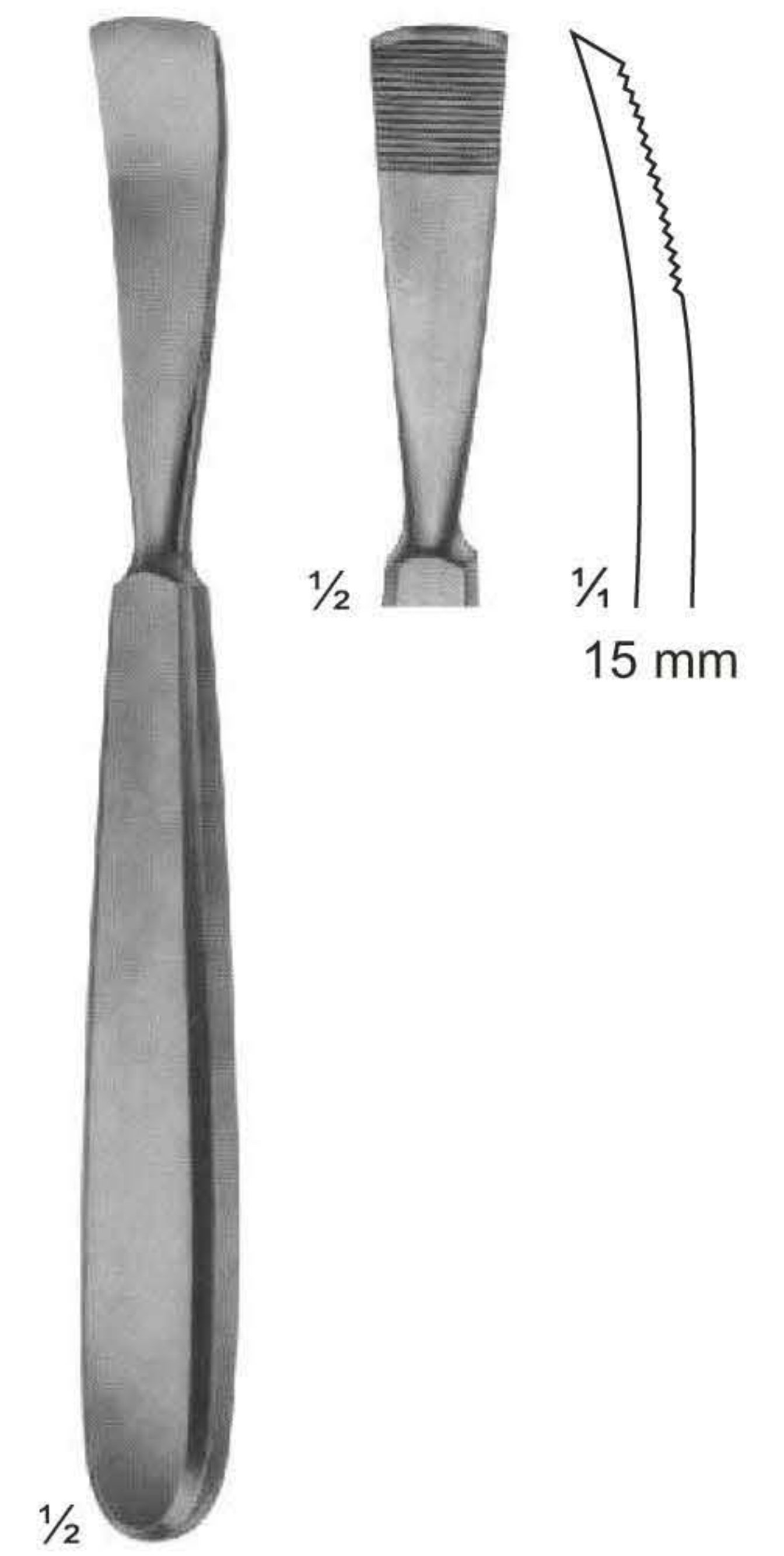

UG-1619
JANSEN
165 mm

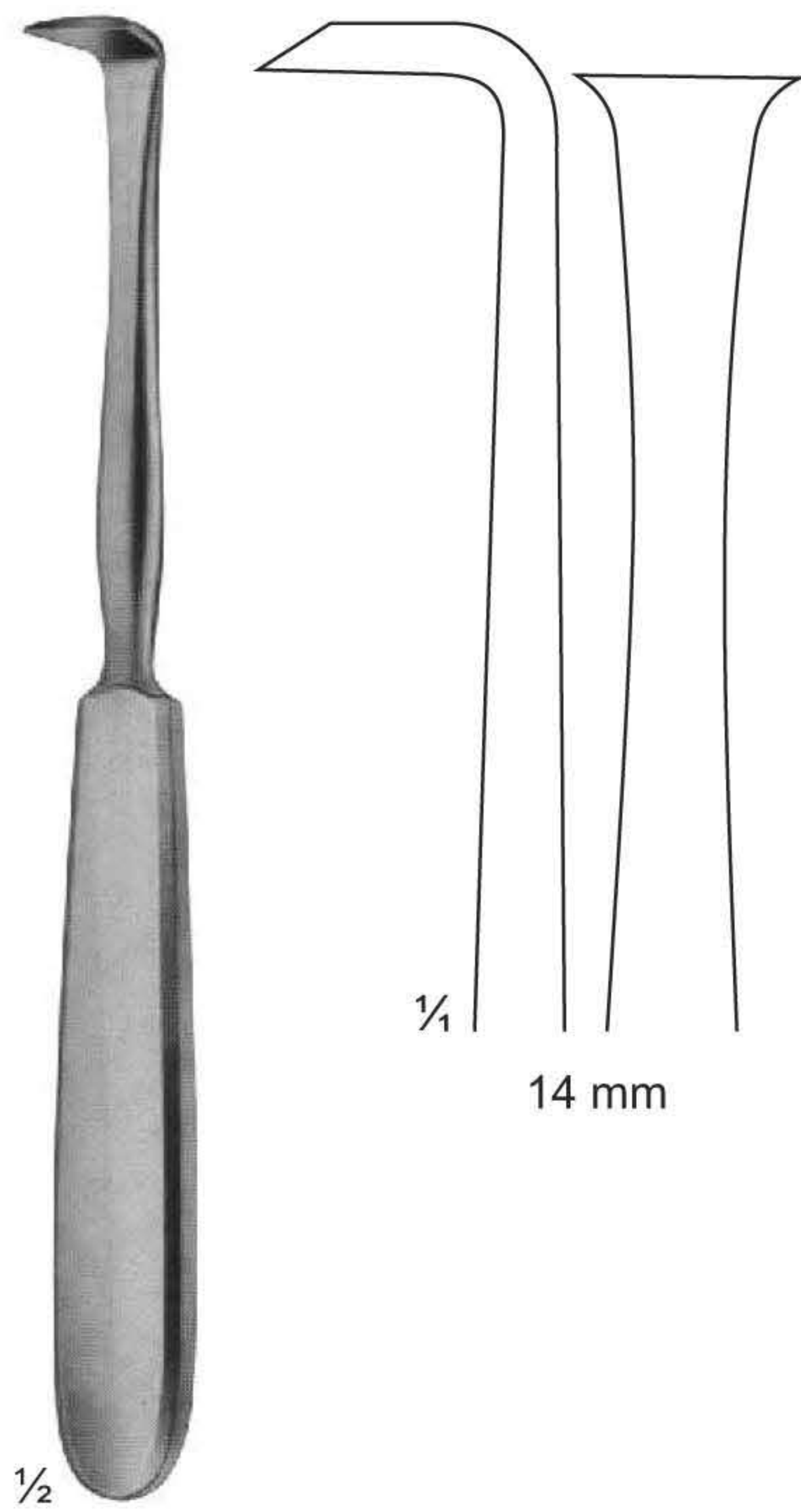

UG-1620
LANGENBACK
180 mm

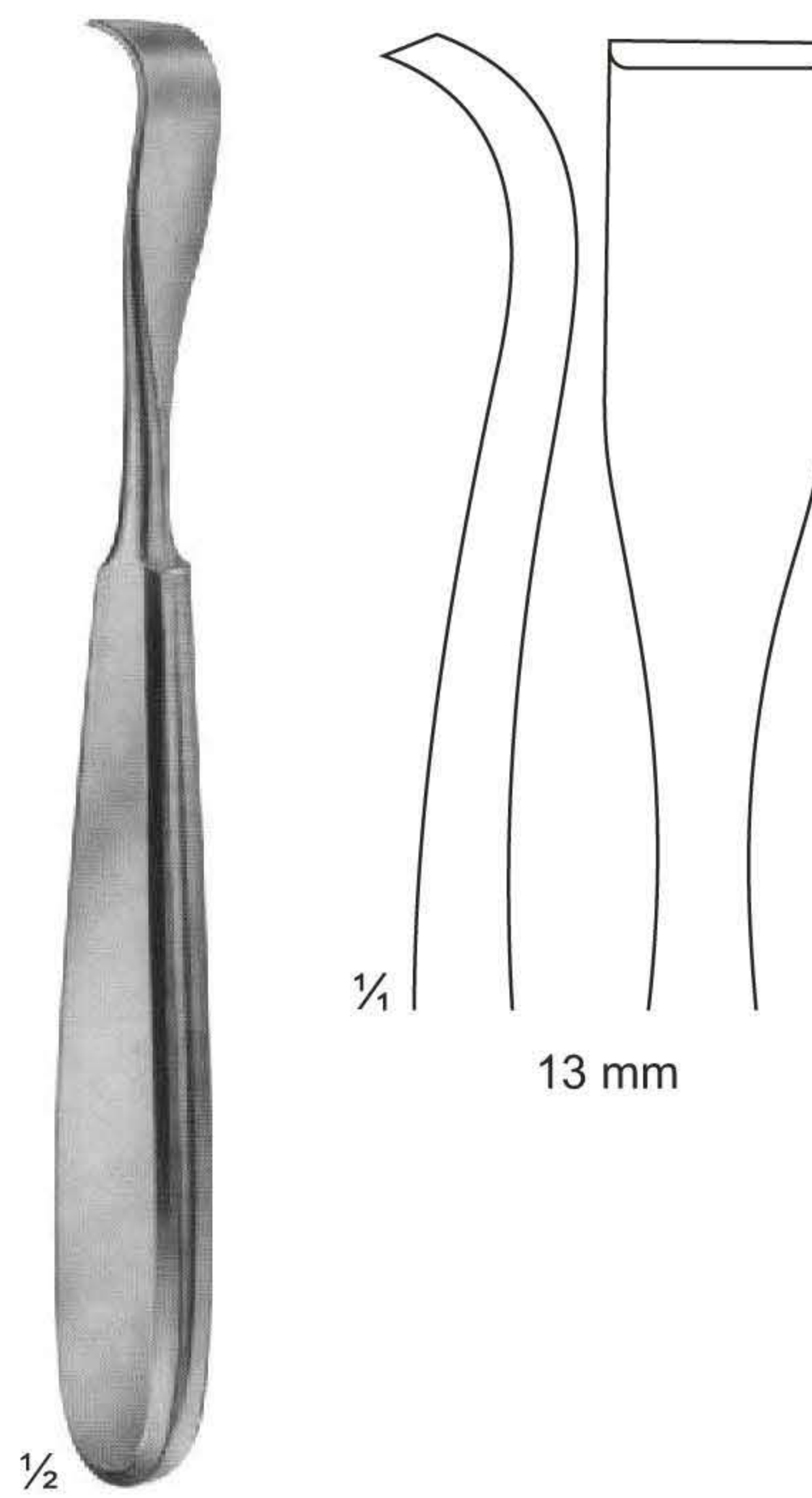

UG-1621
SCHNEIDER
175 mm

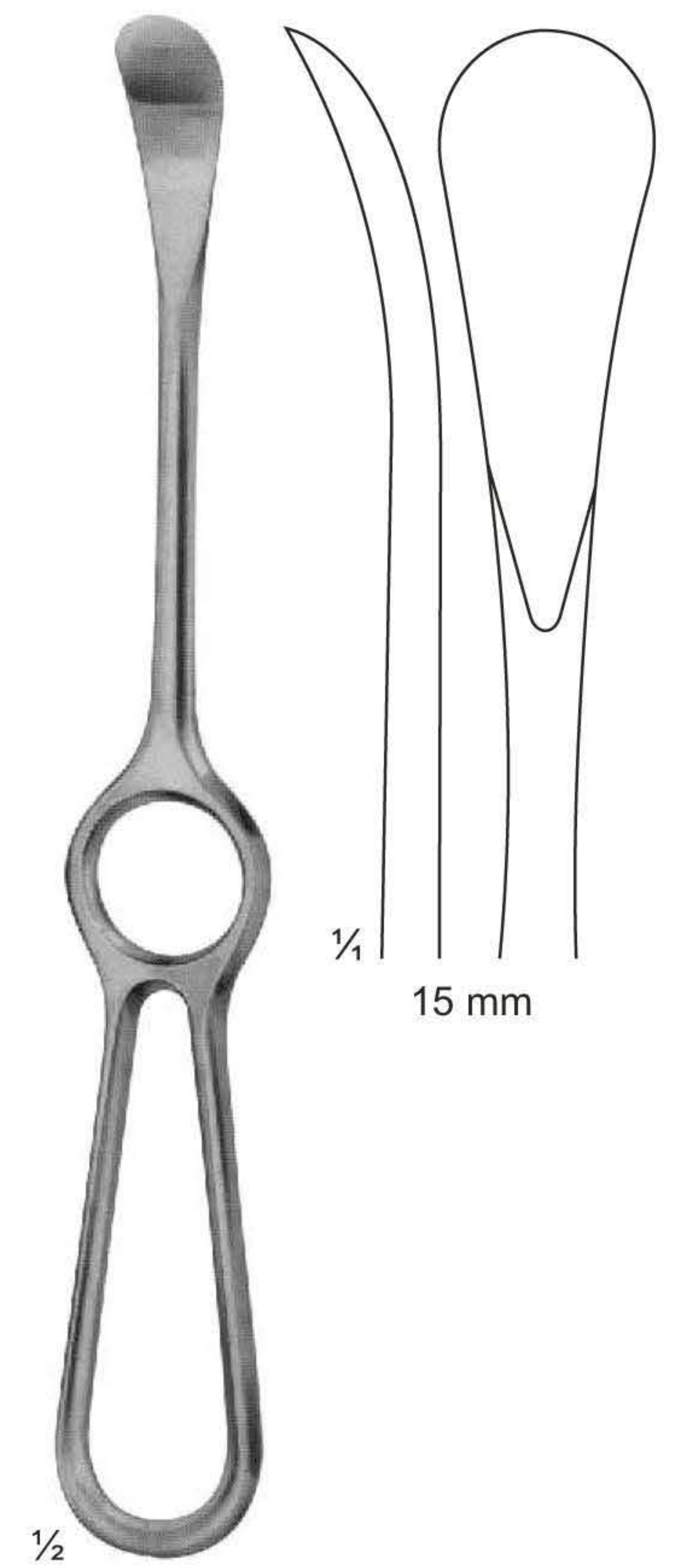

UG-1622
SEDILLOT
215 mm

Raspatories



1/2

UG-1623
SEMB
230 mm



1/2

20-202 - 203
DOYEN
for children
20-204 - 205
for adults
175 mm

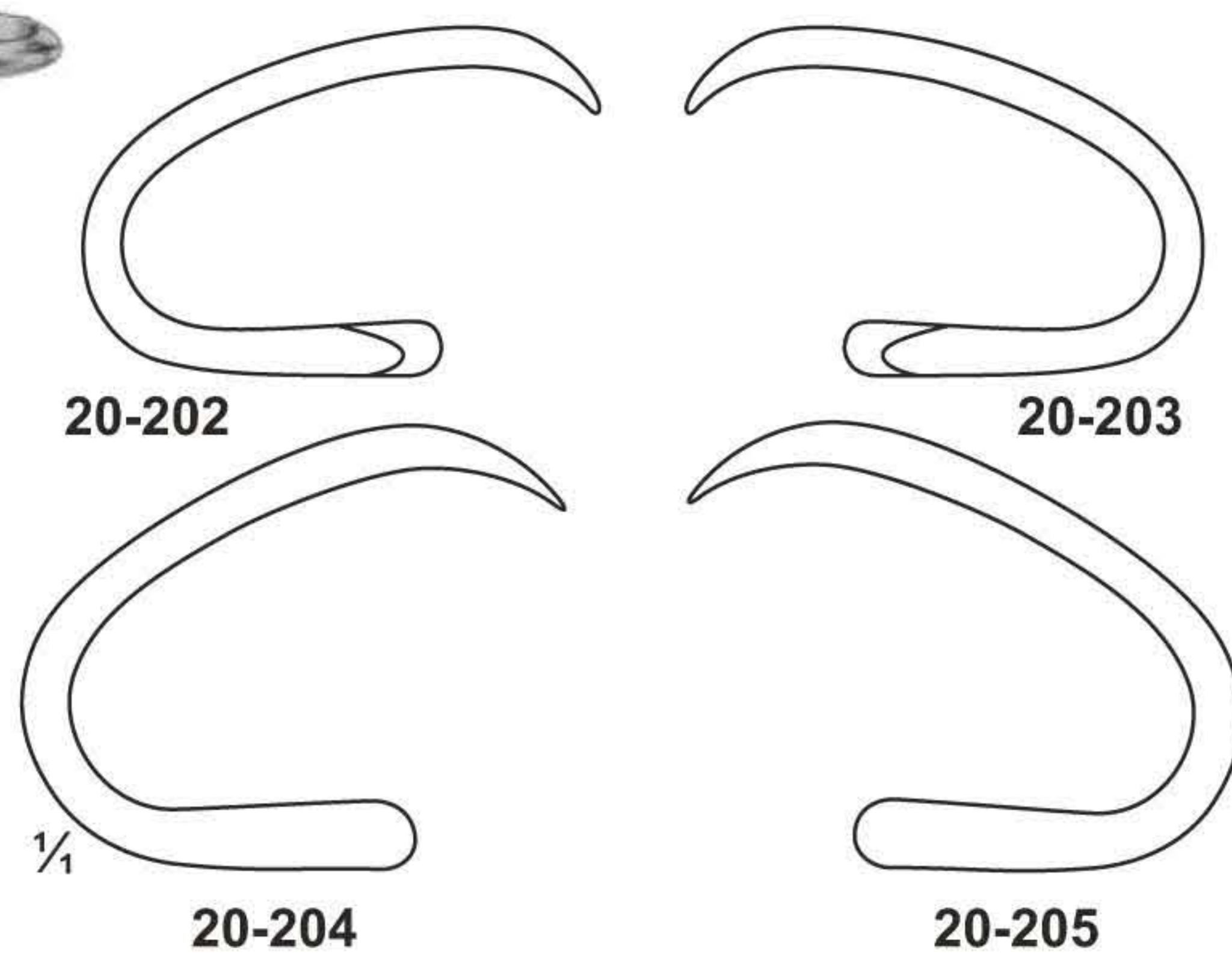

20-202

20-203

1/4

20-204

20-205

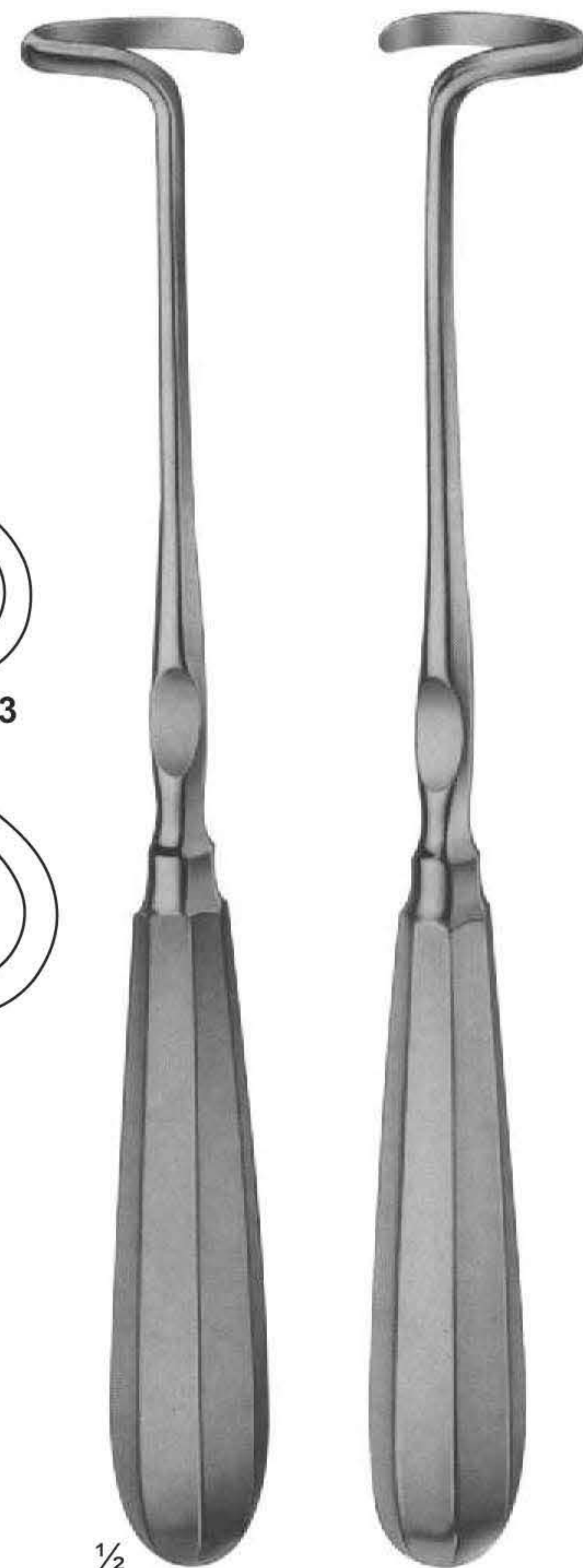

1/2

UG-1626
DOYEN
240 mm

Raspatories with HARTPRESS-handle

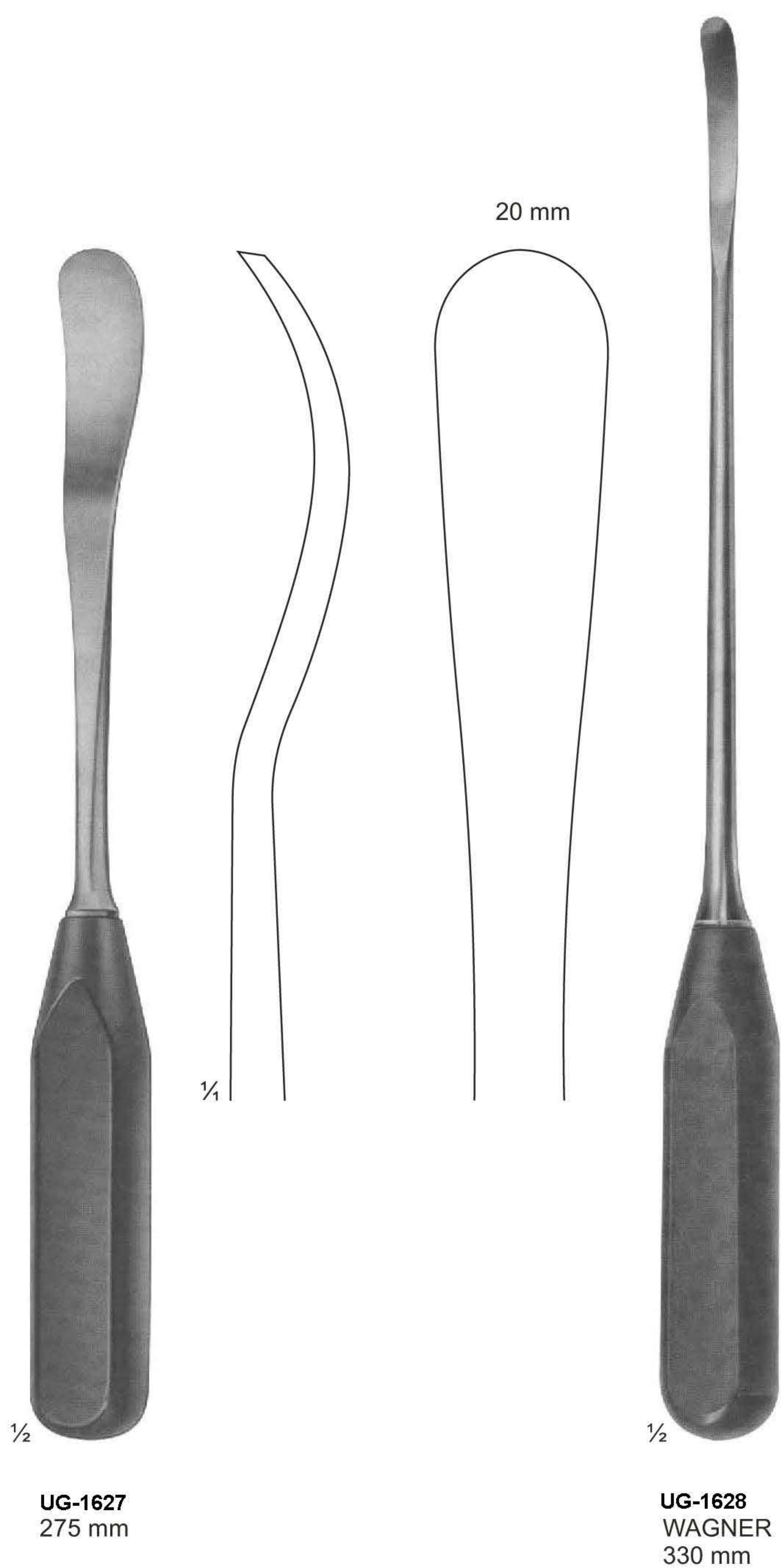

Bone File and Rasps



1/2

UG-1629
JOSEPH
fine, chequered

coarse, chequered
165 mm



1/2

UG-1631
LEWIS
fine, teeth



1/4

9 mm

1/2

UG-1632
MALTZ
down stroke
180 mm



1/2

UG-1633
AUFRICHT
up stroke

down stroke
220 mm

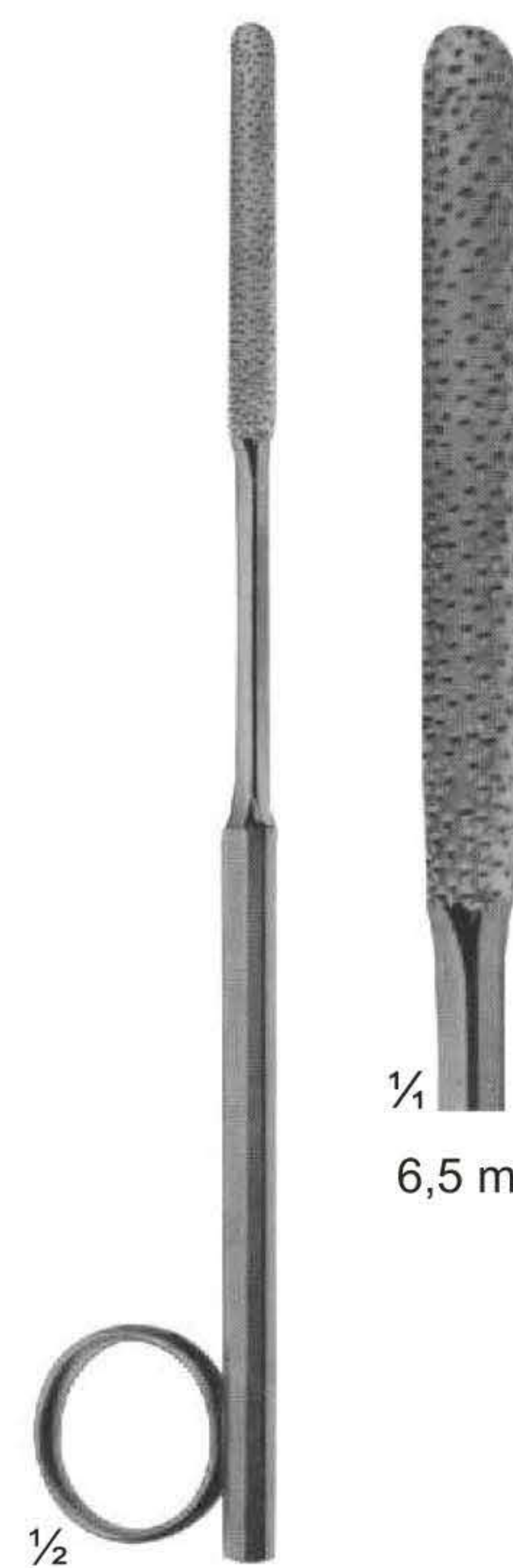

1/4

6,5 mm

1/2

UG-1634
GALLAHER
190 mm

Bone File and Rasps

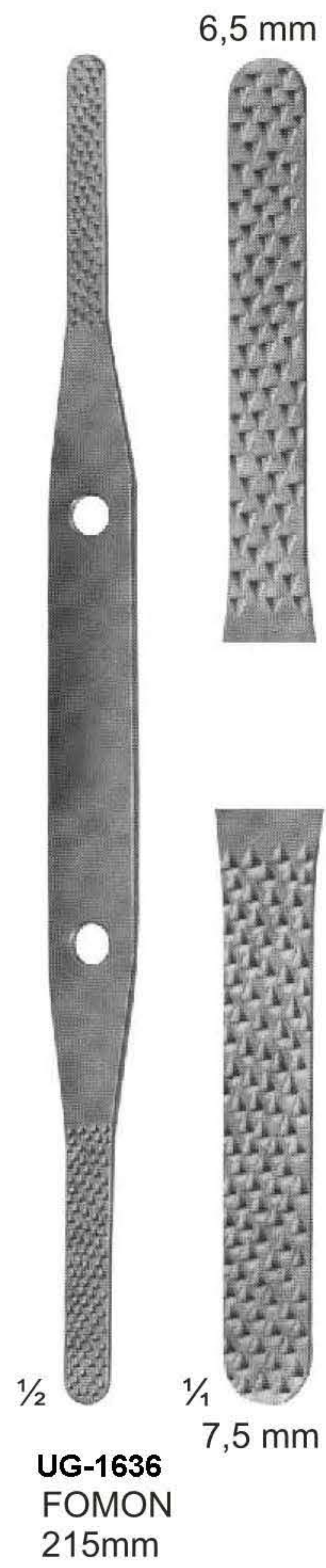
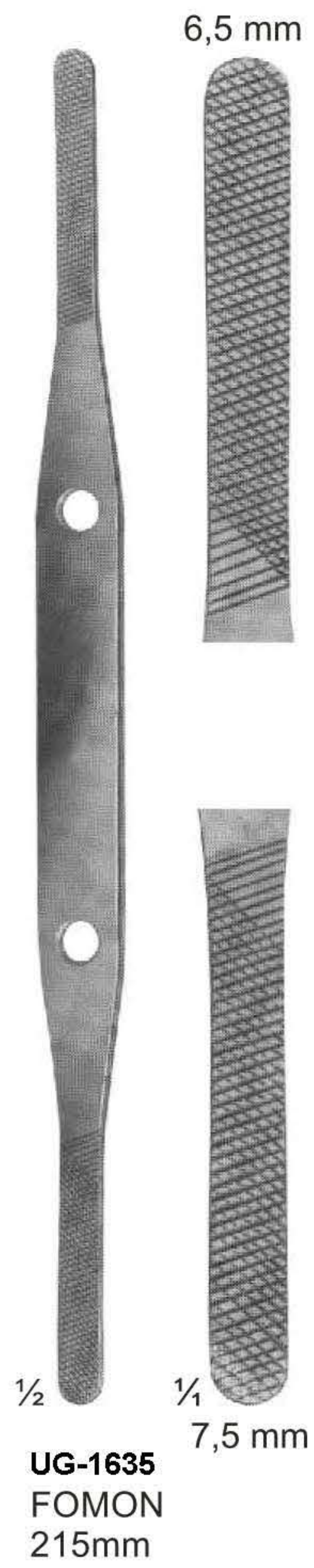

Bone File and Rasps

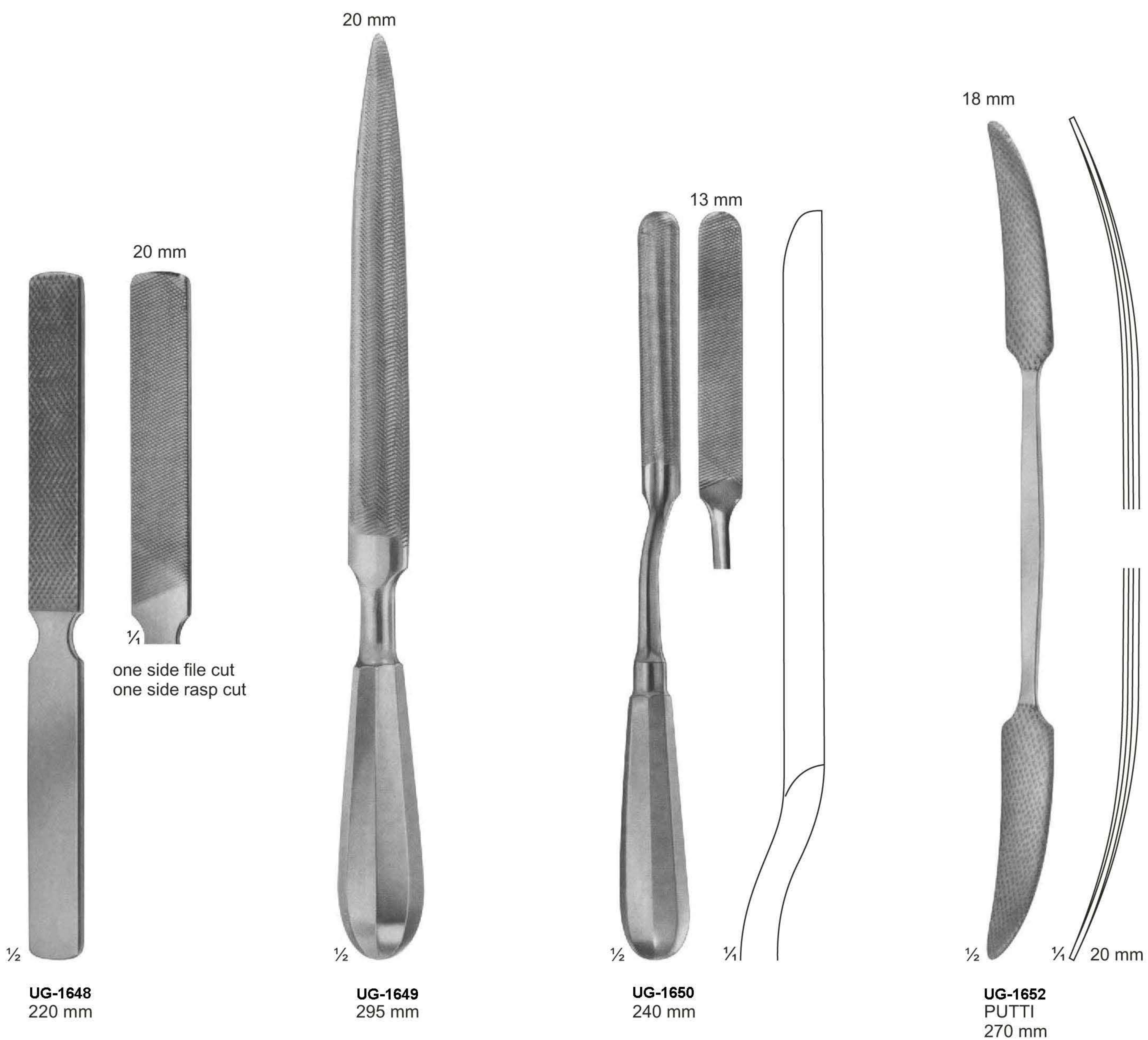

Bone Curettes

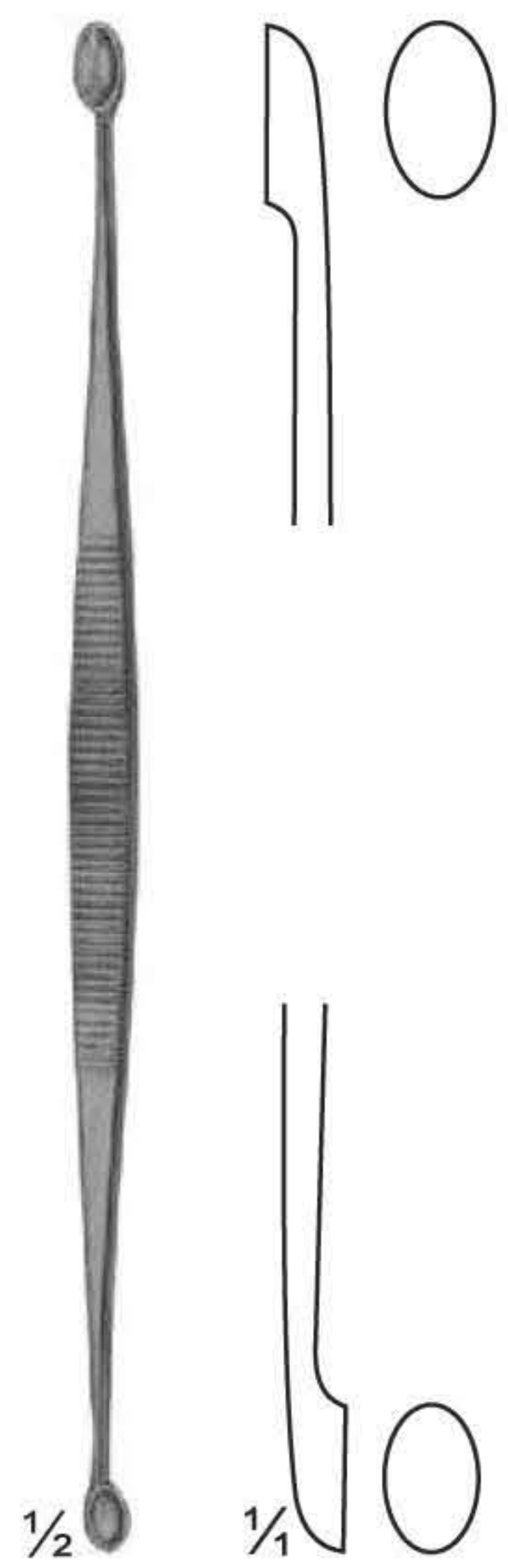

UG-1653
JACOBSON
140 mm

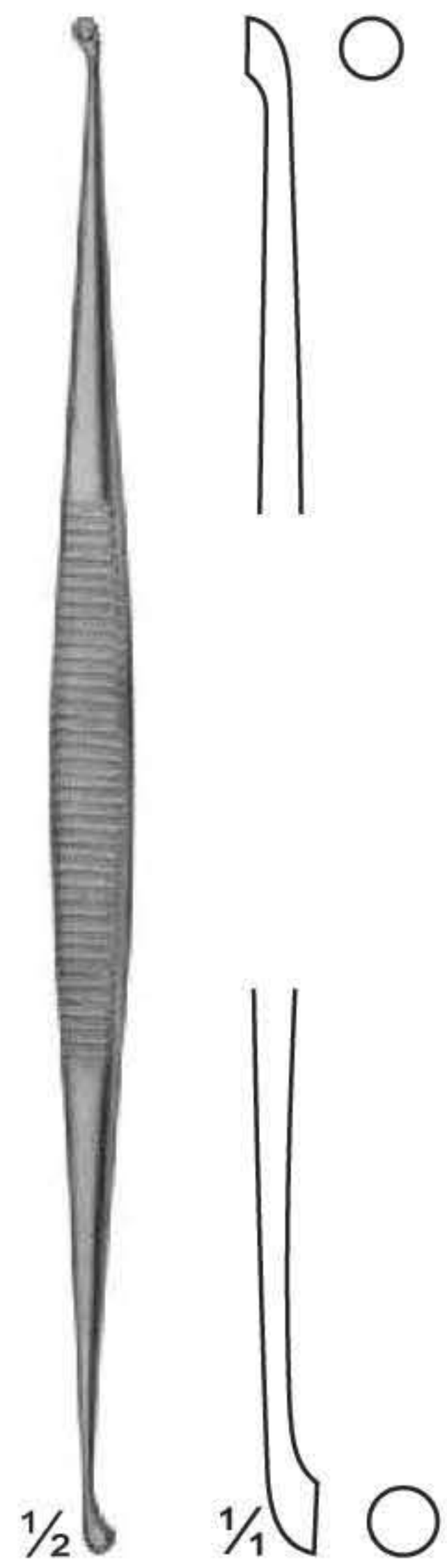

UG-1654
MARTINI
140 mm

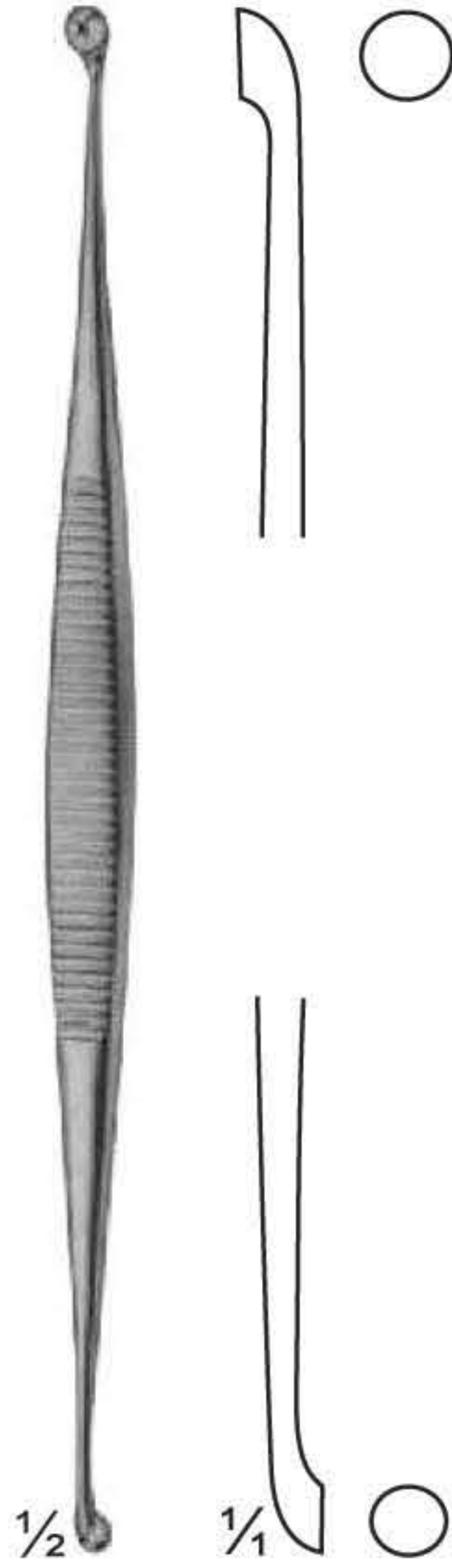

UG-1655
MARTINI
140 mm



UG-1657
WILLIGER
145 mm



UG-1658
JANSEN
160 mm



UG-1659
BARTH
180 mm

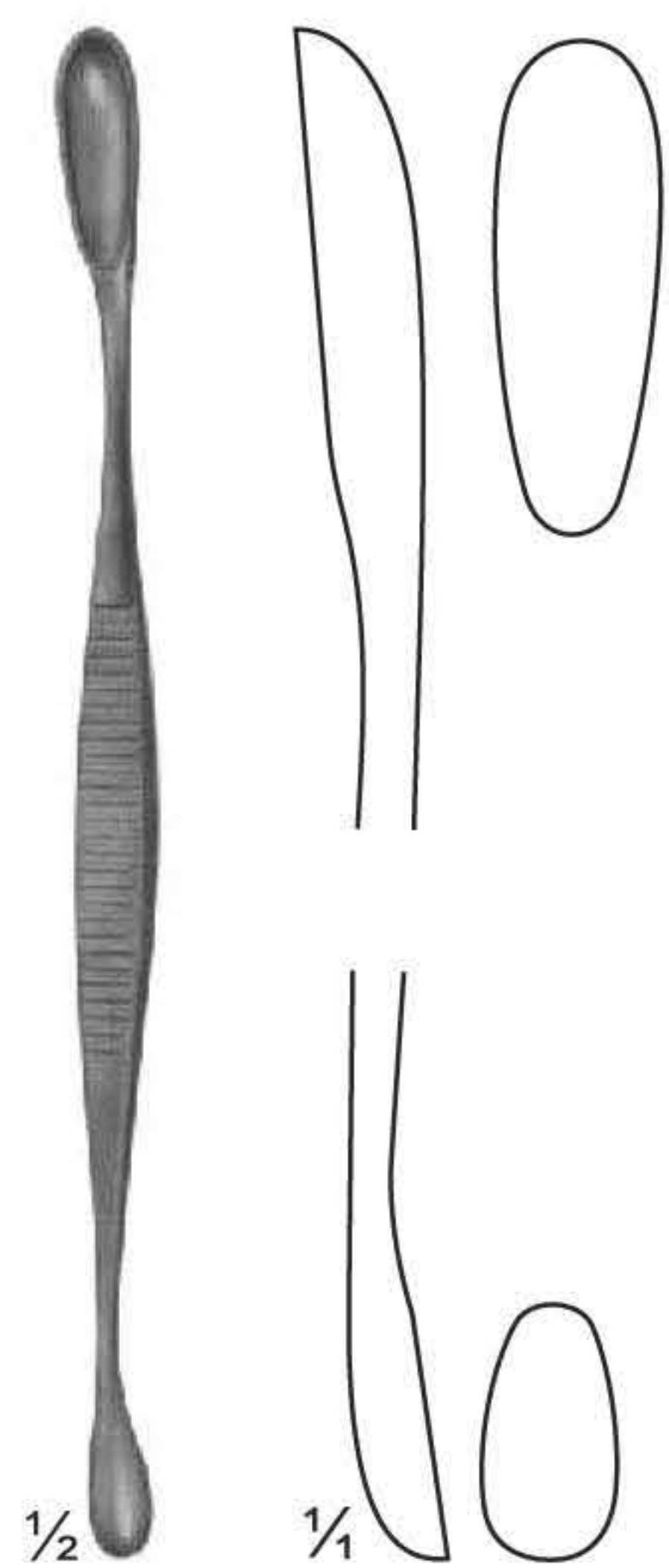

UG-1660
VOLKMANN
130 mm

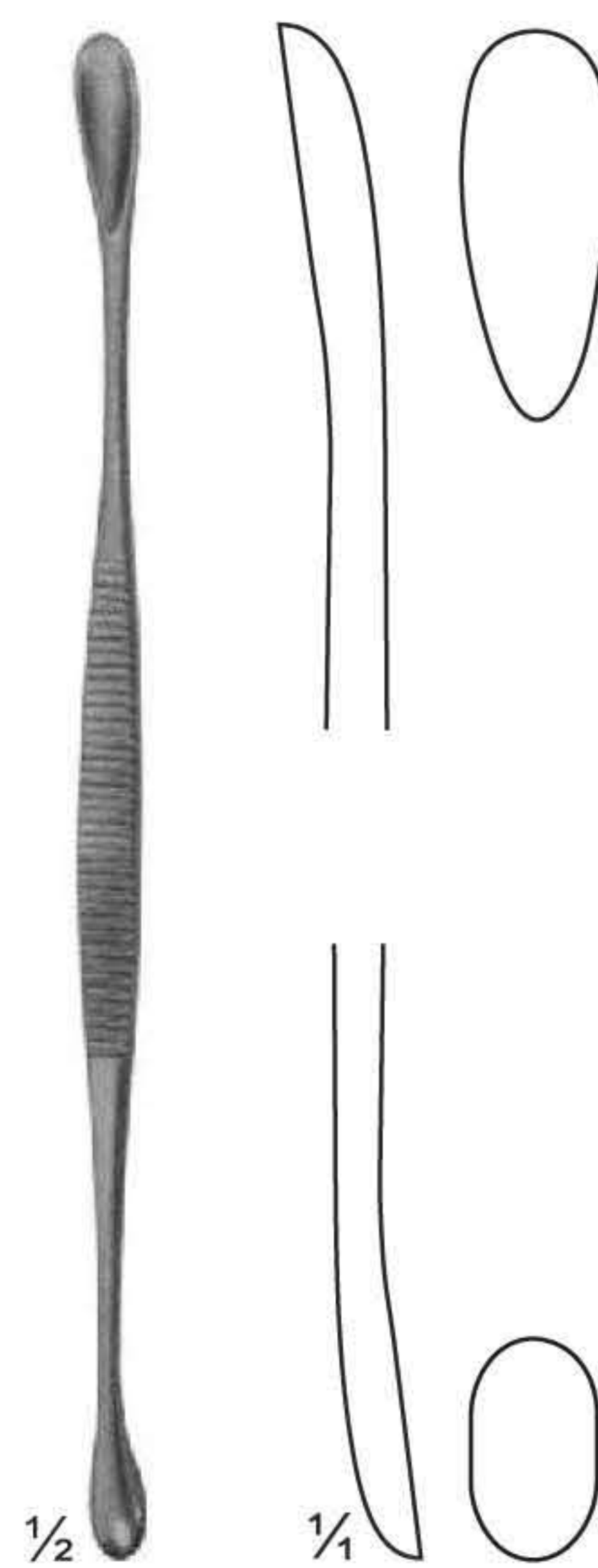

UG-1662
VOLKMANN
145 mm

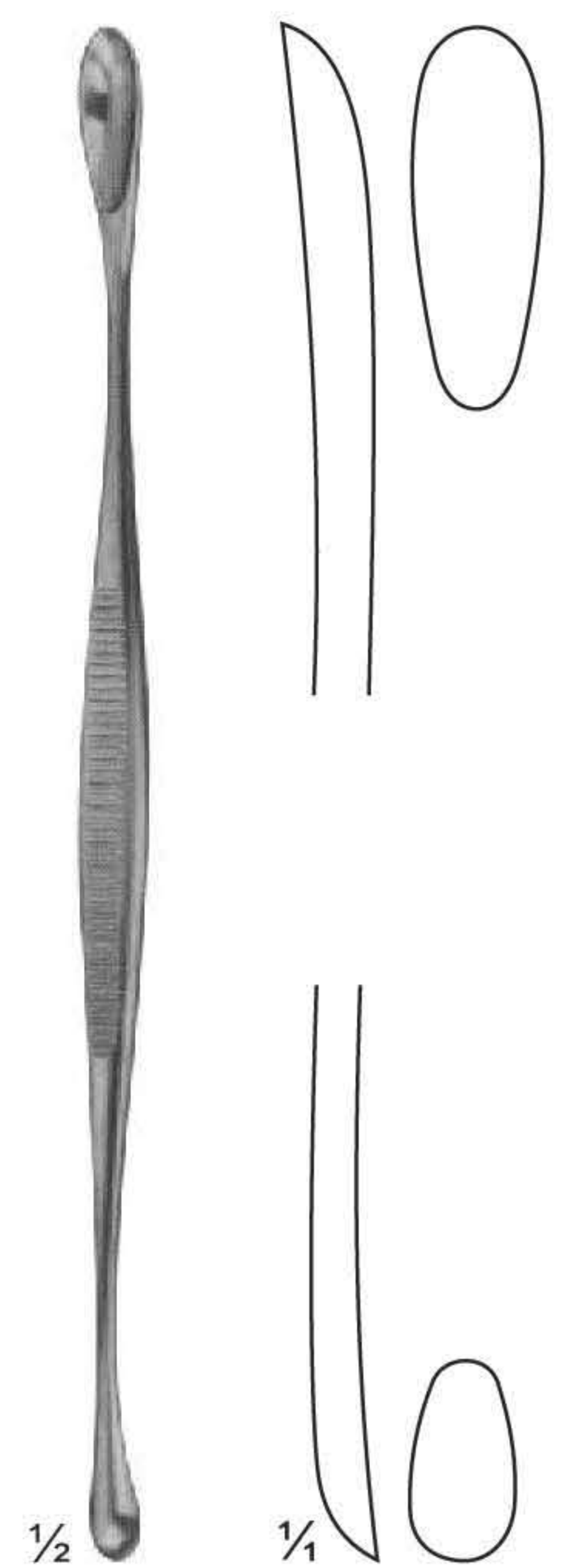

VOLKMANN
170 mm

Bone Curettes



UG-1665
JANSEN
160 mm

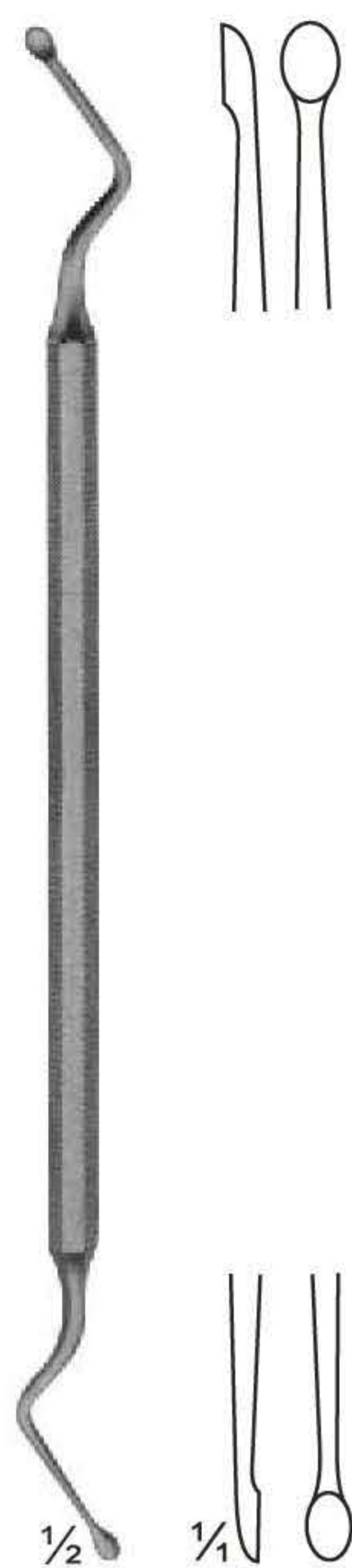

UG-1666
HEMINGWAY
170 mm

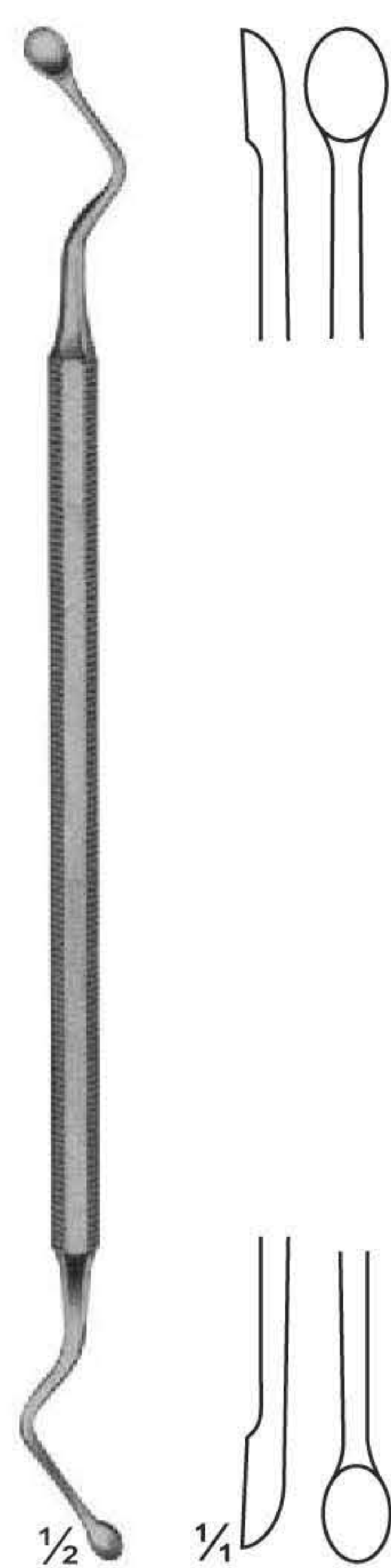

UG-1668
HEMINGWAY
175 mm

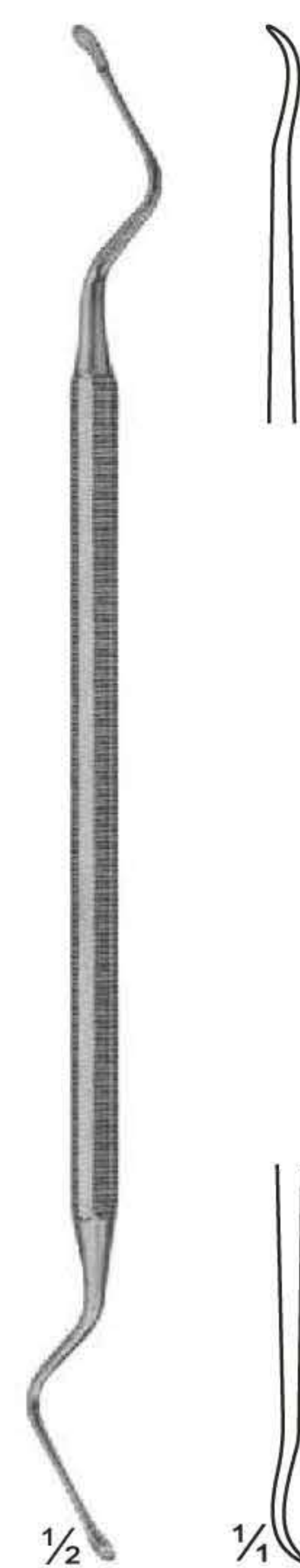

UG-1672
LUCAS
180 mm

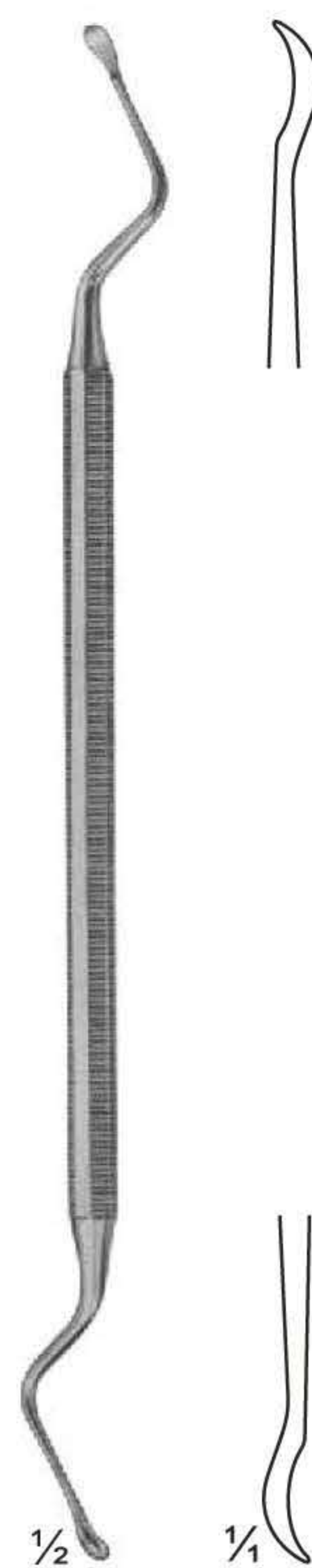

UG-1673
LUCAS
185 mm



UG-1674
KERPEL
145 mm



UG-1677
KERPEL
145 mm

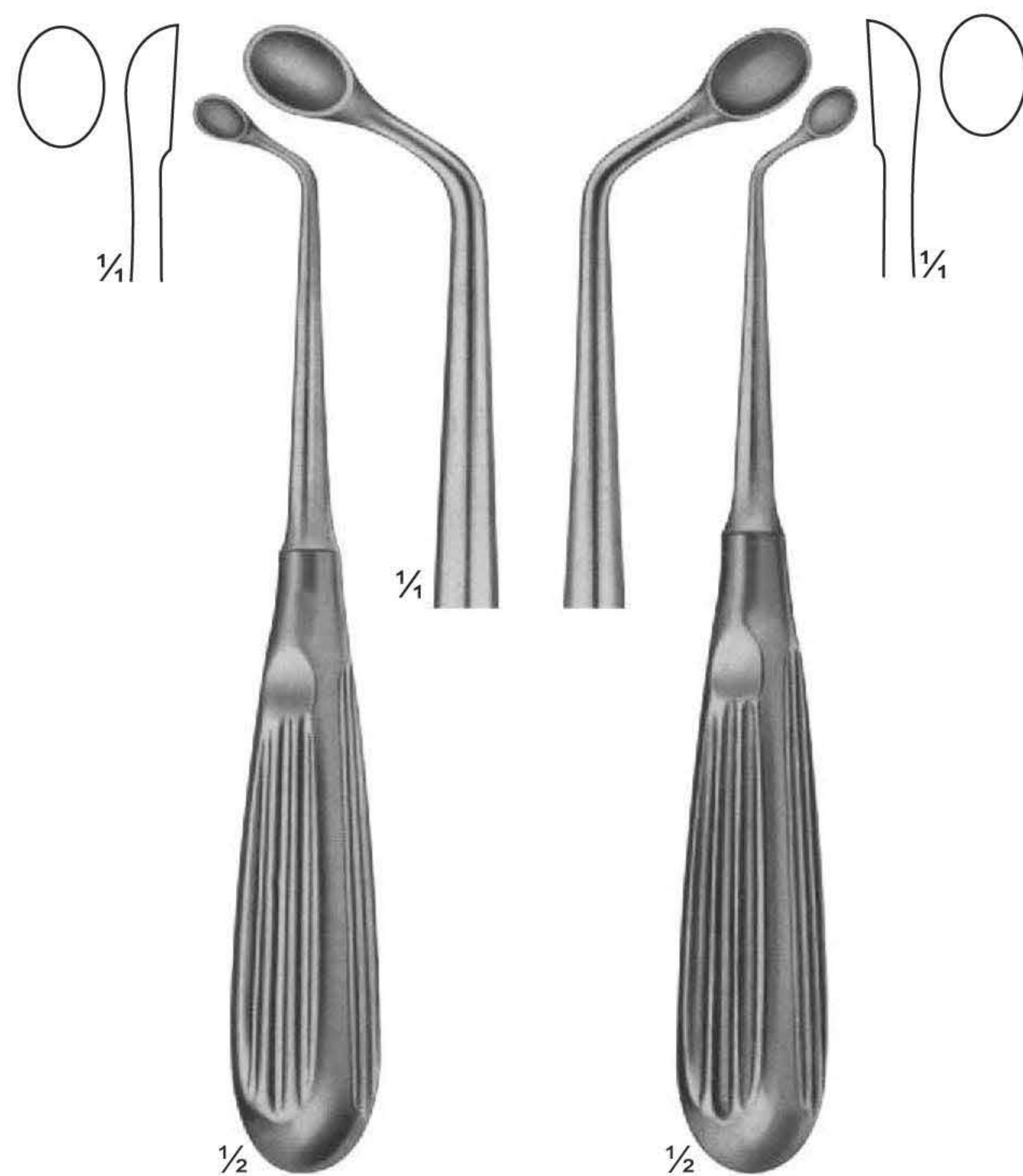

UG-1678
UFFENORDE
170 mm

UG-1679
UFFENORDE
170 mm

Bone Curettes



UG-1681
BRUNS
165 mm



UG-1683
SCHEIDE
170 mm



UG-1685
VOLKMANN
170 mm



UG-1690
WILLIGER
170 mm

Bone Currettes



1/2

UG-1692
LEMPERT
215 mm



1/2

UG-1695
HALLE
215 mm



1/2

UG-1697
DAUBENSPECK
200 mm



1/2

UG-1700
250 mm



1/2

UG-1705
250 mm



1/2

UG-1710
BUSHE
250 mm

Bone Curettes

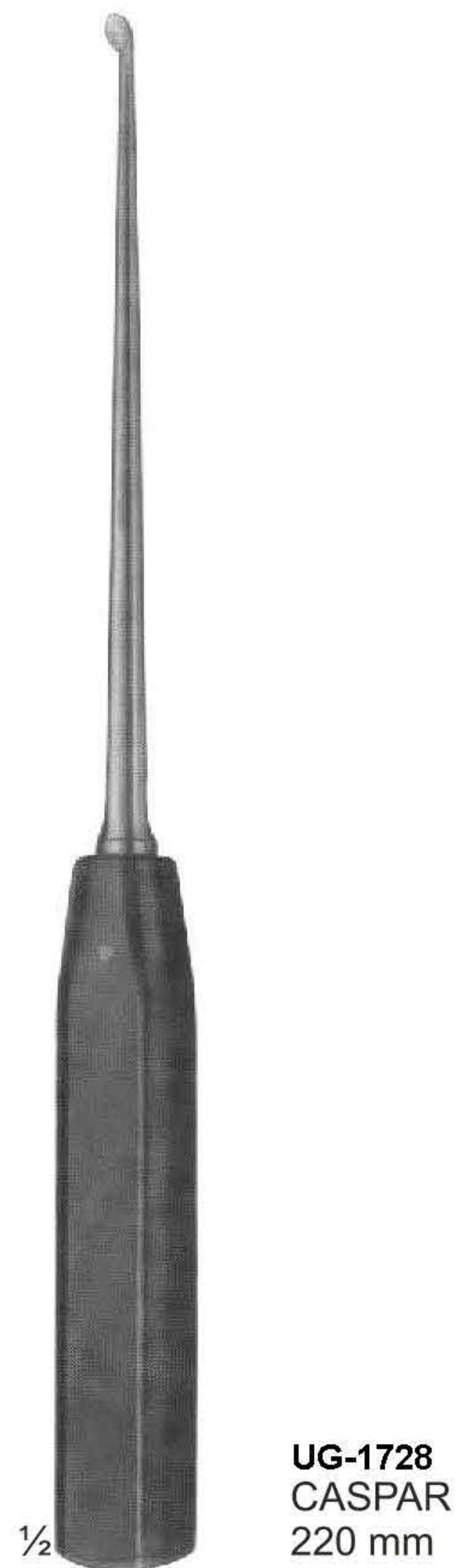
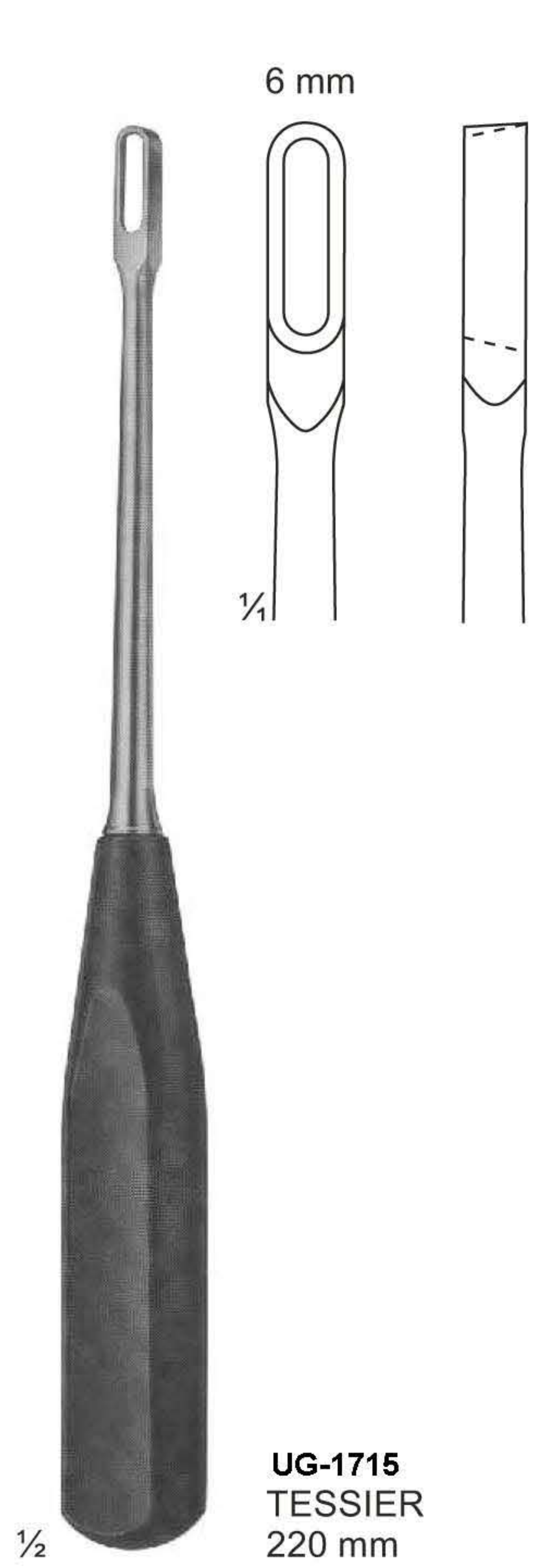

Bone Currettes



1/2

UG-1731
270 mm



1/2

UG-1733
SYPERT
380 mm

Mallets



UG-1603
MEAD
185 g
with interchangeable
plastic disks
190 mm
pair of spare disks



UG-1604
140 g
with interchangeable
plastic disks
185 mm
pair of spare disks



UG-1605
COTTLE
140 g
1 Seite convex
1 Side convex
185 mm



UG-1606
165 g
lead filled head
190 mm

Mallets



UG-1637
HAJEK
140 g
215 mm



UG-1639
215 g
with interchangeable
plastic disks
245 mm

pair of spare disks



UG-1640
WAGNER
complete with:
1 pair of metal disks and
1 pair of plastic disks and
1 wrench 566
235 mm

Mallets



UG-1642
BERGMANN
245 mm



UG-1643
BERGMANN
235 mm



UG-1644
OMBREDANNE
240 mm

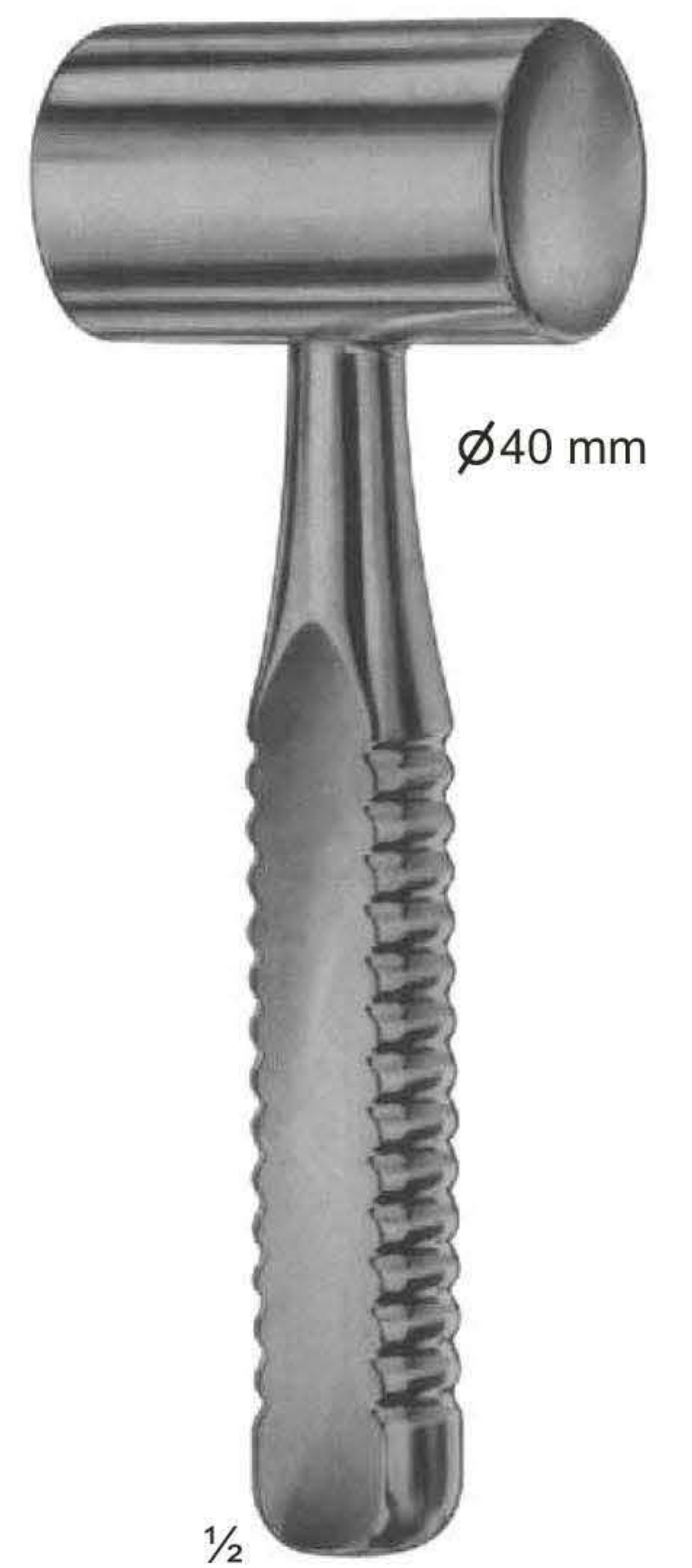

UG-1645
HEATH
copper filled head
700 g
185 mm

Tampers - Osteotomes, Chisels and Gouges

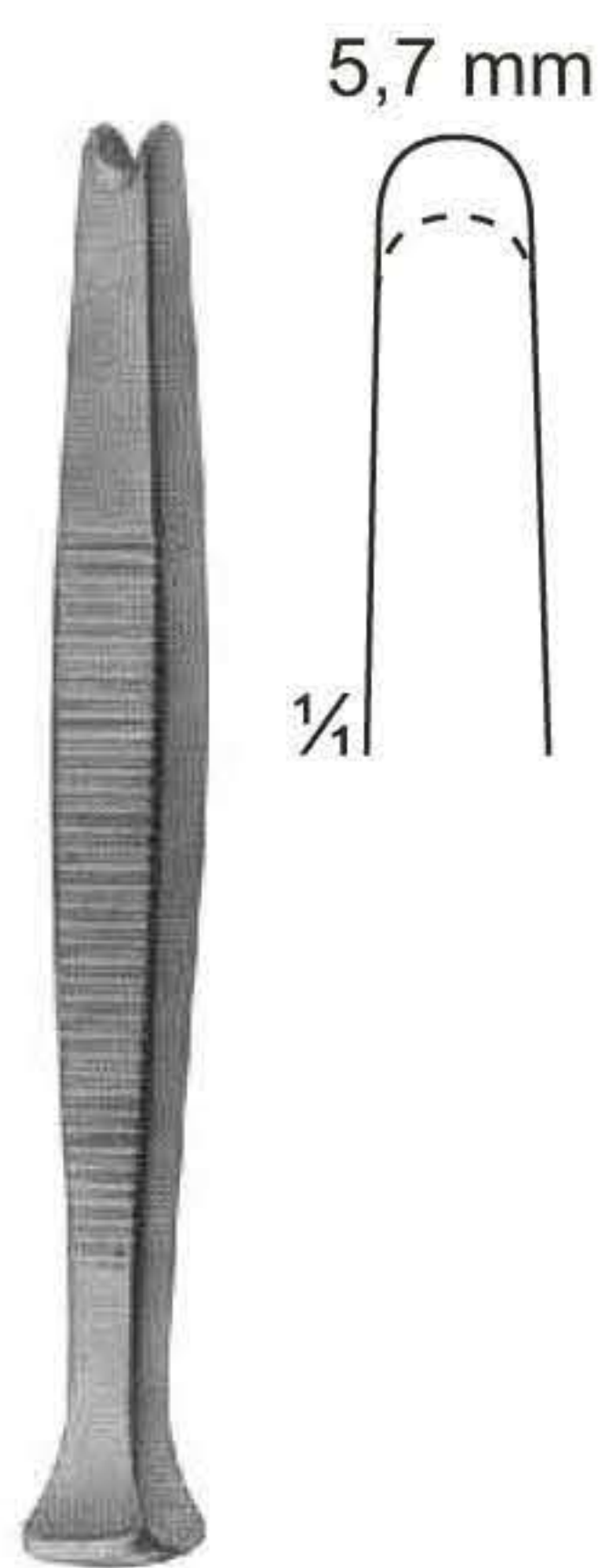

UG-1646
Haase
100 mm

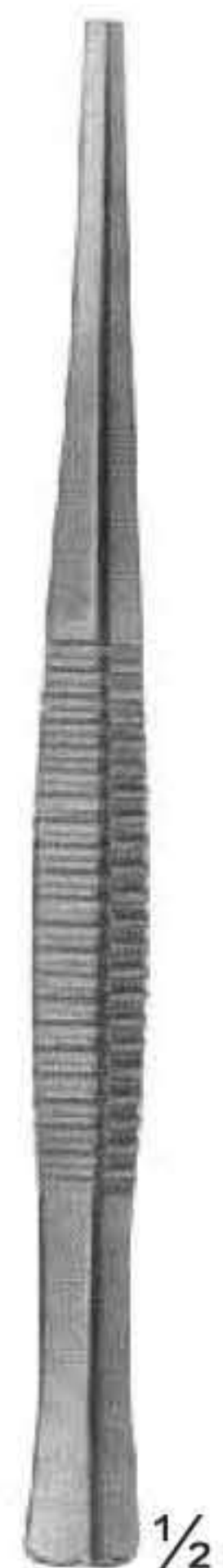

UG-1647
PASSOW
120 mm



UG-1651
CASPER
200 mm



UG-1656
200 mm

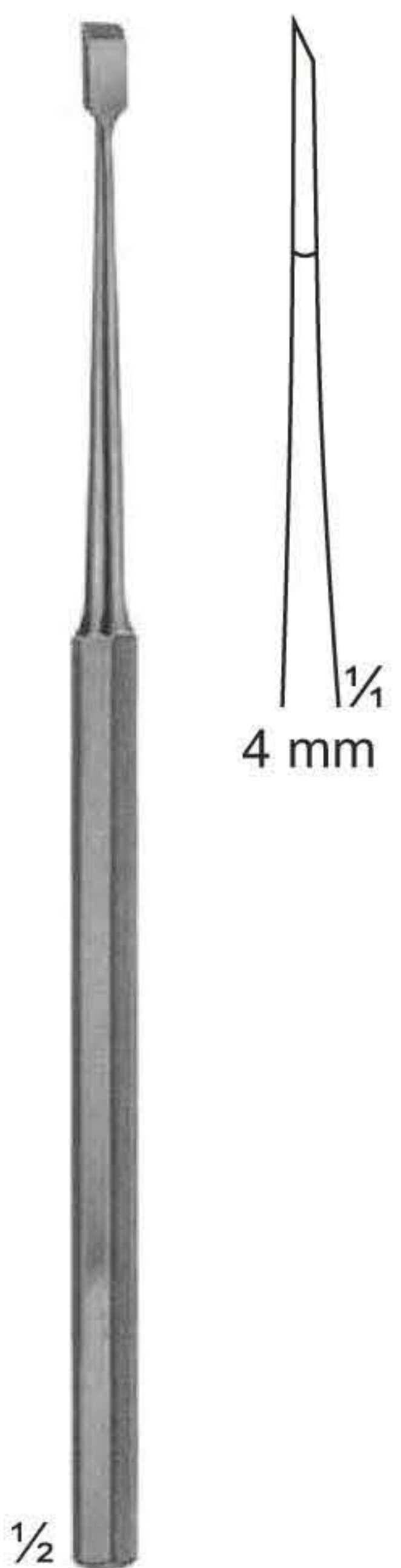

UG-1661
FREER
Chisel
160 mm

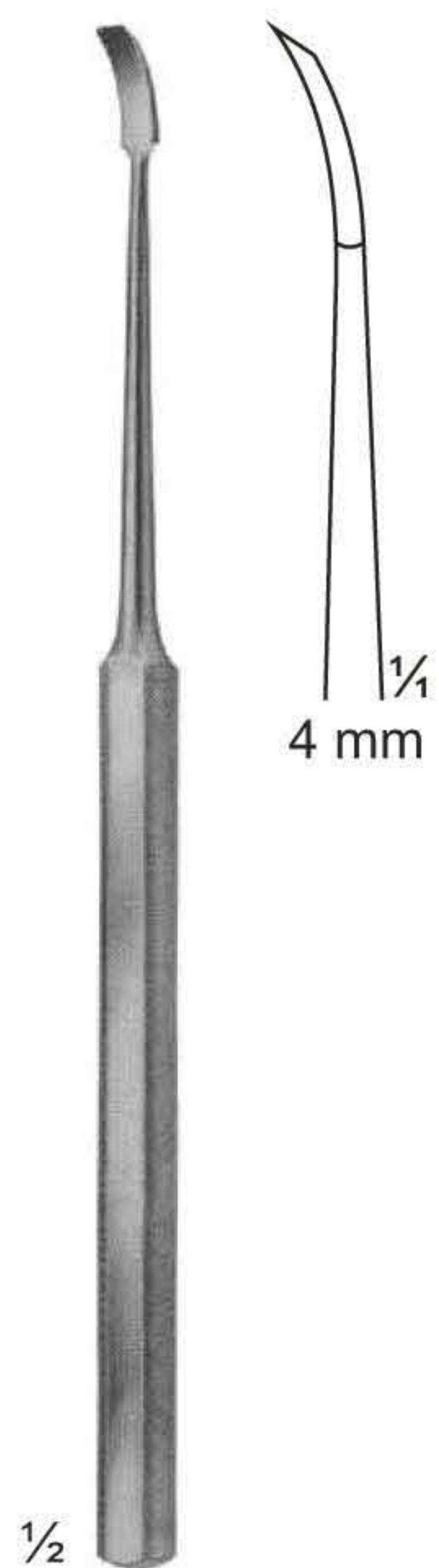

UG-1664
FREER
Chisel, curved
160 mm

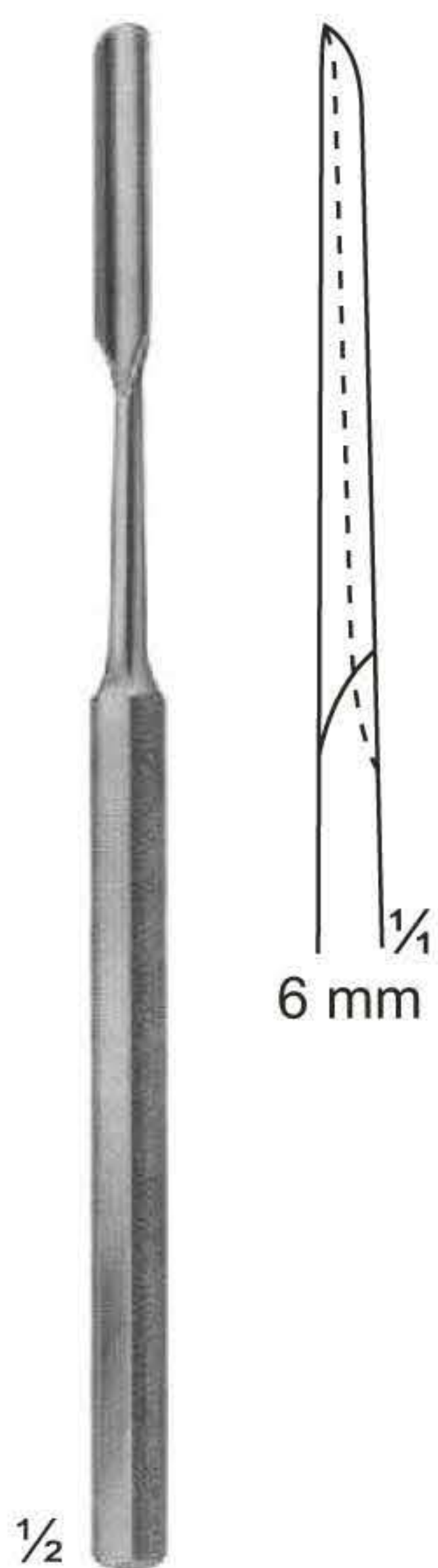

UG-1667
FREER
Gouge
150 mm

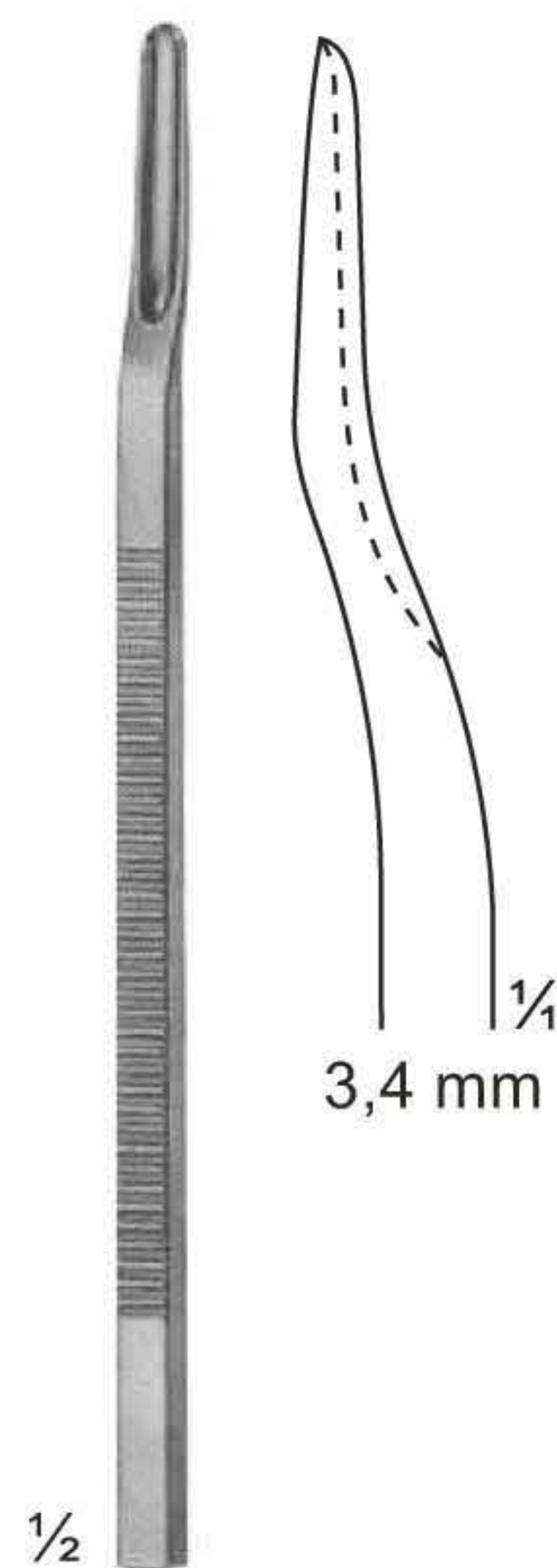

UG-1669
Scaphoid gouge,
downwards curved
135 mm

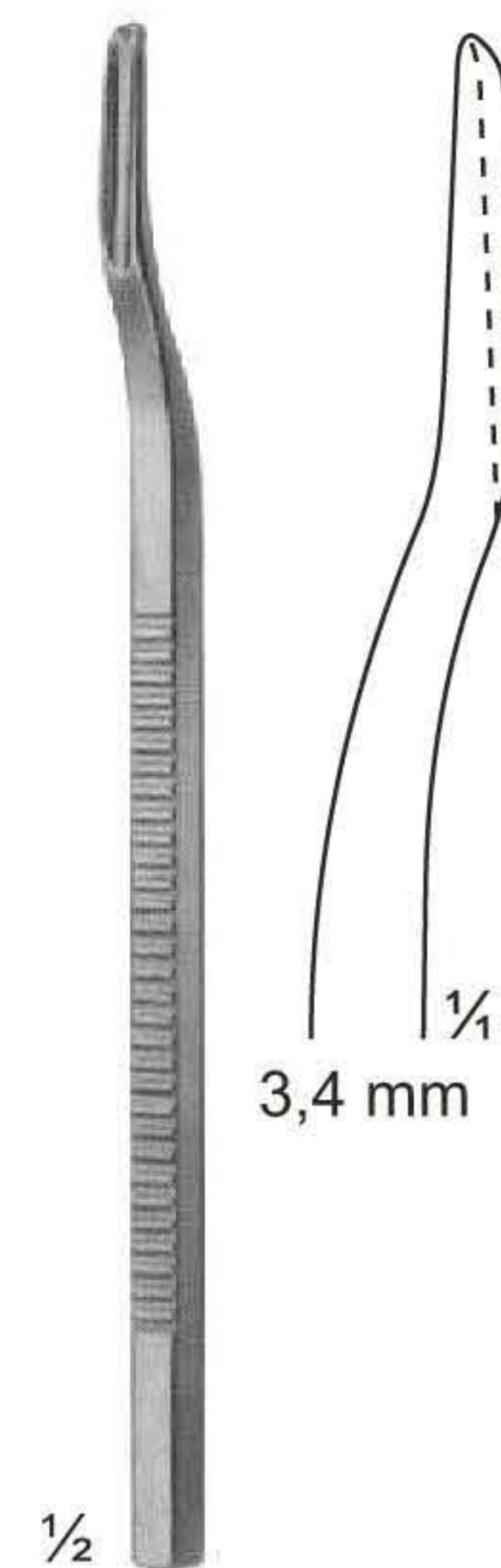

UG-1670
Scaphoid gouge,
upwards curved
135 mm



UG-1671
Mannerfelt
21-131A 4 mm
21-132 6 mm
21-133 8 mm
155 mm

Osteotomes Chisels and Gouges



1/2
UG-1675
Mannerfelt
155 mm



1/2
UG-1676
Osteotome
140 mm



1/2
UG-1680
Chisels
140 mm



1/2
UG-1682
Gouges
140 mm



1/2
PARTSCH
UG-1684
Chisels
140 mm



1/2
PARTSCH
UG-1686
Chisels
170 mm



1/2
PARTSCH
UG-1689
Gouges
140 mm



1/2
PARTSCH
UG-1691
Gouges
170 mm



1/2
LUCAS
UG-1693
Chisels
140 mm



1/2
LUCAS
UG-1694
Gouges
160 mm

Osteotomes Chisels and Gouges



$\frac{1}{2}$
ALEXANDER
UG-1696
Gouges
170 mm



$\frac{1}{2}$
LAMBOTTE
UG-1699
Osteotome
125 mm



$\frac{1}{2}$
COTTLE
UG-1702
Osteotome with depth
markings
180 mm



$\frac{1}{2}$
COTTLE
UG-1708
Chisel-Osteotomes
with depth markings
180 mm



$\frac{1}{2}$
COTTLE
UG-1712
Fishtail Chisel,
with protected ends
180 mm



$\frac{1}{2}$
STILLE
UG-1713
Chisels
205 mm



$\frac{1}{2}$
STILLE
UG-1718
Gouges
205 mm



$\frac{1}{2}$
WALTER
UG-1724
Osteotomes
gouges for taking
grafts from the rib
205 mm



$\frac{1}{2}$
STILLE
UG-UG-1725
Osteotomes
205 mm

Osteotomes

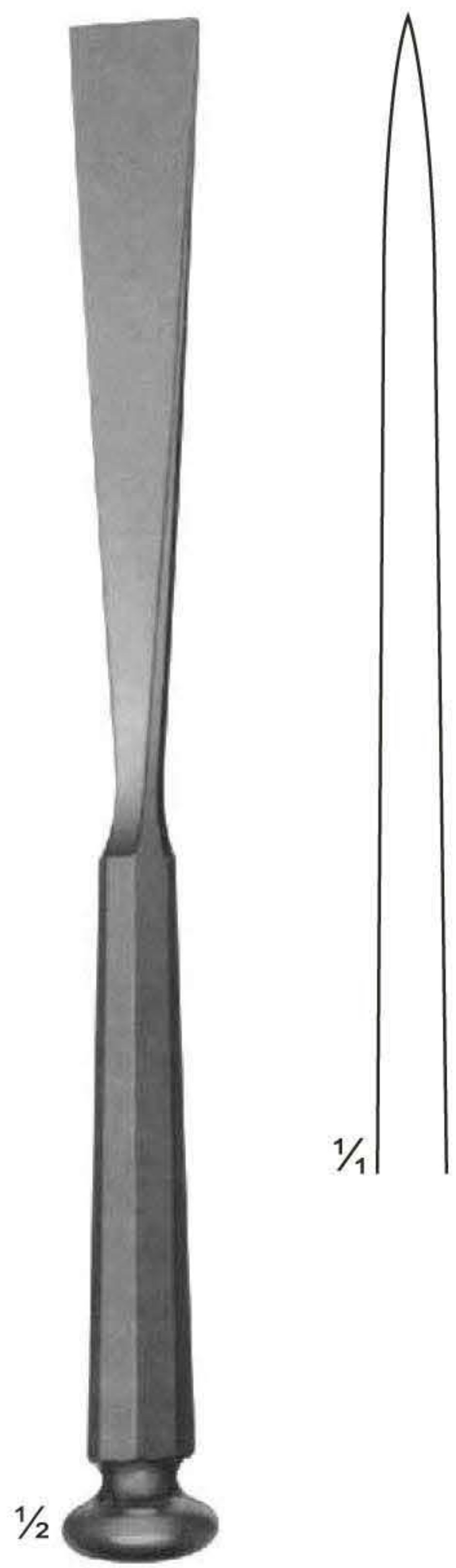

10 mm
12 mm
15 mm
20 mm
25 mm

STILLE
UG-1727
Osteotomes
205 mm



10 mm
12 mm
15 mm
20 mm
25 mm

STILLE
UG-1730
Osteotomes, curved
205 mm



LAMBOTTE
UG-1732
Osteotomes
245 mm



4 mm
8 mm
10 mm
13 mm
15 mm
18 mm
20 mm
25 mm
30 mm
38 mm
44 mm
50 mm



LAMBOTTE
UG-1734
Osteotomes, curved
245 mm

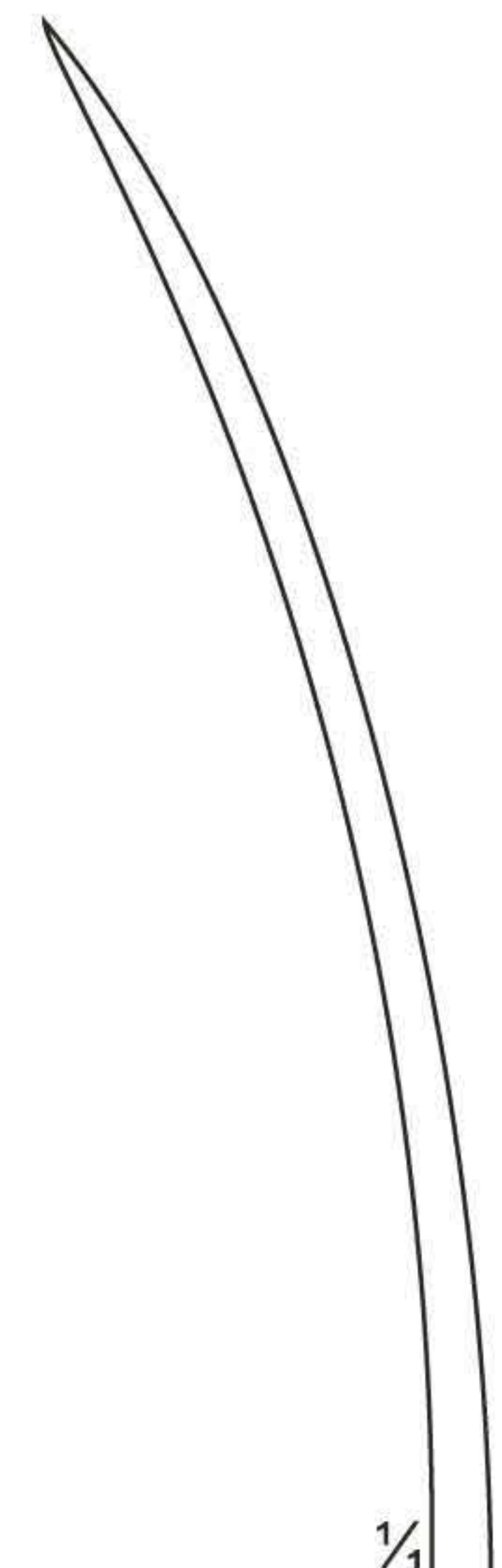

8 mm
13 mm
18 mm
25 mm
30 mm
38 mm

Osteotomes, Chisels and Gouges with HARTPRESS -handle



1/2

LEXER-MINI
UG-1735
Osteotomes
180 mm



1/2

LEXER-MINI
UG-1736
Gouges
180 mm



1/2

LEXER
UG-1737
Osteotomes
220 mm



1/2

LEXER
UG-1744
Gouges
220 mm



1/2

LEXER
UG-1753
Gouge for
removing broken
screws
220 mm

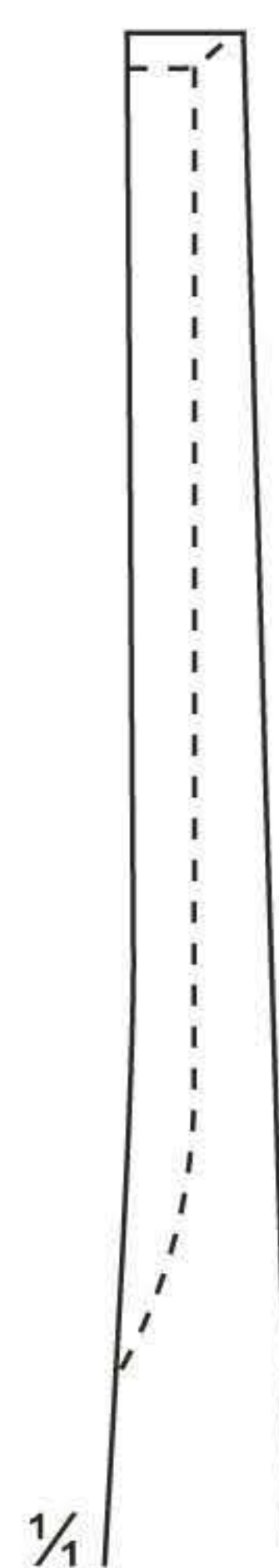

1/4



1/2

ZIELKE
UG-1754
Gouge for
scoliose-operations
230 mm

Osteotomes ,Chisels and Gouges with HARTPRESS -handle



1/2

LEXER
UG-1756
Osteotomes,
angled
275 mm

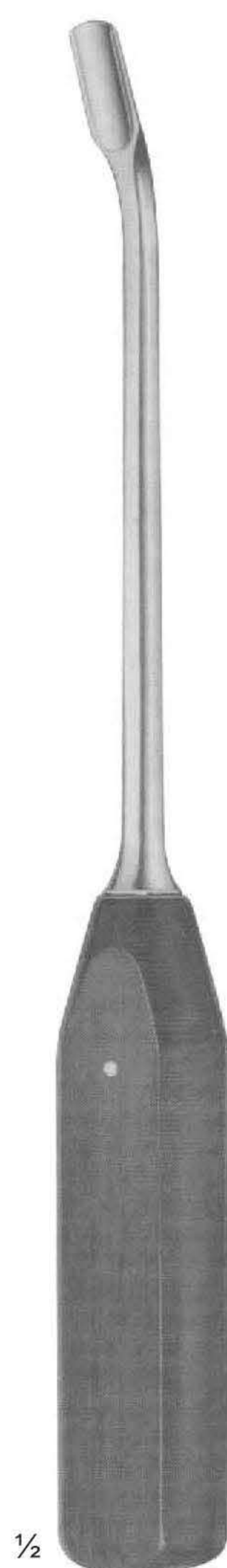

1/2

LEXER
UG-1757
Gouges,
angled
275 mm



1/2

21-268
UG-1759
245 mm



1/2

21-269
UG-1762
265 mm

Reposition Forceps



UG-1764
 Reposition forceps,
 for small fragments
 135 mm

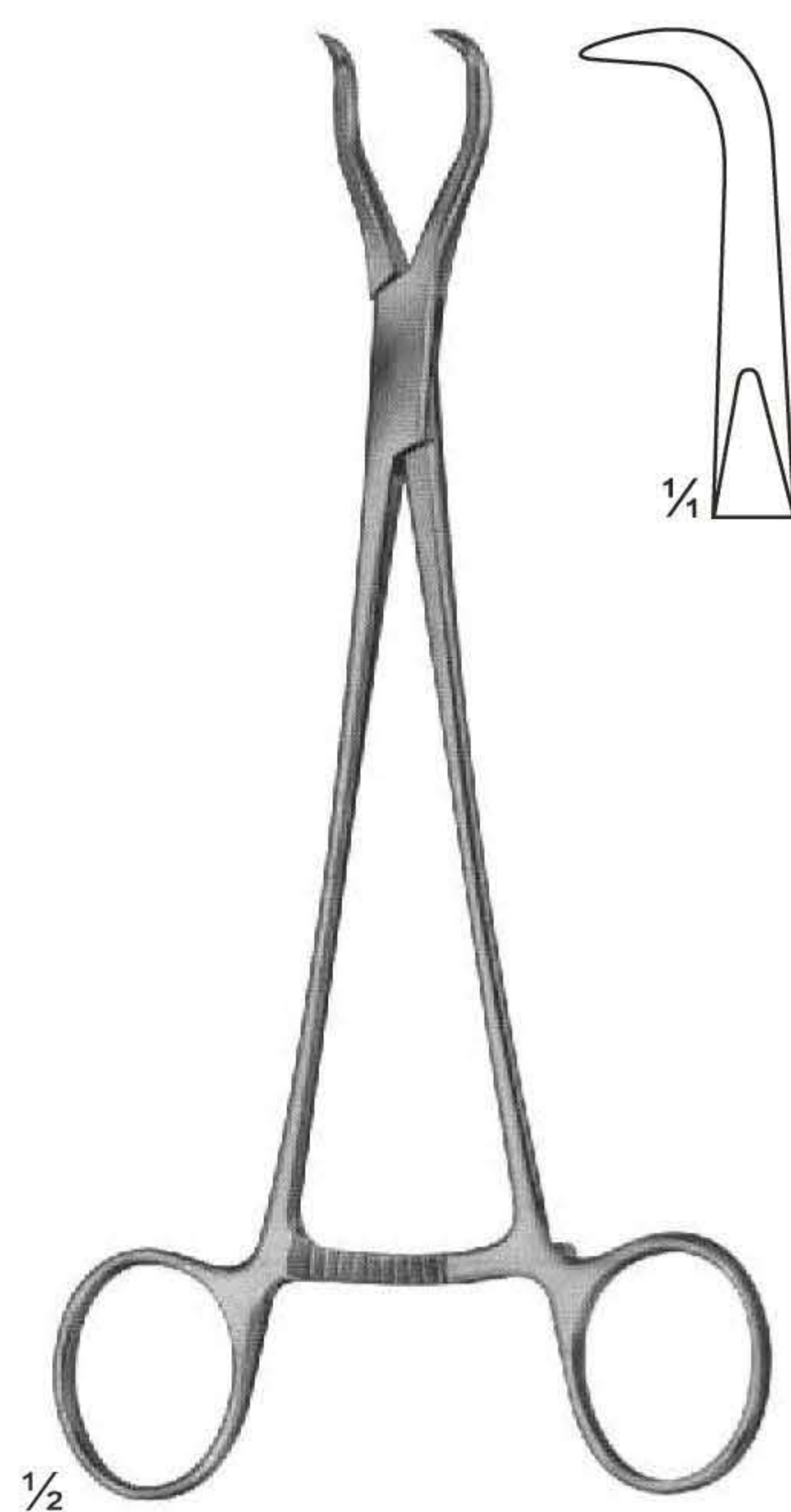

HAASE
UG-1765
 Reposition forceps,
 for mandibular
 fractures
 165 mm

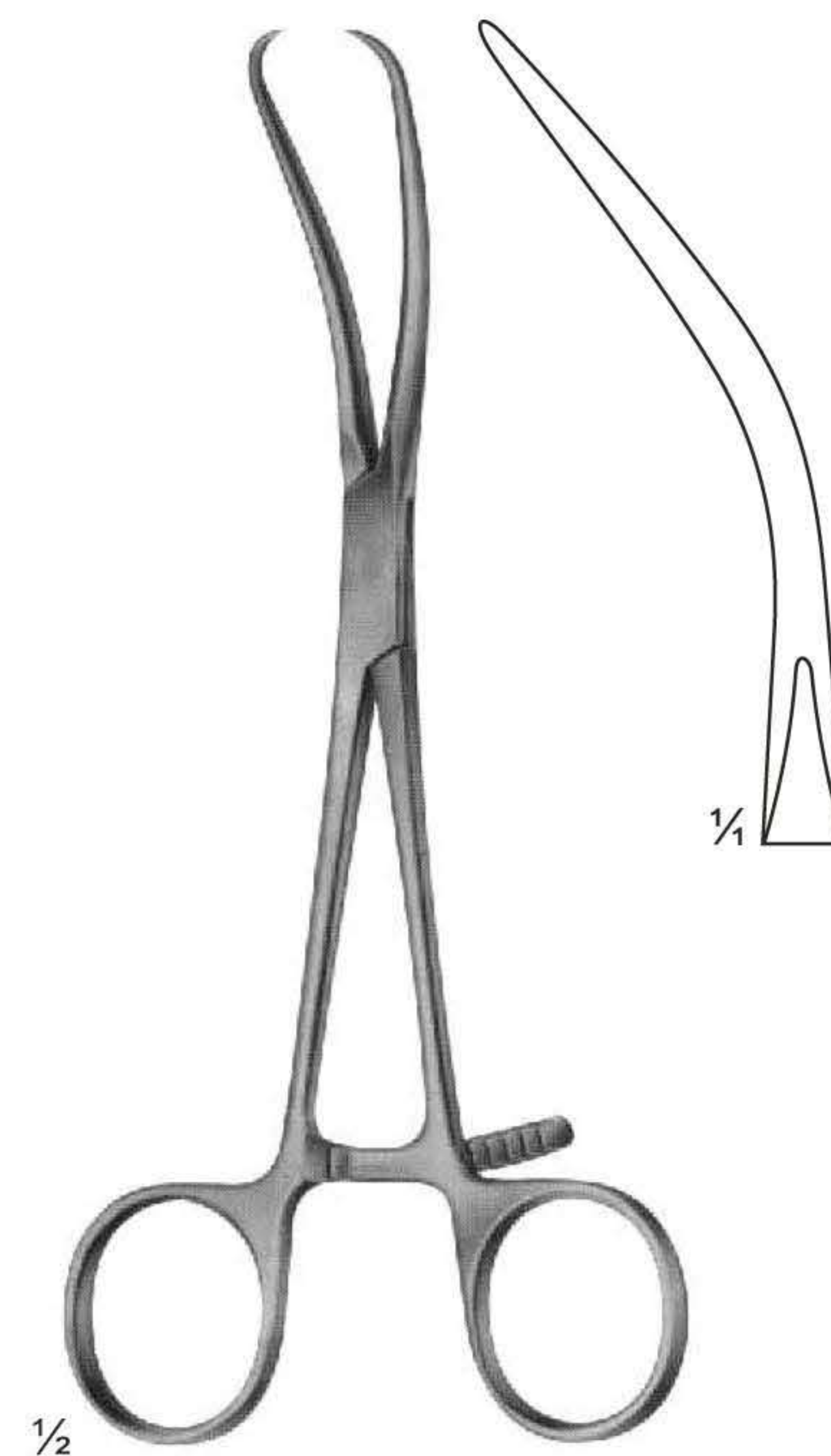

REILL
UG-1766
 Reposition forceps,
 170 mm

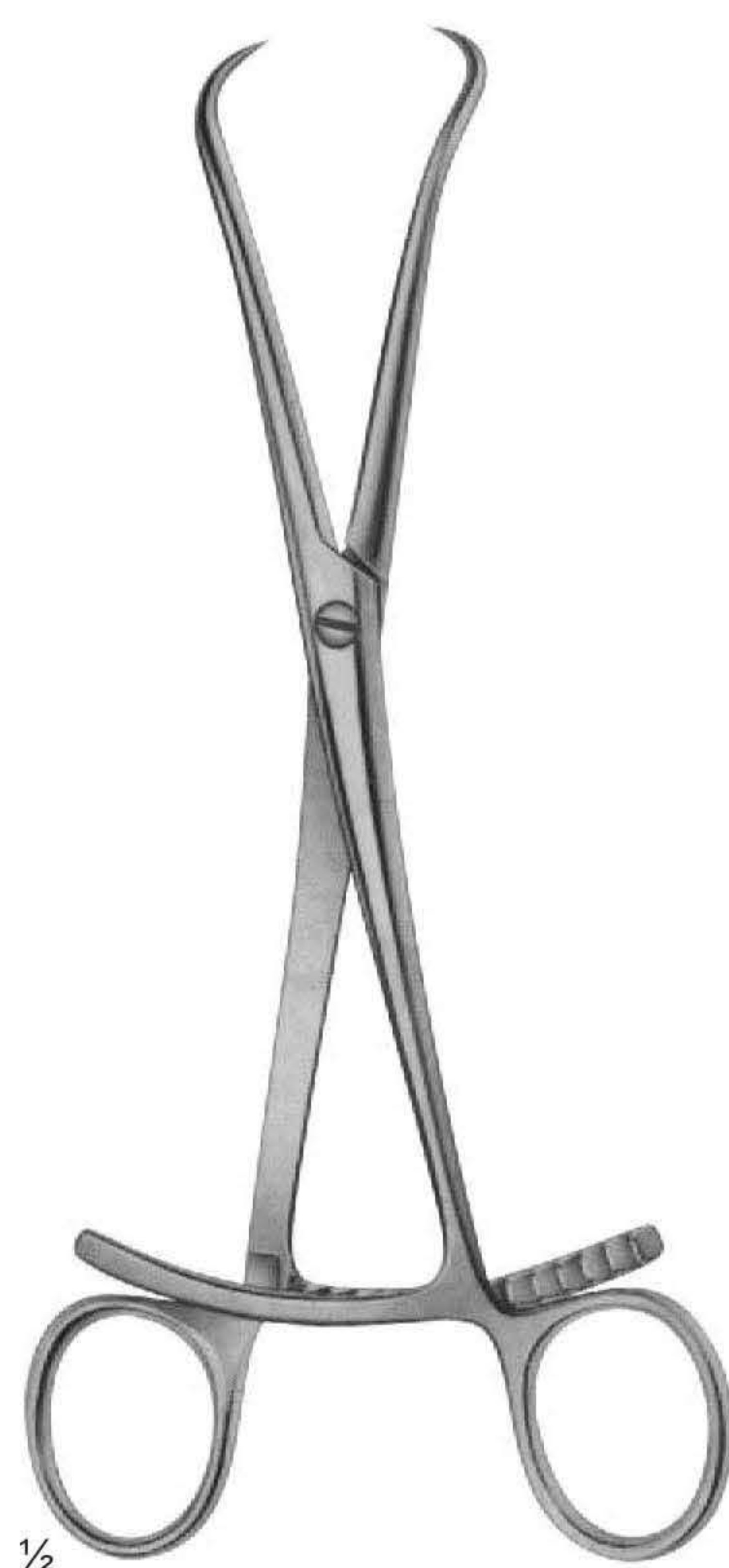

UG-1768
 Reposition forceps
 205 mm

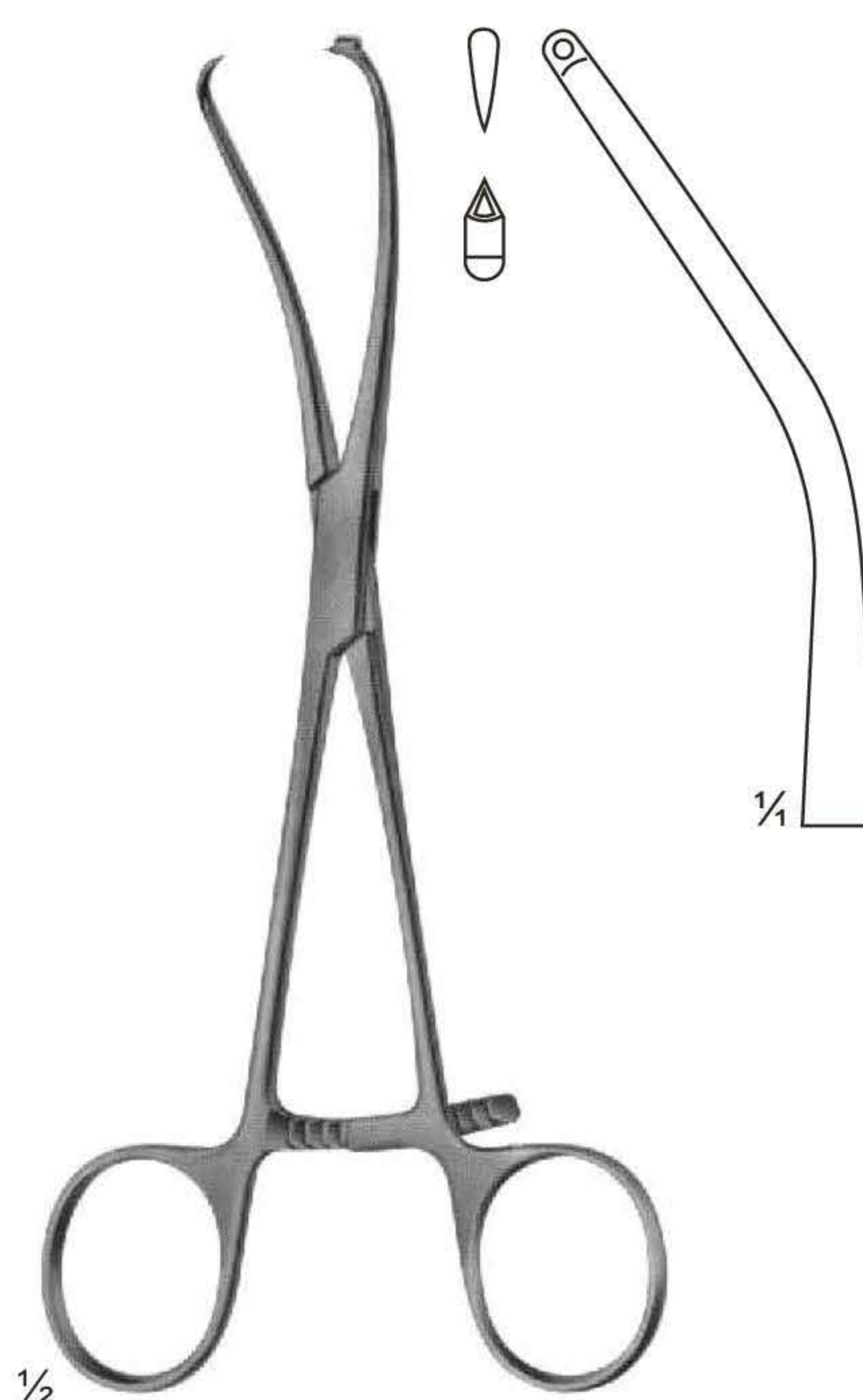

MEYER
UG-1769
 Reposition forceps
 for fingers, with drill
 guide for KIRSCHNER
 wires up to daim.1.0 mm
 170 mm

Reposition Forceps, Bone Holding Forceps



UG-1770
Patella forceps
185 mm



Forceps with
ratchet fixation
140 mm



UG-1771
Forceps with
thread fixation
170 mm



UG-1773
Forceps with
thread fixation
235 mm

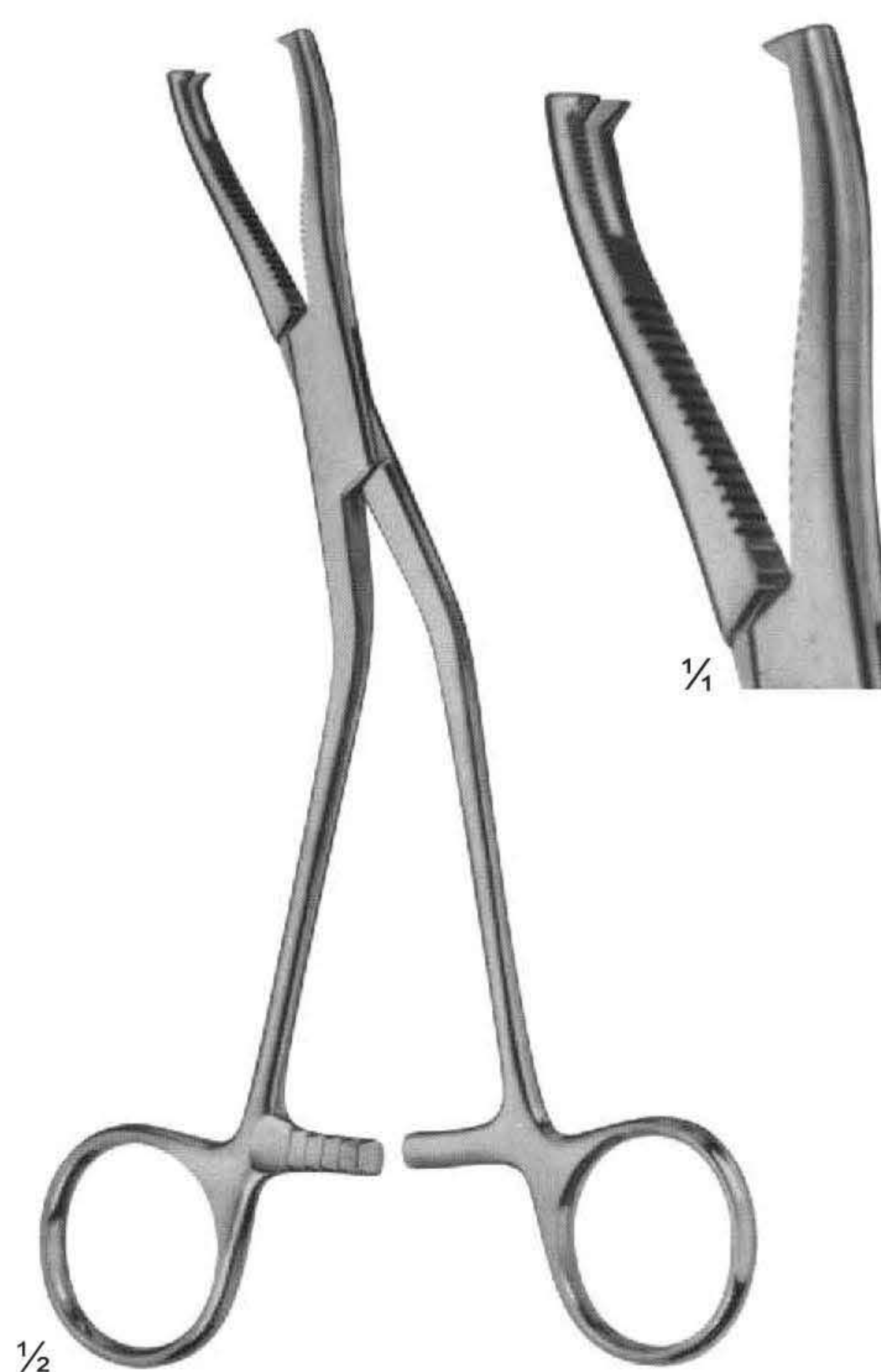

UG-1774
DINGMANN
185 mm

Bone Holding Forceps



1/2

UG-1776
Sequestrum
forceps
200 mm

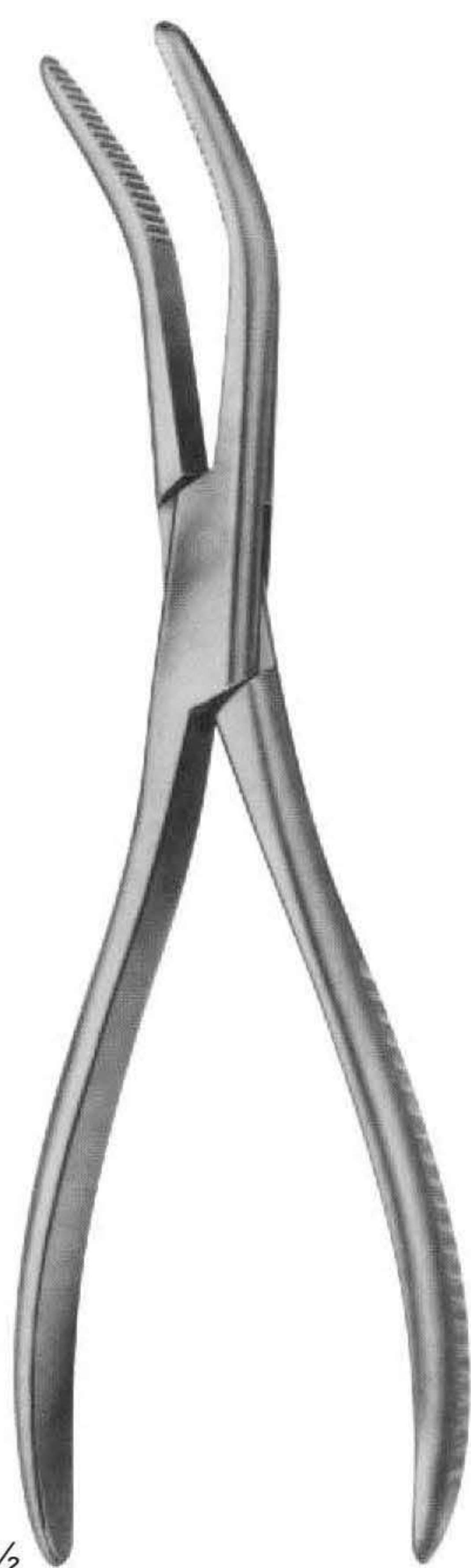

1/2

UG-1778
VAN BUREN
Sequestrum
forceps
225 mm

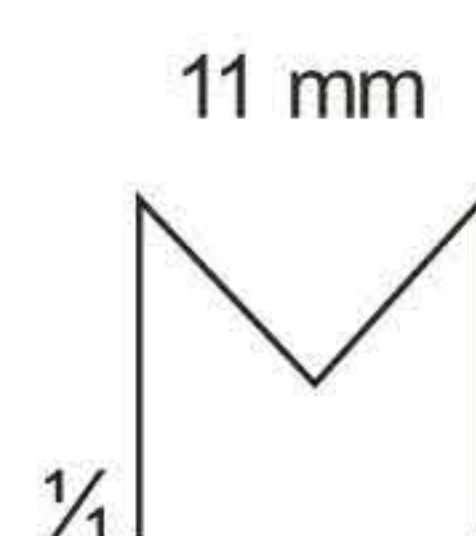

1/2

UG-1780
LANGENBECK
Sequestrum
forceps
205 mm

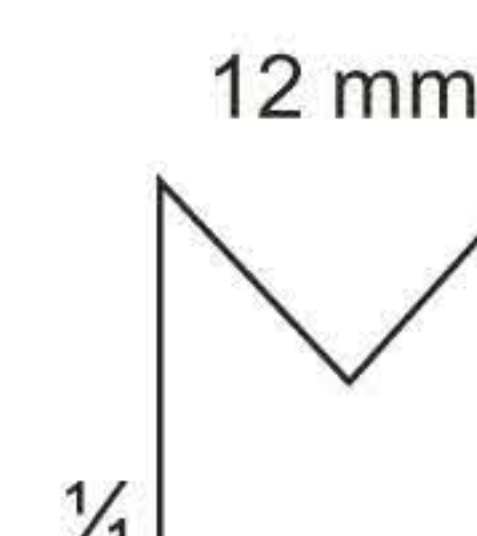

1/2

UG-1781
FERGUSSON
Sequestrum
forceps
205 mm

Bone Holding Forceps

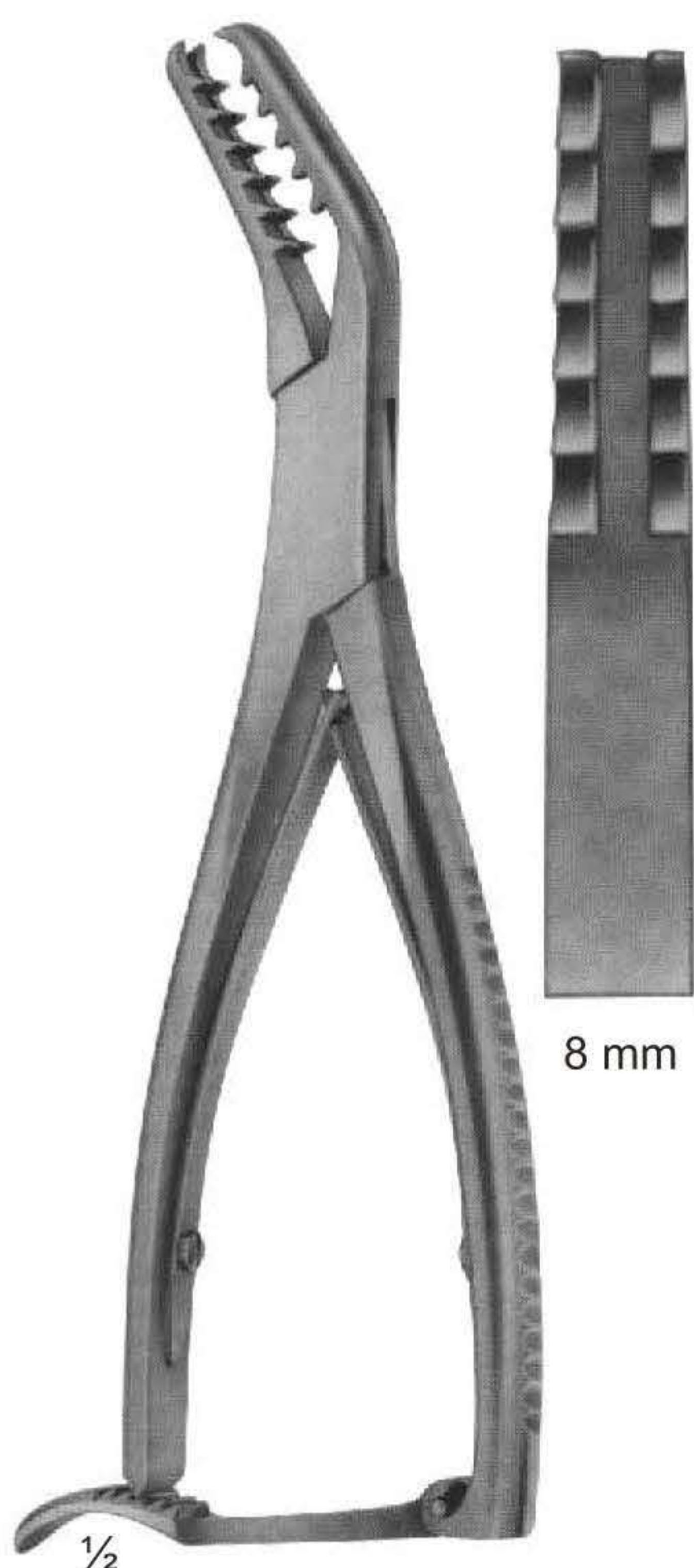
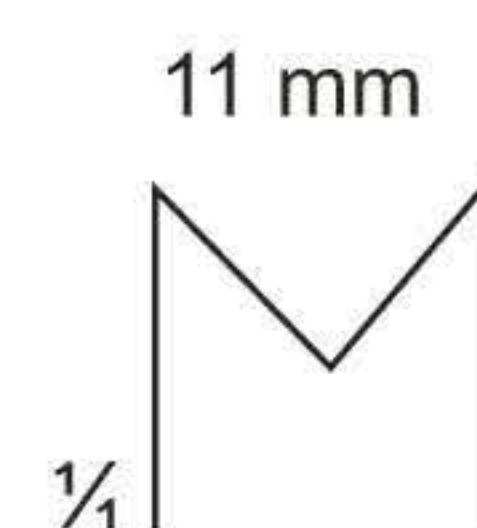
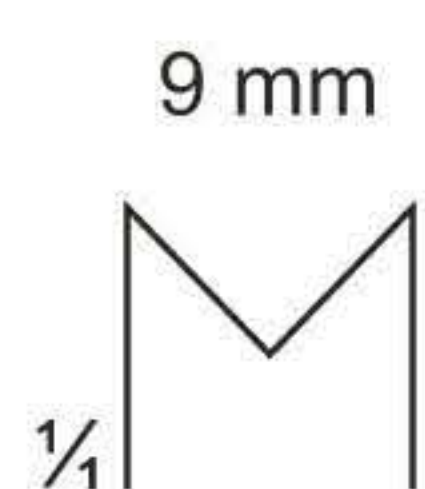
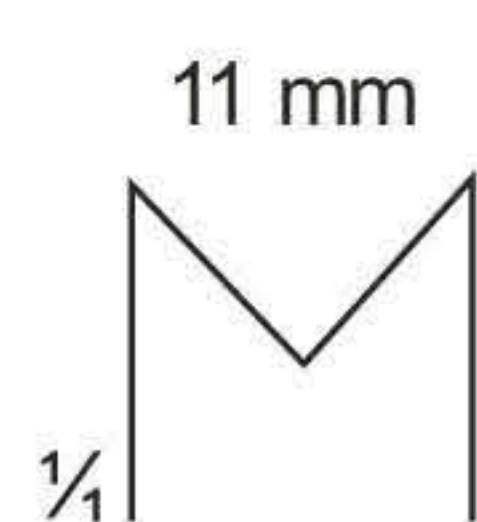
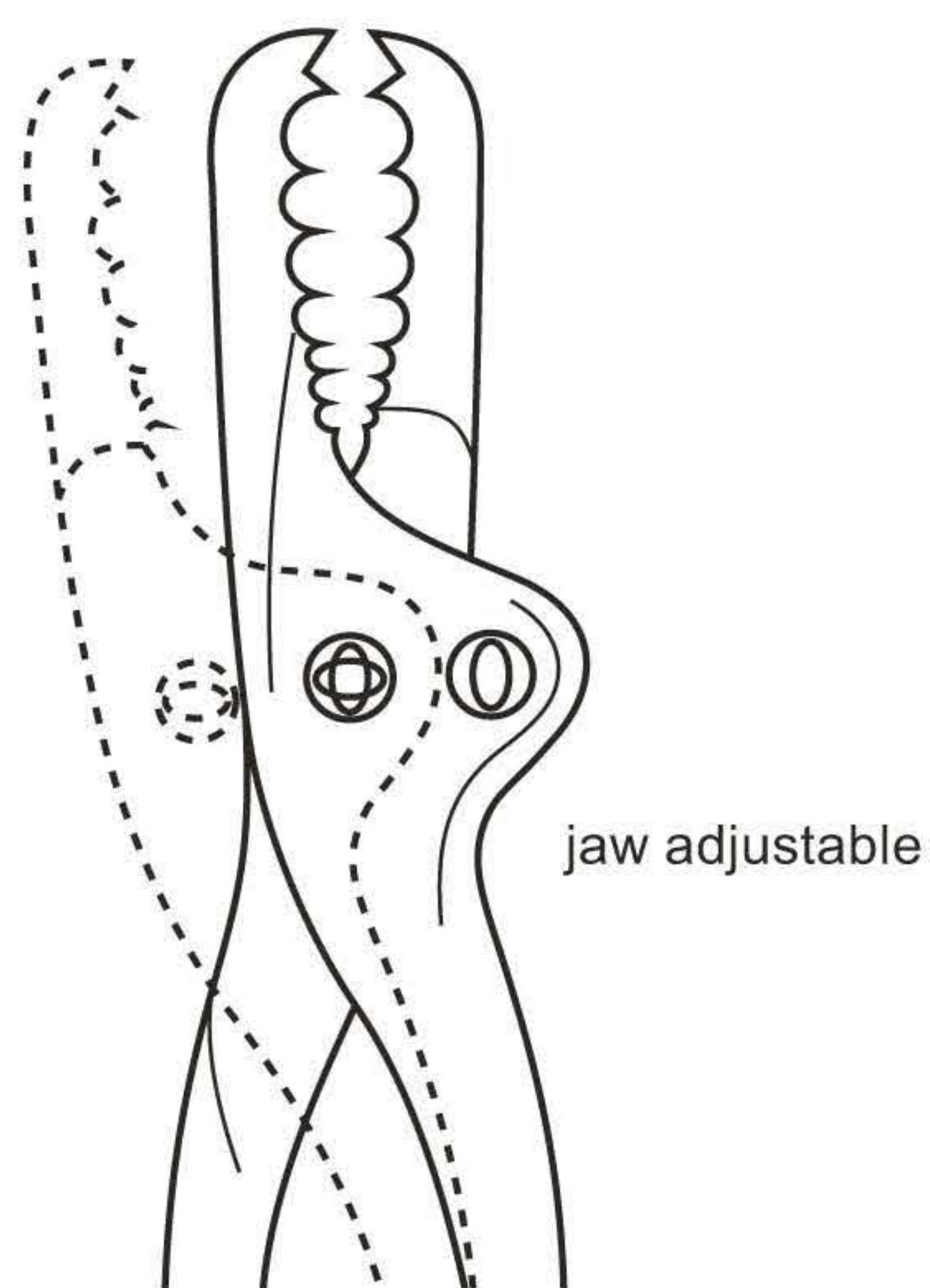

UG-1785
SEMB
190 mm



UG-1788
FARABEUFF
230 mm

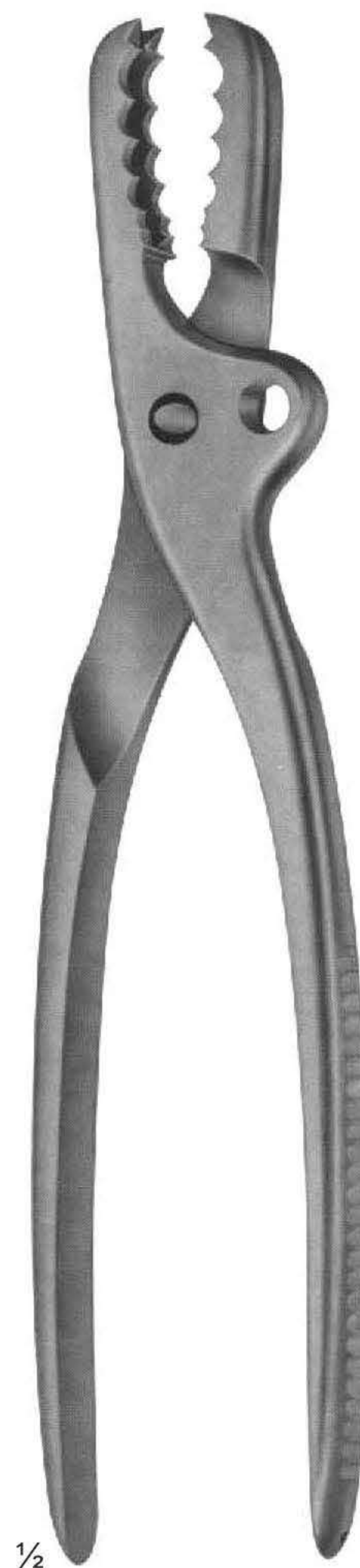

UG-1790
FARABEUFF
255 mm



UG-1791
FARABEUFF-LAMBOTTE
255 mm

Bone Holding Forceps



UG-1854
KERN-LANE
240 mm

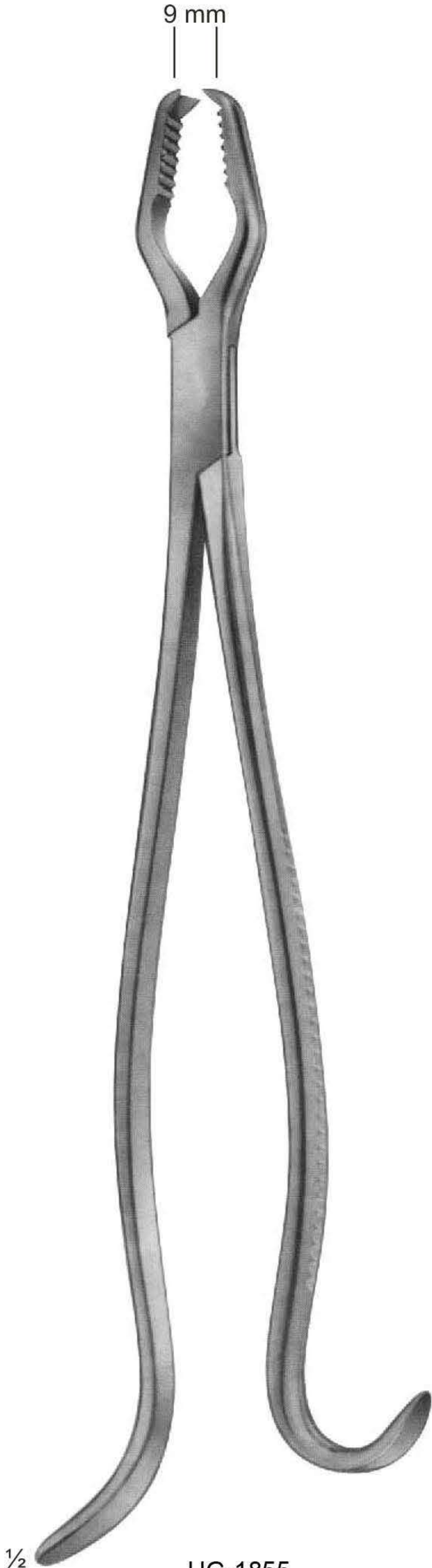

UG-1855
LANE
330 mm



UG-1856
KERN-LANE
240 mm

Bone Holding Forceps



Bone Holding Forceps



1/2

UG-1859

145 mm
190 mm
240 mm
260 mm
280 mm



1/2

UG-1860 255 mm
VERBRUGGE 265 mm
with lip joint 270 mm



1/2

UG-1861
LAMBOTTE
265 mm

Bone Clamps



UG-1862
LOWMAN
22-133 170 mm
22-134 205 mm



UG-1863
LOWMAN-GERSTER
210 mm



UG-1764
LOWMAN-HOGLUND
175 mm

Synovectomy-Rongeurs, Bone Rongeurs



1/2

UG-1869
Synovectomy rongeur
width of jaws 1.2 mm
130 mm



1/2

UG-1870
Synovectomy rongeur
width of jaws 2.0 mm
130 mm



1/2

UG-1872
STELLBRINK
Synovectomy rongeur
175 mm



1/2

UG-1873
STELLBRINK
Synovectomy rongeur
170 mm



1/2

UG-1874
LURE-FRIEDMANN
145 mm



1/2

UG-1875
140 mm

Bone Rongeurs



UG-1876
LURE
150 mm

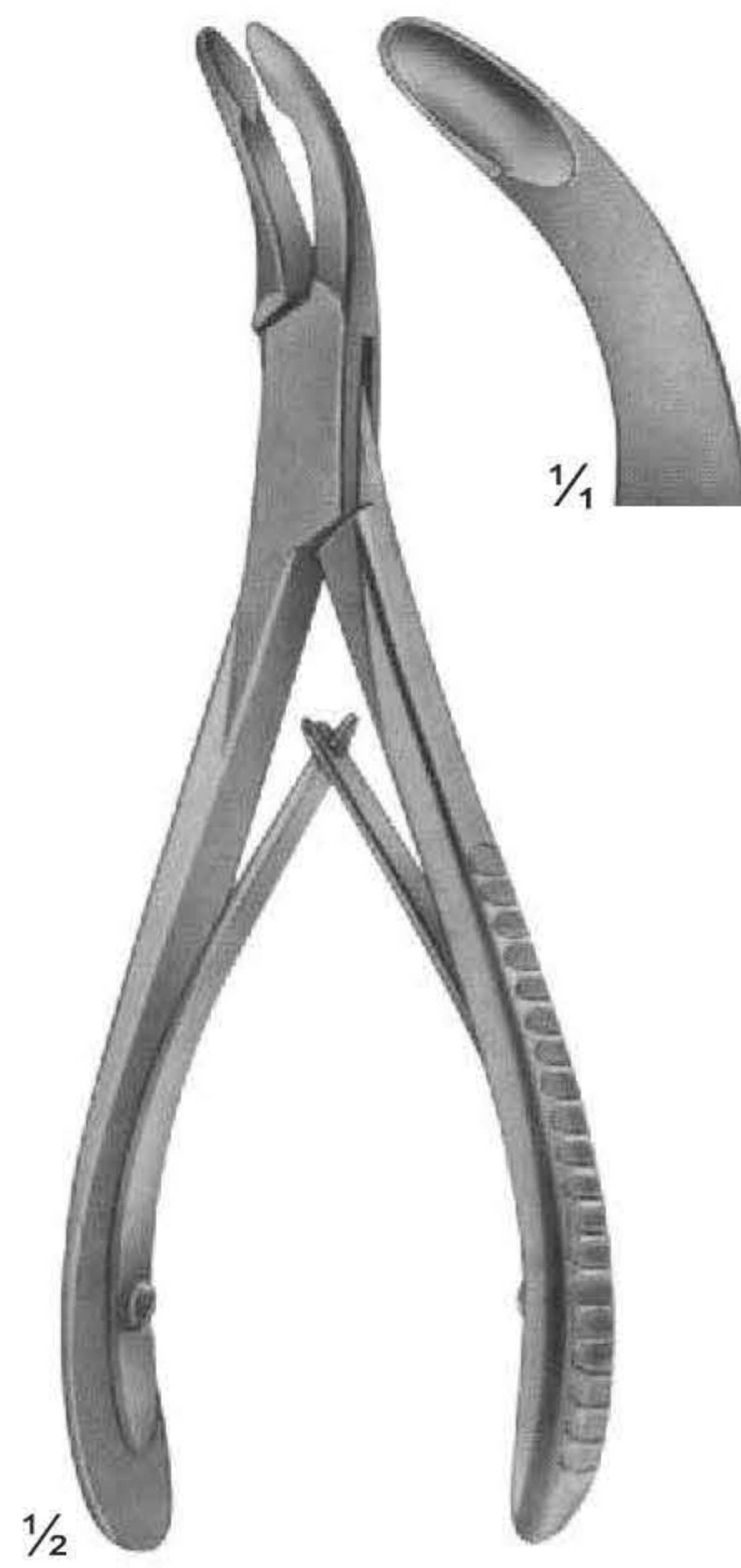

UG-1877
LURE
155 mm

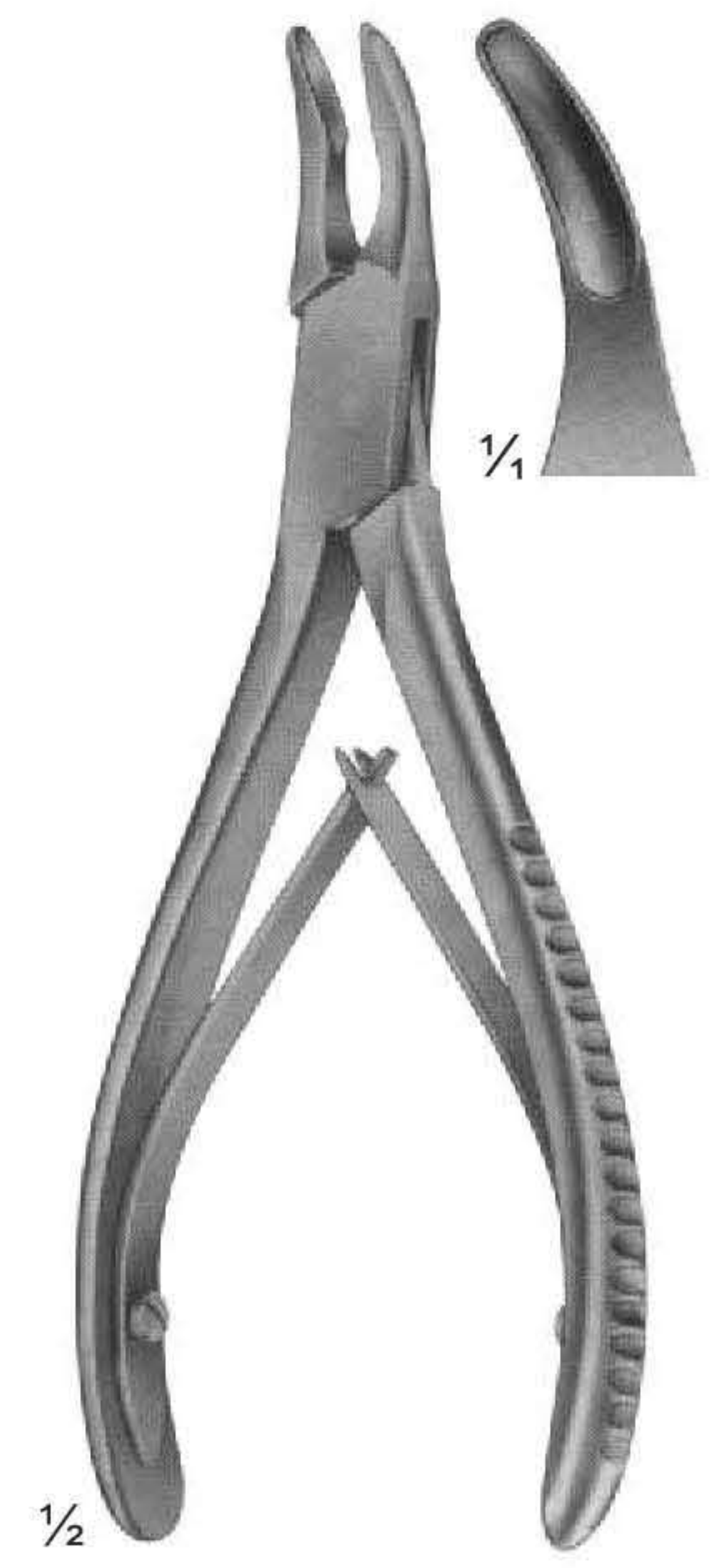

UG-1878
BLUMENTHAL
155 mm

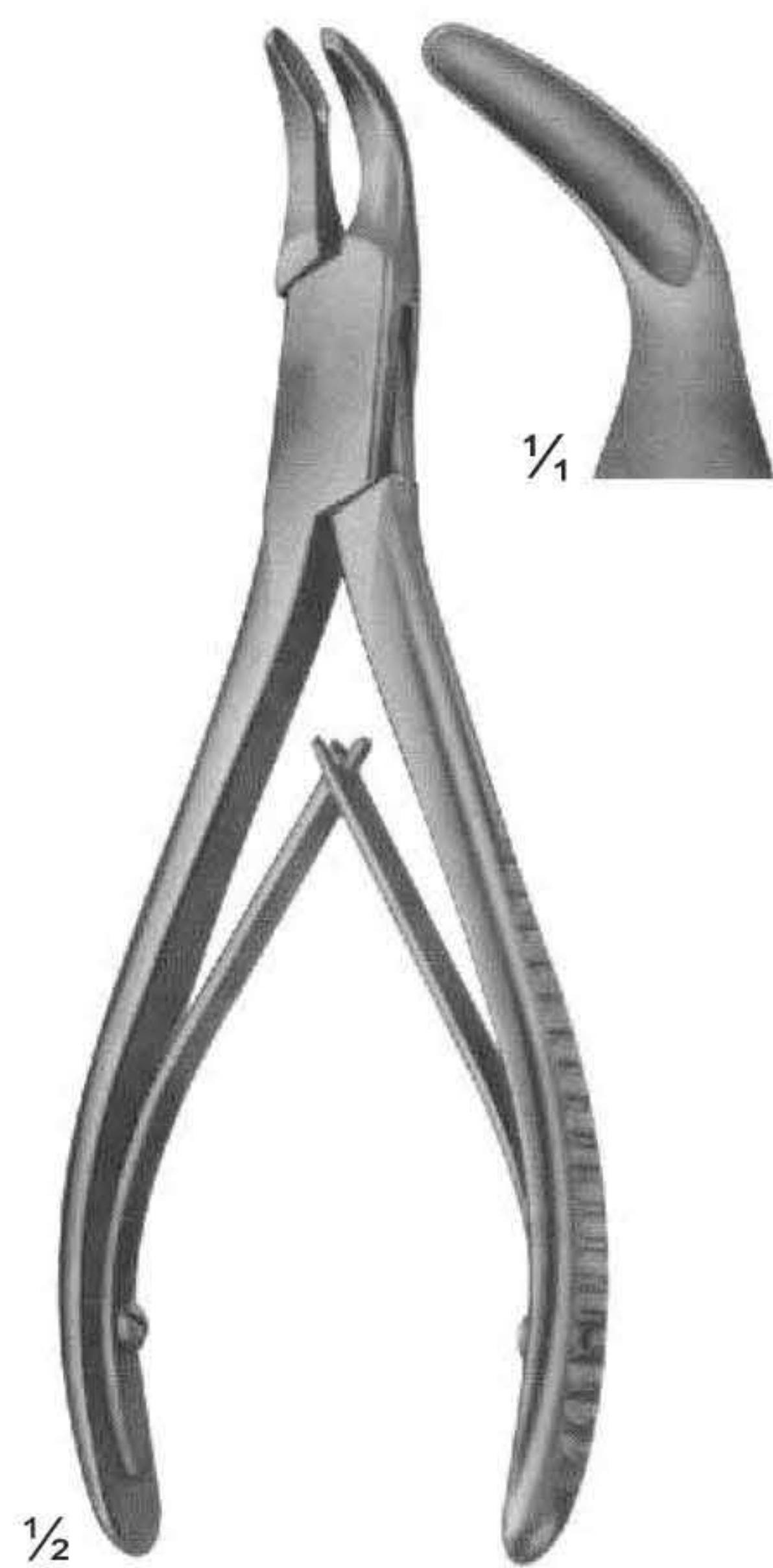

UG-1879
BLUMENTHAL
150 mm



UG-1881
JANSEN
175 mm

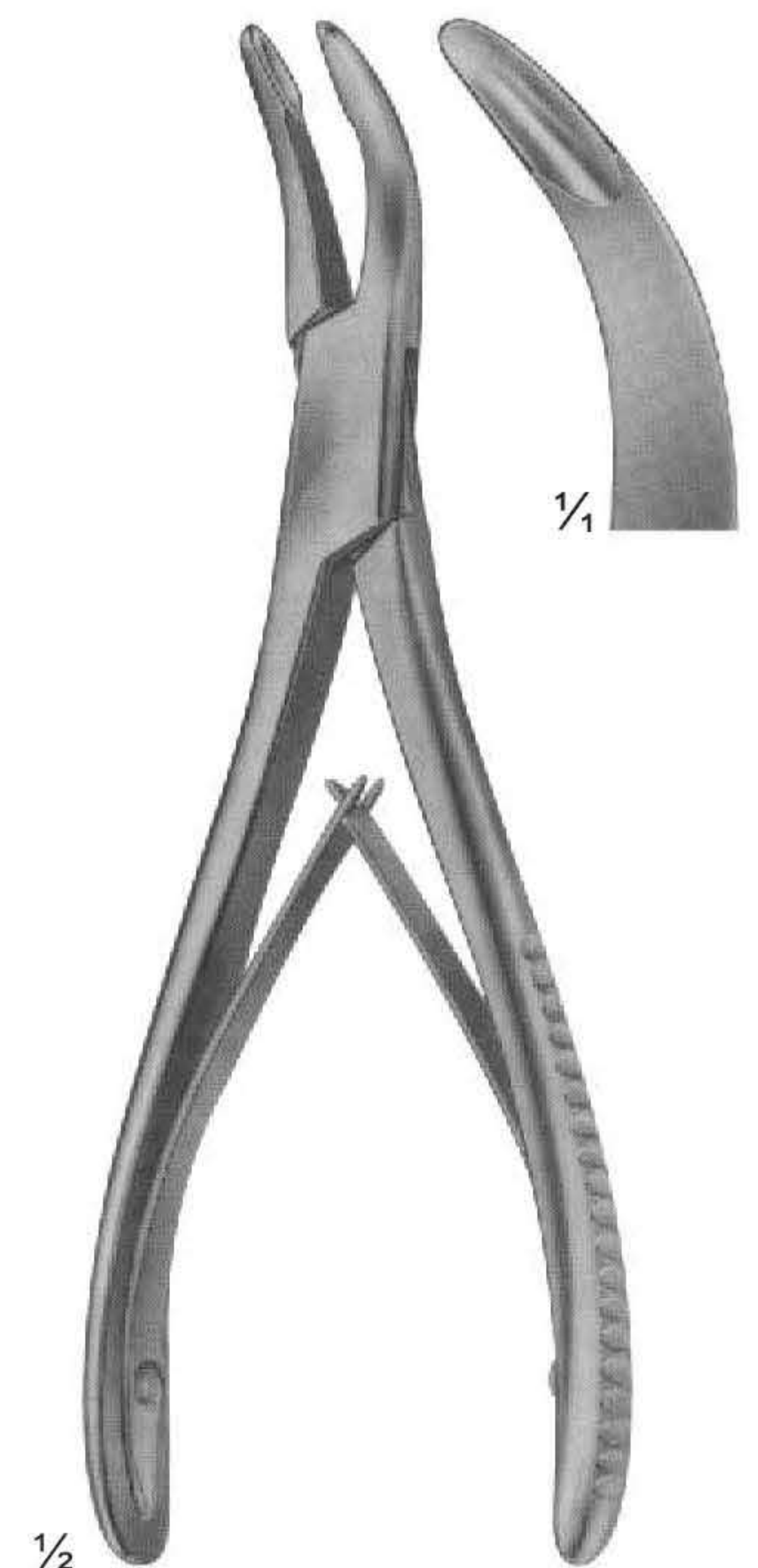

UG-1882
BANE-HARTMANN
175 mm

Bone Rongeurs

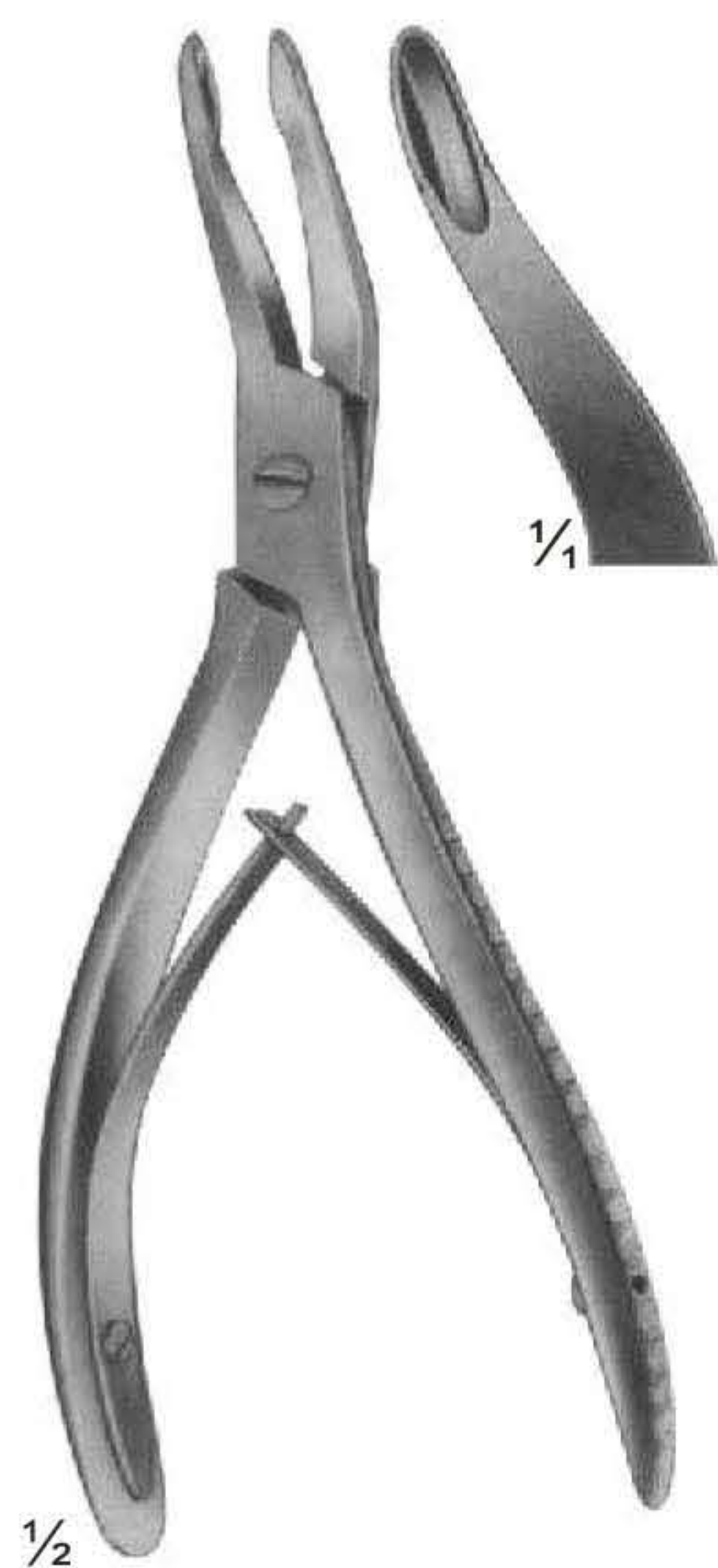

UG-1884
ALEXANDER
140 mm

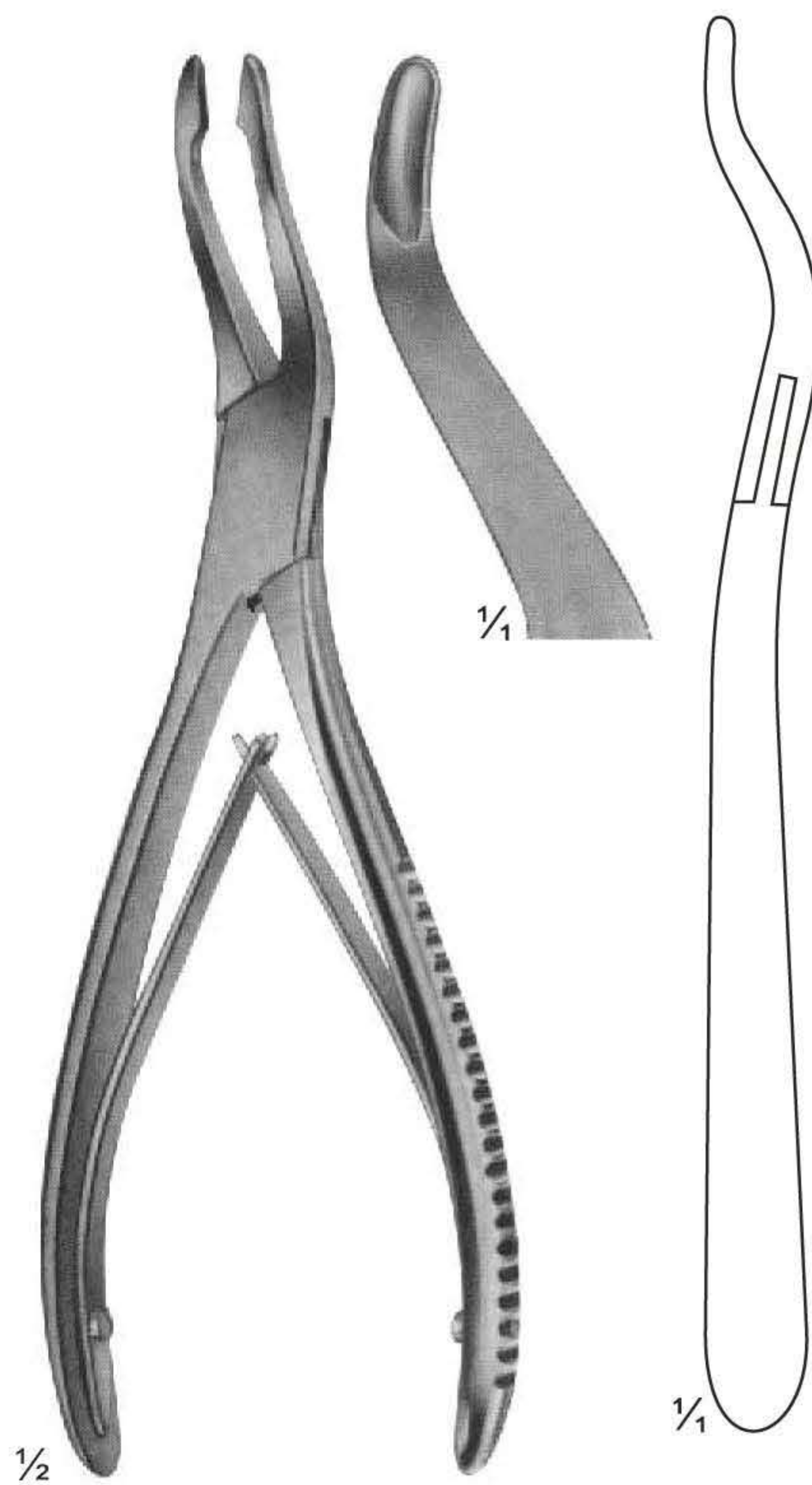

UG-1885
JANSEN
190 mm



UG-1887
LEMPERT
200 mm

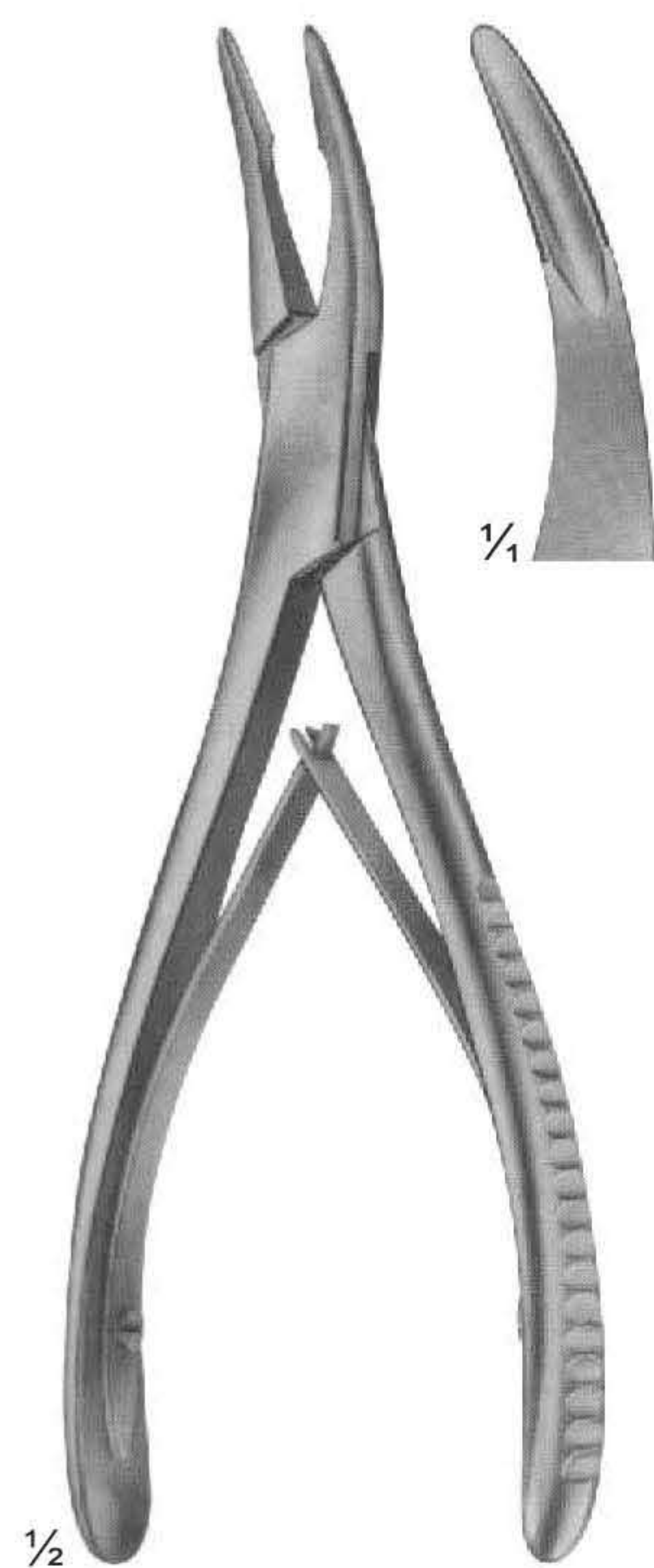

UG-1890
BEYER
180 mm

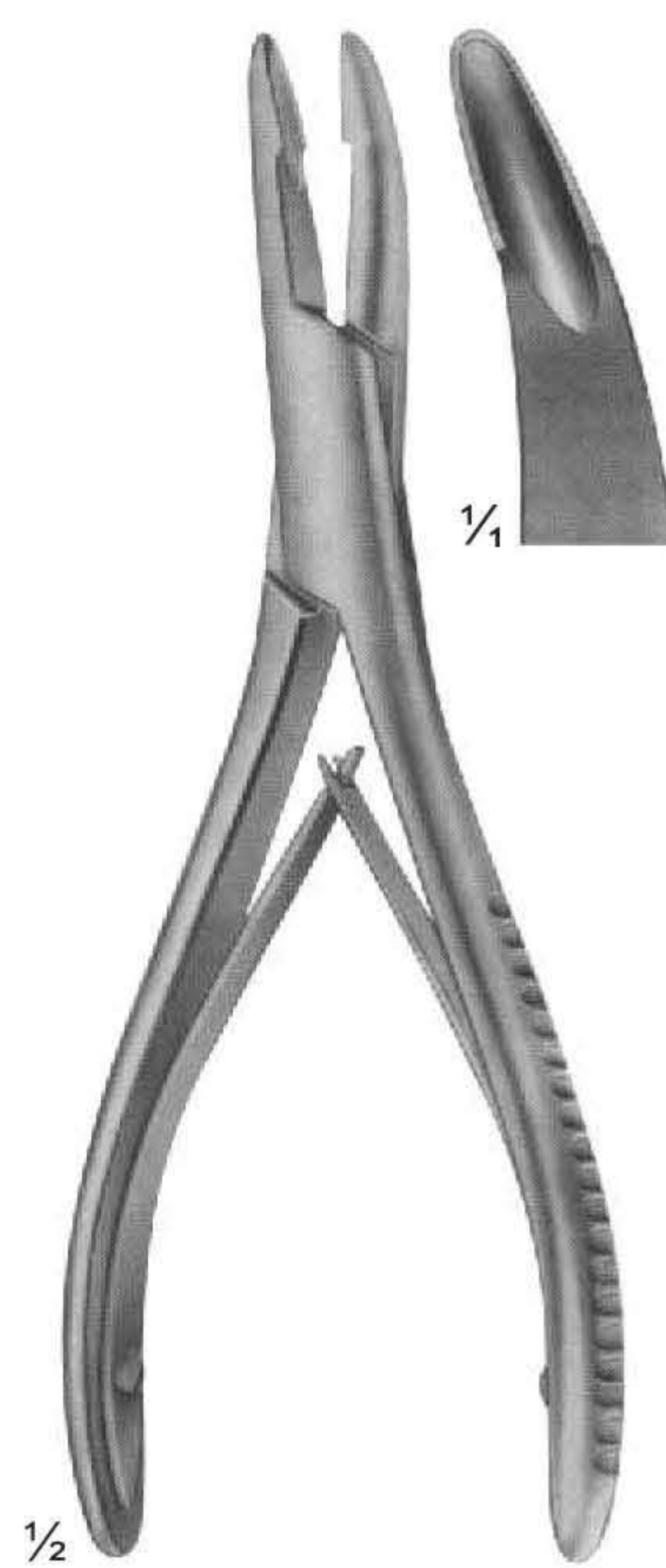

UG-1892
MEAD
165 mm

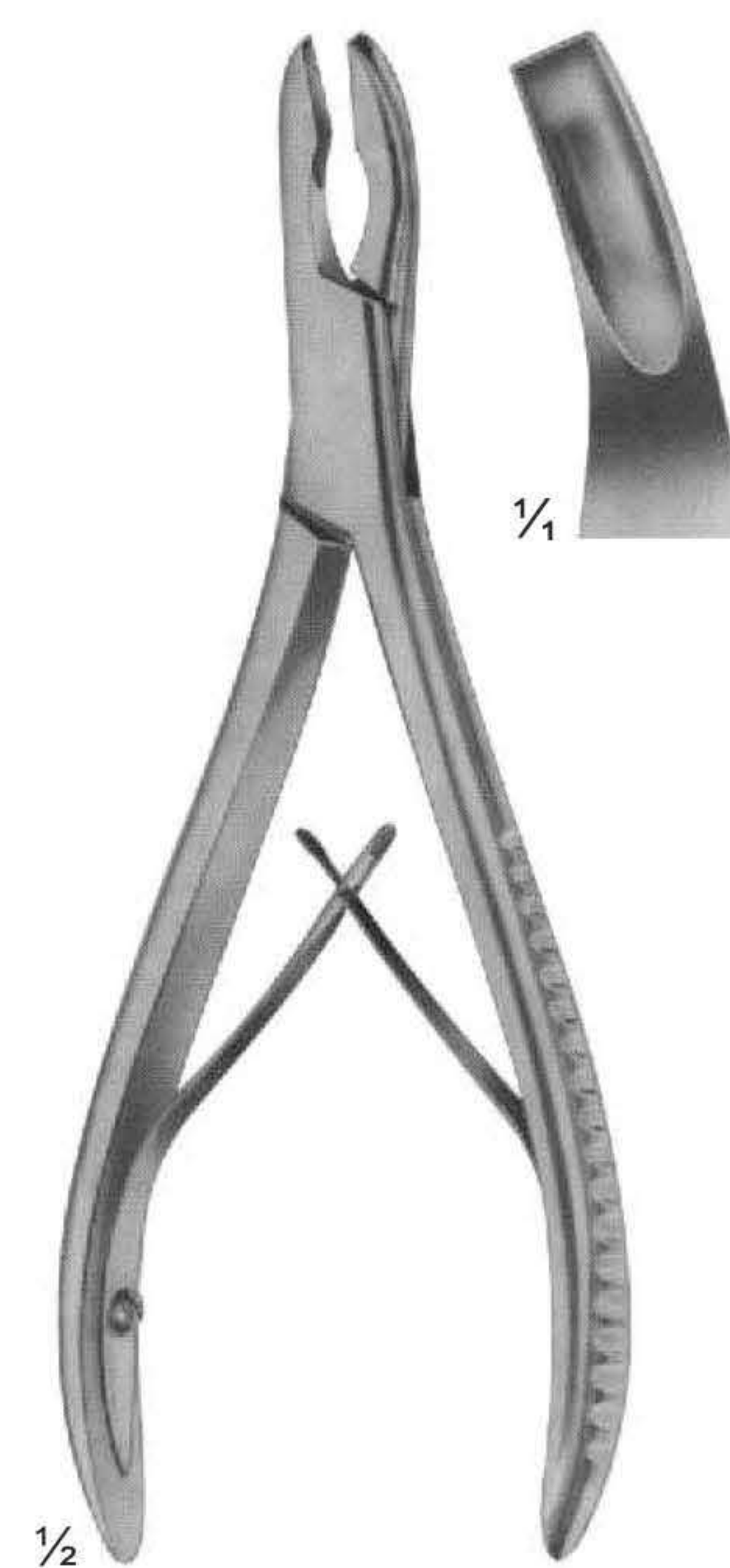

UG-1893
MEAD
165 mm

Bone Rongeurs

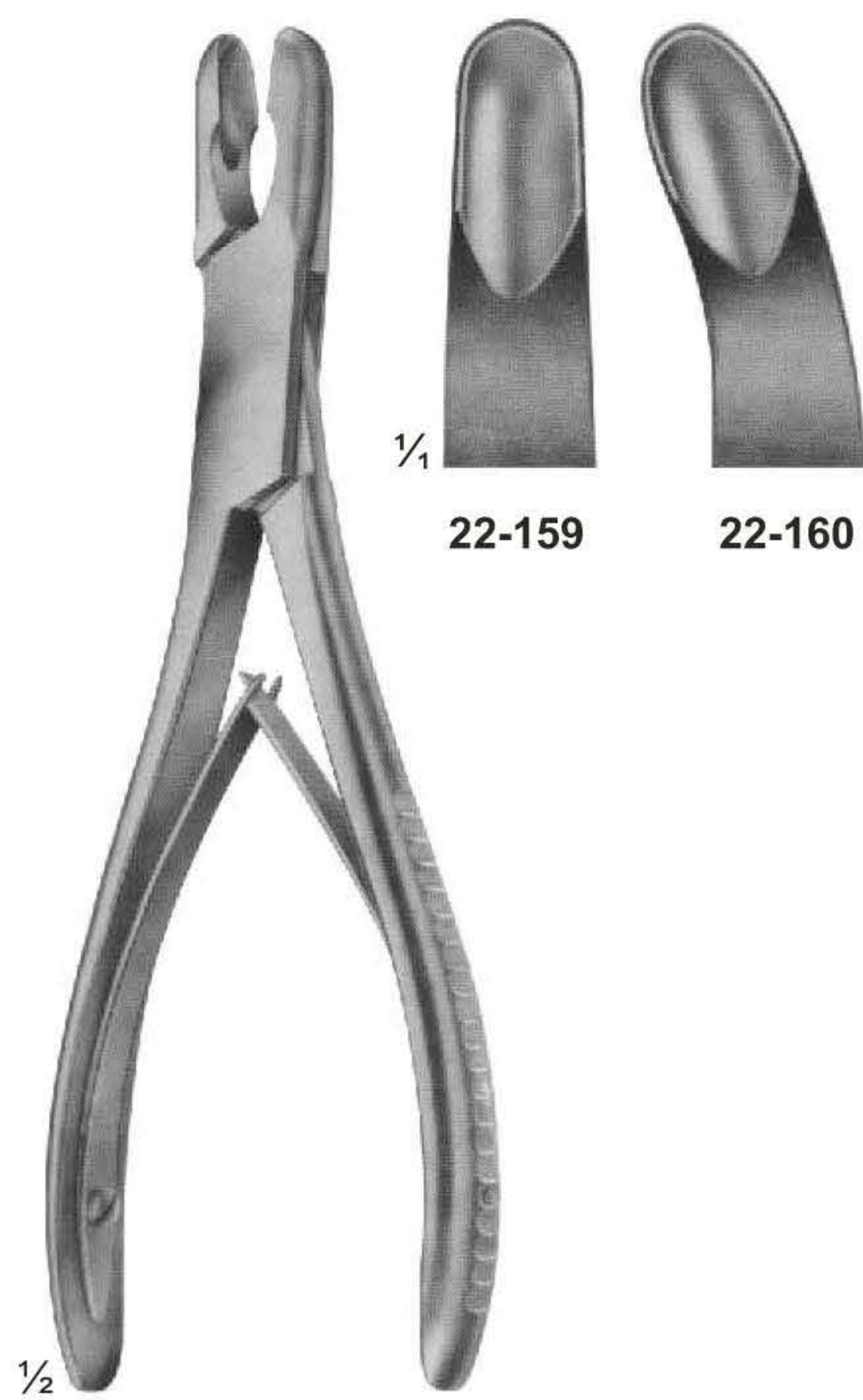

22-159 - 160
LURE
175 mm

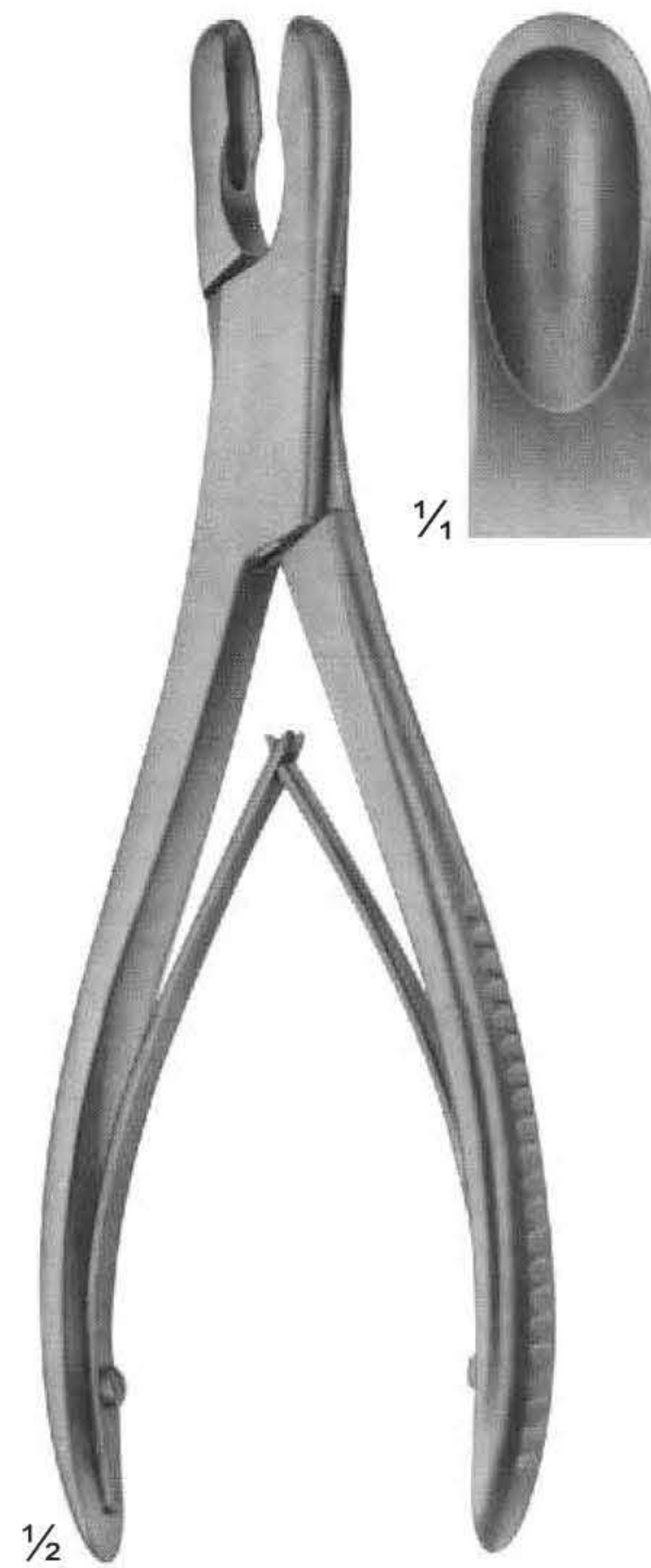

UG-1904
LURE
180 mm

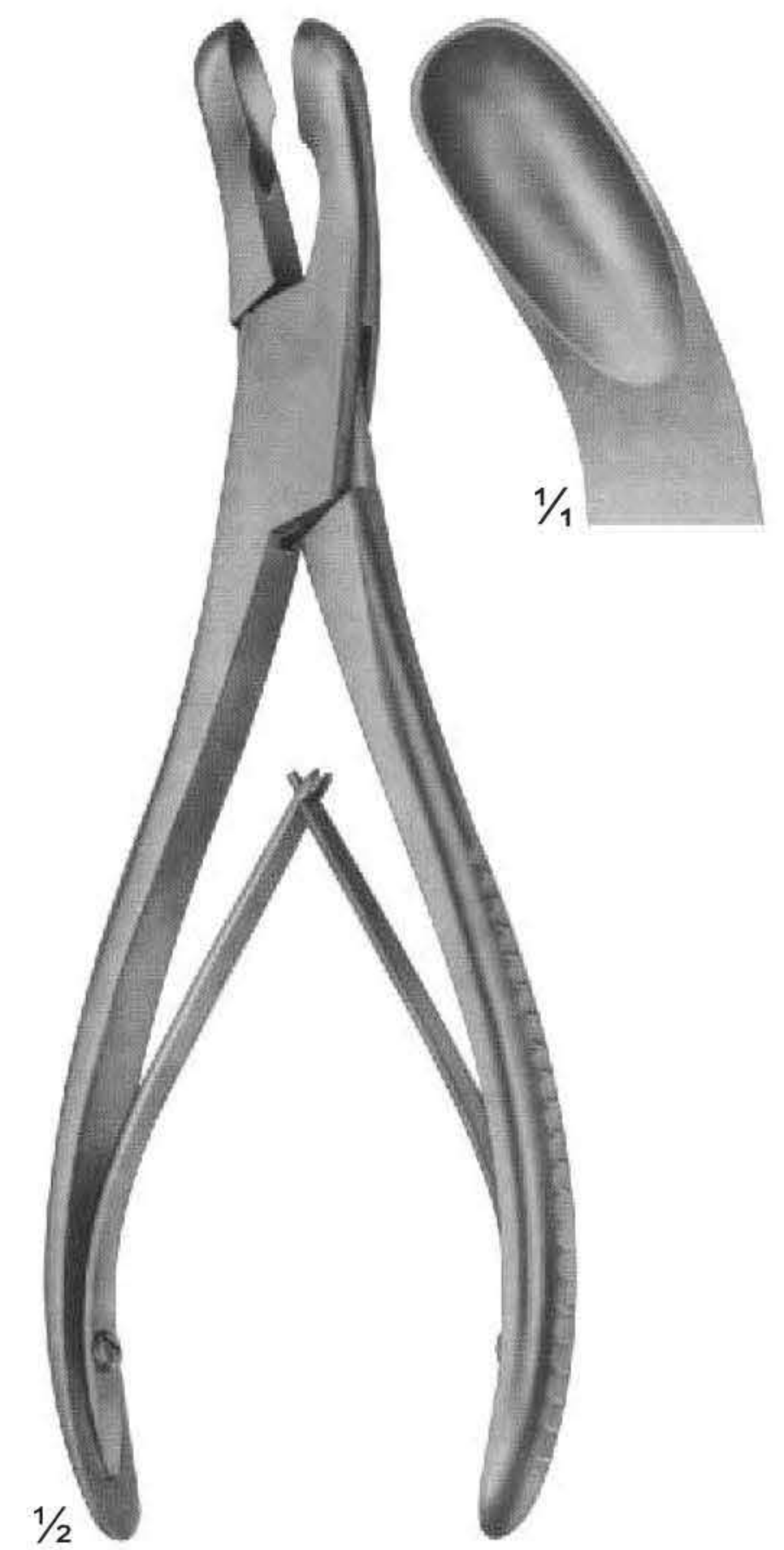

UG-1906
LURE
180 mm

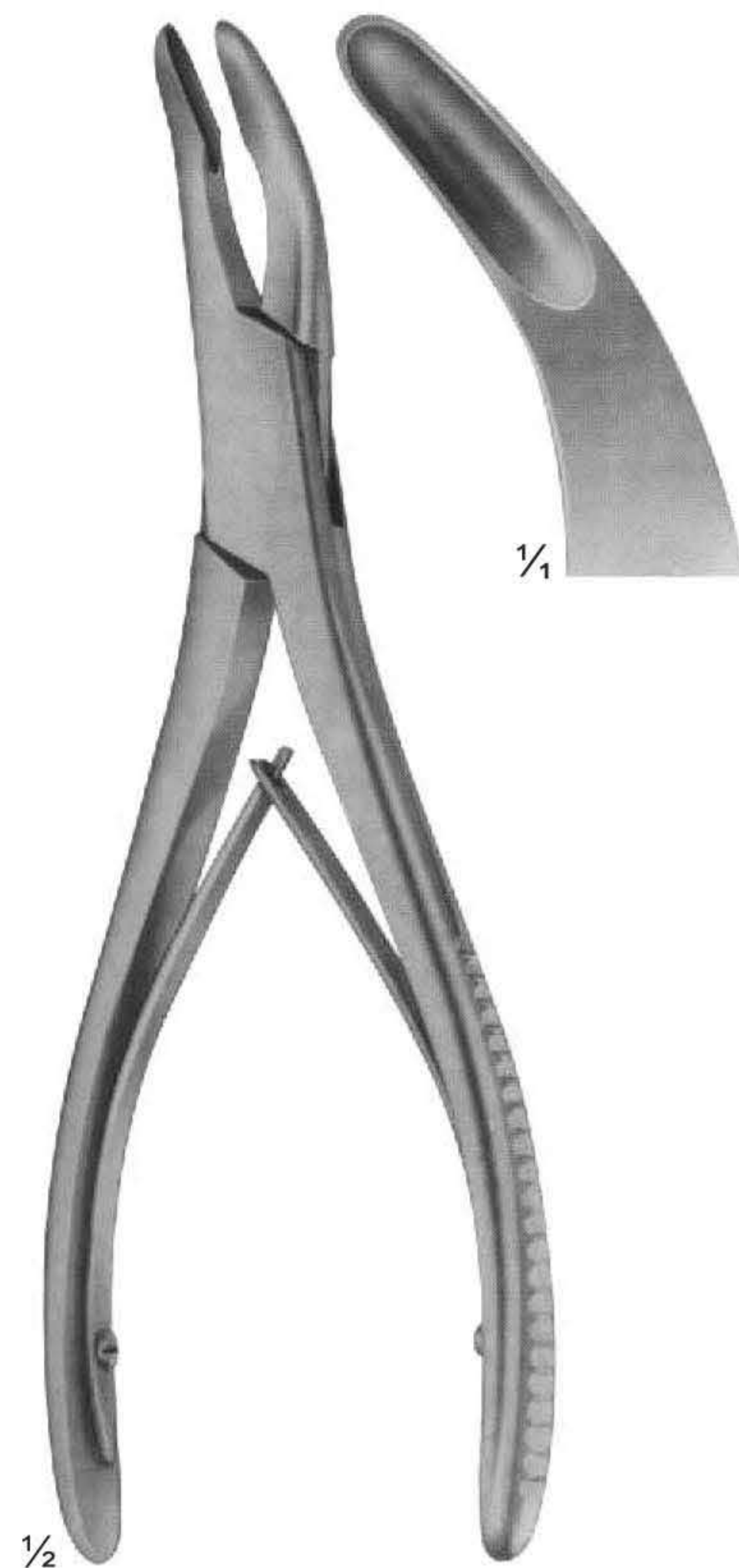

UG-1907
OLIVECRONA
205 mm



UG-1908
BOHLER
155 mm

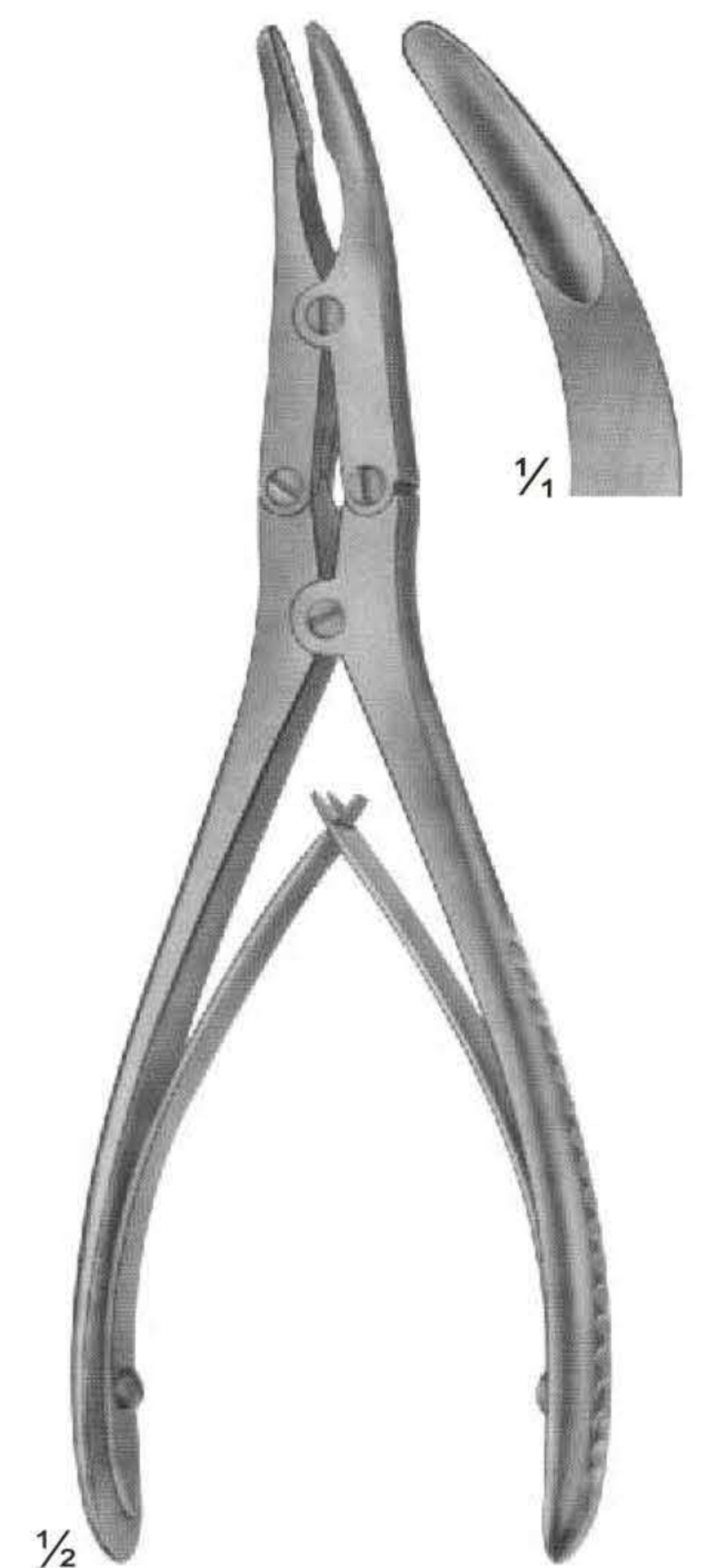

UG-1909
MARQUARTD
200 mm

Bone Rongeurs

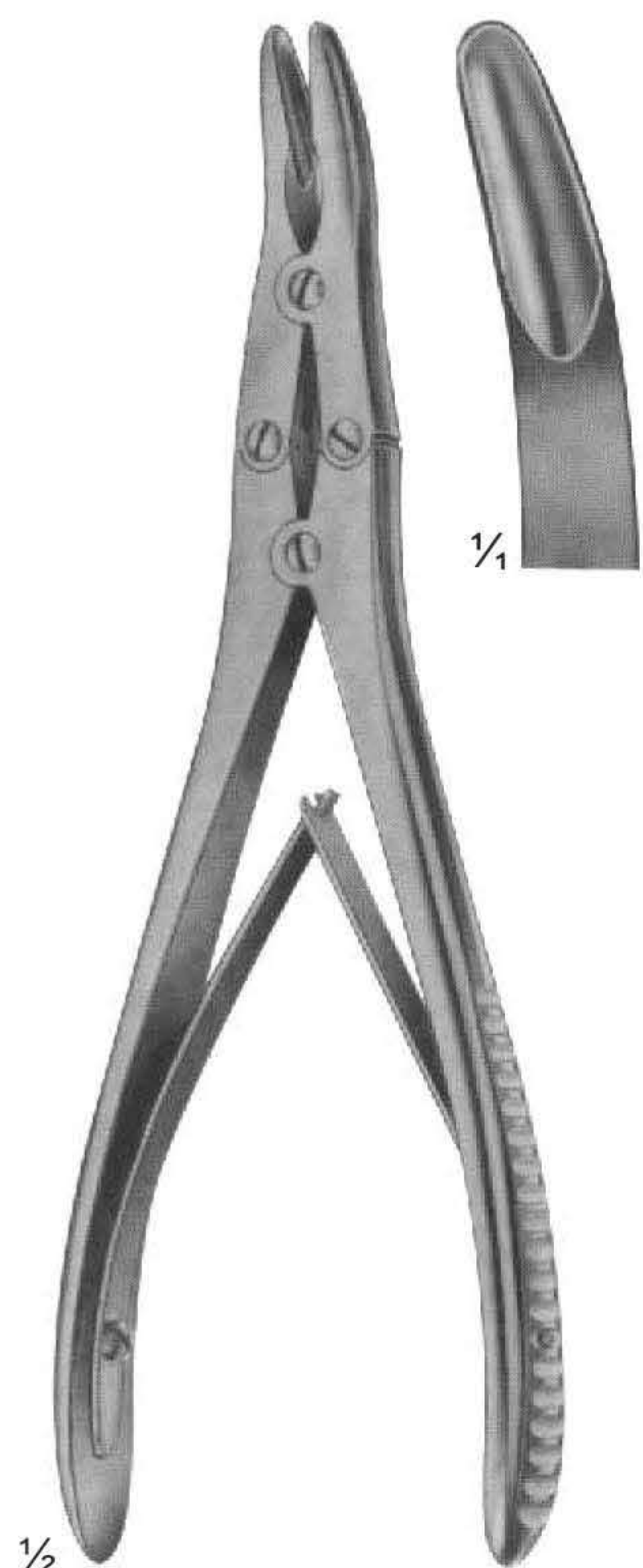

UG-1913
RUSKIN
190 mm



UG-1915
ROTTGEN-RUSKIN
240 mm

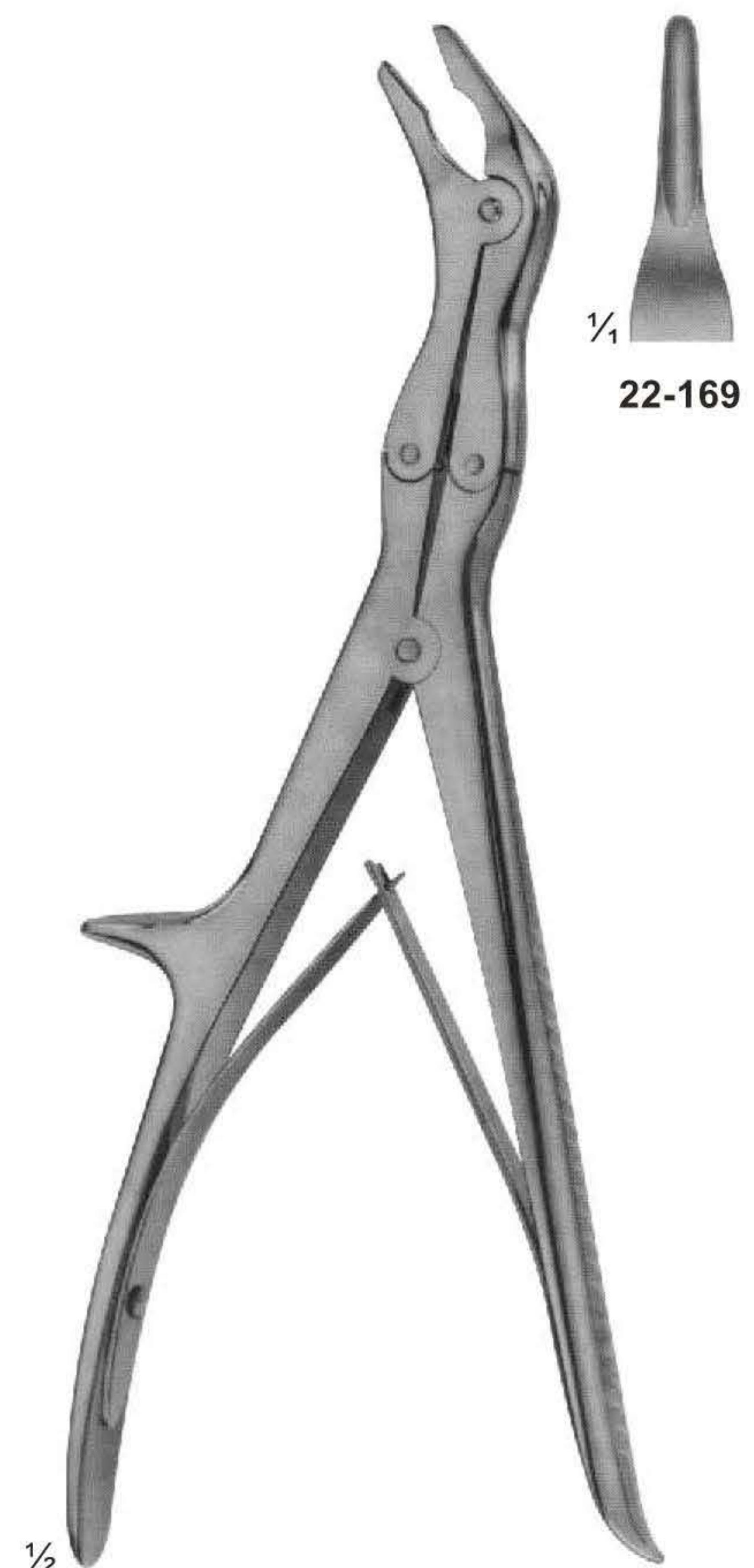

UG-1916
22-169 - 170
ECHLIN
230 mm

Bone Rongeurs



UG-1918
STILLE
235 mm



UG-1919
LEKSELL-STILLE
240mm



UG-1920
STILLE-RUSKIN
240mm

Bone Rongeurs

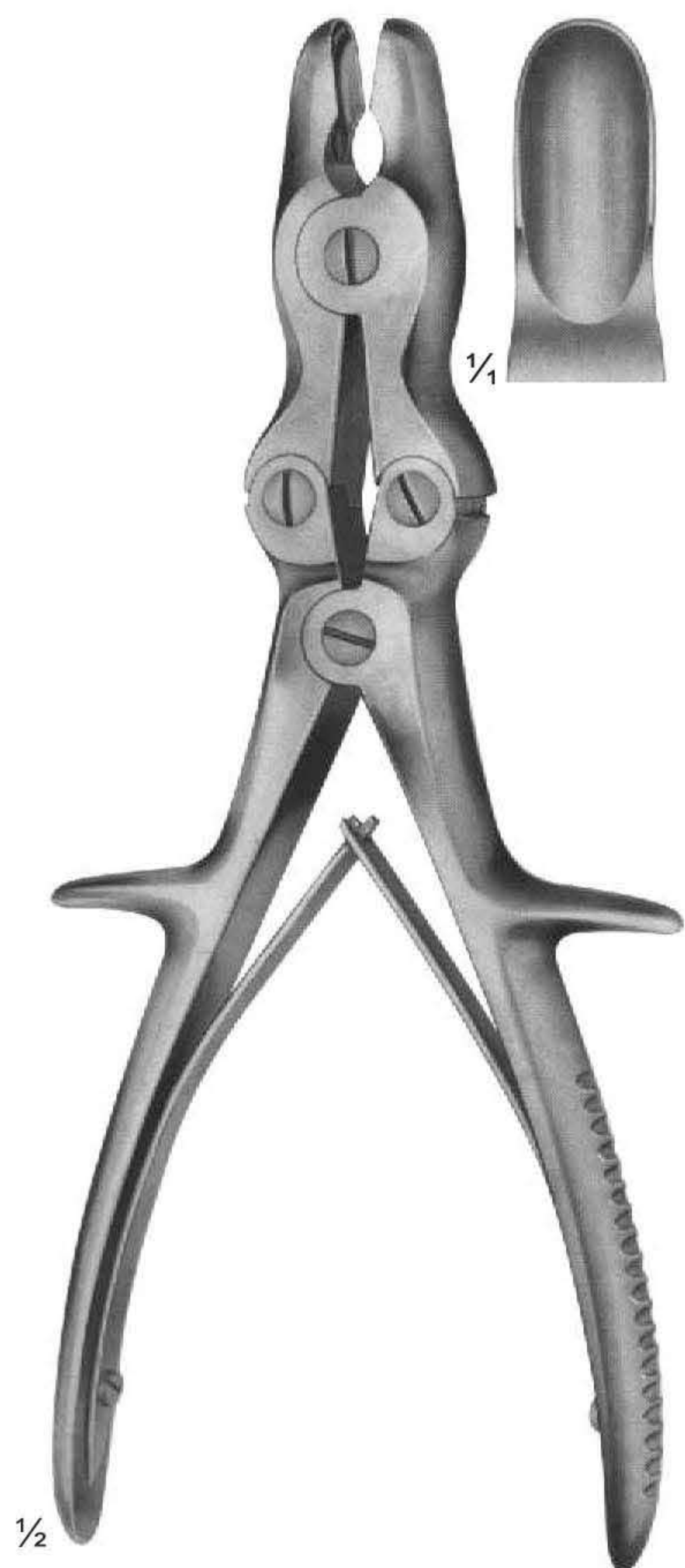

UG-1921
LURE-STILLE
225 mm

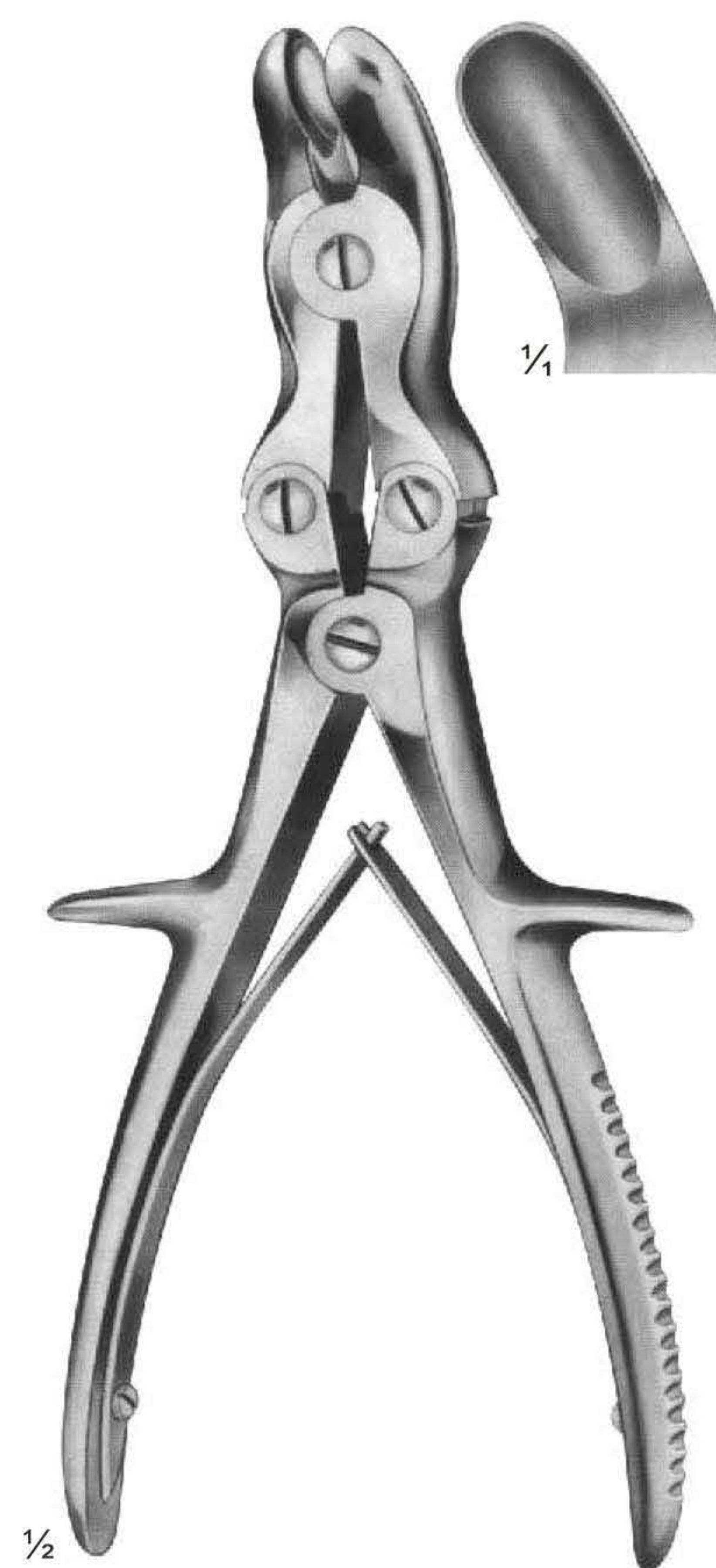

UG-1922
LURE-STILLE
225 mm

Bone Cutting Forceps



UG-1925
STAMM
150 mm

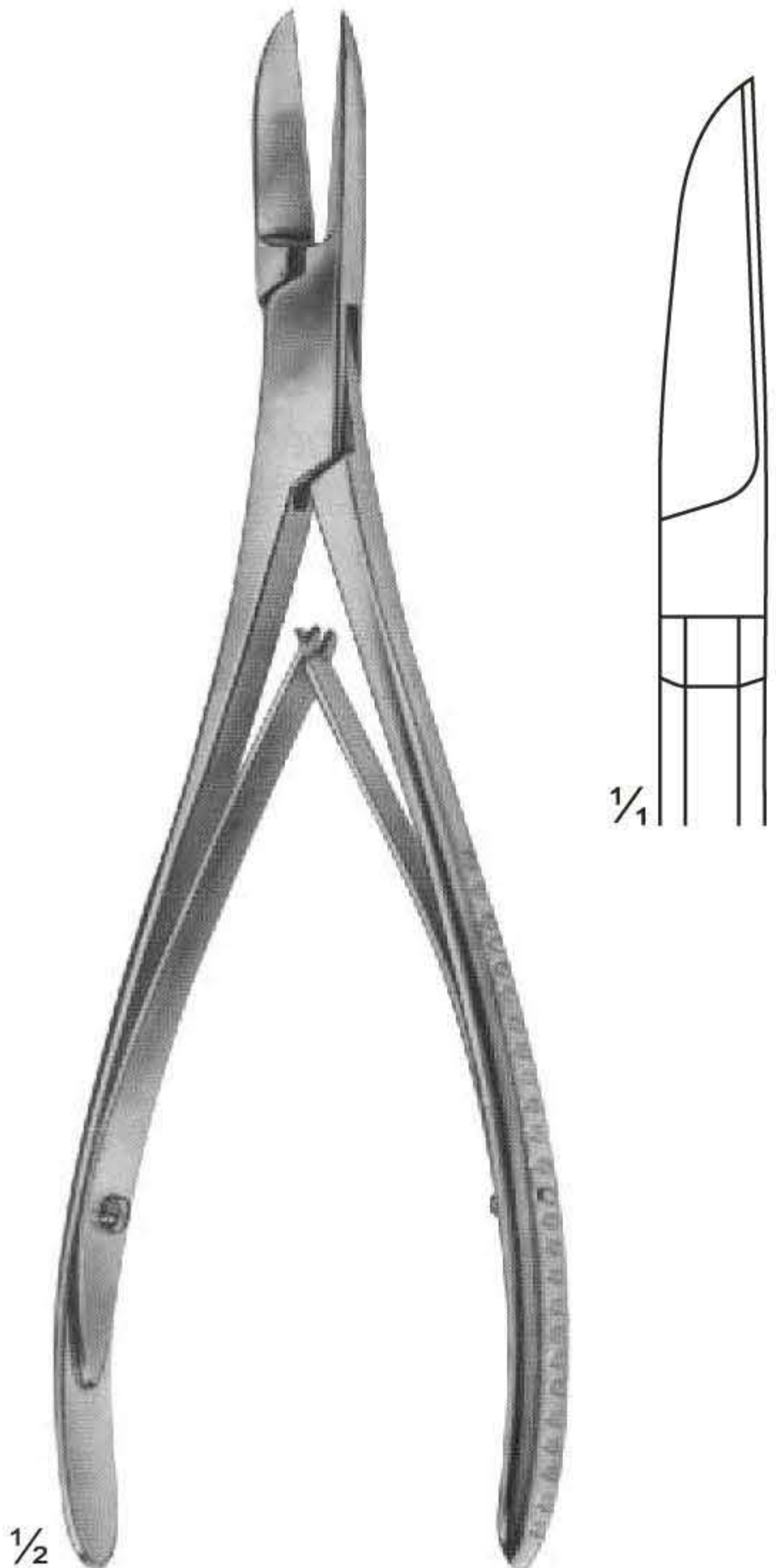

UG-1926
KAZANJIAN
185 mm



UG-1927
LISTON

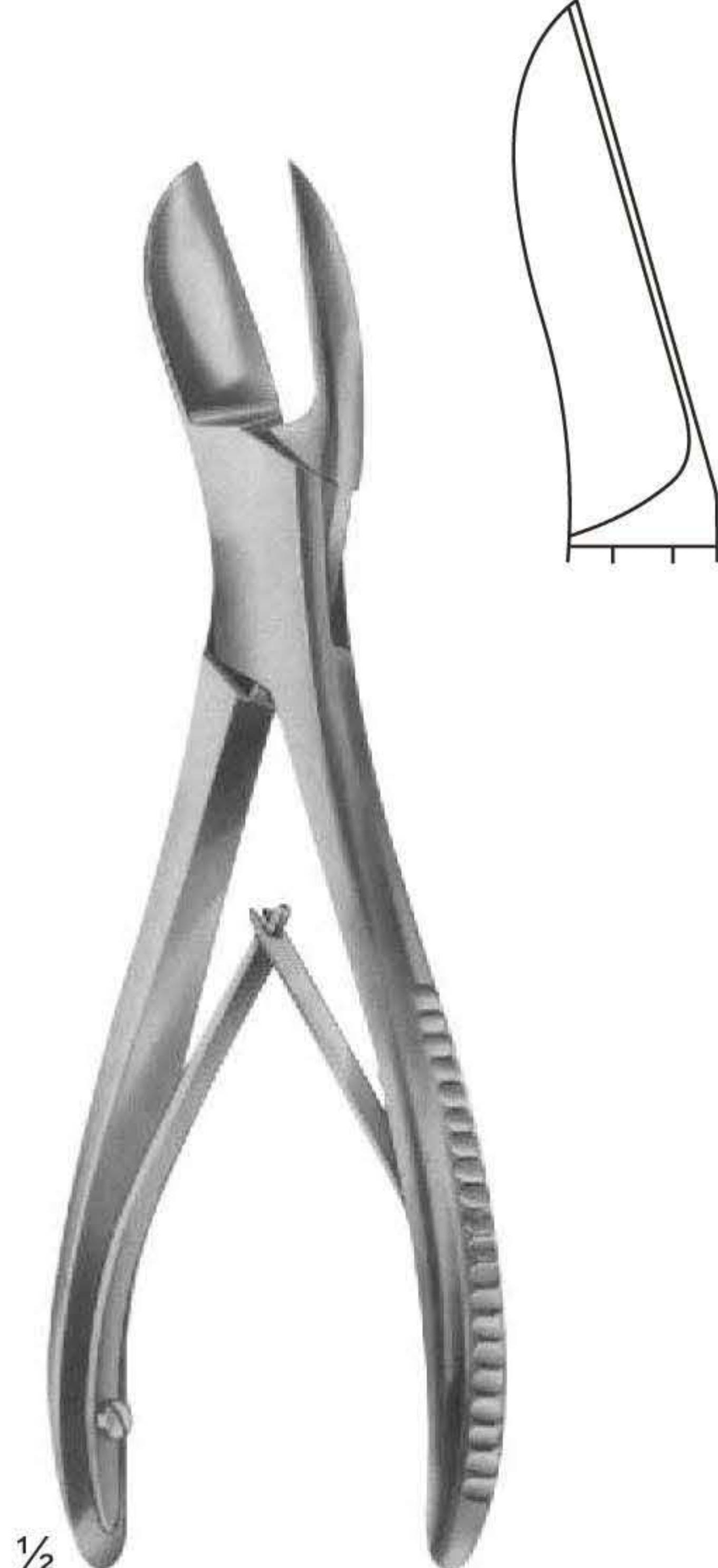

UG-1930
LISTON

Bone Cutting Forceps

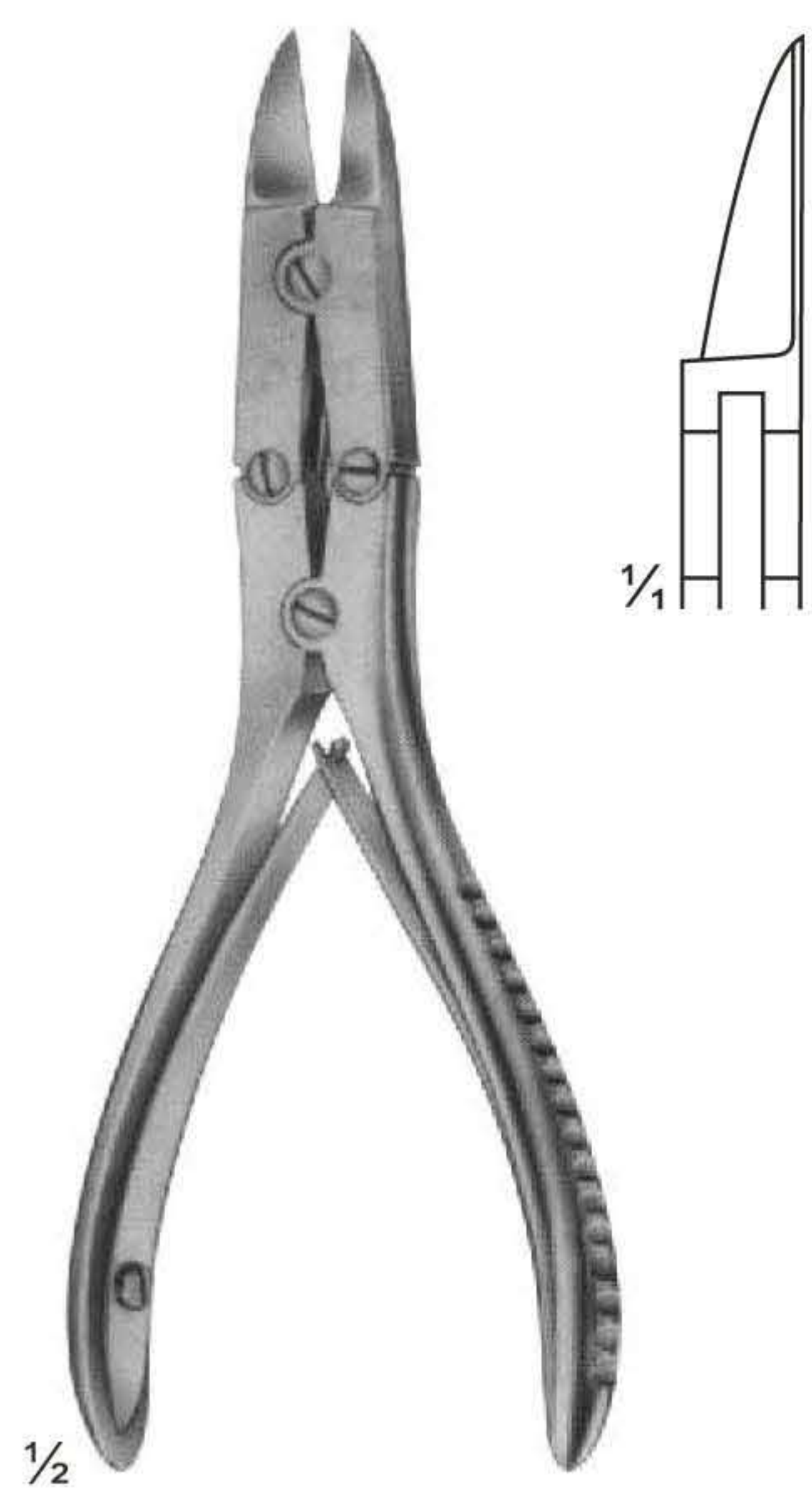

UG-1931
BOHLER
145 mm

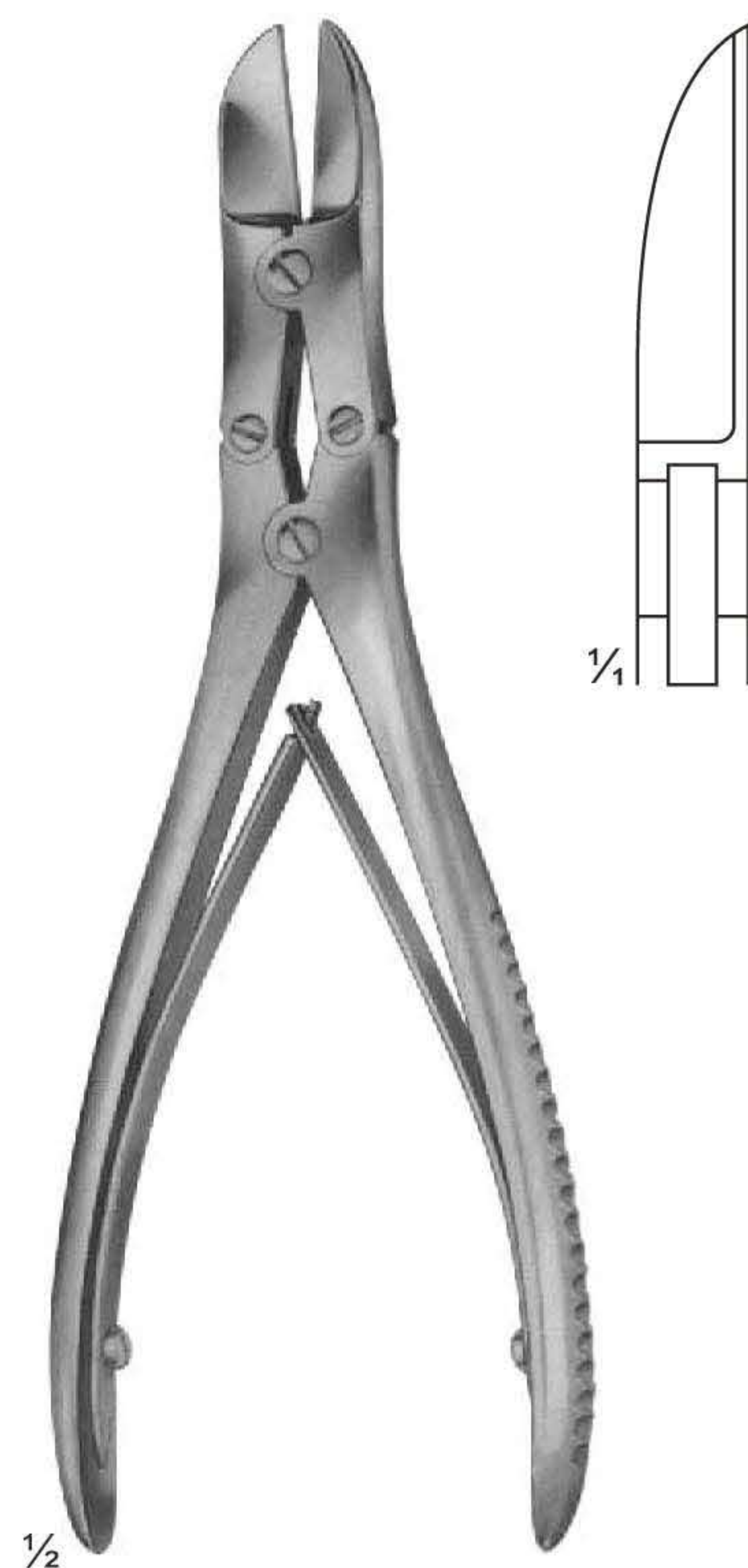

UG-1932
RUSKIN-LISTON
190 mm

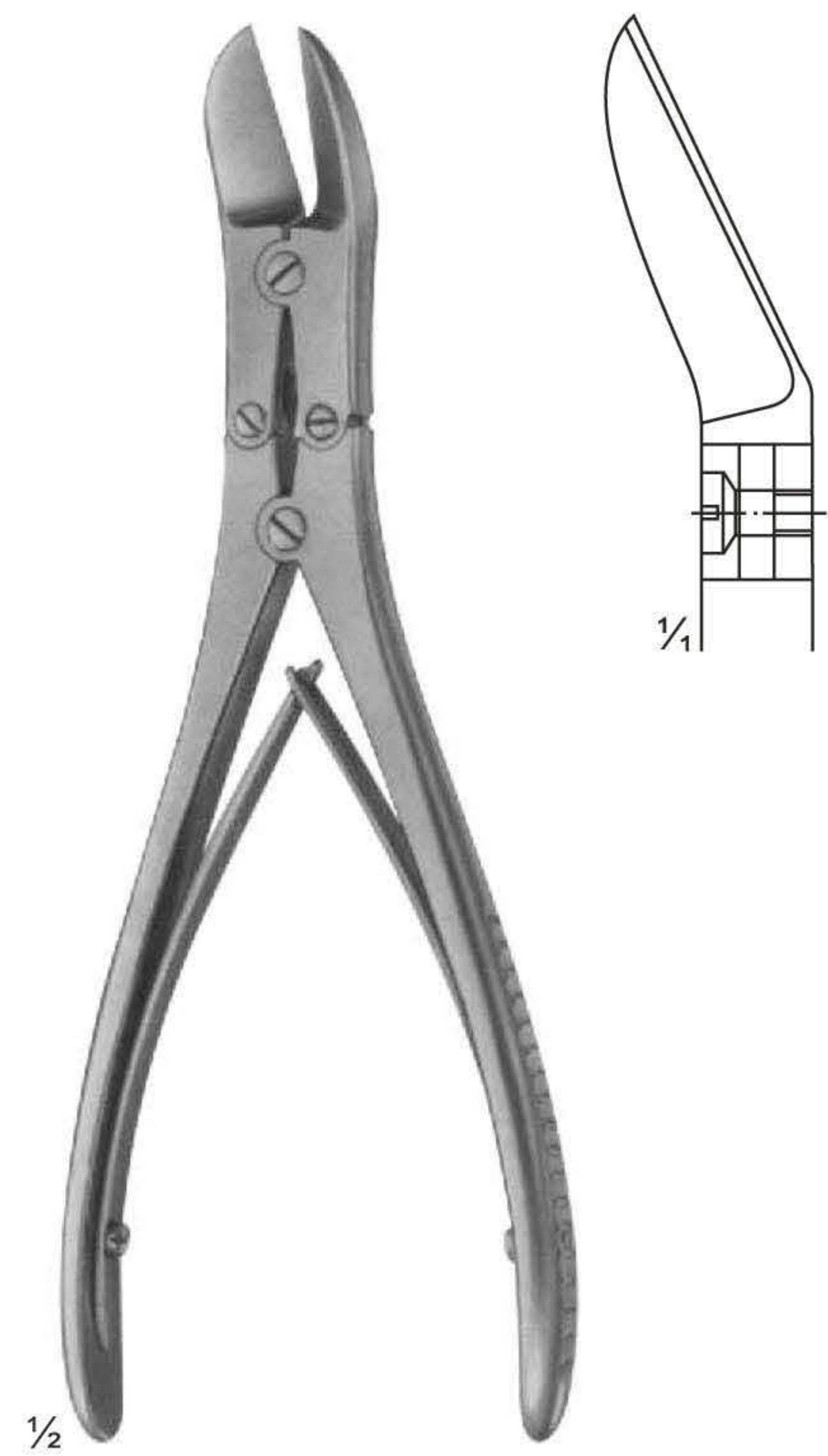

UG-1933
RUSKIN-LISTON
190 mm

Bone Cutting Forceps

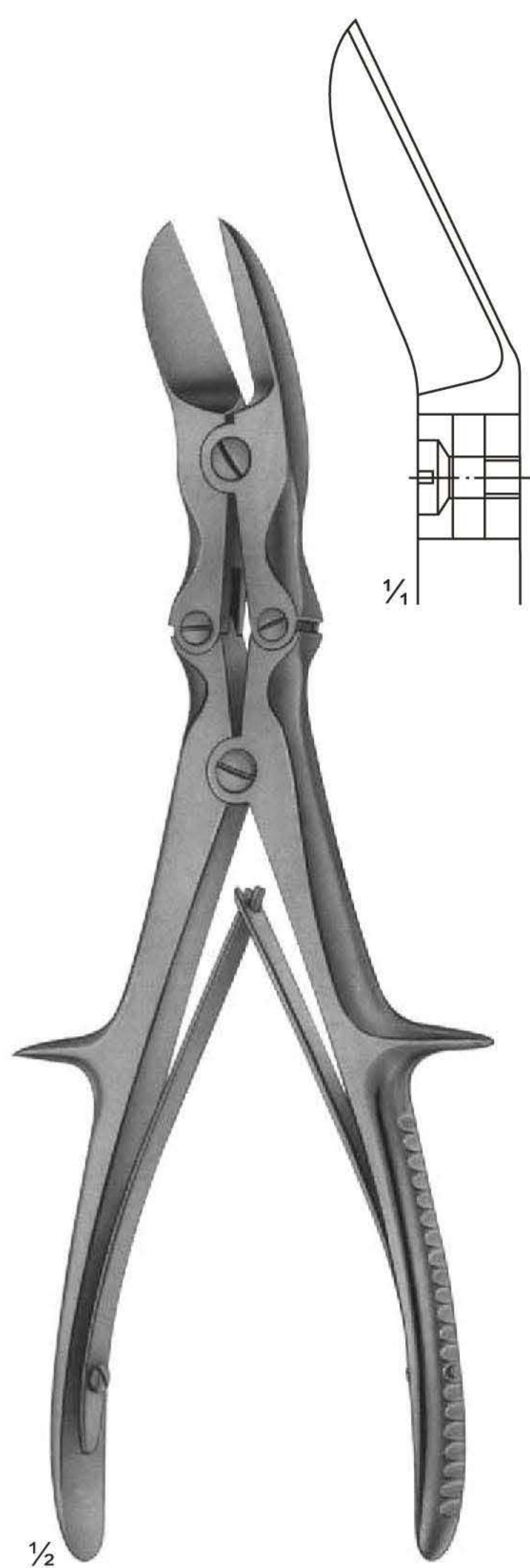

UG-1934
LISTON
curved on flat
240 mm

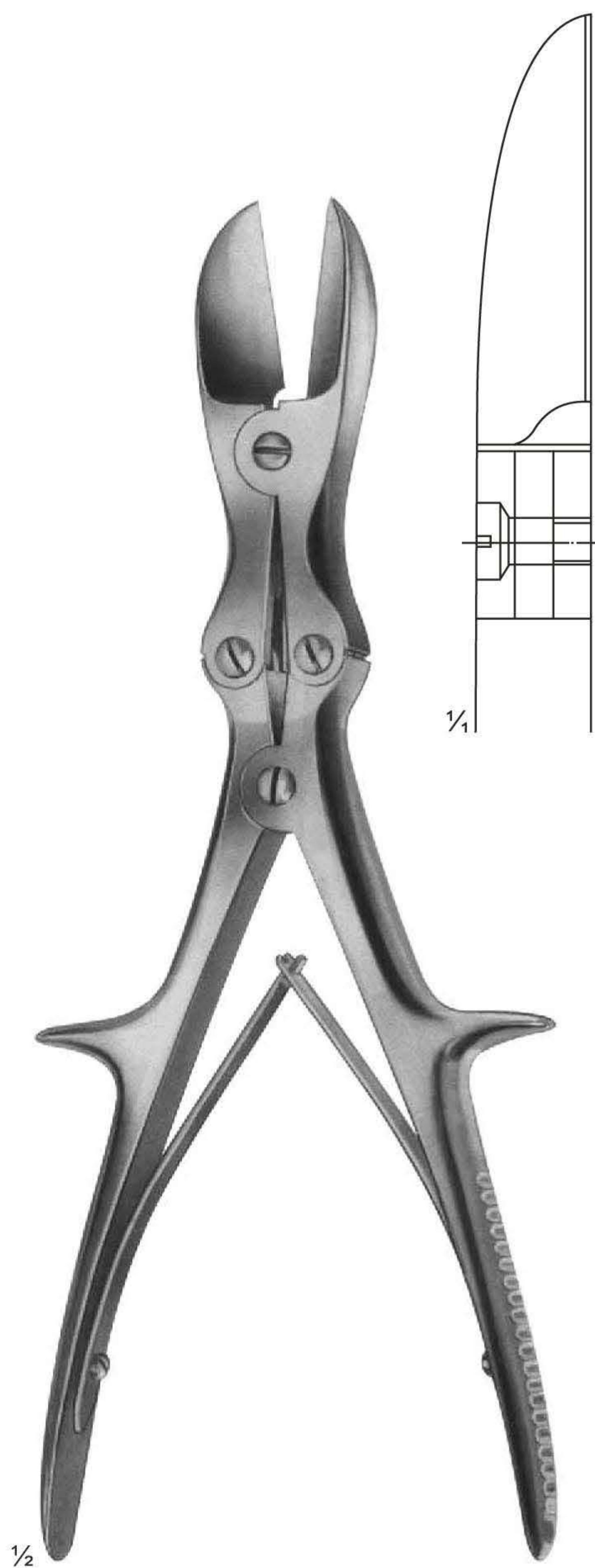

UG-1936
LISTON
straight
280 mm

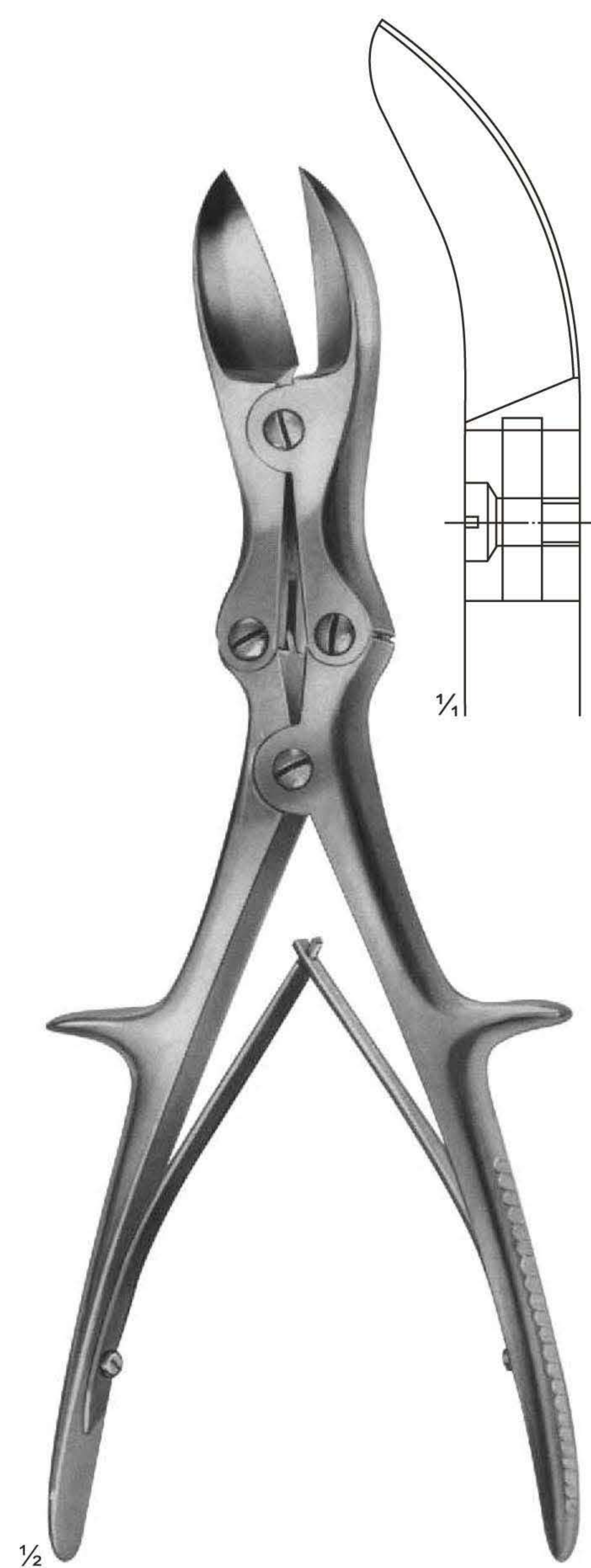

UG-1937
LISTON
curved on flat
280 mm

Bone Cutting Forceps

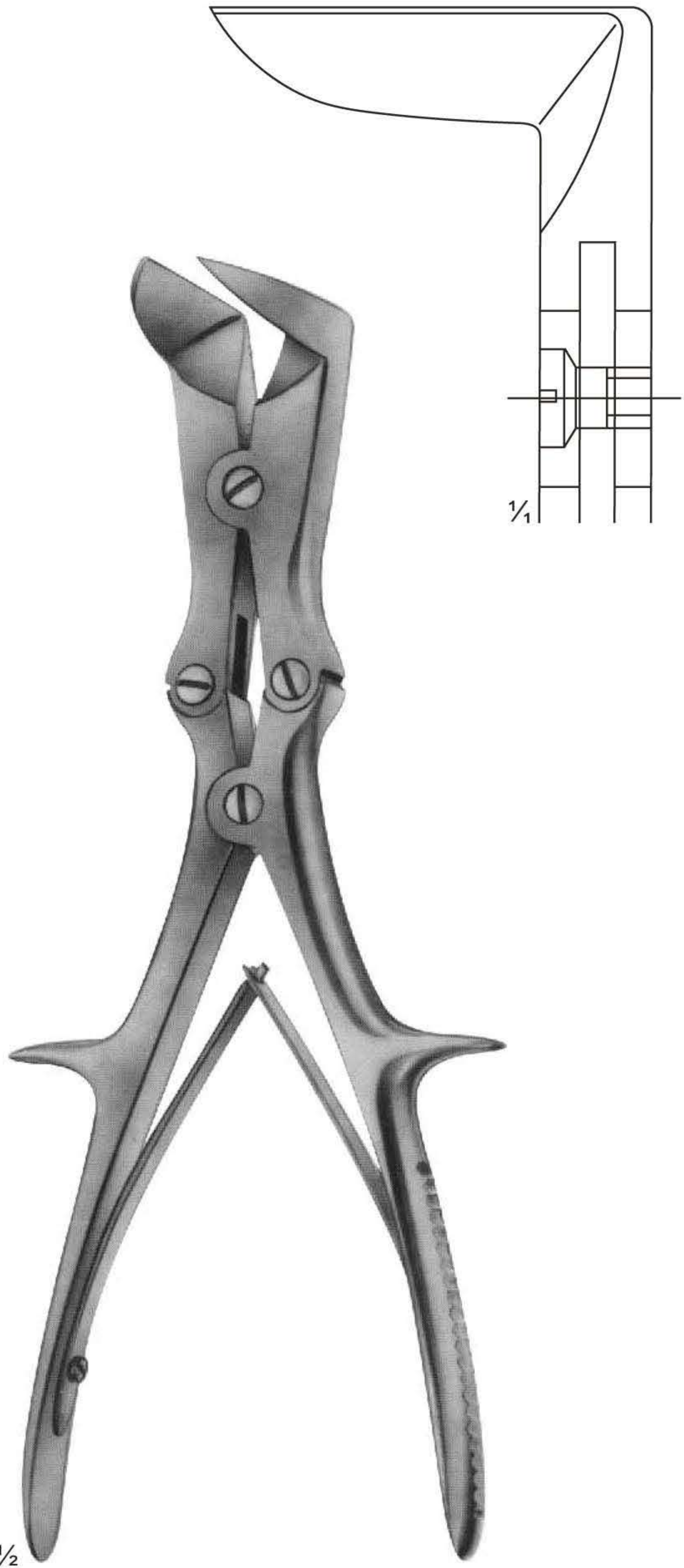

UG-1939
LISTON-STILLE
265 mm

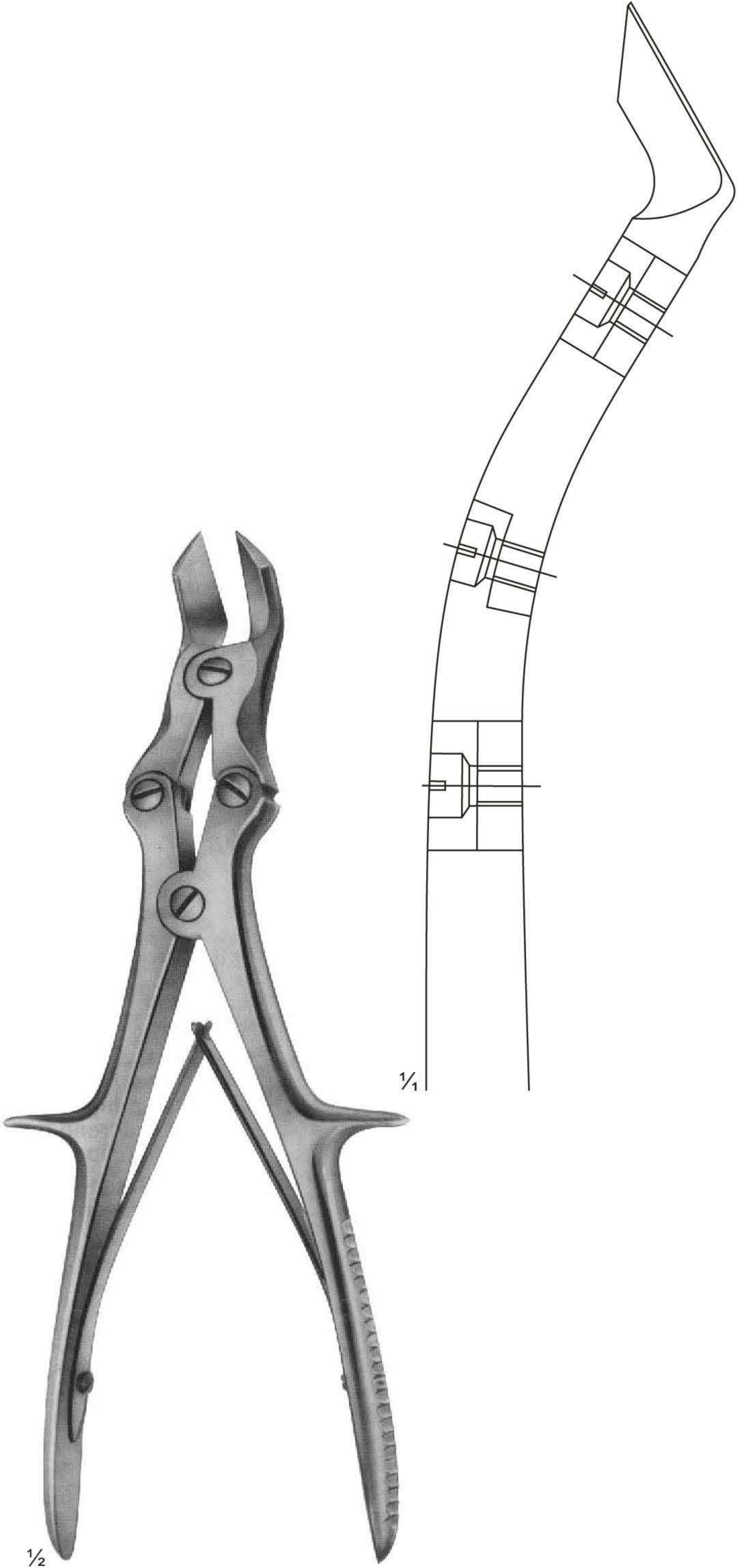

UG-1940
LISTON-KEY-HORSLEY
(TUDOR EDWARDS)
255 mm

Meniscus-and Cartilage Forceps

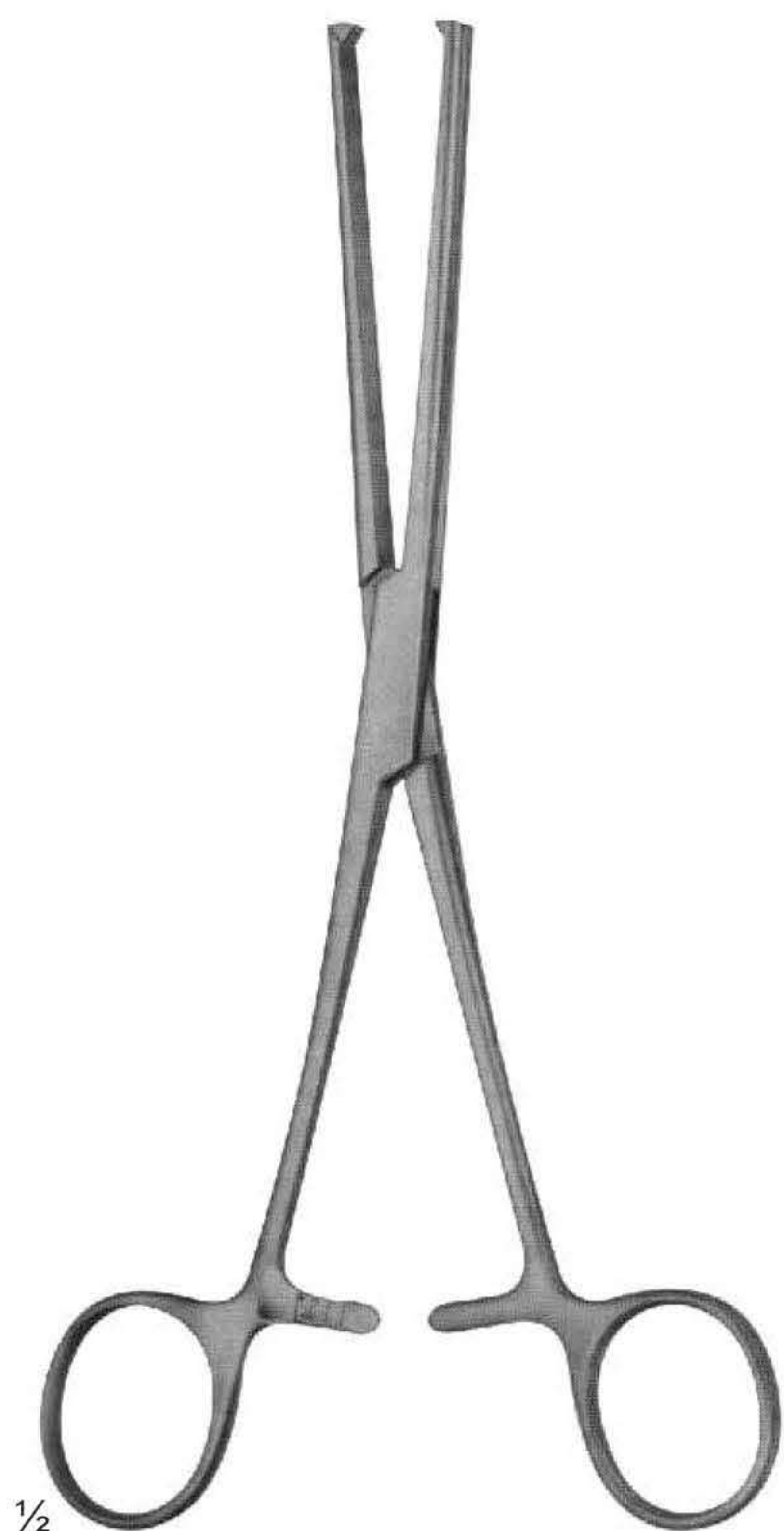

UG-1941
BIRCHER
200 mm

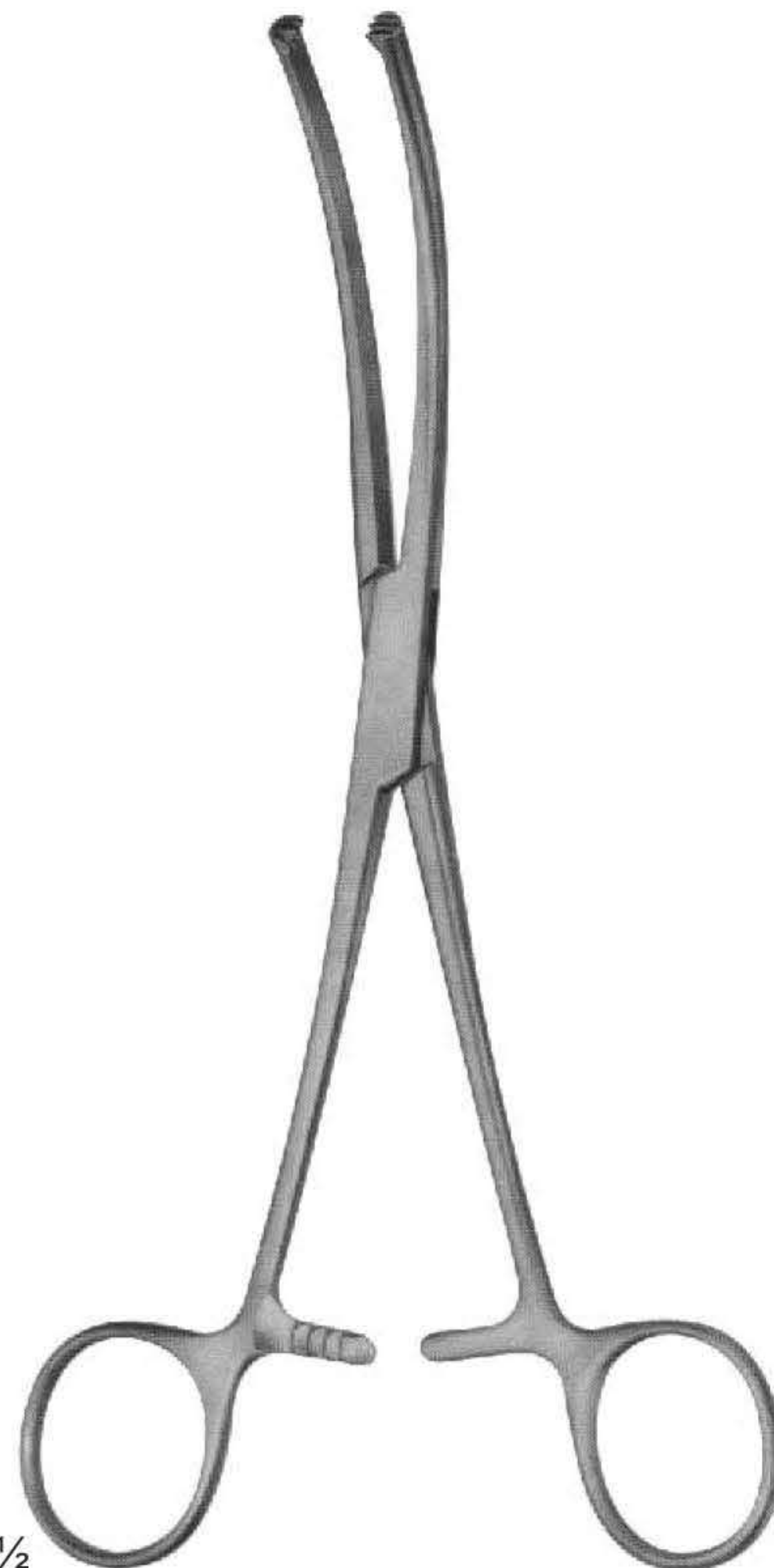

UG-1942
BIRCHER
200 mm

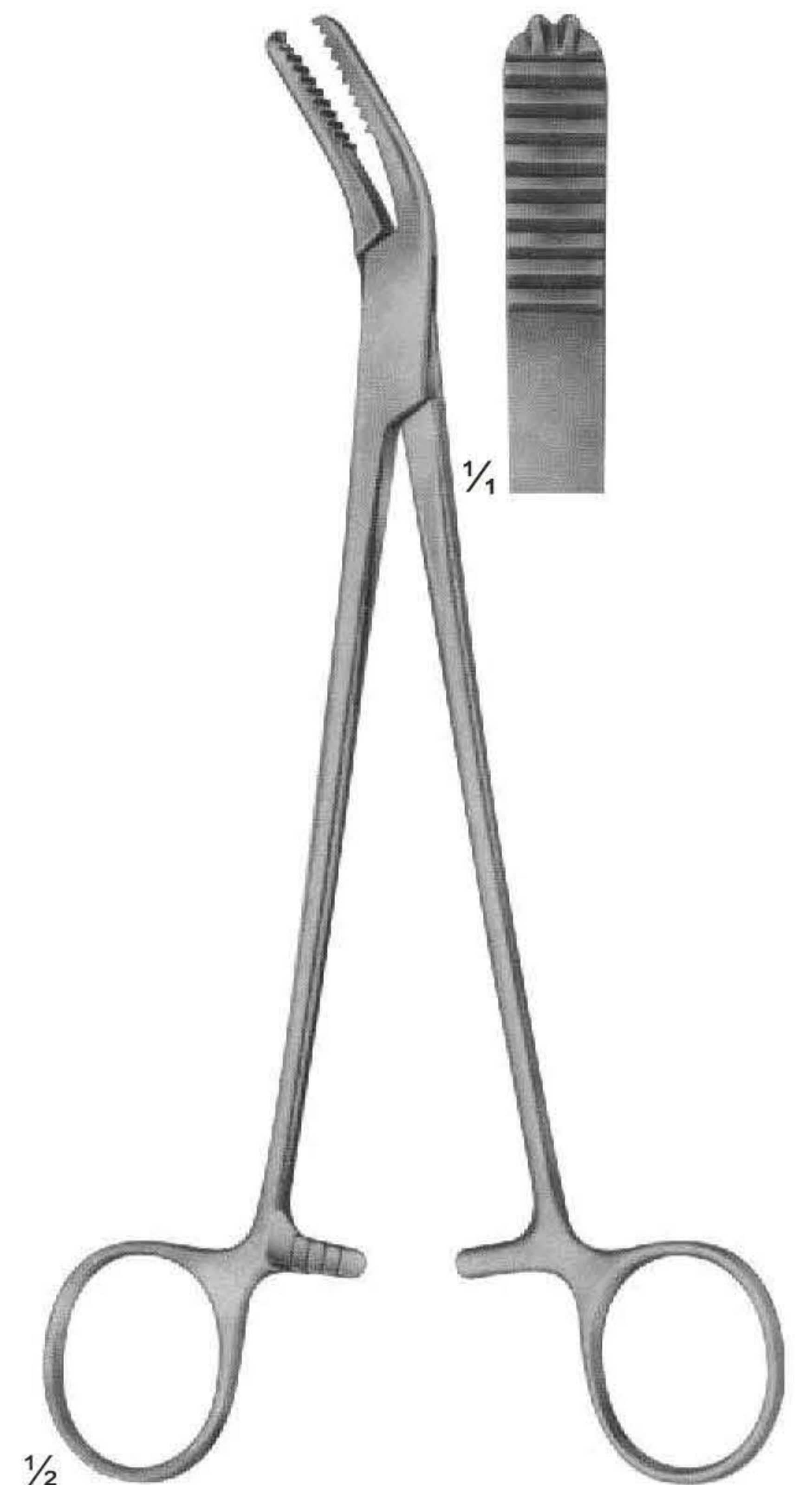

UG-1943
WELLER
200 mm

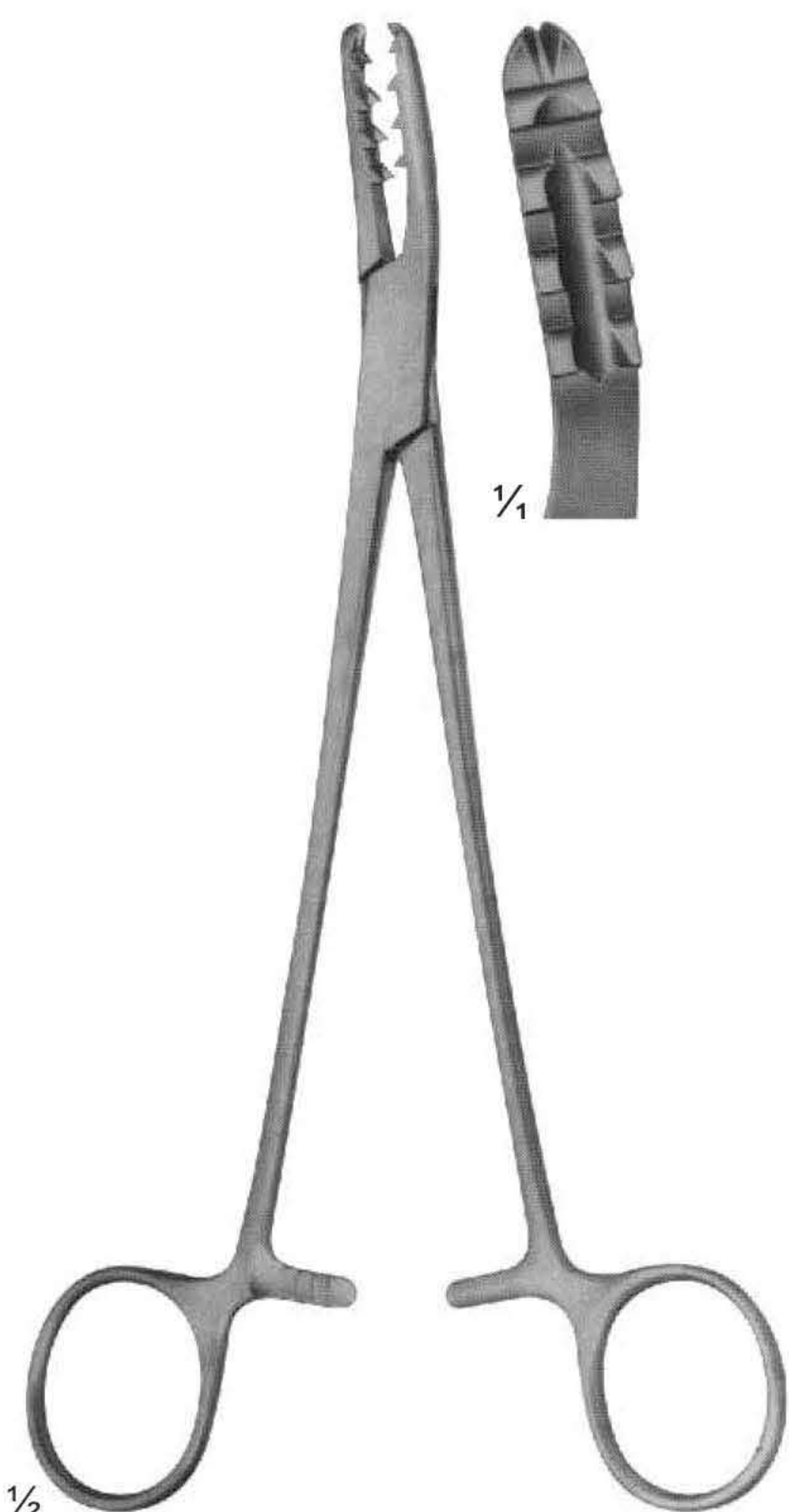

UG-1945
BIRCHER-GANSKE
200 mm

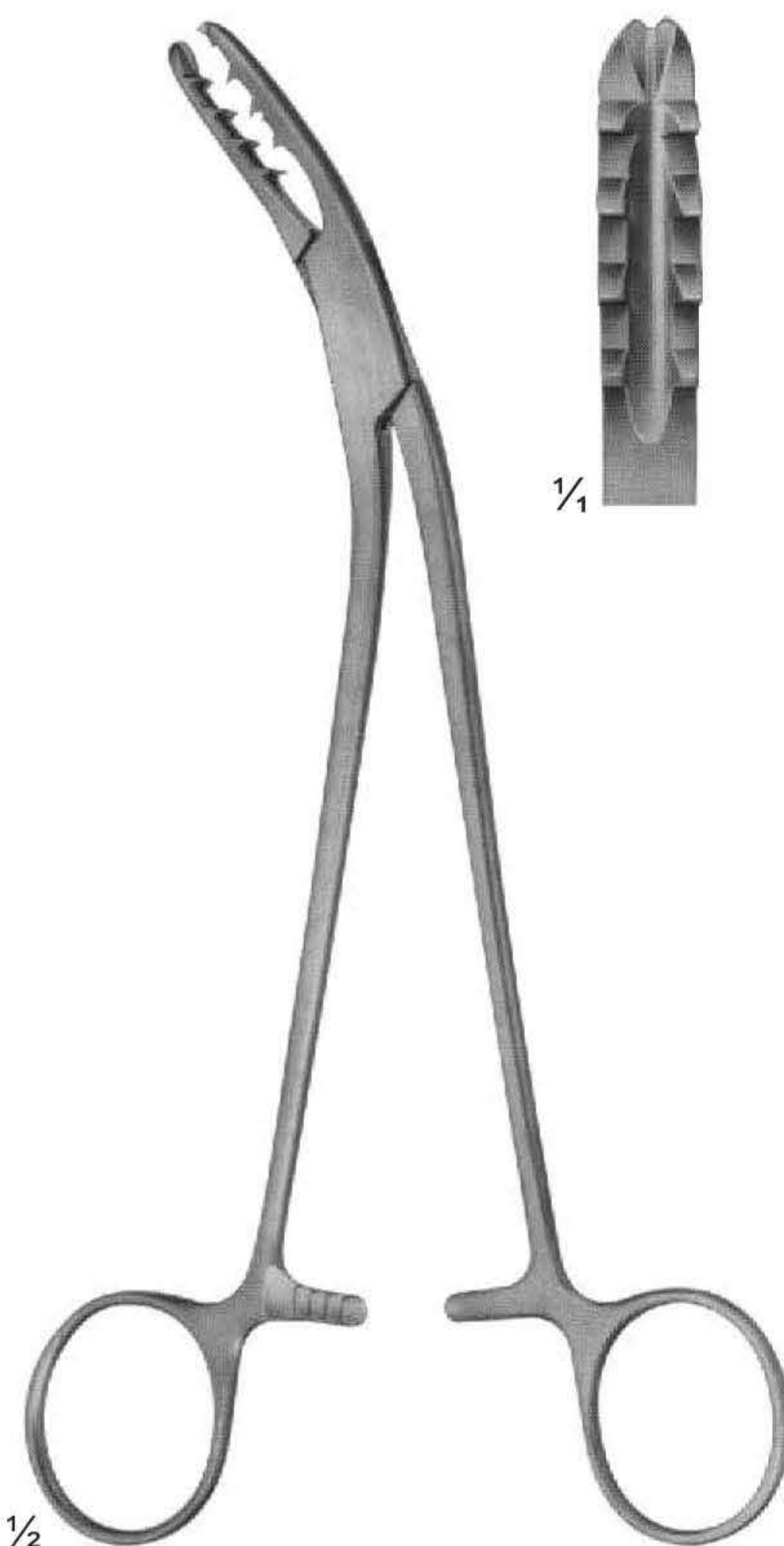

UG-1946
BIRCHER-GANSKE
200 mm



UG-1949
MARTIN
205 mm

Meniscus Knives

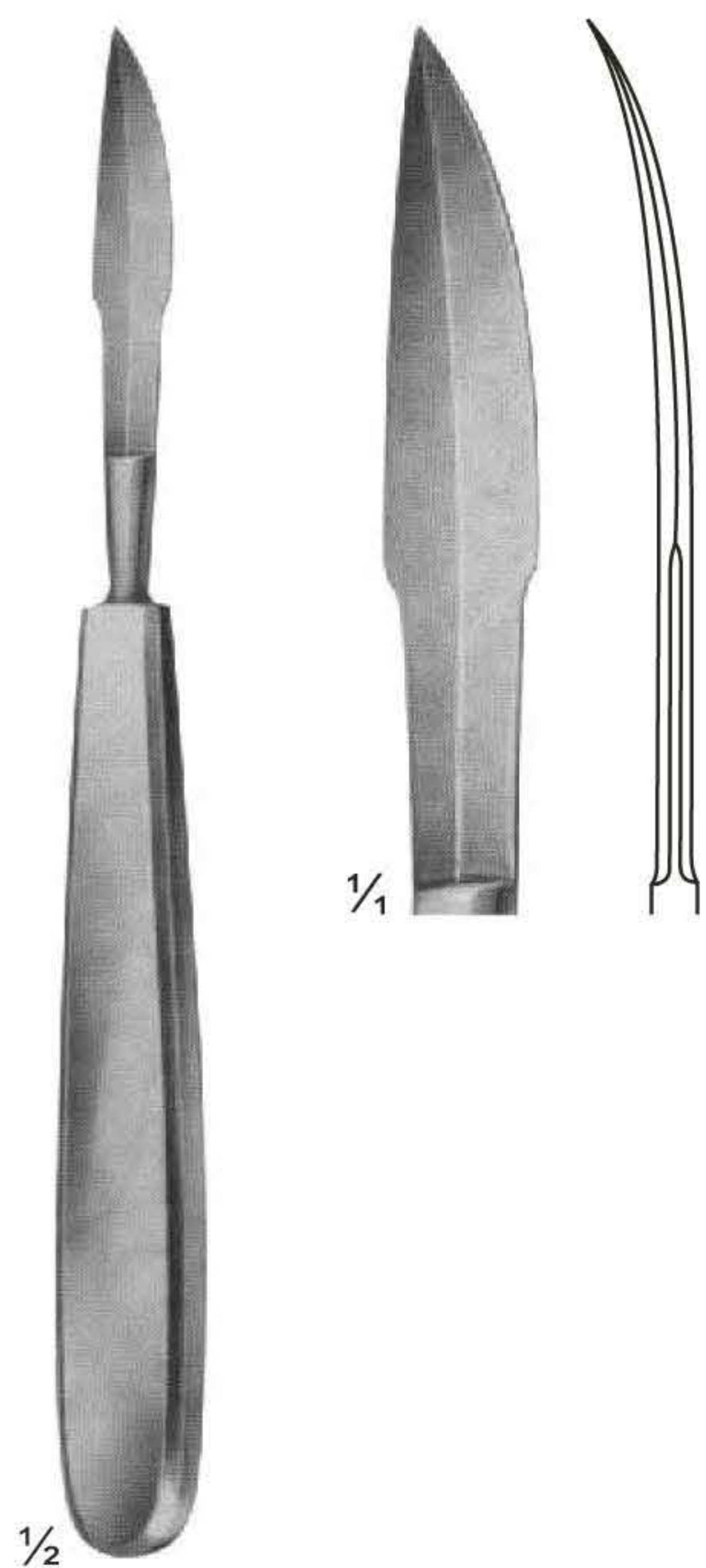

UG-1951
170 mm

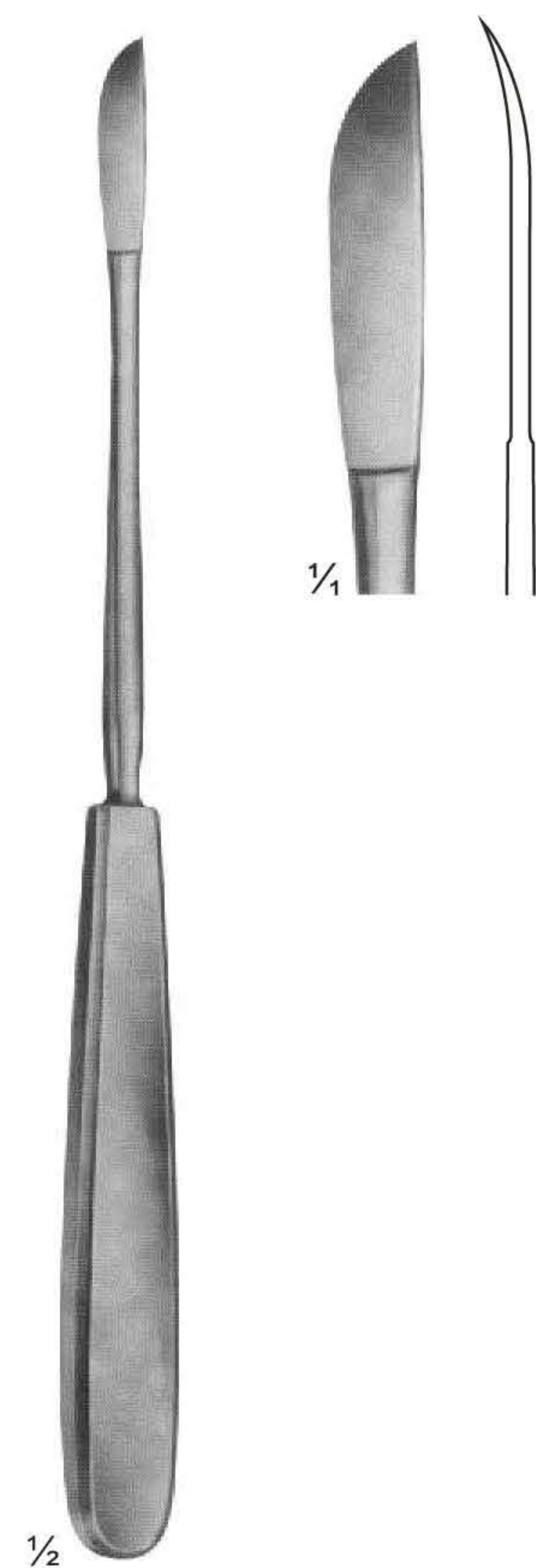

UG-1952
NEFF
215 mm

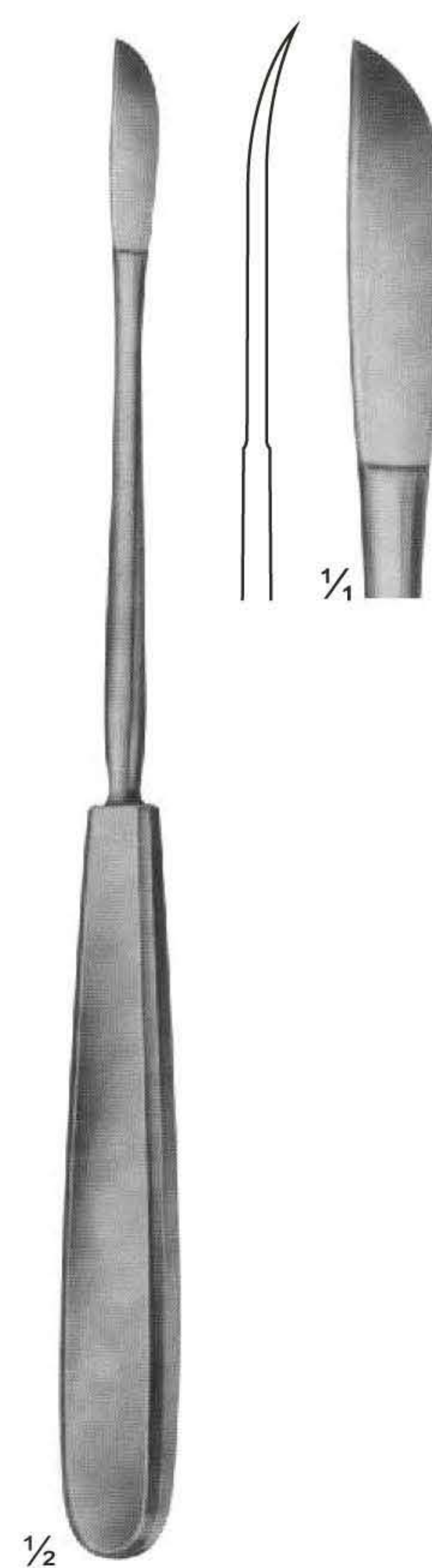

UG-1953
NEFF
215 mm

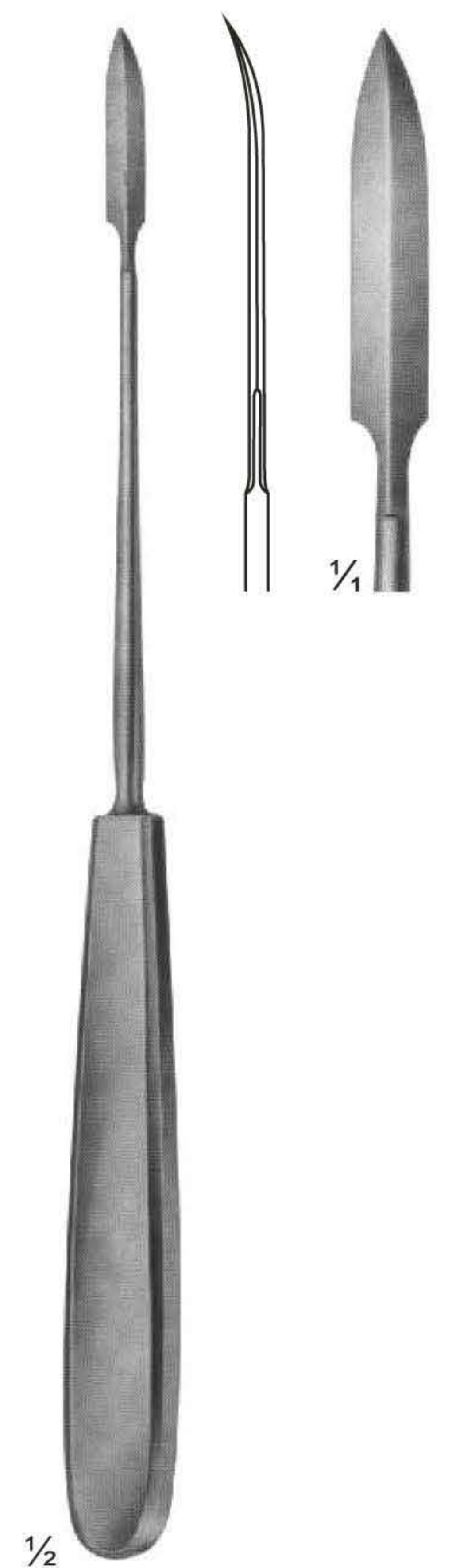

UG-1954
WAGNER
215 mm

Meniscus Knives

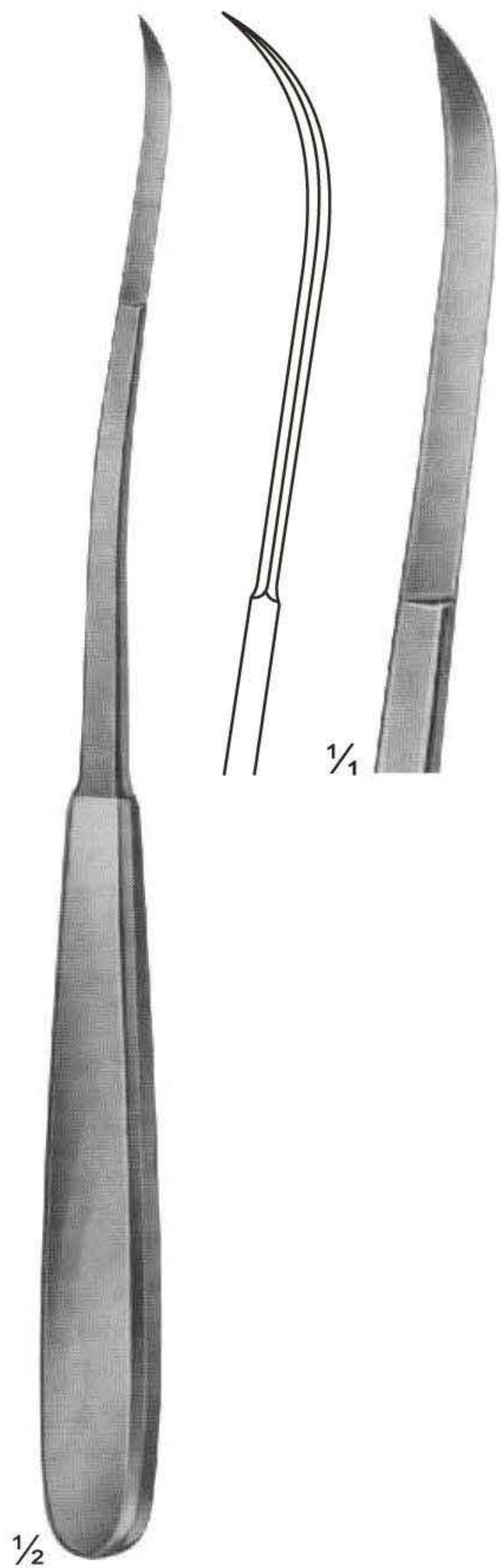

UG-1956
SALENIUS
220 mm

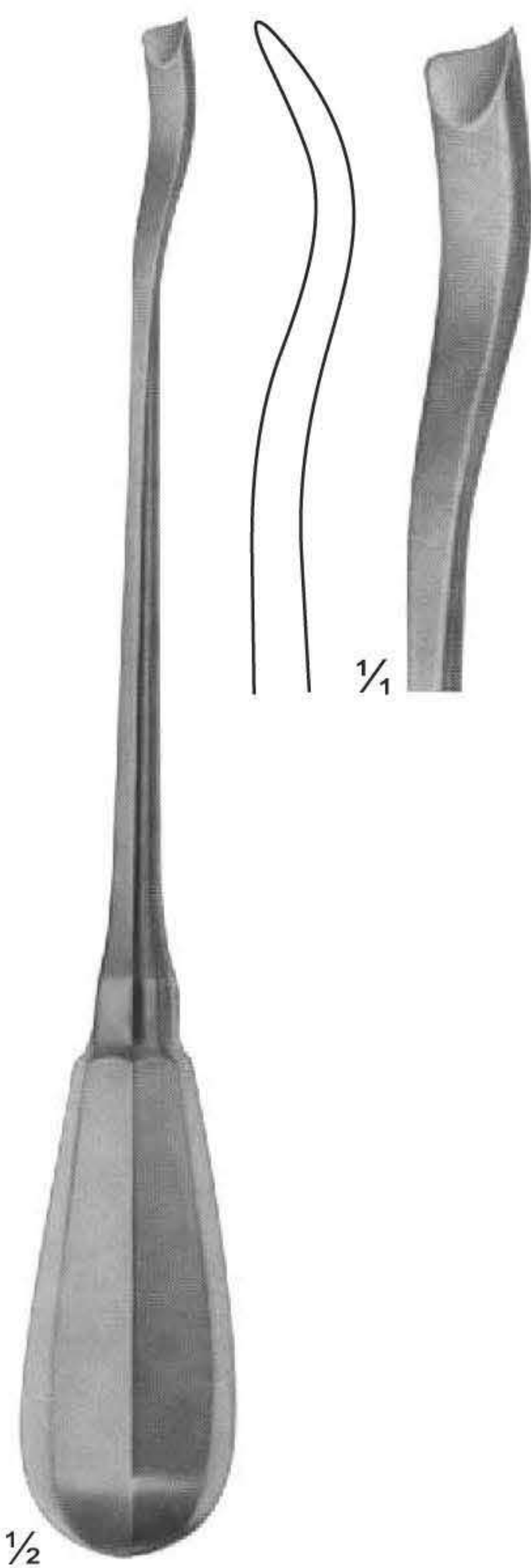

UG-1957
CHNAD.MODELL
200 mm

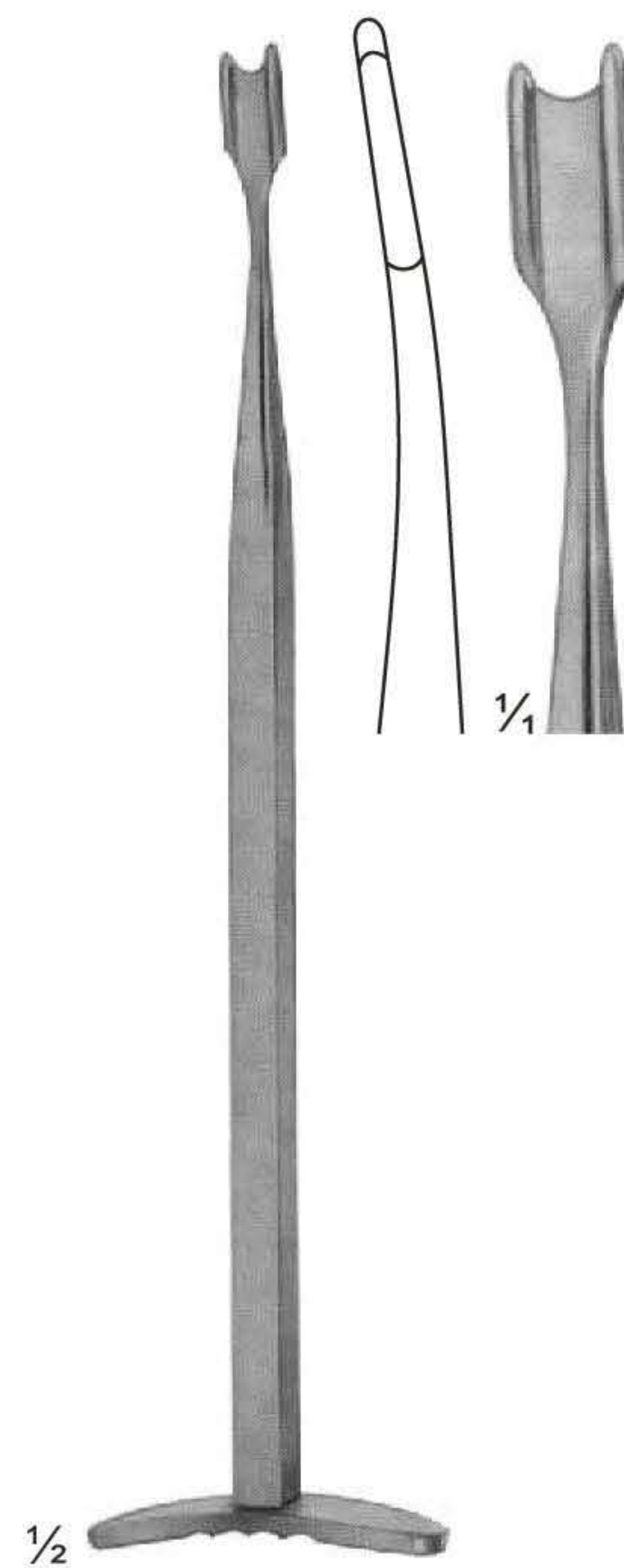

UG-1959
SMILLIE
170 mm

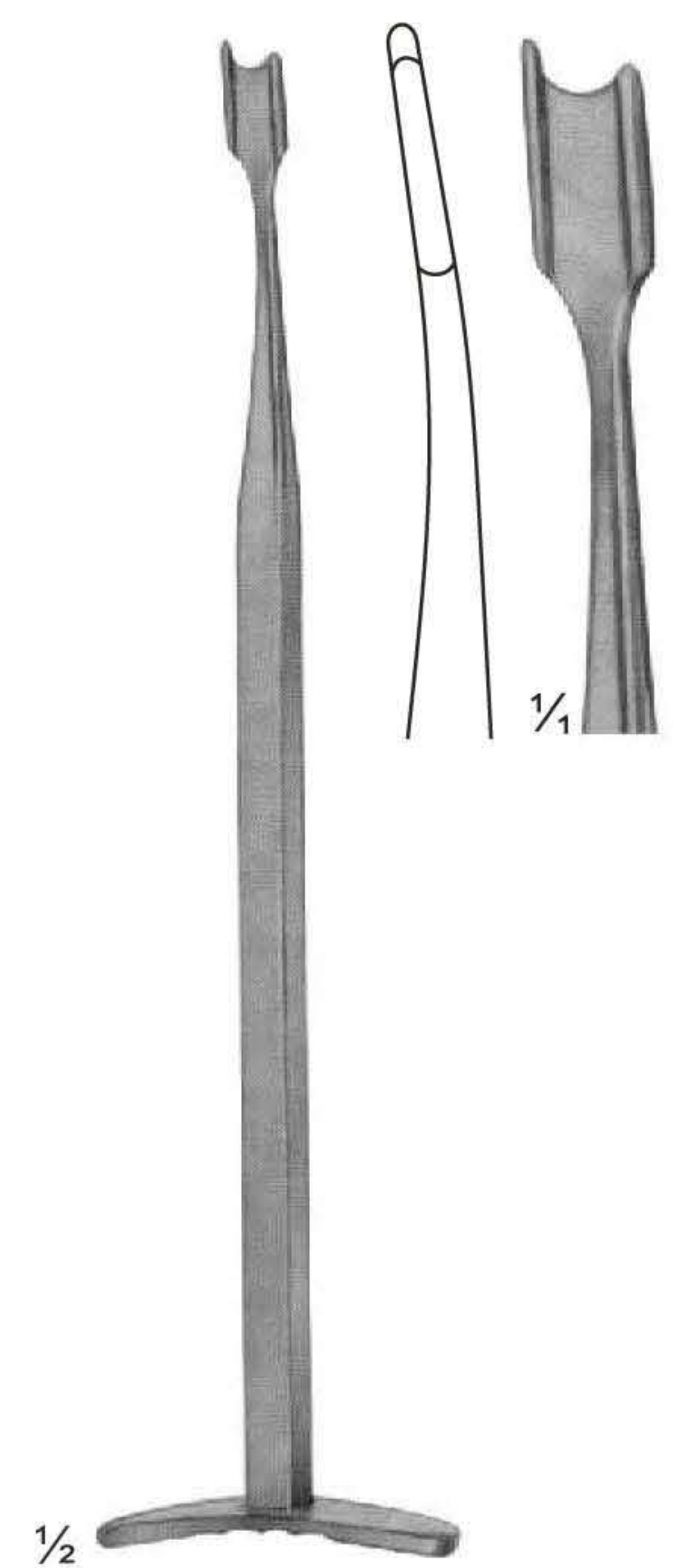

UG-1960
SMILLIE
170 mm

Wire Extension

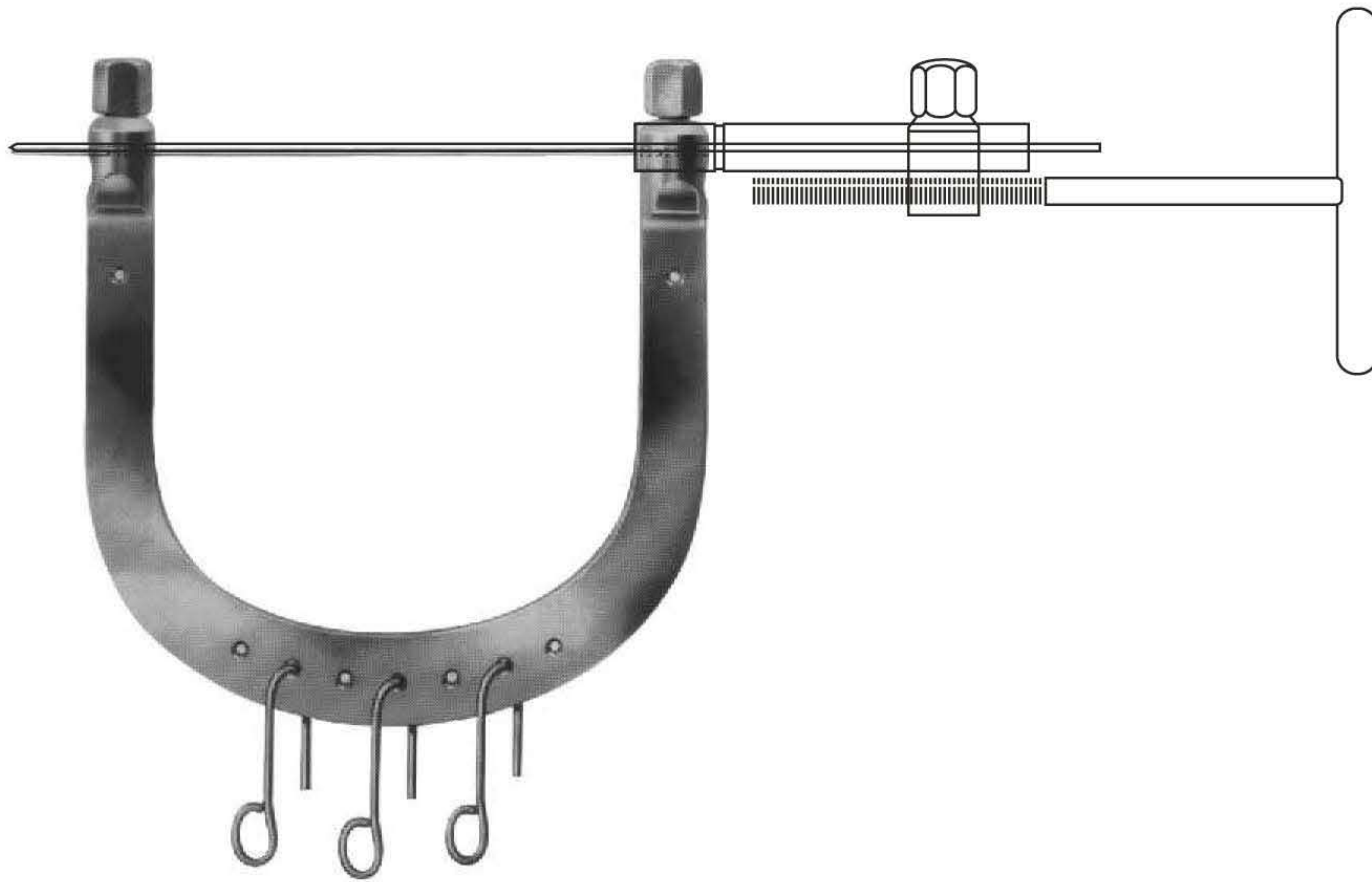

UG-1738
KIRSCHNER
Wire traction bows,
to be used with
KIRSCHNER-wires
up to 2.5 mm diam.,
With 3 hooks,
stainless steel



UG-1739
Wrench, double - ended,
for wire traction bows



UG-1740
Wire tightener, with
clamping jaws



UG-1741
Traction hook only,
large size



UG-1742
Traction hook only,
small size



UG-1743
Fixation clamp, to secure clamping
jaws of stainless steel

Wire Extension

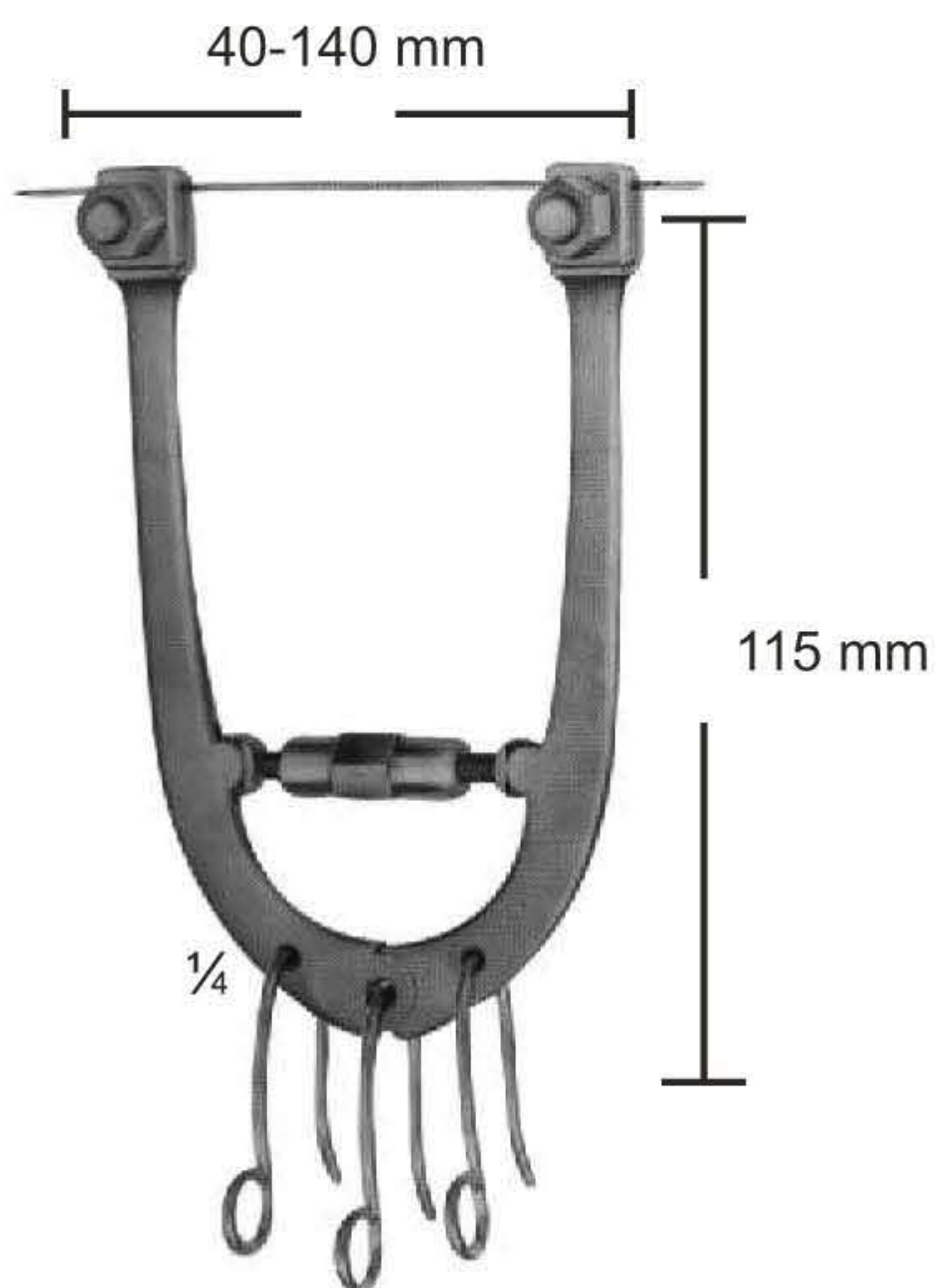

UG-1745
Wire traction bow, adjustable,
with 3 hooks, small size

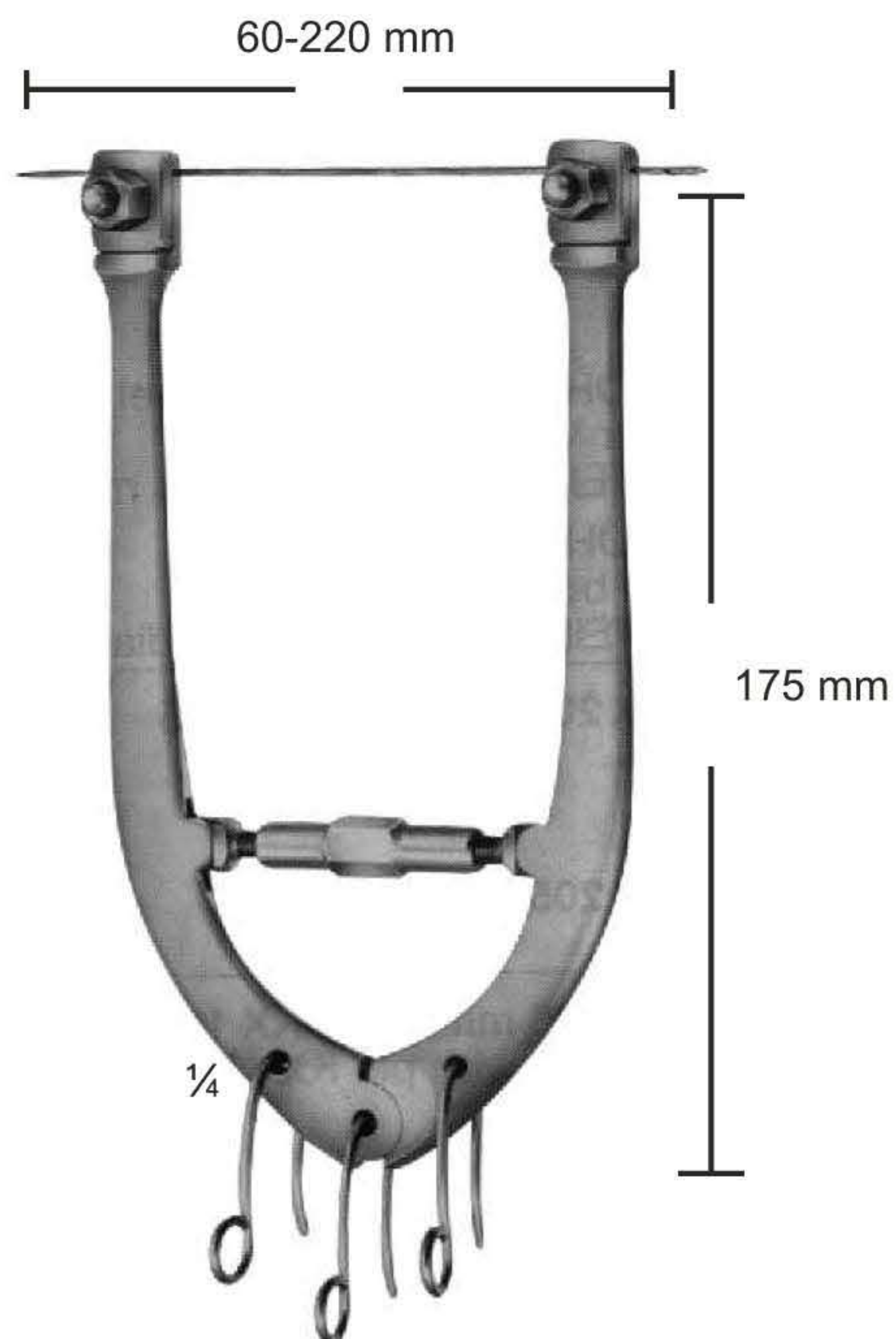

UG-1746
Wire traction bow, adjustable,
with 3 hooks, large size

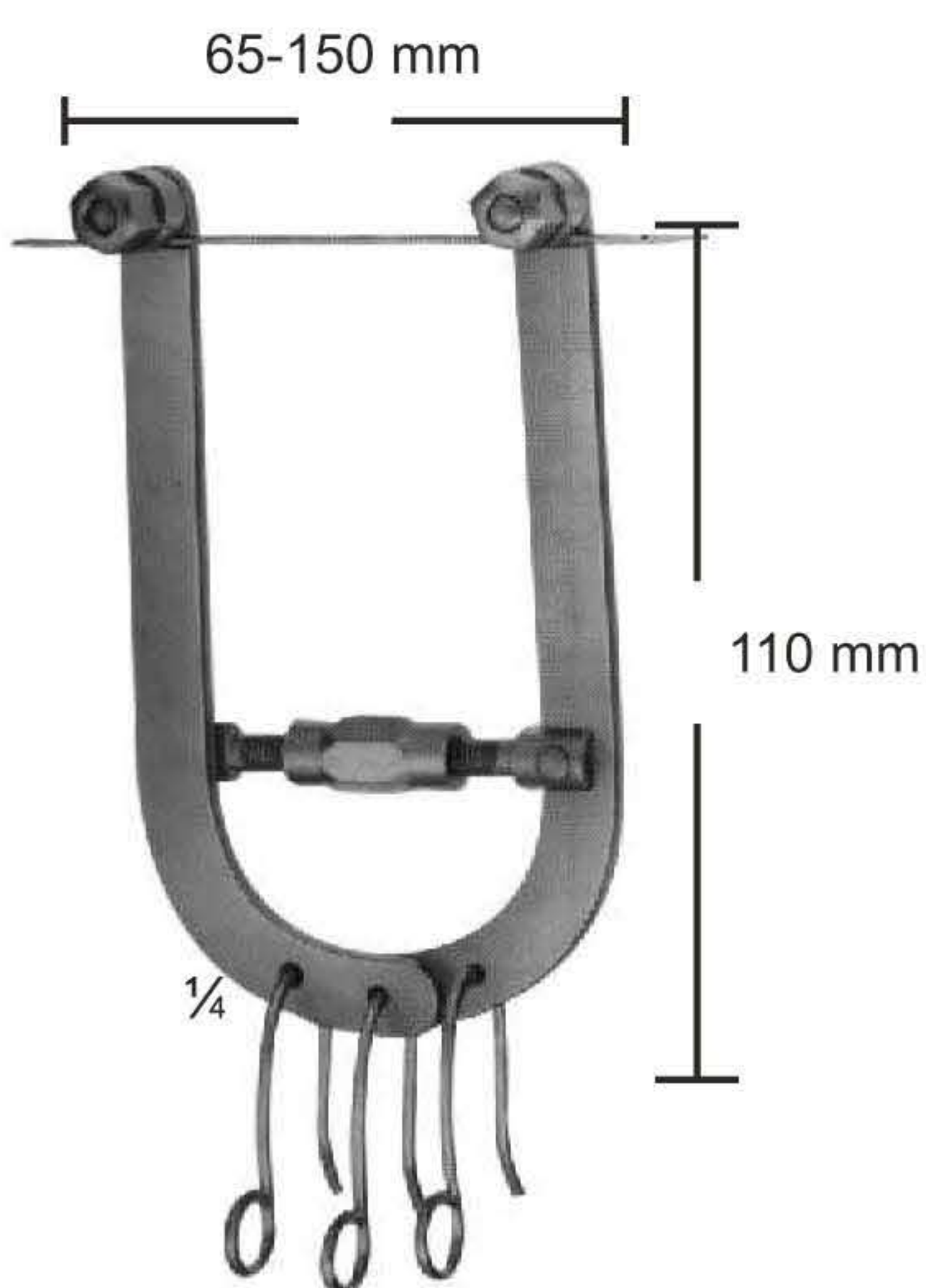

UG-1747
Wire traction bow, adjustable,
with 3 hooks, large size for
elbow and calcaneus, for
adolescents



UG-1748
KIRSCHNER
Wire traction bow, modified
adjustable in with width, holds wire
securely, with 1 hook



UG-1749
Fixation disc, slotted



UG-1751
Fixation disc, slotted



UG-1750
idem, aluminum, transparent
to X-rays



UG-1752
Screw driver, for above
fixations discs

Traction Bows, Distractor

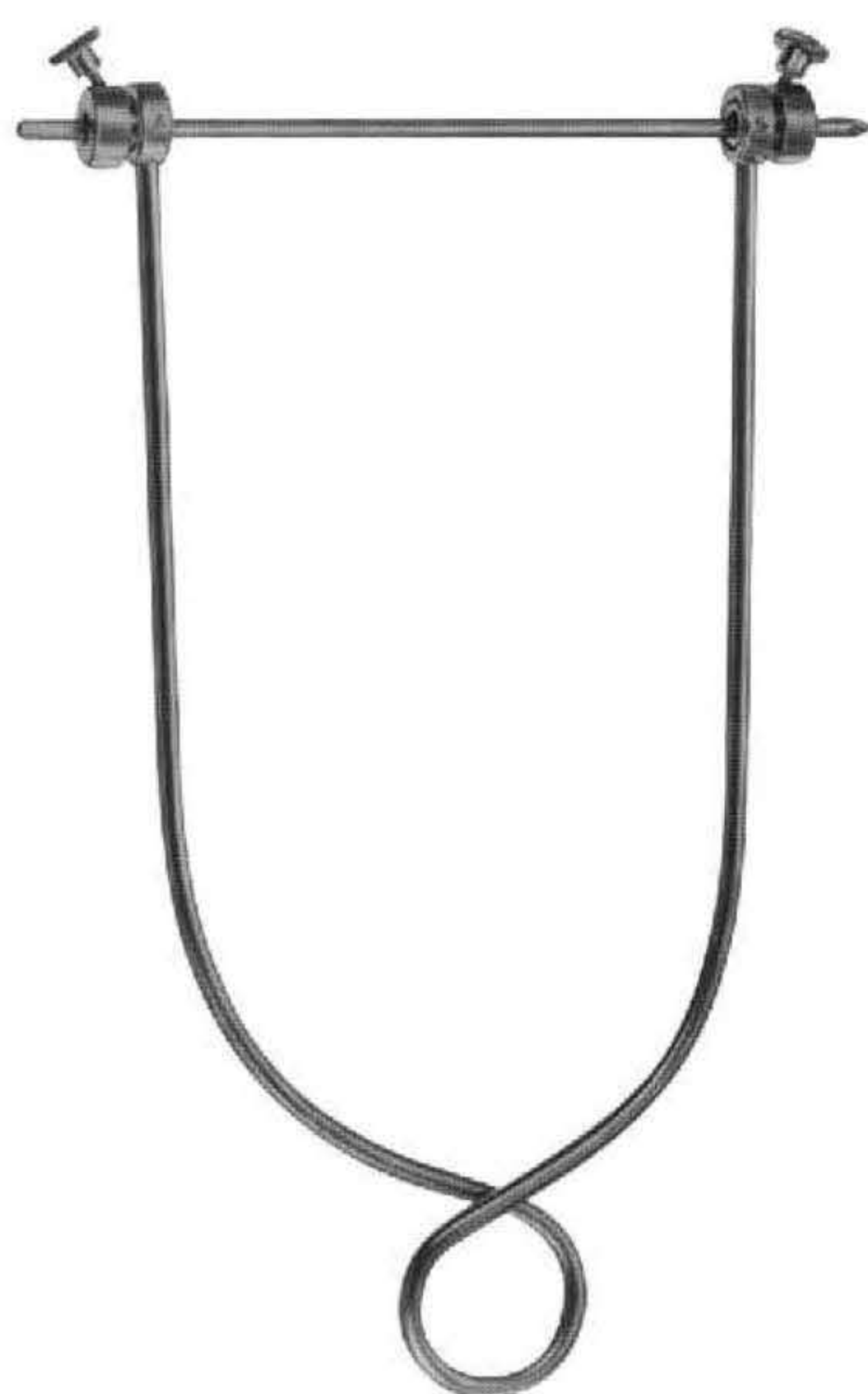

UG-1755
Screw driver, for above
fixations discs



UG-1760
SCHWARZ
Traction bow for fingers,
to be used with KIRSCHNER-
wire up to 1.6 mm diam.

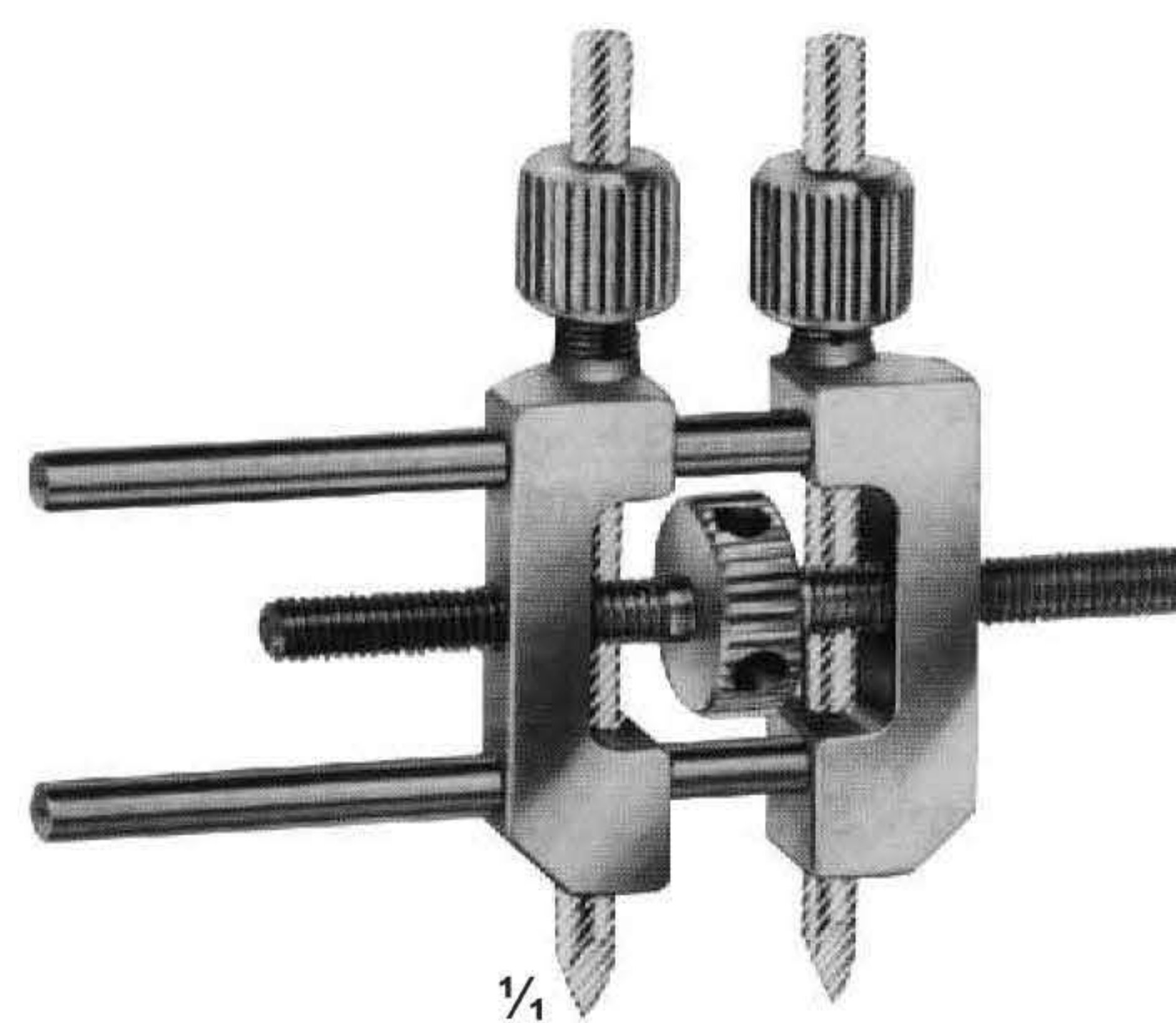

UG-1761
Small distractor
as a repositioning device for
distraction and compression of small bones,
for wires with 3.0 mm diam.

STEINMANN Pins



UG-1763
STEINMANN



$\frac{1}{4}$
UG-1775
Protection cap
for 4,0 mm STEINMANN Pins



$\frac{1}{4}$
UG-1777
Protection cap
for 5,0 mm STEINMANN Pins

Drilling Chucks



1/2

UG-1779
REILL
Drilling chuck, cannulated, for shanks from 2.0 - 2.5 mm diam 115 mm

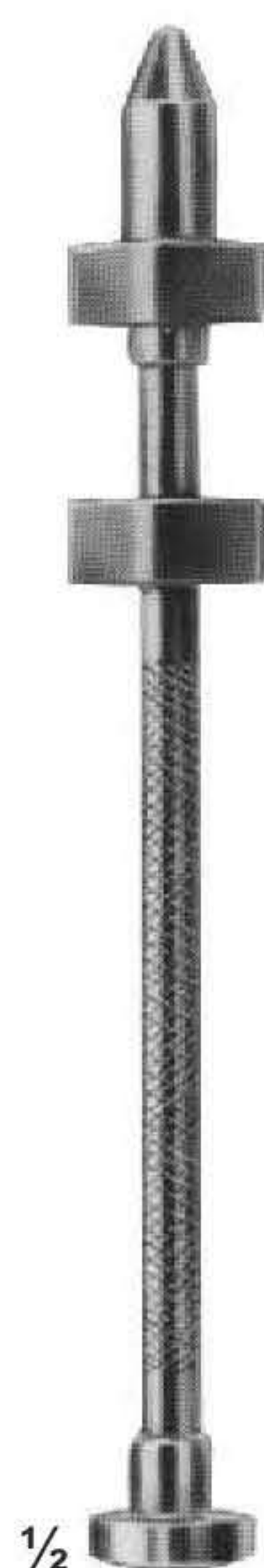

1/2

UG-1782
Drilling chuck, cannulated, for shanks from 0.8 - 2.0 mm diam 150 mm



1/2

UG-1783
Drilling chuck, cannulated, for shanks up to 4.5 mm diam with key 140 mm



1/2

UG-1784
LOUTE
Wire tightener, improved pattern, with movable tip, for wires up to 1.0 mm diam. 220 mm



1/2

UG-1786
Drilling chuck, cannulated, for shanks up to 6.35 mm diam., To be tightened by hand 100 mm



1/2

UG-1787
Drilling chuck, cannulated, for shanks up to 4.5 mm diam., And for triangular shaft width across flats 4.7 mm



1/2

UG-1789
Drilling chuck, cannulated, for shanks up to 6.35 mm diam., With key 160 mm

Cerclage Instruments

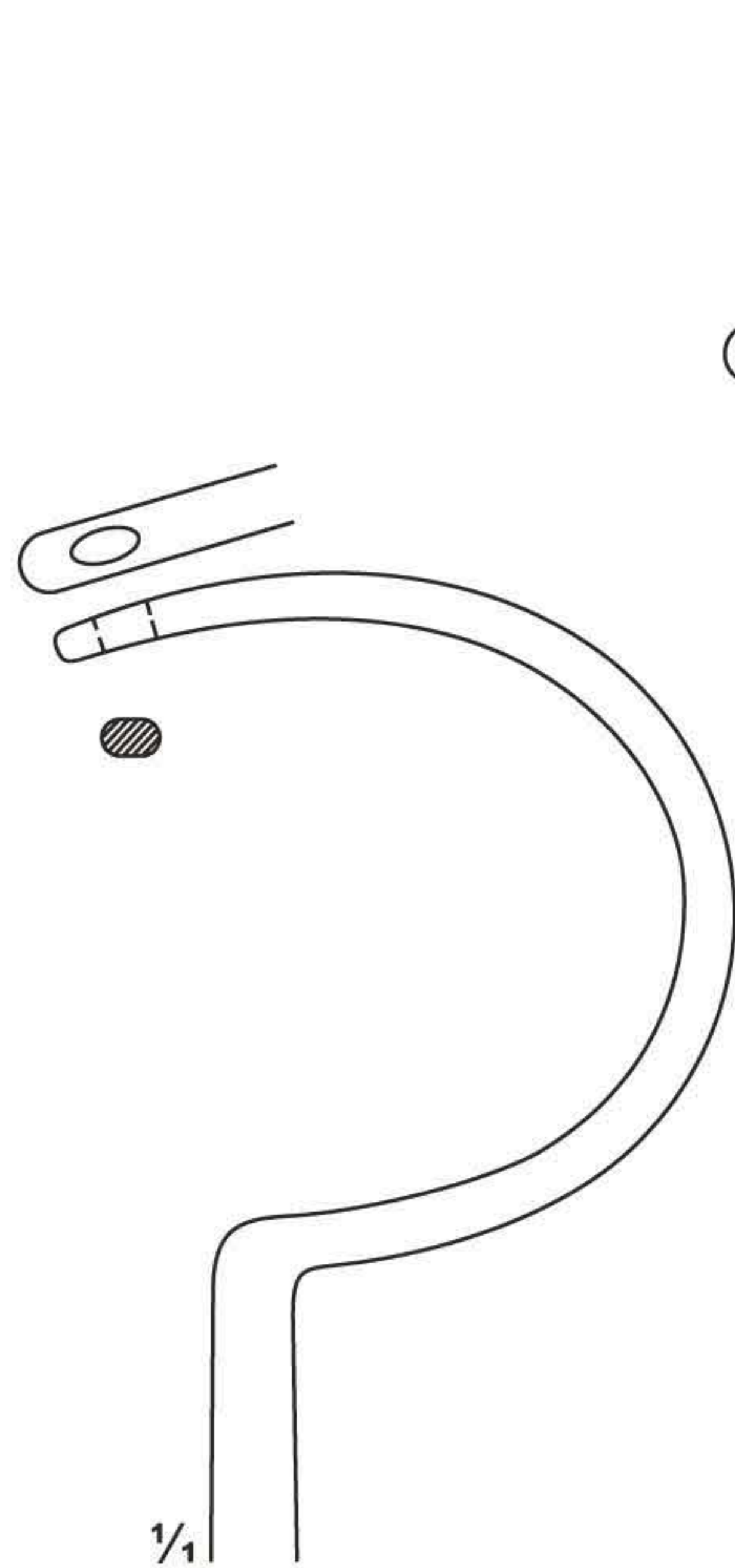

UG-1794
275 mm

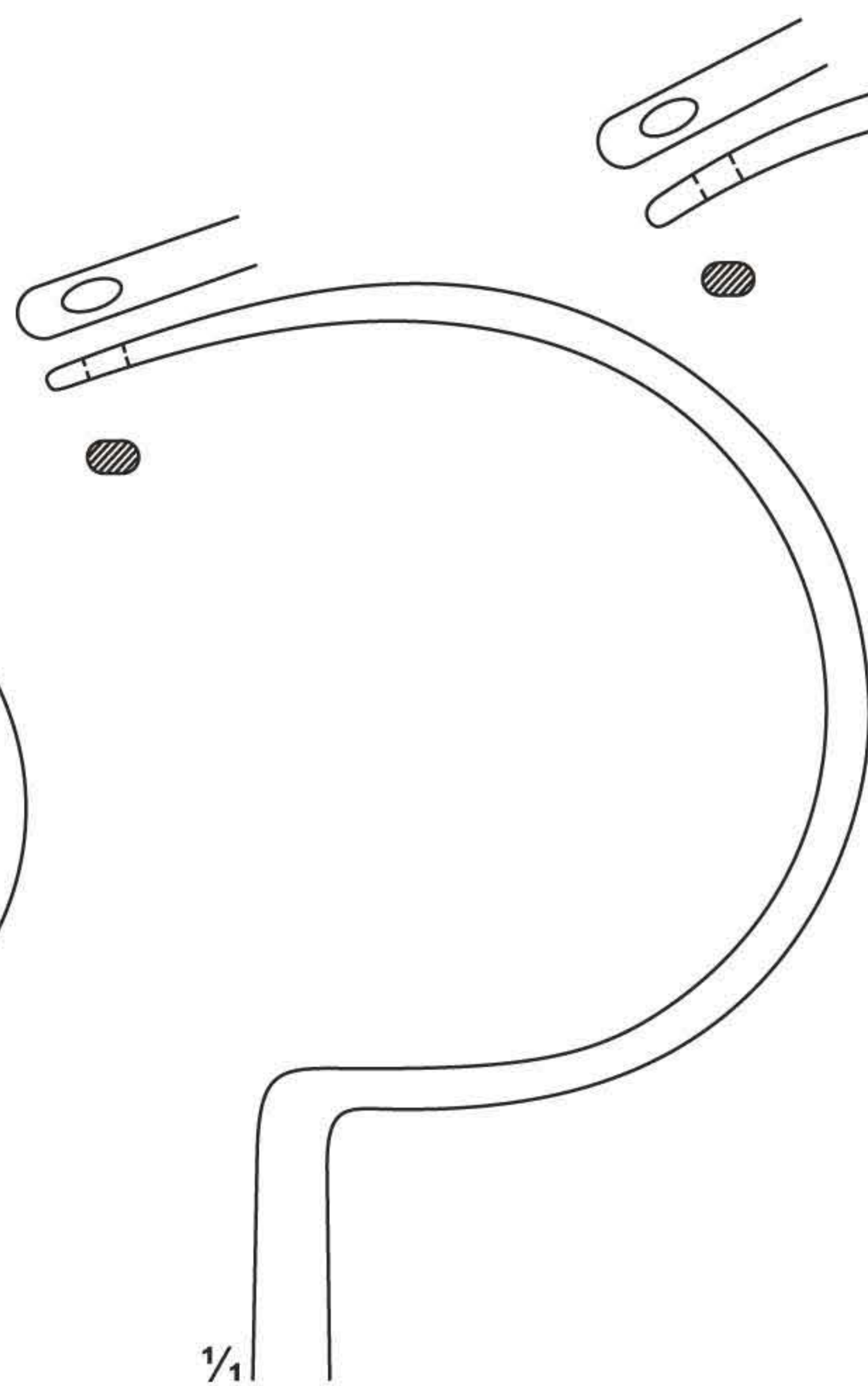

UG-1797
285 mm

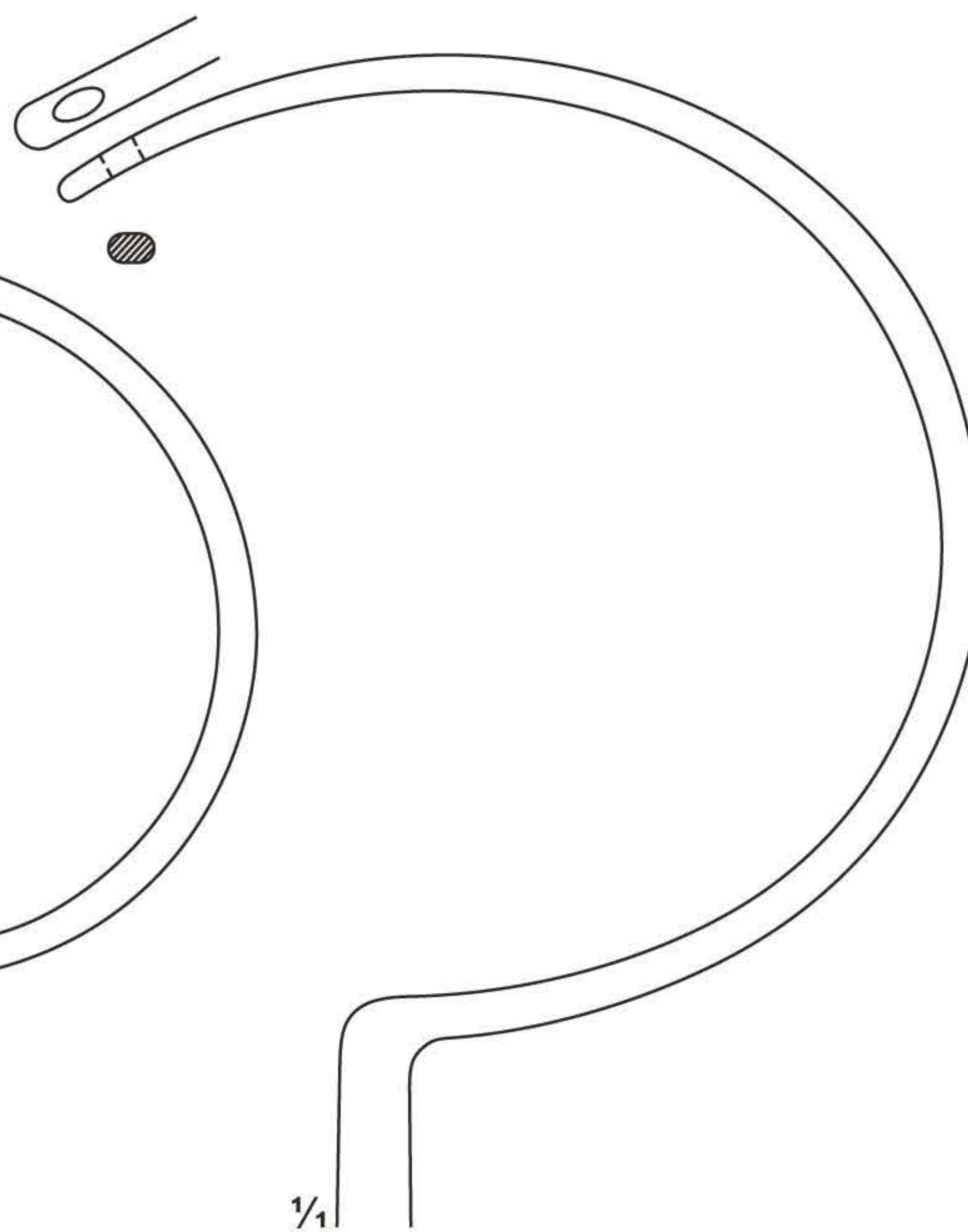

UG-1799
305 mm



UG-1792
DEMEL
Wire guides

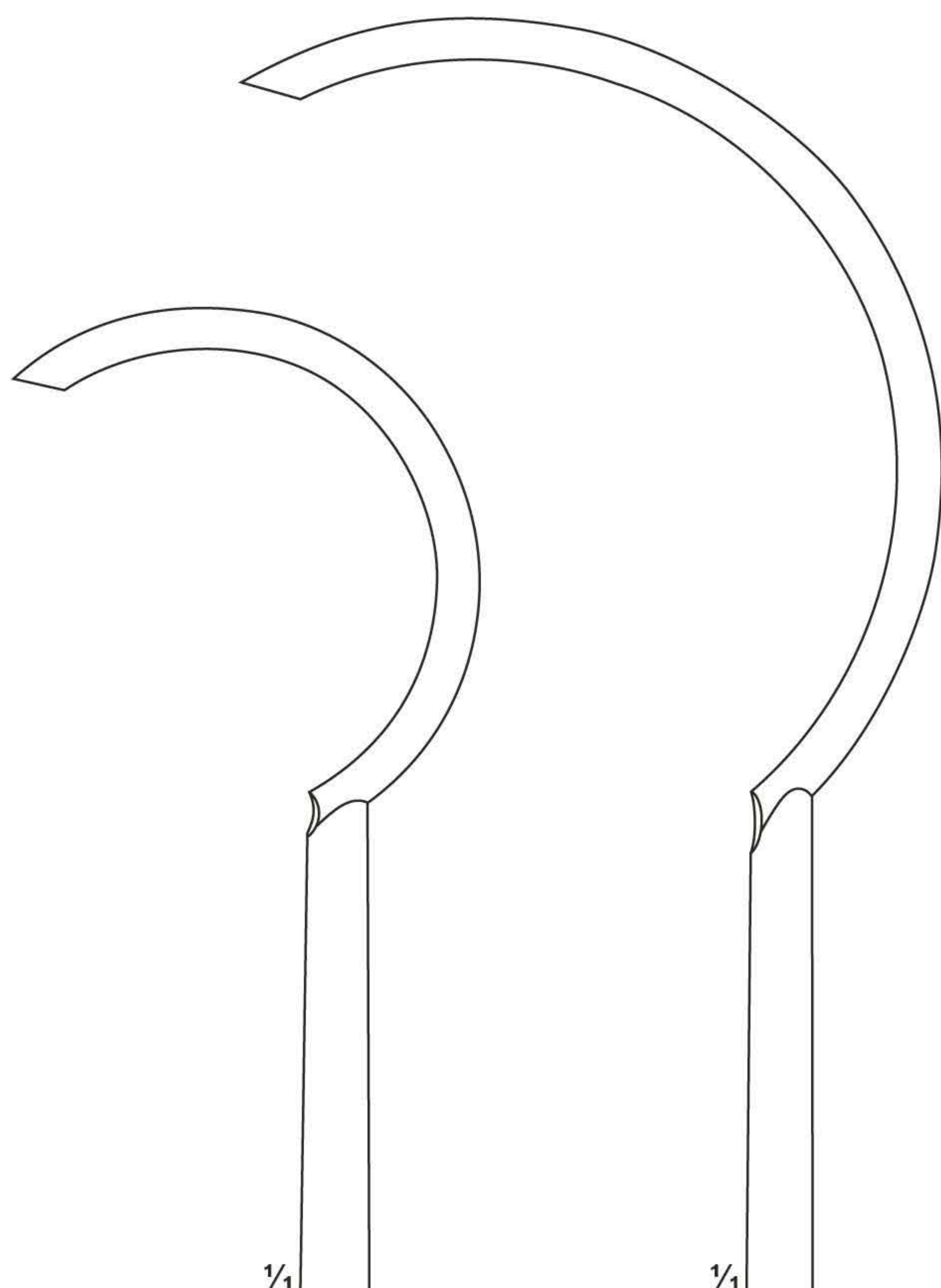

UG-1800
240 mm

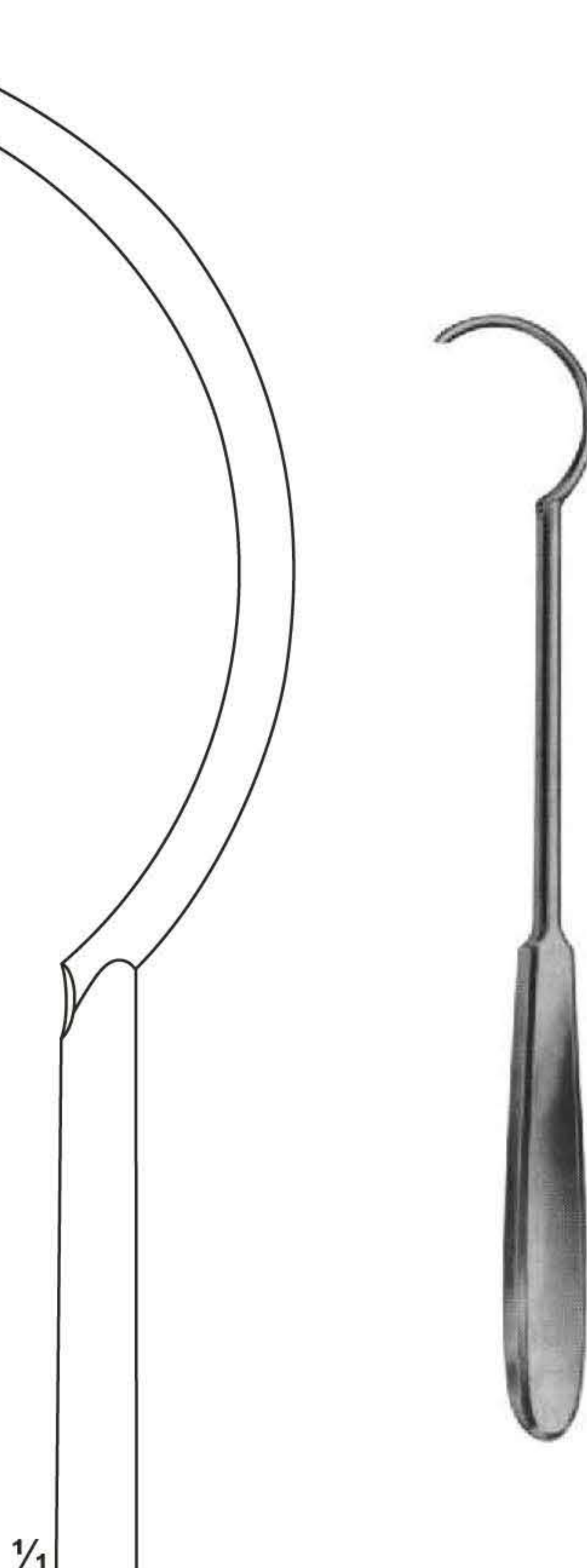

UG-1801
270 mm

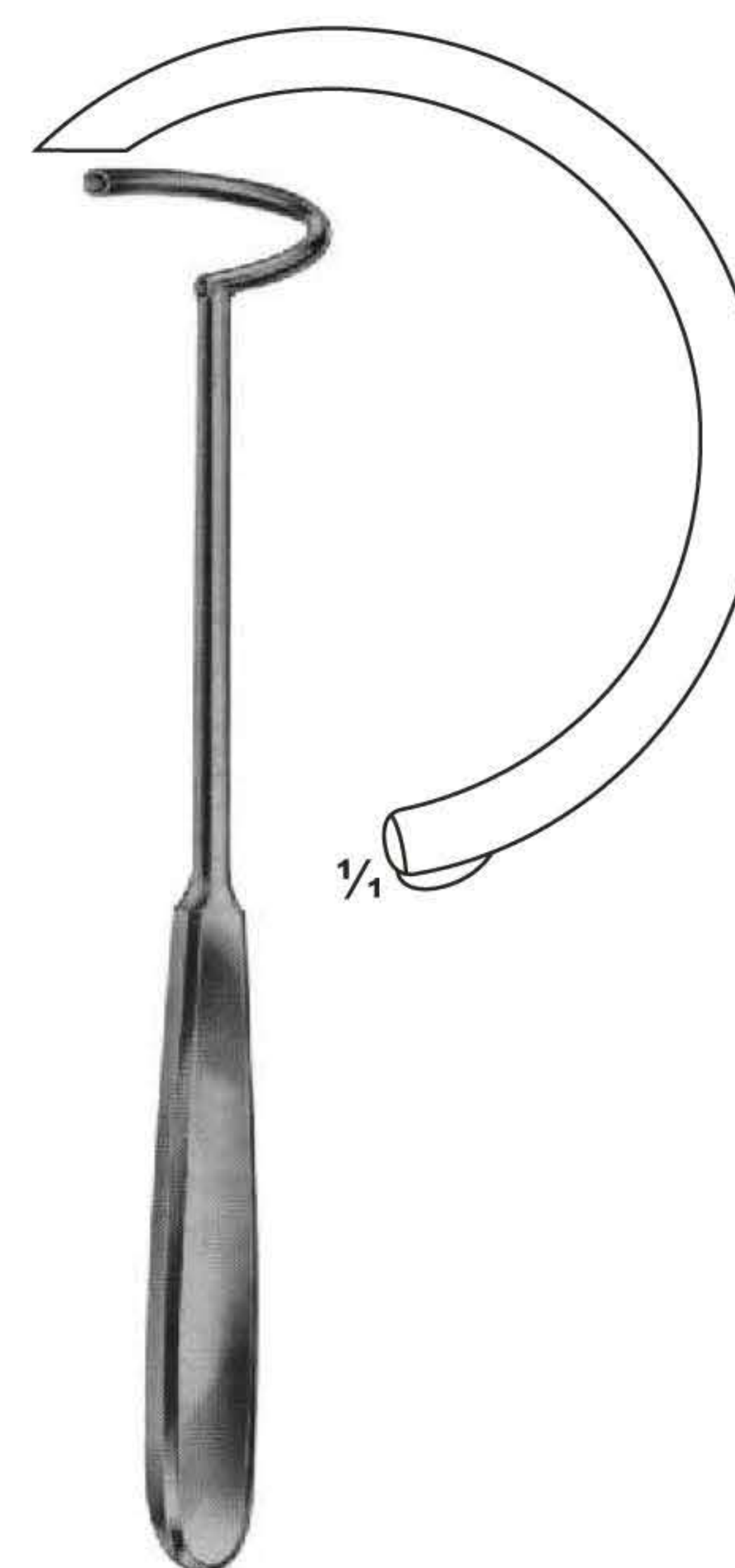

UG-1802
225 mm

JORDAN instruments for subcutaneous Tibia Cerclage

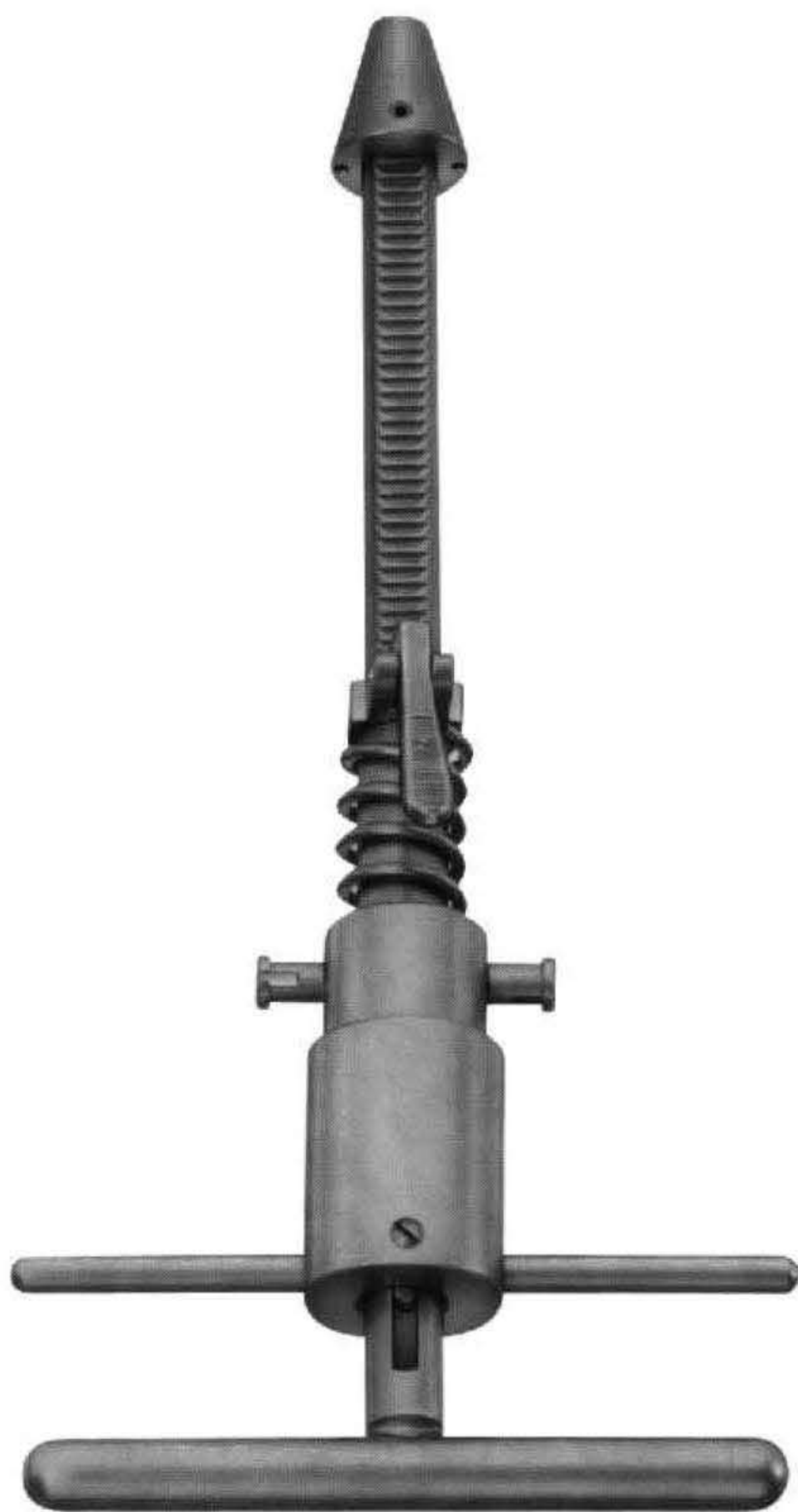

UG-1805
JORDAN
Wire tightener



1/2

UG-1806
JORDAN
Wire twister
170 mm



1/2

UG-1807
JORDAN
Wire catcher
180 mm



1/2

UG-1808
JORDAN
Probe, cannulated
170 mm

Wire Holding forceps, Wire Tightening Pliers, Flat-nosed Pliers

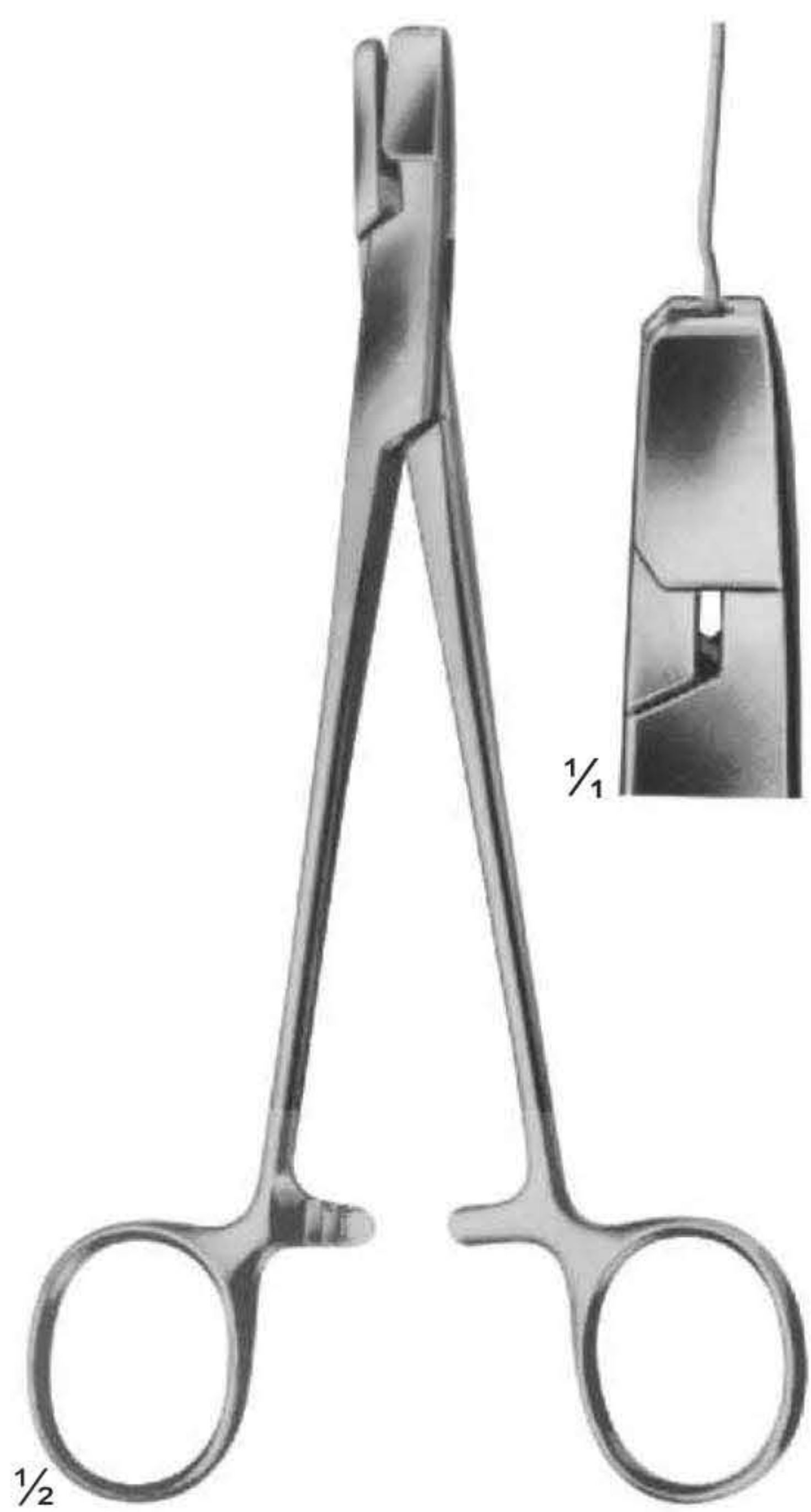

UG-1809
DUROGRIP
Holding forceps for cerclage
wire, with lateral jaws to avoid
wire slipping off
170 mm



UG-1810
DUROGRIP
Wire, tightening pliers,
Ligature pliers
150 mm



UG-1811
DUROGRIP
Wire, tightening pliers,
Ligature pliers
150 mm



UG-1812
with serrated jaws
140 mm



UG-1813
one jaws smooth,
one jaws serrated
140 mm



UG-1814
with serrated jaws
with longitudinal and
transversal grooves
170 mm

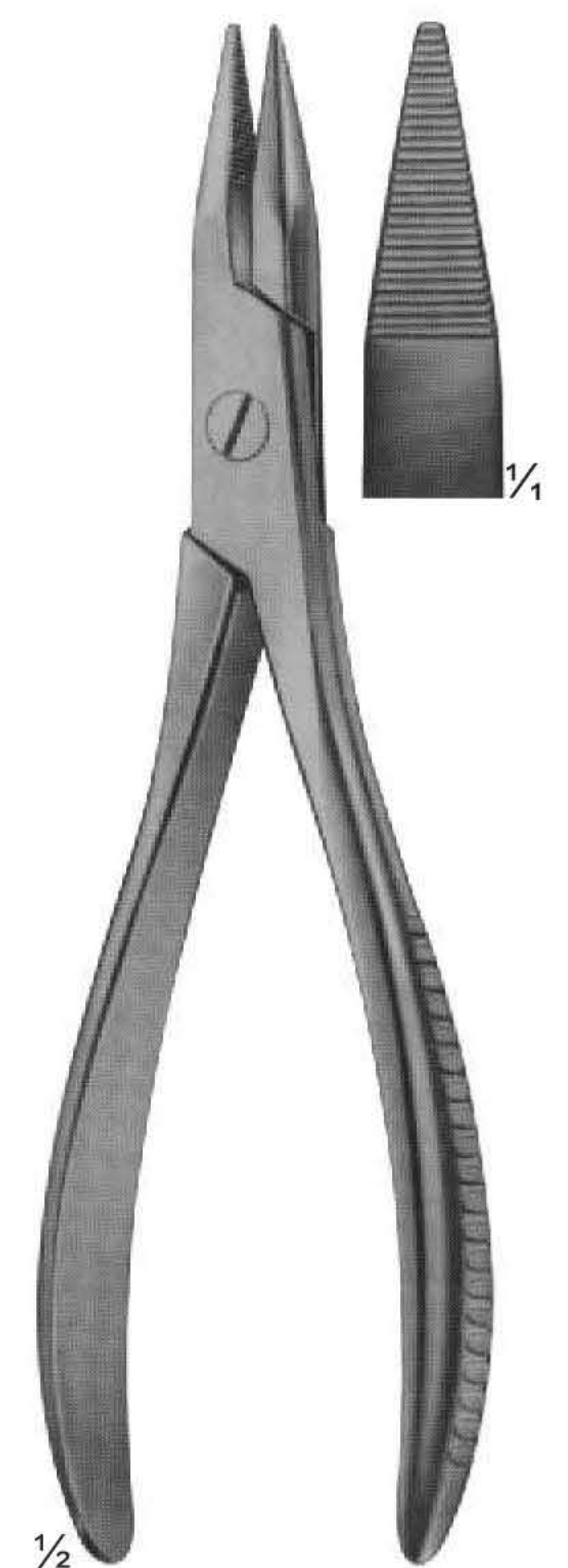

UG-1815
190 mm

Wire Holding forceps, Flat-nosed Pliers, Pliers for bending and cutting wires



1/2

UG-1817
Extraction pliers
for boring wires

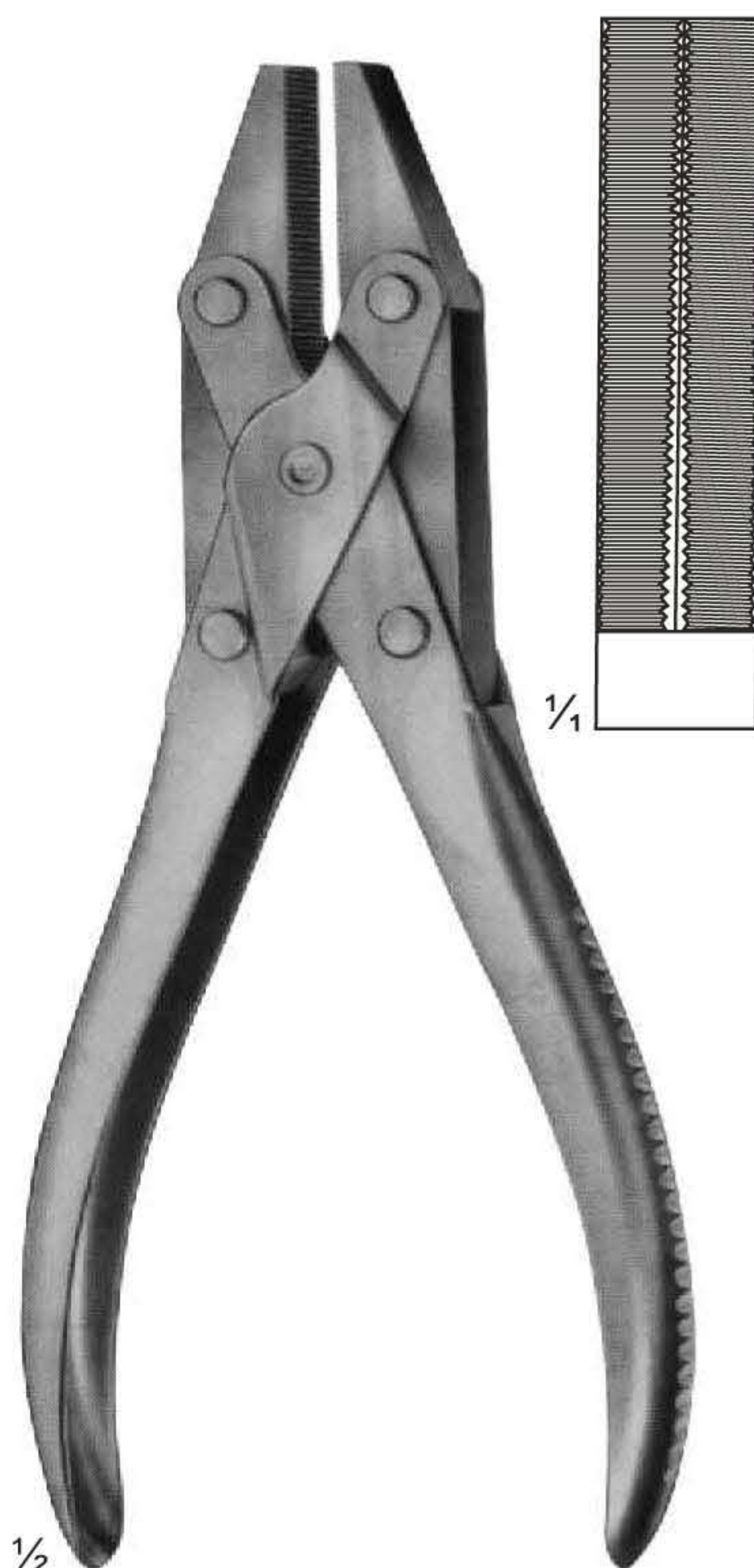

1/2

UG-1818
Flat-nosed pliers,
parallel
185 mm

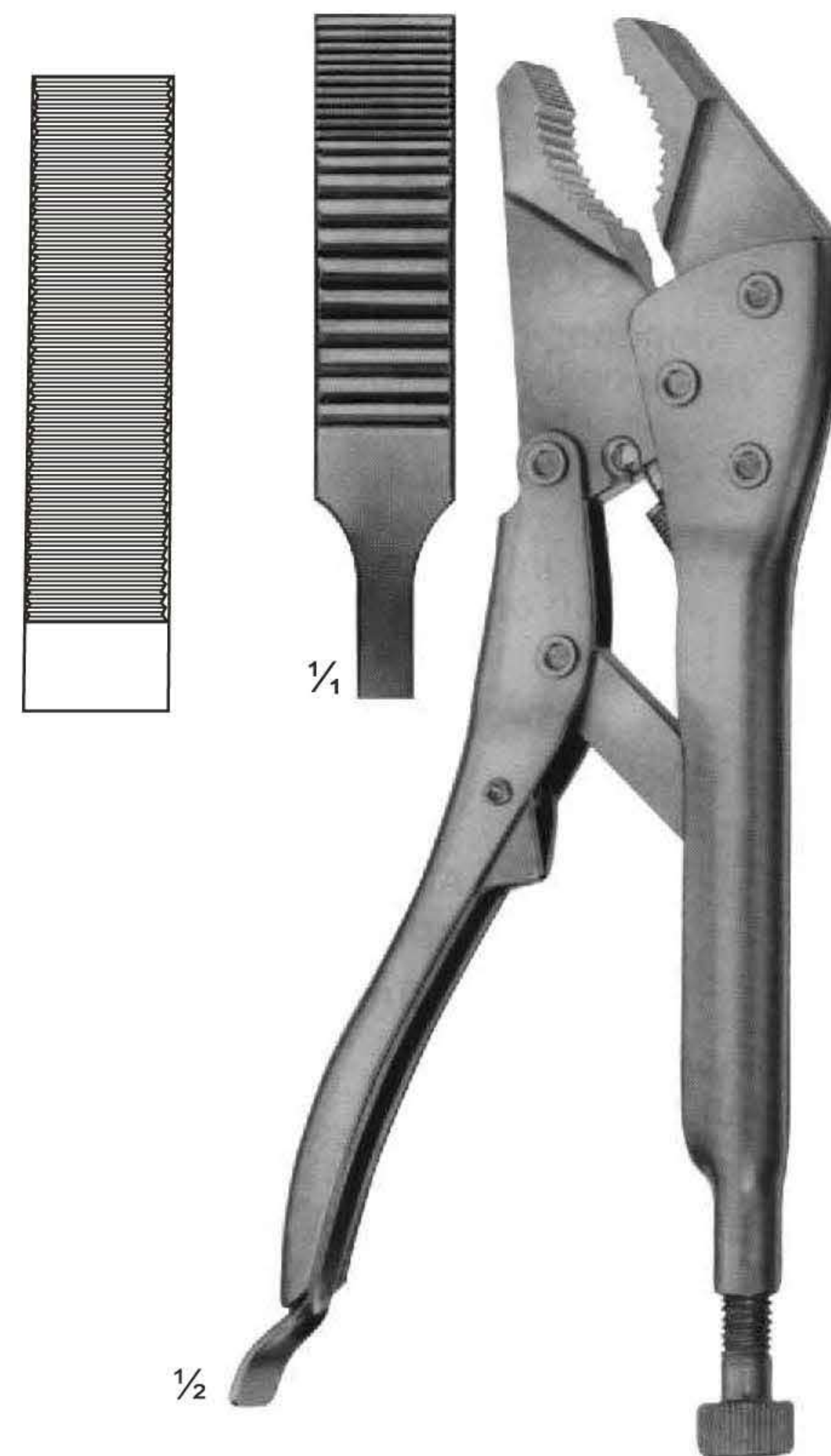

1/2

UG-1819
Vise grip
200 mm



1/2

UG-1820
Round pliers
180 mm

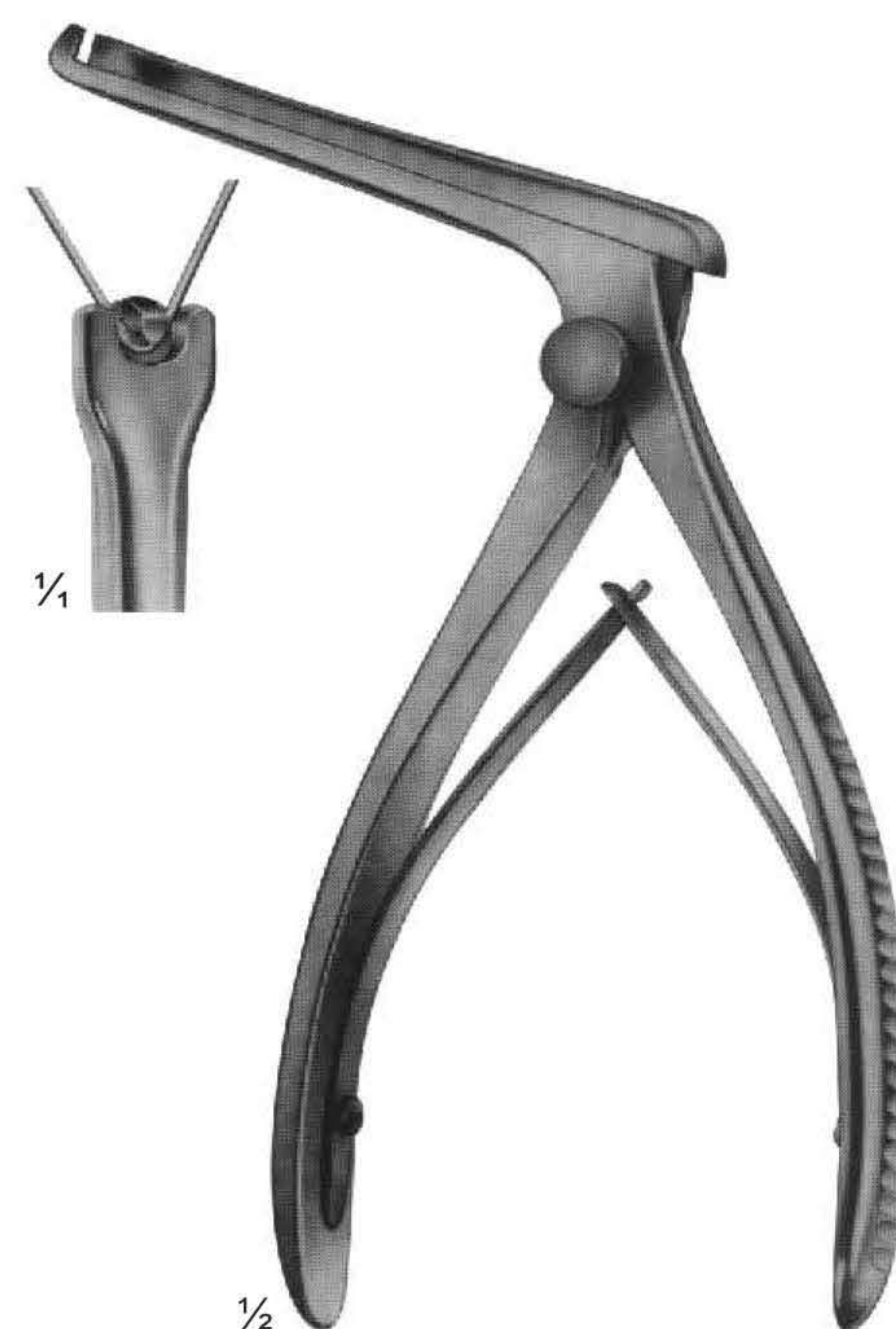

1/2

UG-1821
Bending pliers
for wires up to
1.8 mm diam.

Wire Cutters and wire Cutting Scissors

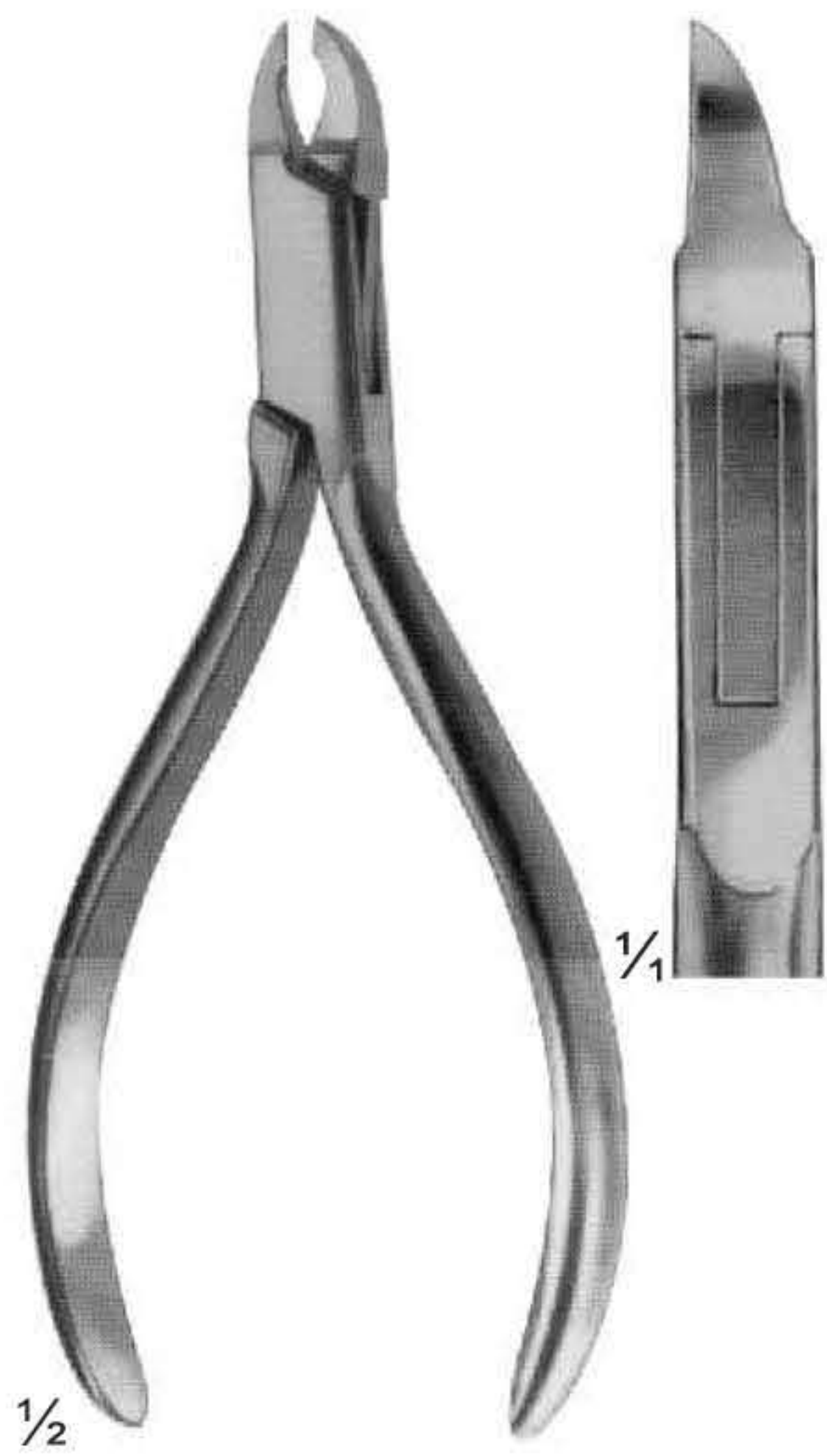

UG-1823
ANGLE
130 mm

for soft wire
up to diam.
for hard wire
up to diam.

UG-1825
DUROTIP
ANGLE
130 mm

0,5 mm 0,6 mm
0,3 mm 0,4 mm

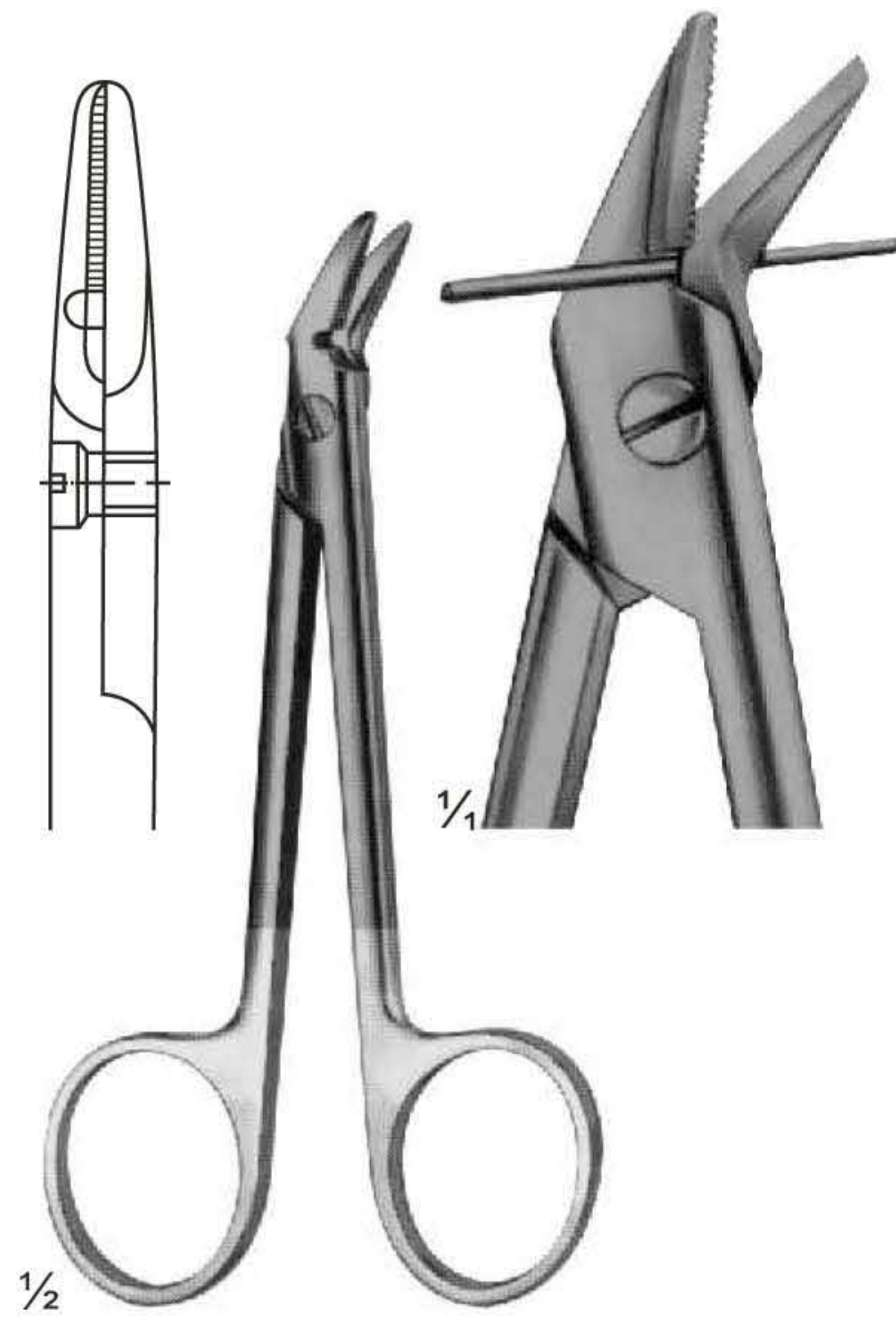

UG-1826
120 mm

for soft wire
up to diam.
for hard wire
up to diam.

UG-1828
DUROTIP
120 mm

1,2 mm 1,2 mm
0,8 mm 0,8 mm

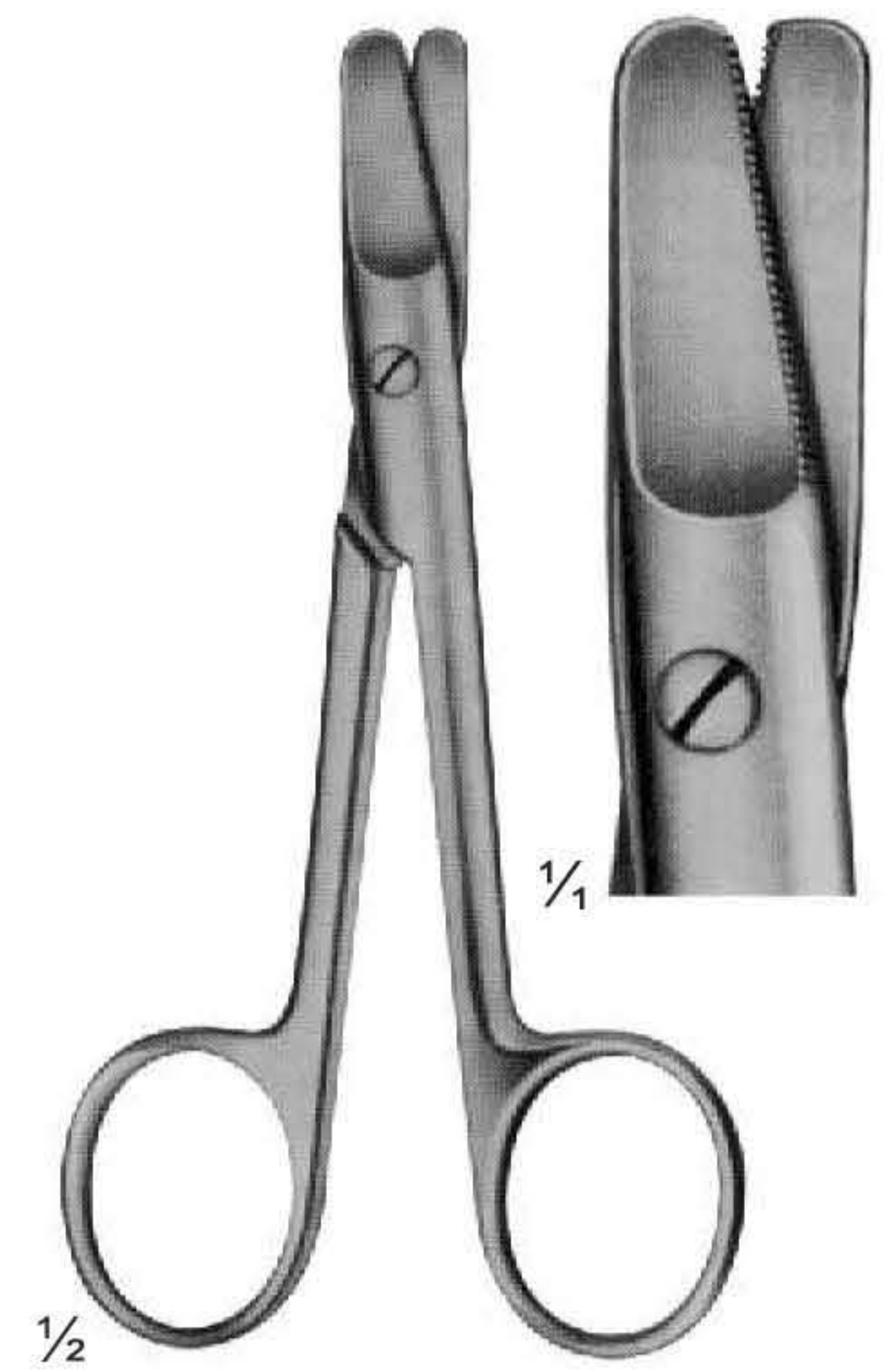

UG-1829
HARVEY
125 mm

0,4 mm
0,3 mm

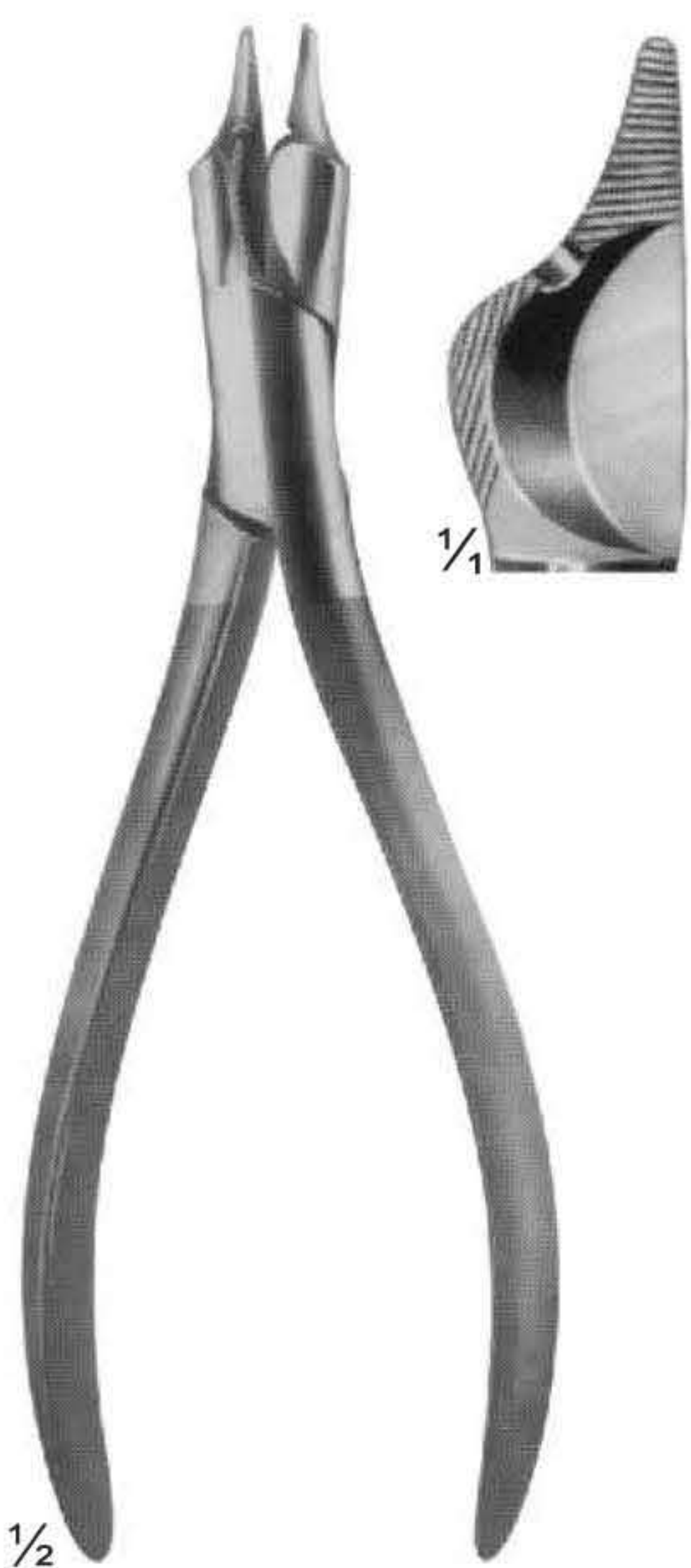

UG-1830
150 mm

for soft wire
up to diam.
for hard wire
up to diam.

1,5 mm
1,0 mm



UG-1831
160 mm

1,5 mm
1,2 mm



UG-1832
140 mm

1,5 mm
1,0 mm

Wire Cutting Pliers, Lateral Cutting Action

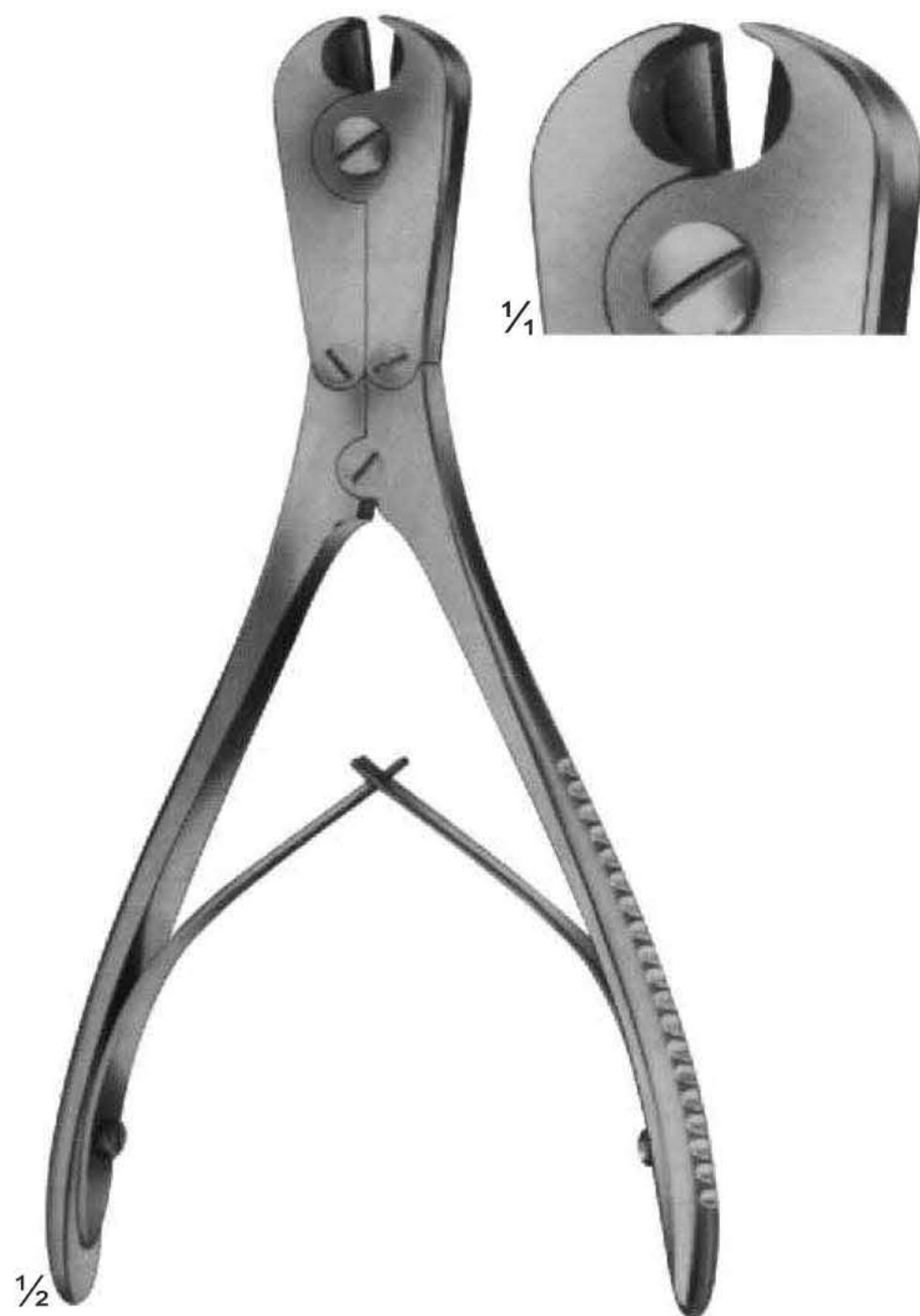

UG-1833
180 mm

for soft wire
up to diam. 2,0 mm
For hard wire 1,5 mm
up to diam
specially hardened
cutting edges, front
and lateral cutting
action



UG-1834
REILL
175 mm

for soft wire
up to diam. 2,0 mm
For hard wire 1,6 mm
up to diam
specially hardened
cutting edges, for
cutting off wires close
to the bone



UG-1835
235 mm

for soft wire
up to diam. 3,0 mm
For hard wire 2,2 mm
up to diam

Wire Cutting Pliers, Lateral and Front Cutting Action

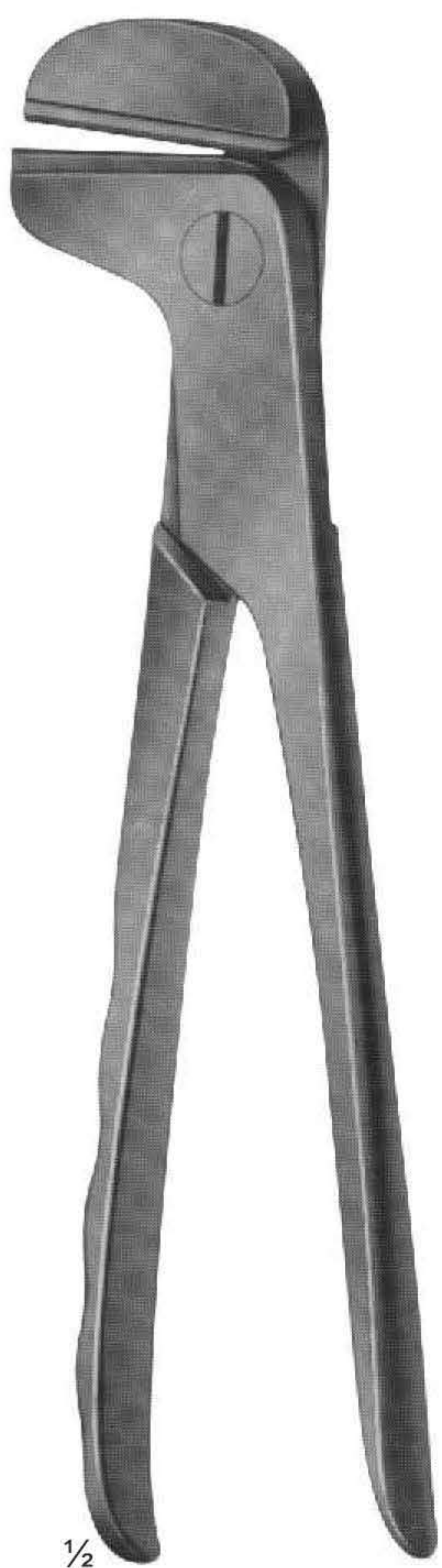

1/2

UG-1836
240 mm

for soft wire
up to diam.
For hard wire
up to diam

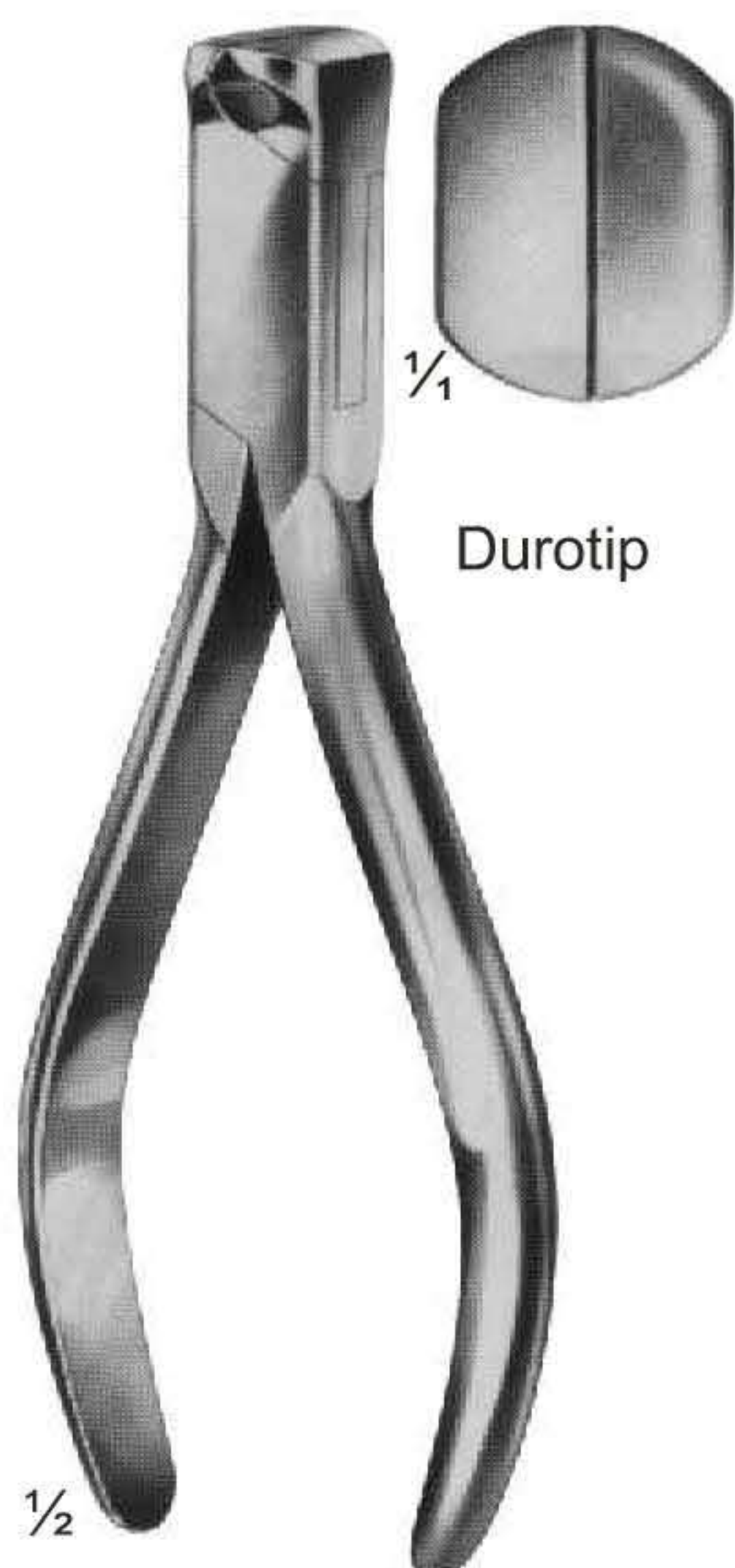

1/2

UG-1837
140 mm

for soft wire
up to diam. 1,5 mm
For hard wire
up to diam 1,0 mm

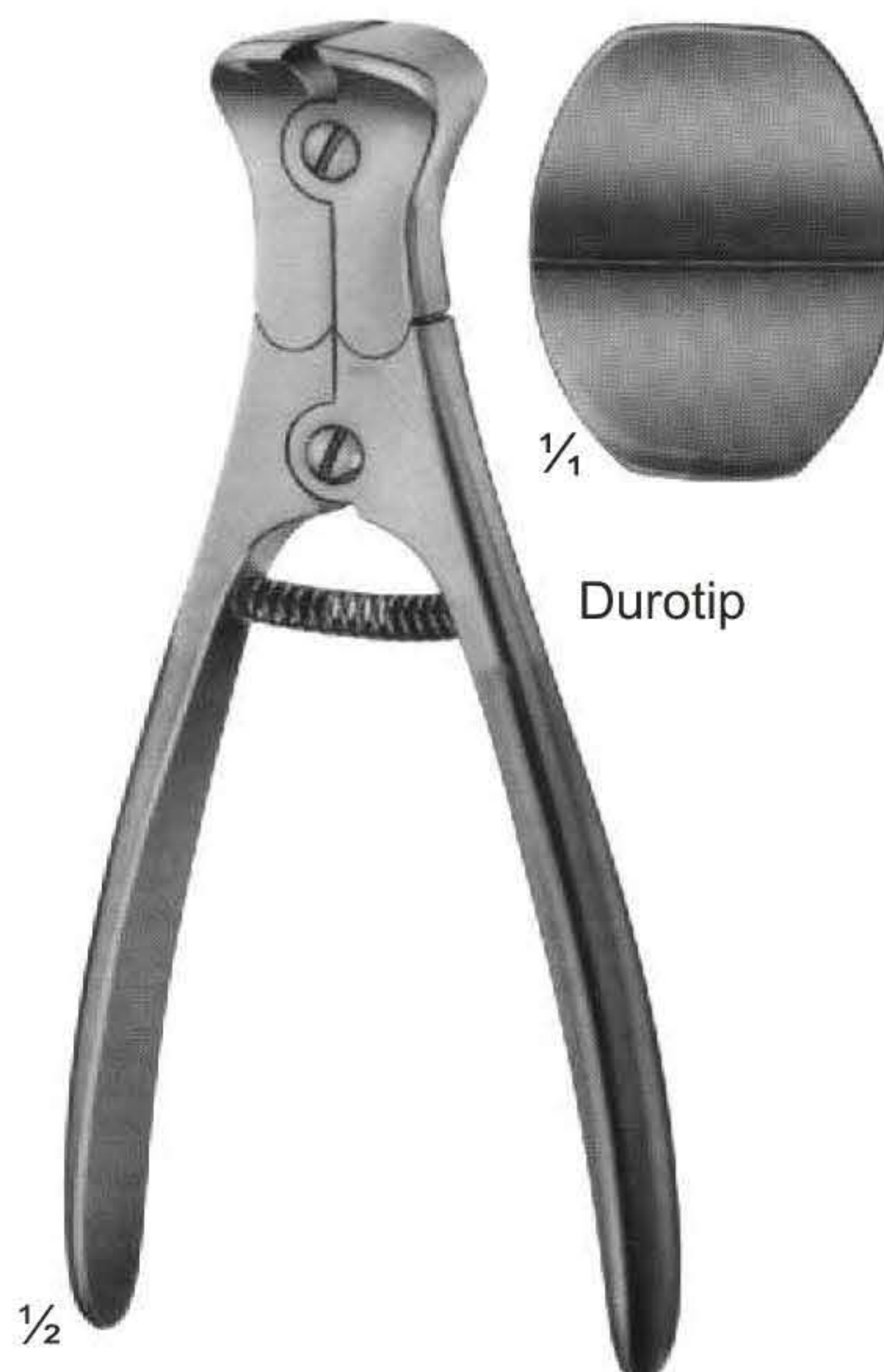

1/2

UG-1838
145 mm

for soft wire
up to diam. 2,0 mm
For hard wire
up to diam 1,5 mm

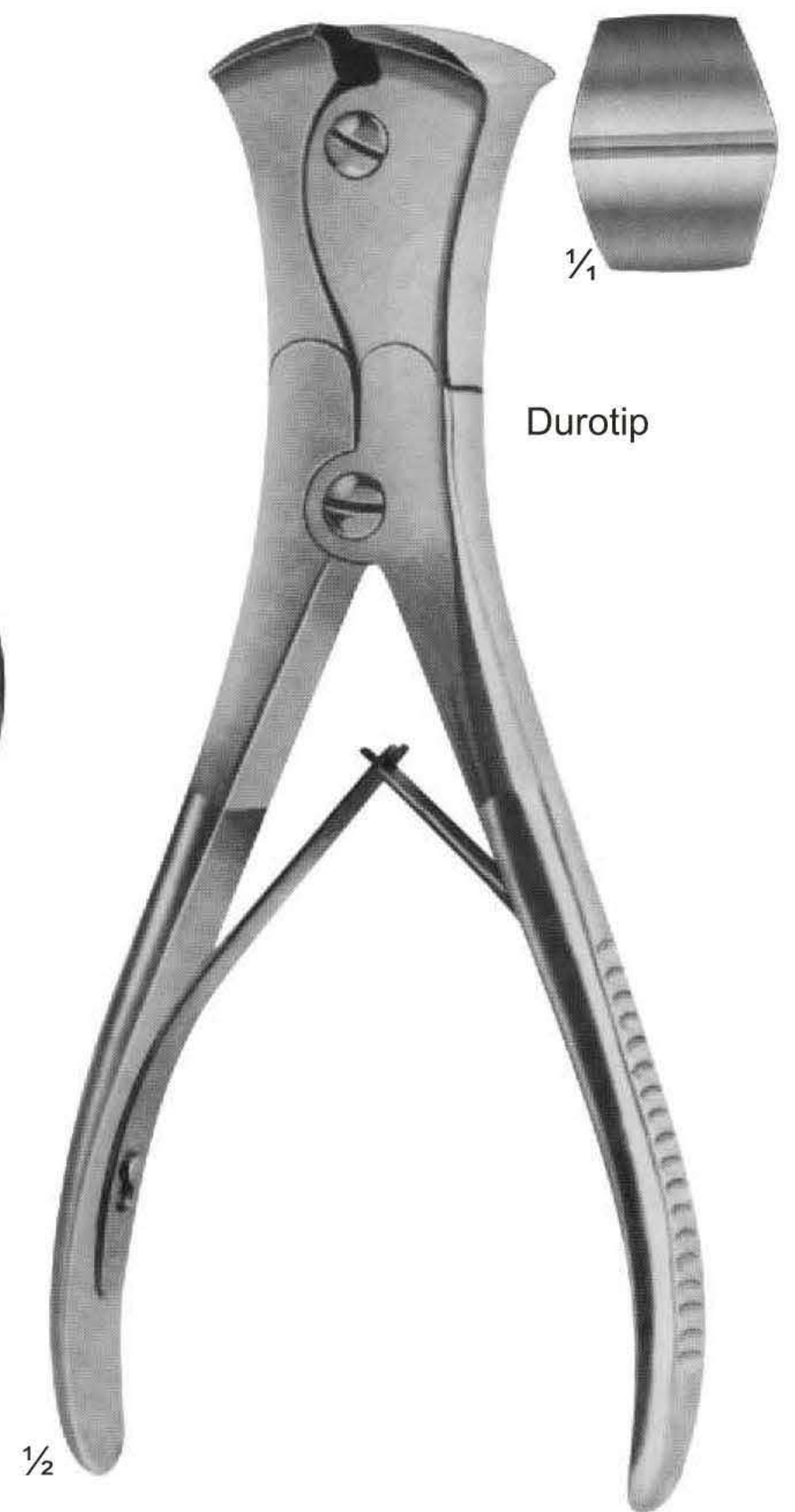

1/2

UG-1839
220 mm

for soft wire
up to diam. 3,5 mm
For hard wire
up to diam 2,5 mm

Wire Cutting Pliers



Cutter for cutting off
KIRSCHNER wires,
Tibia head screws,
bolts, pins, up to 3 mm diam.

UG-1840
320 mm

for soft wire up to diam. 3,0 mm
For hard wire up to diam 3,0 mm



Durotip

UG-1841

Cutter for cutting off
KIRSCHNER wires,
Tibia head screws,
bolts, pins, up to 6 mm diam.
470 mm

Finger Nail Instruments

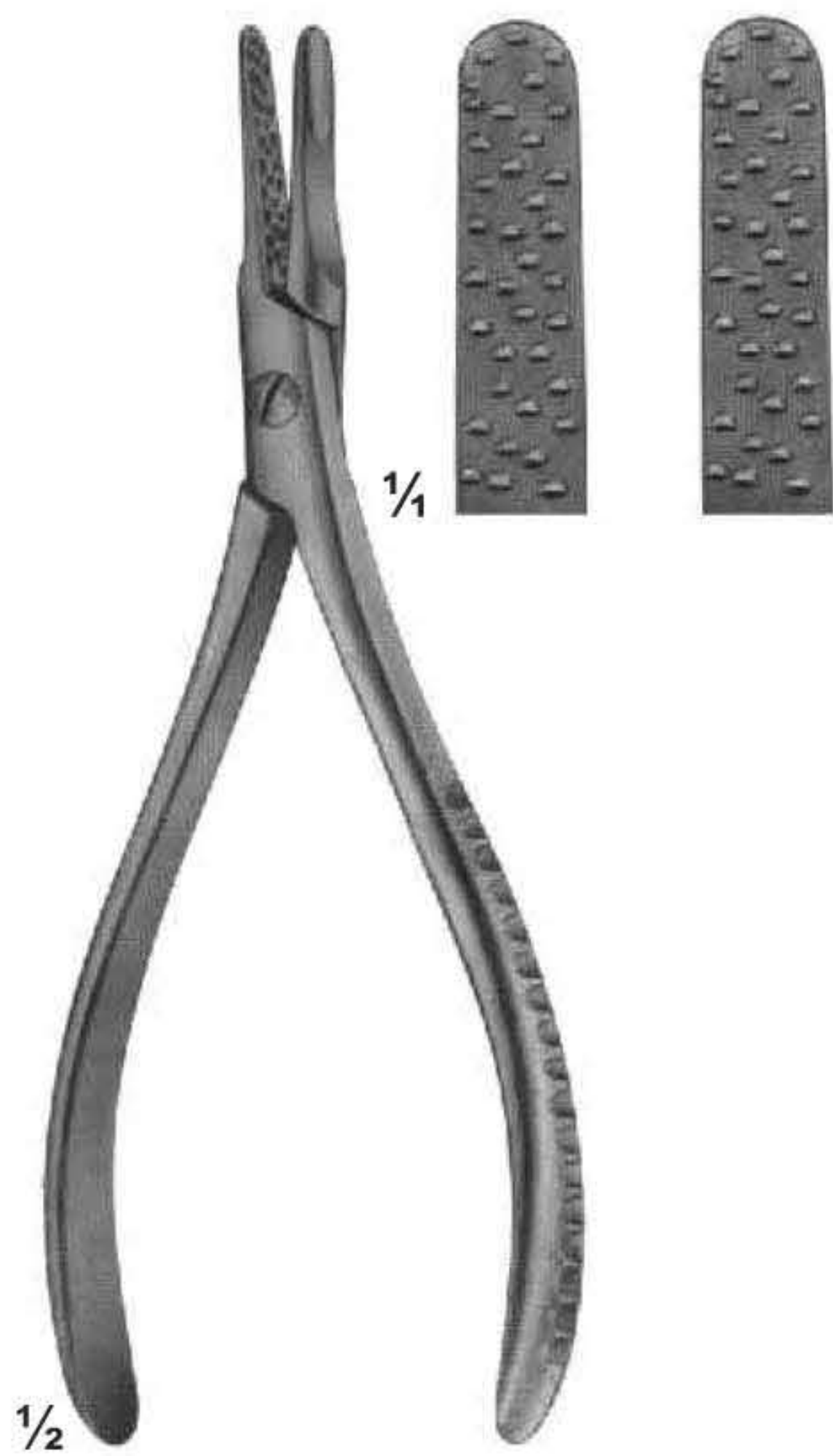

UG-1846
Nail extracting
forceps
135 mm



UG-1843
Nail extracting
forceps
145 mm



UG-1846
Finger nail drill
with 3 points

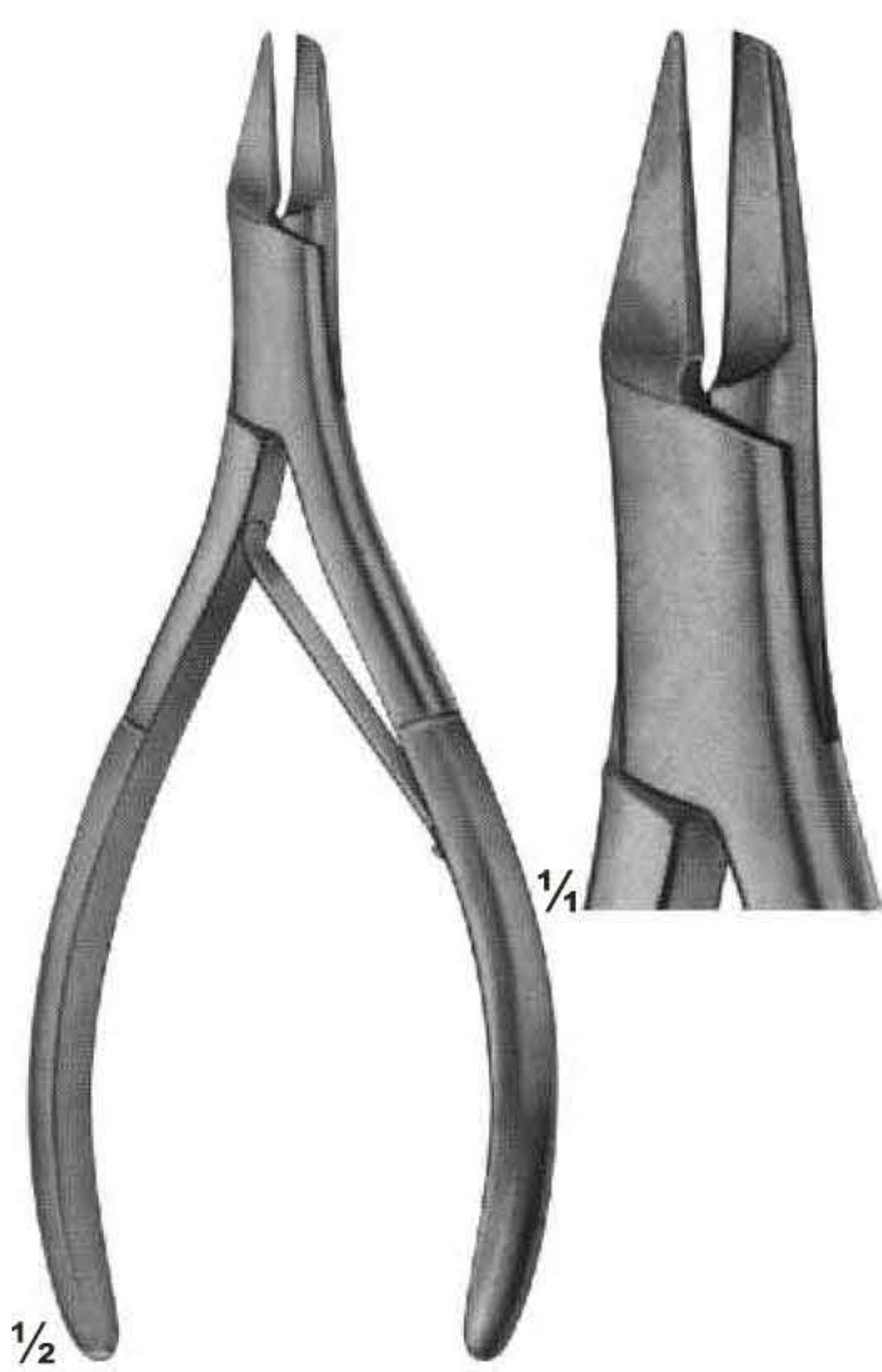

UG-1845
Nail splitting
forceps
135 mm

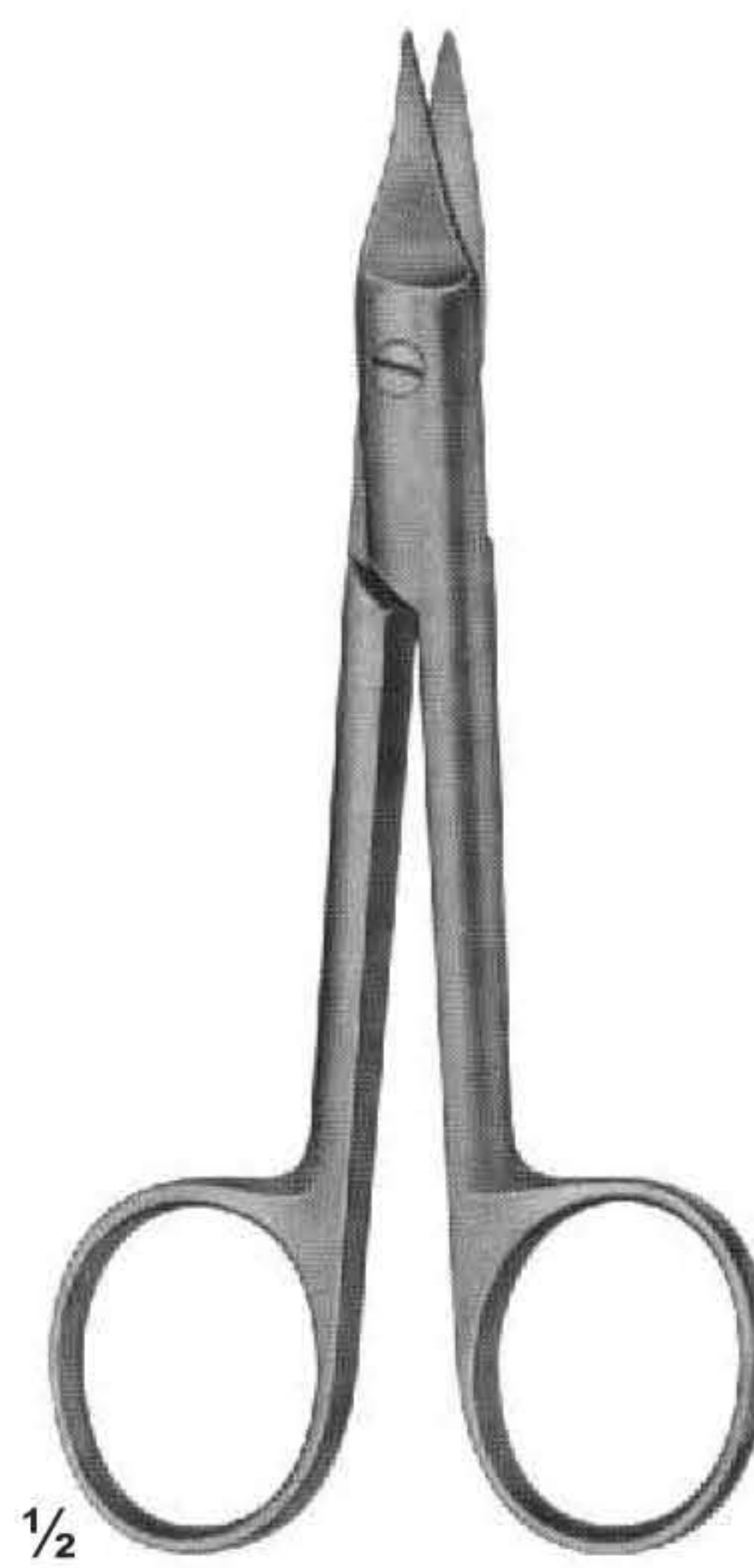

UG-1846
SYSTRUNK
Scissors, for splitting
finger nails
130 mm

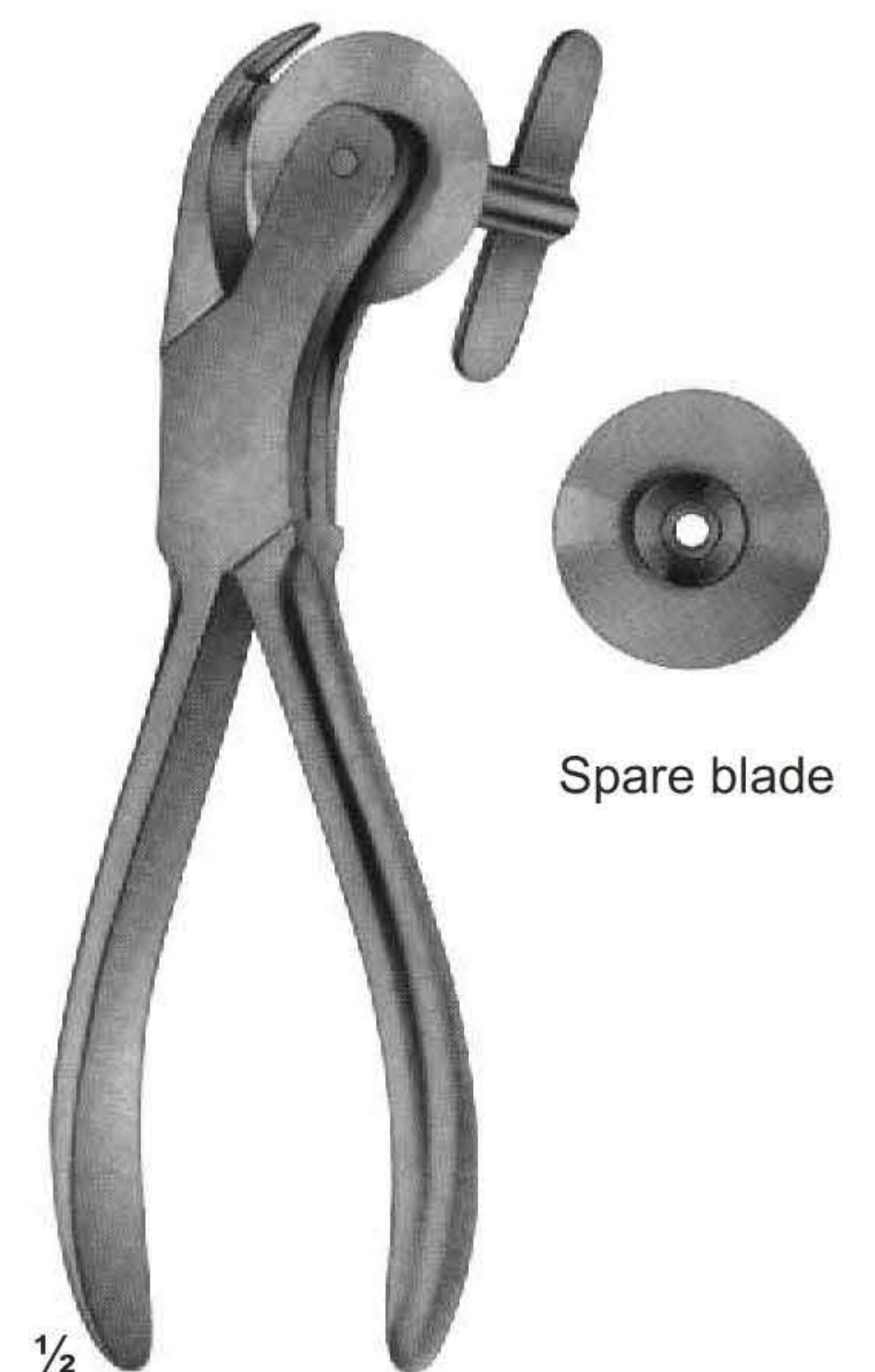

UG-1847
Finger ring saw
150 mm

Plaster Instruments



with ebony handle

UG-1865
HOPKINS
200 mm



1/2

UG-1866
ESMARCH
180 mm



1/2

UG-1867
ENGEL
160 mm

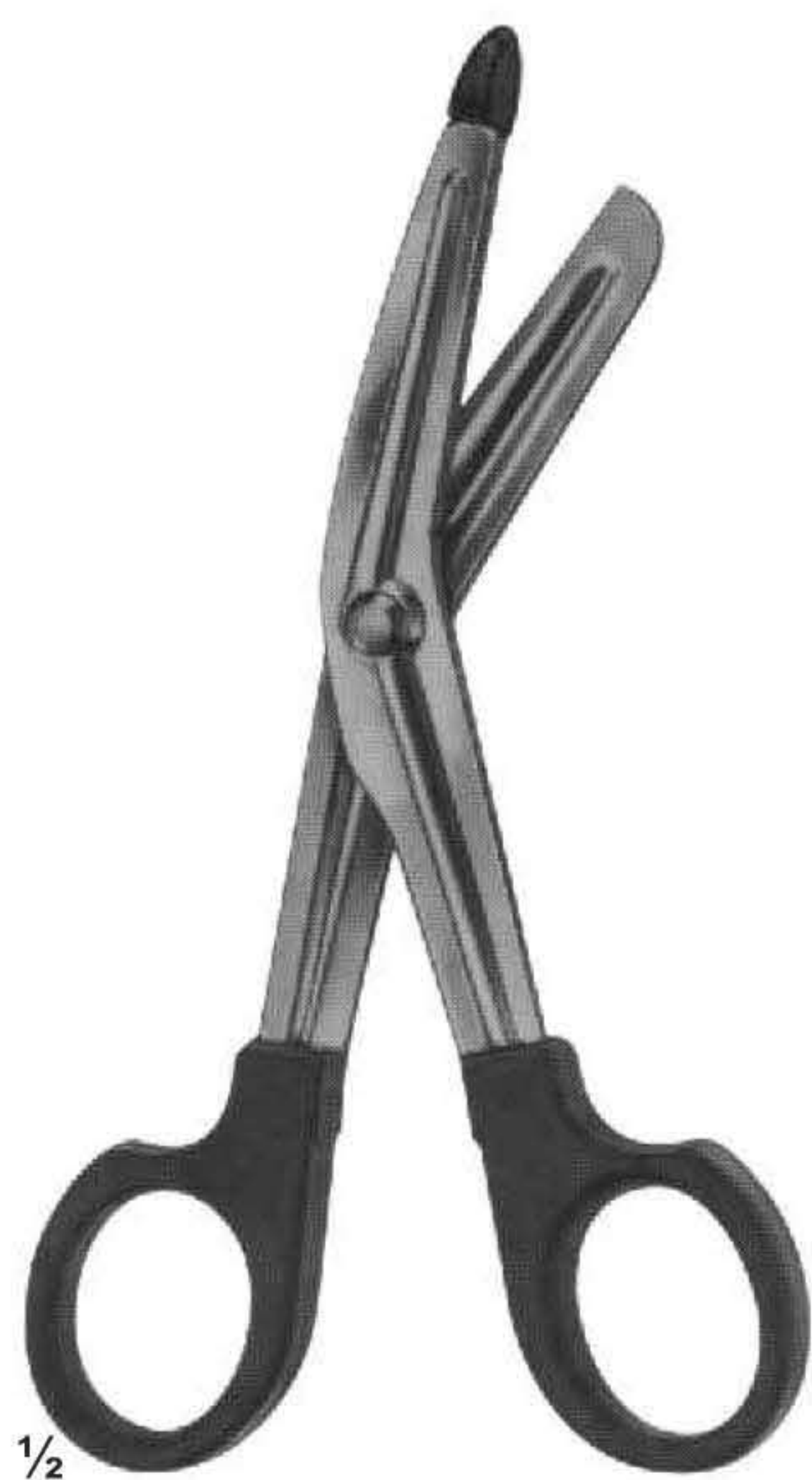

1/2

UG-1868



1/2

UG-1871

Plaster Scissors

For small plaster dressings



UG-1880
160 mm

1/2

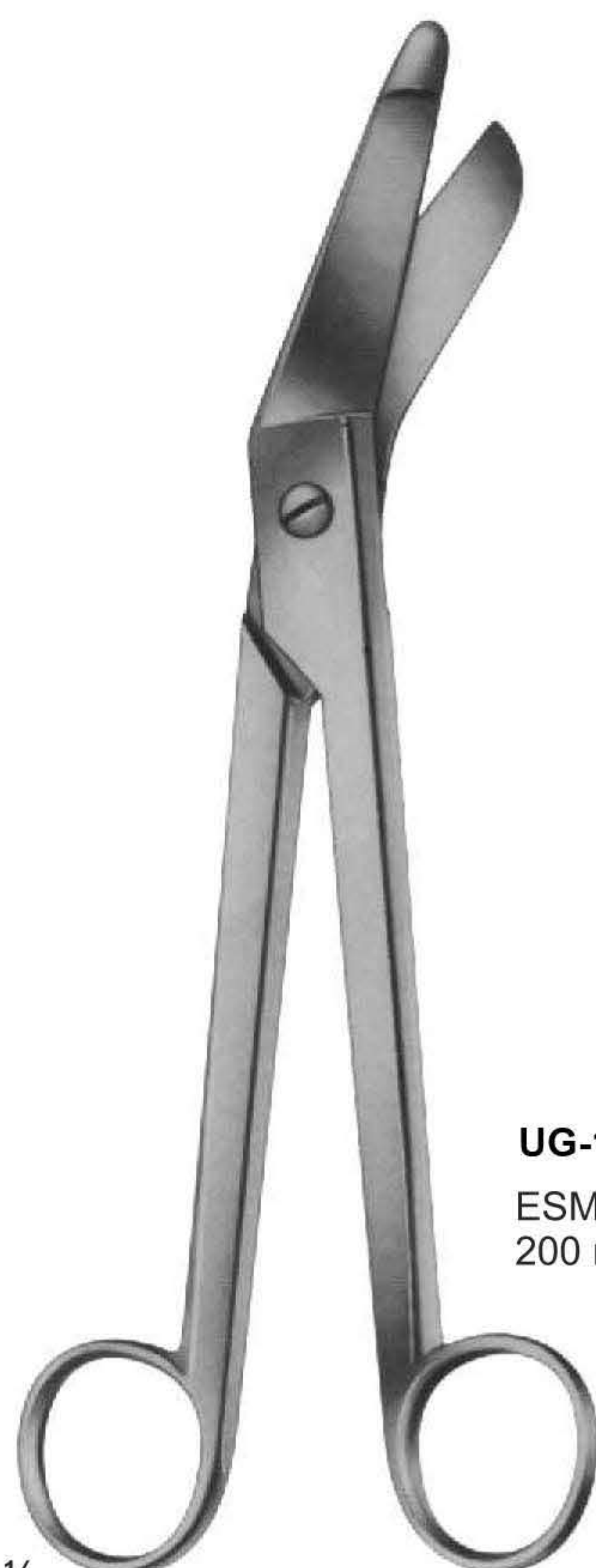

UG-1883
ESMARCH
200 mm 230 mm

1/2



UG-1886
BERGMANN
230 mm

1/2



UG-1888
BRUNS
235 mm

1/2



UG-1889
235 mm

1/2

also to be used as
bandage scissors



UG-1891
SEUTIN
230 mm

1/2

also to be used as
bandage scissors

Plaster Shears



UG-1894
STILLE-AESULAP
260 mm



UG-1896
STILLE-AESULAP
360 mm

STILLE Plaster Shears

Blade with reinforced back



UG-1898
STILLE
230 mm

UG-1899
Spare blade



UG-1901
STILLE
370 mm

UG-1902
Spare blade

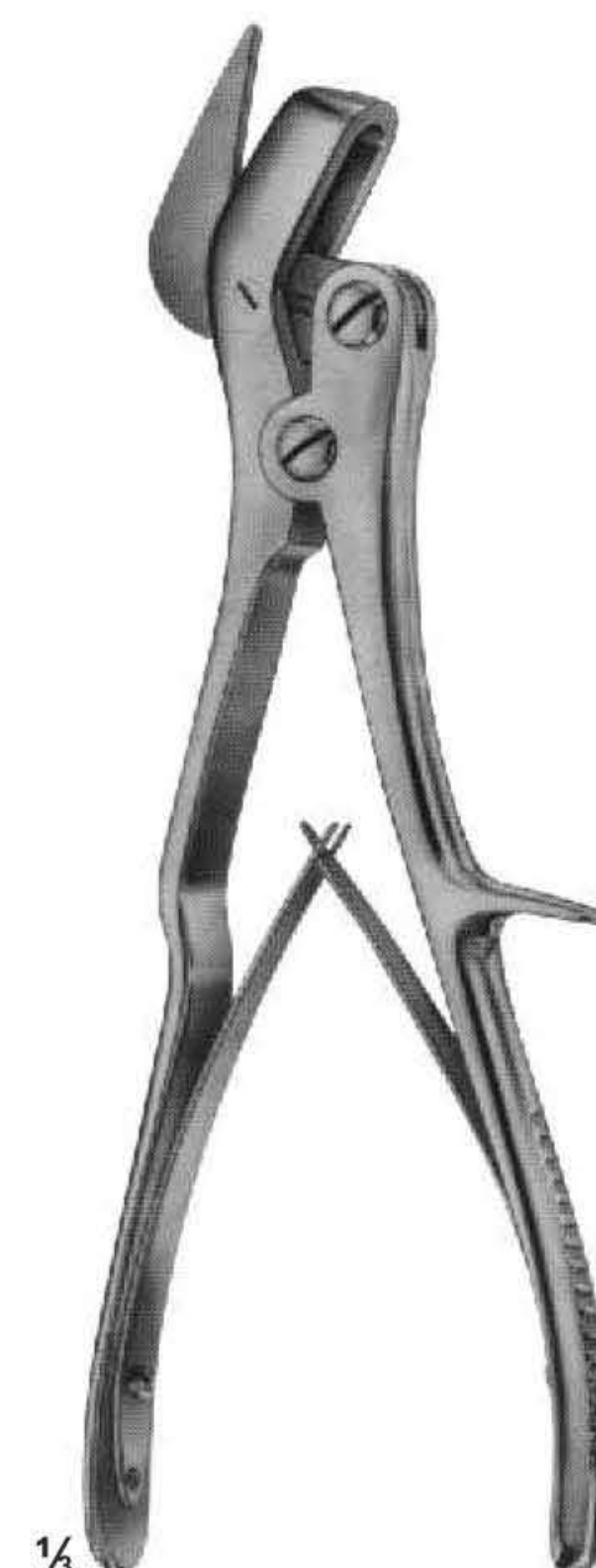

UG-1904
STILLE
240 mm

UG-1905
Spare blade

Plaster Spreader, Plaster Breakers



UG-1910
HENING
270 mm



UG-1911
MOD.USA
230 mm

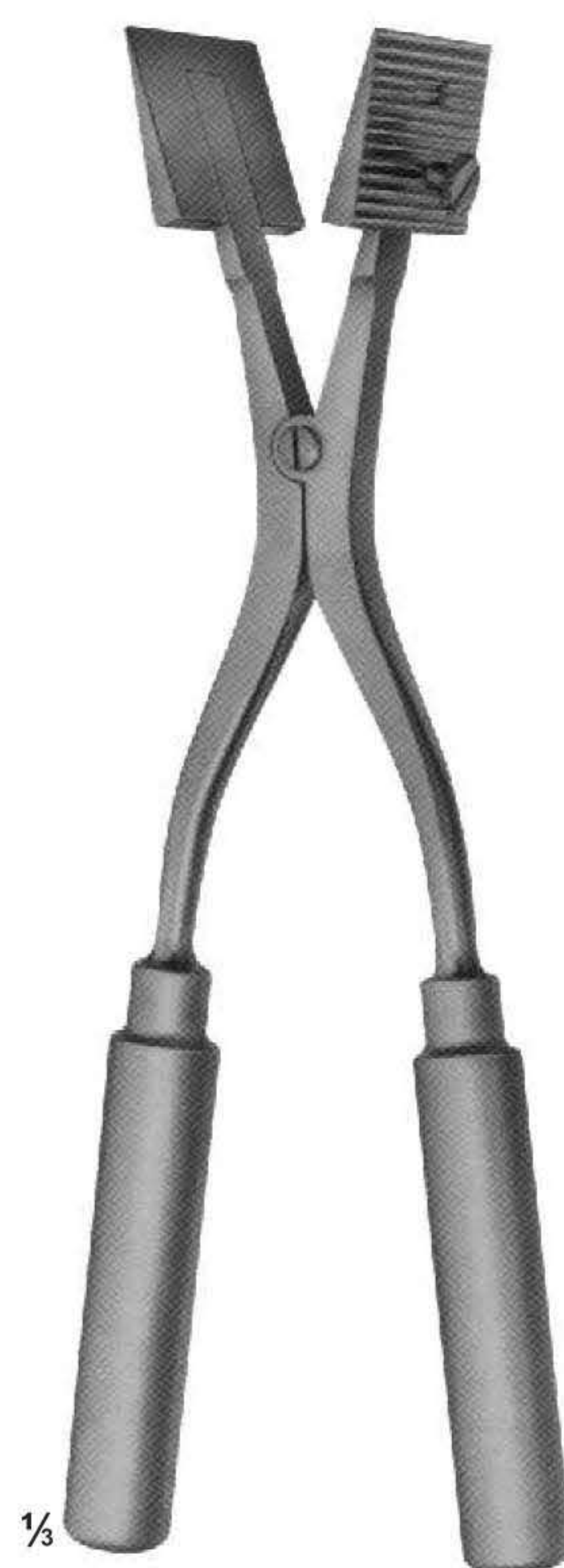

UG-1912
290 mm



with removable jaws



UG-1914
WOLFF
180 mm
240 mm

Vacuum Currettes for Aspiration Lipectomy, Suction Instruments

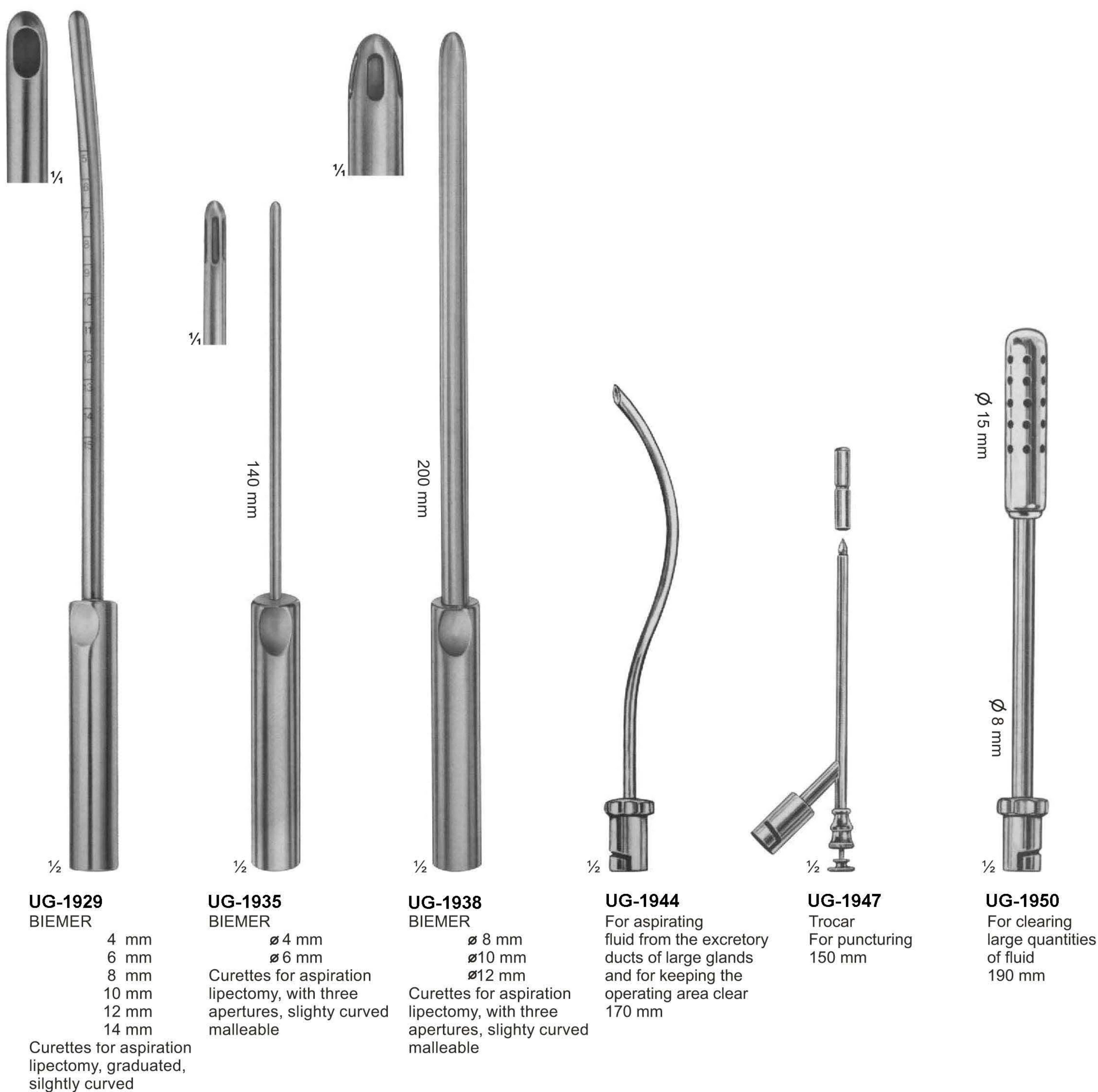

UG-1929
BIEMER

- 4 mm
- 6 mm
- 8 mm
- 10 mm
- 12 mm
- 14 mm

Curettes for aspiration lipectomy, graduated, slightly curved

UG-1935
BIEMER

- ø 4 mm
 - ø 6 mm
- Curettes for aspiration lipectomy, with three apertures, slightly curved malleable

UG-1938
BIEMER

- ø 8 mm
 - ø 10 mm
 - ø 12 mm
- Curettes for aspiration lipectomy, with three apertures, slightly curved malleable

UG-1944

For aspirating fluid from the excretory ducts of large glands and for keeping the operating area clear
170 mm

UG-1947

Trocar
For puncturing
150 mm

UG-1950

For clearing large quantities of fluid
190 mm

Suction Instruments



UG-1955
Trocar
For puncturing
170 mm



UG-1958
Hollow needle,
sharp
150 mm



UG-1961
double curved
For general
surgery
230 mm



UG-1962
For tonsillectomy,
oral and laryngeal
operations
190 mm



UG-1963
For tonsillectomy,
oral and laryngeal
operations
220 mm

Suction Instruments

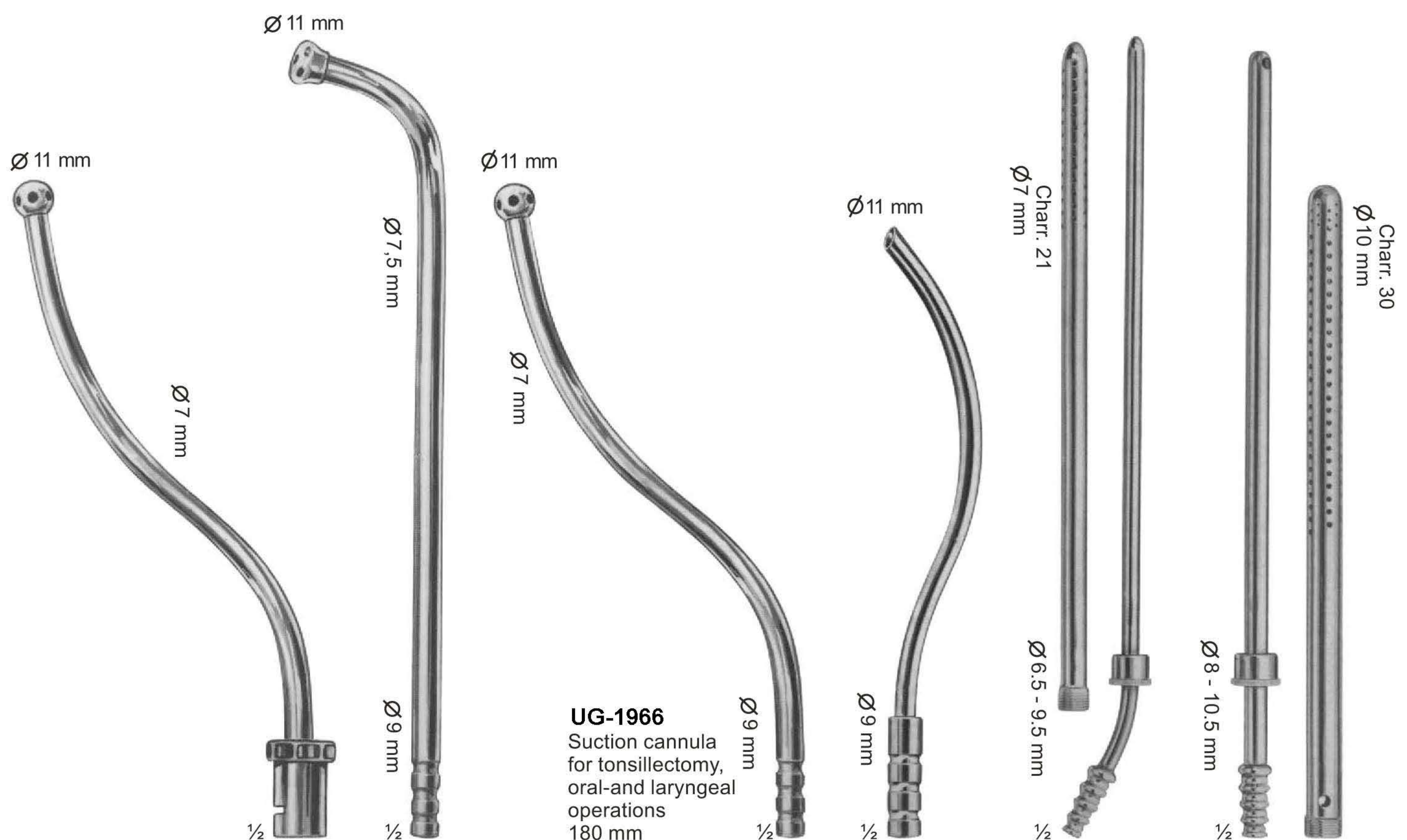

UG-1964
For tonsillectomy,
oral-and laryngeal
operations
180 mm

UG-1965
Suction cannula
for tonsillectomy,
oral-and laryngeal
operations
220 mm

UG-1966
Suction cannula
for tonsillectomy,
oral-and laryngeal
operations
180 mm

UG-1967
S-shaped blunt cannula
for aspirating fluid from
the excretory ducts of
large glands and for
keeping the operations
area clear
170 mm

UG-1968
POOL
Suction cannula,
with outer tube
to be screwed of
225 mm

UG-1970
POOL
Suction cannula,
with outer tube
to be screwed of
225 mm

Suction Instruments

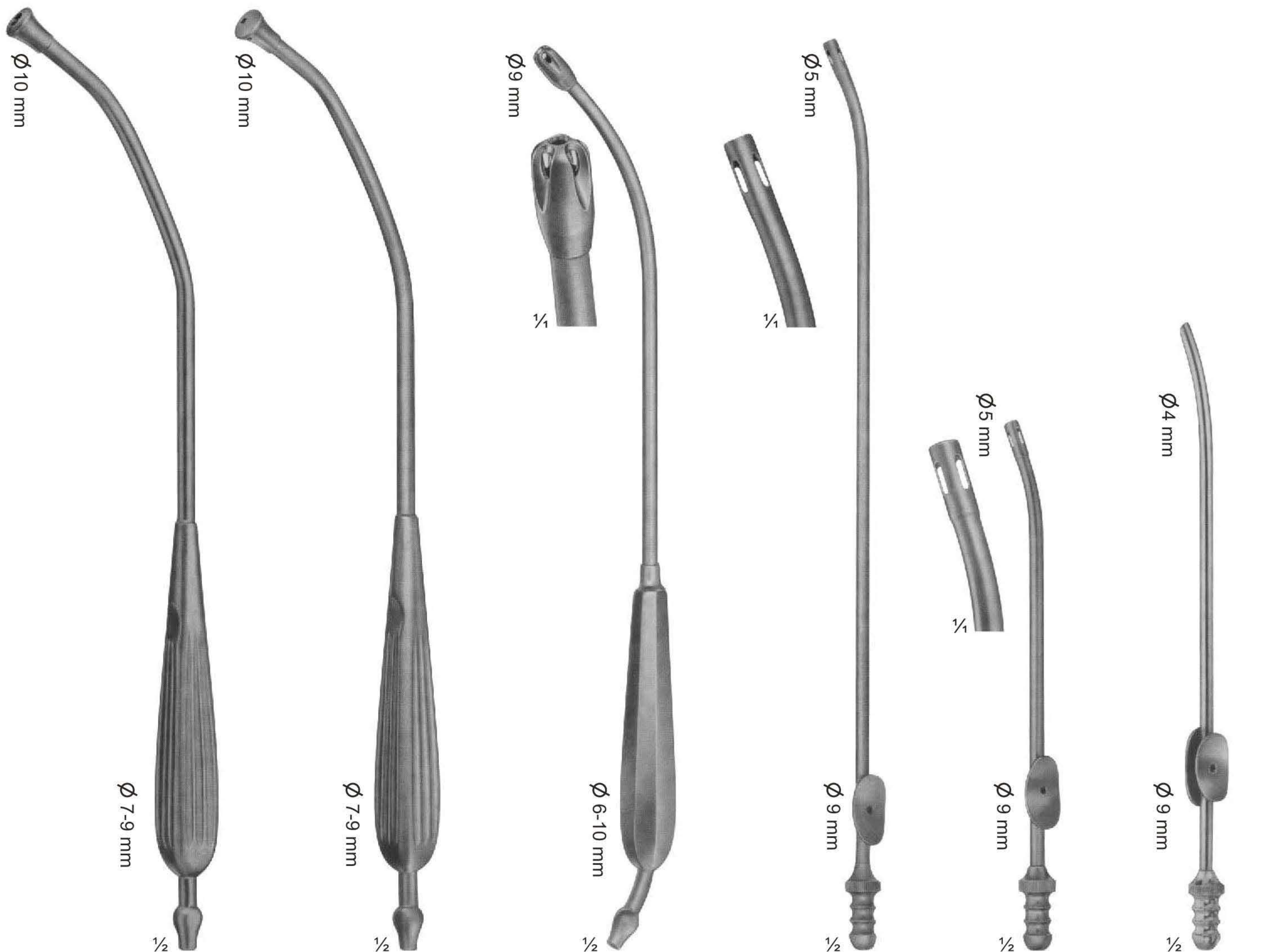

UG-1971
YANKAUER
with especially large
central bore, 4,8 mm
diam.
285 mm

UG-1972
YANKAUER
with central bore,
2,0 mm diam.
285 mm

UG-1973
DE-BAKEY
with central bore,
3,0 mm diam. with
lateral slots
275 mm

UG-1975
DE-BAKEY
with finger cut-off
and stylet
270 mm

UG-1977
DE-BAKEY
with finger cut-off
and stylet
160 mm

UG-1976
with finger
cut-off
190 mm

Suction Instruments



UG-1984
PLESTER
with finger cut-off and
stylet, thumb piece
parallel to curved, with
LUER hub
195 mm



UG-1989
FERGUSSON
with finger cut-off and
stylet, thumb piece
90° to curved, with
LUER hub
180 mm



UG-1991 ∅ 4,0 mm
FERGUSSON
insulated, with finger cut-off
and stylet, thumb piece 90°
to curved, with LUER hub
180 mm



UG-1992 ∅ 5,0 mm
FRAZIER
insulated, with finger
cut-off and stylet, thumb
piece 90° to curved,
with LUER hub
180 mm



UG-1994
5,0 mm diam., Tip
6,5 mm wide, Nasal
suction tube, with
LUER hub
180 mm



UG-1995
Nasal suction
tubes
175 mm



UG-1999
GORNEY
Suction dissector
180 mm



4 mm wide
UG-20015
15 mm wide
Suction raspatories,
sharp, bayonet-shaped,
with stylet
200 mm



UG-2002
LOPEZ-REINKE
Tonsil dissector with
suction device
235 mm

Suction Instruments

UG-2003
WULLSTEIN
Suction tube, conical, silver, oliver
with LUER hub
160 mm

$\varnothing 1,75$ mm

$\varnothing 3$ mm
 $\frac{1}{2}$
 $\varnothing 8$ mm

UG-2004
WULLSTEIN
Suction tube, cylindrical, silver, with
stylet with LUER hub
160 mm

1,5 mm
2,0 mm

$\frac{1}{2}$
 $\varnothing 8$ mm

Usable length

YASARGIL usable length diam.		YASARGIL usable length diam.	
UG-2005	130 mm 1,5 mm	UG-2013	130 mm 2,5 mm
UG-2006	150 mm 1,5 mm	UG-2014	150 mm 2,5 mm
UG-2007	180 mm 1,5 mm	UG-2015	180 mm 2,5 mm
UG-2008	220 mm 1,5 mm	UG-2016	220 mm 2,5 mm
UG-2009	130 mm 2,0 mm	UG-2017	130 mm 3,5 mm
UG-2010	150 mm 2,0 mm	UG-2018	150 mm 3,5 mm
UG-2011	180 mm 2,0 mm	UG-2019	180 mm 3,5 mm
UG-2012	220 mm 2,0 mm	UG-2020	220 mm 3,5 mm
		UG-2021	180 mm 4,5 mm

$\varnothing 6,5-9$ mm
with LUER hub

UG-2022
LANDOLT
150 MM
diam $\varnothing 3$ mm

8 mm / curved
11mm / curved
15mm / curved

$\frac{1}{2}$
 $\frac{1}{2}$

$\varnothing 3.5$ mm

$\varnothing 2.0$ mm

UG-2023 500 mm
UG-2024 350 mm
with rubber tip,
with LUER hub

$\varnothing 9$ mm
 $\frac{1}{2}$

UG-2025 2,0 mm diam
UG-2026 2,5 mm diam
UG-2027 3,0 mm diam
with finger cut-off,
thumb piece 90° to
curved, with LUER hub
250 mm

$\varnothing 6-9$ mm
 $\frac{1}{2}$

Combined Suction and Irrigation Cannulae



UG-1947
FINSTERER
320 mm

Ø9-13 mm 1/2

Ø15 mm



Ø 2 mm

Ø 4,5 mm

UG-1974
YASARGIL
LURE-LOCK cone
200 mm

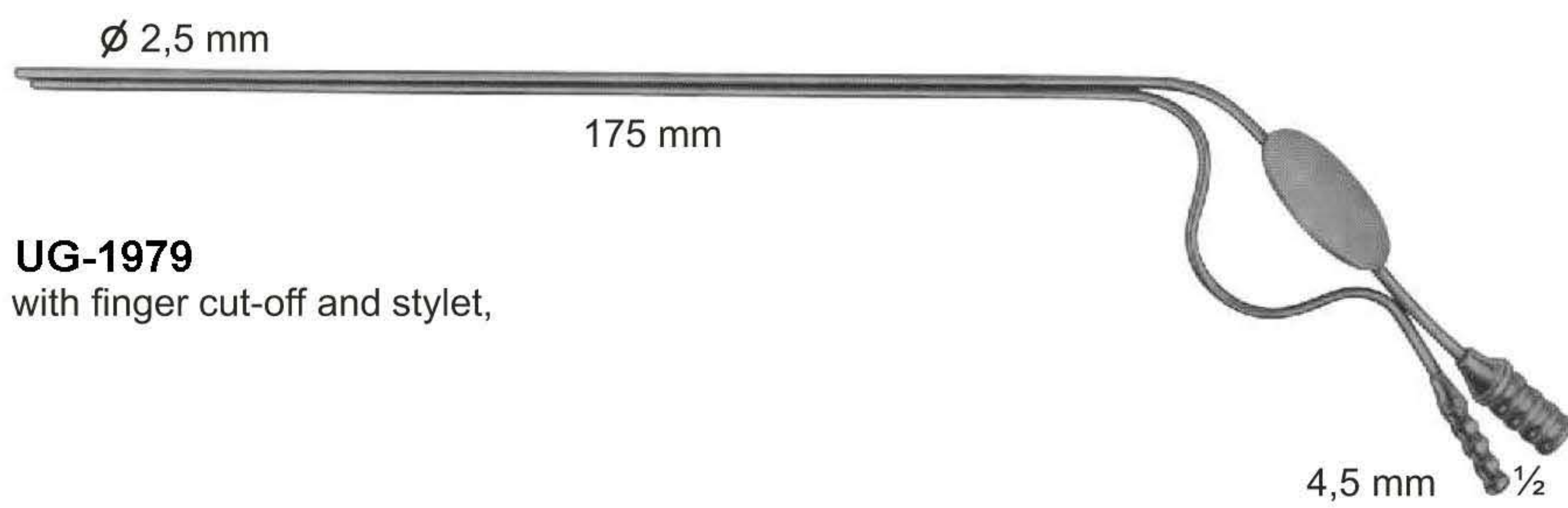

Ø 2,5 mm

175 mm

UG-1979
with finger cut-off and stylet,

4,5 mm 1/2

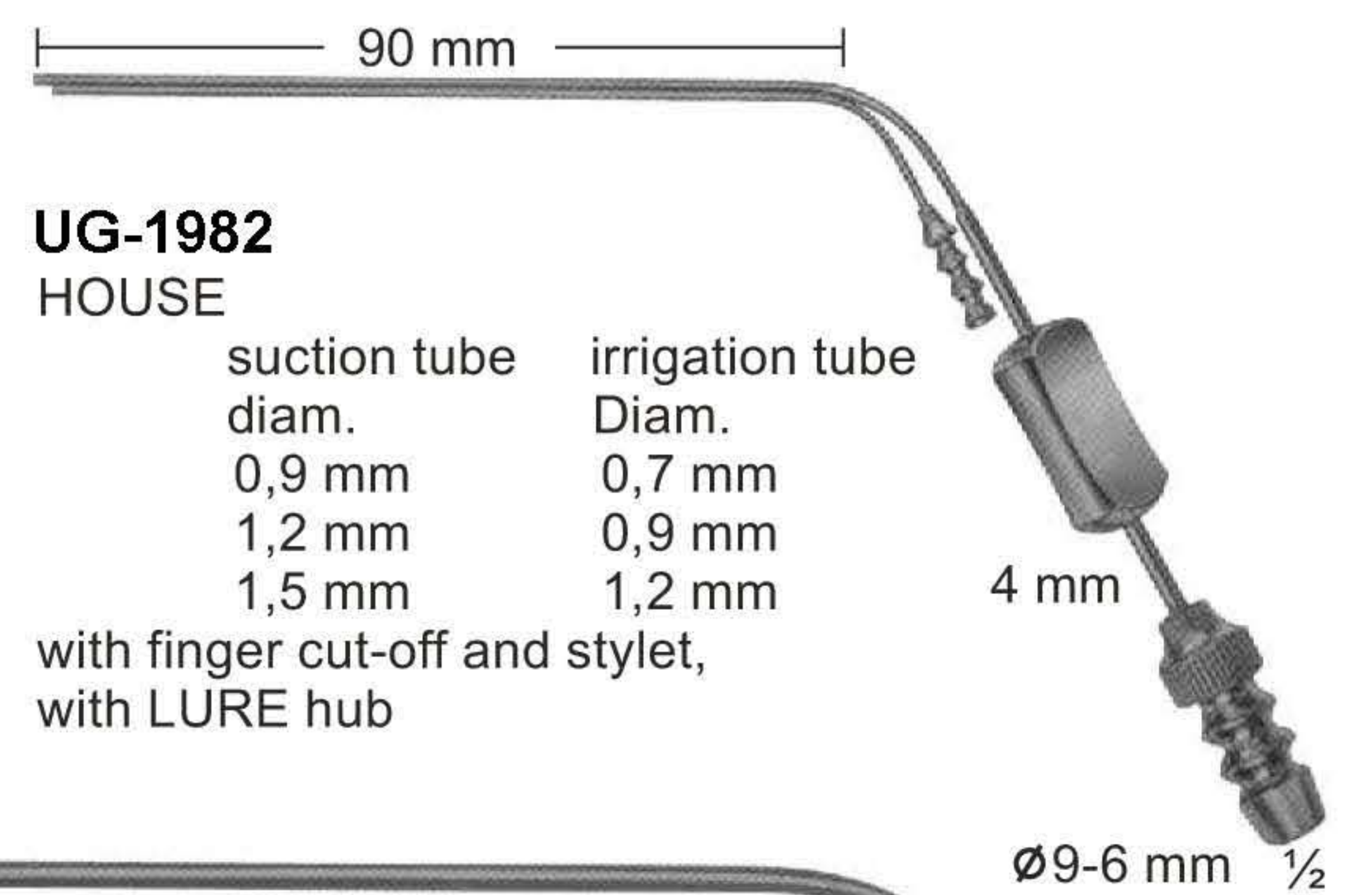

90 mm

UG-1982
HOUSE

suction tube diam.	irrigation tube Diam.
0,9 mm	0,7 mm
1,2 mm	0,9 mm
1,5 mm	1,2 mm

with finger cut-off and stylet,
with LURE hub

4 mm

Ø9-6 mm 1/2

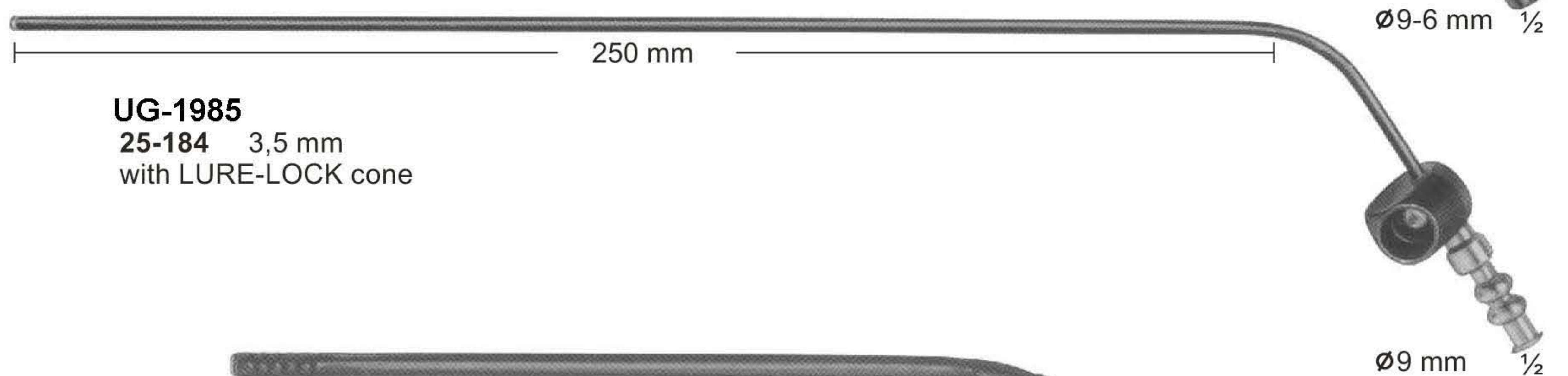

UG-1985
25-184 3,5 mm
with LURE-LOCK cone

250 mm

Ø9 mm 1/2

UG-1987
LANDOLT
with finger cut-off and stylet, can be sterilized in an autoclave up to 3 bar (143 °C)

Connection for suction hose

Ø 7,5-12 mm

4 mm diam., Untrashed contact to be touched by HF-electrodes

1/2

Scissors with Tungsten Carbide Inserts



UG-1990
Standard



UG-1993
Standard



UG-1996
Standard



UG-1997
Standard



UG-1998
Standard



UG-2000
Standard

Scissors with Tungsten Carbide Inserts



UG-1969
Mayo-Lexer



UG-1978
Mayo-Lexer



UG-1981
Lexer



UG-1983
Lexer



UG-1986
Mayo-Stille



UG-1988
Mayo-Stille

Scissors with Tungsten Carbide Inserts



$\frac{1}{2}$
UG-1853
Metzenbaum



$\frac{1}{2}$
UG-1895
Metzenbaum



$\frac{1}{2}$
UG-1900
Metzenbaum



$\frac{1}{2}$
UG-1917
Metzenbaum-Fino



$\frac{1}{2}$
UG-1928
Metzenbaum-Fino



$\frac{1}{2}$
UG-1948
Metzenbaum-Fino

Scissors with Tungsten Carbide Inserts



Scissors with Tungsten Carbide Inserts



1/2

UG-1816
Parametrium



1/2

UG-1822
Mayo-Harrington



1/2

UG-1824
Sims

Scissors with Tungsten Carbide Inserts

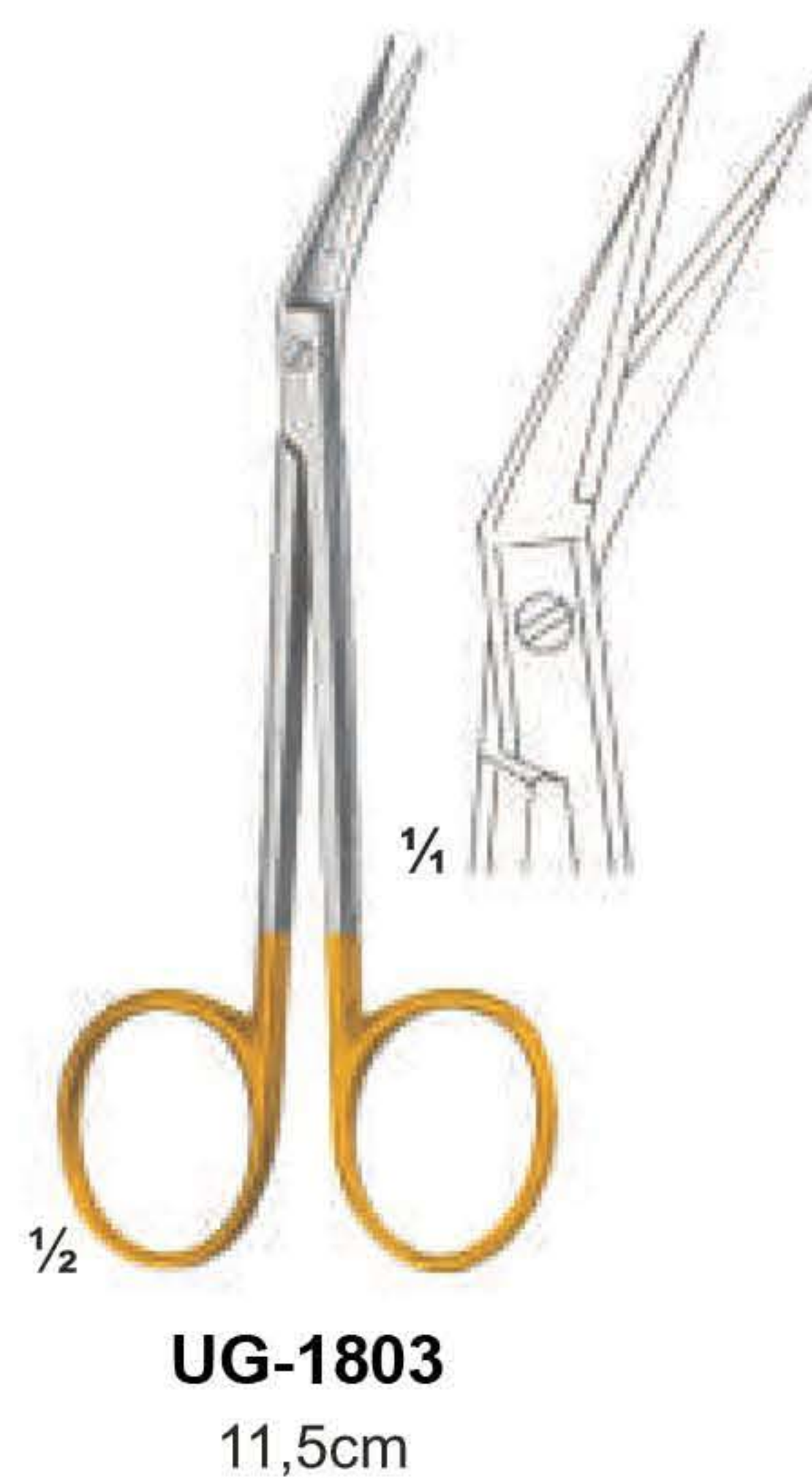
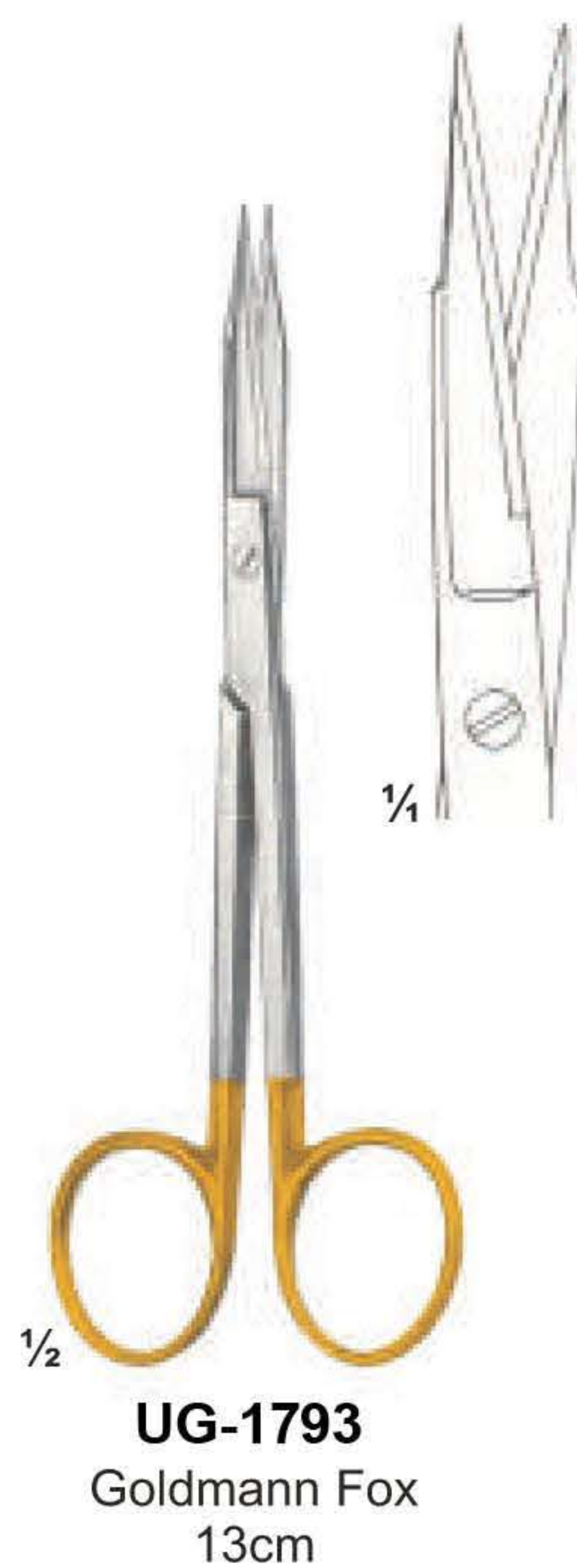

Scissors & Dissecting Forceps with Tungsten Carbide Inserts

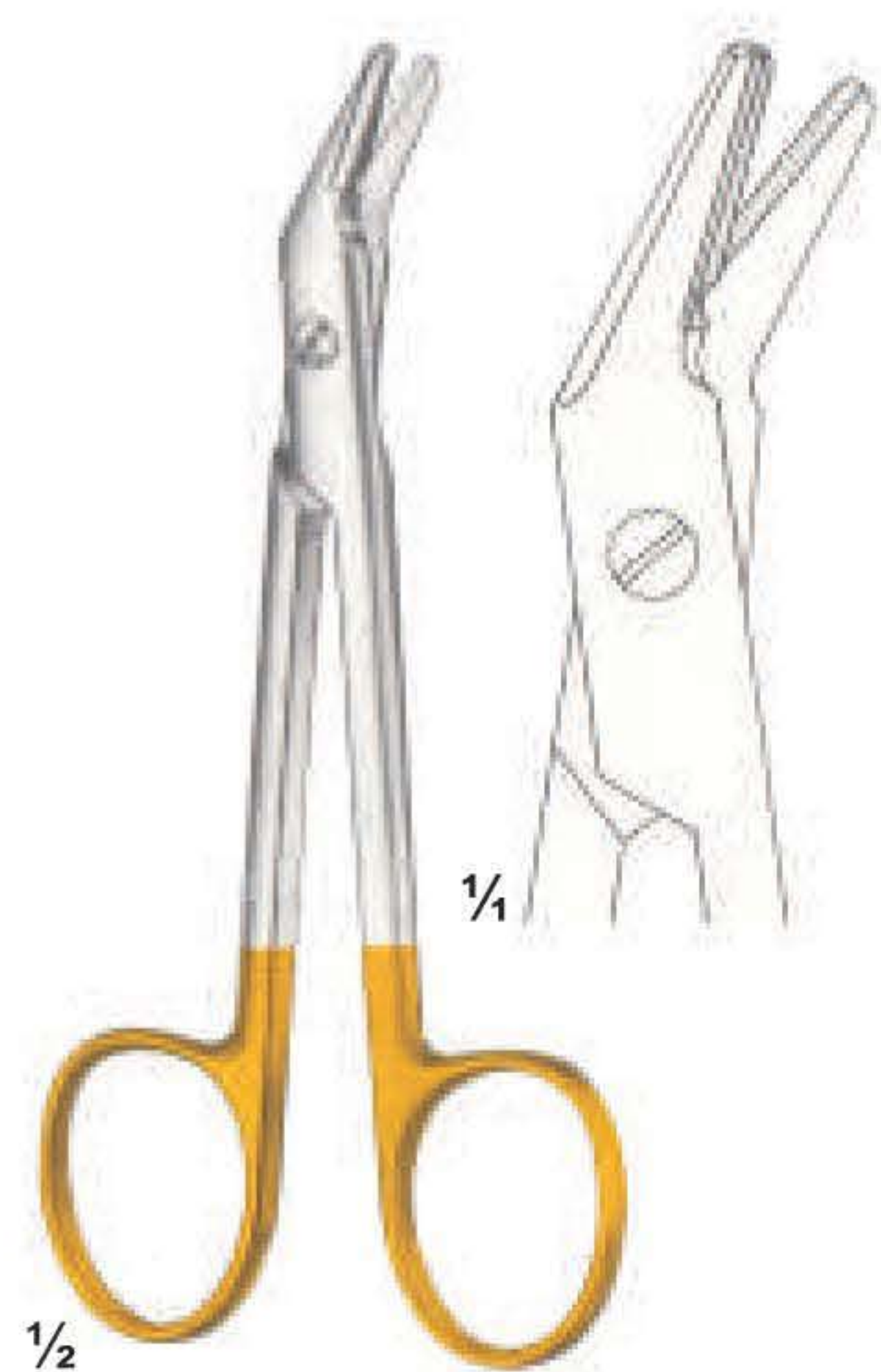

UG-1709
Universal
12cm



UG-1711
Ligature Scissors
1 Black & 1 Goldplated ring



UG-1714
Adson



UG-1717
Cushing
17,5cm



UG-1719
Cushing
18cm



UG-1721
Cushing-Taylor
18cm



UG-1722
Dissecting Forceps
15cm



UG-1723
Semken
15cm

Dissecting Forceps and Needle holders with Tungsten Carbide Inserts



$\frac{1}{2}$
UG-1687
Wangensteen



$\frac{1}{2}$
UG-1688
Potts-Smith



$\frac{1}{2}$
UG-1698
Oehler



$\frac{1}{2}$
UG-1701
Potts-Smith
22cm



$\frac{1}{2}$
UG-1701
Hepp-Scheidle
18cm

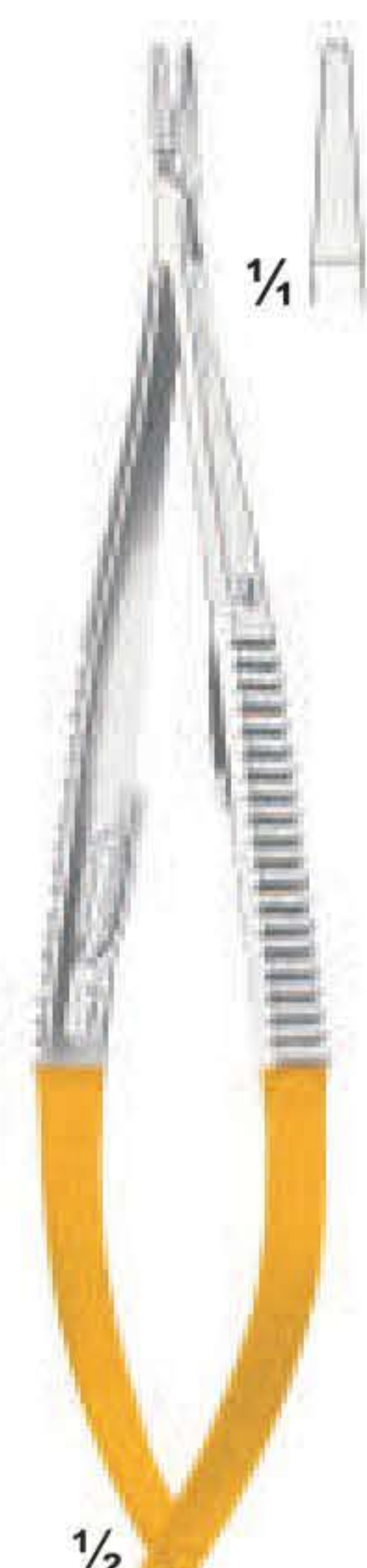

$\frac{1}{2}$
UG-1704
Castroviejo
14cm



$\frac{1}{2}$
UG-1706
Castroviejo
14cm



$\frac{1}{2}$
UG-1707
Arruga
16cm

Needle holders with Tungsten Carbide Inserts



UG-1209
Arruga
16cm



UG-1212
Castroviejo
13cm



UG-1213
Hegar
20cm 24cm



UG-1219
Halsey
13cm 15cm



UG-1225
Mayo-Hegar
16cm 18cm 20cm
24cm 26cm 30cm



UG-1316
De-Bakey
18cm 20cm 23cm
26cm 31cm 37cm



UG-1317
Hegar-Vascular
14cm 18cm
20cm 23cm

Needle holders with Tungsten Carbide Inserts



UG-1133
Bozemann-Wertheim
20cm 24cm 26cm



UG-1137
Stratte
22cm 23cm



UG-1139
Ryder
13cm 15cm 18cm
20cm 23cm 26cm



UG-1146
Ryder-Vascular
13cm 15cm 18cm
20cm 23cm 26cm



UG-1195
Martin
15cm 17cm 20cm



UG-1201
Sarot
18cm 20cm 26cm

Needle holders with Tungsten Carbide Inserts



Needle holders with Tungsten Carbide Inserts



$\frac{1}{2}$ **UG-1056**
Mathieu-Ryder
17cm
20cm 24cm



$\frac{1}{2}$ **UG-1057**
Lichtenberg
20cm



$\frac{1}{2}$ **UG-1059**
Langhals
20cm 25cm



$\frac{1}{2}$ **UG-1062**
Lichtenberg
20cm 25cm



$\frac{1}{2}$ **UG-1064**
Luehty-Beck
20cm 25cm



$\frac{1}{2}$ **UG-1065**
Luehty-Beck
20cm 25cm



$\frac{1}{2}$ **UG-1066**
Langebeck
18cm
20cm 23cm



$\frac{1}{2}$ **UG-1068**
Langebeck-beck
18cm
20cm 23cm

Hospital Wares



UG-1032
Schimmelbusch

UG-1032 Ø x H
sizes in mm

80 x 80
105 x 120
140 x 140

160 x 120
160 x 150
190 x 150

190 x 190
240 x 160
240 x 240

290 x 160
290 x 240
340 x 160
340 x 340

390 x 190
390 x 290

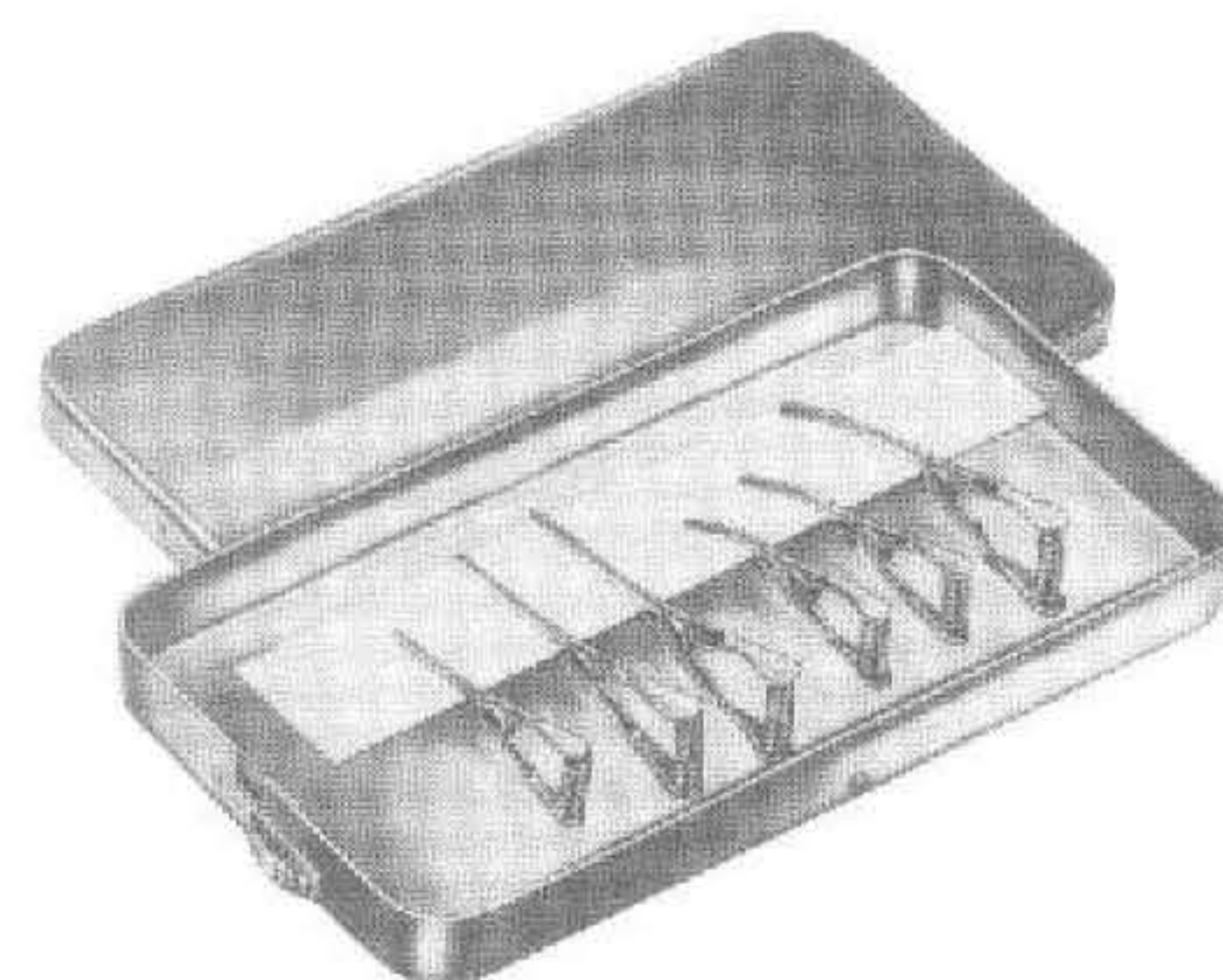

UG-1046

Box
120 x 65 x 13mm
(without Bulldog clamps,
without silicone tape)



UG-1047

Box with support
120 x 65 x 13 mm
(ohne Bulldogklemmen)



UG-1048

Box with support for
needle electrodes,
without instruments

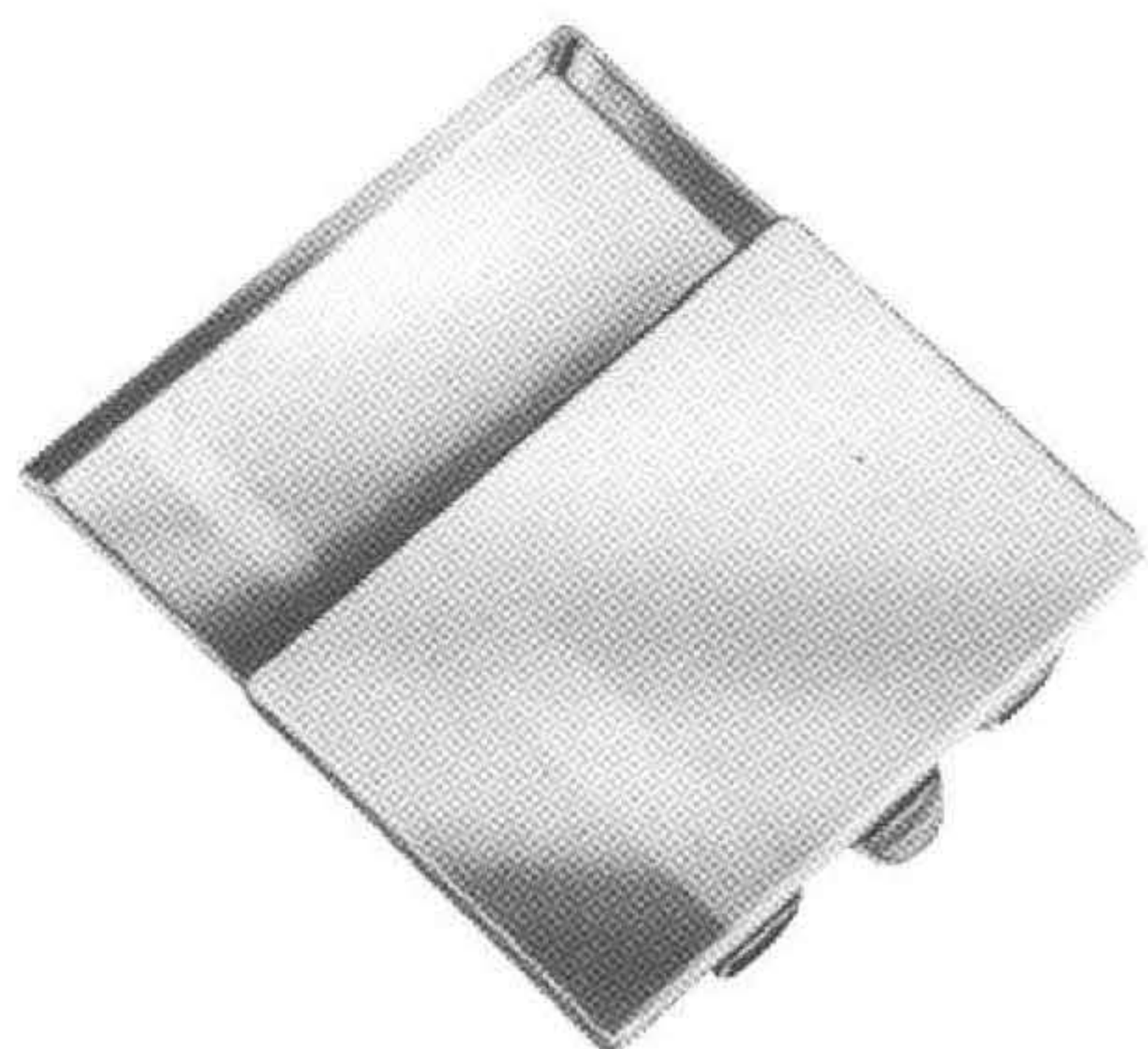

UG-1049

50 x 25 x 4,5 mm

65 x 42 x 8 mm

75 x 25 x 4,5 mm

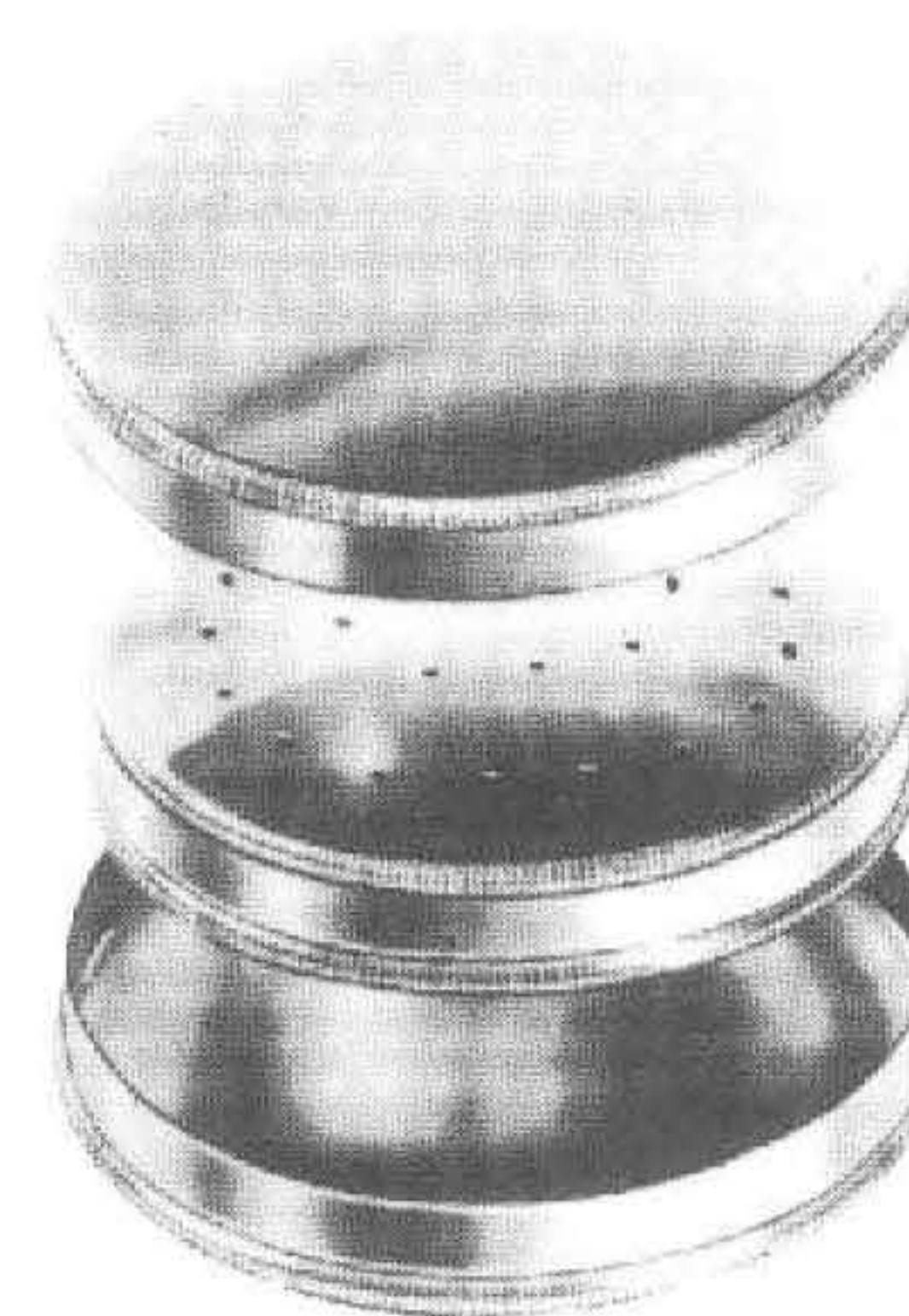

UG-1050

Ø 65mm x 15mm

Hospital Wares



UG-992

\varnothing x H
30 x 90 mm
50 x 100 mm
50 x 130 mm
50 x 175 mm
75 x 100 mm
75 x 130 mm
75 x 175 mm
100 x 175 mm
100 x 200 mm



UG-1024

165 x 85 x 35	mm
200 x 100 x 35	mm
200 x 100 x 50	mm
230 x 130 x 50	mm
260 x 150 x 50	mm
270 x 235 x 50	mm
300 x 200 x 50	mm
325 x 275 x 50	mm



UG-1029

205 x 105 x 35 mm

Forceps Jars

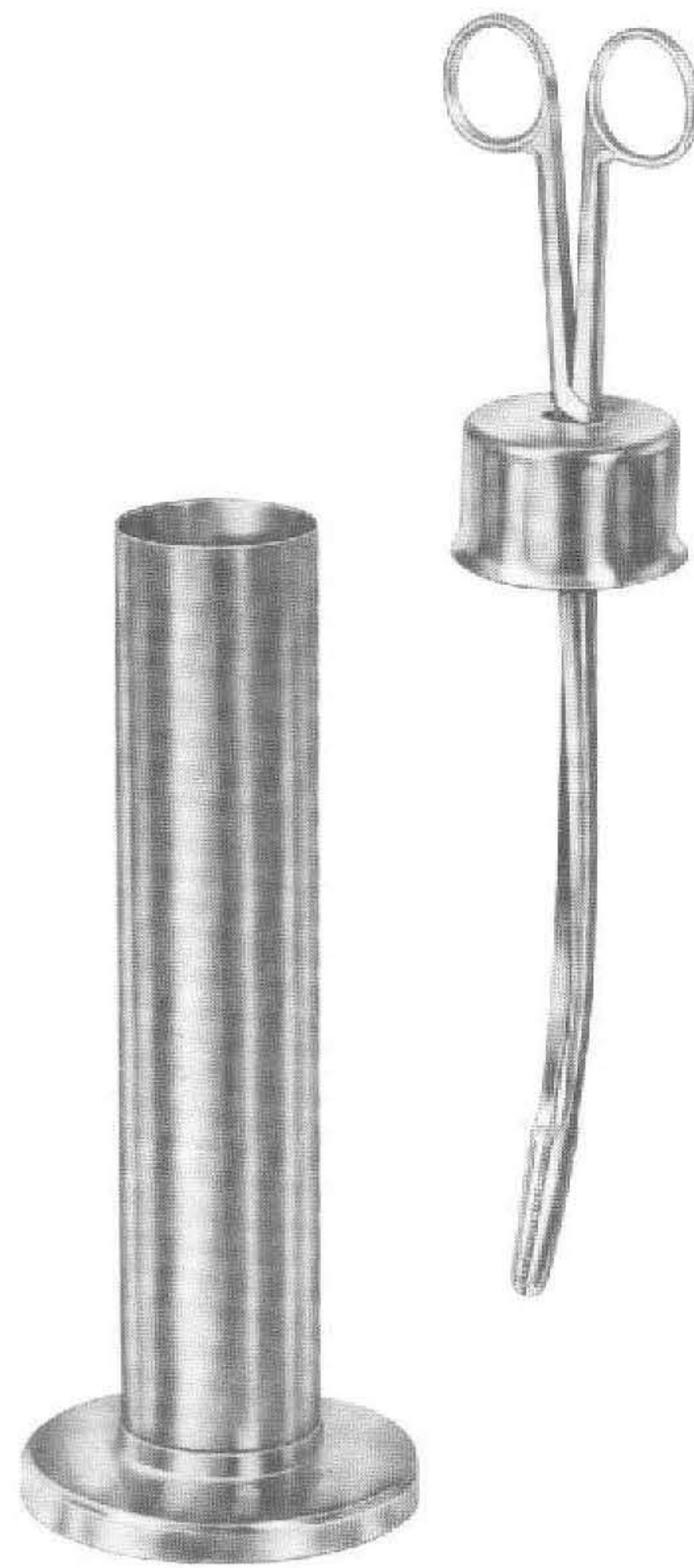
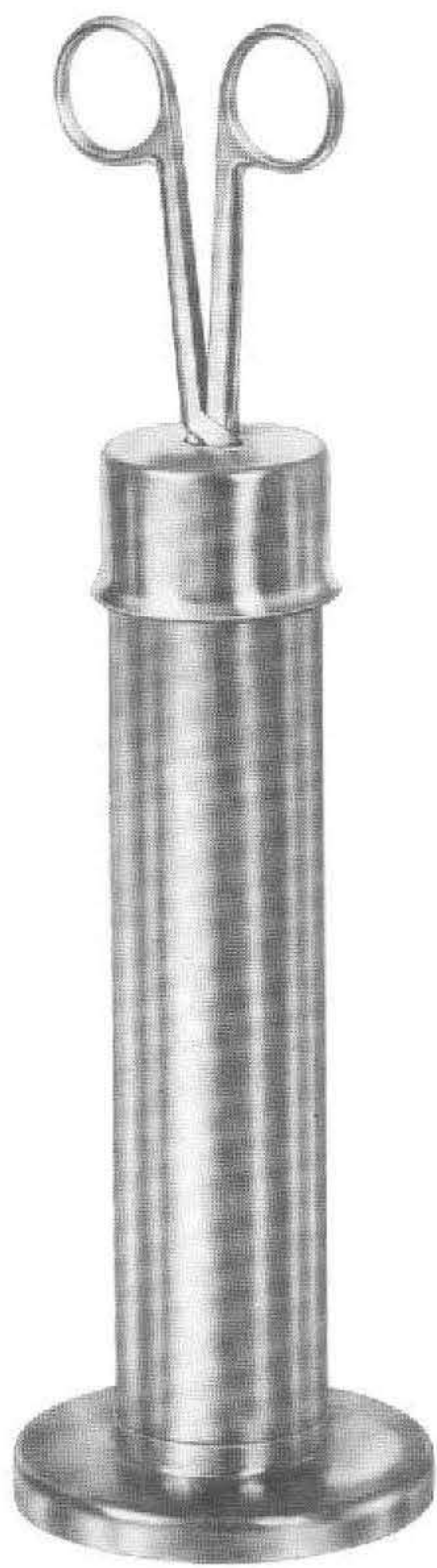

UG-961

Martin Sterilizing Forceps
consisting of:
1 Sterilizing Forceps, curved, 25 cm,
without ratchet, with lid for jar
1 jar with bottom plate (anti-tilt)
ditto, with 32 cm long Sterilizing Forceps

Round Metal Boxes and Medicine Cups



UG-939

Ø x H
 75 x 60 mm
 75 x 75 mm
 100 x 60 mm
 100 x 100 mm
 125 x 80 mm
 125 x 125 mm
 150 x 150 mm

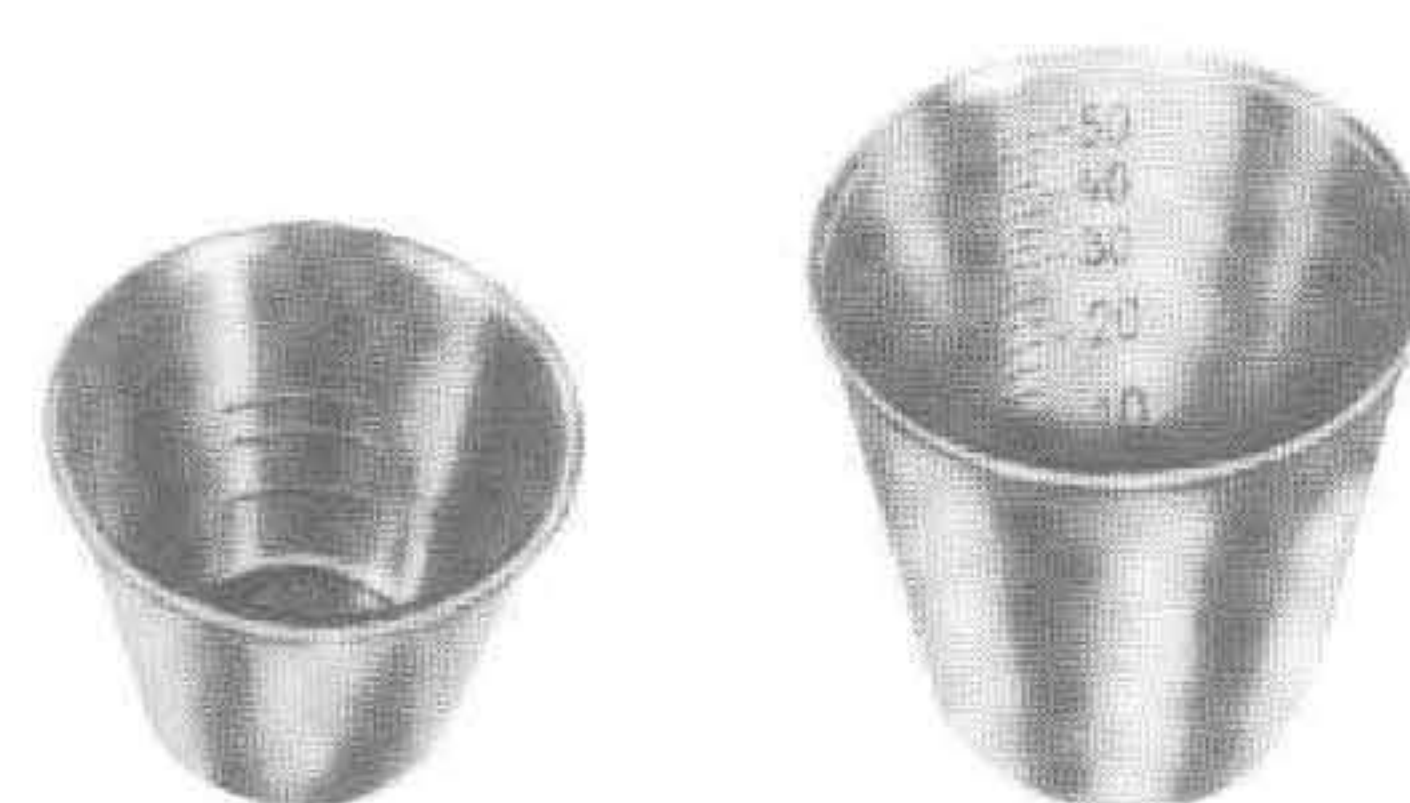

UG-944
25 cc

UG-945
50 cc



UG-946
20 cc
Medicine Spoon



UG-947
Ø75 x 12 mm
Tablet Tray



UG-949
Ø90 x 90 mm
Metal Cup



UG-950
Ø75 x 80 mm
Sputum Cup

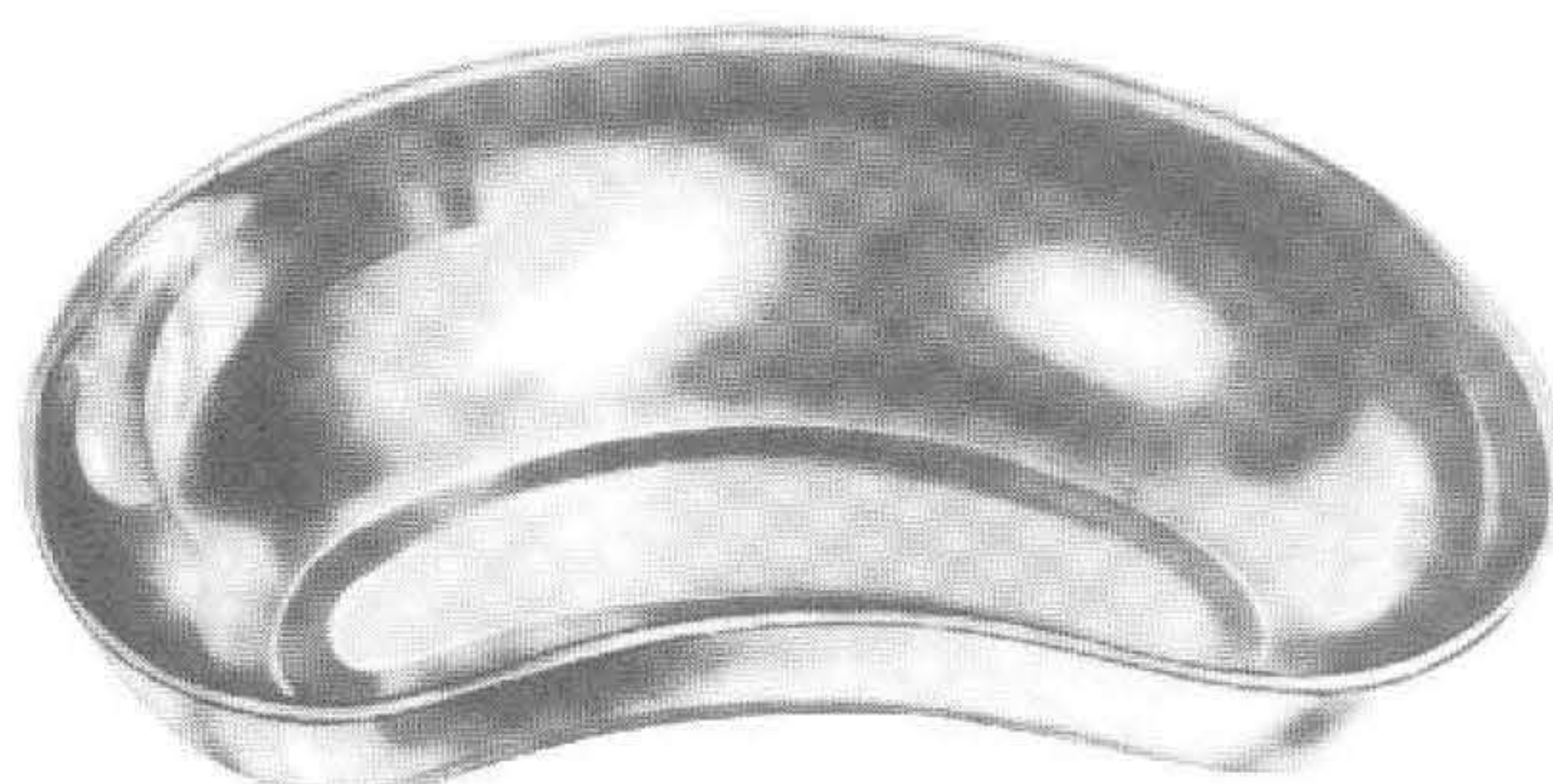

Kidney Dish

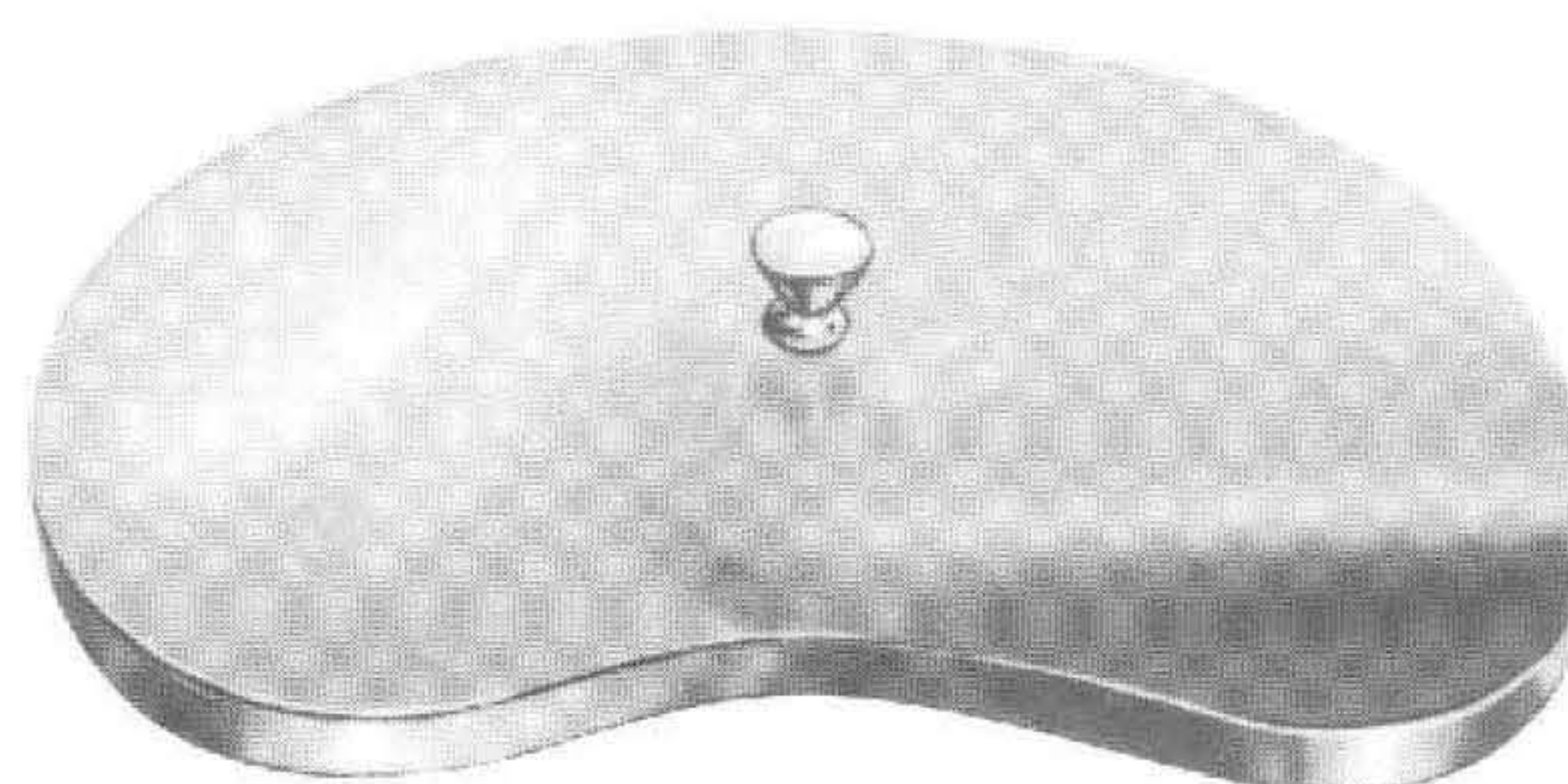

UG-952

170 x 100 x 35 mm
 250 x 140 x 40 mm
 275 x 150 x 45 mm

Hospital Wares

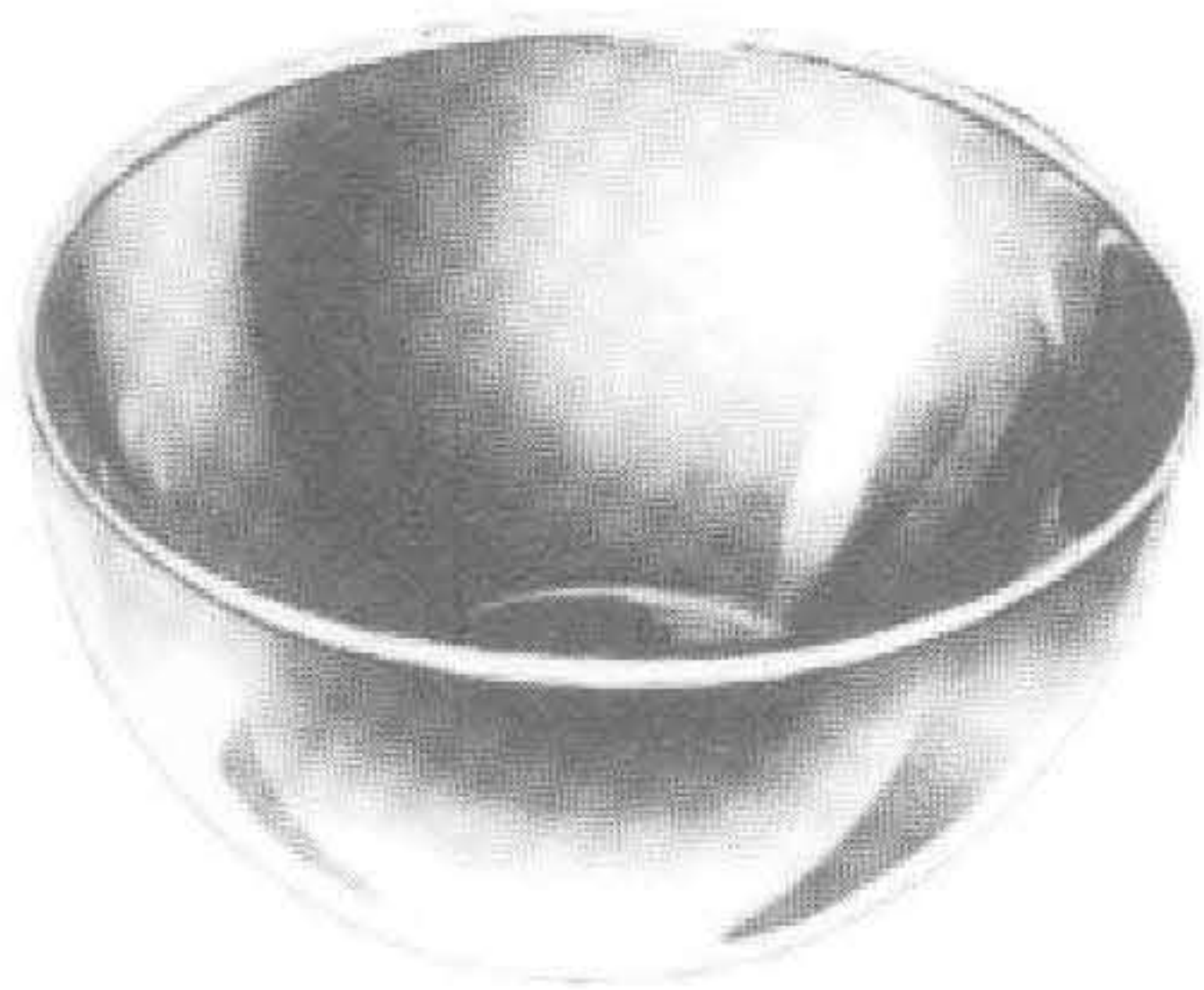

UG-533

Ø x H		
40 x 19	mm	0.05L
61 x 30	mm	0.07L
80 x 40	mm	0.14L
116 x 50	mm	0.35L
128 x 55	mm	0.45L
147 x 65	mm	0.70L
167 x 75	mm	1.10L
187 x 85	mm	1.60L

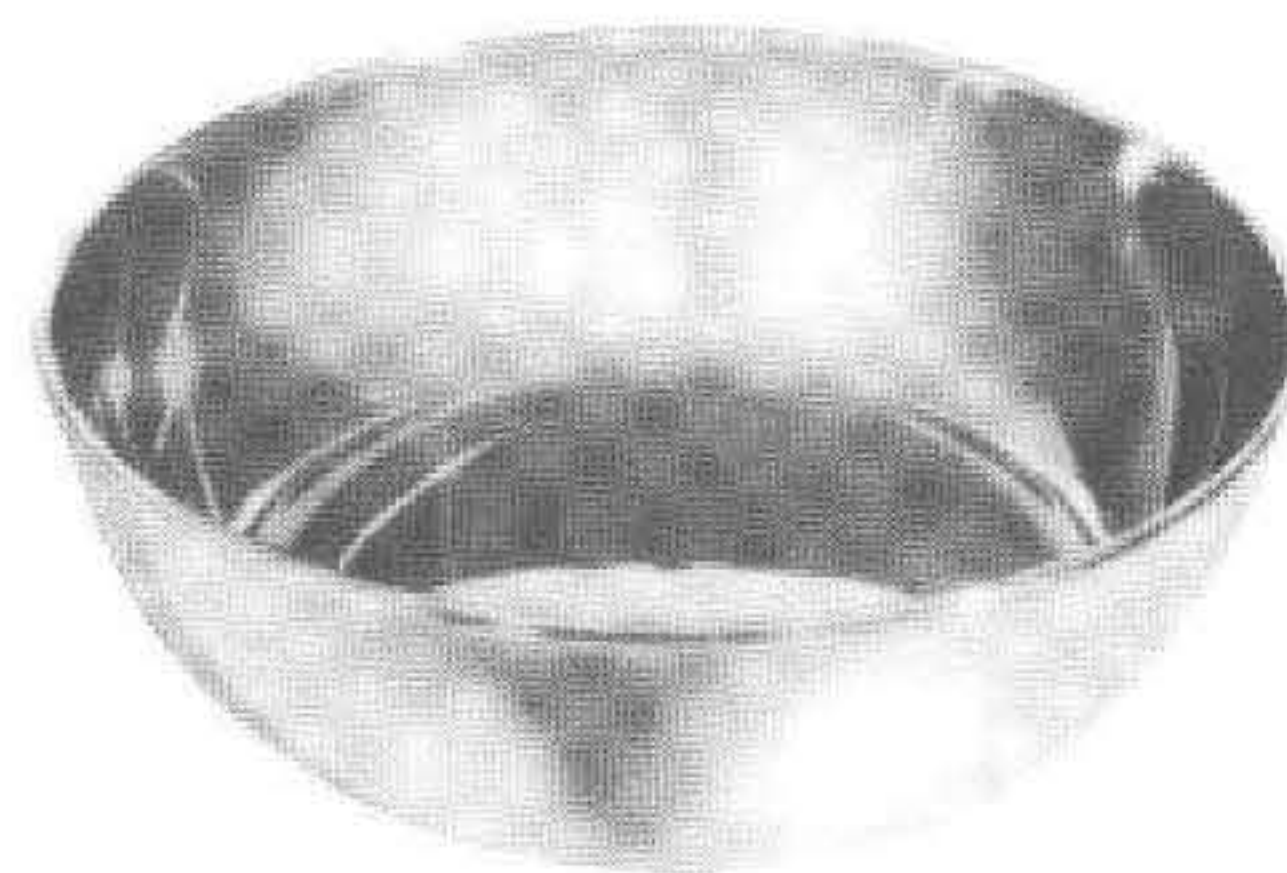

UG-668

116 x 35	mm	0.30L
128 x 38	mm	0.40L
147 x 40	mm	0.50L
157 x 45	mm	0.75L
187 x 45	mm	1.00L

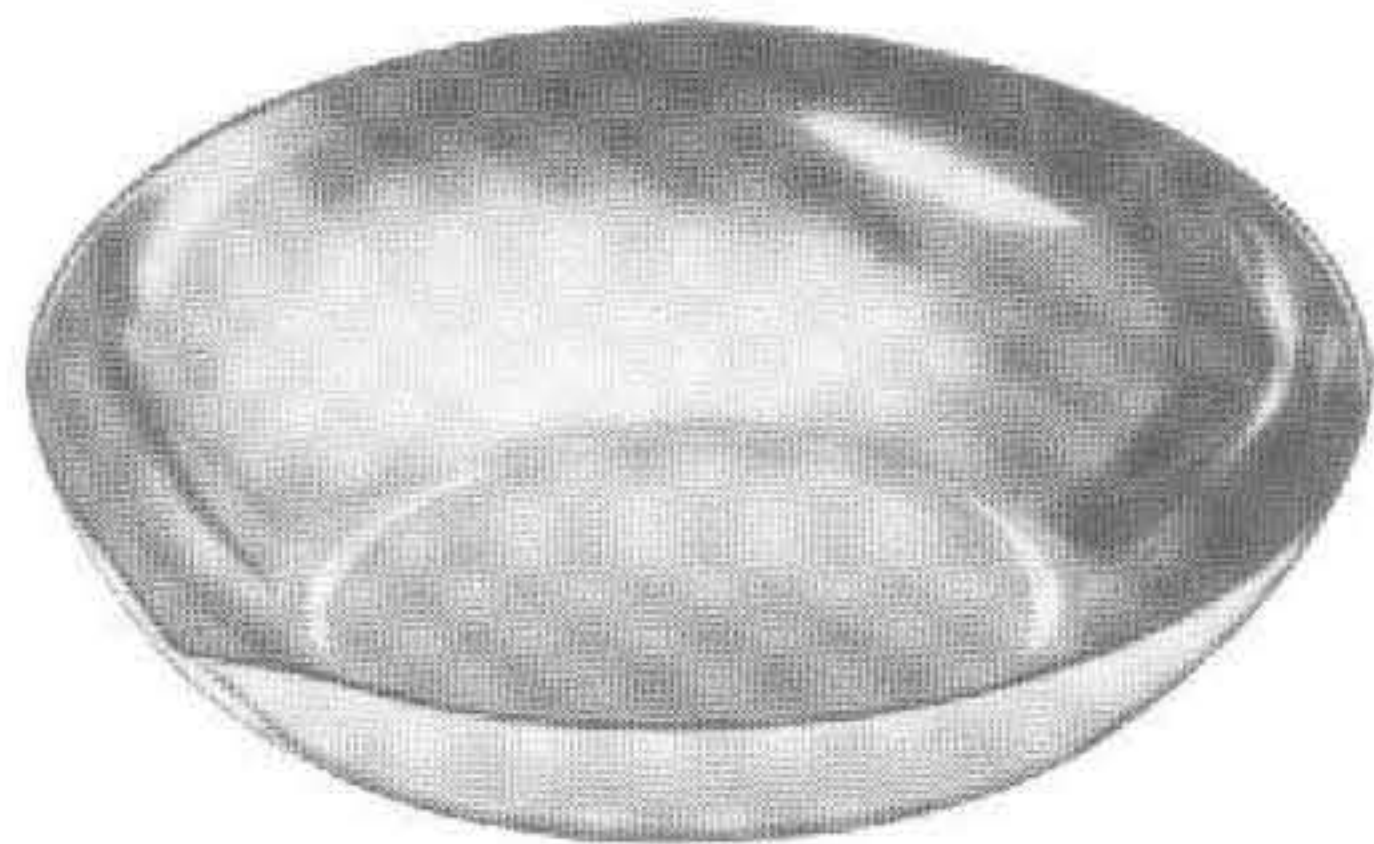

UG-682

Ø 110 x 28 mm 0.15L

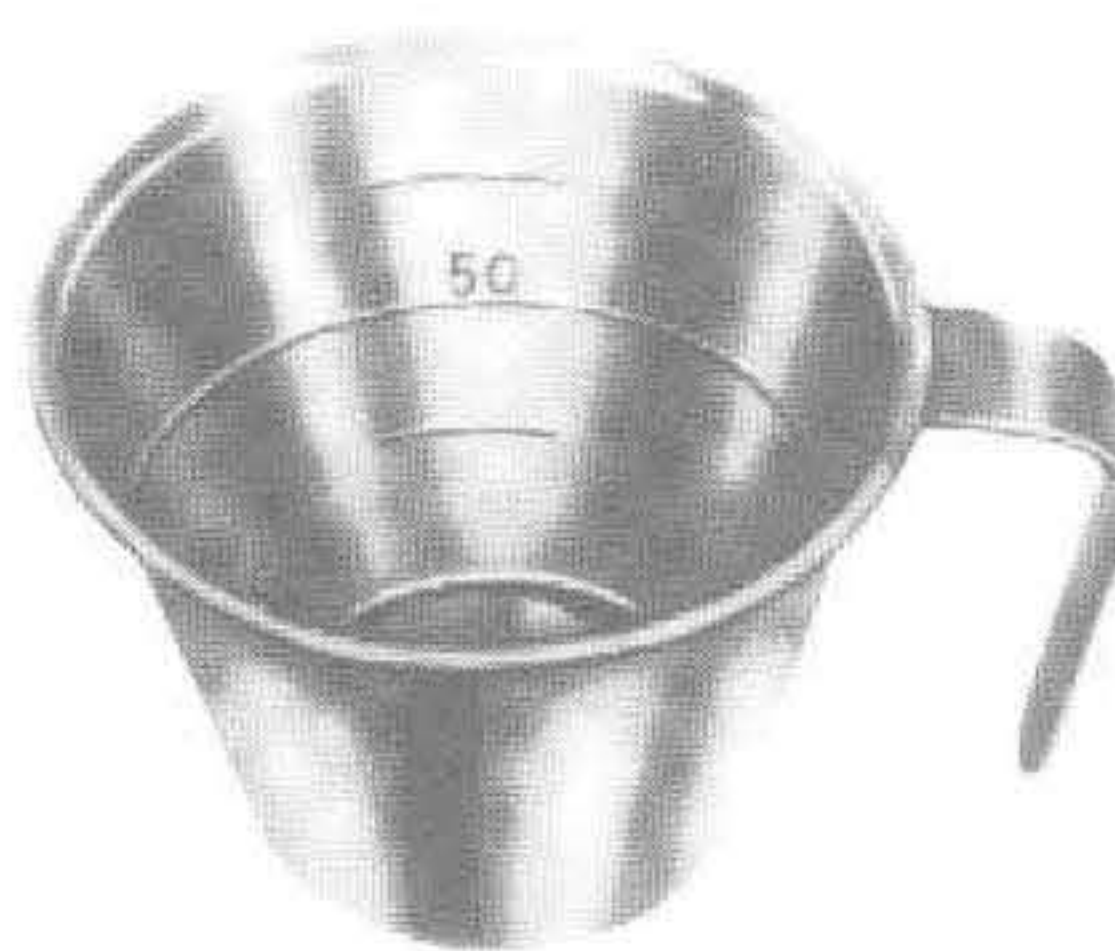

UG-719

100 cc 0.1L



UG-934

0,25L
0,50L
1,00L
2,00L



UG-935

235 x 190 x 40 mm



UG-936

Ø 220 x 70 mm

Hospital Wares

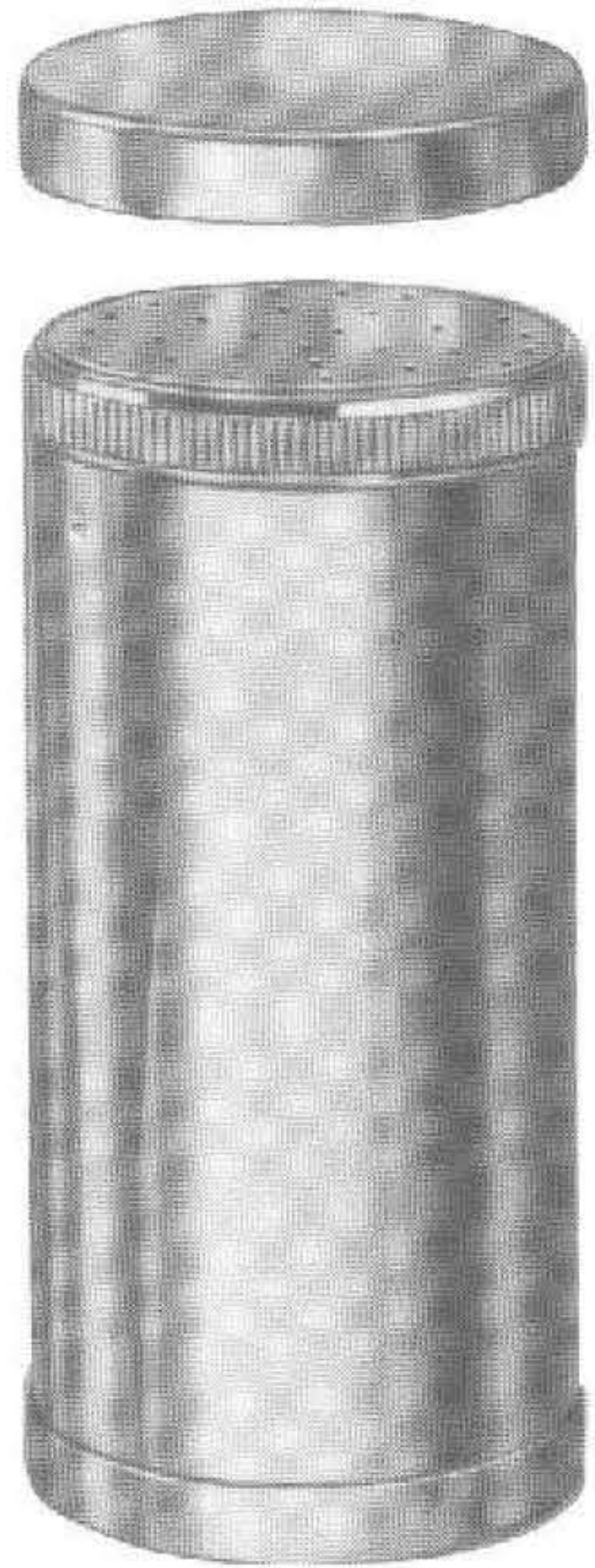

UG-519
Ø 50 x 100 mm
Powder Pot

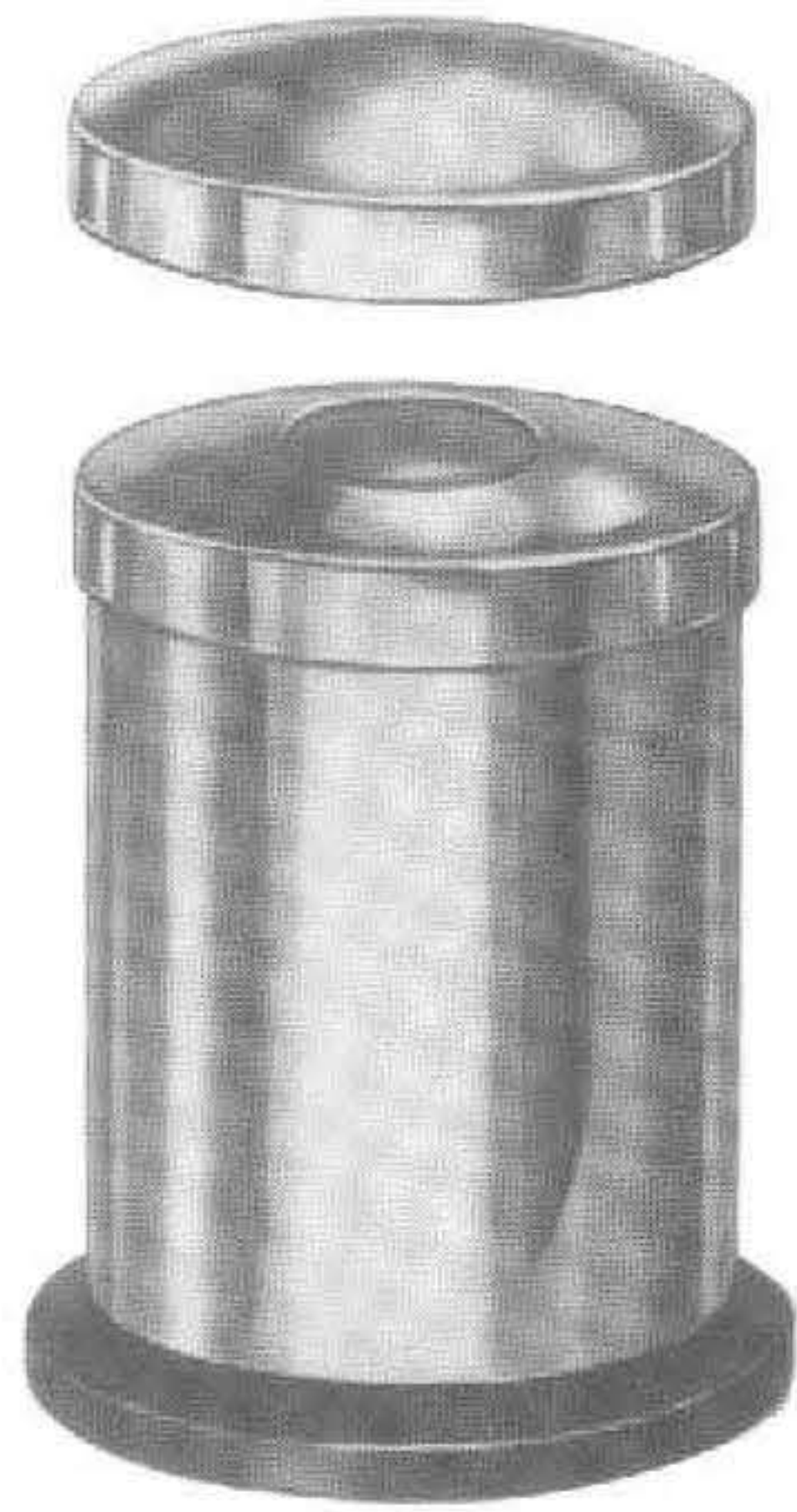

UG-521
Ø 50 x 75 mm
Methot With Lid



UG-523
Ø 50 x 75 mm
Methot Without Lid

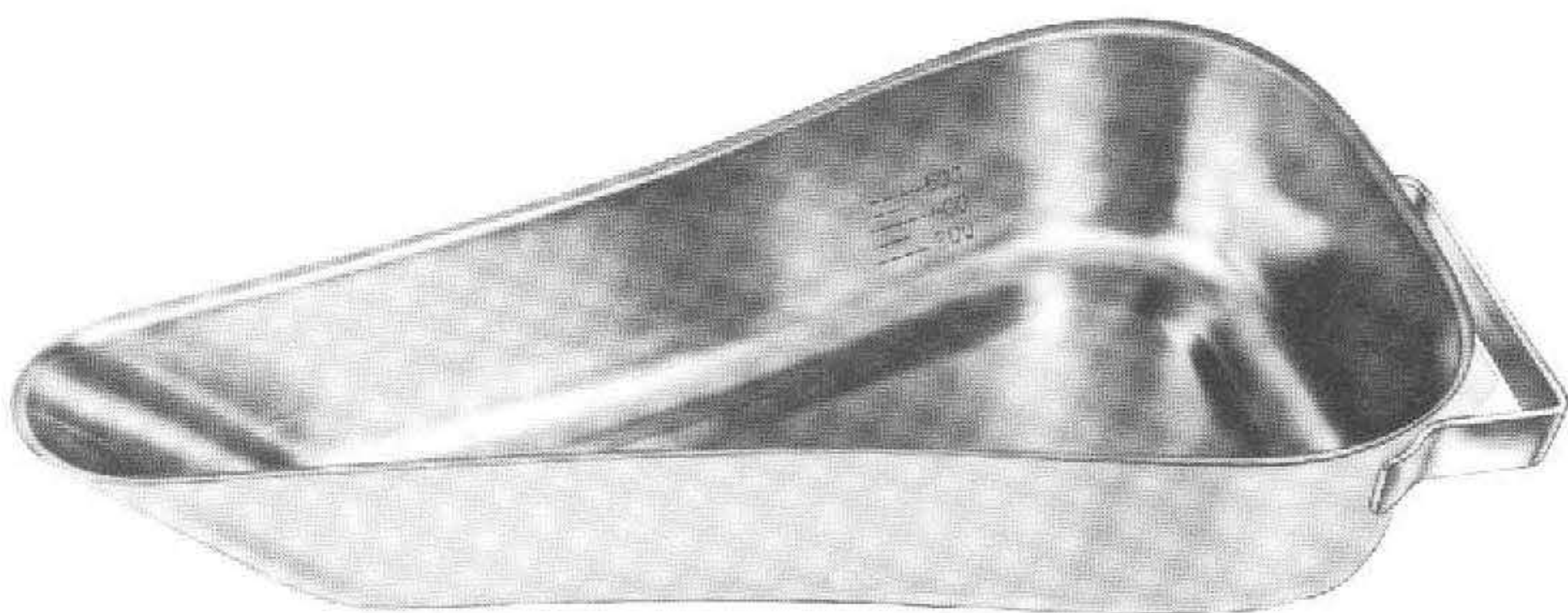

UG-526

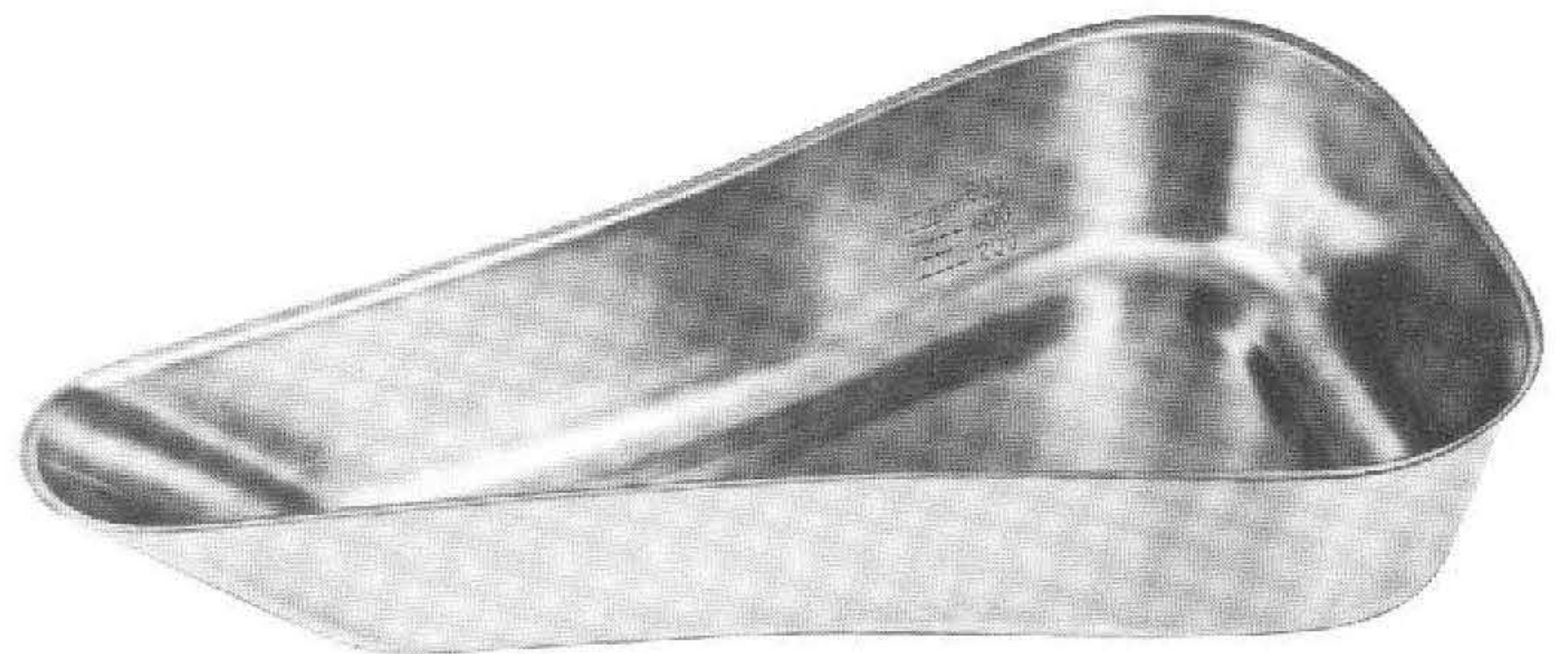

UG-526

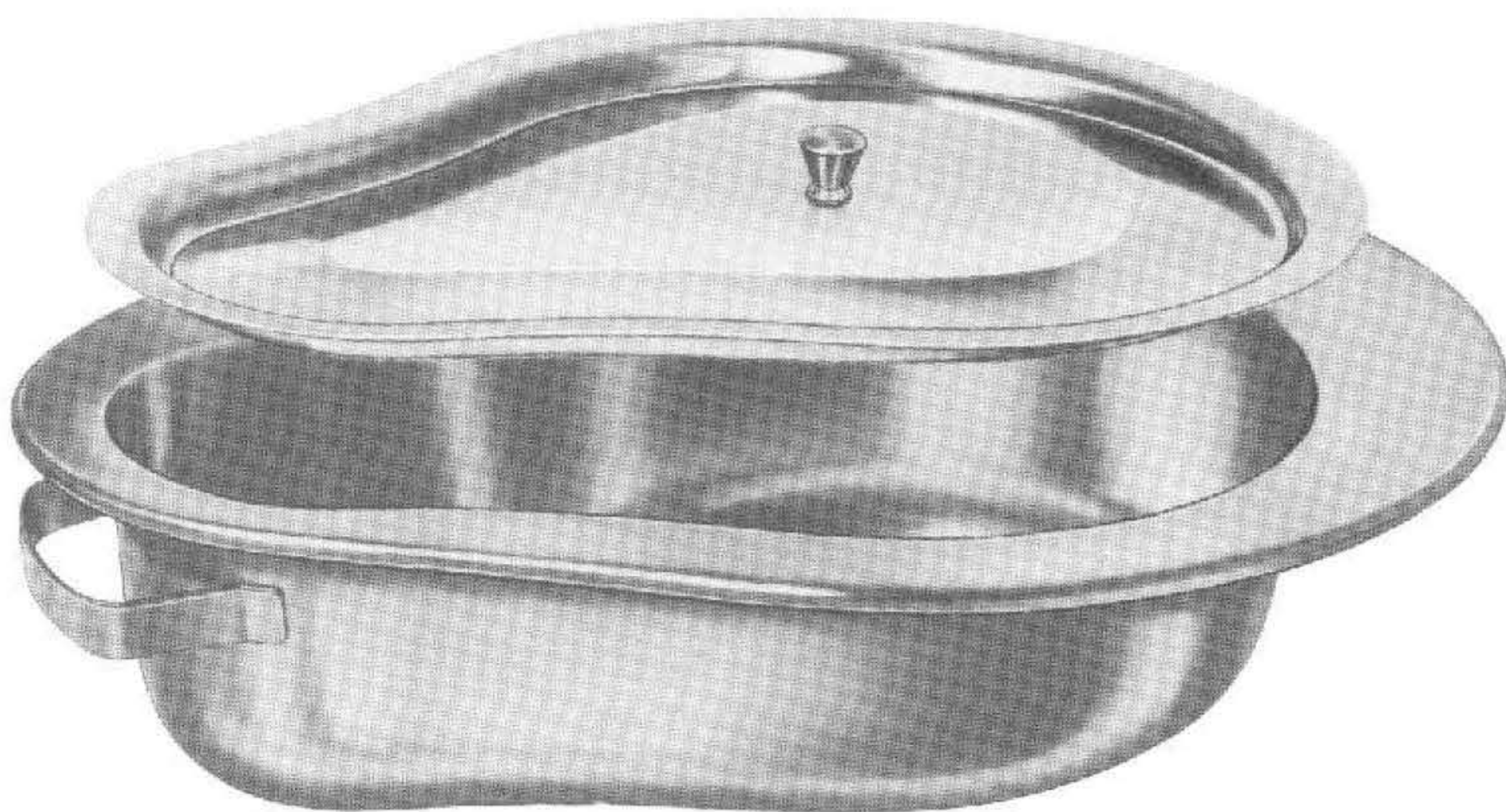

UG-530

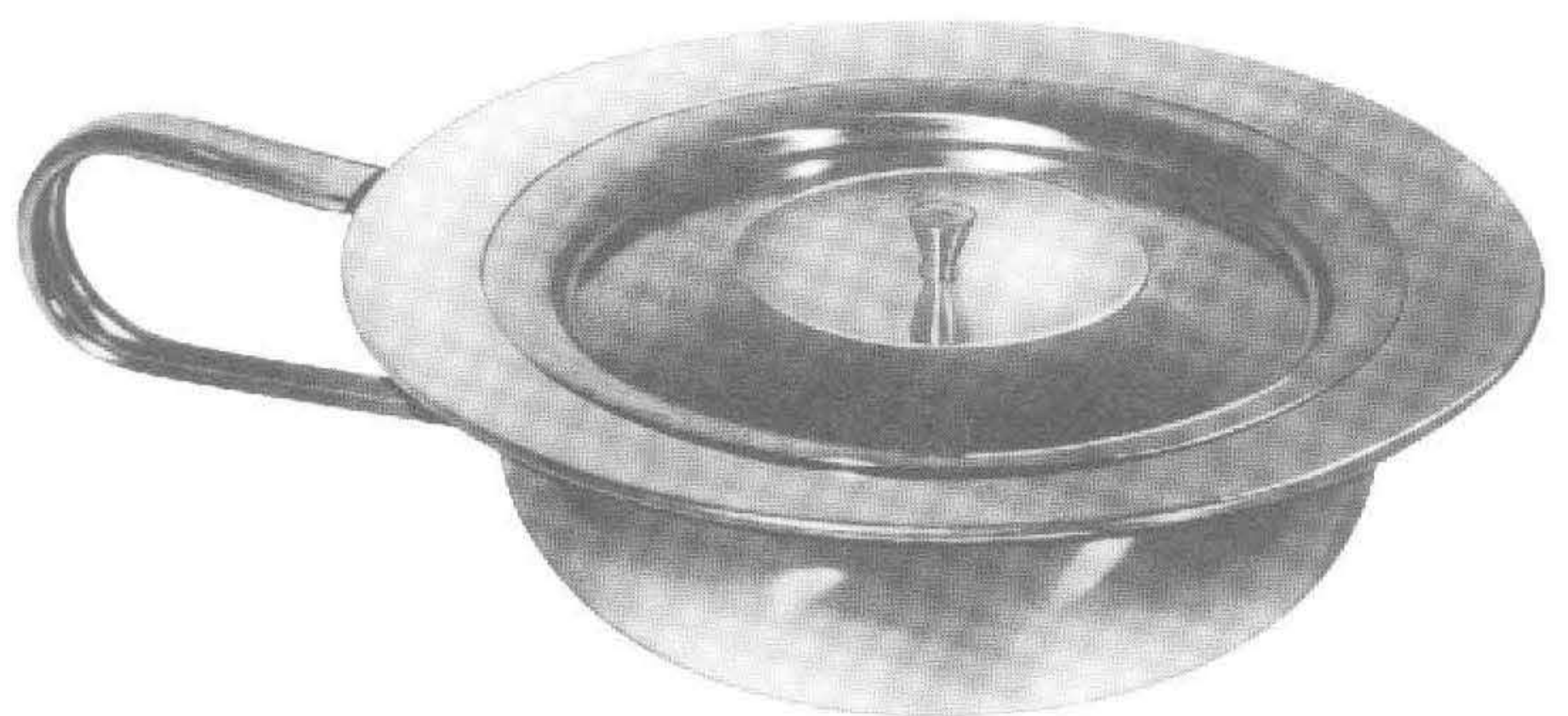

UG-532

Ø 235 mm
Ø 310 mm

Needle Cases



UG-505
Sauerbruch
210 x 125 x 17 mm



UG-506
Sauerbruch
210 x 125 x 17 mm



UG-507
150 x 95 x 13 mm

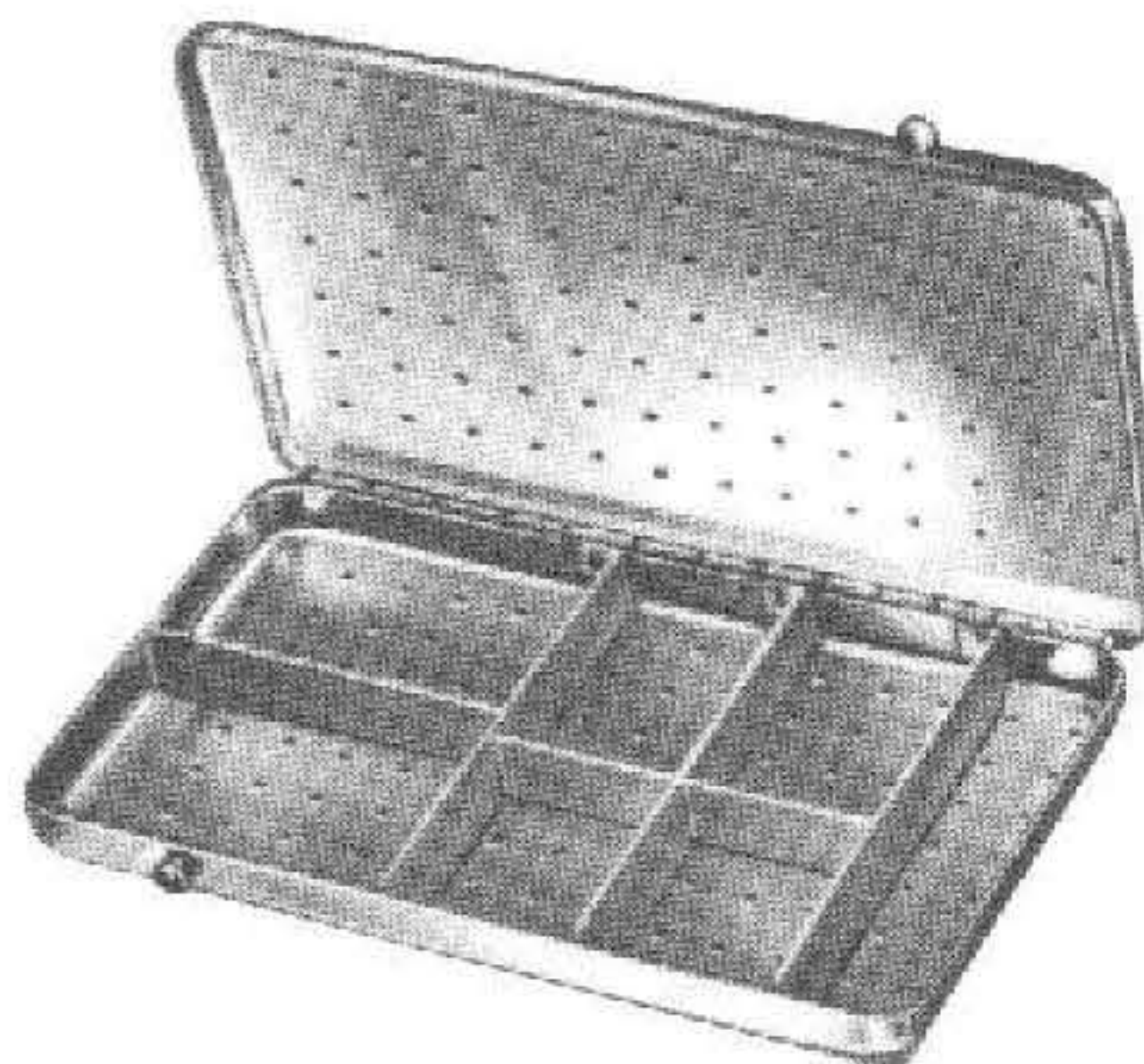

UG-509
150 x 95 x 13 mm

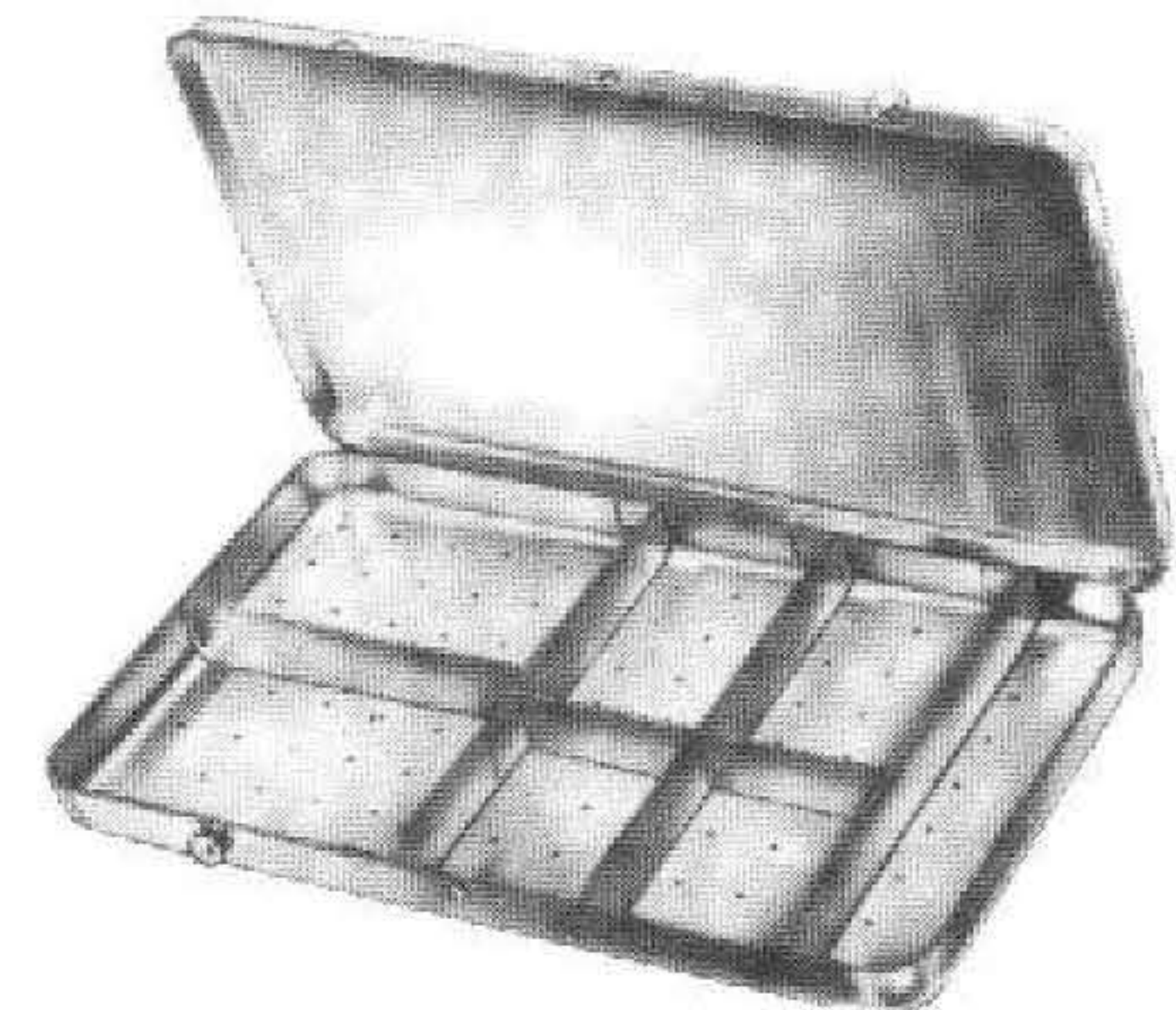

UG-510
150 x 95 x 13 mm



UG-511
150 x 95 x 13 mm



UG-512
150 x 95 x 13 mm



UG-513
150 x 95 x 13 mm

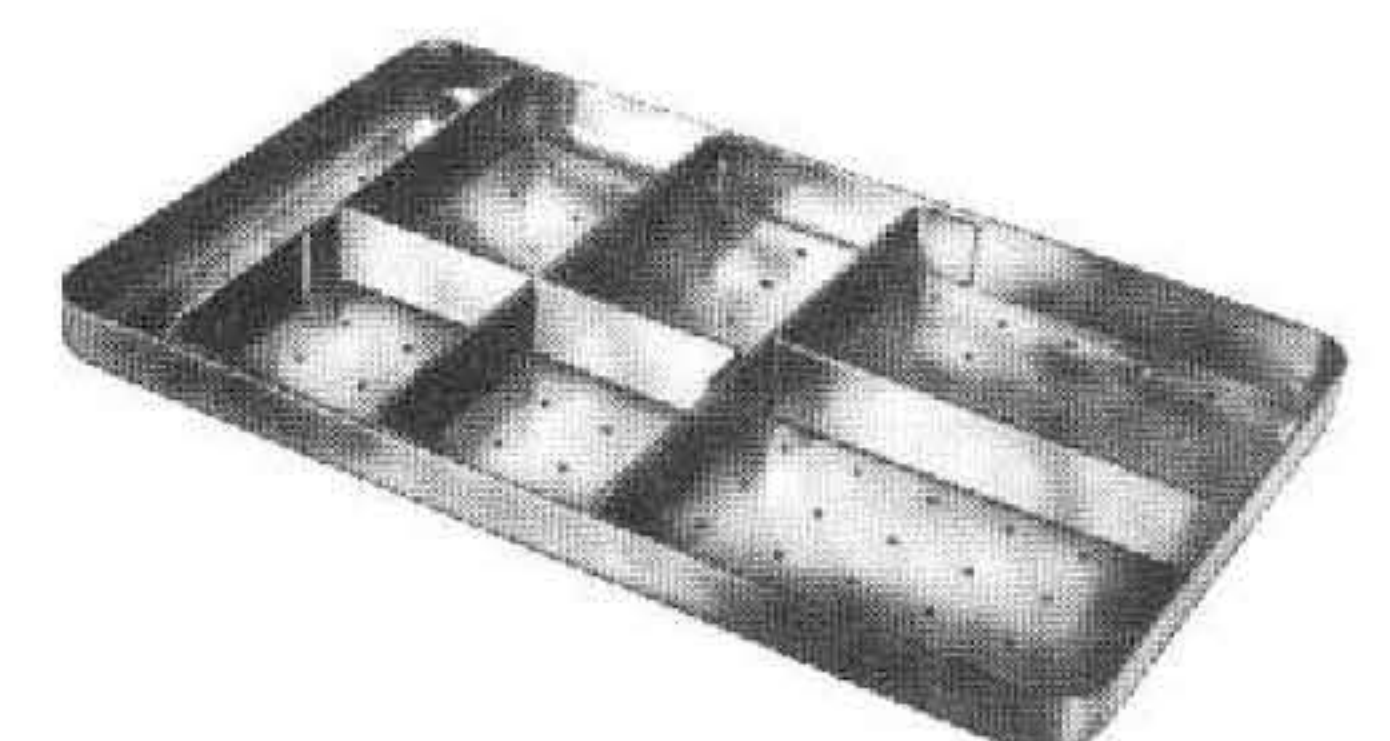

UG-514
150 x 95 x 11 mm

Storing Cases



27-196
Deponette
245 x 135 x 35mm

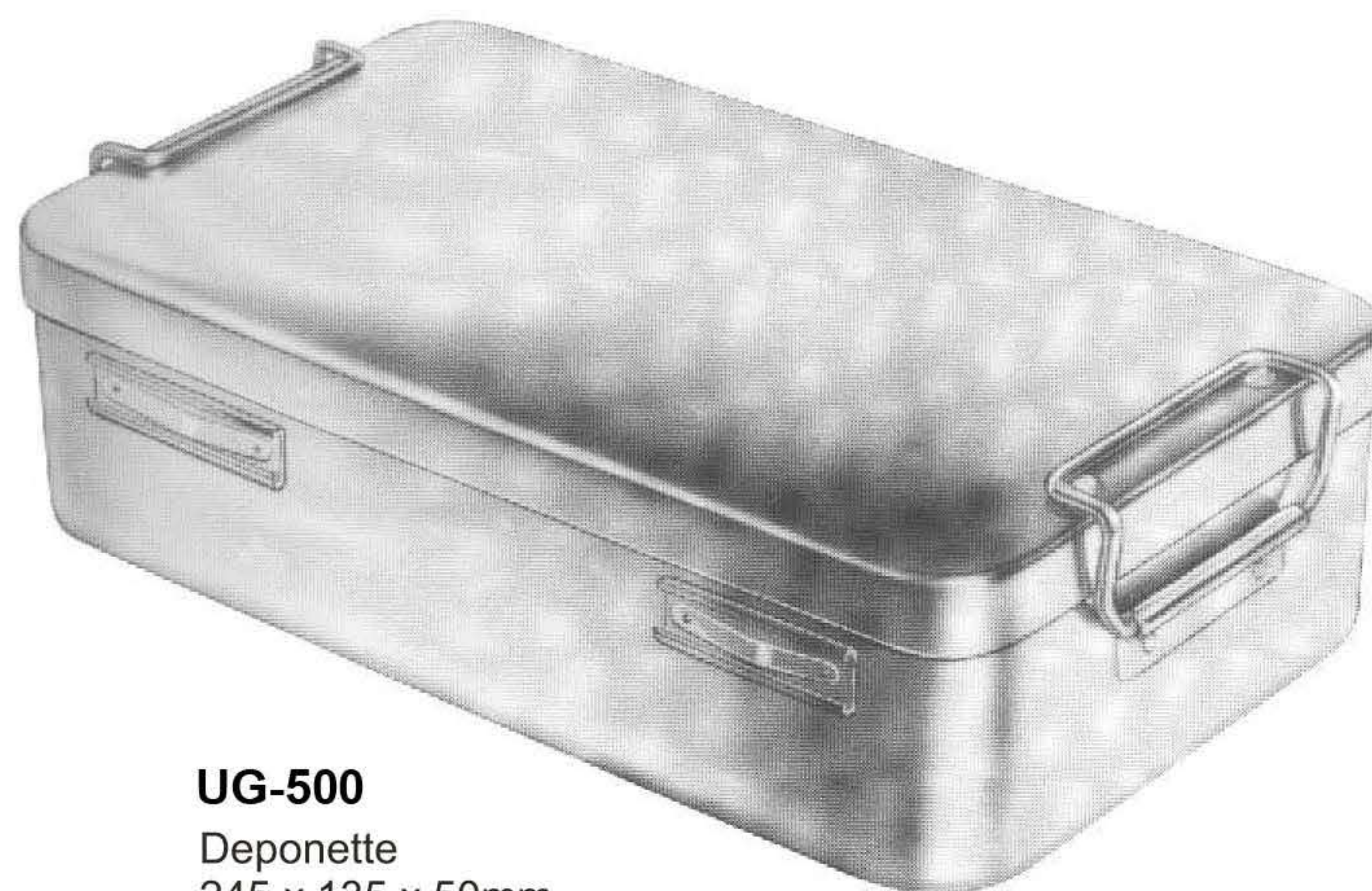

UG-500
Deponette
245 x 135 x 50mm



UG-501
Deponette
245 x 135 x 60mm

Storing Cases

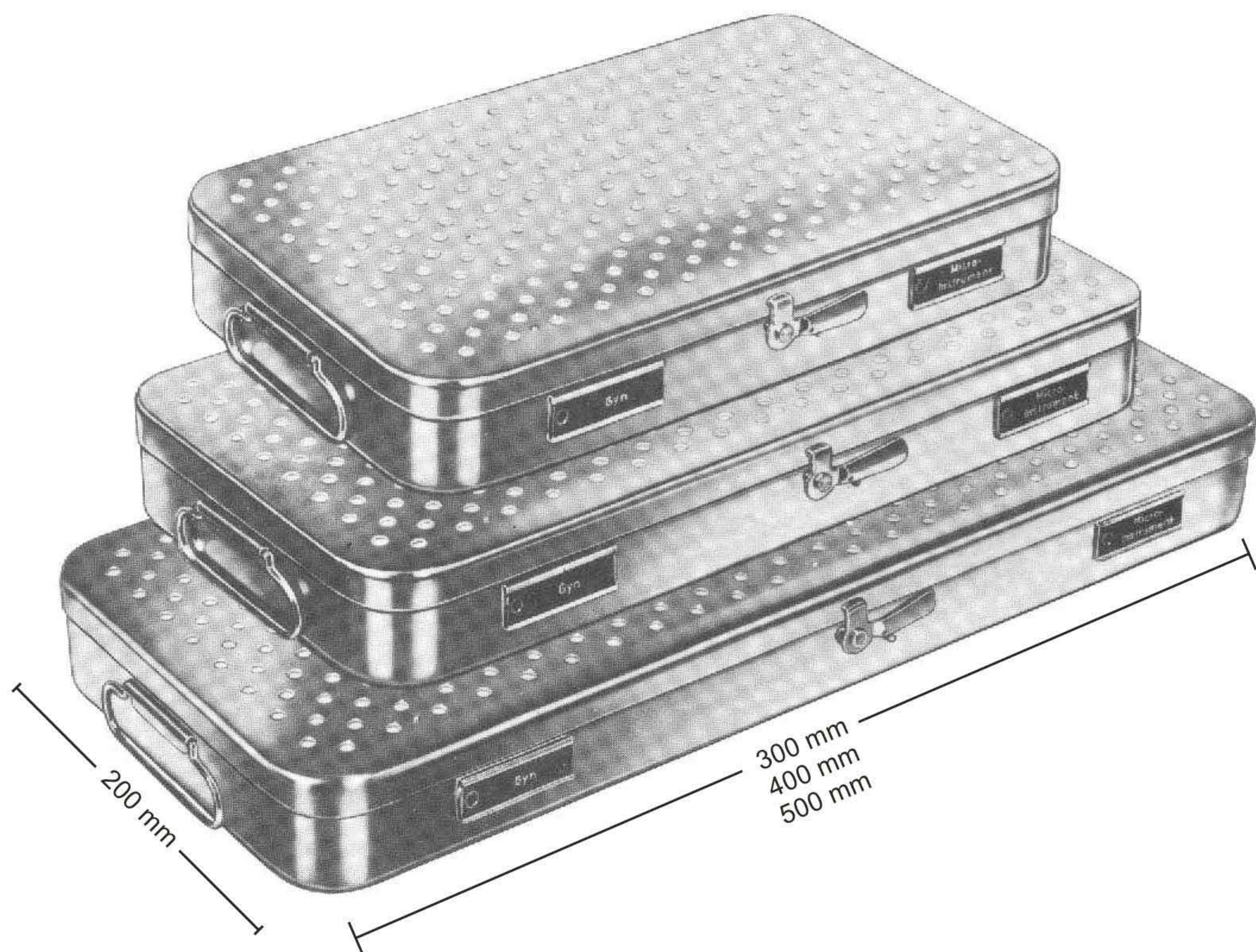

UG-364

230 x 130 x 50	mm
260 x 150 x 50	mm
275 x 235 x 50	mm
300 x 200 x 50	mm
325 x 275 x 50	mm
420 x 175 x 50	mm
230 x 130 x 75	mm
260 x 150 x 75	mm
300 x 200 x 75	mm
325 x 275 x 75	mm
420 x 175 x 75	mm

Sterilizing Baskets / Trays

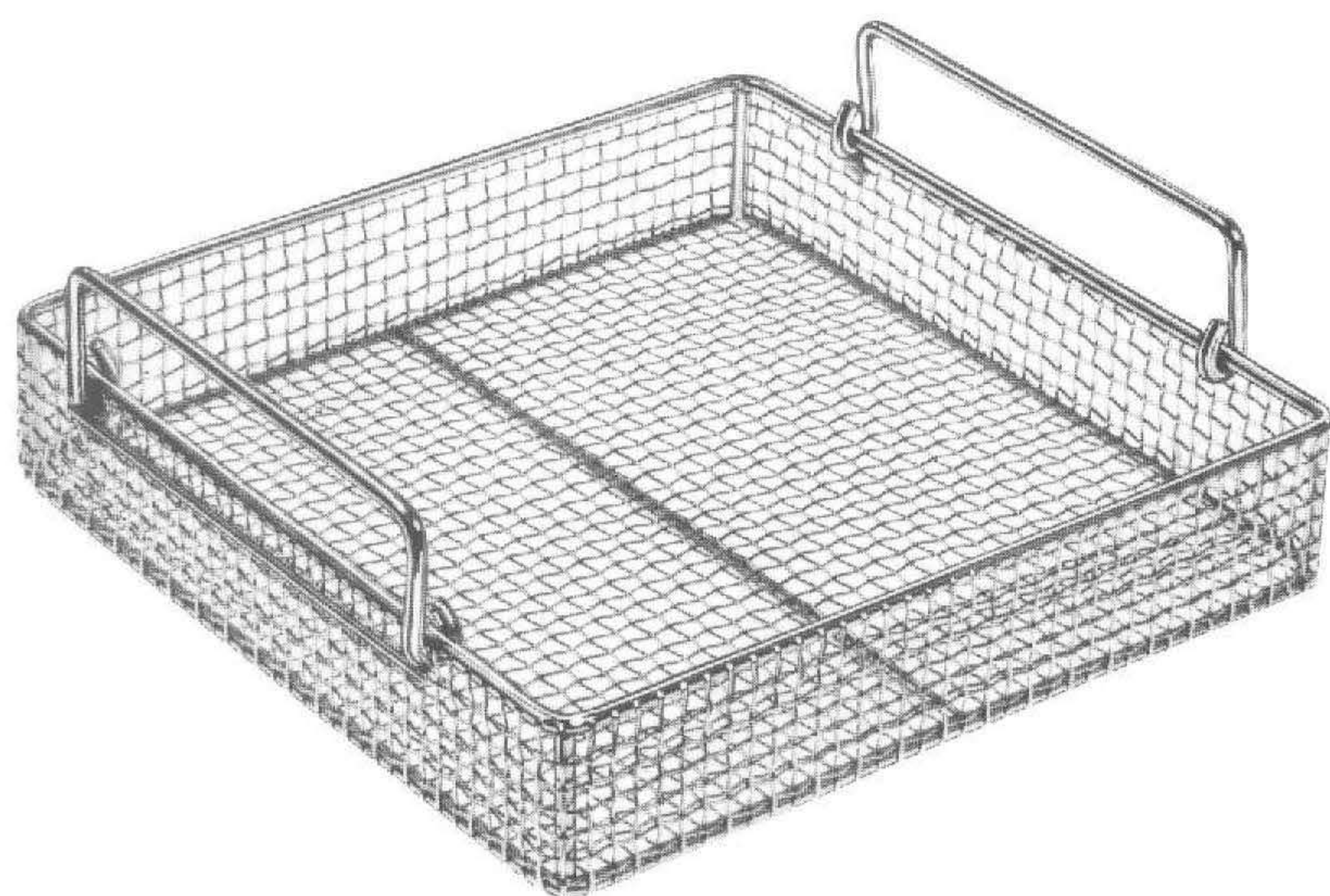

UG-349



UG-353

Sterilizing Basket

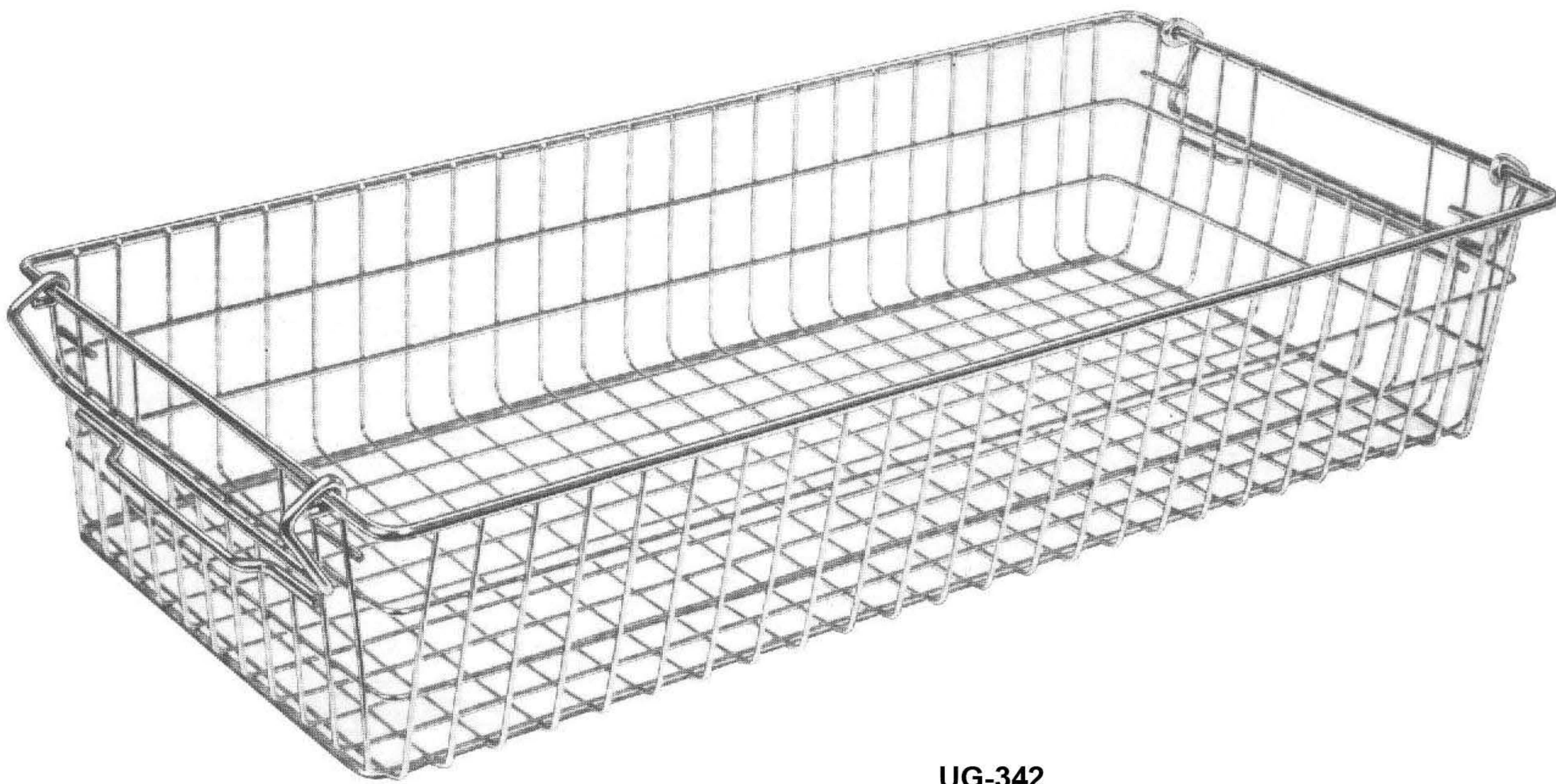

UG-342
(60 x 30 x 15 cm)
Nominal dimensions

Sterilizing Basket

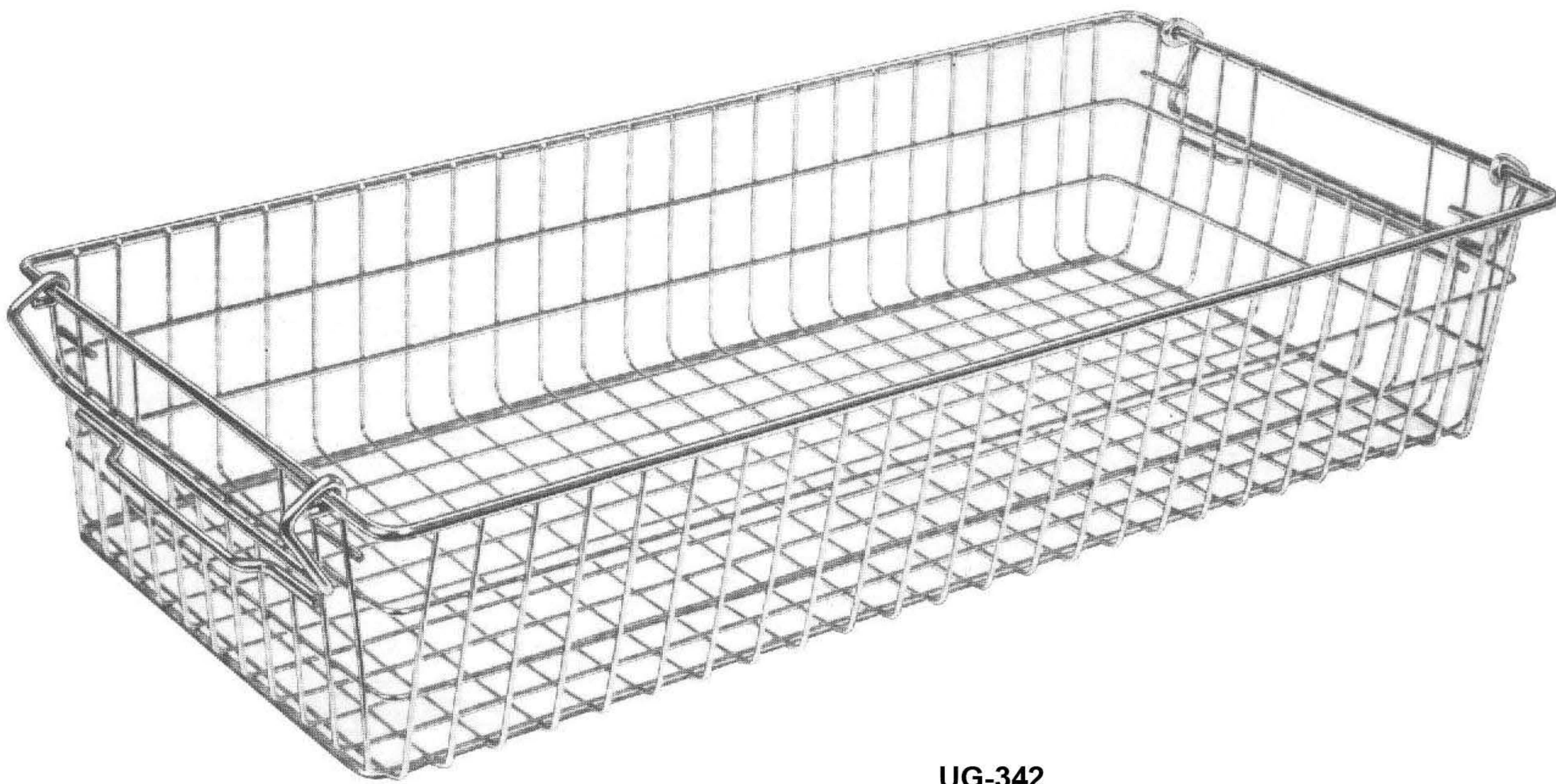

UG-342
(60 x 30 x 15 cm)
Nominal dimensions