

# UGOKI

International



# UGOKI INTERNATIONAL

**Address:** Moh Muhammad Pura  
P.O Khas Ugoki, Sialkot-Pakistan  
**Tel:** +92- 523-513380  
**Whatsapp:** +92-337-4950100  
**E-Mail:** [info@ugokiintl.com](mailto:info@ugokiintl.com)  
**Web:** [www.ugokiintl.com](http://www.ugokiintl.com)

# Percussion Hammers & Aesthesiometers



UG-001  
TROEMNER  
Size: 245 mm

1/2



UG-002  
DEJERINE  
Size: 200 mm

1/2



UG-003  
DEJERINE  
With Needle  
Size: 210 mm

1/2

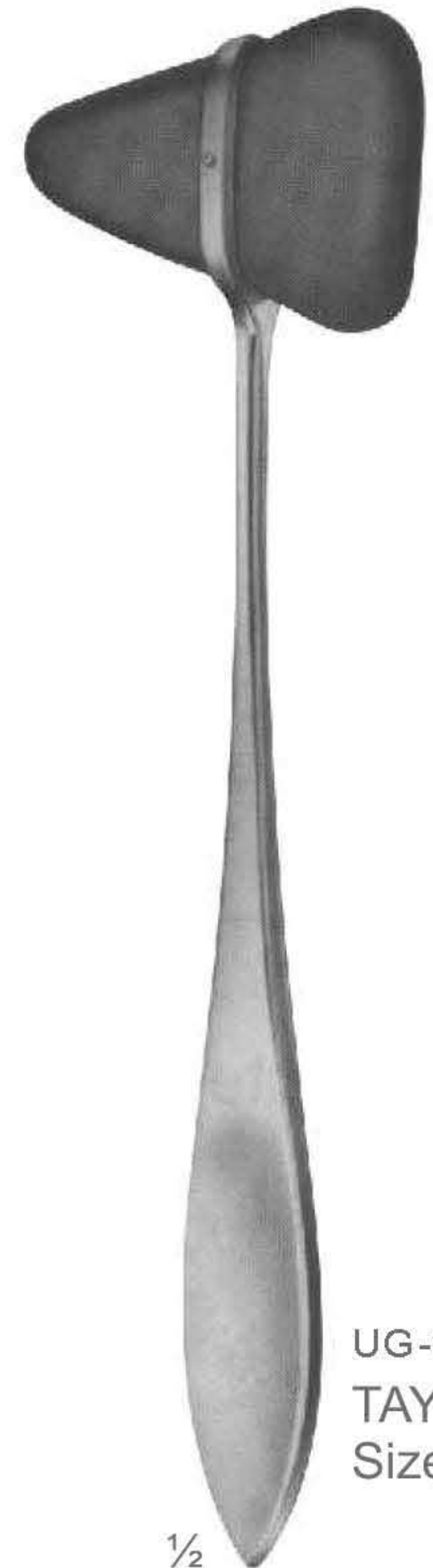

UG-004  
TAYLOR  
Size: 195 mm

1/2

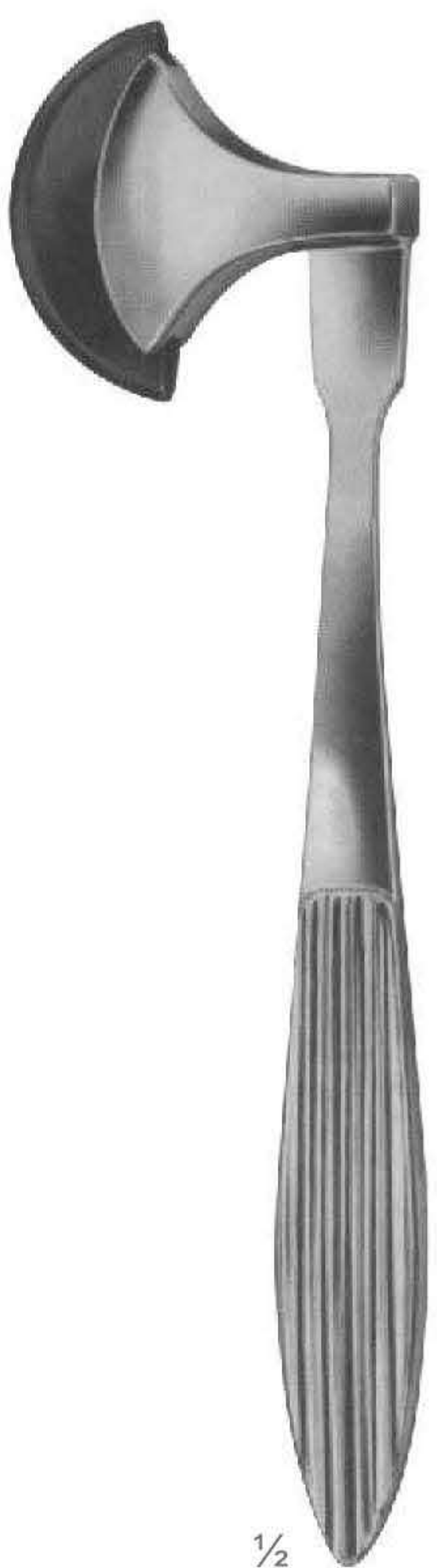

UG-005  
BERLINER  
Size: 200 mm

1/2

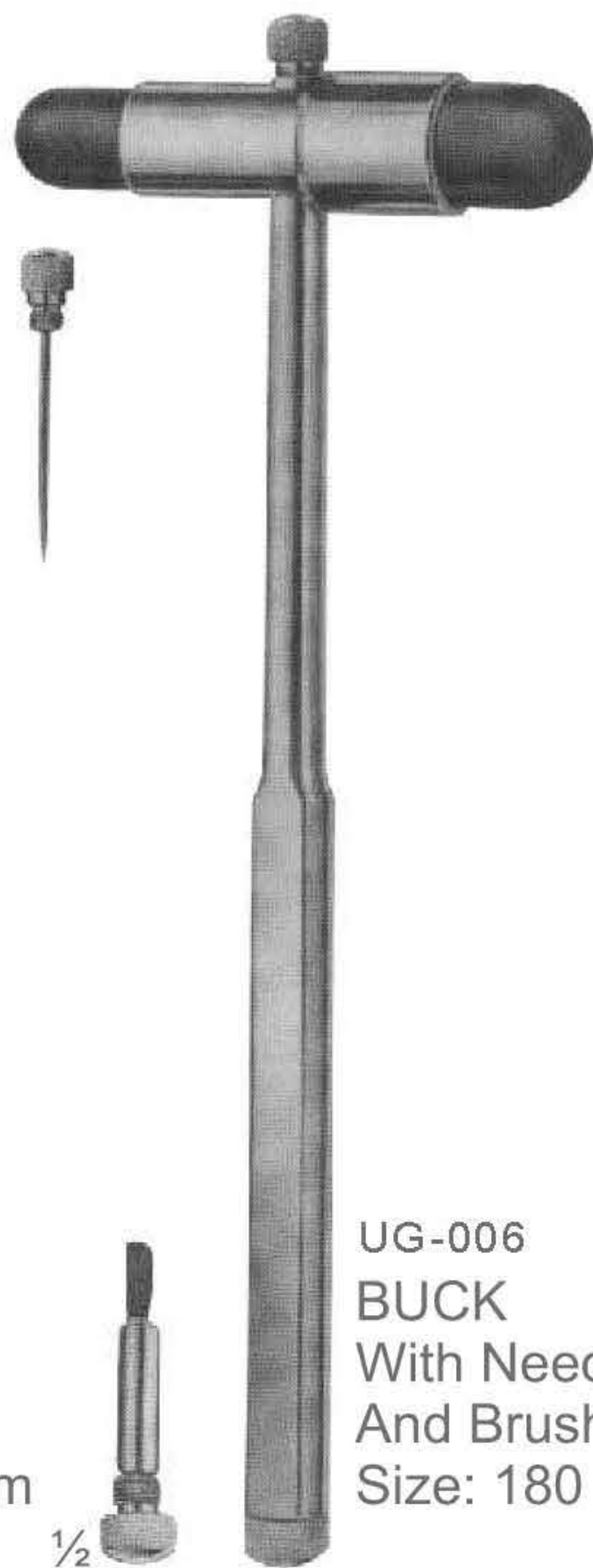

UG-006  
BUCK  
With Needle  
And Brush  
Size: 180 mm

1/2

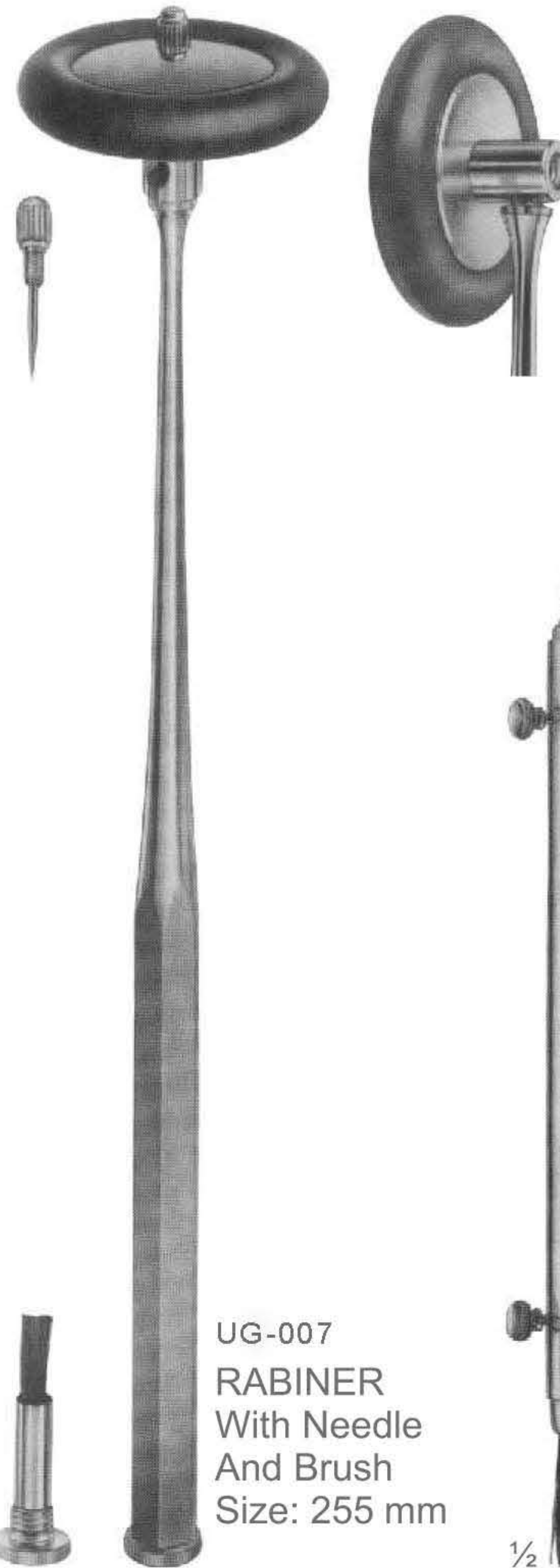

UG-007  
RABINER  
With Needle  
And Brush  
Size: 255 mm

1/2



UG-008  
ALY  
Size: 190 mm

1/2

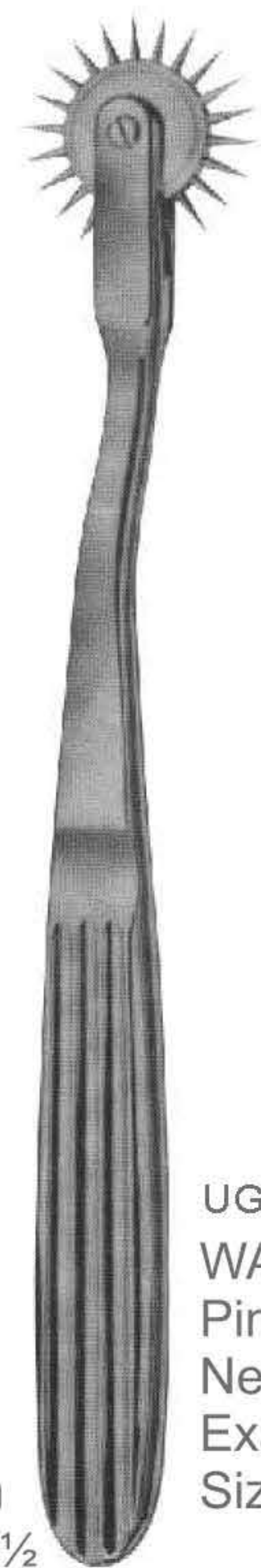

UG-009  
WARTENBERG  
Pinwheel For  
Neurological  
Examination  
Size: 185 mm

1/2

# Stethoscopes

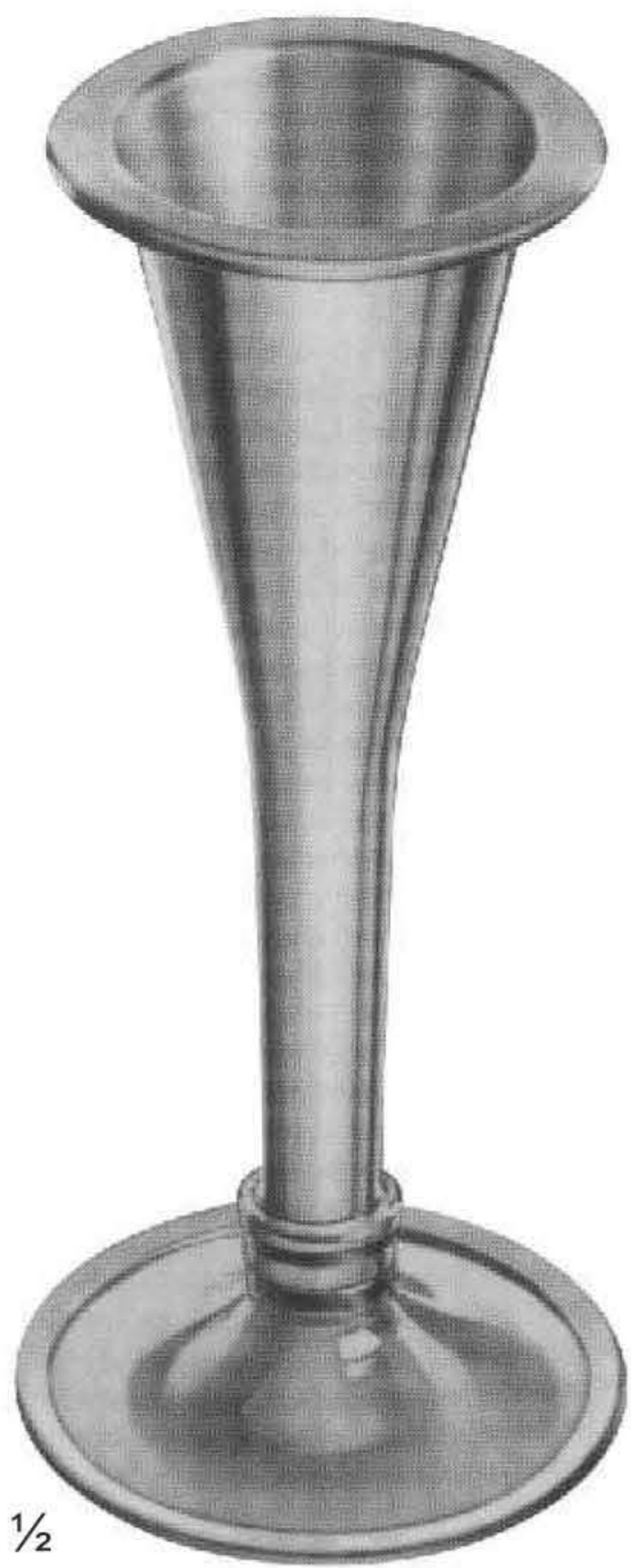

**01-110**  
PINARD (Aluminum)  
Size: 155 mm

1/2



**01-111**  
aus Holz (Wooden)  
Size: 145 mm

1/2



**01-112**  
BOWLES  
Stethoscope  
With Diaphragm

1/4

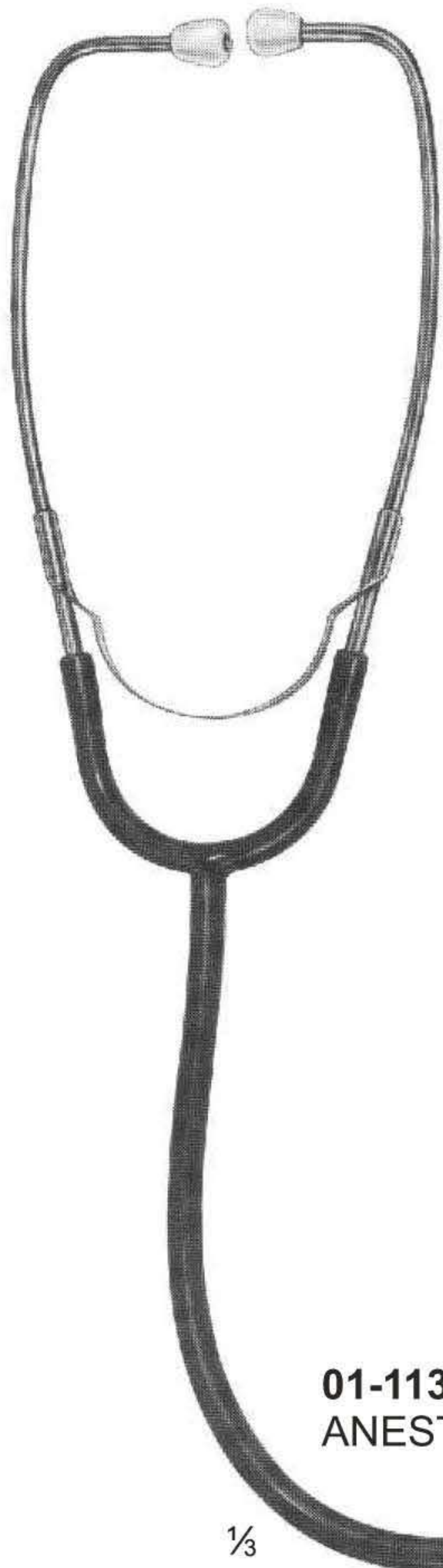

**01-113**  
ANESTOPHON

1/3

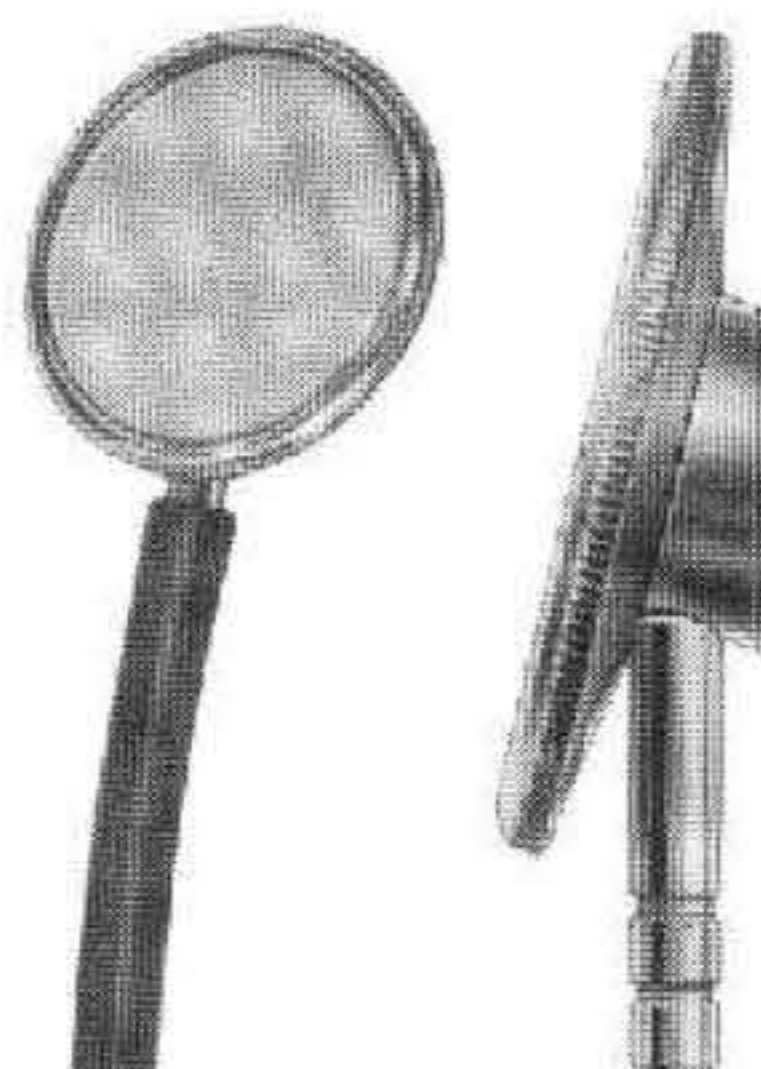

**01-114**  
FORD-BOWLES  
Duel Chest Piece  
With Two Outlets

1/4



**UG-008**  
BOWLES  
Size: With  
Needle

1/4

## Head Mirrors & Head Bands

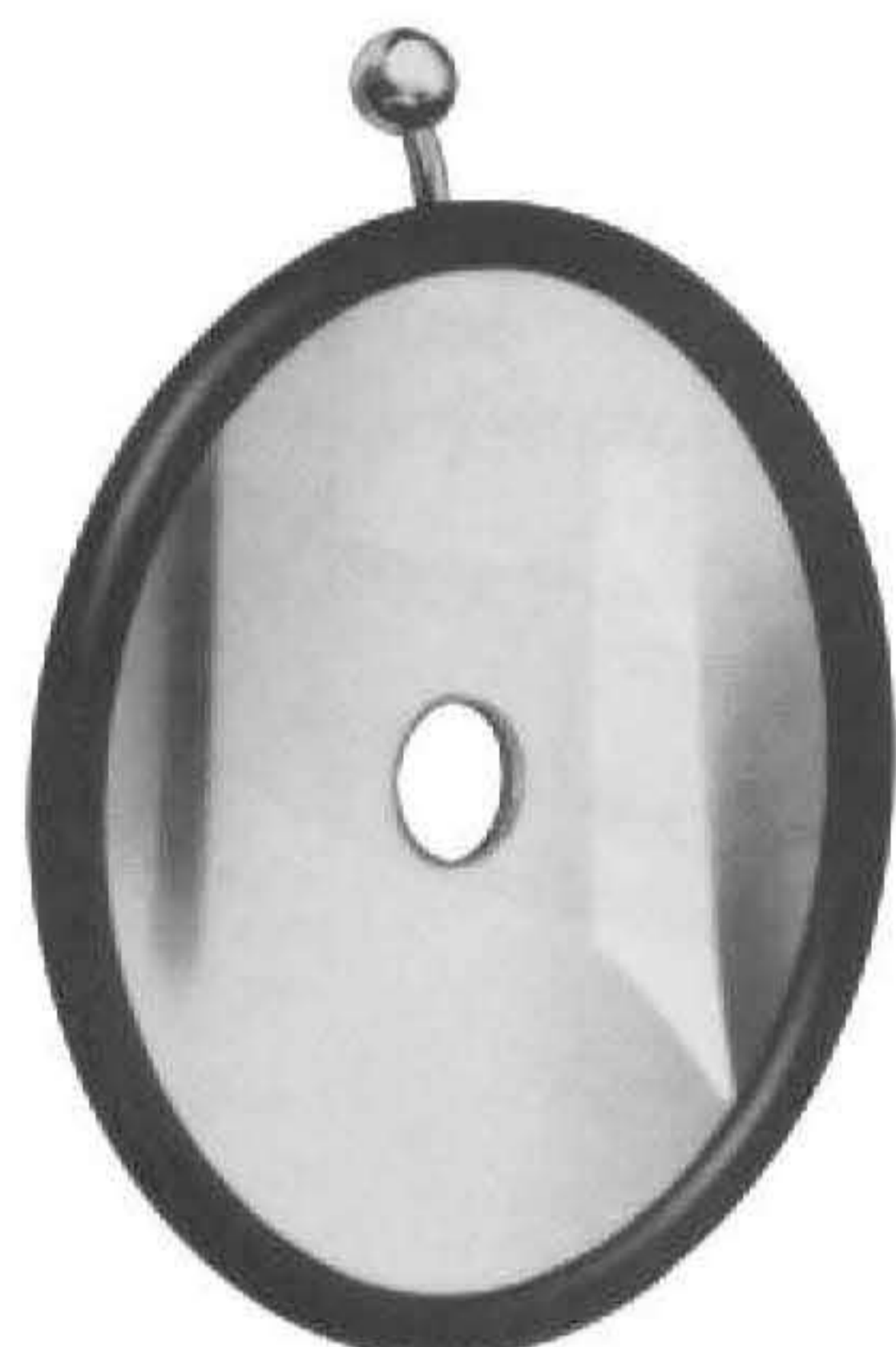

**UG-009**  
ZIEGLER  $\varnothing$  mm  
Head mirror only  
with rubber coating



**UG-010**  
ZIEGLER  $\varnothing$  mm  
Head mirror only  
with metal coating



**UG-011**  
ZIEGLER  
Head band of plastic black

**UG-012**  
ZIEGLER  
Head band of plastic white

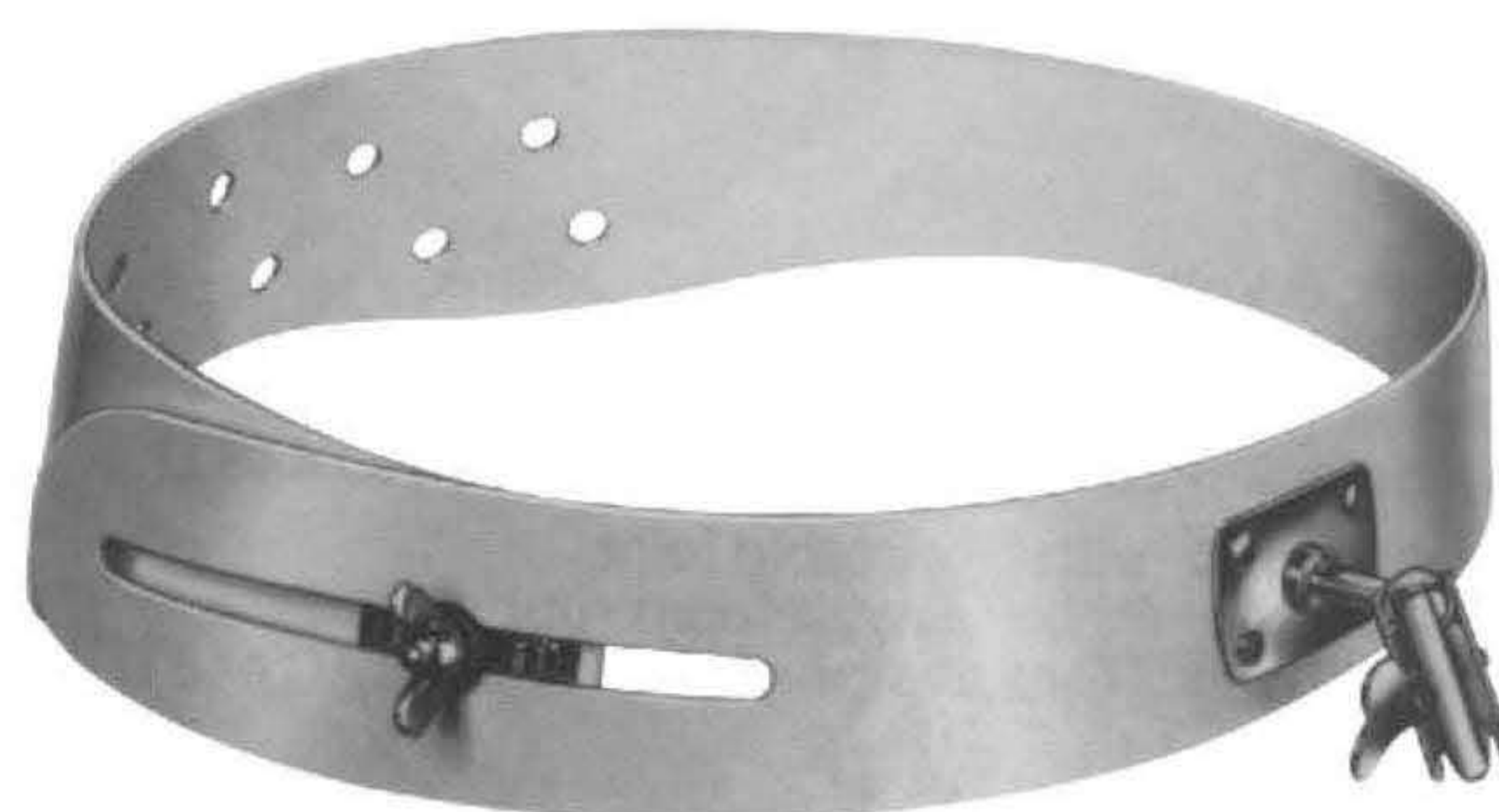

**UG-013**  
MURPHY  
Head band of celluloid, white

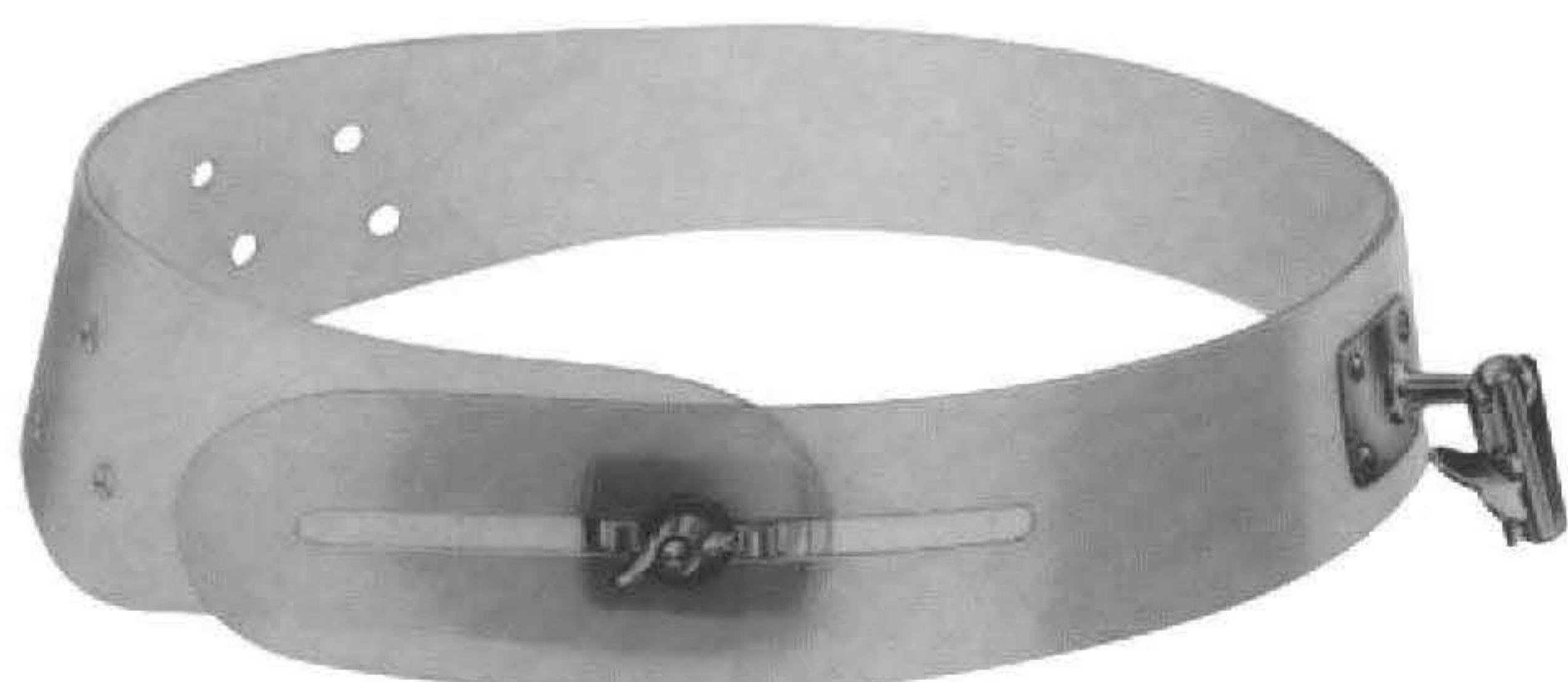

**UG-014**  
Head band of plastic,  
white, soft pattern



**UG-015**  
Head mirror with black  
plastic head band.

# Head Light

**UG-016**

CLAR

Head light, 6 volt, with adjustable joint,  
white celluloid head band,  
cord with plugs for transformer

**UG-017**

White celluloid head band, only, for

**UG-018**

Spare mirror only, for



**UG-019**

CLAR

Head light, 6 volt, with adjustable joint,  
white celluloid head band, with foam rubber pad  
and cord with plugs for transformer

**UG-020**

White celluloid head band, only, for head light

**UG-021**

mirror only, for head light

spare foam rubber pad, for head band



**UG-023**

CLAR

Head light, 6 volt, with adjustable joint,  
white plastic head band,  
cord with plugs for transformer



# Tongue Depressors

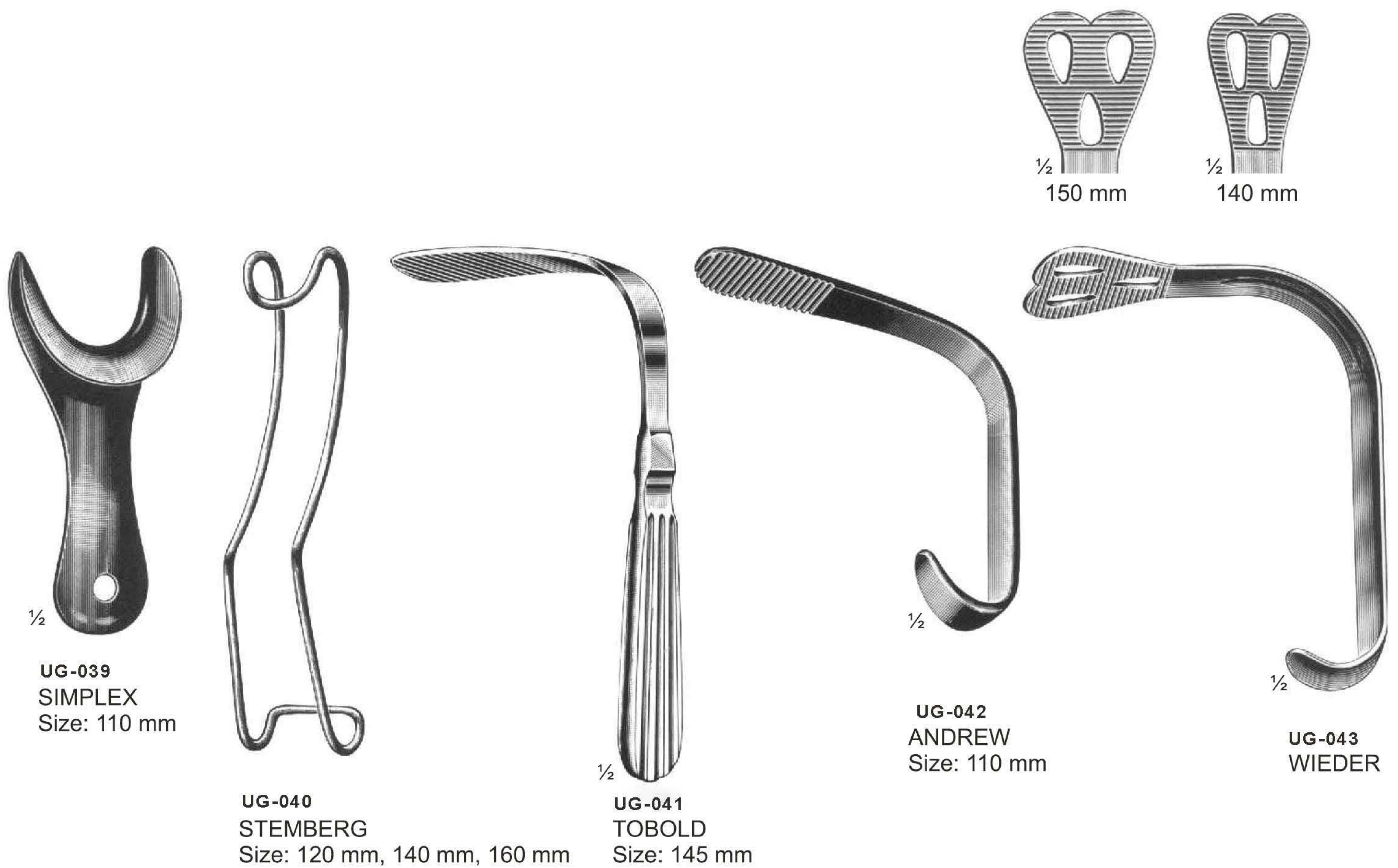
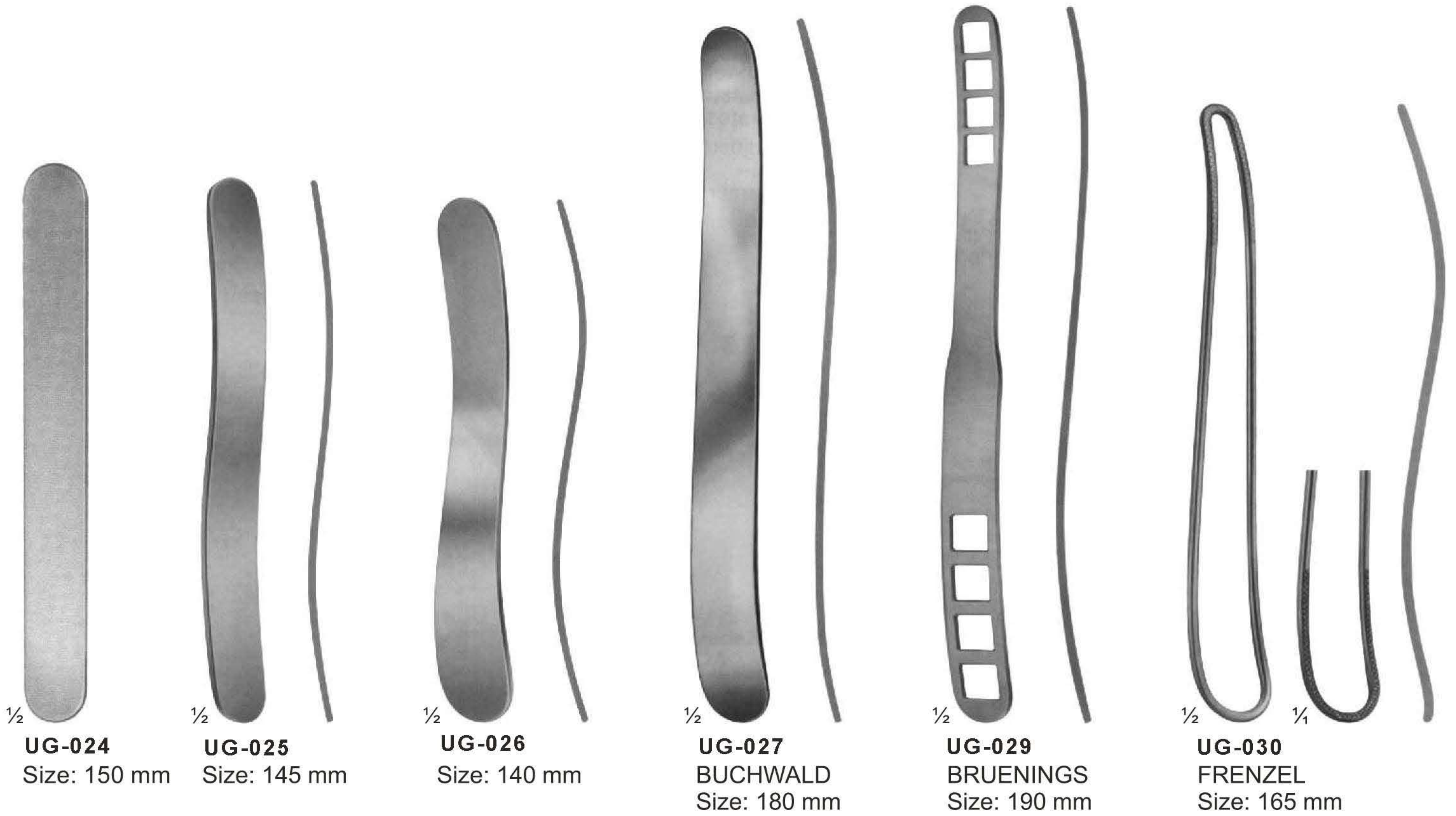

# Tongue Depressors



1/2

**UG-034**  
SCHIMMELBUSCH  
Ether Mask



1/2

**UG-035**  
HEISTER  
Mouth Gag  
Size: 130 mm



1/2

**UG-037**  
FERGUSSON-ACKLAND  
Mouth Gag  
Size: 145 mm



1/2

**UG-038**  
DENHARDT  
Mouth Gag With Silicon  
Inserts, Interchangeable  
Size: 125 mm



1/2

**UG-039**  
ROSER KONIG  
Mouth Gag  
Size: 160 mm, 185 mm

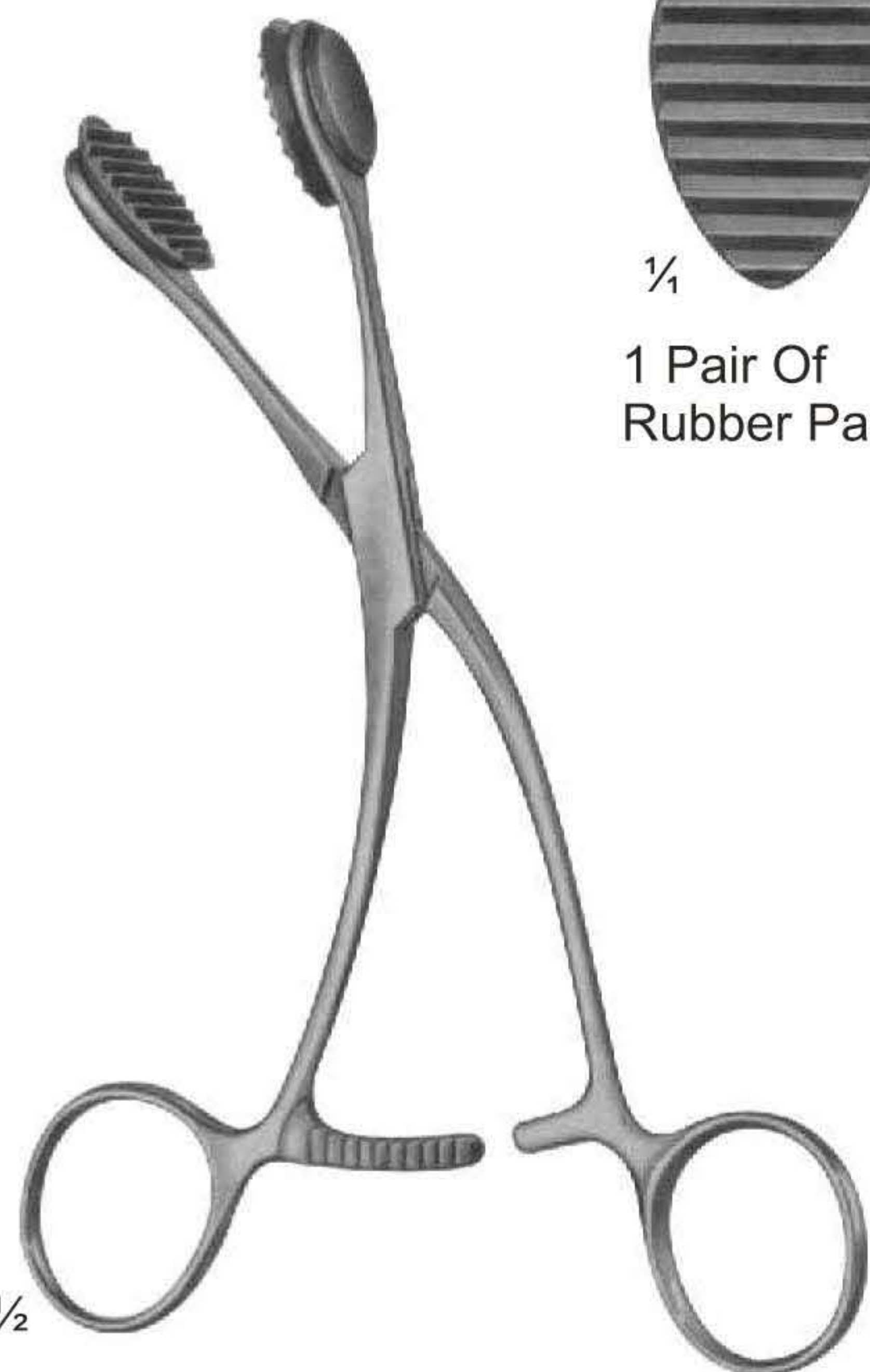

1/2

**UG-040**  
YOUNG  
Size: 165 mm



1/4

1 Pair Of  
Rubber Pads

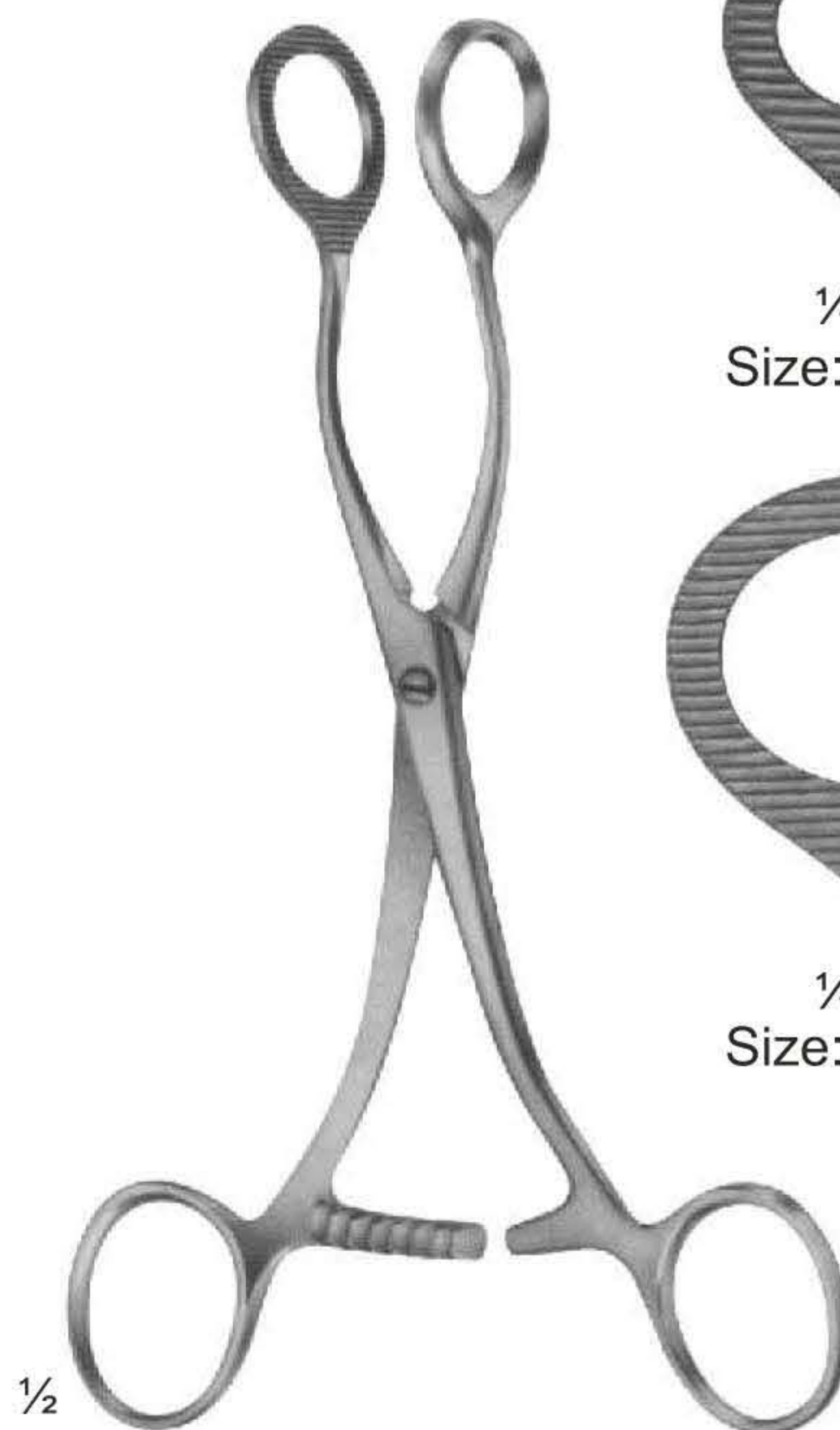

1/2

**UG-041**  
COLLIN  
Size: 160 mm, 170 mm



1/4

Size: 160 mm



1/4

Size: 170 mm

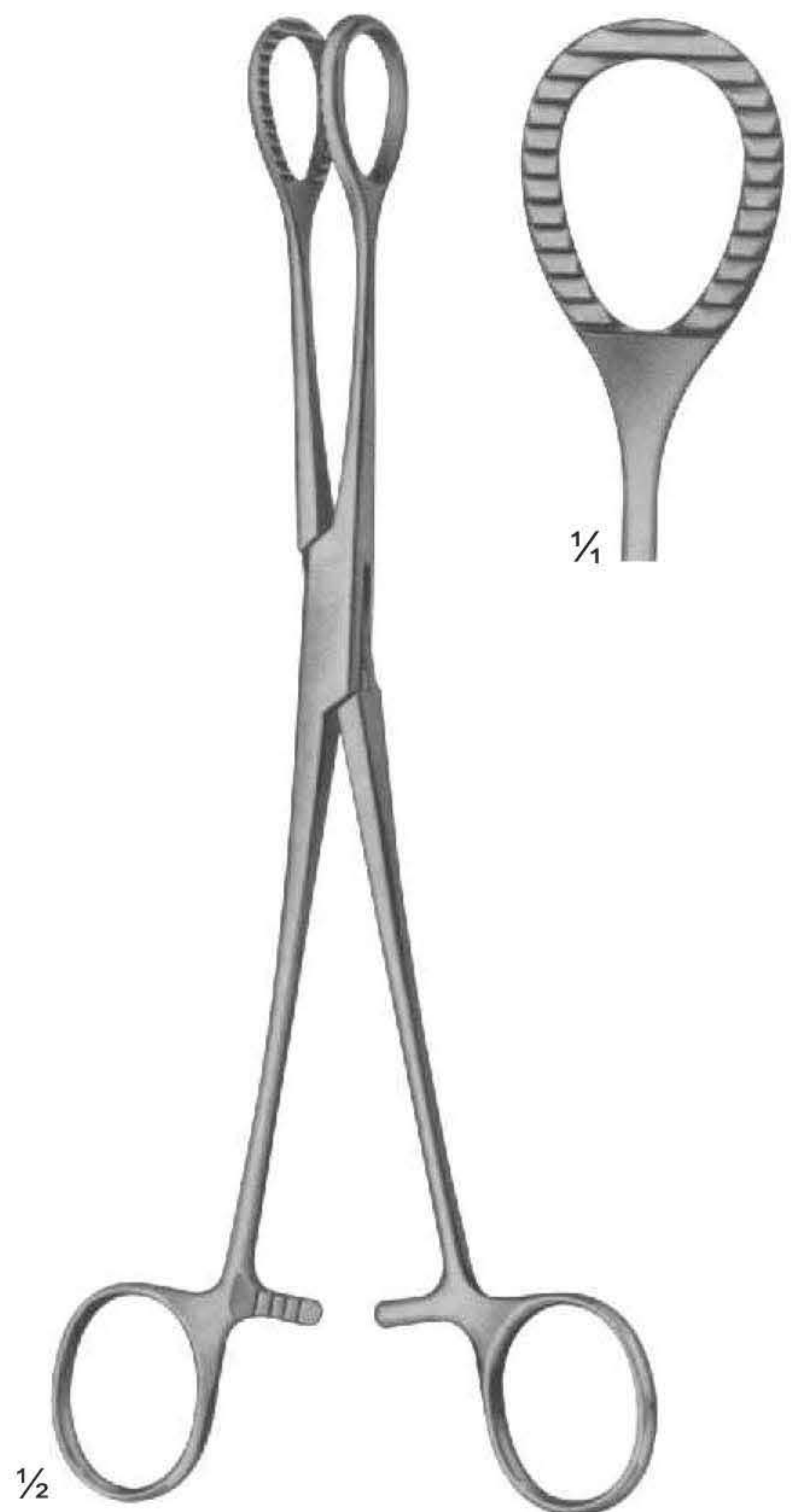

1/2

**UG-042**  
HEYWOOD-SMITH modif.  
Size: 215 mm

# Blood Lancets & Laryngeal Mirrors



**UG-044**  
FRANCKE  
Automatic Blood Lancet



**UG-045**  
KOLLE  
Microscopic Needle Holder  
With Plastic Handle  
Size: 240 mm

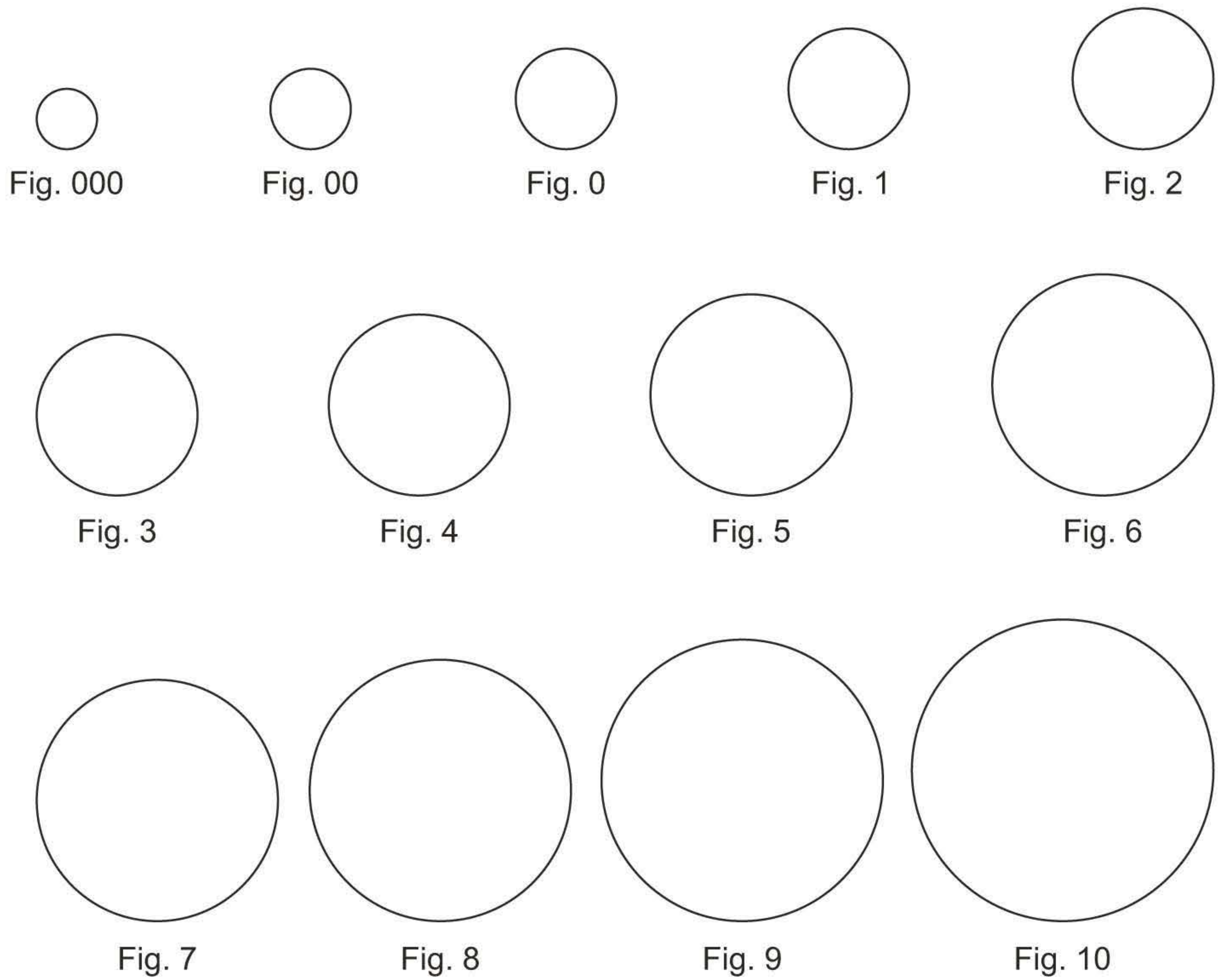

**UG-047**  
Laryngeal Mirrors With  
Hexagonal Handle  
Size: 180 mm



**UG-048**  
Mirror Handle  
Size: 110 mm



**UG-049**  
Mirror Handle  
Size: 105 mm



**UG-050**  
MICHEL  
Rhinoscopic Mirrors With  
Interchangeable Mirror Inserts  
Size: 250 mm



**UG-058**  
Spare Mirrors Only  
Size: 12 mm



**UG-059**  
Spare Mirrors Only  
Size: 14 mm



# Diagnostic Sets



**UG-078**  
MAGILL



**UG-060**  
Infants  
Size: 150 mm



**UG-061**  
Children  
Size: 200 mm



**UG-062**  
Adults  
Size: 250 mm



**UG-079**  
Medium battery handle  
only, 25 mm diam.



**UG-063-A**  
Spare bulb  
2.7 volt, for  
otoscopes



**UG-063-B**  
Spare bulb  
2.6 volt, for  
ophthalmoscopes



**UG-080**  
Otoscope Set, Consists Of  
Battery Handle Without Batteries,  
3 Ear Specula, 1 Bulb In Velvet Lined Case



**UG-081**  
Diagnostic Set, Otoscope With Three Specula,  
Nasal Speculam, Lamp Holder, Two Laryngeal  
Mirrors, Tongue Blade Holder

# Diagnostic Sets



1/3

**UG-082**  
MILLER  
Laryngoscope Set, Consists Of Battery Handle ( Without Battery )  
With Four Miller Laryngoscope Blades



1/3

**UG-083**  
GUEDEL-NEGUS  
Laryngoscope Set, Consists Of Battery Handle ( Without Battery )  
With Four Miller Laryngoscope Blades

# Diagnostic Sets



1/3

## UG-084

McIntosh  
Laryngoscope Set, Consists Of Battery Handle ( Without Battery )  
With Three McIntosh Blades, Fig. 1, Fig. 2, Fig. 3

## UG-088

McIntosh  
Laryngoscope Set, Consists Of Battery Handle ( Without Battery )  
With Five McIntosh Blades, Fig. 1, Fig. 2, Fig. 3, Fig. 4, Fig. 5

## UG-091

FOREGGER  
Laryngoscope Set, Consists Of  
Battery Handle ( Without Battery )  
With Three Foregger Blades,  
Fig. 1, Fig. 2, Fig. 3,

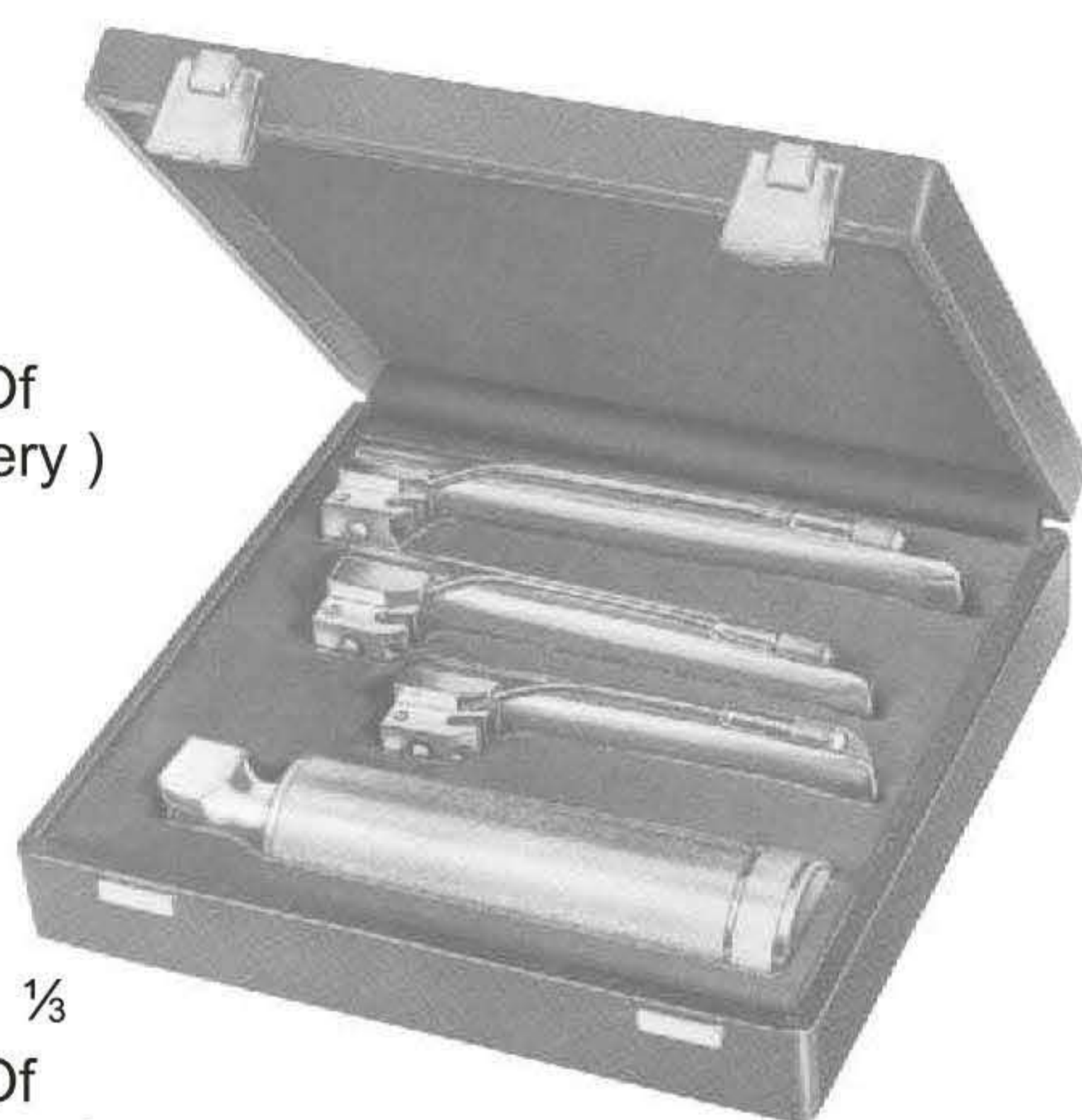

## UG-093

FOREGGER  
Laryngoscope Set, Consists Of  
Battery Handle ( Without Battery )  
With Five Foregger Blades,  
Fig. 1, Fig. 2, Fig. 3, Fig. 4, Fig. 5

1/3



1/2

**UG-096**  
Fiber Optic  
Battery Handle

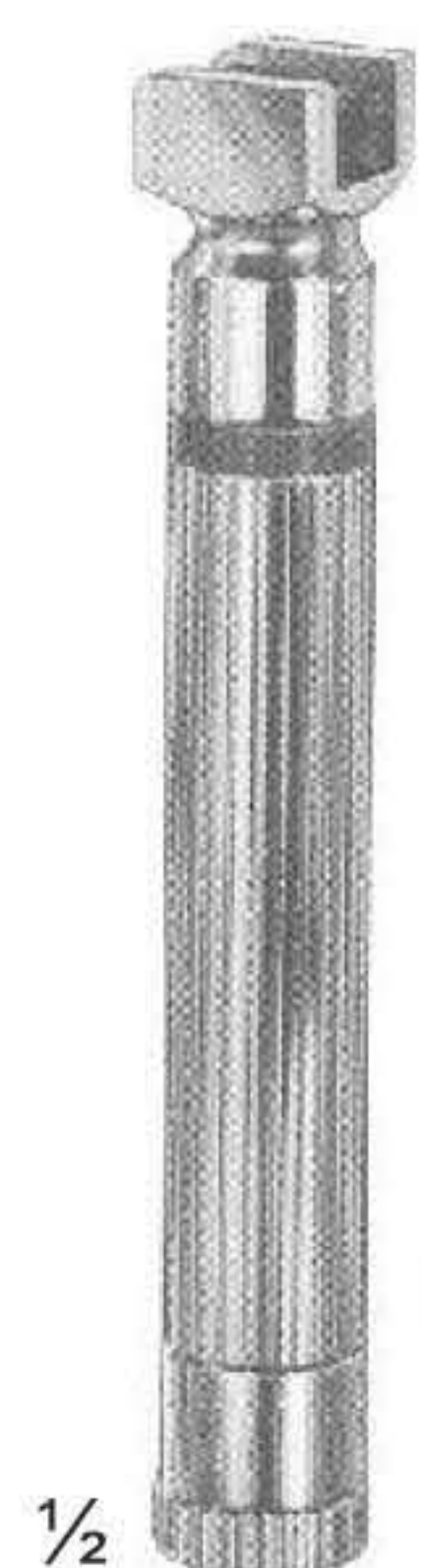

1/2

**UG-098**  
Fiber Optic  
Battery Handle

# Suture Instruments - Reverdin Needles



UG-339  
REVERDIN  
140 mm



UG-340  
REVERDIN  
195 mm



UG-341  
REVERDIN  
220 mm

# Suture Instruments - Ligature Needles

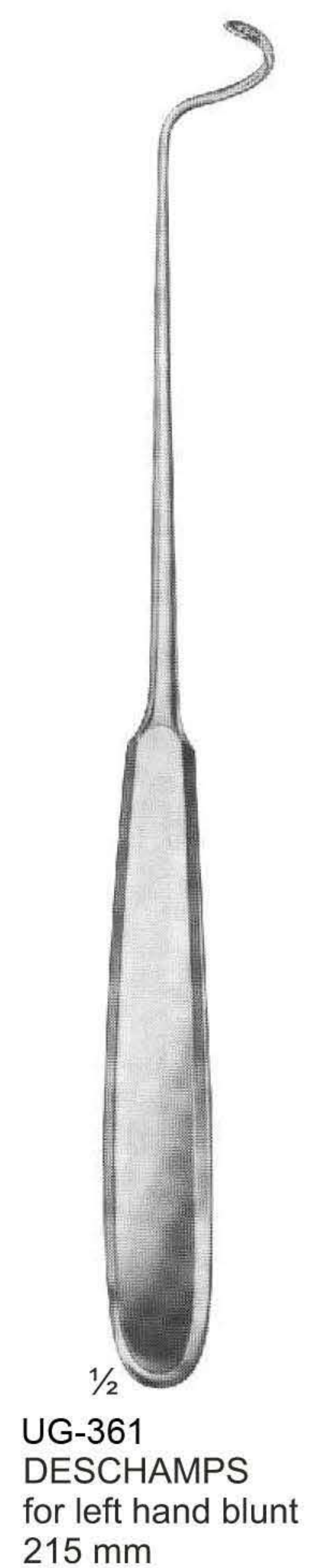
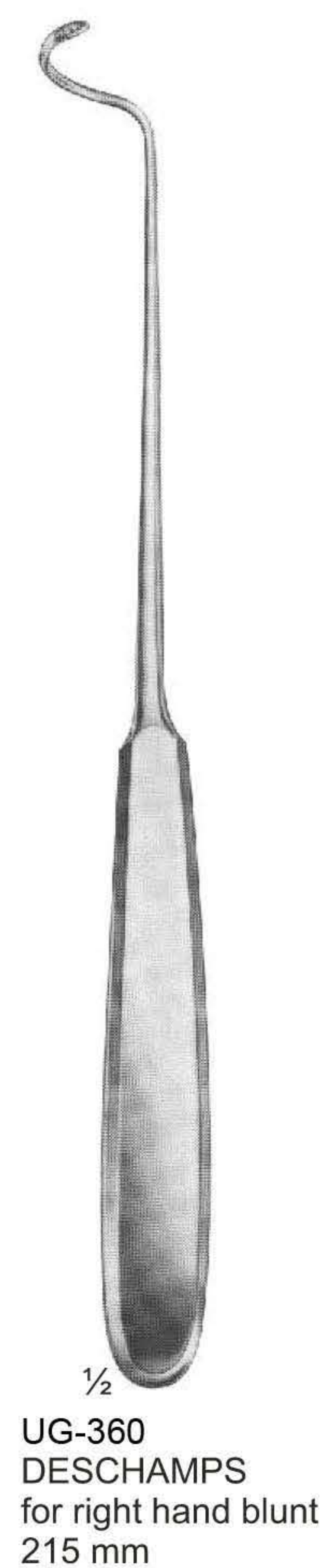
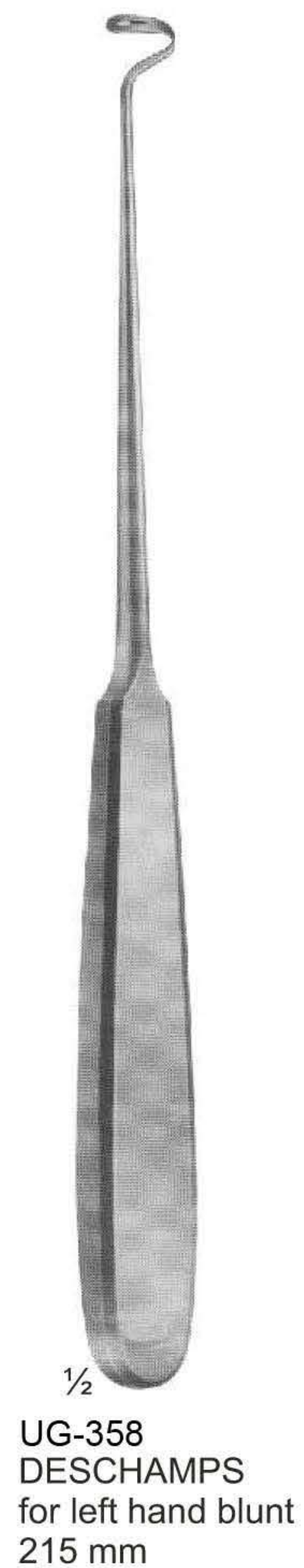
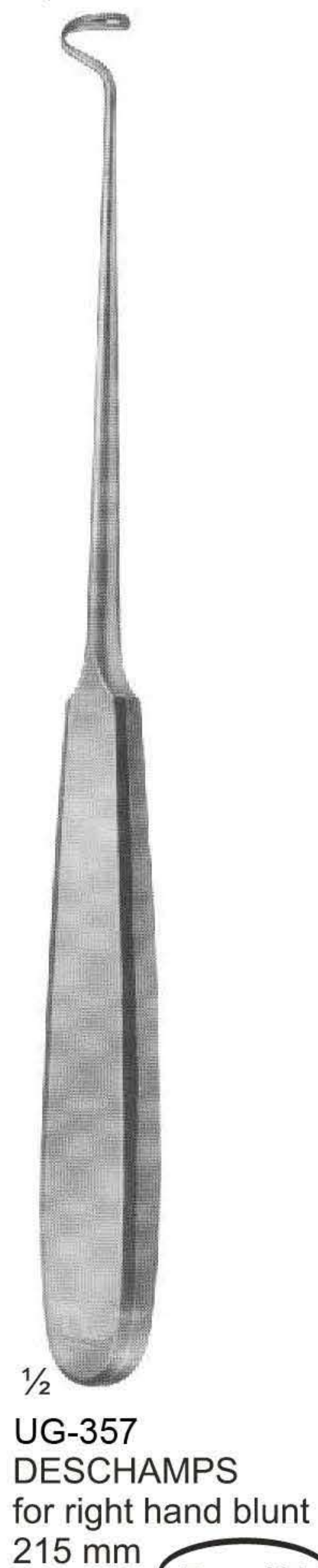
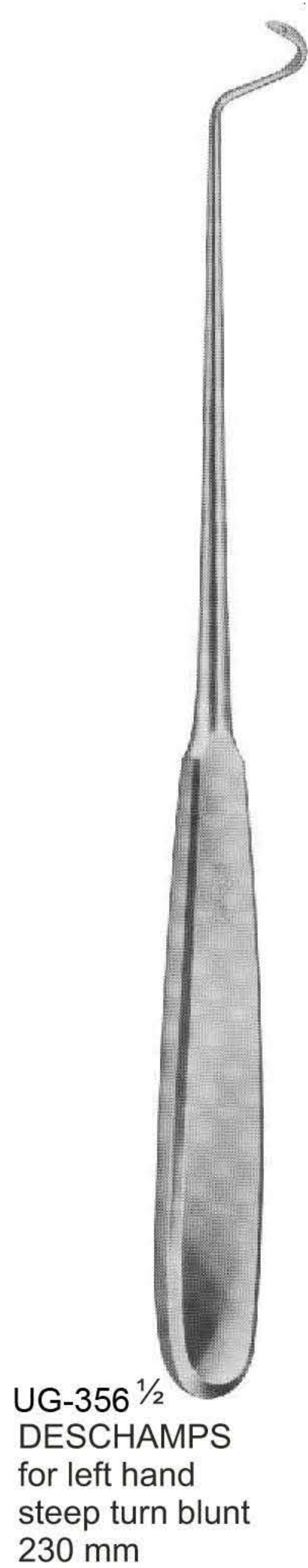
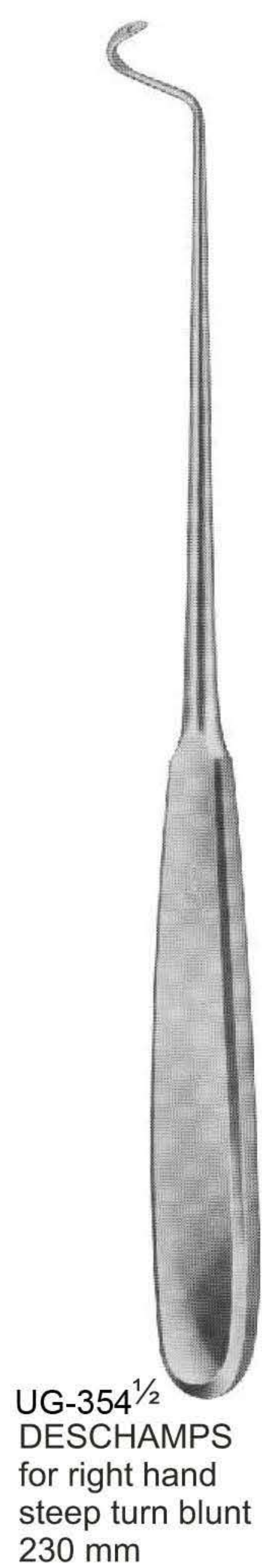
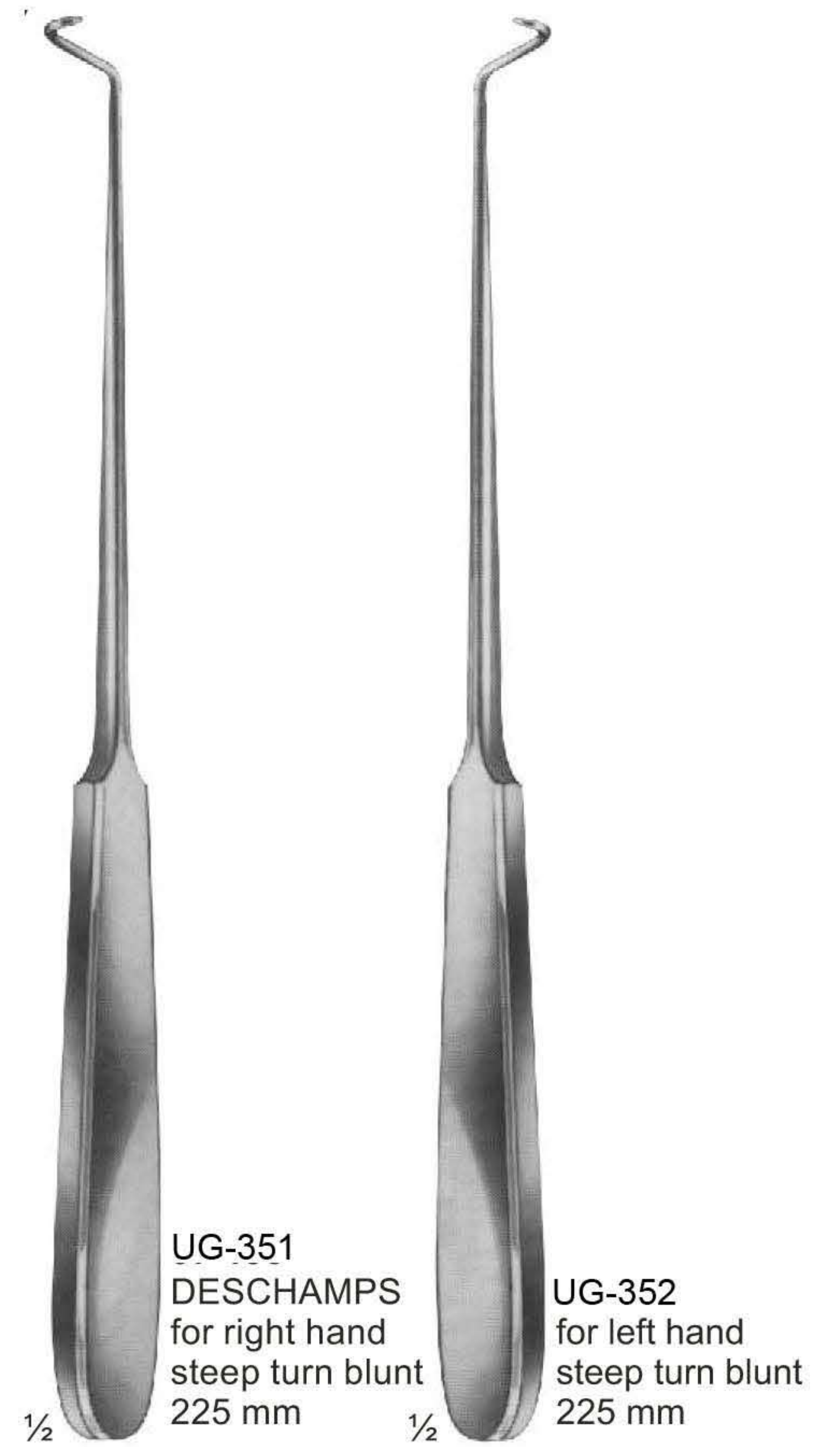
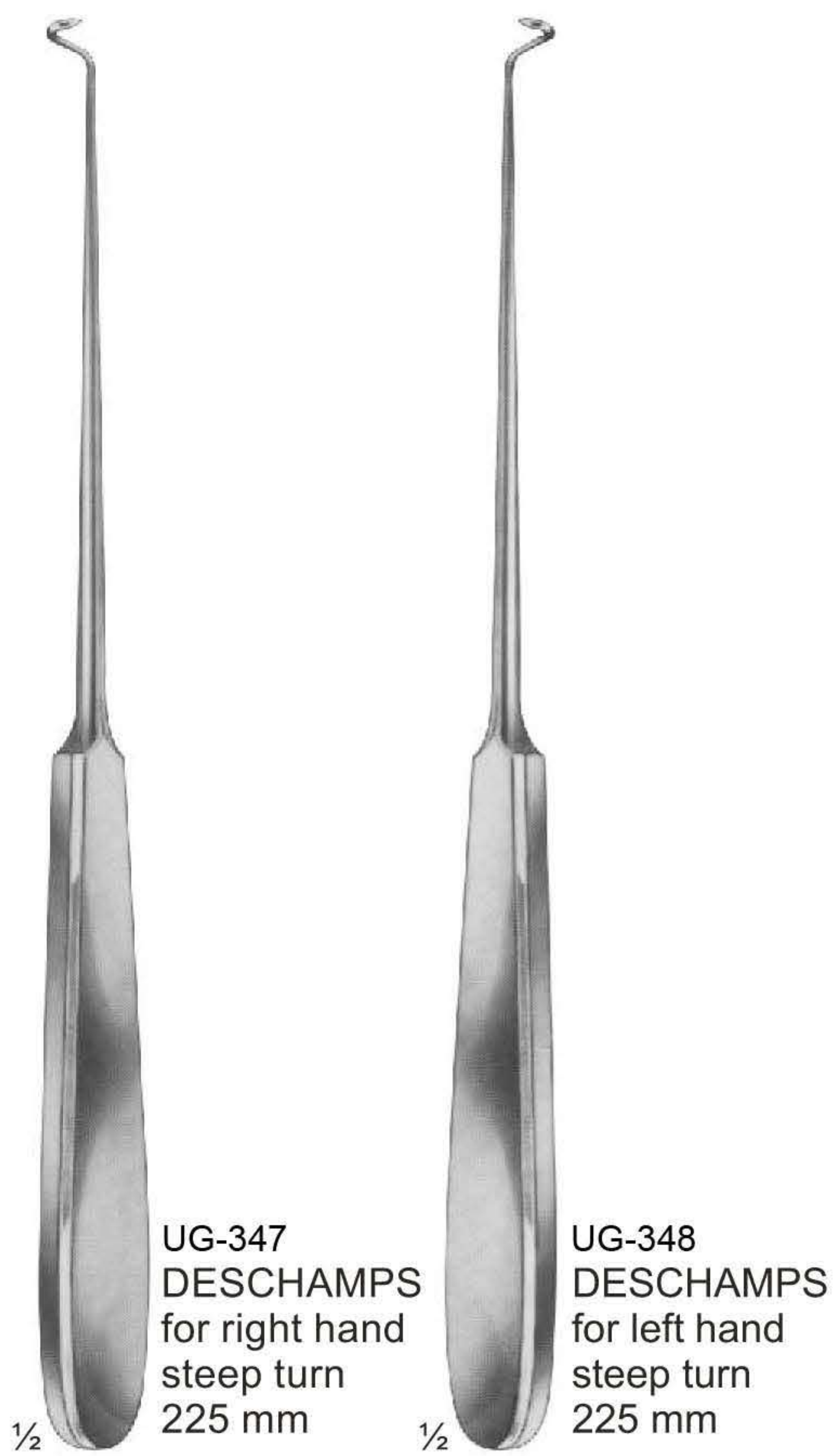

# Suture Instruments - Ligature Needles



1/2  
UG-368  
HURD  
for right hand  
sharp  
210 mm



1/2  
UG-371  
HURD  
for left hand  
sharp  
210 mm



1/2  
UG-372  
DESCHAMPS  
for right hand  
sharp  
215 mm



1/2  
UG-373  
DESCHAMPS  
for left hand  
sharp  
215 mm



1/2  
UG-374  
JONESCO  
Needle for wire suture  
185 mm



1/2  
UG-375  
CLAUS VAN EICKEN  
Needle for wire suture  
250 mm



1/2  
UG-376  
150 mm



1/2  
UG-377  
SYME  
170 mm



1/2  
UG-378  
COOPER  
205 mm



1/2  
UG-379  
KOCHER  
205 mm

# Ligature Needles

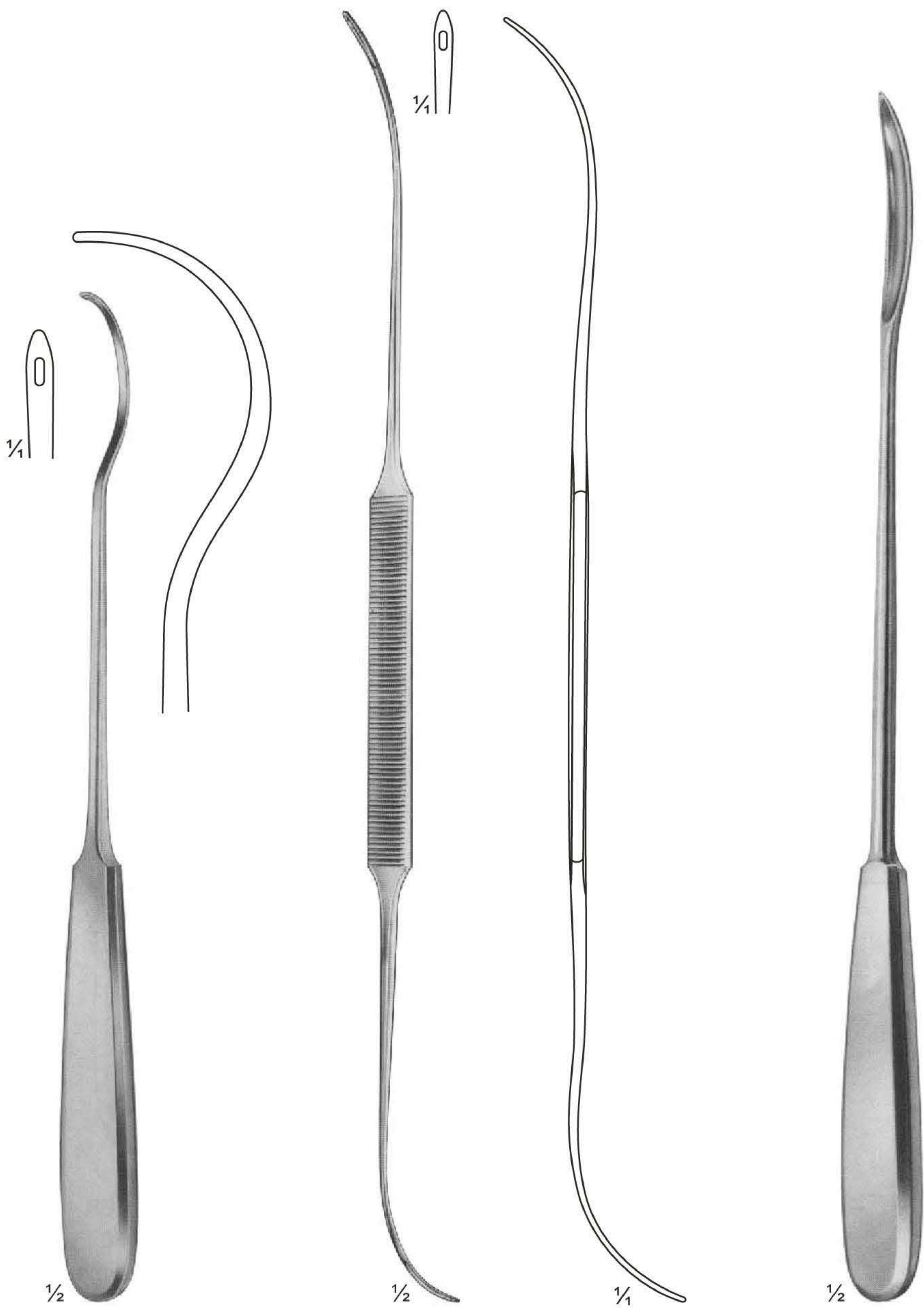

UG-380  
BRUNNER  
240 mm

UG-381  
SCHMIEDEN-DICK  
320 mm

UG-382  
BRUNNER  
Guiding Probes  
300 mm





# Suture Instruments - Reverdin Needles

---



UG-339  
REVERDIN  
140 mm



UG-340  
REVERDIN  
195 mm



UG-341  
REVERDIN  
220 mm

# Suture Instruments - Ligature Needles

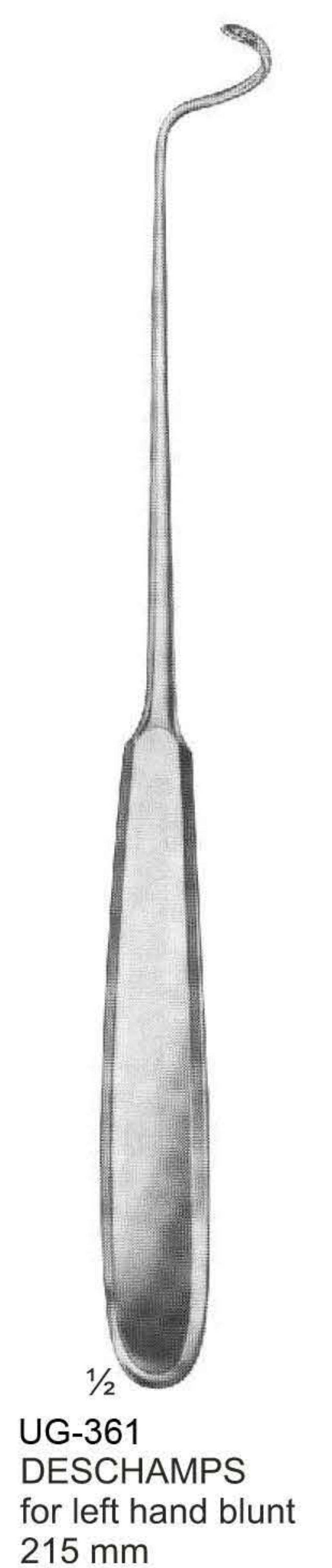
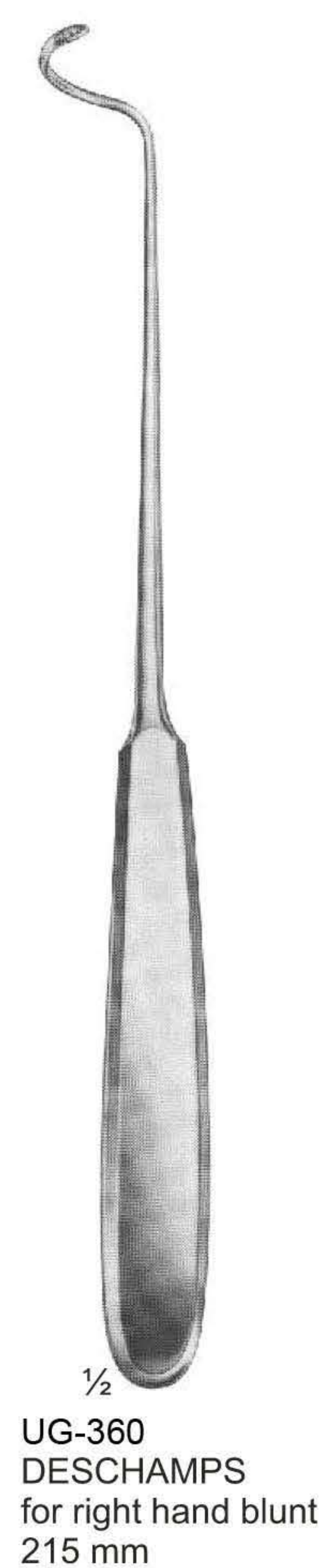
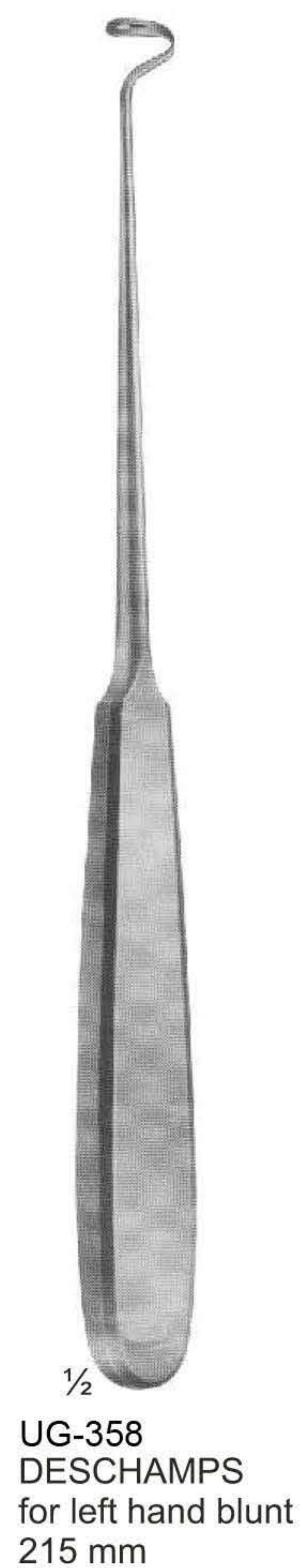
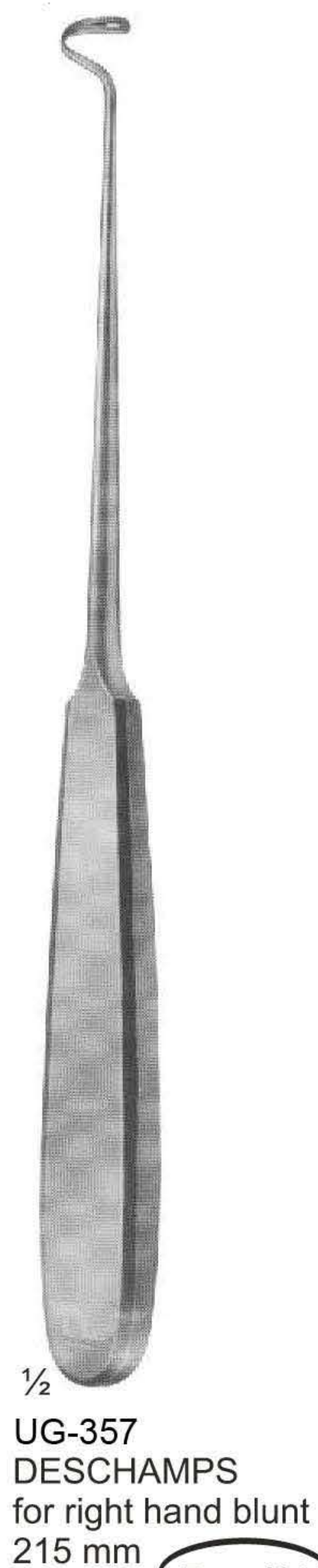
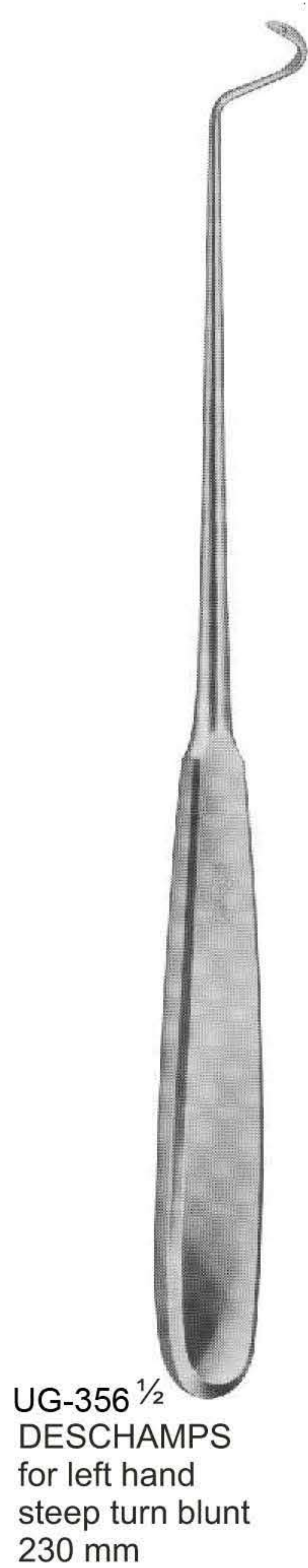
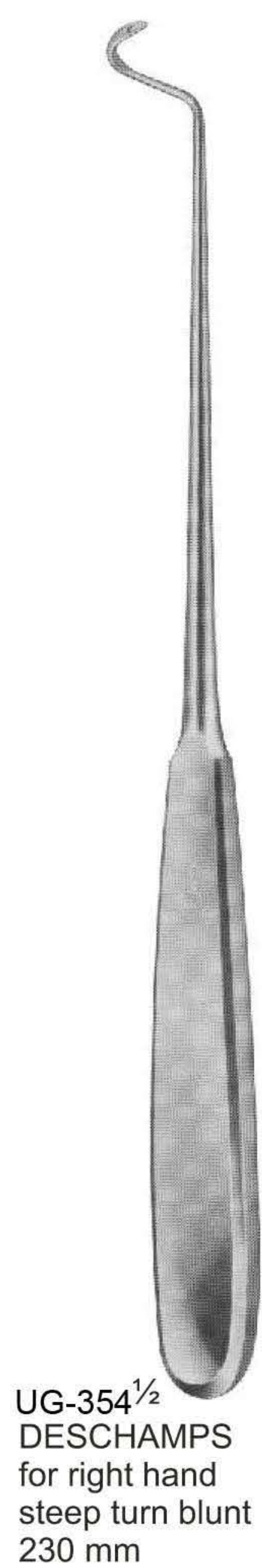
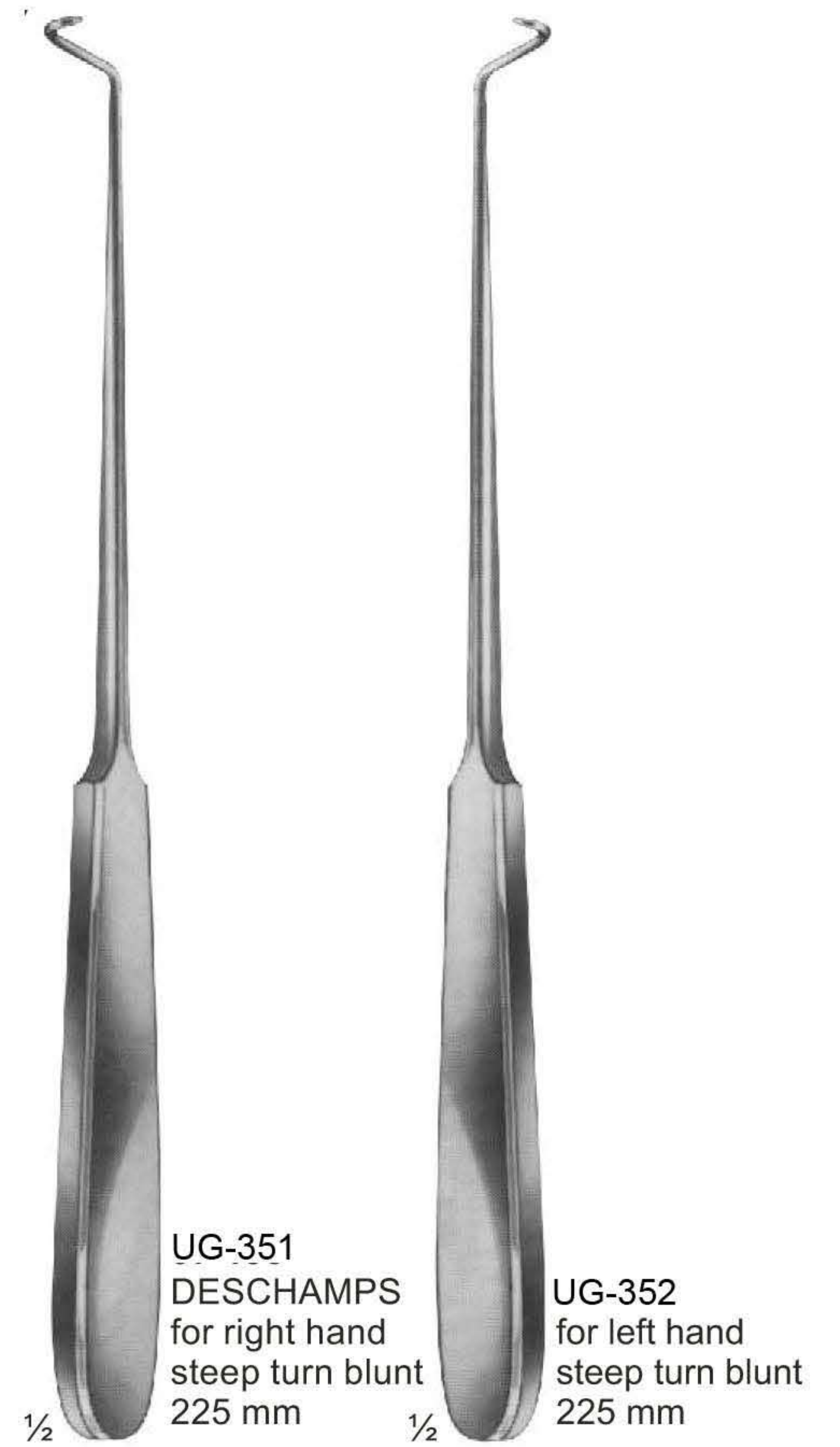
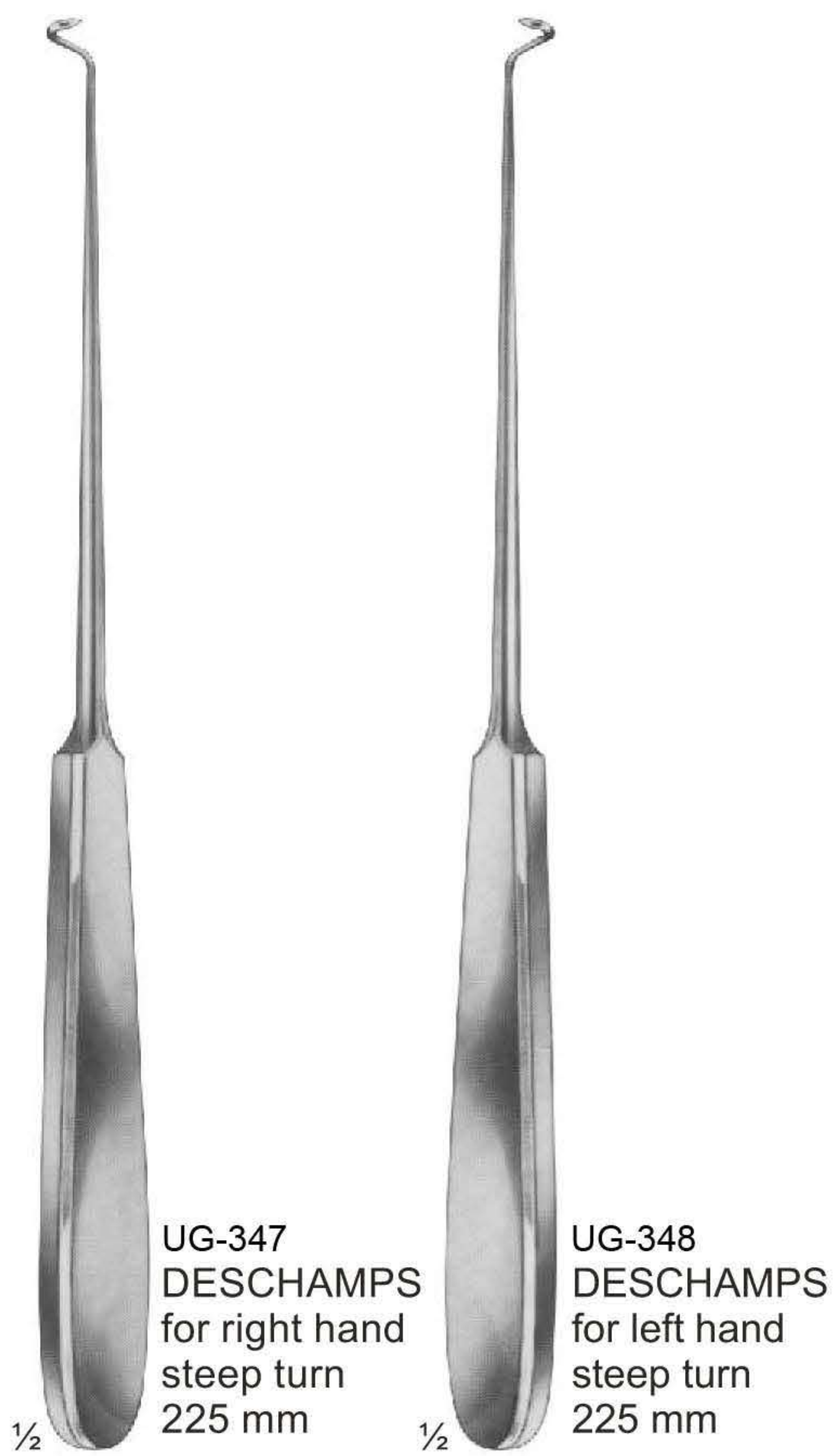

# Suture Instruments - Ligature Needles



1/2  
UG-368  
HURD  
for right hand  
sharp  
210 mm



1/2  
UG-371  
HURD  
for left hand  
sharp  
210 mm



1/2  
UG-372  
DESCHAMPS  
for right hand  
sharp  
215 mm



1/2  
UG-373  
DESCHAMPS  
for left hand  
sharp  
215 mm



1/2  
UG-374  
JONESCO  
Needle for wire suture  
185 mm



1/2  
UG-375  
CLAUS VAN EICKEN  
Needle for wire suture  
250 mm



1/2  
UG-376  
150 mm



1/2  
UG-377  
SYME  
170 mm



1/2  
UG-378  
COOPER  
205 mm



1/2  
UG-379  
KOCHER  
205 mm



# Probes



UG-408 145 mm  
 UG-409 160 mm  
 UG-410 200 mm  
 Probes with eye



UG-411  
 Myrtle leaf probe  
 145 mm



UG-412 130 mm  
 UG-413 145 mm  
 UG-414 160 mm  
 UG-415 180 mm  
 UG-416 200 mm



UG-417  
 Probes



UG-418 1/2  
 Double ended probe,  
 malleable, diam. of tips  
 3 mm with hole  
 190 mm



UG-419  
 Double ended probes,  
 tin, malleable,  
 diam. of tips  
 3,5 mm with hole  
 250 mm, 300 mm



UG-420  
 Double ended probes,  
 tin, malleable,  
 diam. of tips 4 mm  
 400 mm



UG-421 1,5 mm  
 UG-422 2,0 mm  
 UG-423 2,5 mm  
 300 mm

# Examination & Measuring Instruments

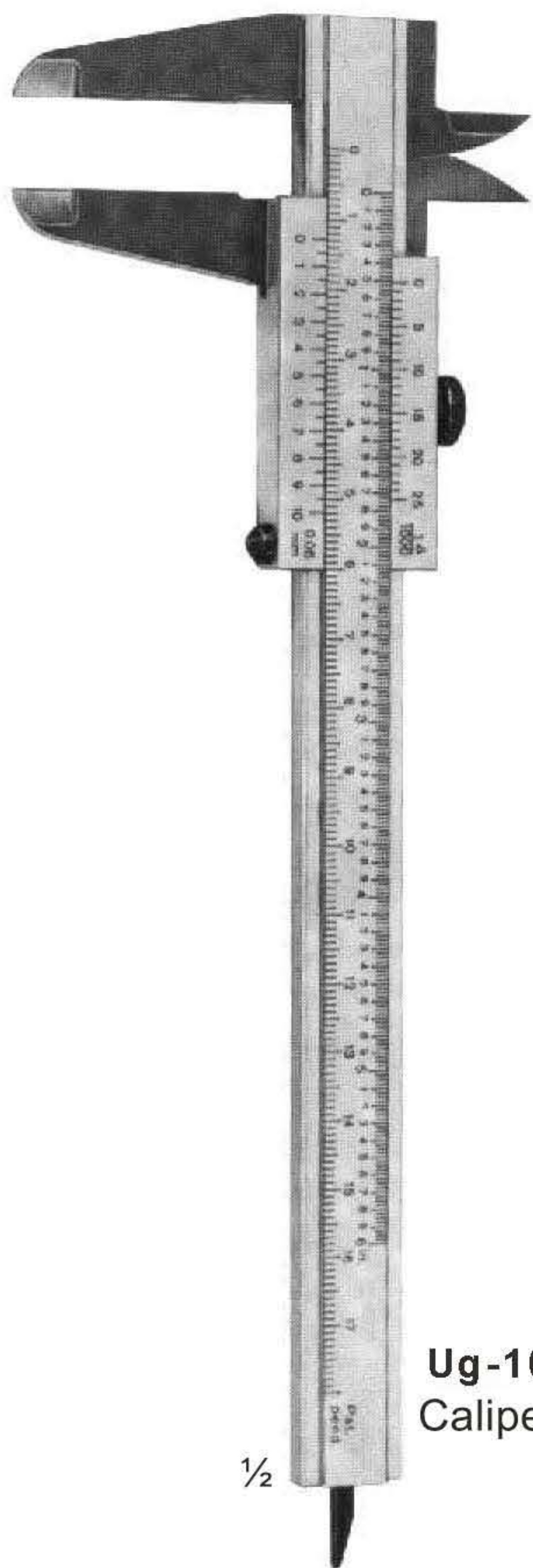

**Ug-101**  
Caliper Of Aluminum



**UG-102**  
VERNIER  
Universal Caliper Of Steel  
SIZE:222mm

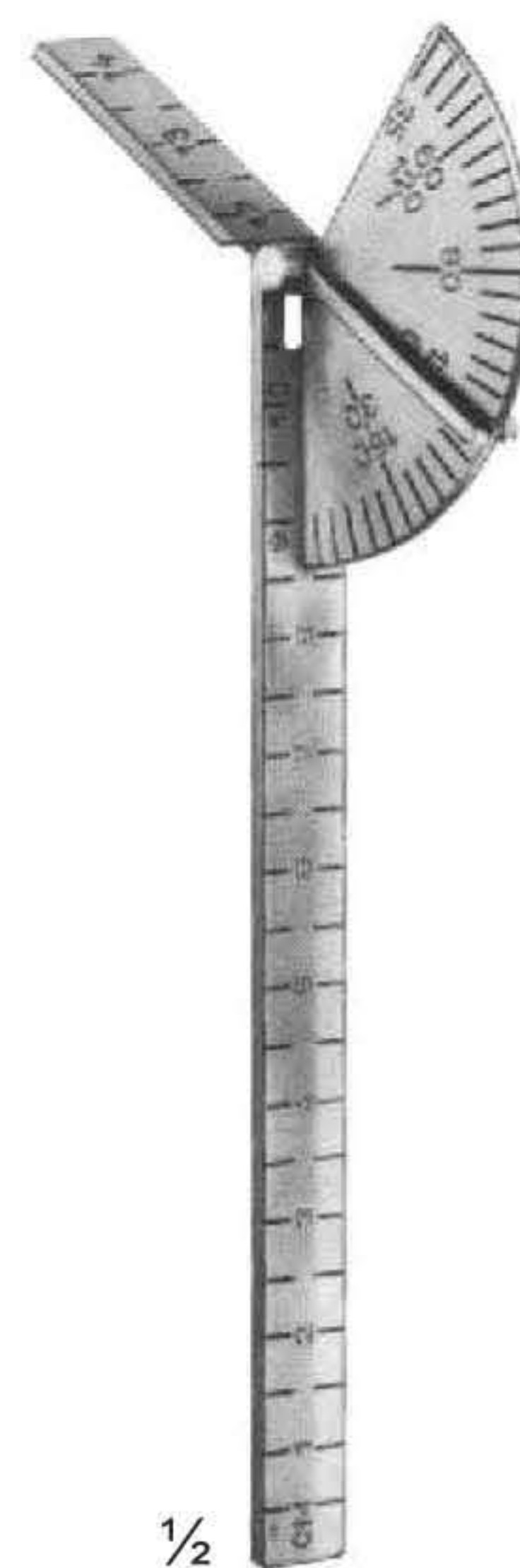

**UG-105**  
CAROLL  
SIZE:115mm



**UG-106**  
TOWNLEY  
SIZE:240mm

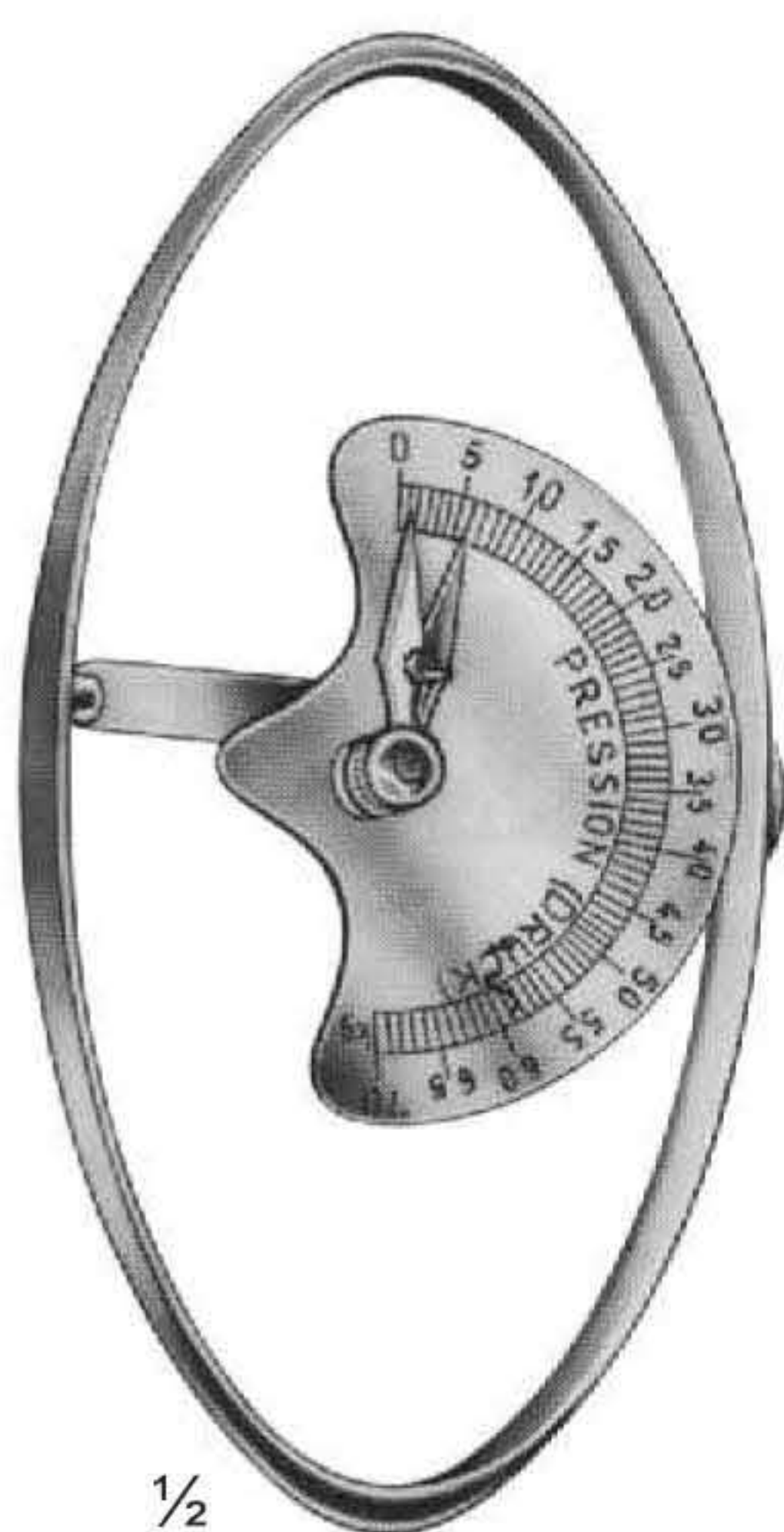

**UG-108**  
COLLIN  
Druck Pressure 72 kg  
SIZE:145mm



**UG-110**  
BERTILLON  
Caliper For Measuring The Head  
SIZE:220mm



**UG-111**  
CASTROVIEJO  
Caliper  
SIZE: 145mm

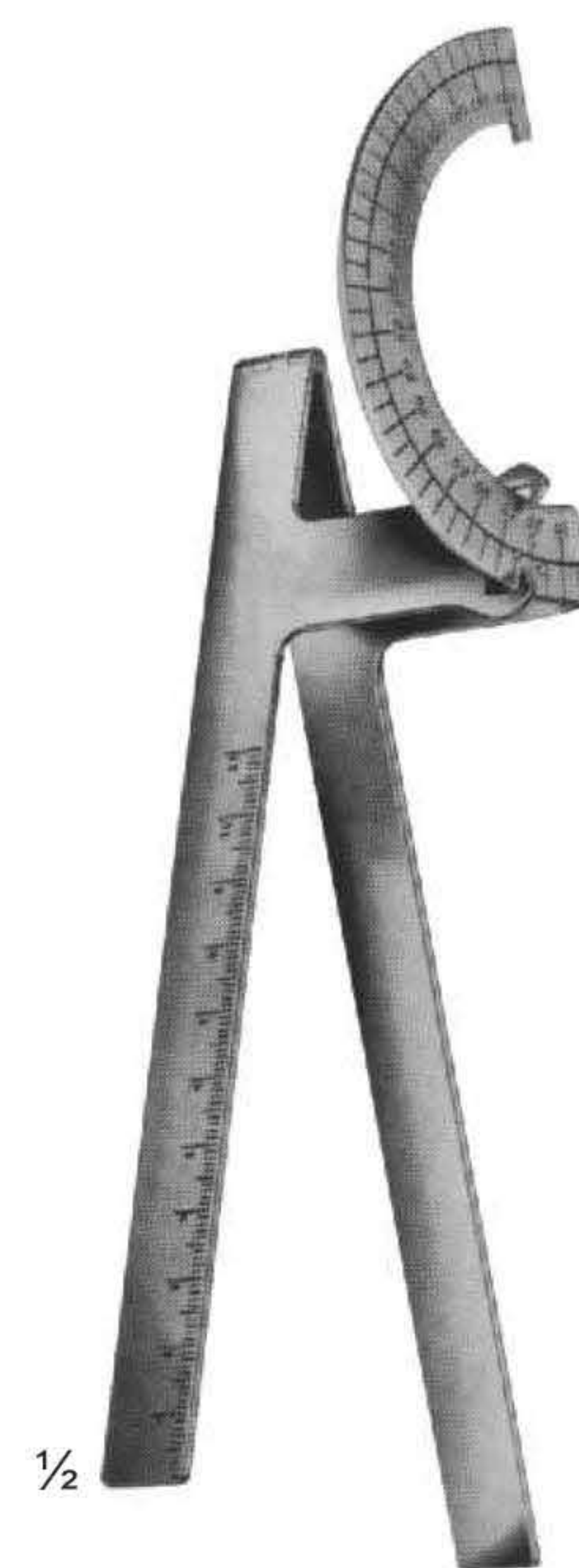

**UG-114**  
MOLTGEN  
Goniometer



**UG-085**  
Size: 150 mm

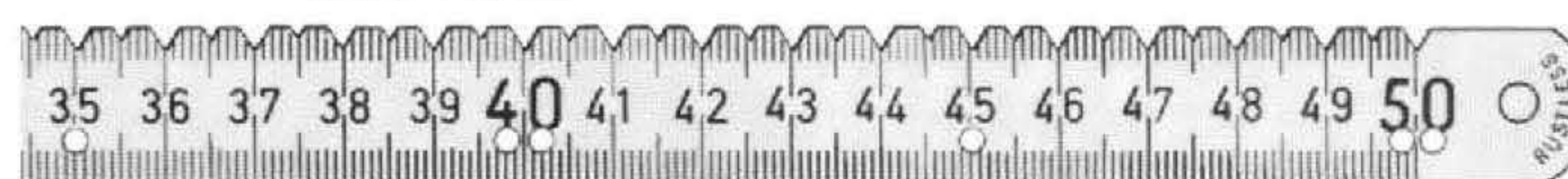

**UG-084**  
Size: 500 mm

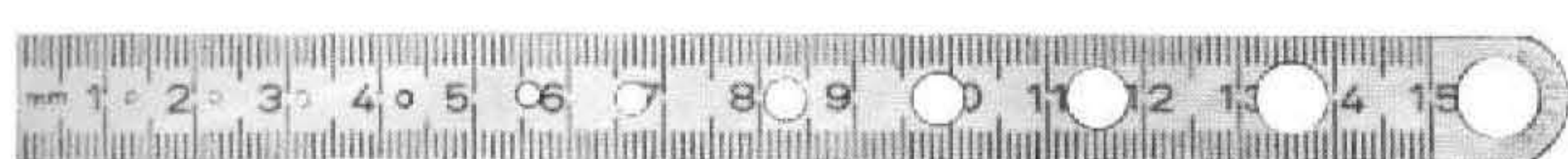

# Probes - Spatulas - Cotton Applicators



UG-424  
STACKE  
100 mm



UG-425  
KILLIAN  
165 mm



UG-426  
160 mm



UG-427  
SEIFFERT  
180 mm



UG-428  
BOWMAN  
130 mm



UG-429  
SPATULA  
145 mm



UG-430  
SPATULA  
145 mm



UG-431  
Modell PICCOLO  
Round Serrated  
110 mm



UG-432  
Modell PICCOLO  
Triangular Serrated end  
110 mm



UG-434  
FARRELL  
Round Serrated end  
110 mm



UG-435  
LATHBURY-FARREL  
Triangular Serrated end  
110 mm



# Cotton Applicators

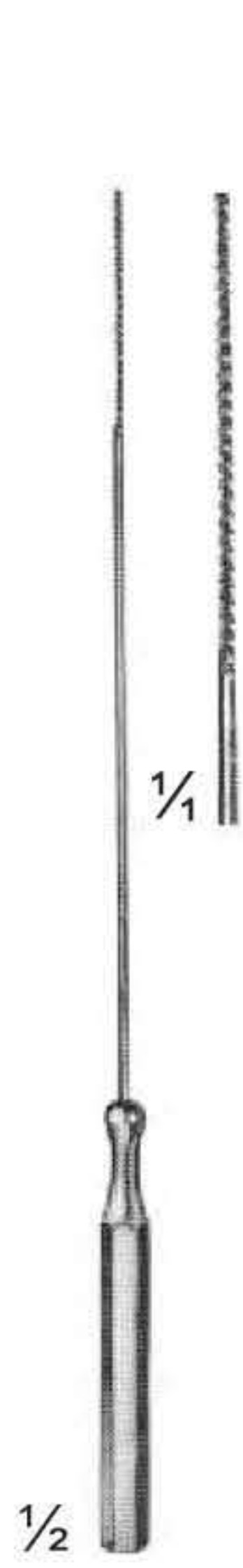

UG-438  
BUCK  
Rough, spiral end  
120 mm

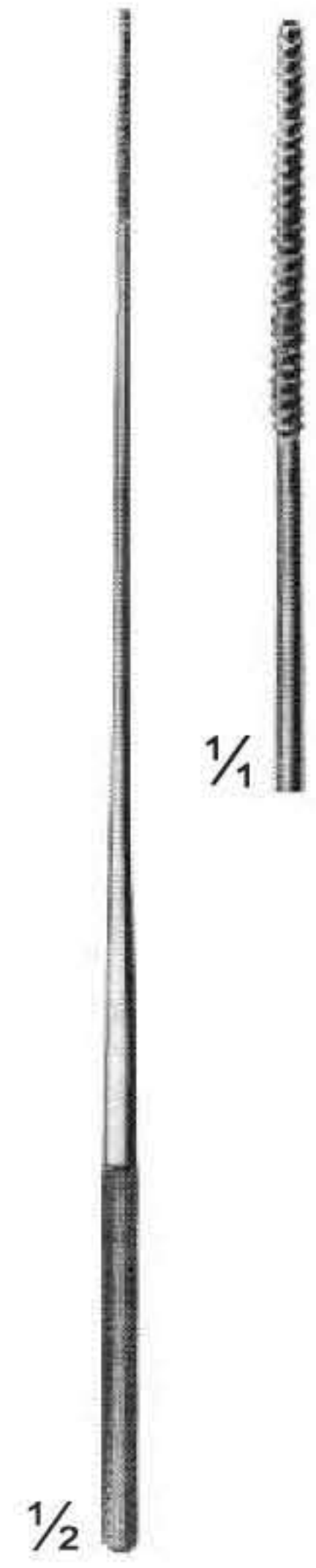

UG-440  
Triangular  
serrated end  
140 mm

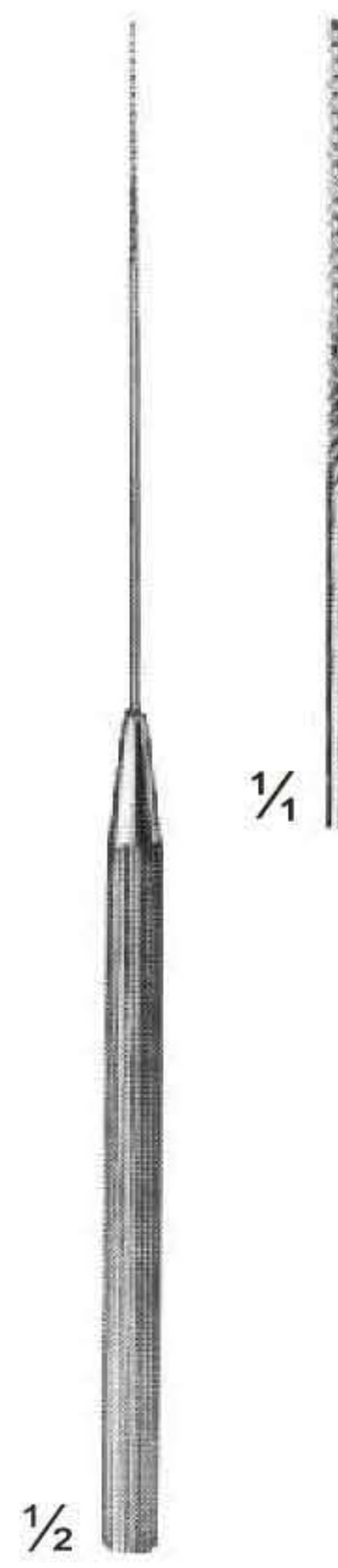

UG-441  
Rough, spiral end  
140 mm



UG-443  
Rough, spiral end  
140 mm



UG-444  
Rough, spiral end  
140 mm



UG-446  
FARRELL  
Round,  
serrated end  
140 mm



UG-447  
LATHBURY-FARRELL  
Triangular,  
serrated end  
140 mm

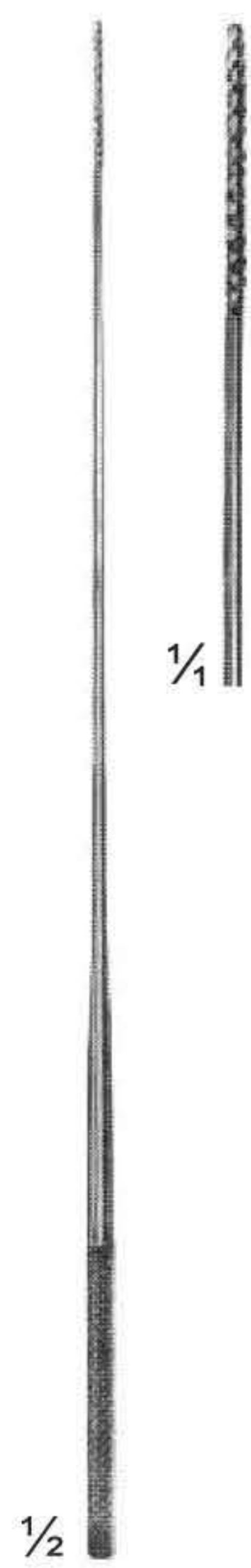

UG-3512  
FARRELL  
Rough,  
spiral end  
160 mm



UG-3513  
LATHBURY-FARRELL  
Triangular,  
serrated end  
160 mm



UG-3514  
Triangular,  
serrated end  
160 mm



UG-3515  
Rough,  
spiral end  
180 mm



UG-3516  
Rough,  
spiral end  
180 mm

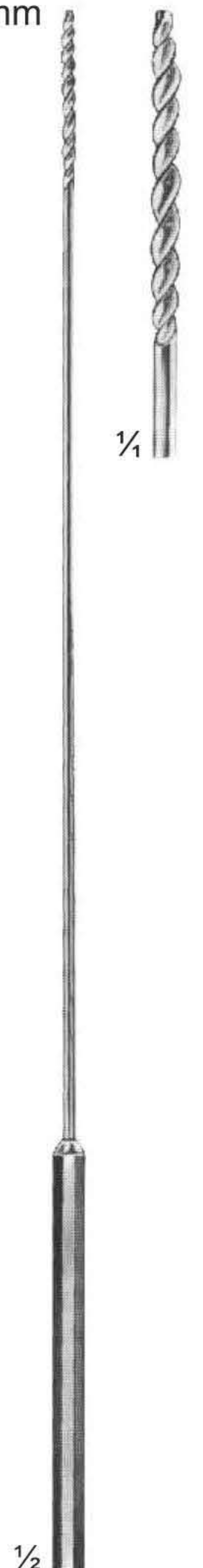

UG-3517  
Rough,  
spiral end  
270 mm



# Clip Applying Forceps - Suture Set



1/2

UG-2029  
MICHEL  
125 mm



1/2

UG-2030  
HEGENBARTH  
120 mm



1/2

UG-2032  
WACHENFELDT  
120 mm



1/2

UG-2033  
WACHENFELDT  
120 mm



1/2

UG-2034  
MICHEL  
125 mm



1/2

UG-2036  
MICHEL modif.  
130 mm



1/2

UG-2037  
HEATH  
135 mm

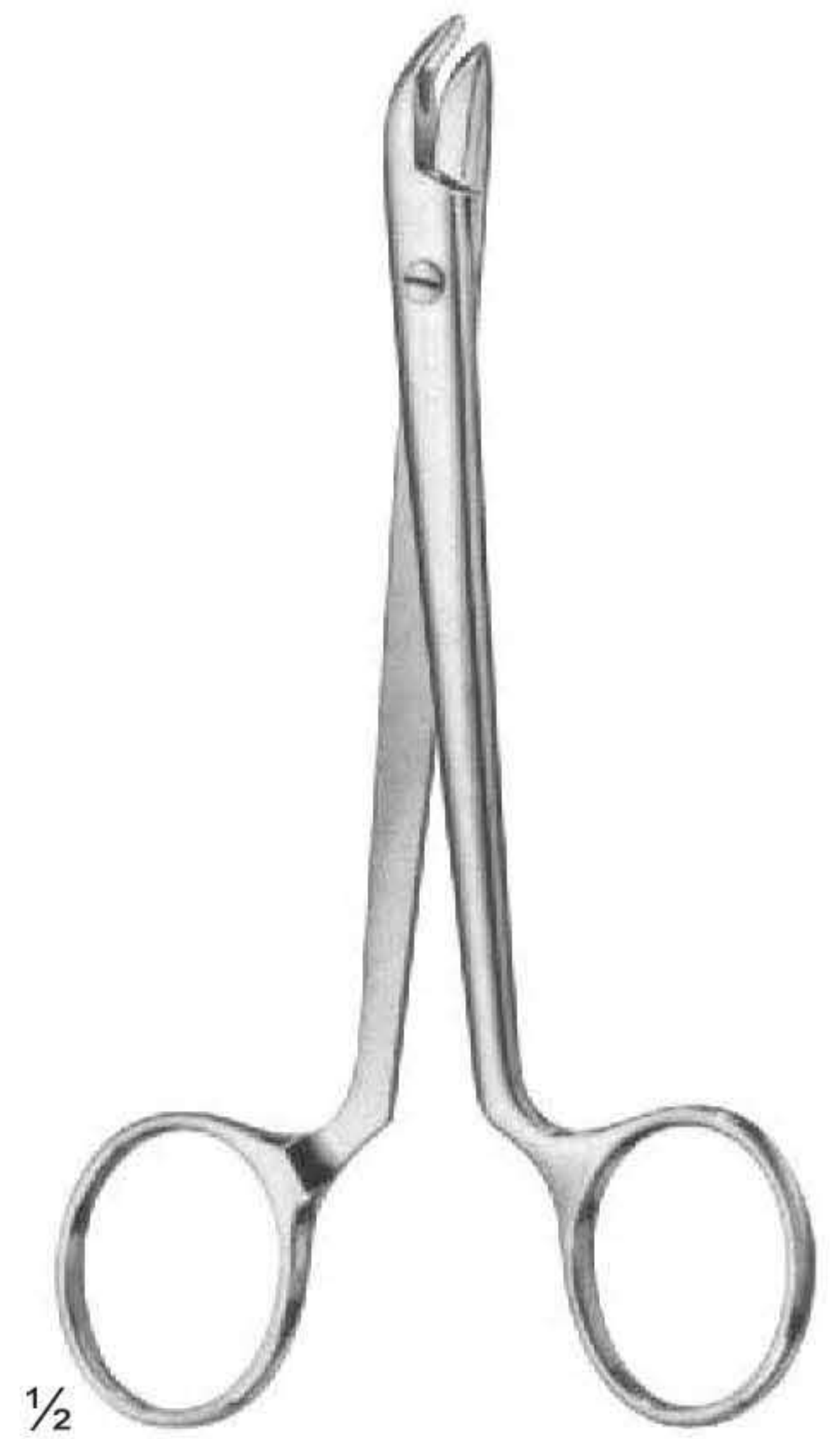

1/2

07-289  
COLLIN  
135 mm

# Clip Applying Forceps - Suture Set



UG-2039

Suturing instruments set, in metal case consisting of: Scissors, curved, sharp/sharp, 115mm  
25 MICHEL clip, 16 x 3mm  
1 Delicate tissue forceps, 130mm  
1 Scalpel, bellied  
1 MATHIEU needle holder, 140mm  
1 Perforated metal case, stainless containing:  
1 Suture needle  
1 item 1 item



UG-2040

Pocket instrument set, in metal case consisting of:

**Bottom tray**

1 MATHIEU needle holder, 140mm  
1 MICHEL clip forceps, combined  
1 Myrtle leaf probe, 130mm  
1 Sharp double curette  
1 Skin hook  
1 Detachable scalpel handle, no.4  
1 Perforated metal case, containing  
6 Scalpel blades BB 520  
1 Perforated metal case, stainless, containing  
1 Suture needle  
1 item  
1 item

**Top tray**

1 Tissue forceps, 130mm  
1 KOCHER haemostatic forceps, 130mm  
1 Straight surgical scissors, 130mm  
1 Dissecting forceps, 130mm  
1 FEILCHENFELD splinter forceps, 115mm  
25 MICHEL clip, 16 x 3mm  
1 Flacon of suture skin, sterile in alcohol

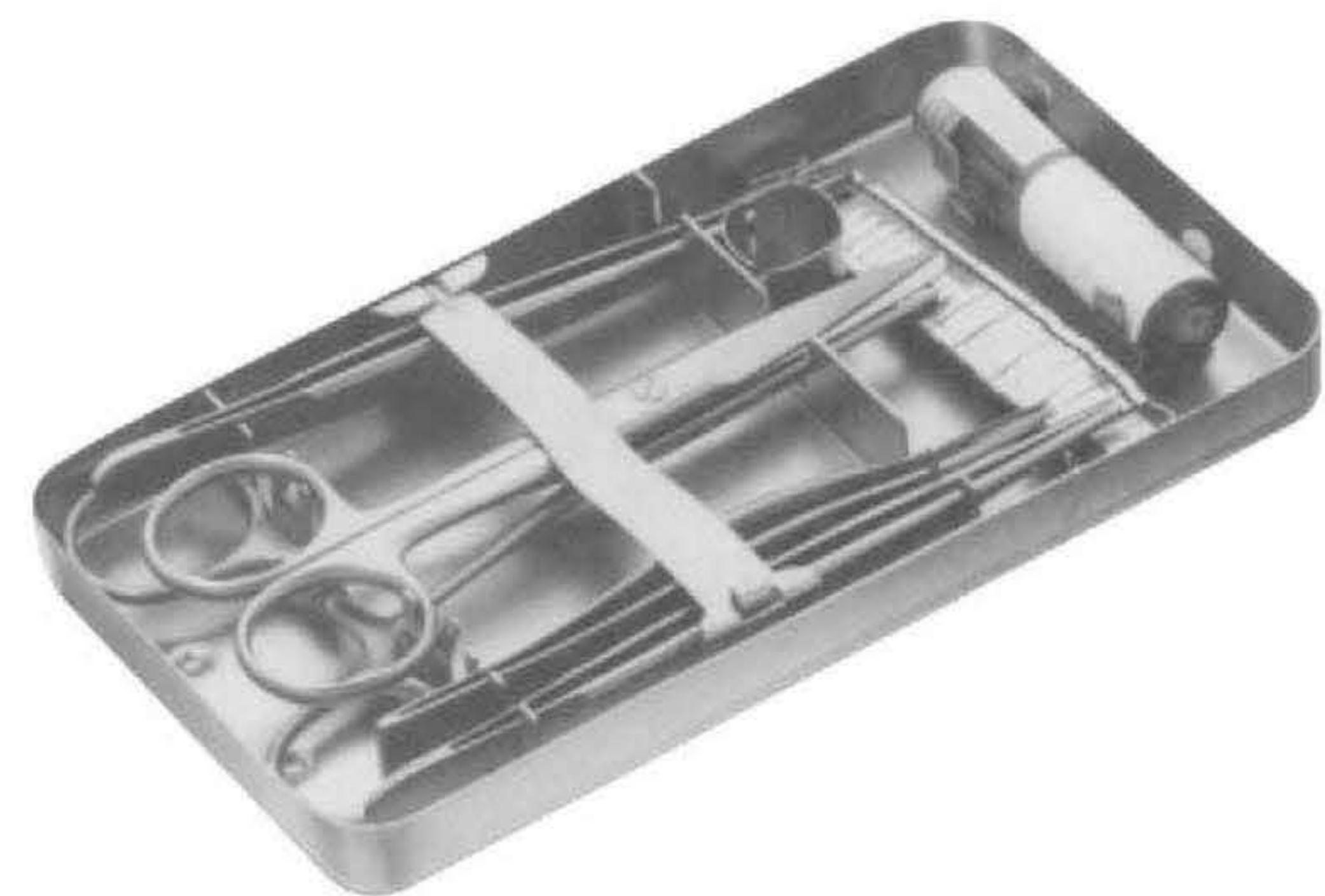

UG-2041

Pocket instrument set, in metal case consisting of:

**Bottom tray**

1 MAYO-HEGER needle holder, 150mm  
1 MICHEL clip forceps, combined  
1 Myrtle leaf probe, 130mm  
1 Sharp double curette  
1 Skin hook  
1 Detachable scalpel handle, no. 4  
1 Perforated metal case, consisting  
6 Scalpel blades BB 520  
1 Perforated metal case, stainless, consisting:  
1 Suture needle  
1 item, & 1 item

**Bottom tray**

1 Tissue forceps, 130mm  
1 CRILE haemostatic forceps, 140mm  
1 Straight surgical scissors, 130mm  
1 Dissecting forceps, 130mm  
1 FEILCHENFELD splinter forceps, 115mm  
25 MICHEL clip, 16 x 3mm  
1 Flacon of suture silk, sterile in alcohol

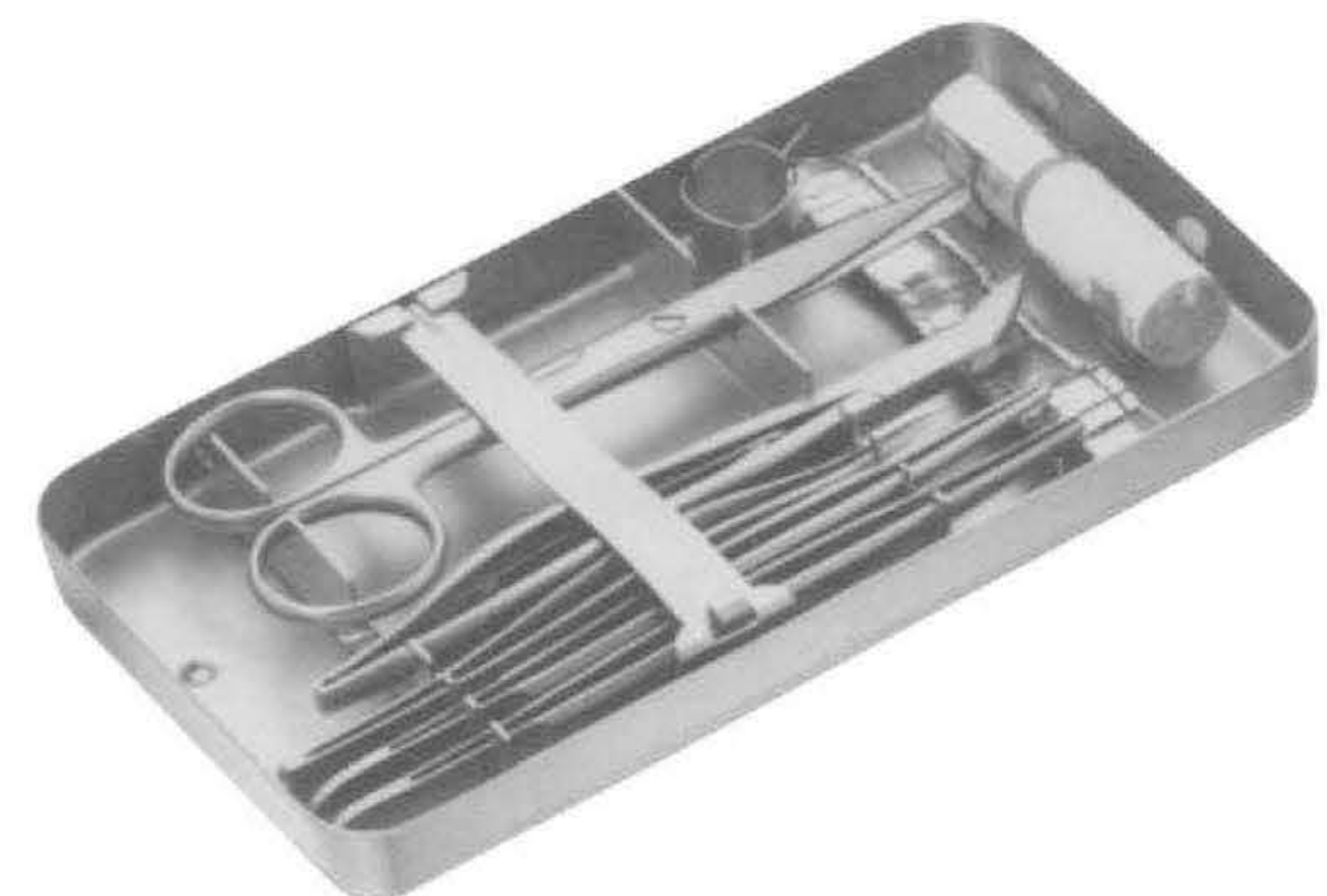

## Clip Applying Forceps - Suture Set

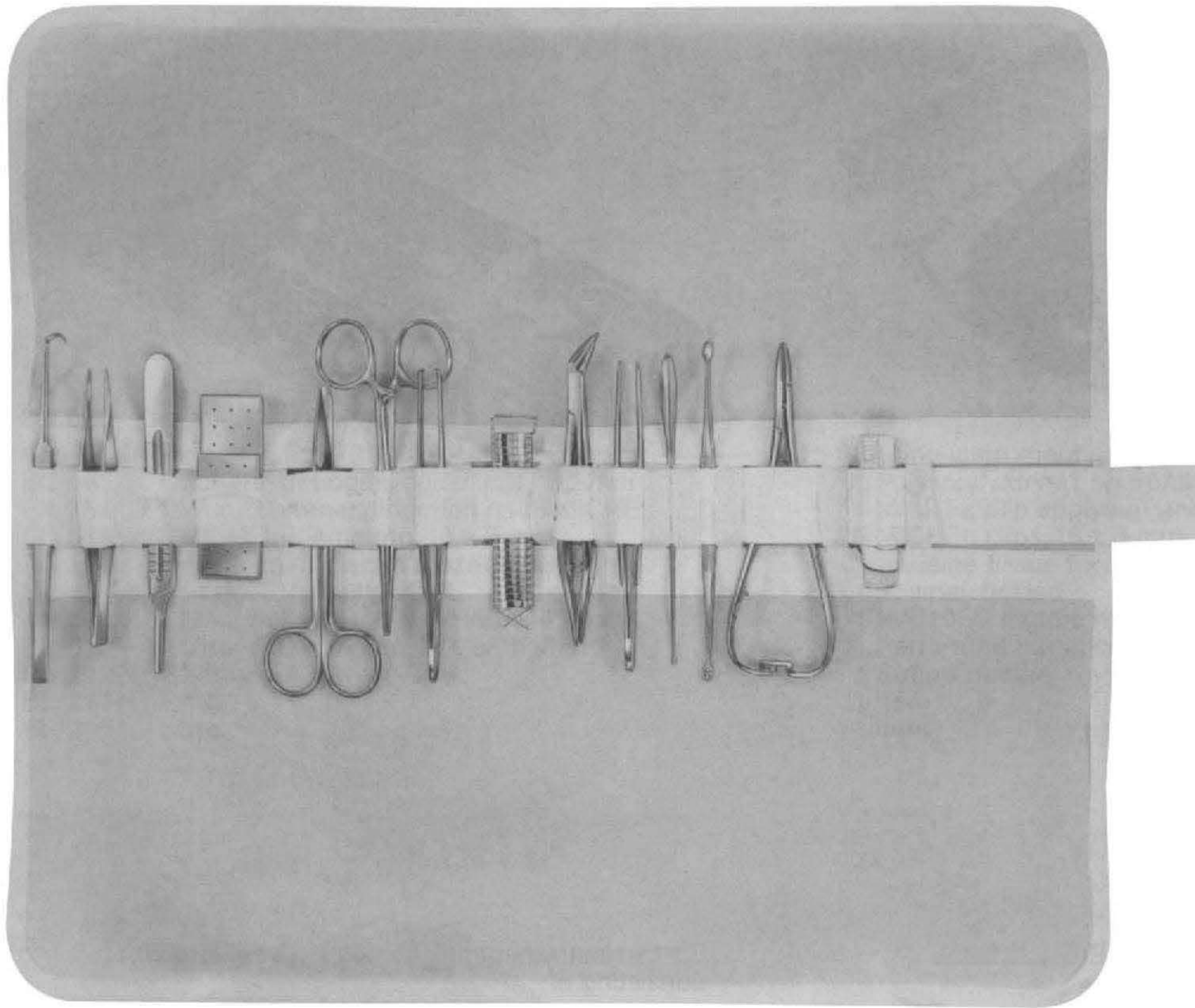

UG-2028  
Pocket instrument set in metal case 170 x 90mm  
with sterilizable canvas roll  
consisting of:  
1 Myrtle leaf probe, 130mm  
1 Sharp double curette  
1 FEILCHENFELD splinter forceps, 115mm  
1 Dissecting forceps, 130mm  
1 Tissue forceps, 130mm

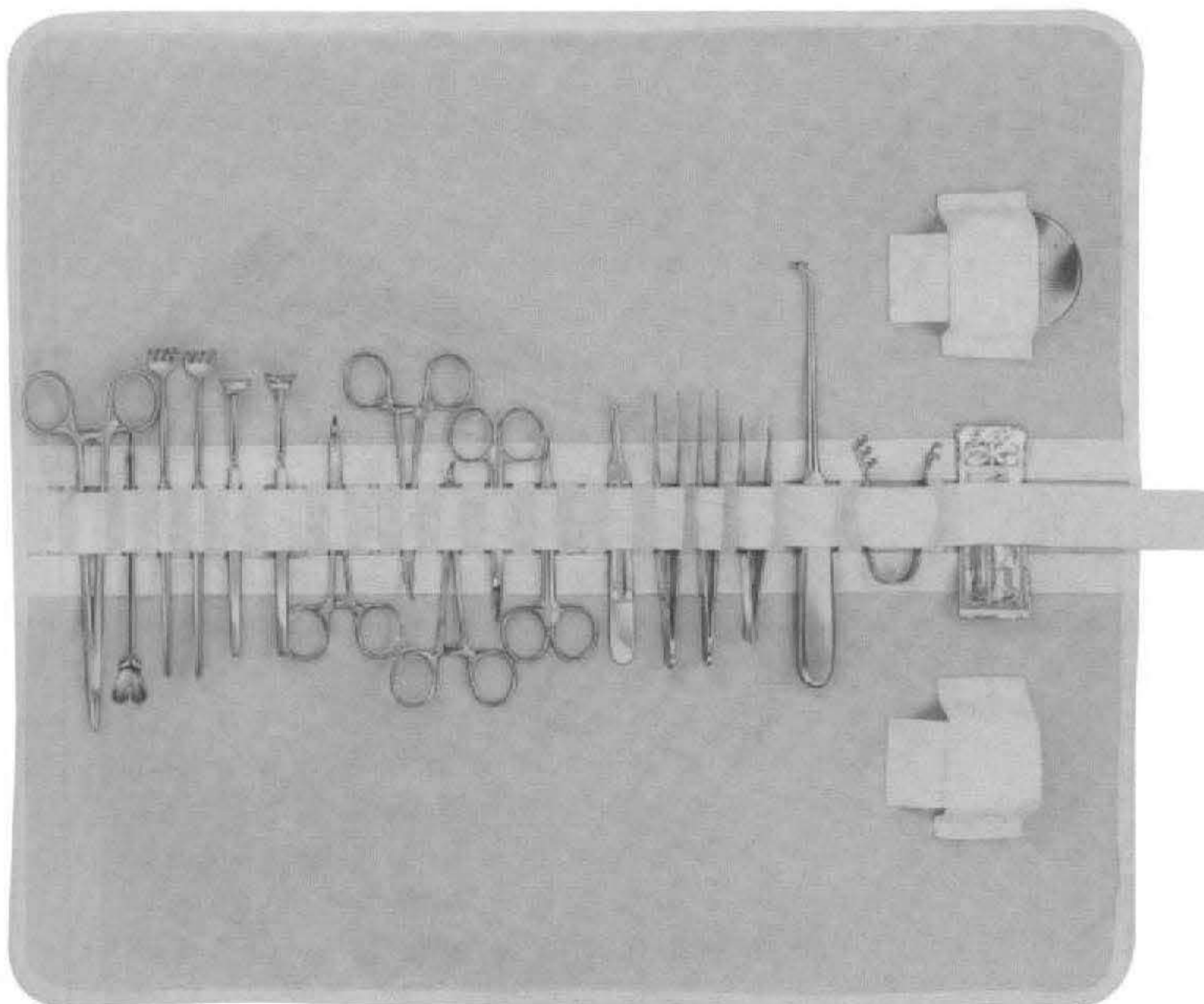

UG-2031  
Venae sectio set, in sterilizable canvas roll  
consisting of:  
1 Tissue forceps, 1 x 2 teeth, 140mm  
1 Dissecting forceps, 145mm  
1 FEILCHENFELD straight scissors, sharp, 110mm  
1 curved scissors, blunt, 115mm  
1 HALSTED mosquito forceps, curved on flat,  
125mm

## Clip Applying Forceps - Suture Set

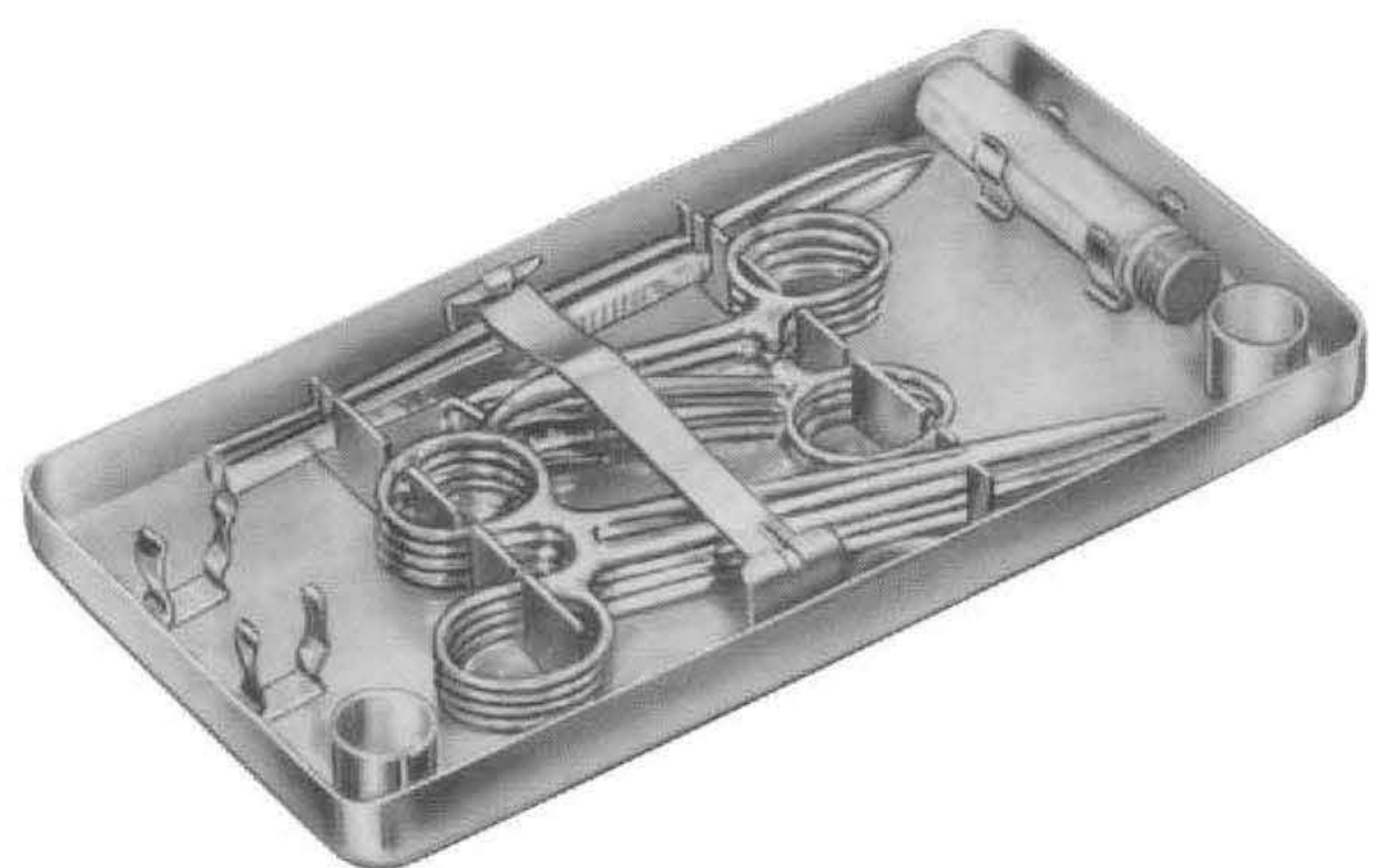
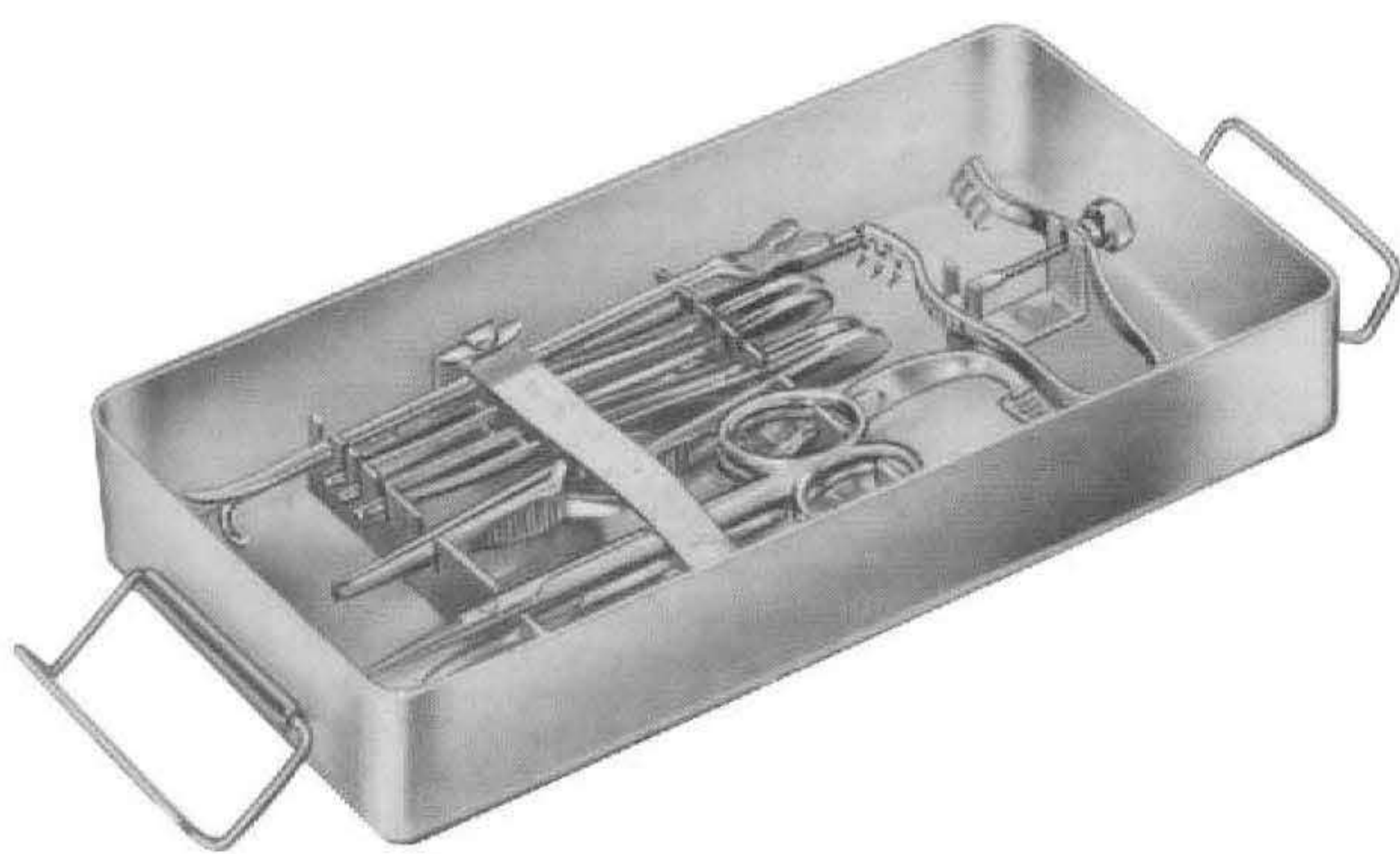

UG-2035

Venae sectio set, in metal case  
consisting of:

**Bottom tray**

- 1 MATHIEU needle holder, fine pattern 140mm
- 1 Ligature needle, fine short pattern
- 1 DOYEN director, curved
- 1 HEGENBARTH clip forceps,
- 1 ELSCHNIG tissue forceps, 1 x 2 teeth fine, 150mm
- 1 Dressing forceps, fine 105mm
- 1 Tissue forceps, 1 x 2 teeth, 110mm
- 1 Vessel scissors, straight, with 1 ball point, 110mm
- 1 Vessel scissors, curved, pointed 105mm
- 1 FINSEN retractor
- 1 Perforated needle case

**Top tray**

- 1 Scalpel, pointed
- 1 Scalpel, bellied
- 2 HALSTED mosquito forceps, curved, 125mm
- 2 HALSTED mosquito forceps, straight, 1x 2 teeth, 125mm
- 3 BACKHAUS towel forceps, 90mm
- 2 Flacon holder

# Nerve - and Vessel Hooks



$\frac{1}{2}$   
UG-712  
WAGENER  
150 mm



$\frac{1}{2}$   
UG-713  
GRAEFE  
140 mm



$\frac{1}{2}$   
UG-715  
BROM  
Vein hook  
170 mm



$\frac{1}{2}$   
UG-716  
CRILE  
200 mm



$\frac{1}{2}$   
UG-717  
CUSHING  
190 mm

# Nerve - and Vessel Hooks

---



$\frac{1}{2}$   
UG-718  
KRAYENBUHL  
185 mm



$\frac{1}{2}$   
UG-720  
CASPAR  
245 mm



$\frac{1}{2}$   
UG-721  
CUSHING  
280 mm

# Fine Wound Retractors (Dura- and Skin Retractors)



UG-724  
GRAEFE  
125 mm



UG-727  
Sharp  
GUTHRIE



UG-728  
ROLLET



UG-732  
FRAZIER  
Dura Retractors  
130 mm

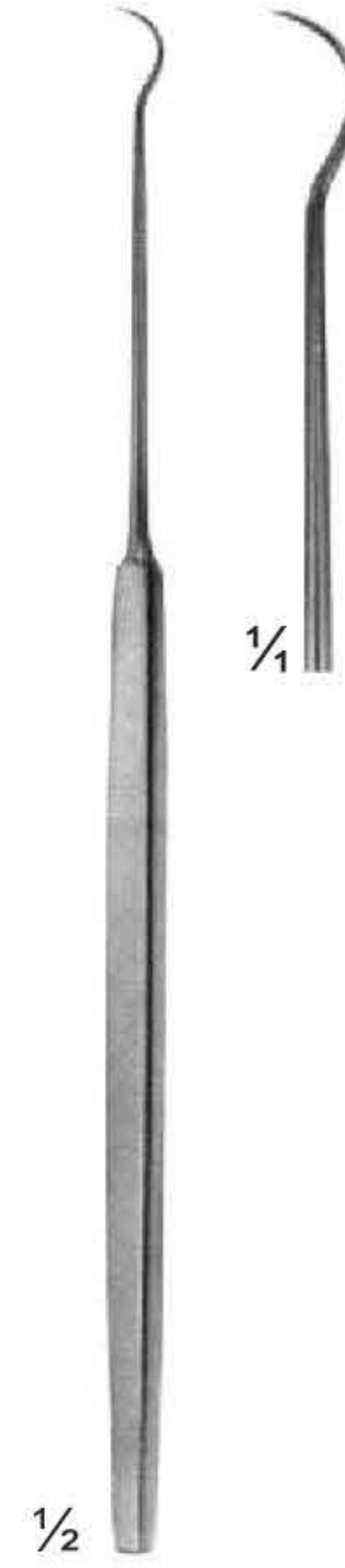

UG-734  
TONNIS  
Dura Retractors  
150 mm



UG-735  
KILNER  
160 mm

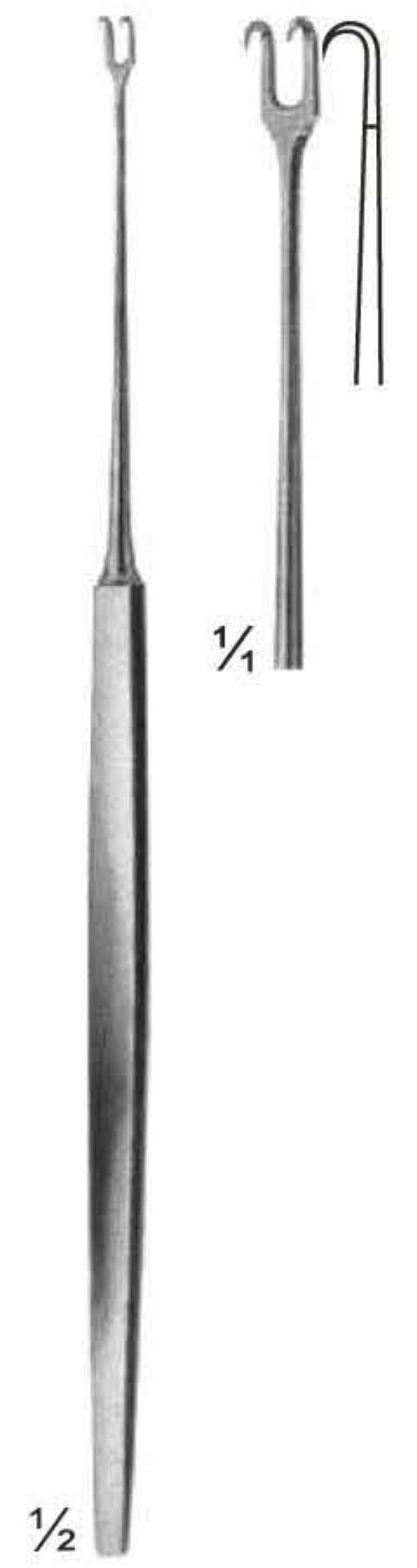

UG-737  
FREER  
150 mm



UG-738  
MULLER  
150 mm

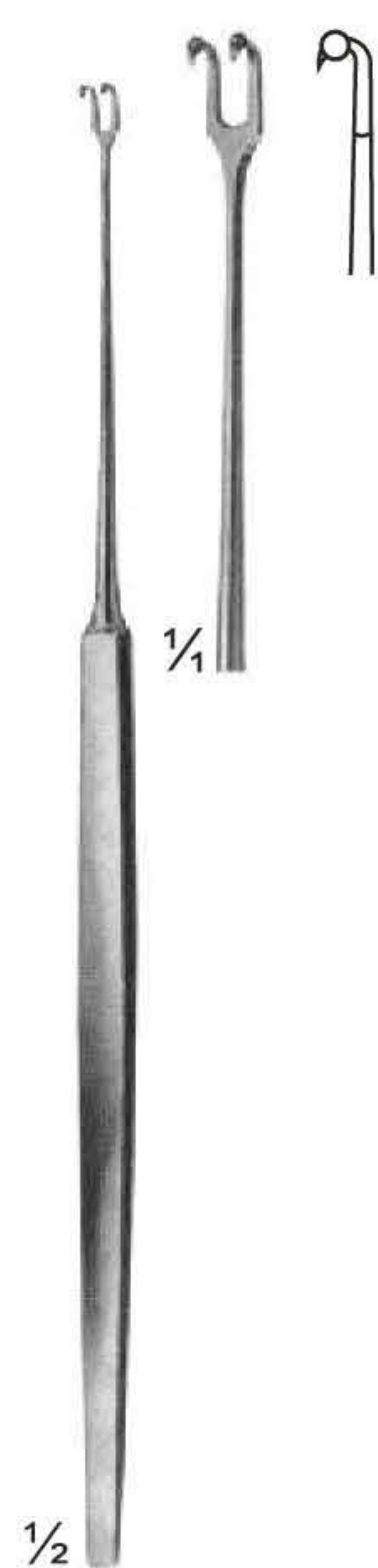

UG-740  
MULLER  
150 mm

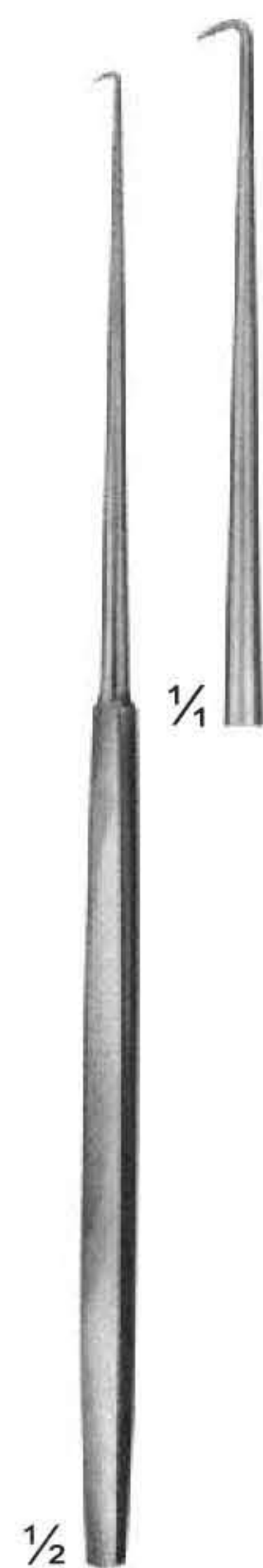

UG-741  
COTTLE  
160 mm



UG-742  
COTTLE  
160 mm



UG-743  
JAEGAR  
135 mm



UG-746  
JOSEPH  
165 mm



UG-749  
GILLIES  
180 mm



UG-751  
KILNER  
Sharp  
80 mm



UG-753  
CONVERSE  
Blunt  
120 mm

# Wound - Trachea Retractors

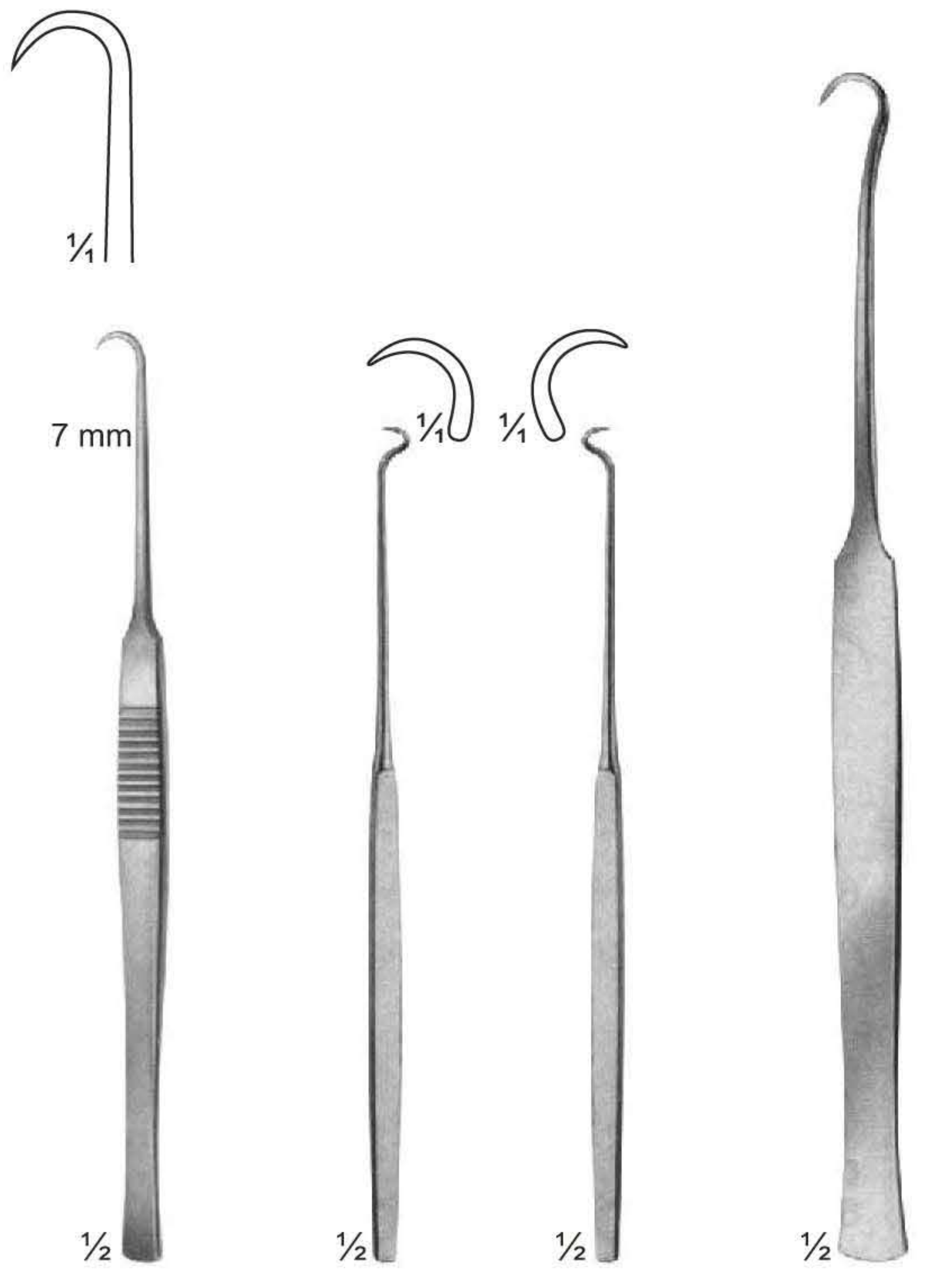

UG-757  
BERGMANN  
140 mm

UG-758  
BOSE  
165 mm

UG-760  
BOSE  
165 mm

UG-763  
180 mm

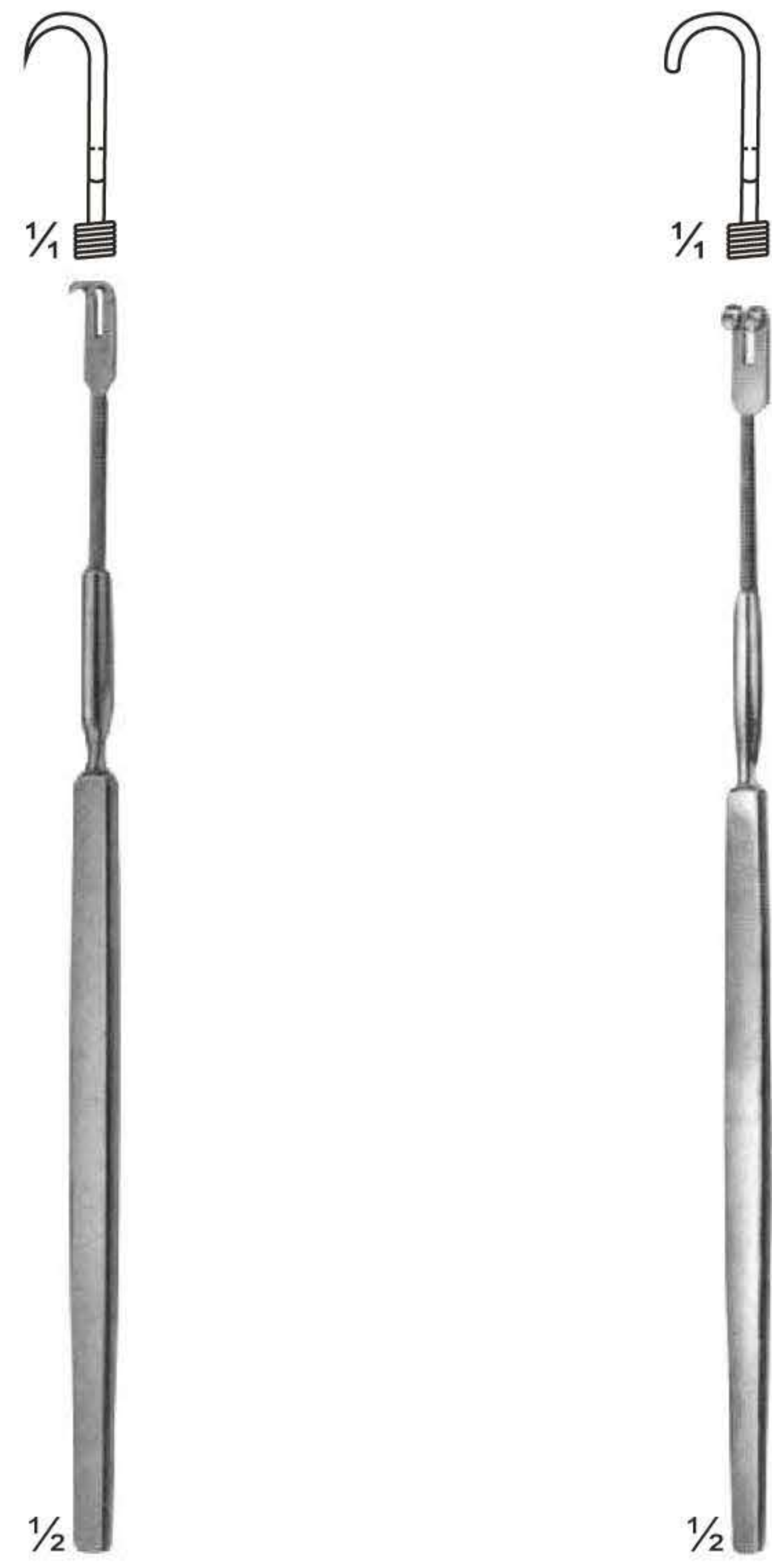

UG-765  
Flexible shaft, sharp  
155 mm

UG-766  
Flexible shaft, blunt  
155 mm



UG-768  
Large curve,  
sharp  
165 mm



UG-774  
Large curve,  
blunt  
165 mm





1/2

**UG-122**  
Fig. 1 - 10  
SIZE: 100mm

# Retractors

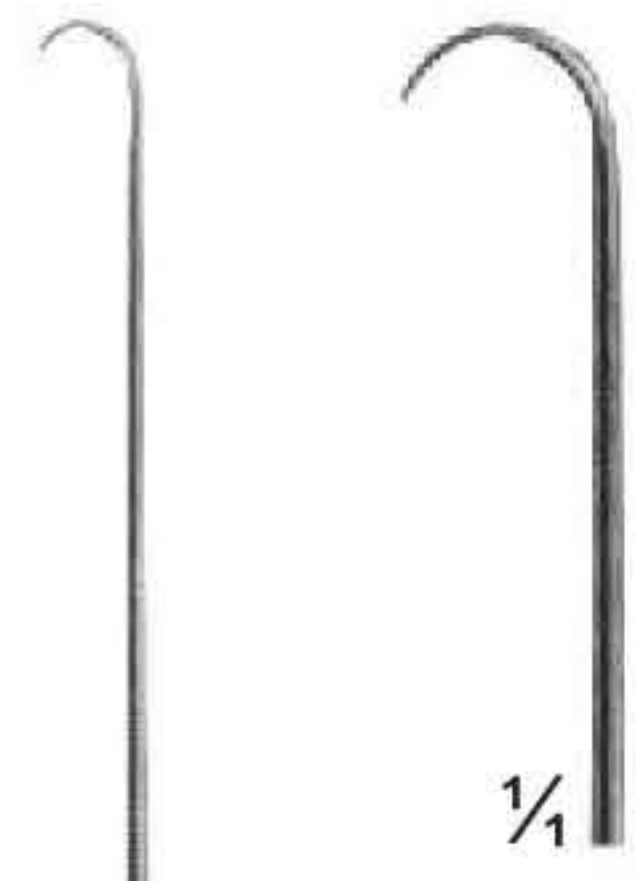

1/2

UG-816  
EMMET  
Fistula hook  
220 mm

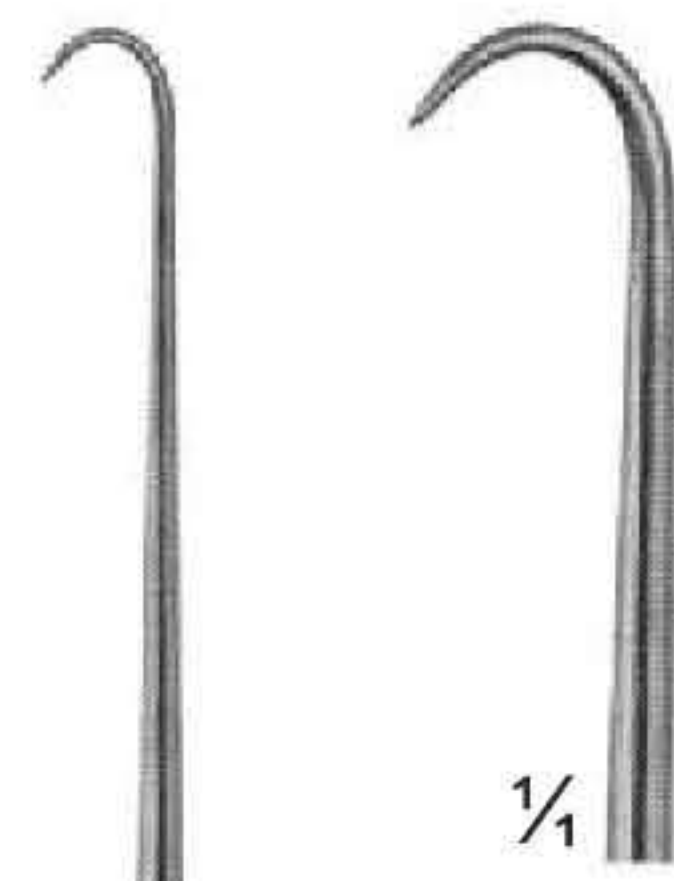

1/2

UG-817  
SIMON  
Fistula hook  
220 mm

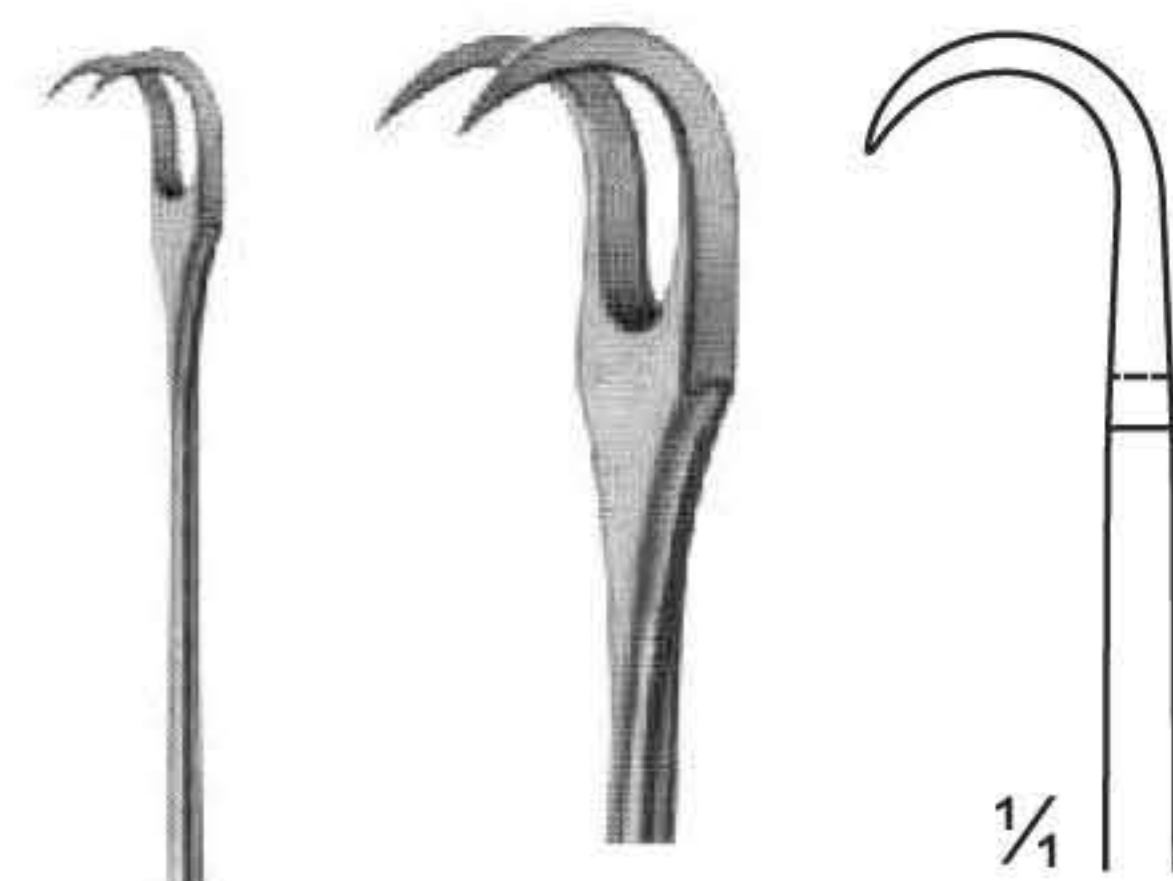

1/2

UG-818  
SIMON  
Fistula hook  
220 mm

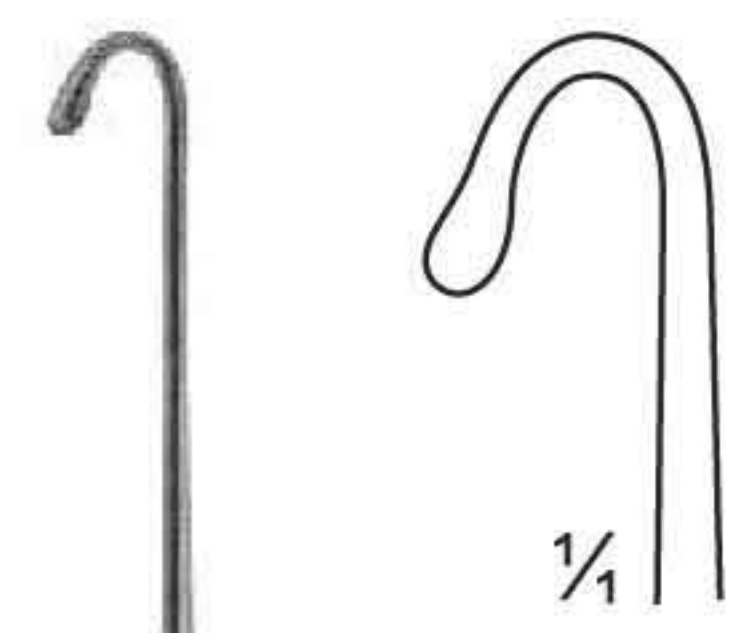

1/2

UG-819  
LANGE  
Fistula hook  
230 mm



1/2

UG-819  
Tendon hooks  
175 mm

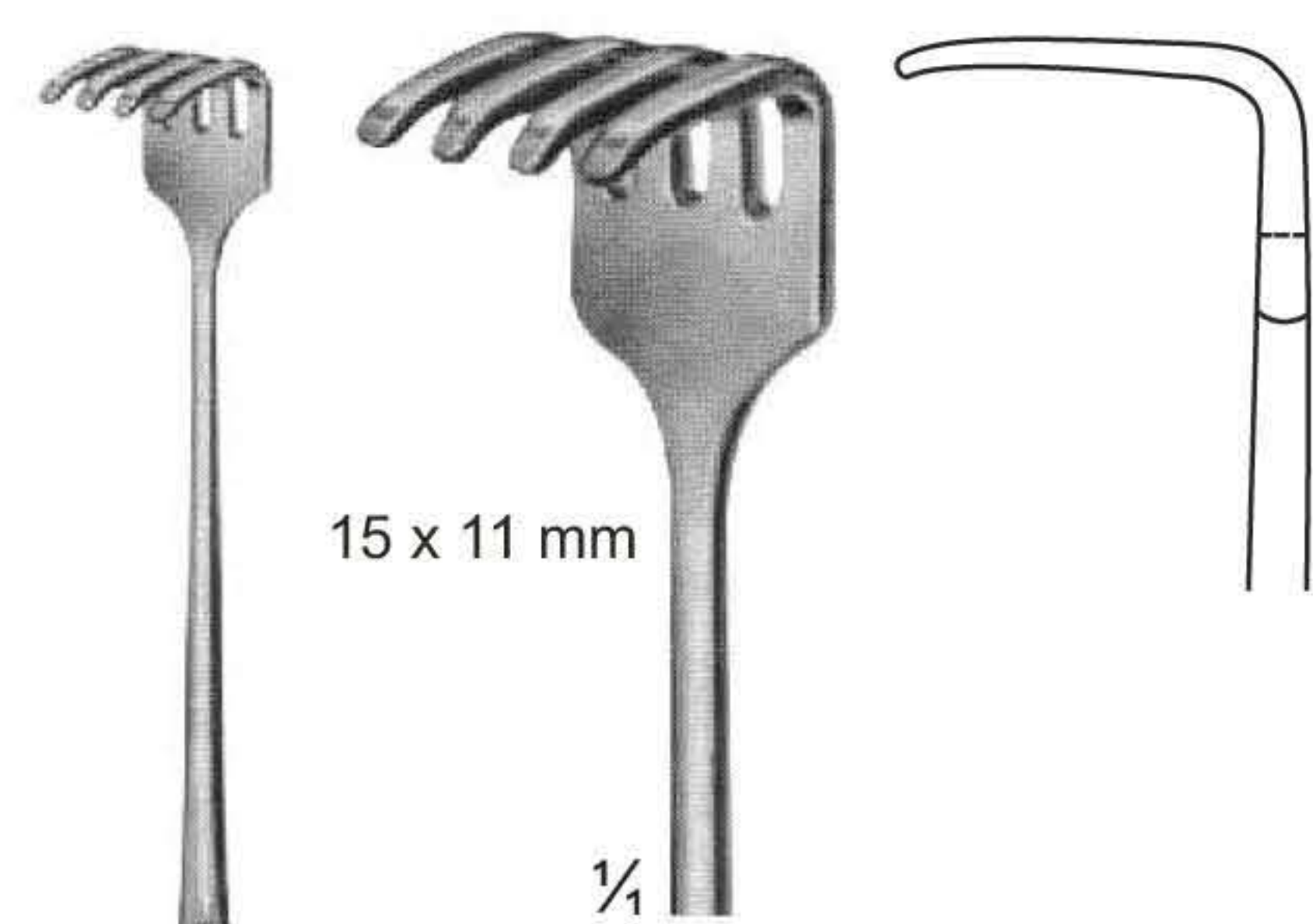

15 x 11 mm

1/4

1/2

UG-821  
KLAPP  
Tendon hooks  
175 mm

# Retractors



1/2

**08-190**  
FOMON  
145 mm

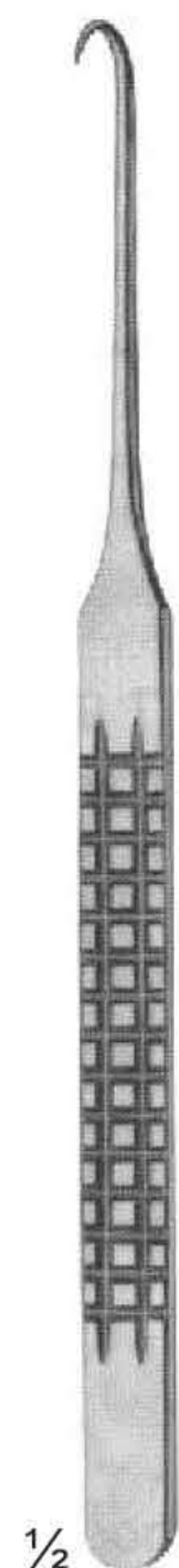

1/2

**UG-805**  
160 mm



1/2

**UG-807**  
LANGENBECK-GREEN  
160 mm

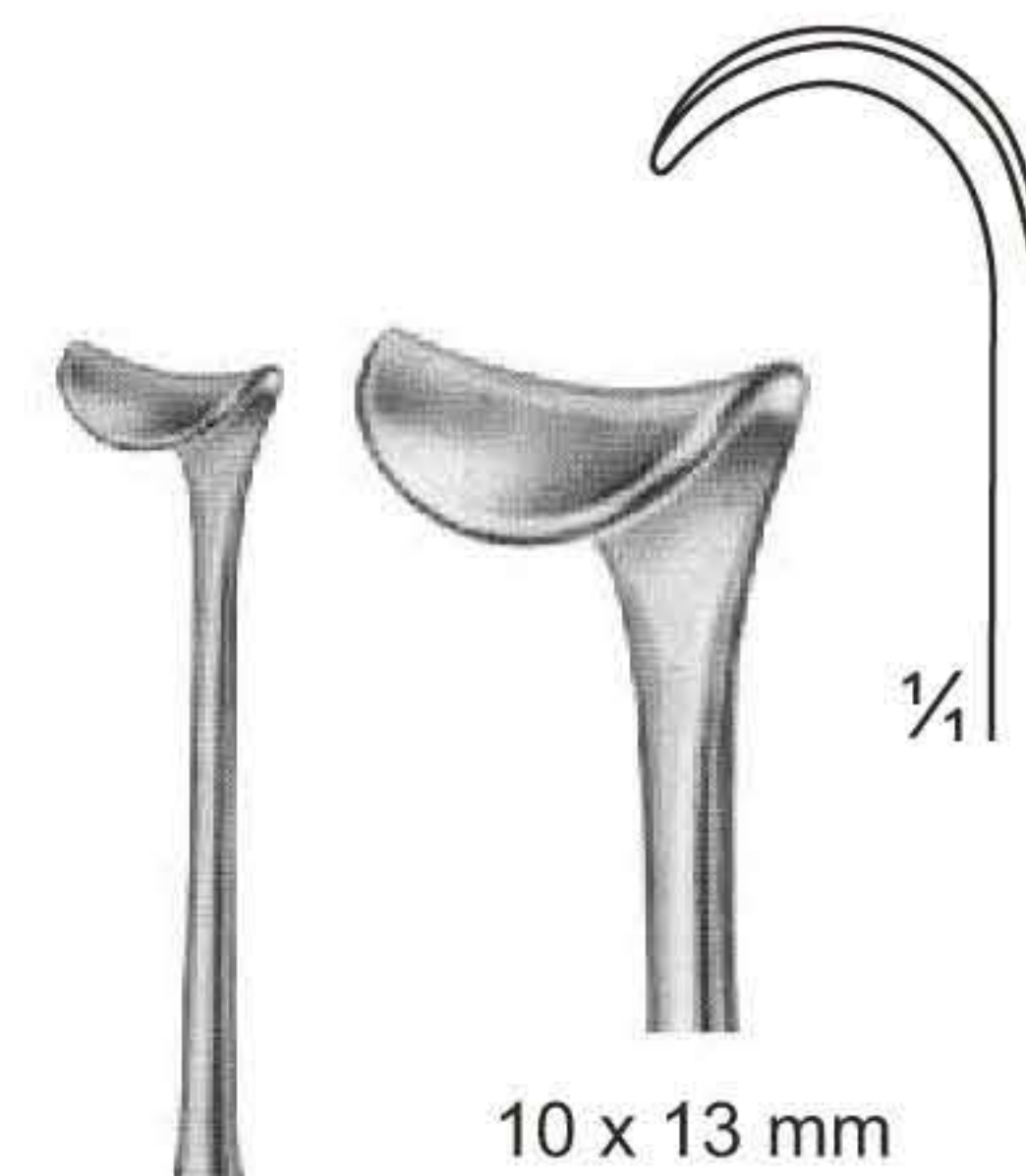

1/2

**UG-809**  
160 mm

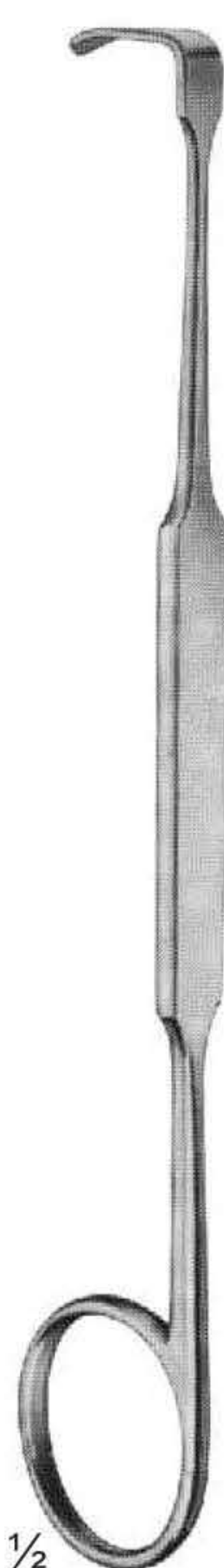

1/2

**UG-811**  
MEYERDING  
Fig. A - Fig. F  
180 mm



1/2

**UG-815**  
WILLIGER  
120 mm

# Retractors

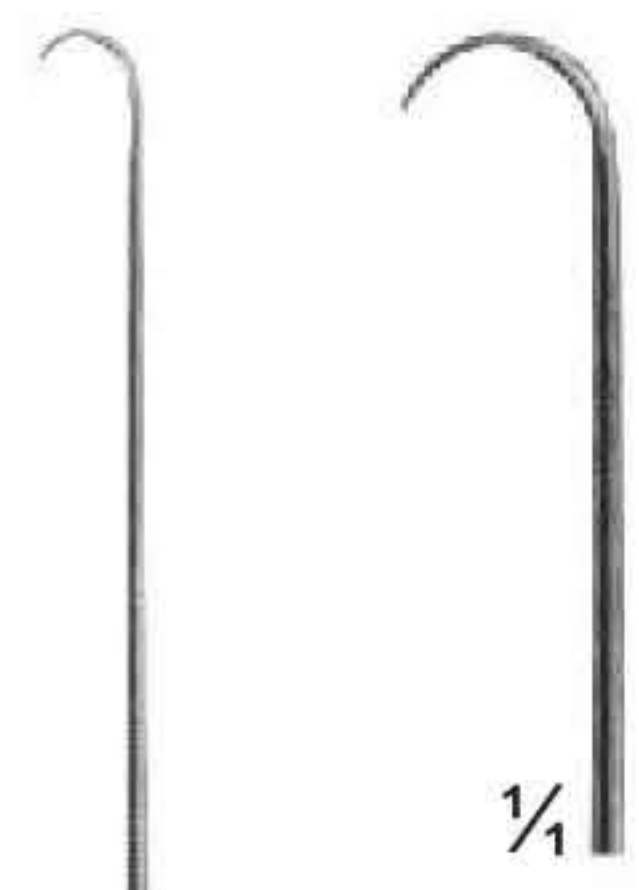

1/2

UG-816  
EMMET  
Fistula hook  
220 mm

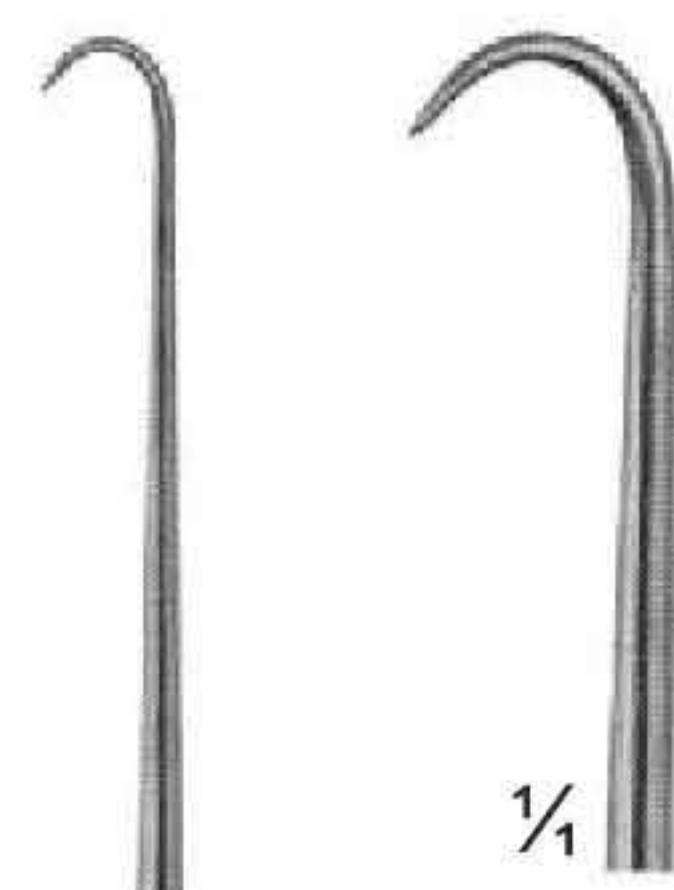

1/2

UG-817  
SIMON  
Fistula hook  
220 mm

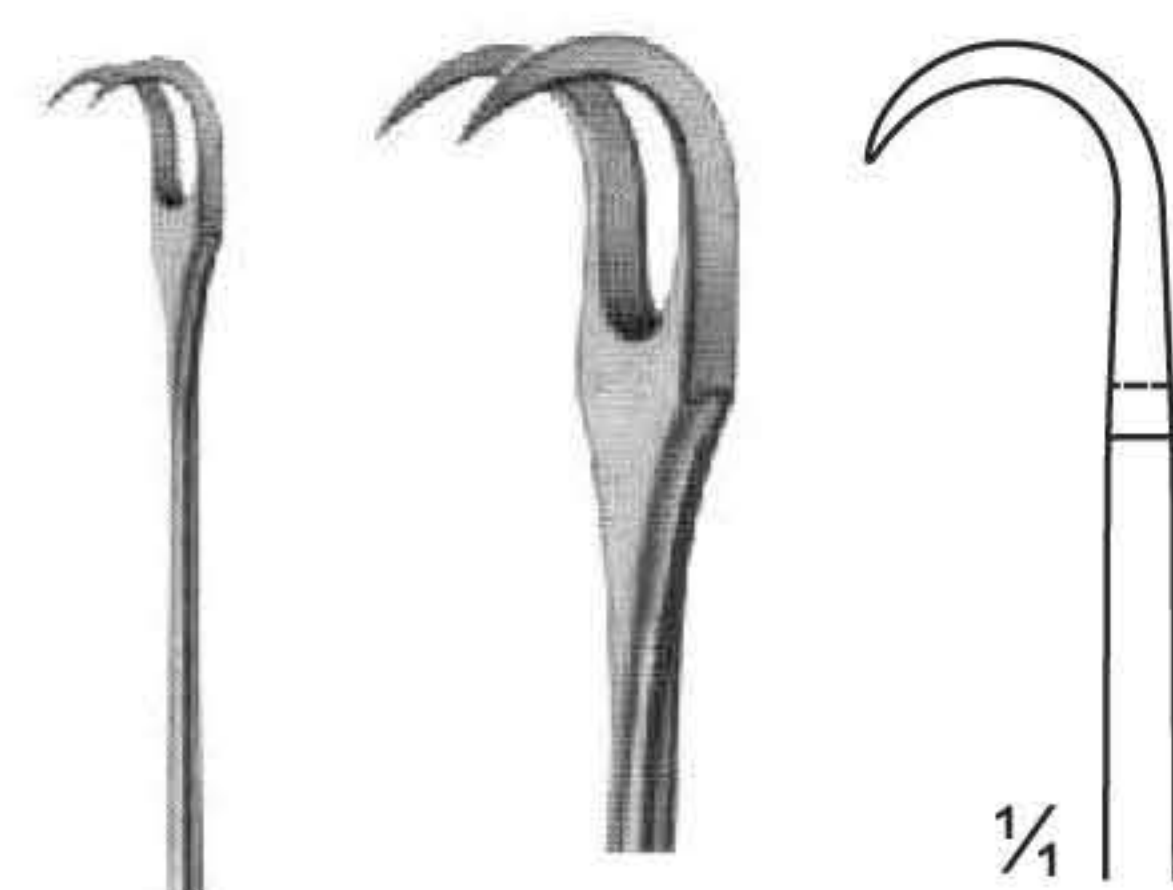

1/2

UG-818  
SIMON  
Fistula hook  
220 mm

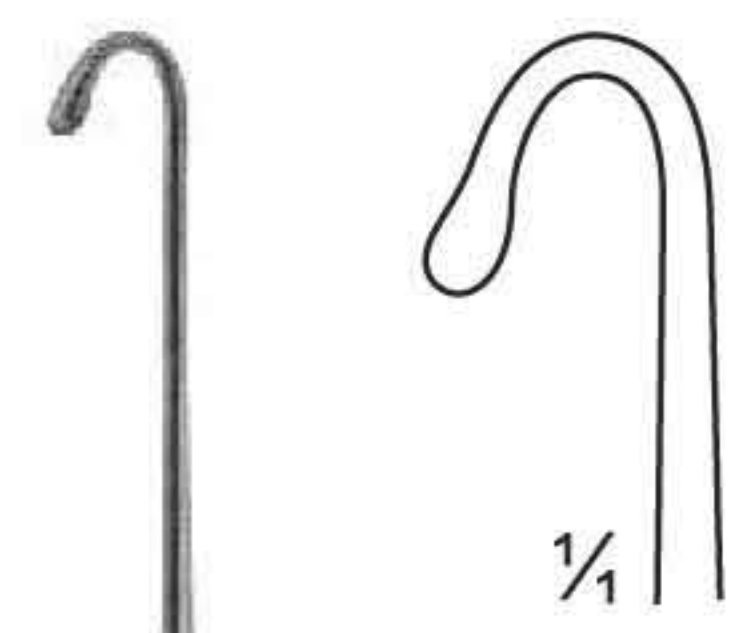

1/2

UG-819  
LANGE  
Fistula hook  
230 mm



1/2

UG-819  
Tendon hooks  
175 mm

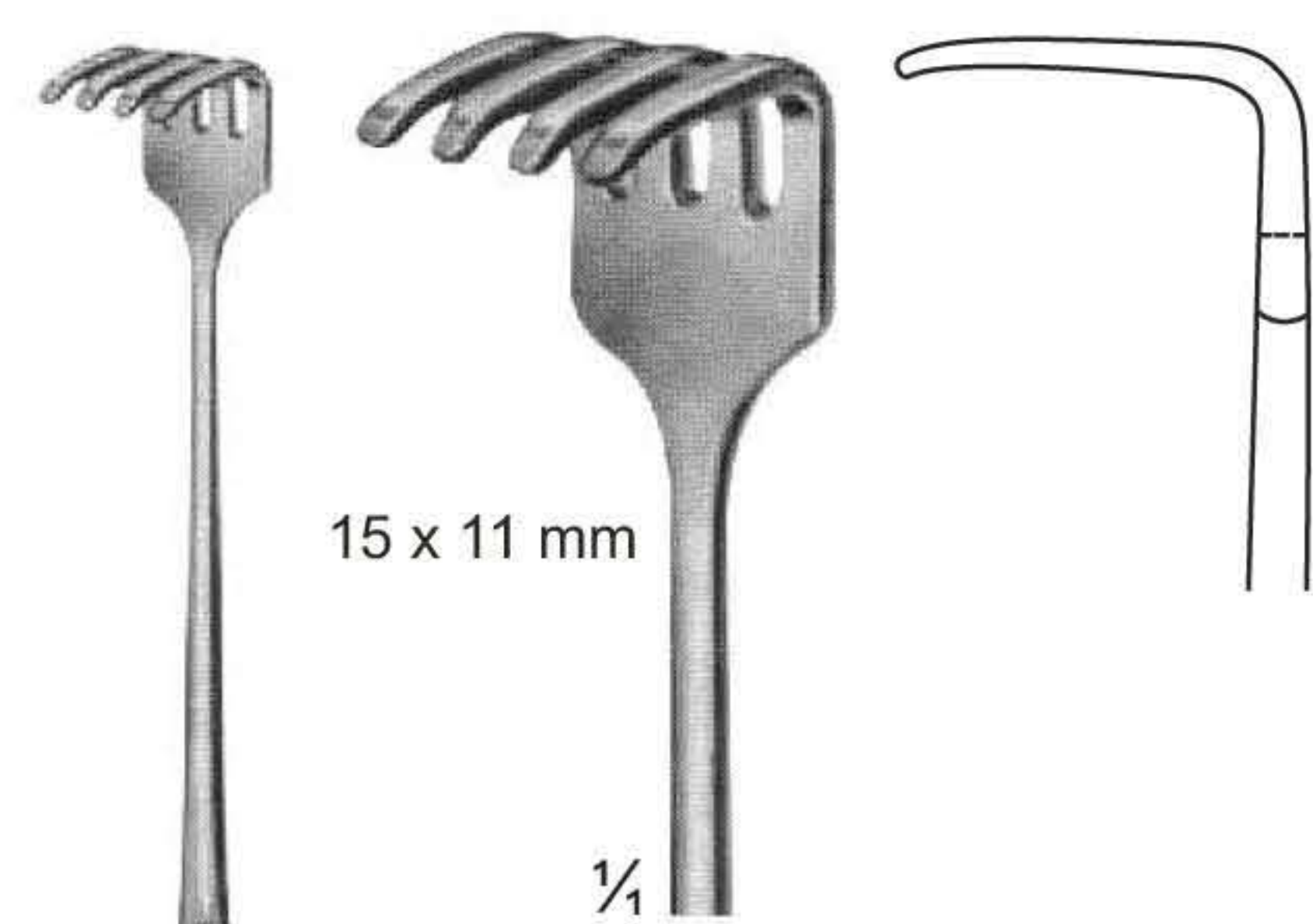

15 x 11 mm

1/4

1/2

UG-821  
KLAPP  
Tendon hooks  
175 mm

# Retractors

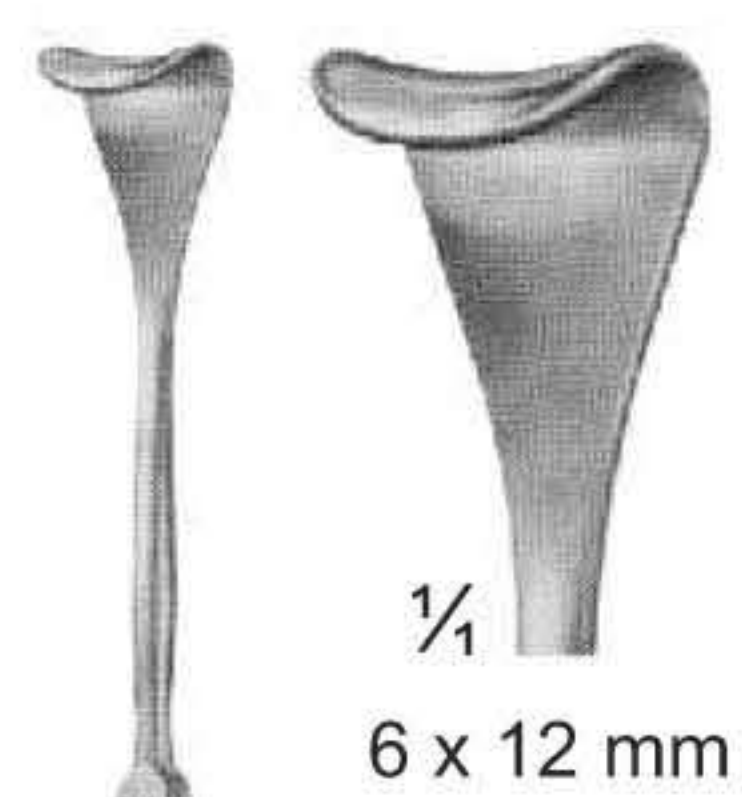

1/2  
UG-822  
MASING  
140 mm

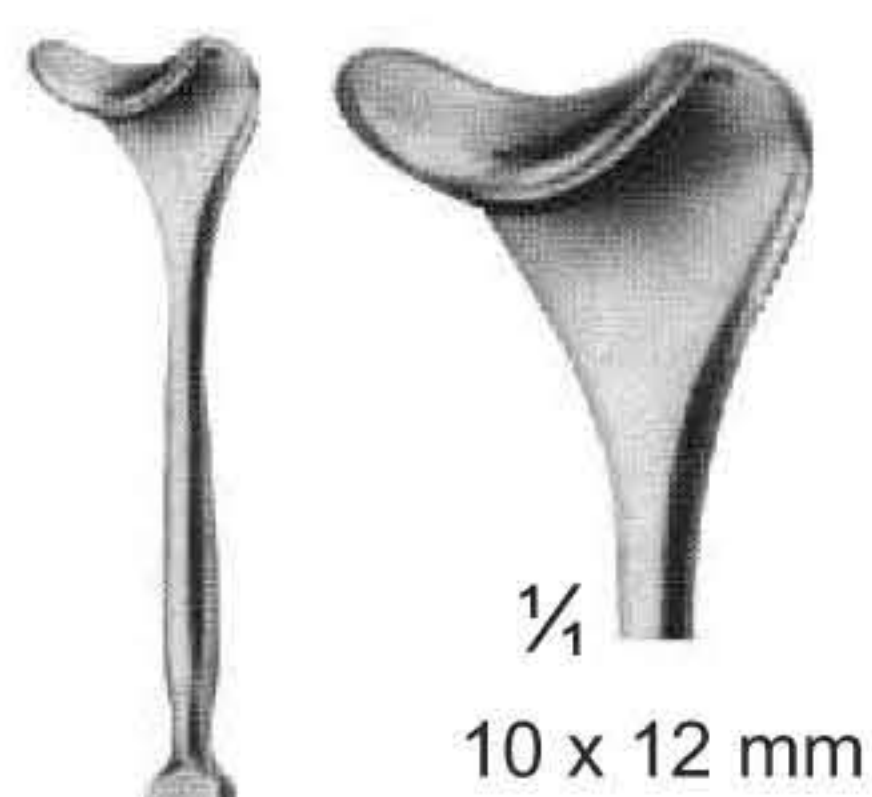

1/2  
UG-823  
COTTLE  
140 mm



1/2  
UG-824  
DESMARRES  
140 mm



1/2  
UG-825  
KONIG  
180 mm

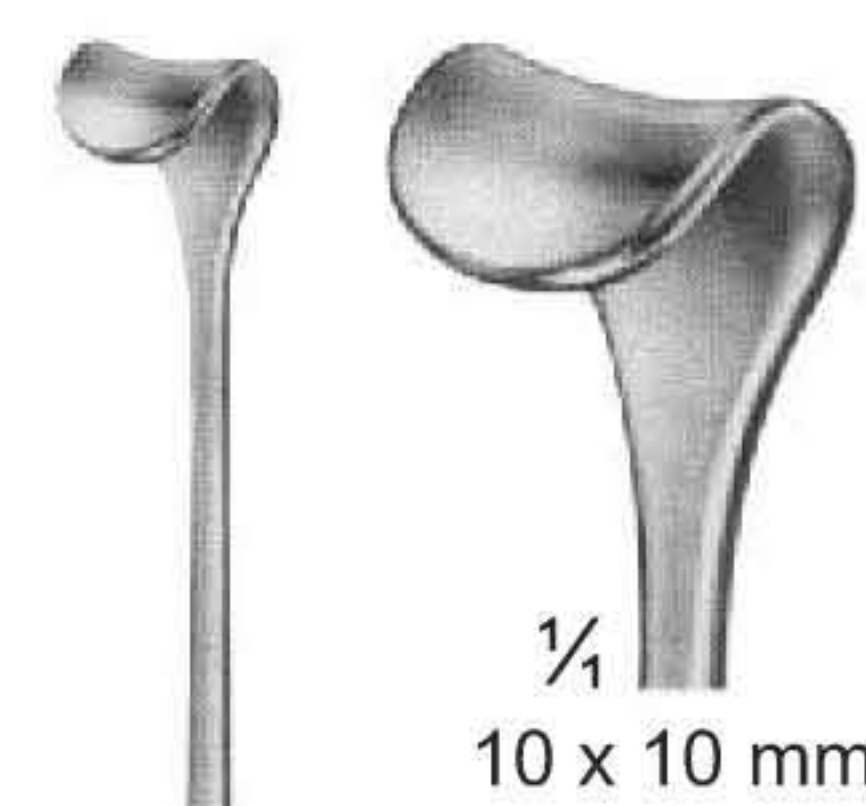

1/2  
UG-826  
CUSHING-KOCHER  
175 mm



1/2  
UG-827  
KOCHER  
205 mm



1/2  
UG-828  
SCHOENBORN  
200 mm



1/2  
UG-829  
CUSHING  
205 mm

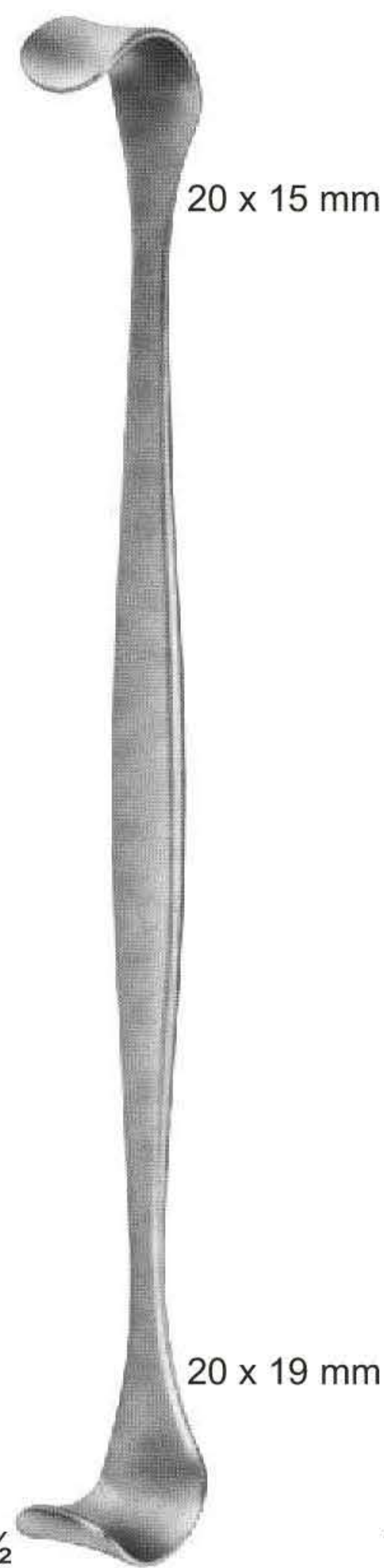

1/2  
UG-830  
205 mm



1/2  
UG-831  
CUSHING  
250 mm

# Retractors

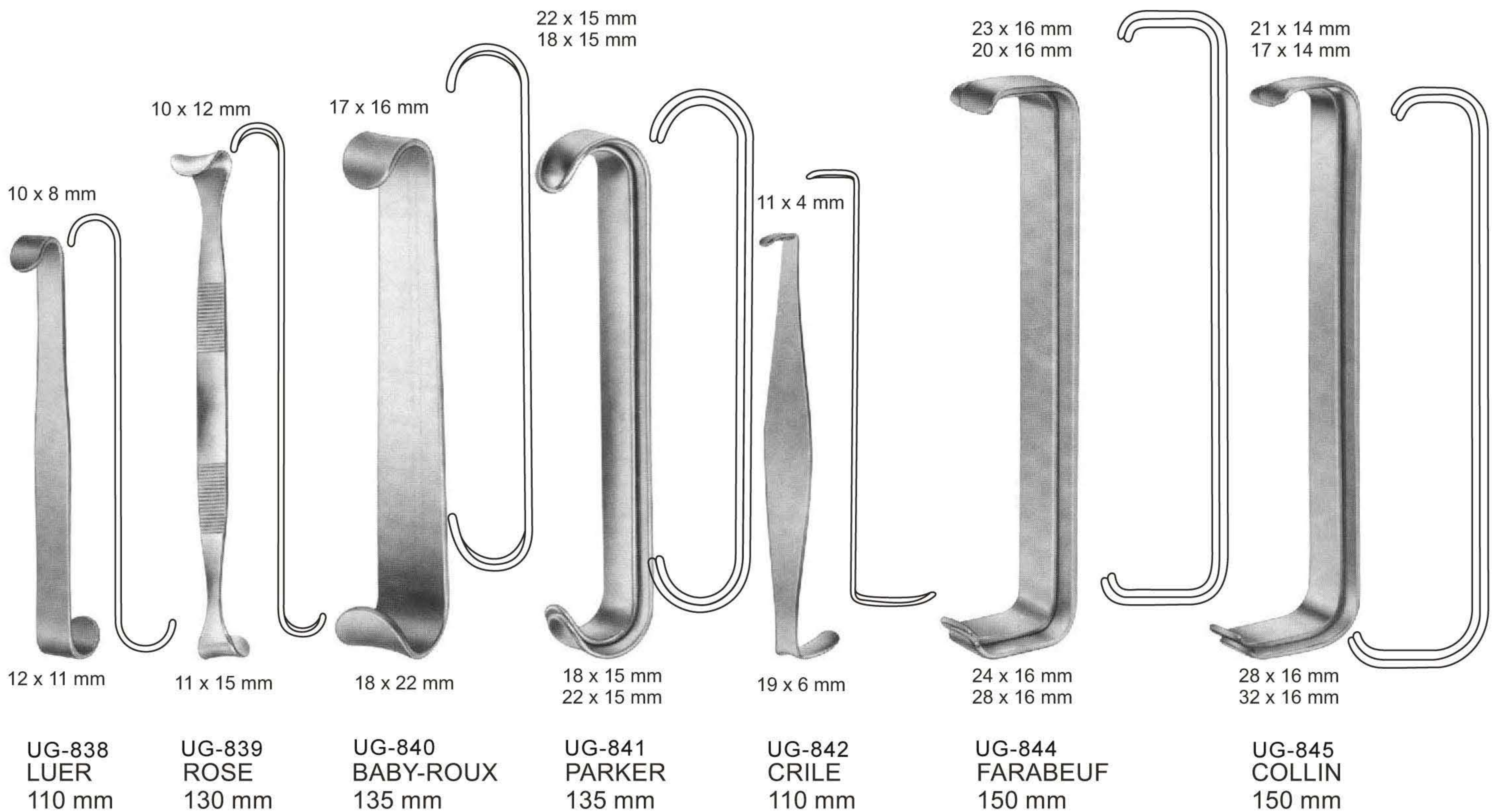

# Retractors



UG-848  
ROUX  
Satz/Set  
165 mm



UG-850  
ROUX  
150 mm

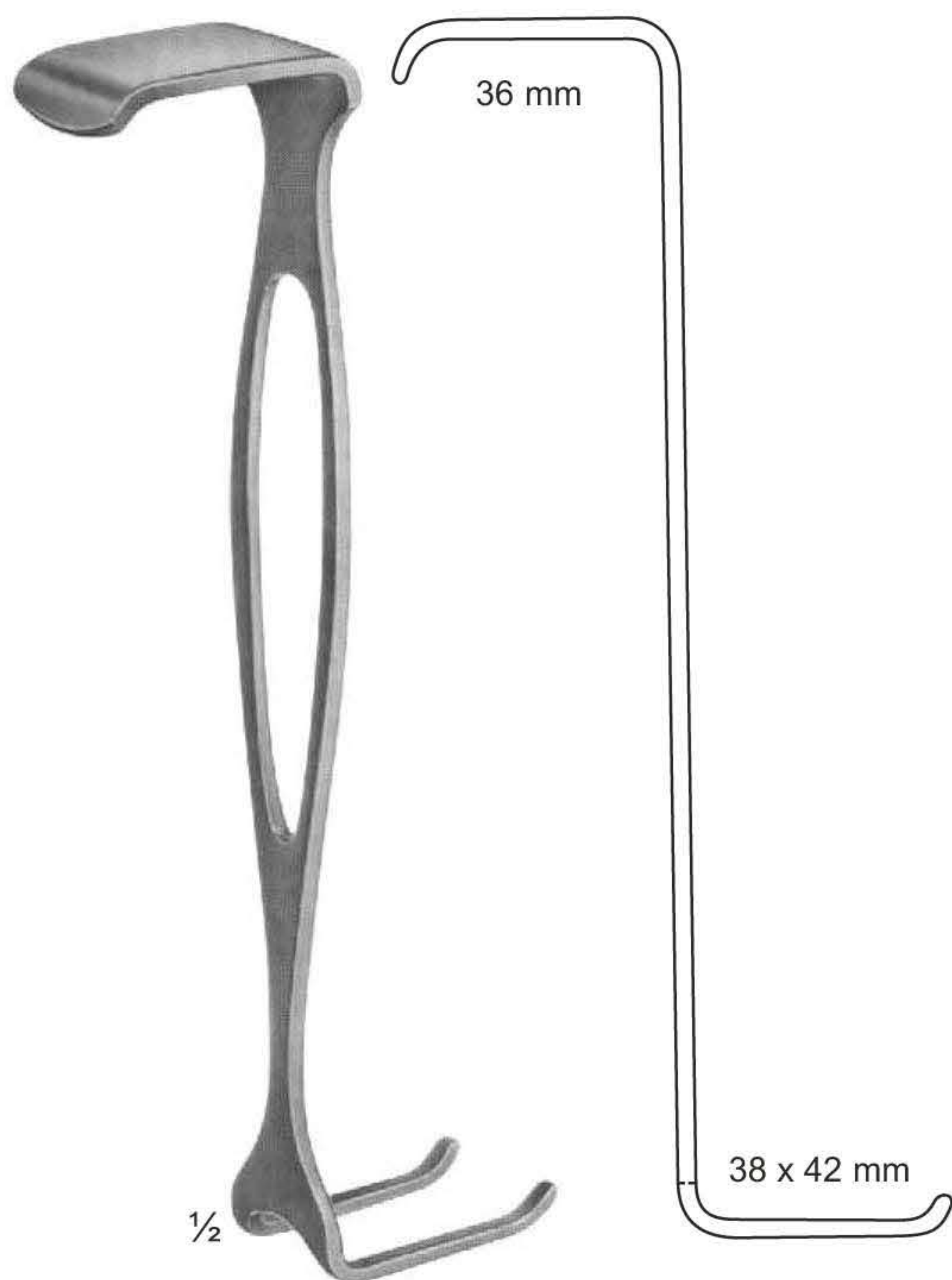

UG-852  
CZERNY  
175 mm

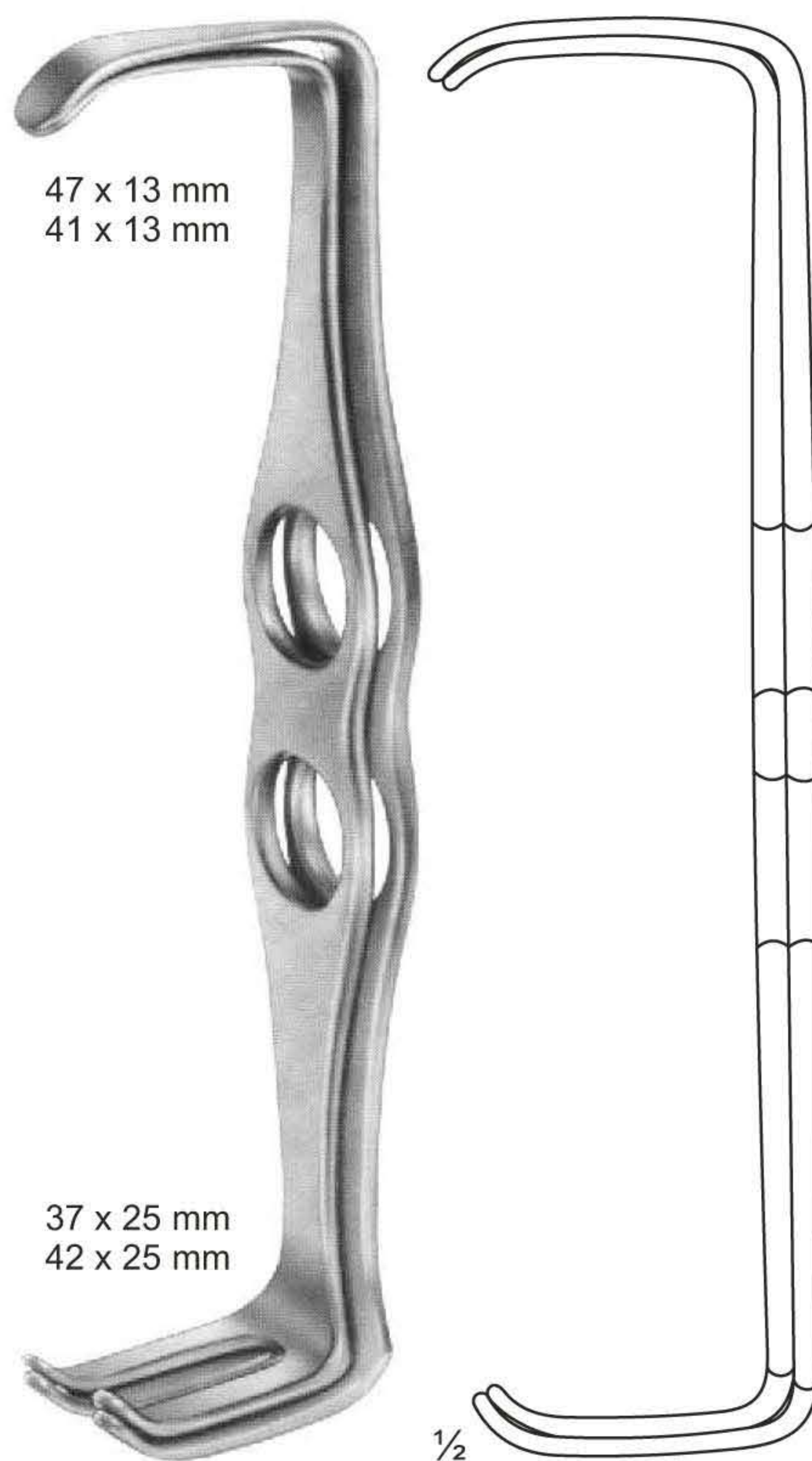

UG-853  
MATHIEU  
200 mm

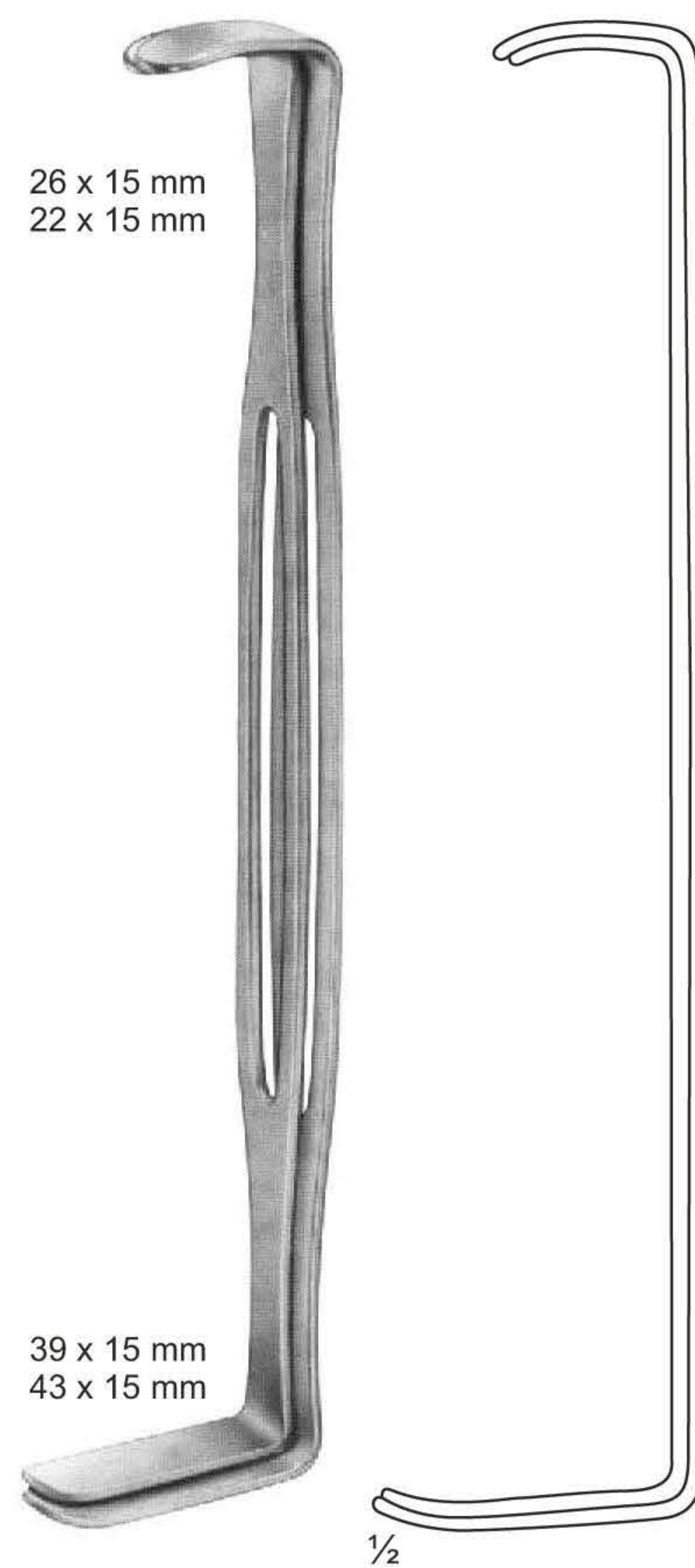

UG-855  
US-ARMY  
220 mm

# Bone Retractors and Retractors



UG-856  
KOCHER  
Sharp  
205 mm



UG-857  
KOCHER  
Sharp  
220 mm

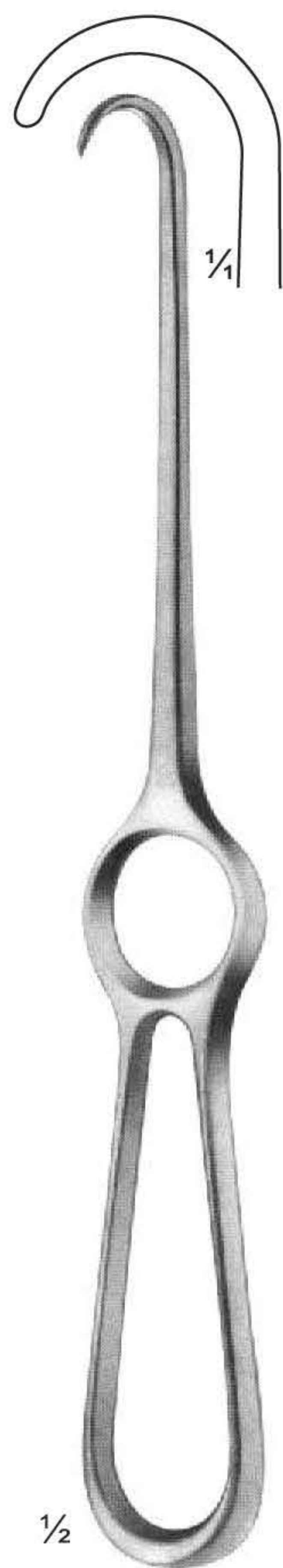

UG-859  
KOCHER  
Blunt  
220 mm



UG-860  
VOLKMANN  
Sharp  
220 mm

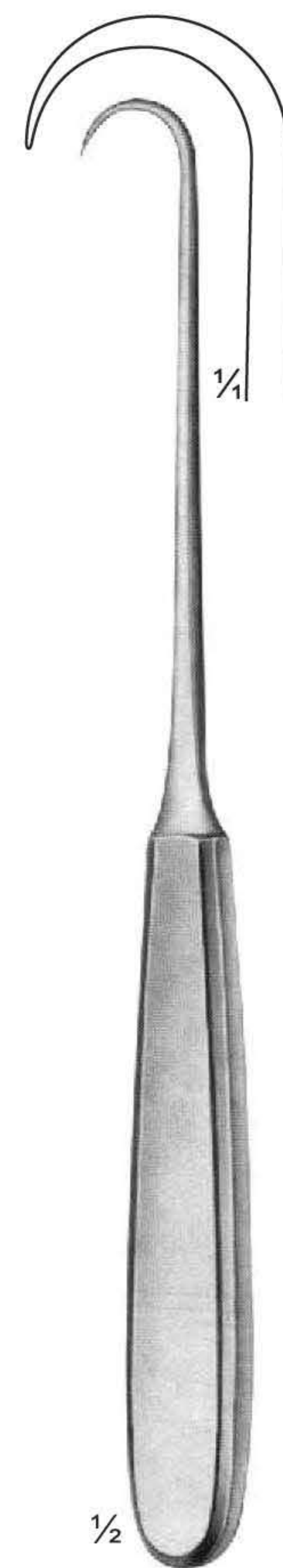

UG-861  
VOLKMANN  
Sharp  
220 mm

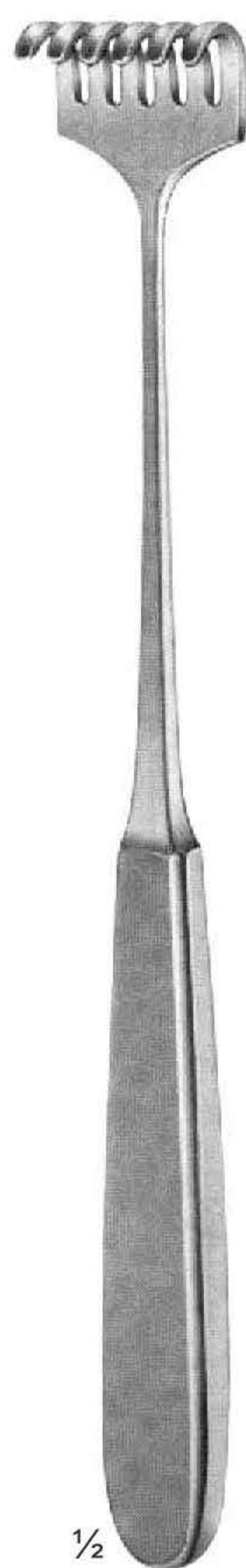

UG-862  
VOLKMANN  
225 mm

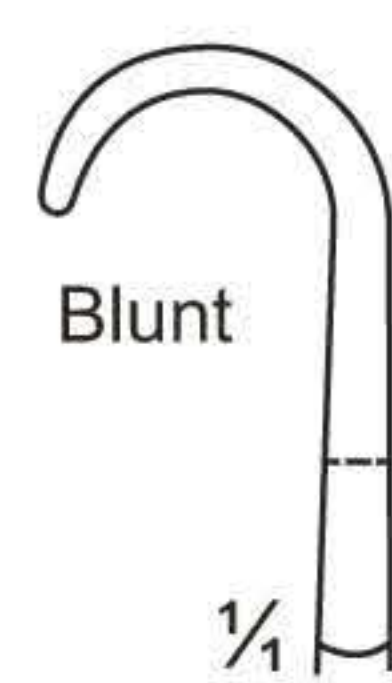
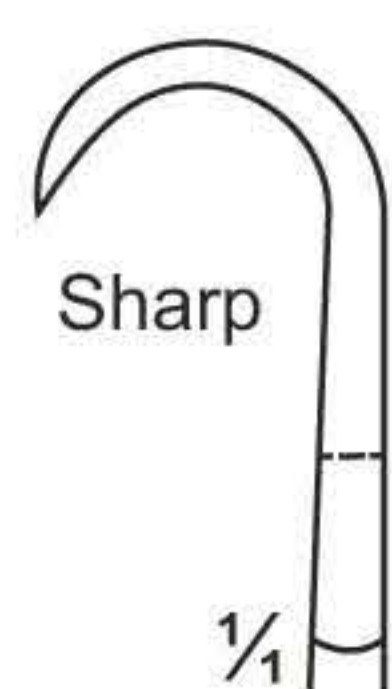



# Retractors



1/2

UG-865  
VOLKMANN  
220 mm



1/2

UG-868  
KOCHER  
220 mm

## Retractors, Deep form

---

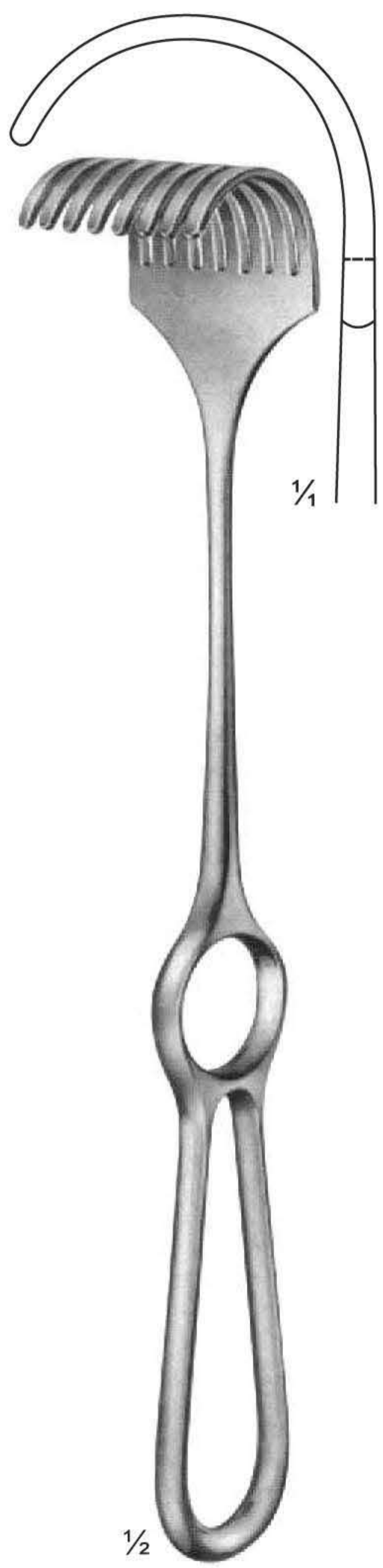

UG-870  
KORTE  
240 mm



UG-871  
ISRAEL  
255 mm

# Retractors



UG-872  
LANGENBECK  
210 mm



UG-873  
KOCHER-LANGENBECK  
215 mm

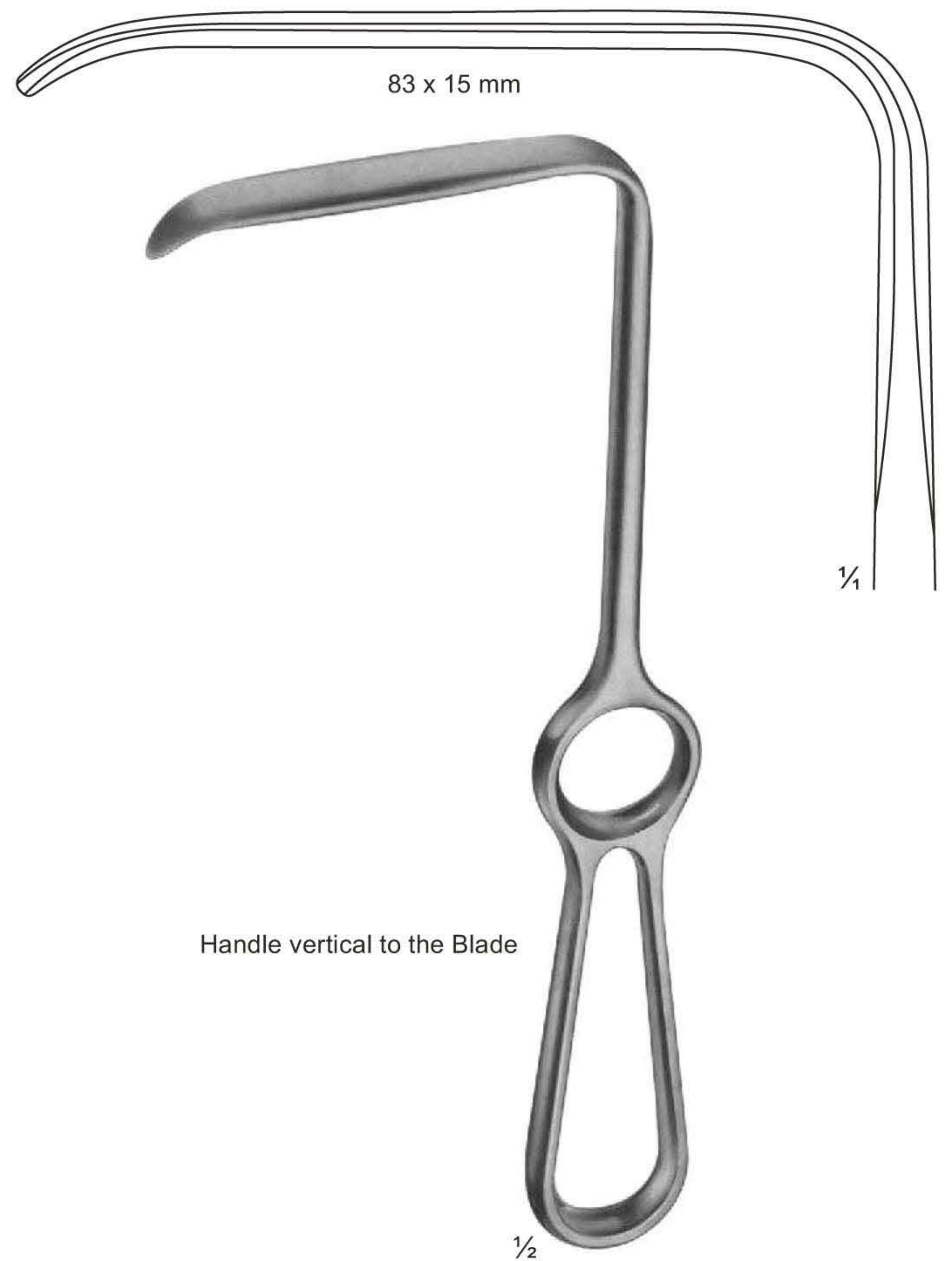

UG-874  
LANGENBECK  
215 mm

# Autopsy & Cartilage Knives

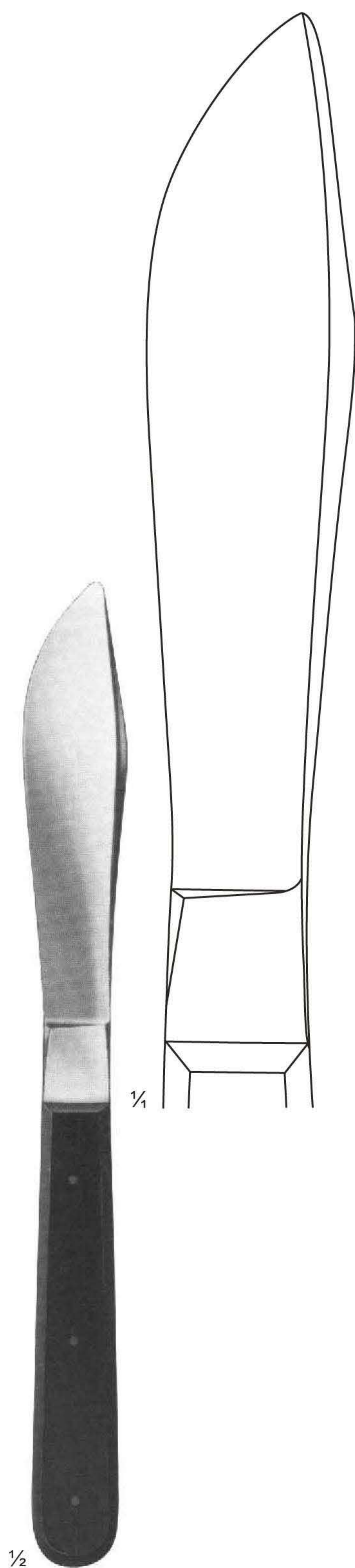

**UG-125**  
Autopsy & Cartilage Knives  
SIZE:200mm

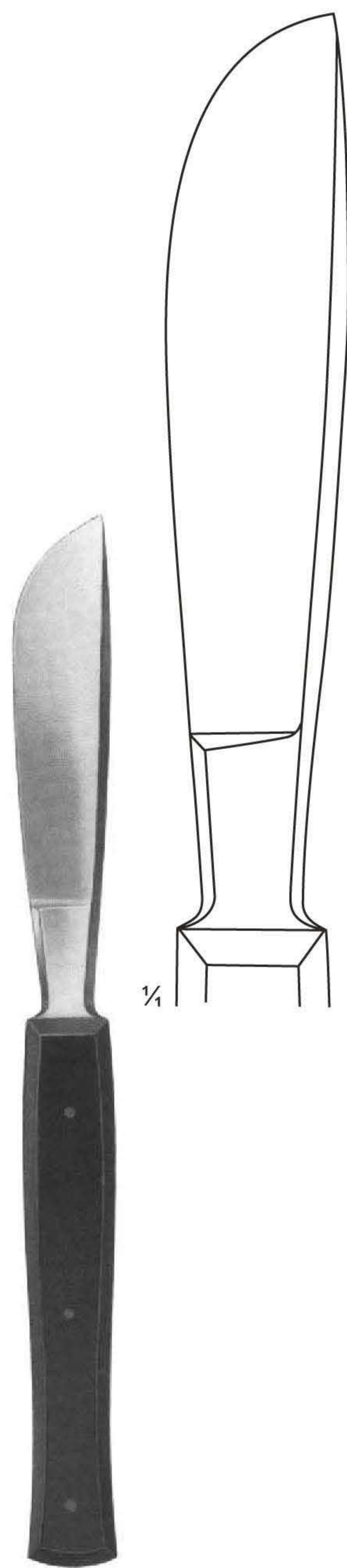

**UG-126**  
VIRCHOW  
SIZE:320mm



**UG-128**  
WALB  
SIZE:120mm

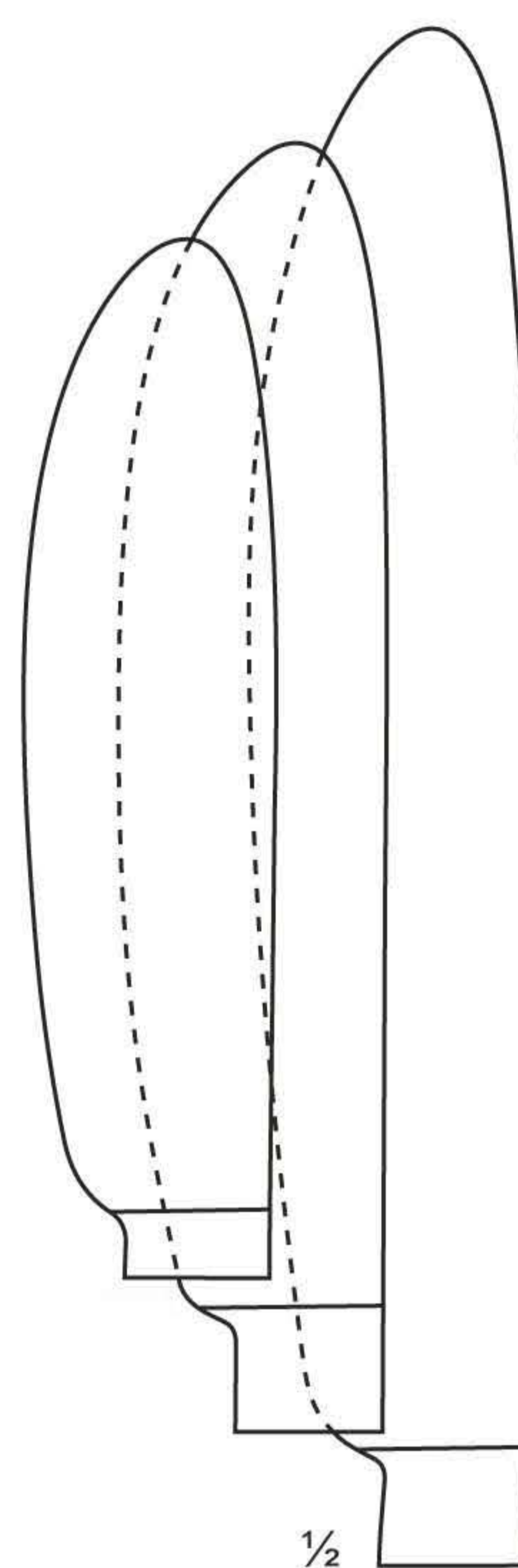

**UG-133**  
VIRCHOW  
SIZE:120mm

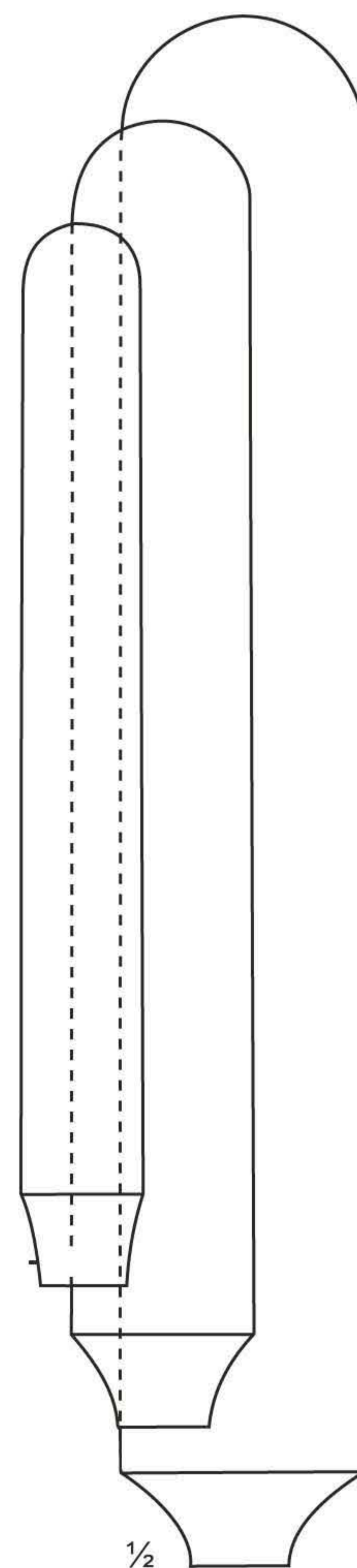

# Retractors

---



UG-875  
KOCHER  
230 mm

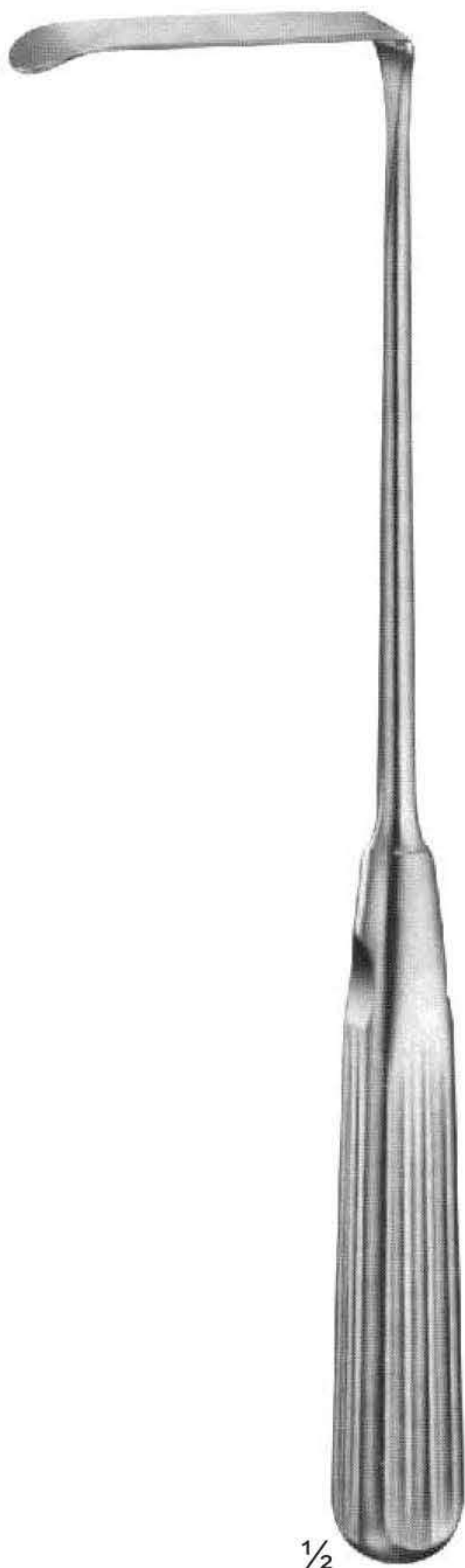

UG-876  
SAUERBRUCH  
225 mm

# Retractors



1/2

UG-877  
MIDDELDORPF



1/2

UG-878  
BUCHS  
205 mm

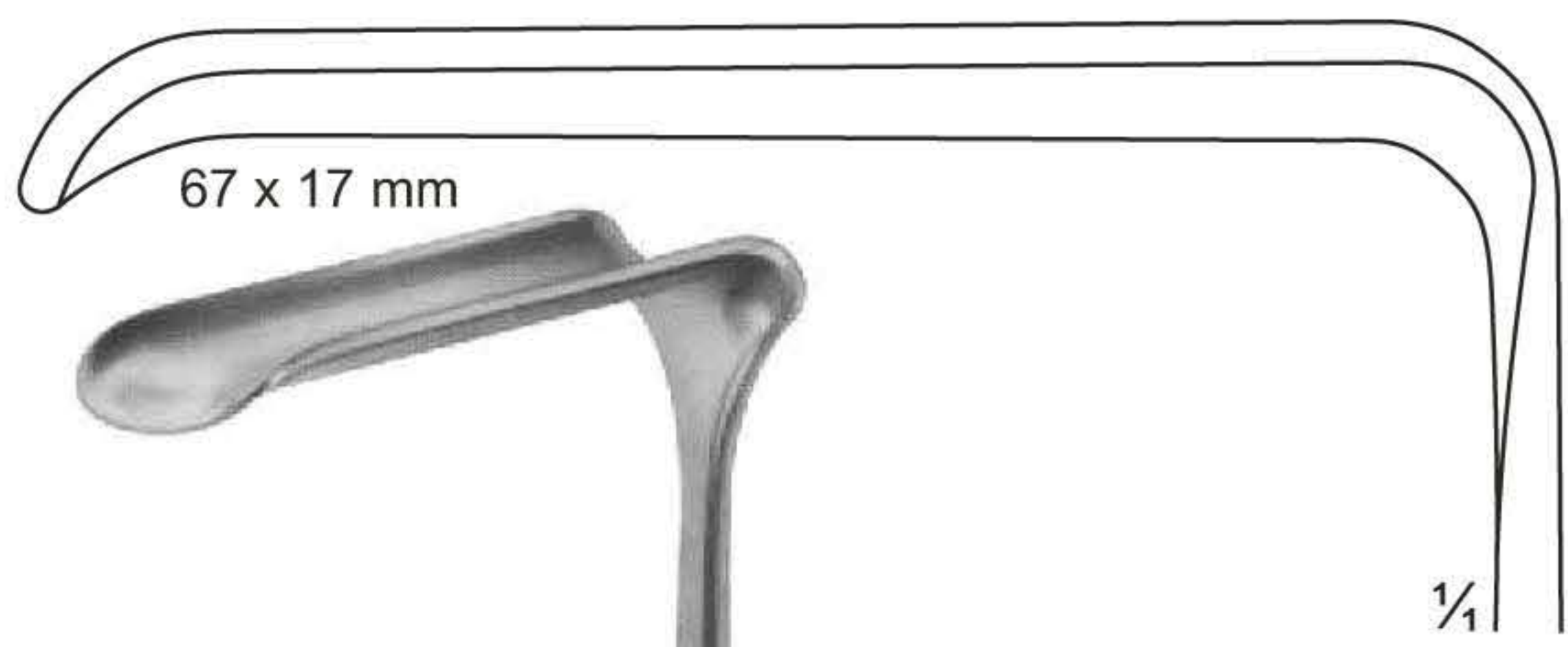

67 x 17 mm

1/4

1/2

UG-879  
CASPAR  
210 mm

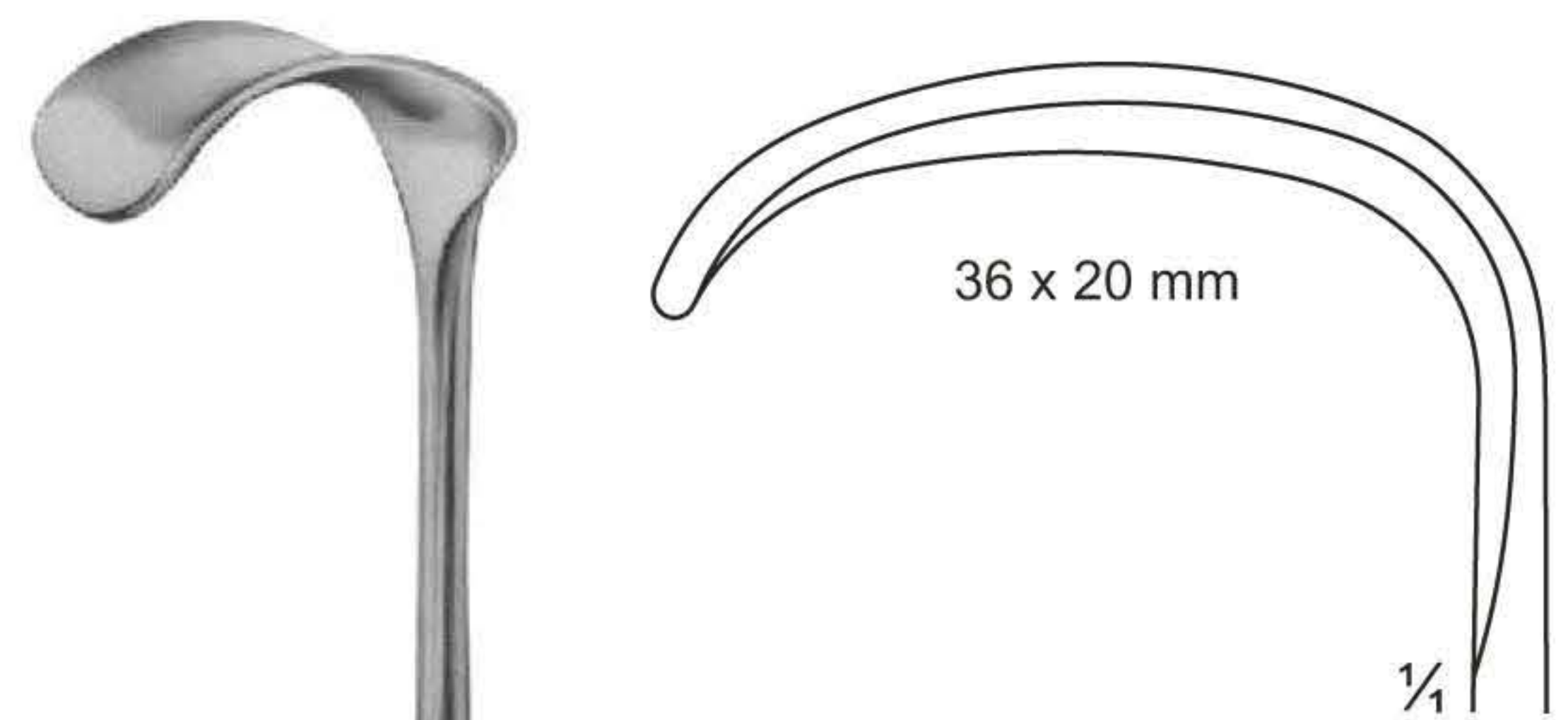

36 x 20 mm

1/4

1/2

UG-880  
KOCHER  
230 mm

# Retractors

---



1/2

UG-881  
HOSEL  
250 mm

# Retractors

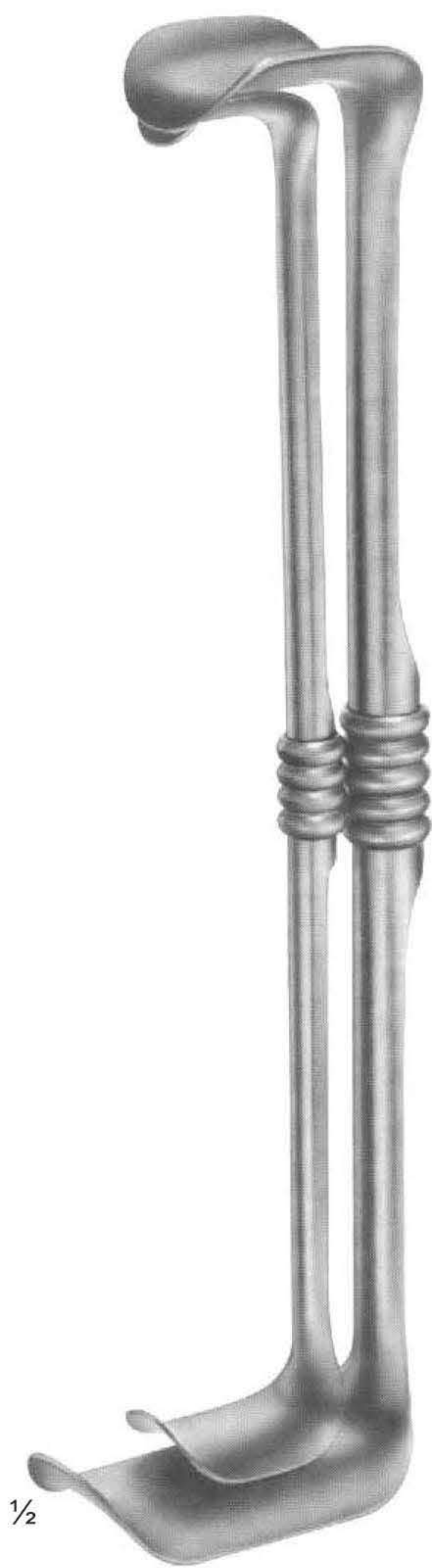

UG-882  
RICHARDSON-EASTMAN  
Set-250 mm

08-329 250 mm  
08-330 270 mm

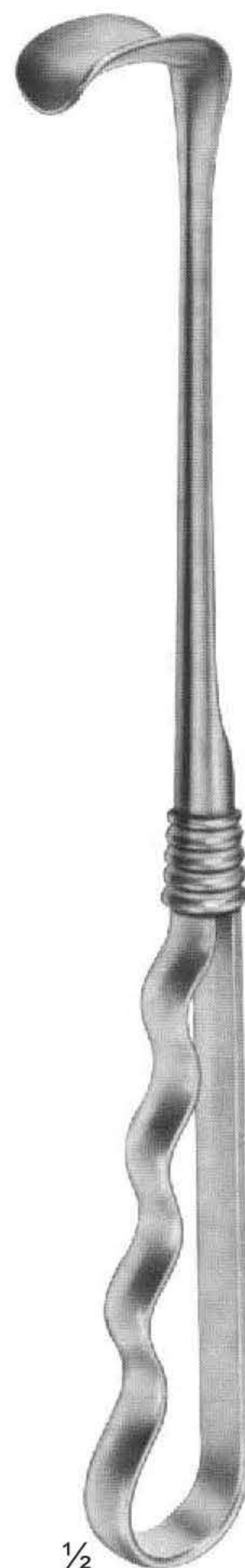

UG-883  
RICHARDSON  
240 mm



UG-884  
RICHARDSON  
240 mm



# Retractors

---



UG-885  
KELLY  
260 mm



UG-886  
MORRIS  
245 mm

# Retractors For Deep Surgery

---

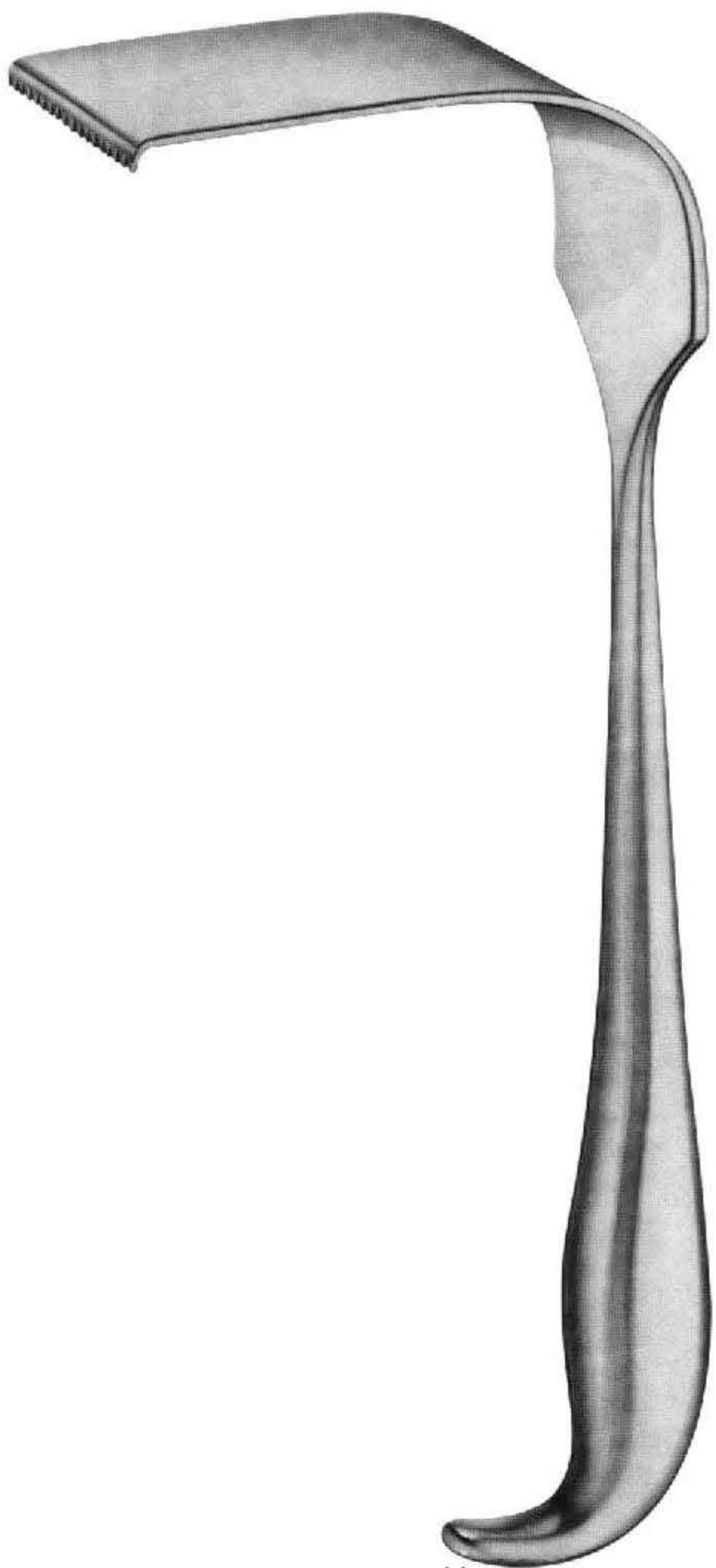

$\frac{1}{2}$   
UG-893  
MEYERDING  
260 mm

# Retractors For Deep Surgery

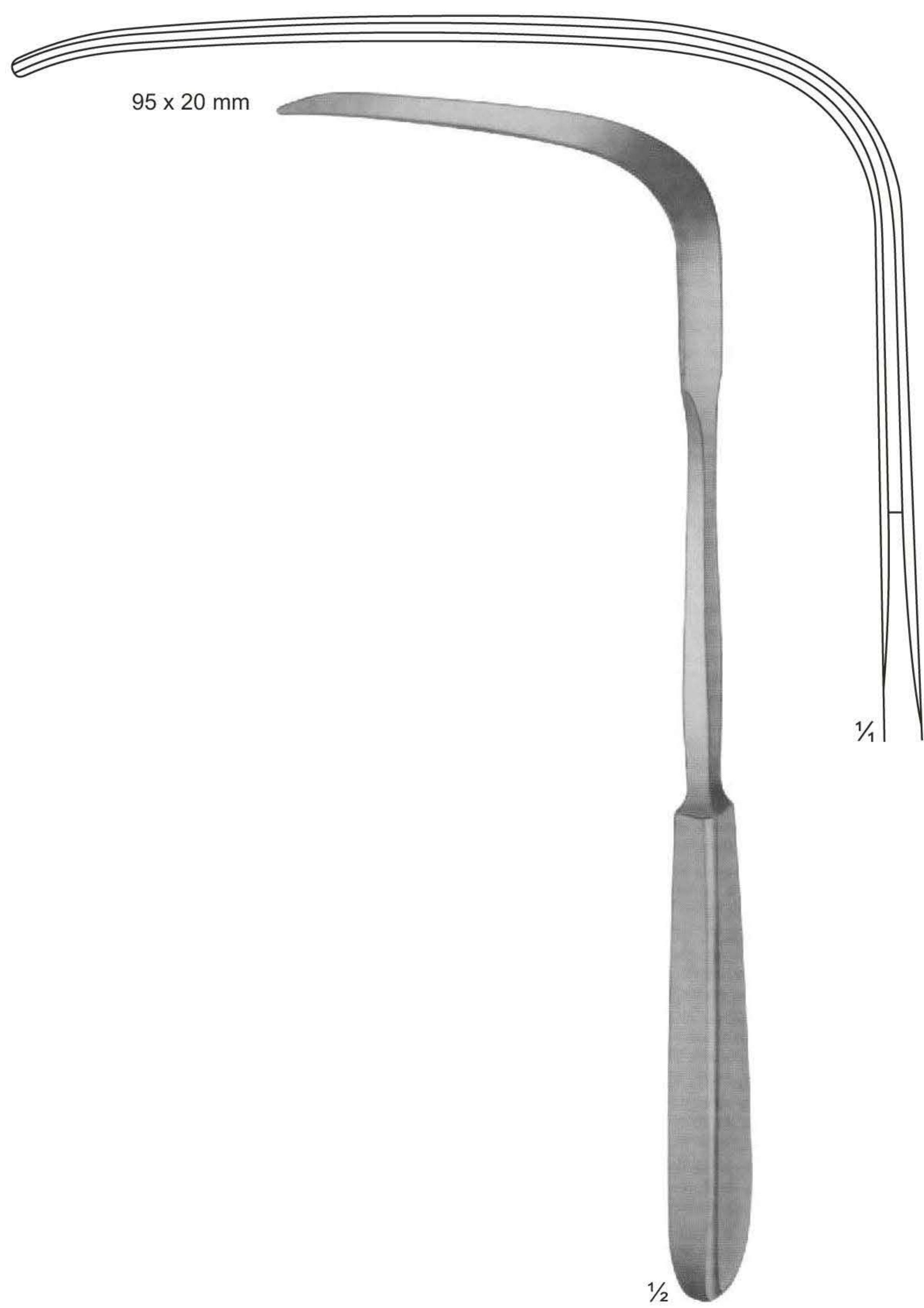

UG-895  
MODELL TUBINGEN  
265 mm

Vario Retractor System, Germ. Fed. Patent,  
Germ. Fed. Regd.Des.



UG-900  
BRUNNER  
275 mm

1/2



UG-902  
Handle with cold  
light carrier for  
retractor blades.  
280 mm

1/2



Handle arrange-  
ment verriable

# Retractors, Lung Spatulas



UG-904  
HARRINGTON  
08-355 123 x 45 mm  
08-356 123 x 64 mm  
Flexible  
295 mm



UG-906  
ALLISON  
255 mm



UG-907  
ALLISON  
320 mm

# Retractors, Lung Spatulas



# Scalpels, Tenotomes & Resection Knives



1/4

**UG-139**  
**GRAEFE**  
**SIZE:155mm**



1/4

**UG-143**  
**DIEFFENBACH**  
**SIZE:155mm**



1/2

**UG-145**  
**Scalpels,**  
**Tenotomes &**

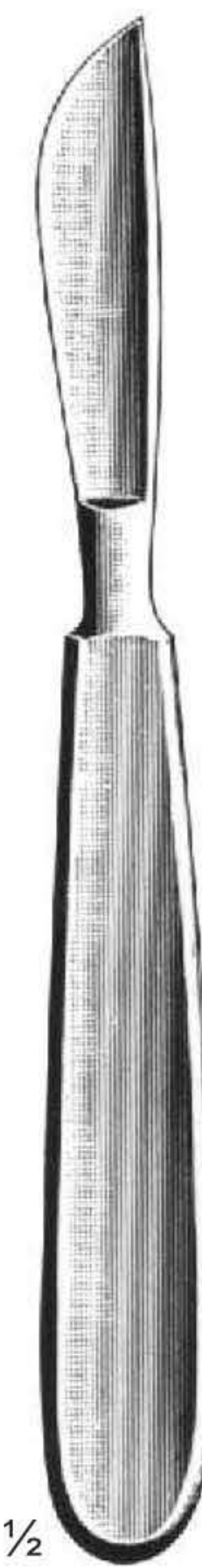

1/2

**UG-148**  
**Scalpels,**  
**Tenotomes &**

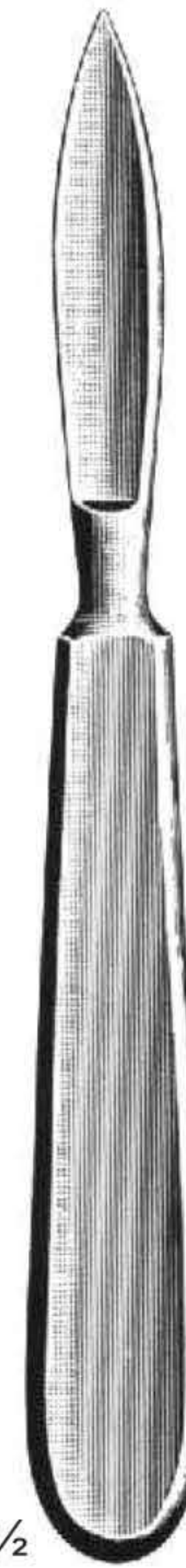

1/2

**UG-149**  
**Scalpels,**  
**Tenotomes &**  
**SIZE:130mm**

# Retractors, Lung Spatulas



UG-916  
DEAVER  
300 mm  
Fig. 1

UG-917  
DEAVER  
315 mm  
Fig. 2

UG-918  
DEAVER  
365 mm  
Fig. 2



# Retractors, Lung Spatulas



UG-921  
DEAVER  
300 mm  
Fig. 3

UG-922  
DEAVER  
310 mm  
Fig. 4

UG-923  
DEAVER  
320 mm  
Fig. 5

# Retractors, Lung Spatulas

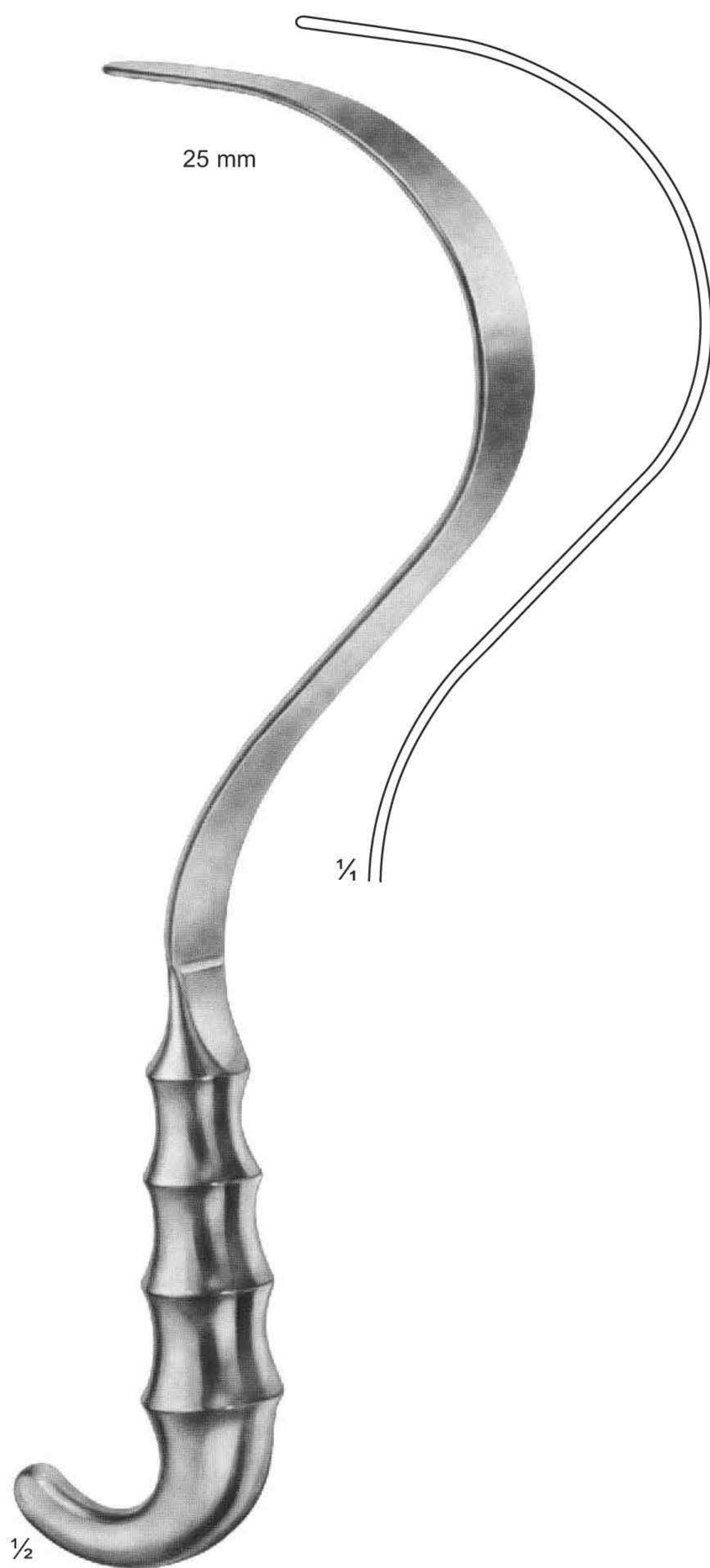

UG-924  
DEAVER  
310 mm  
Fig. 1



UG-926  
DEAVER  
310 mm  
Fig. 3

# Retractors, Lung Spatulas

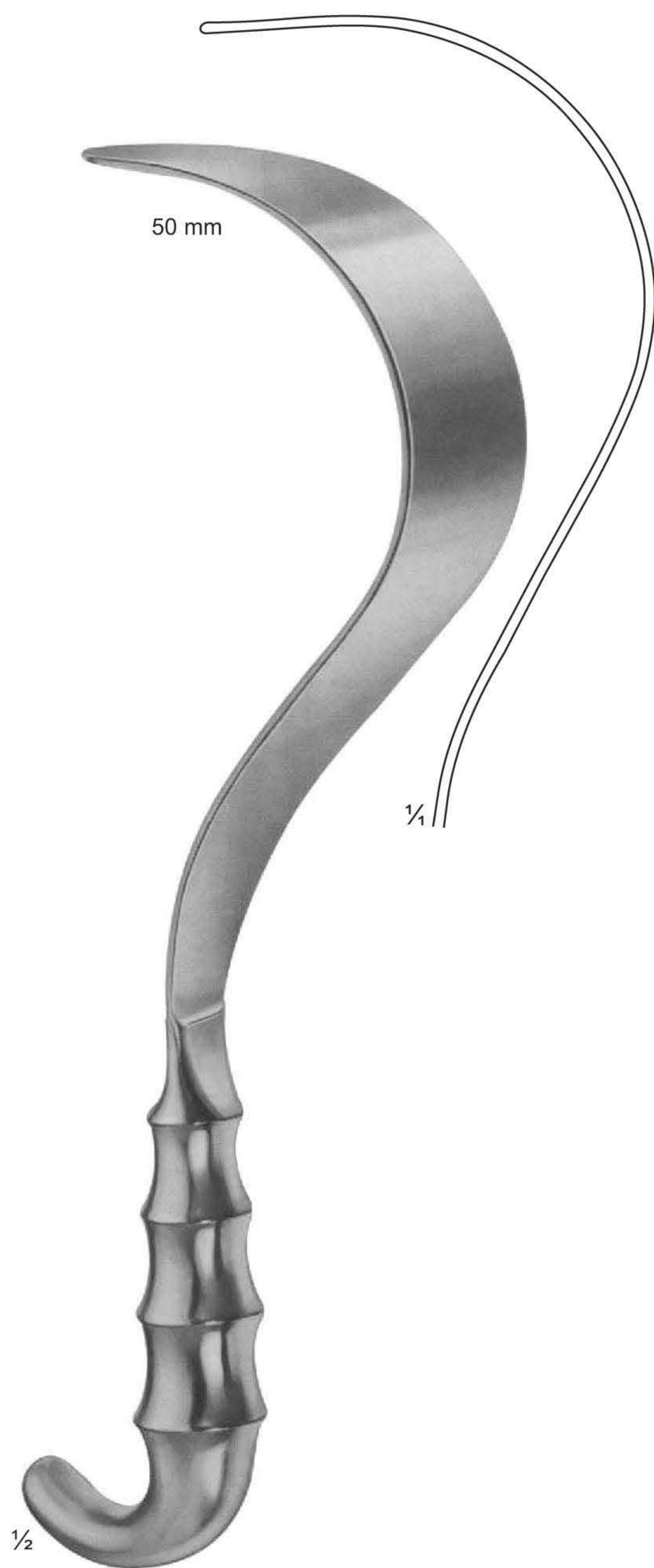

UG-927  
DEAVER  
305 mm  
Fig. 3

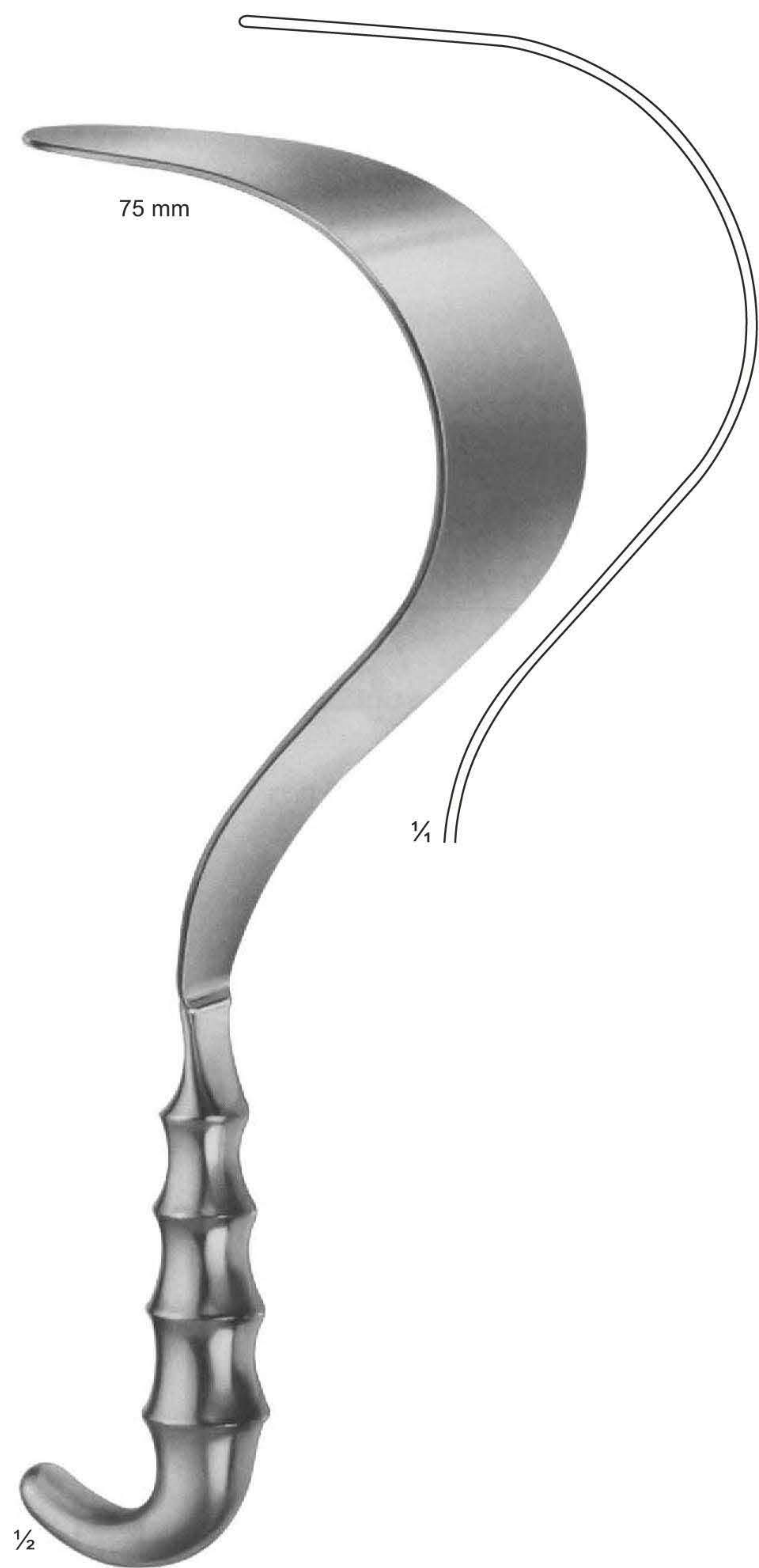

UG-928  
DEAVER  
310 mm  
Fig. 4

# Retractors For Deep Surgery (Abdominal Retractors)

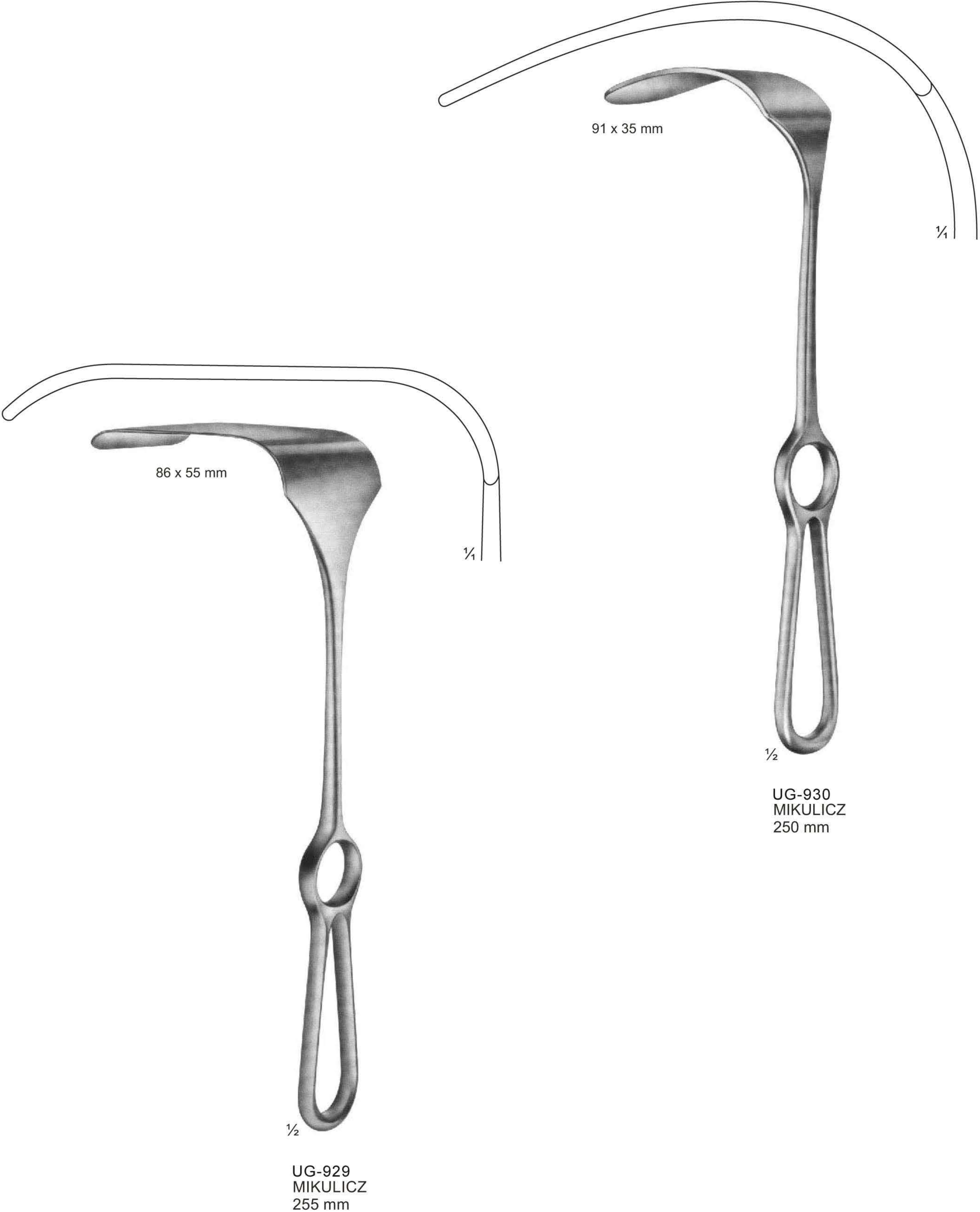

# Retractors For Deep Surgery (Abdominal Retractors)



UG-931  
**08-376** 121 x 50 mm  
**08-377** 147 x 50 mm  
 Liver Retractor  
 250 mm

1/2

1/2  
 UG-932  
 KELLY  
**08-378** 150 x 39 mm  
**08-379** 150 x 57 mm  
 260 mm

# Retractors, Abdominal Retractors

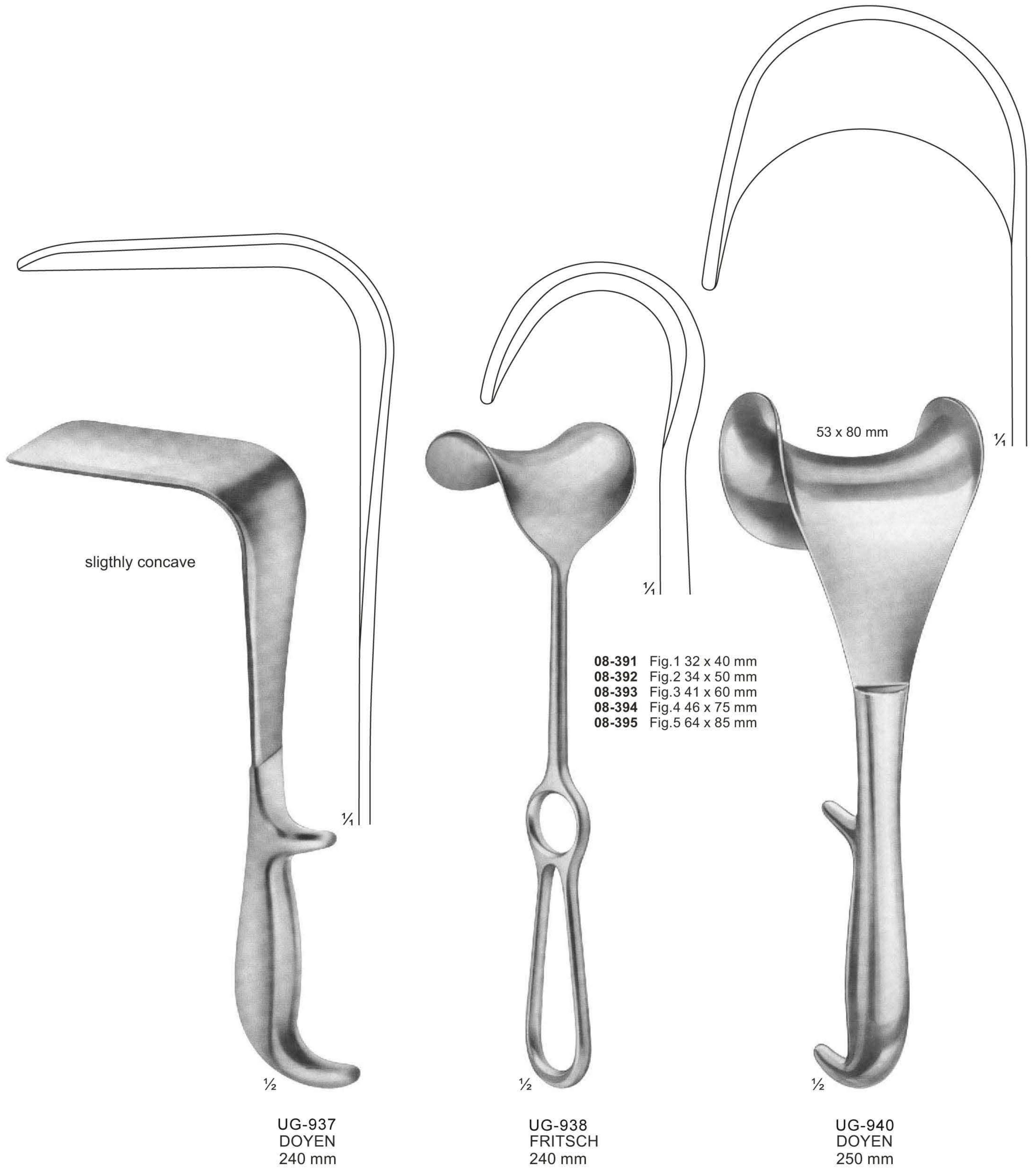

# Abdominal Retractors

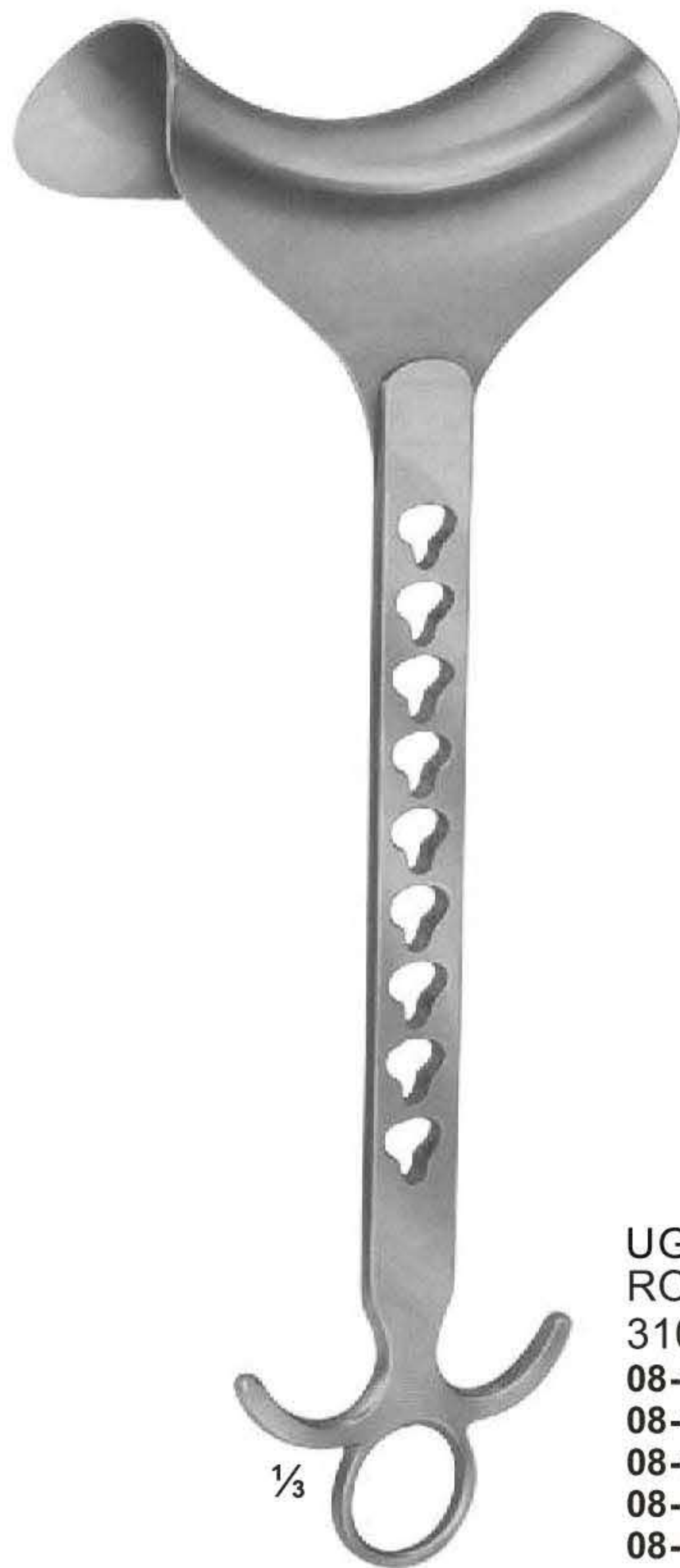

UG-942  
ROCHARD  
310 mm  
08-397 48 x 90 mm  
08-398 48 x 105 mm  
08-399 48 x 120 mm  
08-400 48 x 135 mm  
08-401 48 x 155 mm

1/3



1/3

UG-954



1/3

UG-995  
DOYEN  
280 mm  
08-403 48 x 90 mm  
08-404 48 x 105 mm  
08-405 48 x 120 mm  
08-406 48 x 135 mm



1/3

UG-958  
DOYEN-CHILD  
Fixation device  
220 mm



UG-960  
Chain with  
weight (747 / 645g)  
790 mm

# Pelvis Retractors

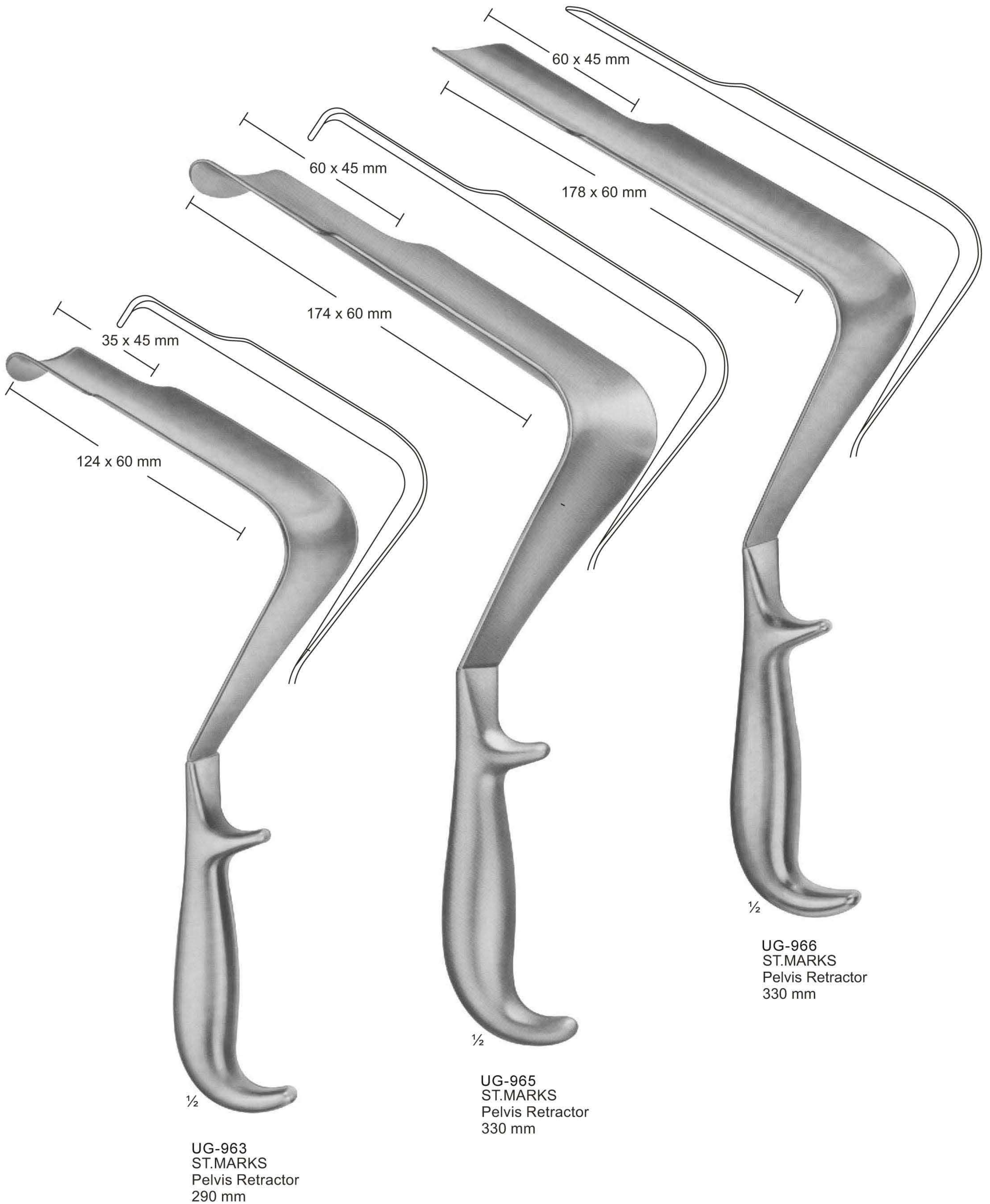



# Abdominal- and Intestinal Spatulas

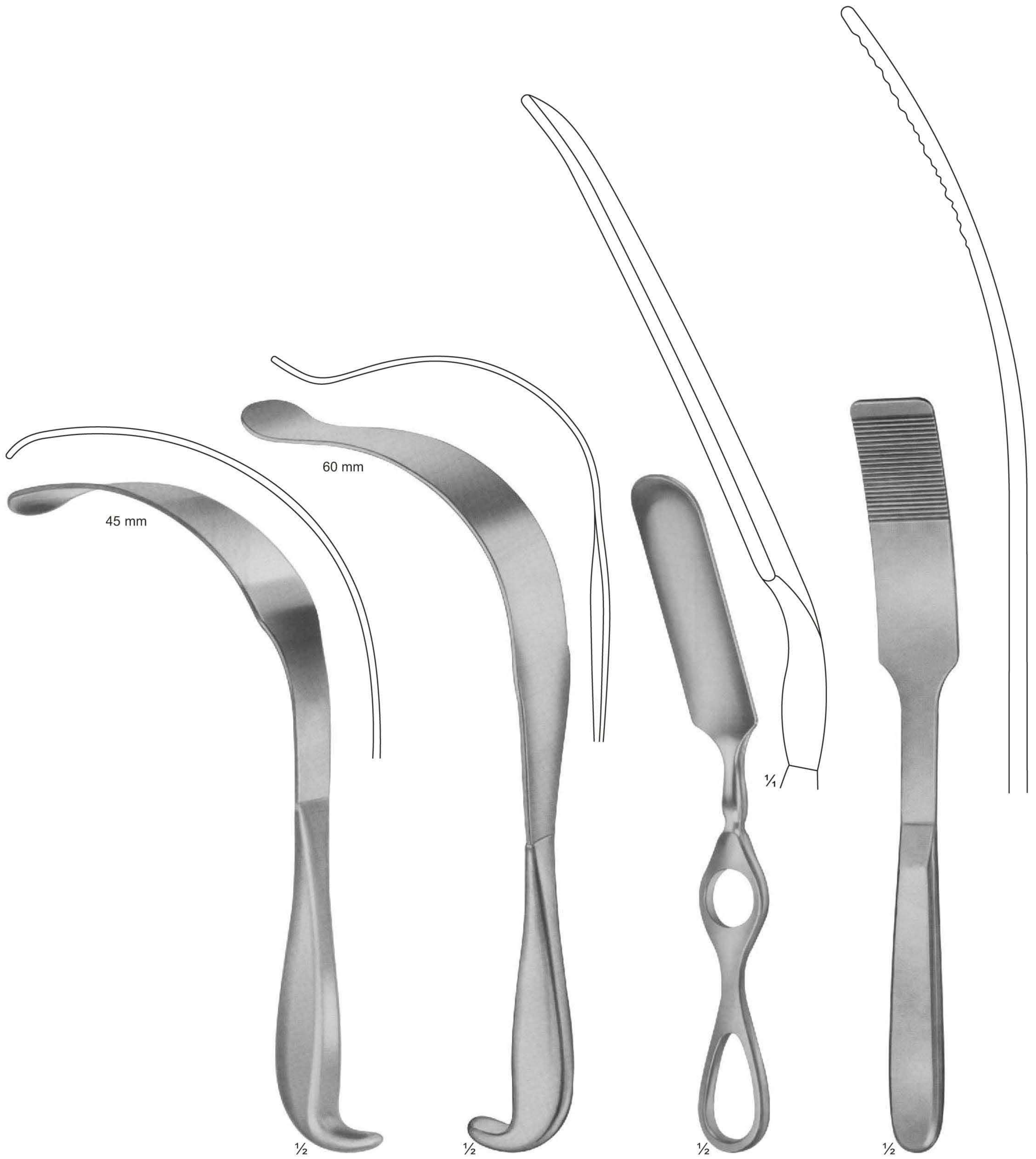

UG-967  
LERICHE  
255 mm

UG-968  
KUMMEL  
Malleable  
285 mm

UG-970  
MIKULICZ  
29 mm  
250 mm

UG-971  
KADER  
08-415 30 mm  
08-416 40 mm  
270 mm



**UG-150**  
**Scalpels,**  
**Tenotomes &**  
**Resection**

**SIZE:100mm**

# Abdominal- and Intestinal Spatulas



UG-972  
REVERDIN  
285 mm



UG-973  
HABERER  
Malleable  
305 mm



UG-974  
Malleable  
330 mm



UG-977  
TUFFIER  
Melleable  
200 mm

# Self-Retaining Retractors



UG-978  
BOSE  
60 mm



UG-980  
FINSEN  
50 mm



UG-981  
FINSEN  
70 mm



UG-983  
FINSEN modif.  
75 mm



UG-984  
45 mm



08-428  
55 mm



UG-985  
MUELLER  
65 mm



UG-986  
100 mm



UG-987  
ALM  
08-431 70 mm  
08-432 100 mm

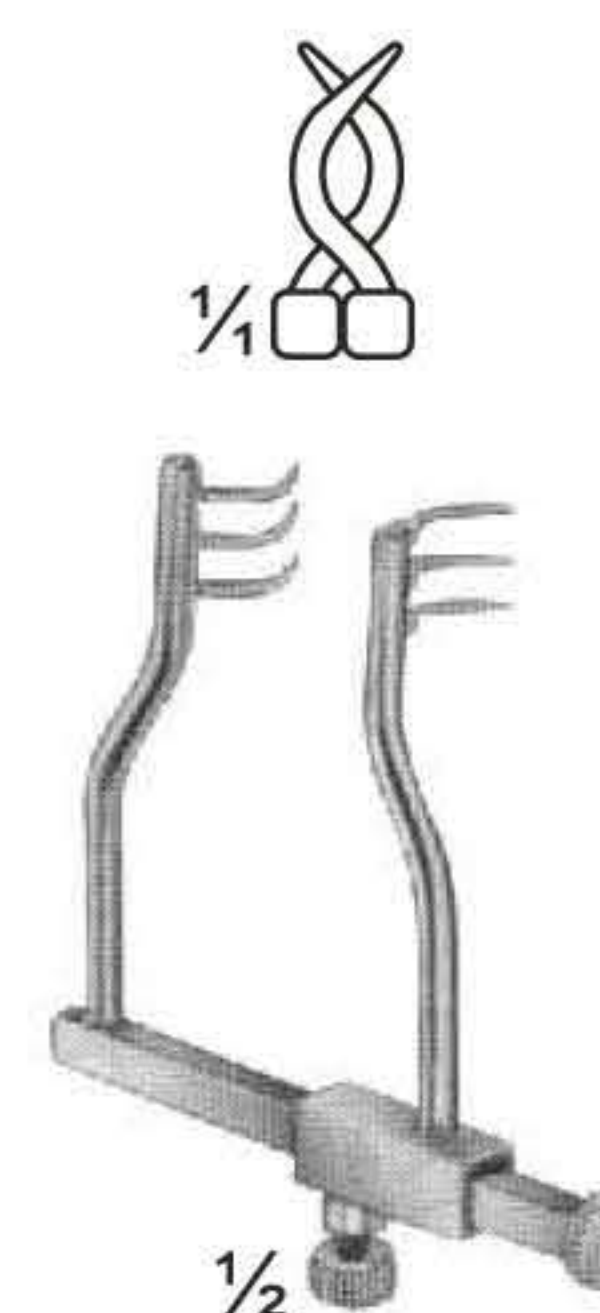
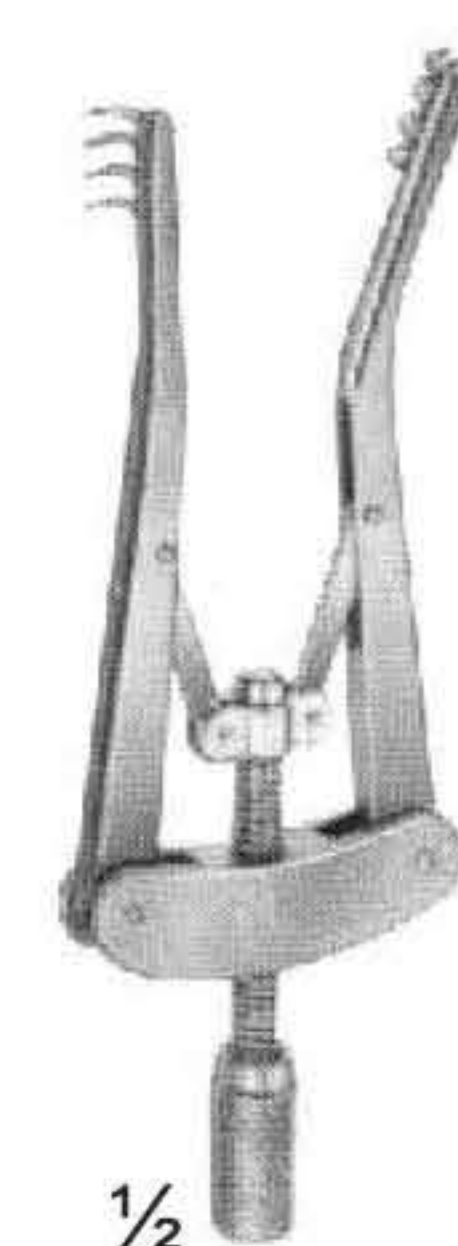

UG-988  
LOGAN  
modif. REILL  
50 mm

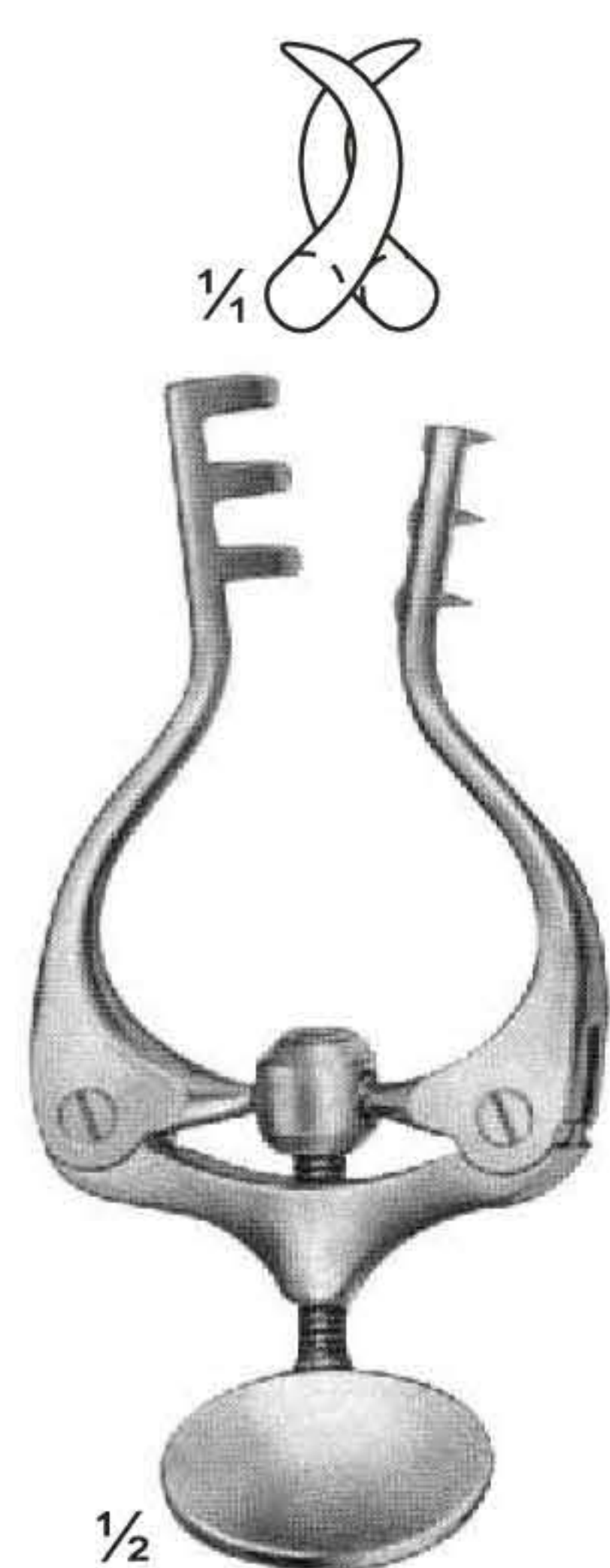

UG-989  
JANSEN  
100 mm

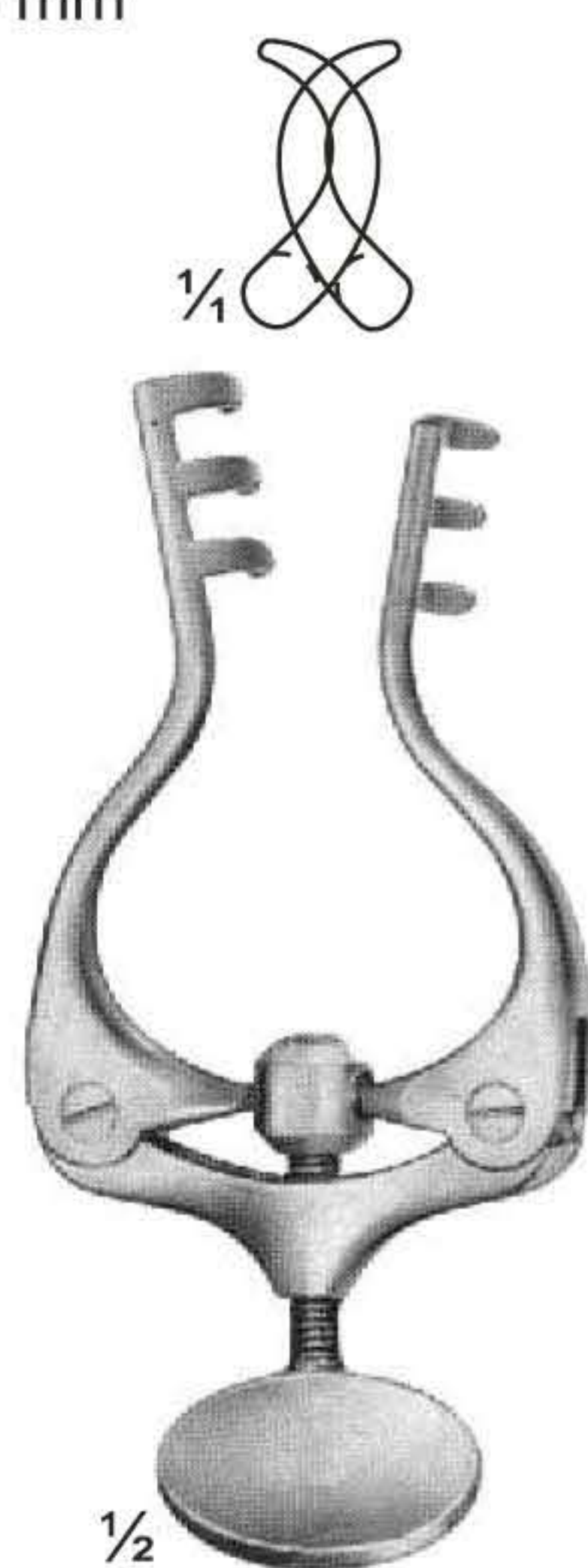

UG-990  
100 mm

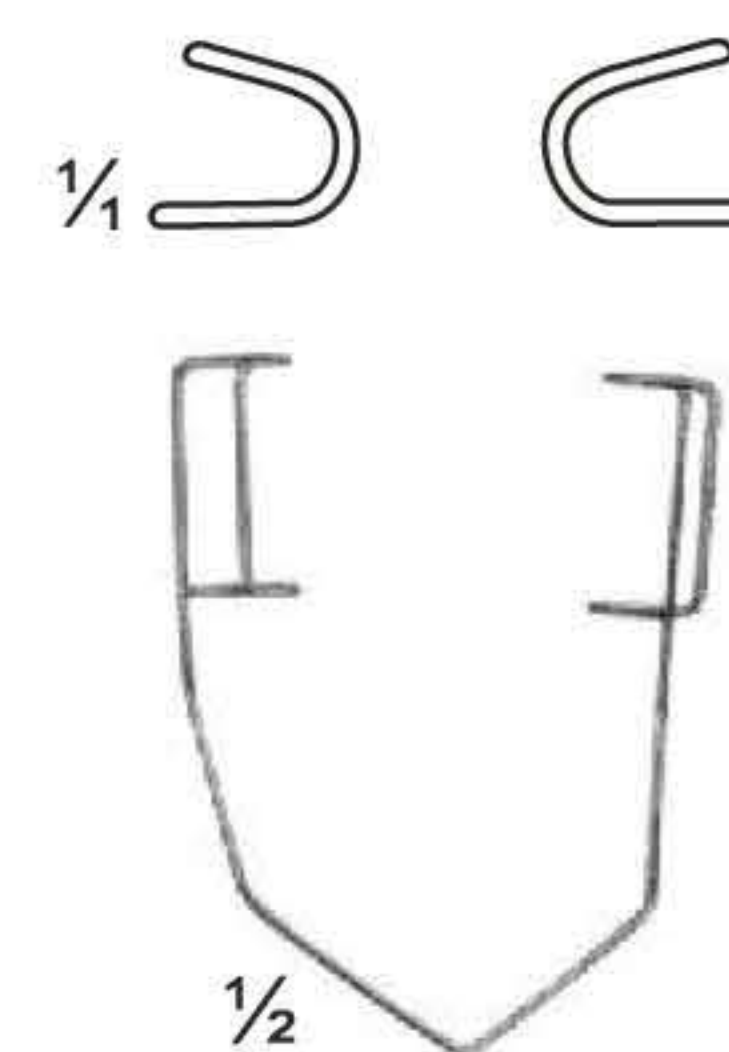

UG-991  
BARRAQUER  
45 mm

# Self-Retaining Retractors

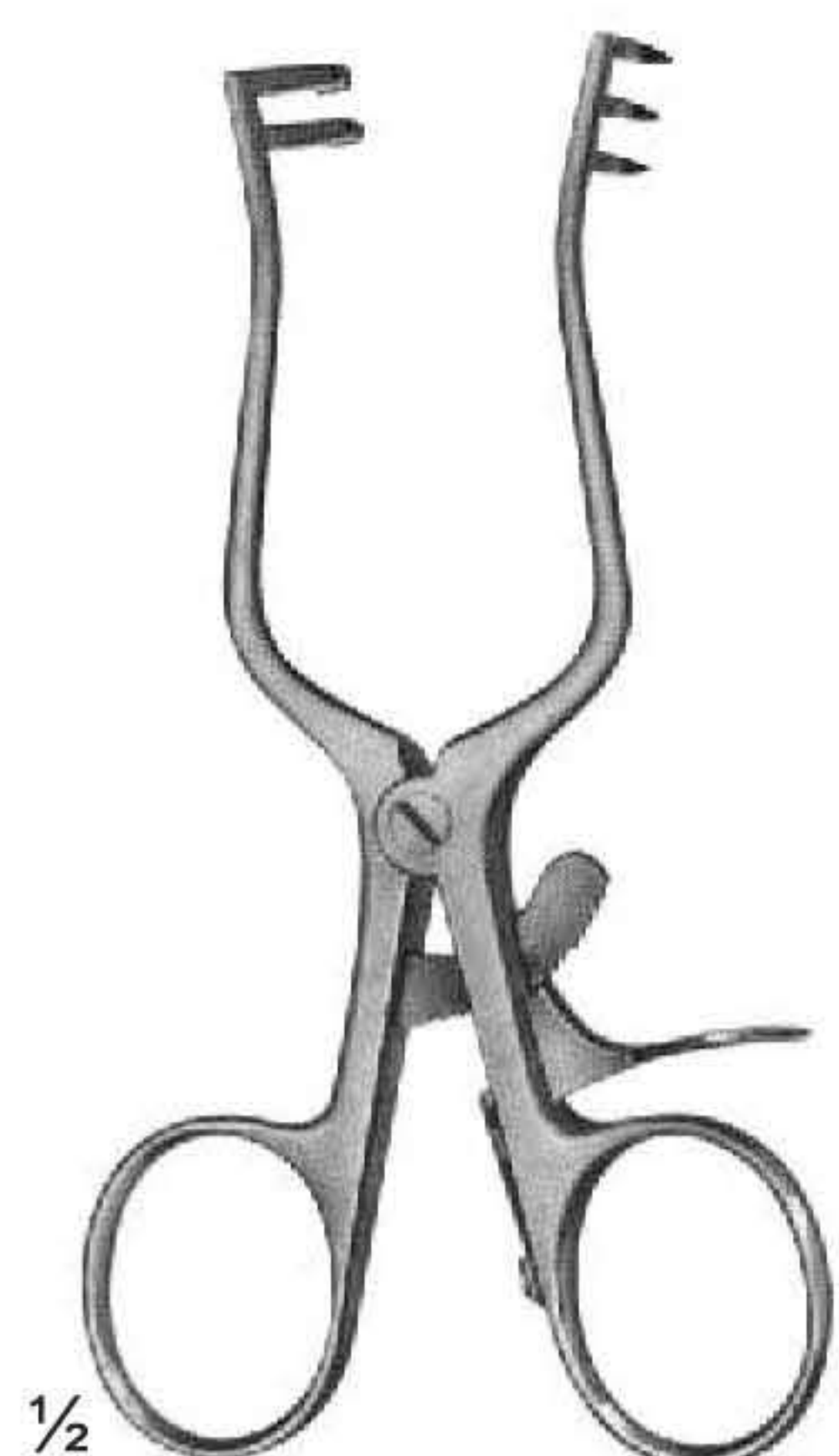

UG-993  
WEITLANER  
Sharp  
110 mm

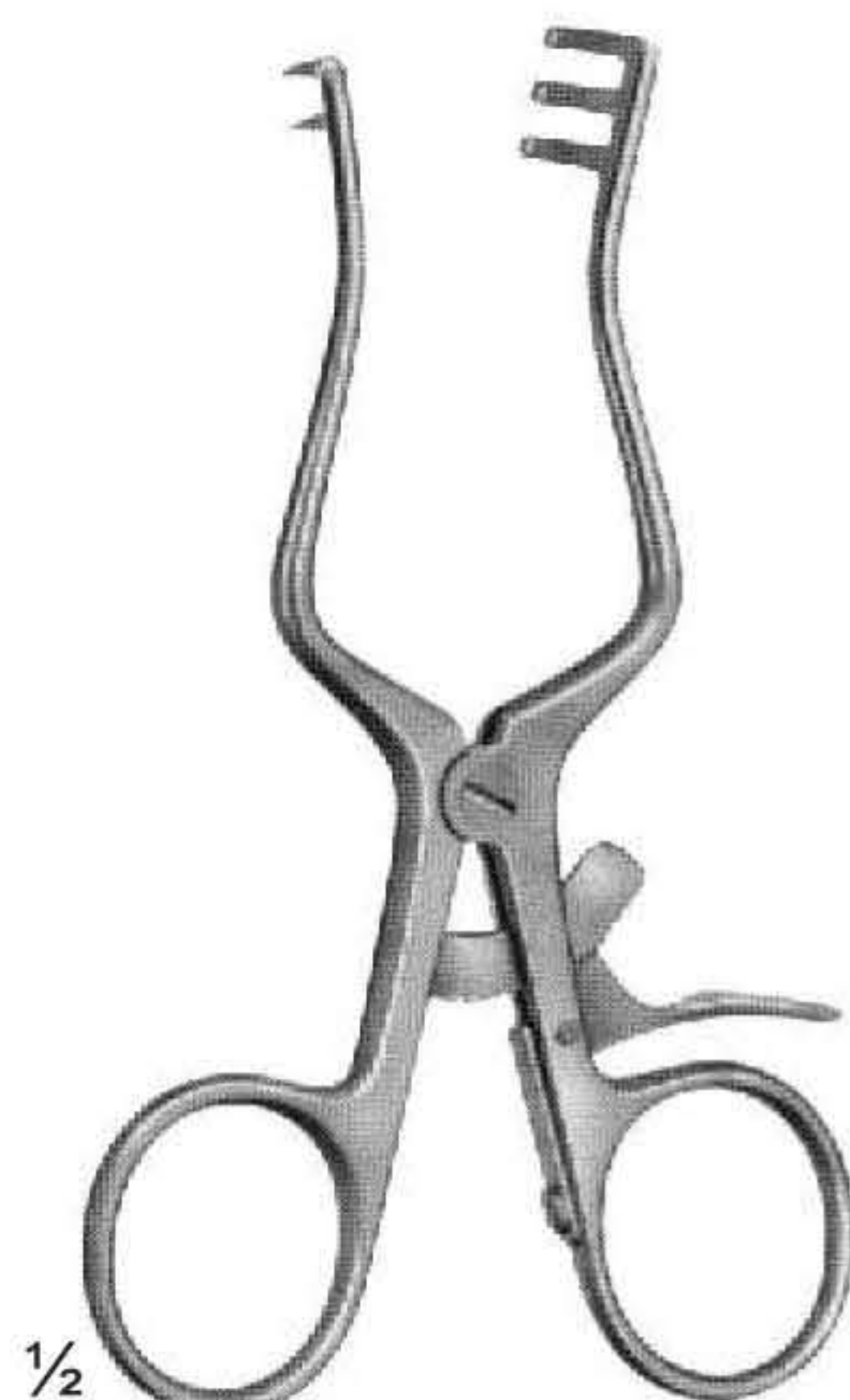

UG-994  
WEITLANER  
Semi-Sharp  
110 mm

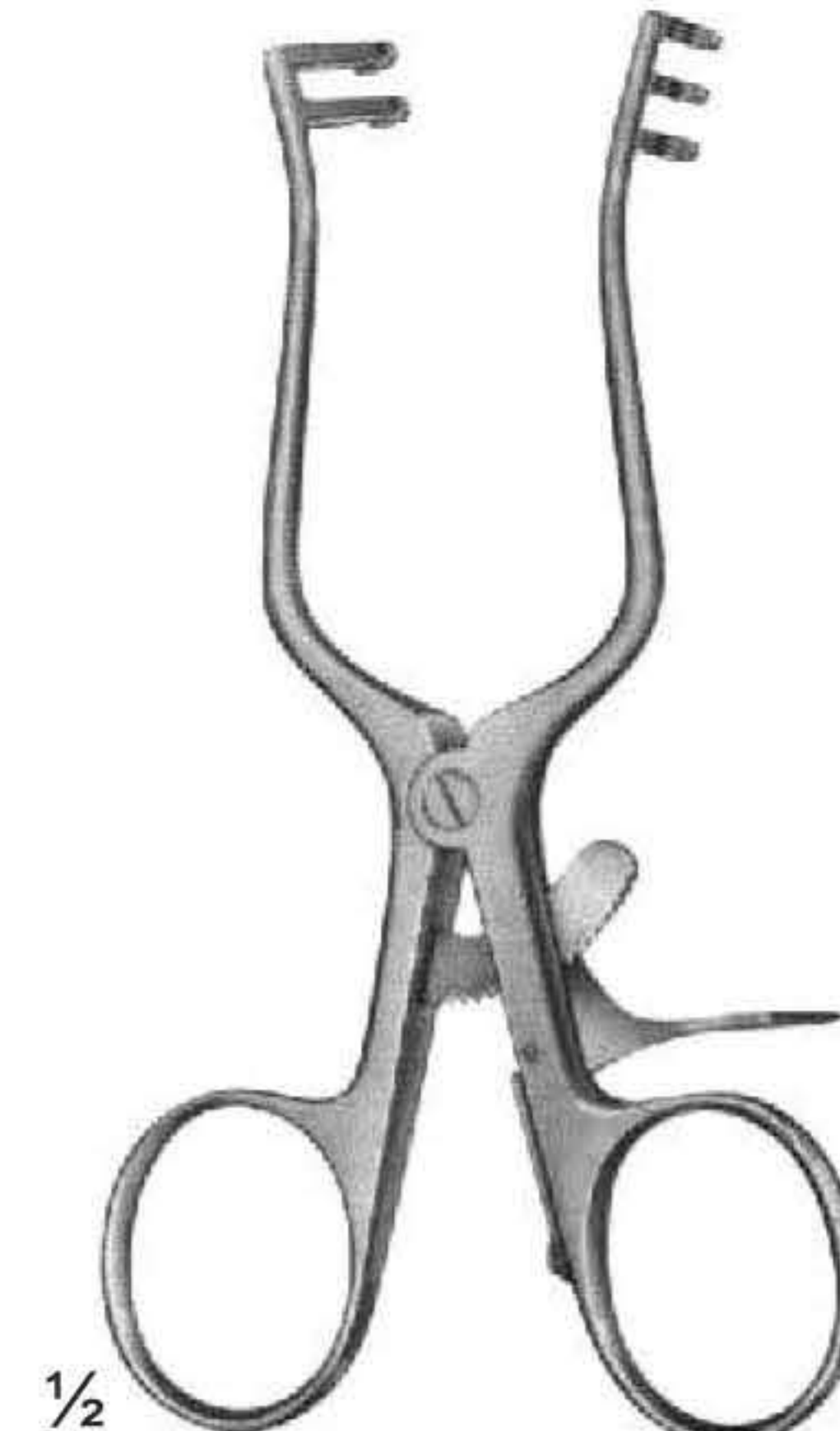

UG-995  
WEITLANER  
Blunt  
110 mm

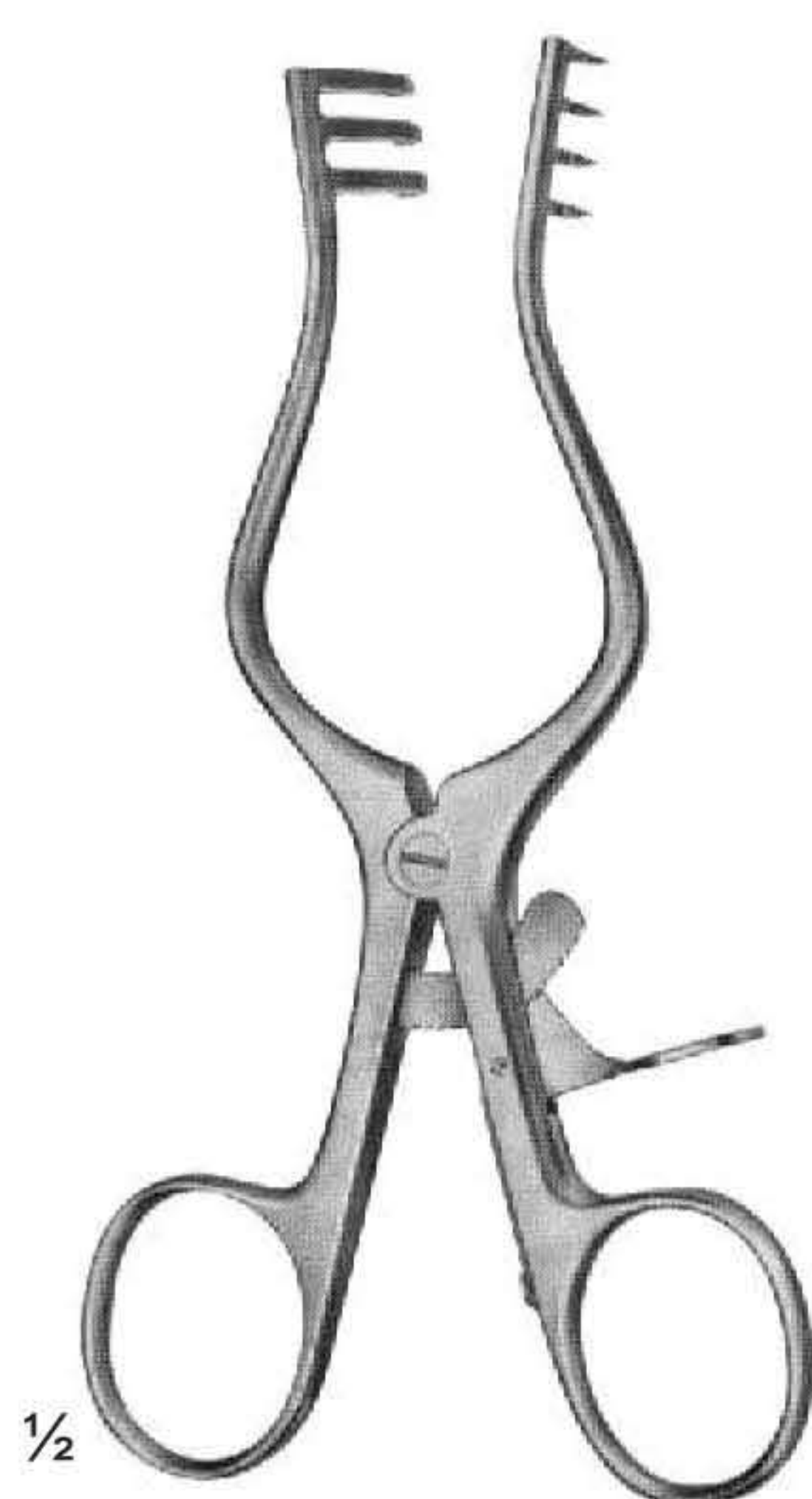

UG-994  
WEITLANER  
Sharp  
130 mm



UG-997  
WEITLANER  
Semi-Sharp  
130 mm

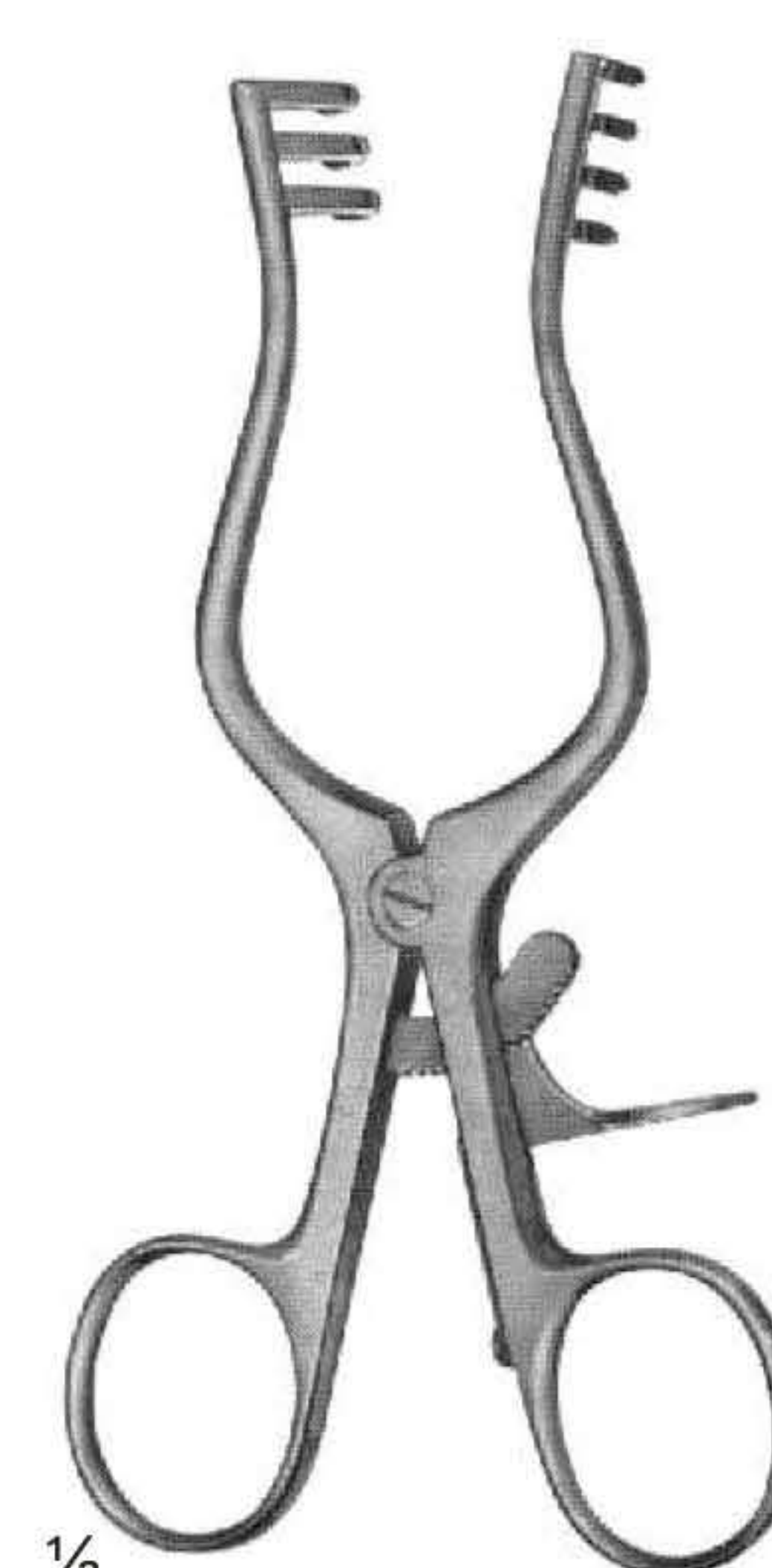

UG-998  
WEITLANER  
Blunt  
130 mm

# Self-Retaining Retractors

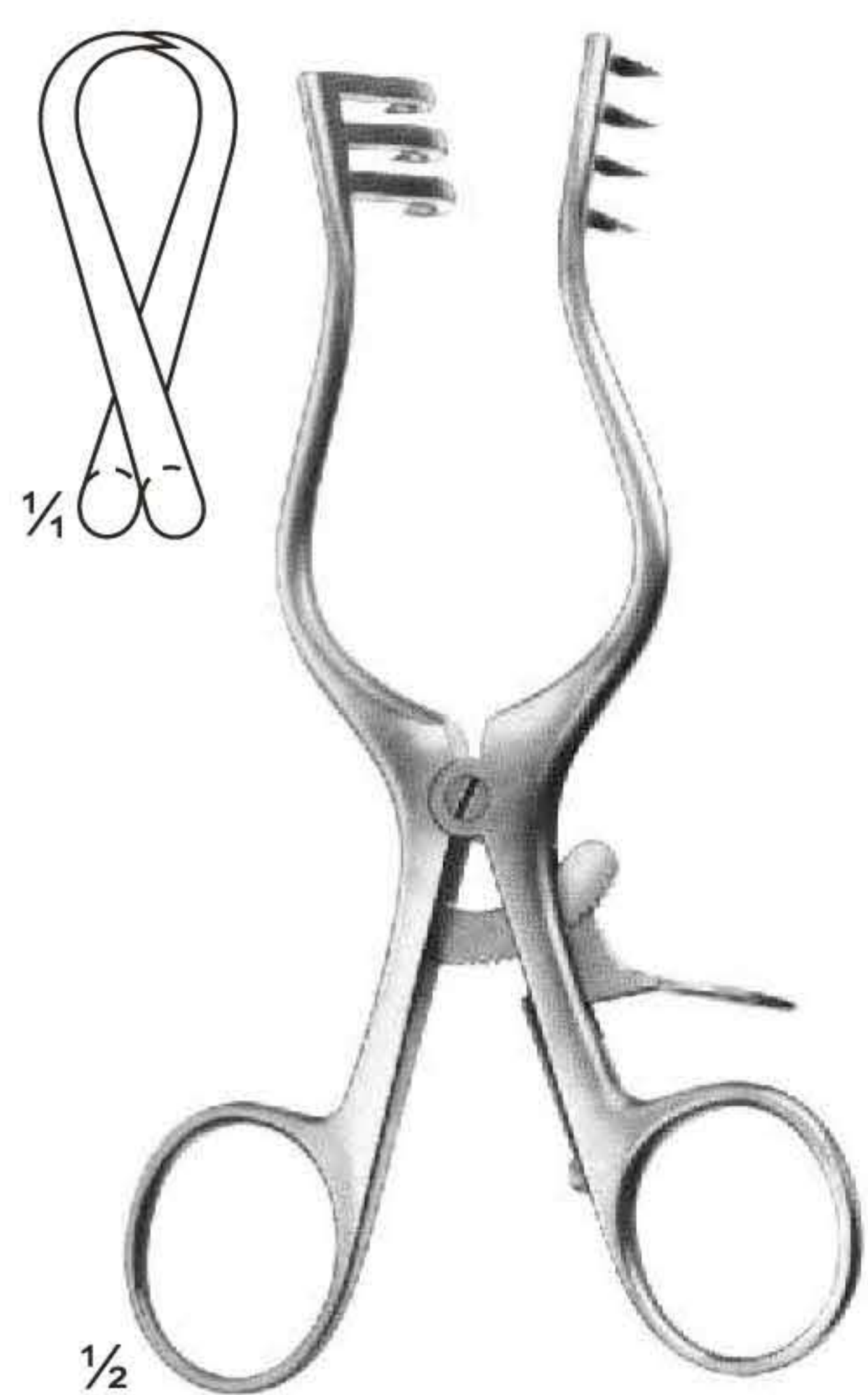

UG-999  
WEITLANER  
Sharp  
130 mm

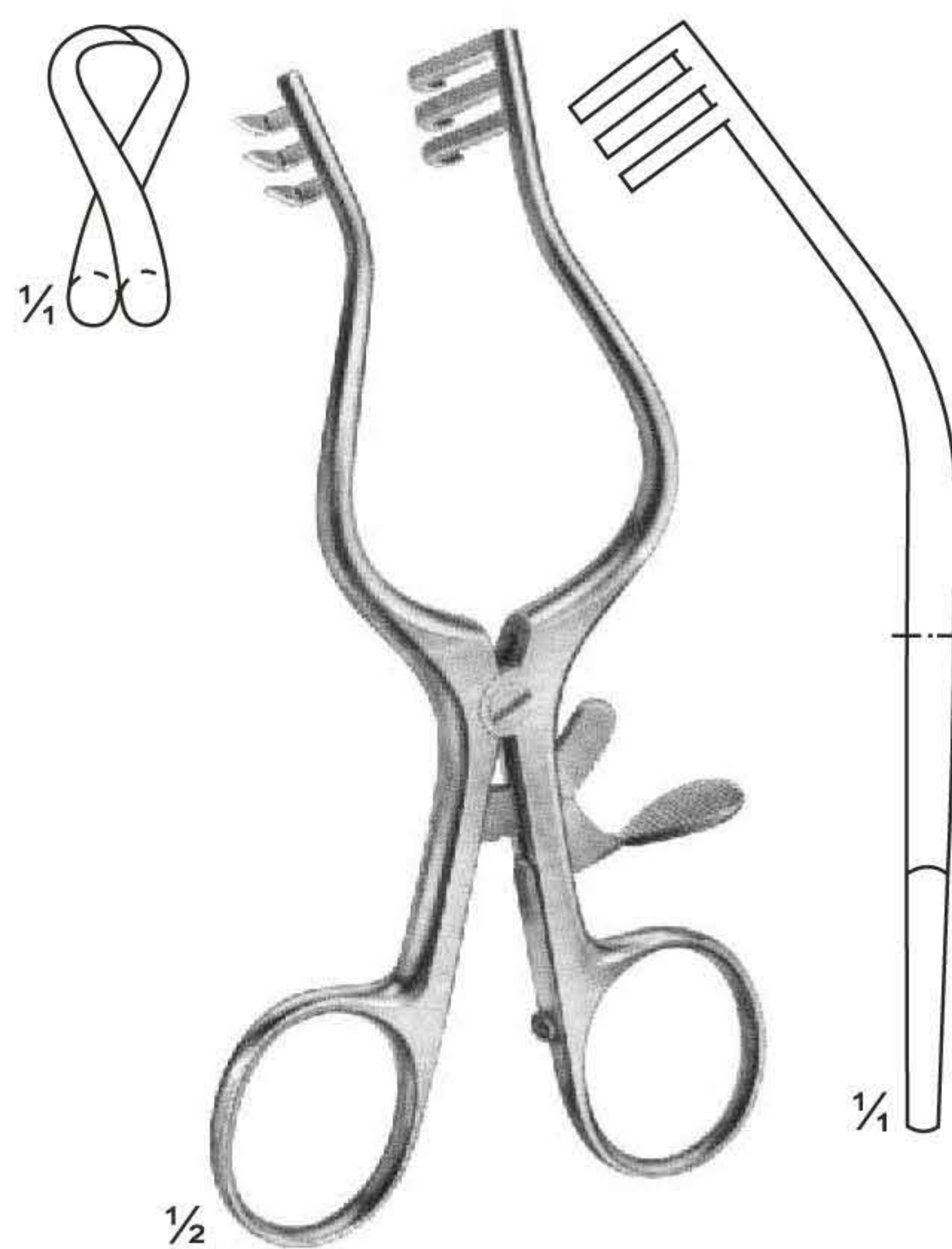

UG-1000  
WULLSTEIN  
Sharp  
130 mm

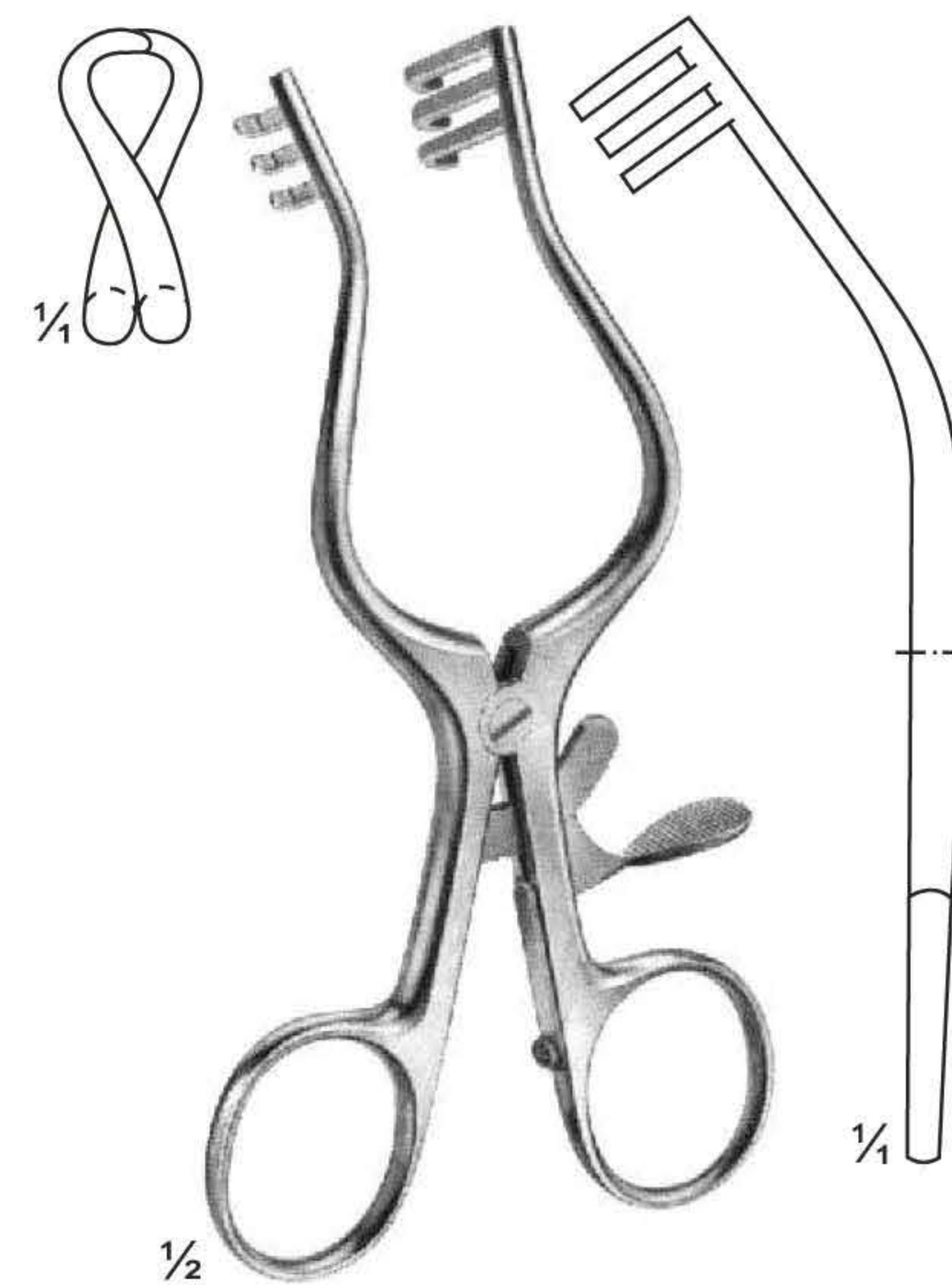

UG-1001  
WULLSTEIN  
Blunt  
130 mm

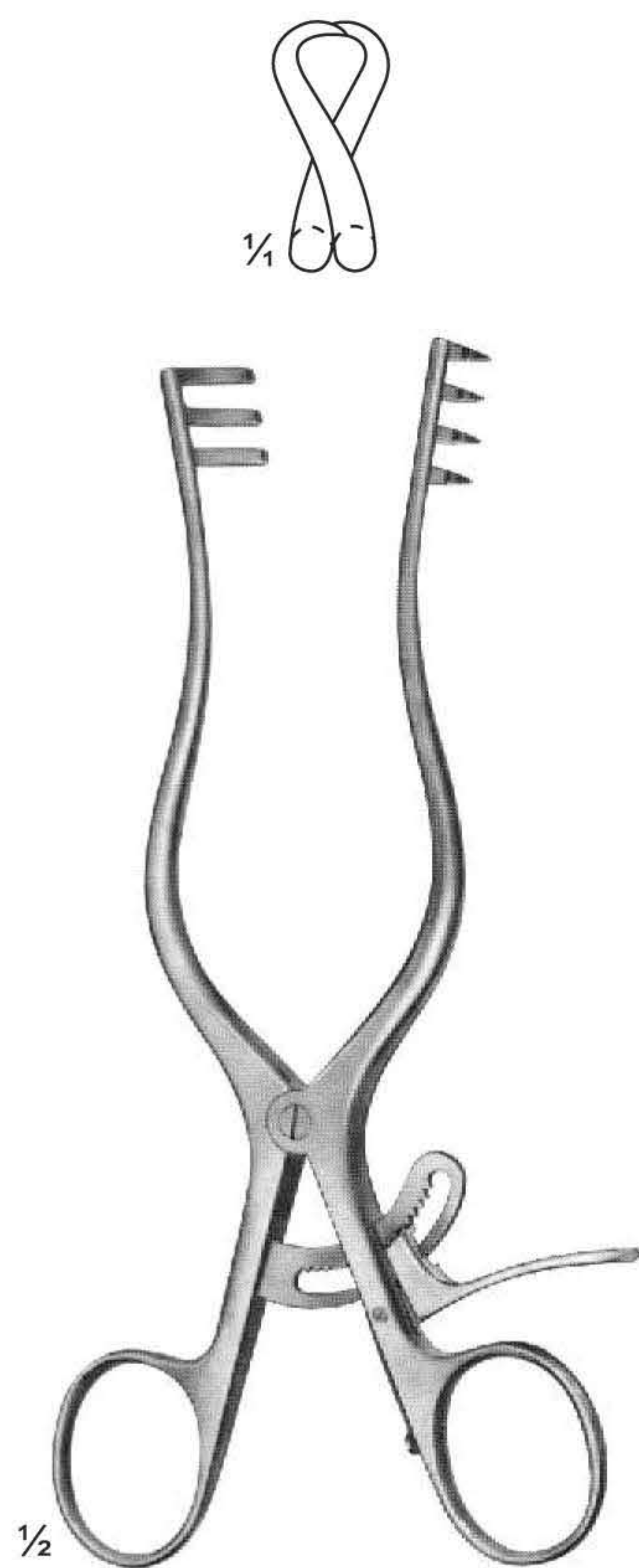

UG-1002  
WEITLANER  
Sharp  
165 mm



UG-1003  
PLESTER  
Blunt  
110 mm

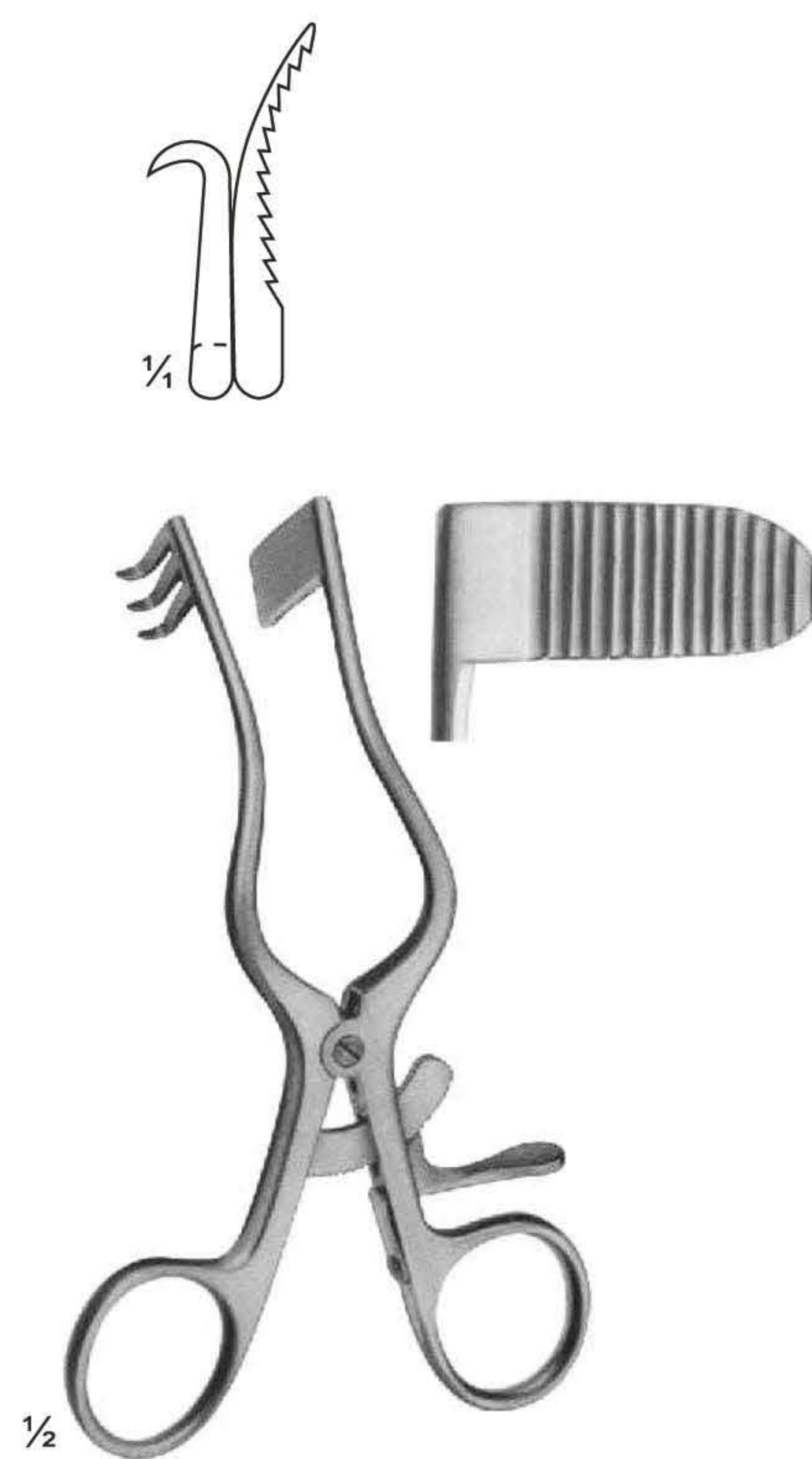

UG-1004  
PERKINS  
130 mm

# Self-Retaining Retractors



UG-1005  
ADSON-BABY  
Blunt  
140 mm

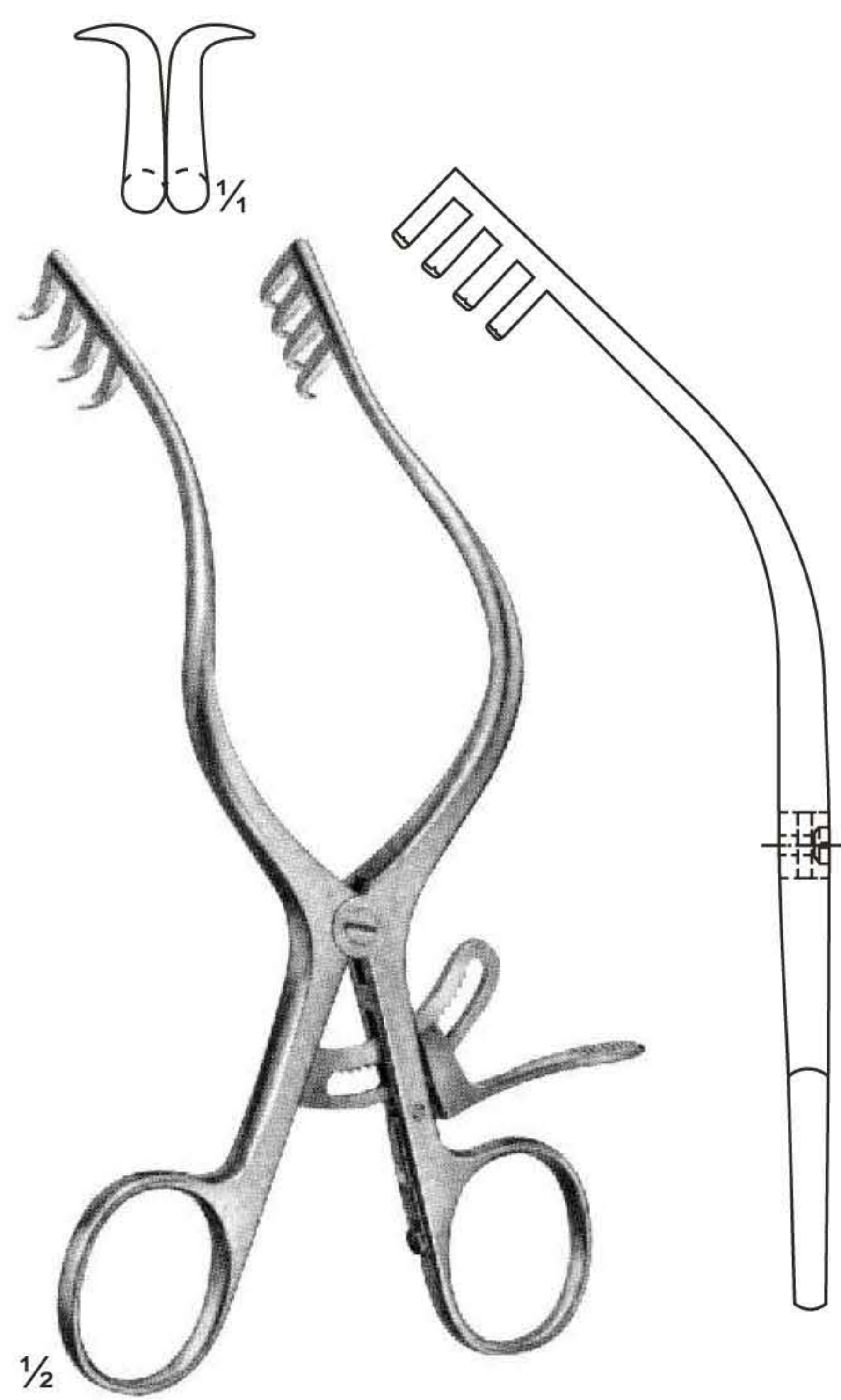

UG-1006  
MOLLISON  
Sharp  
155 mm

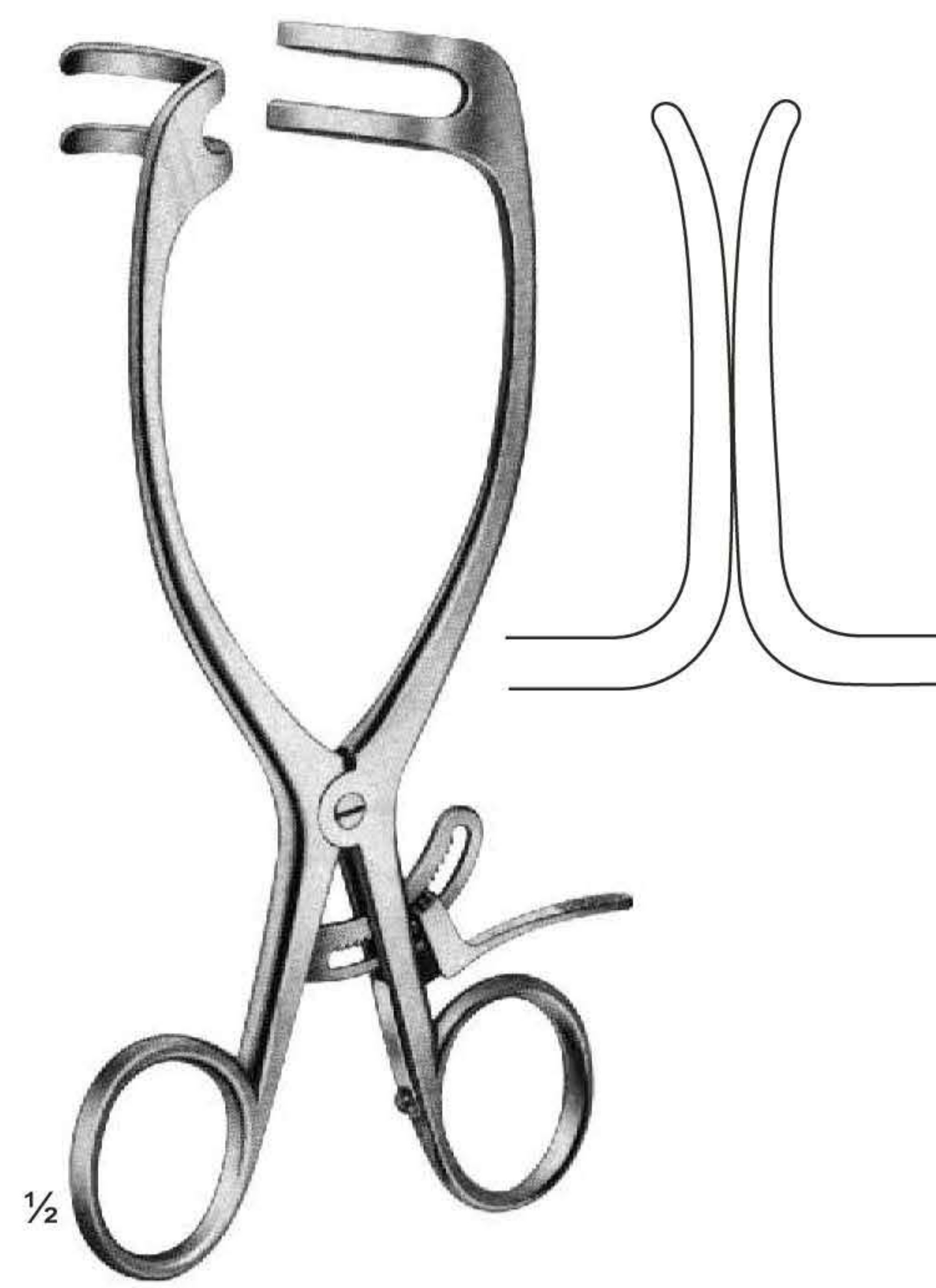

UG-1008  
MAYO-ADAMS  
165 mm

# Self-Retaining Laminectomy Retractors

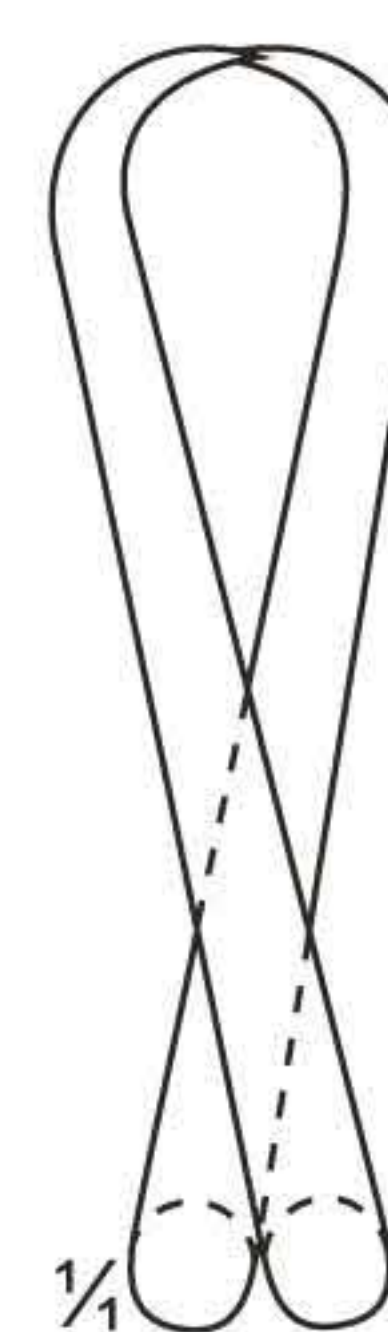
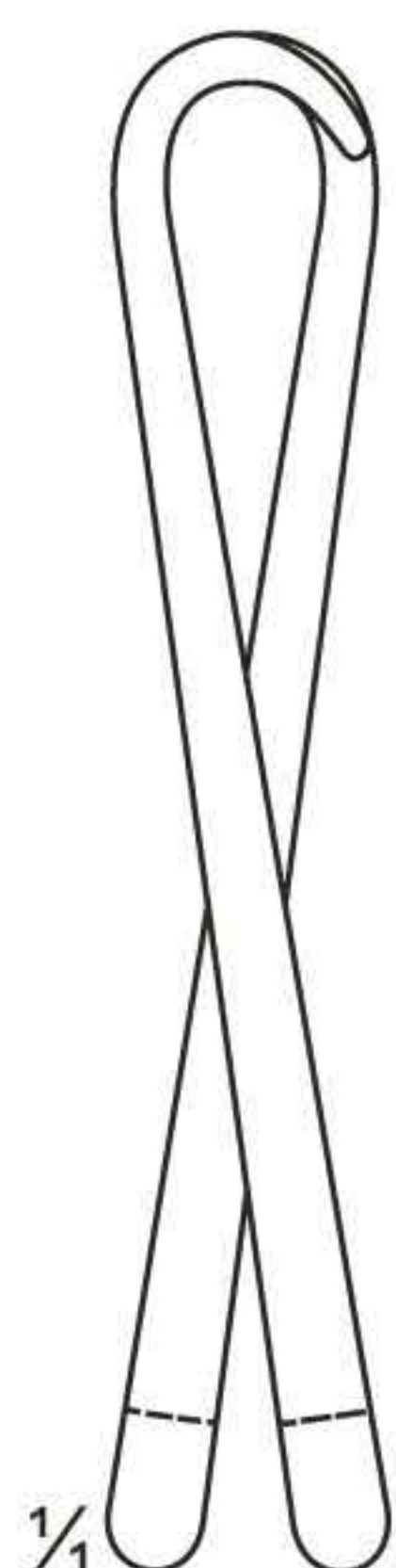
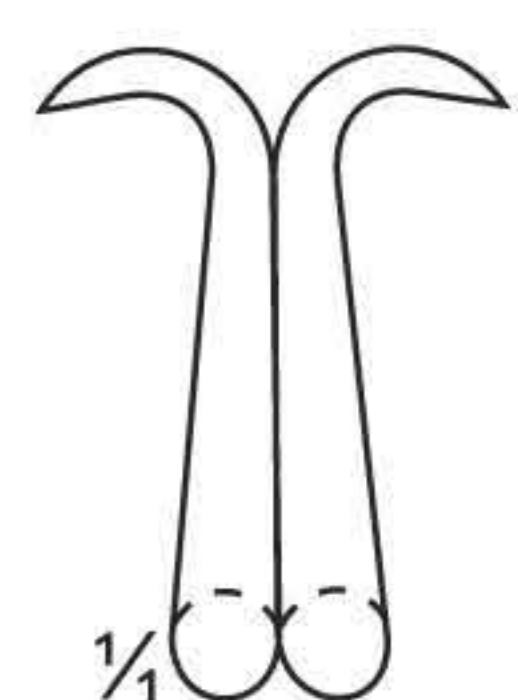

UG-1010  
ANDERSON-ADSON  
Sharp  
190 mm

UG-1013  
NORFOLK and  
NORWICH  
Blunt  
220 mm

UG-1015  
ADSON  
Sharp  
265 mm



# Self-Retaining Laminectomy Retractors

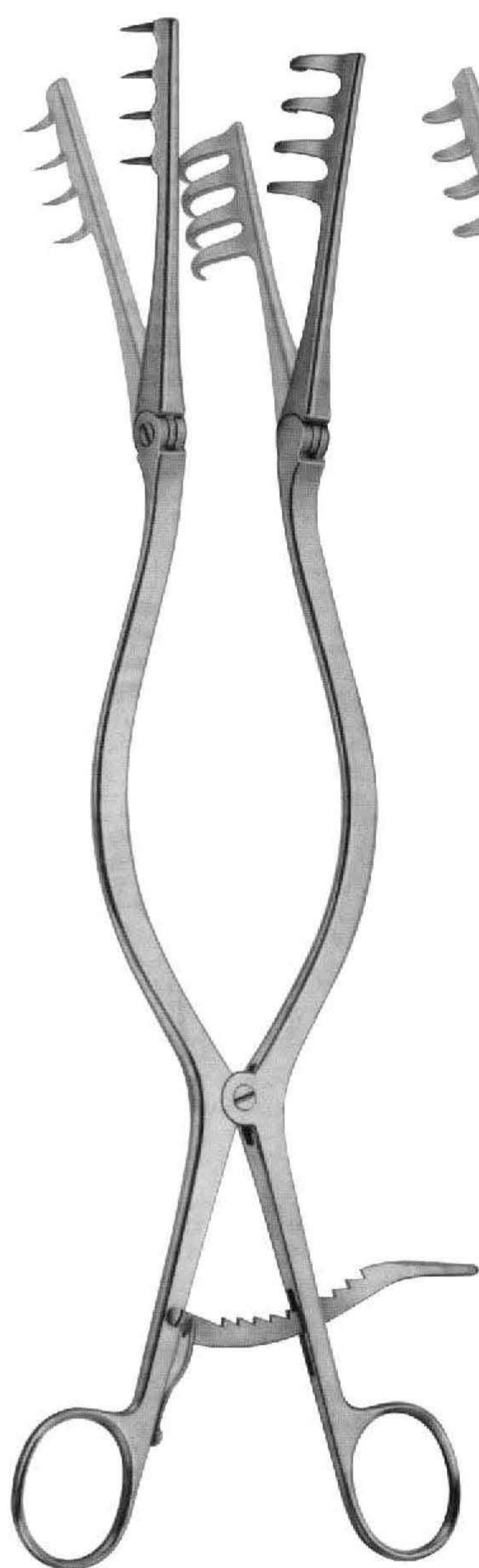
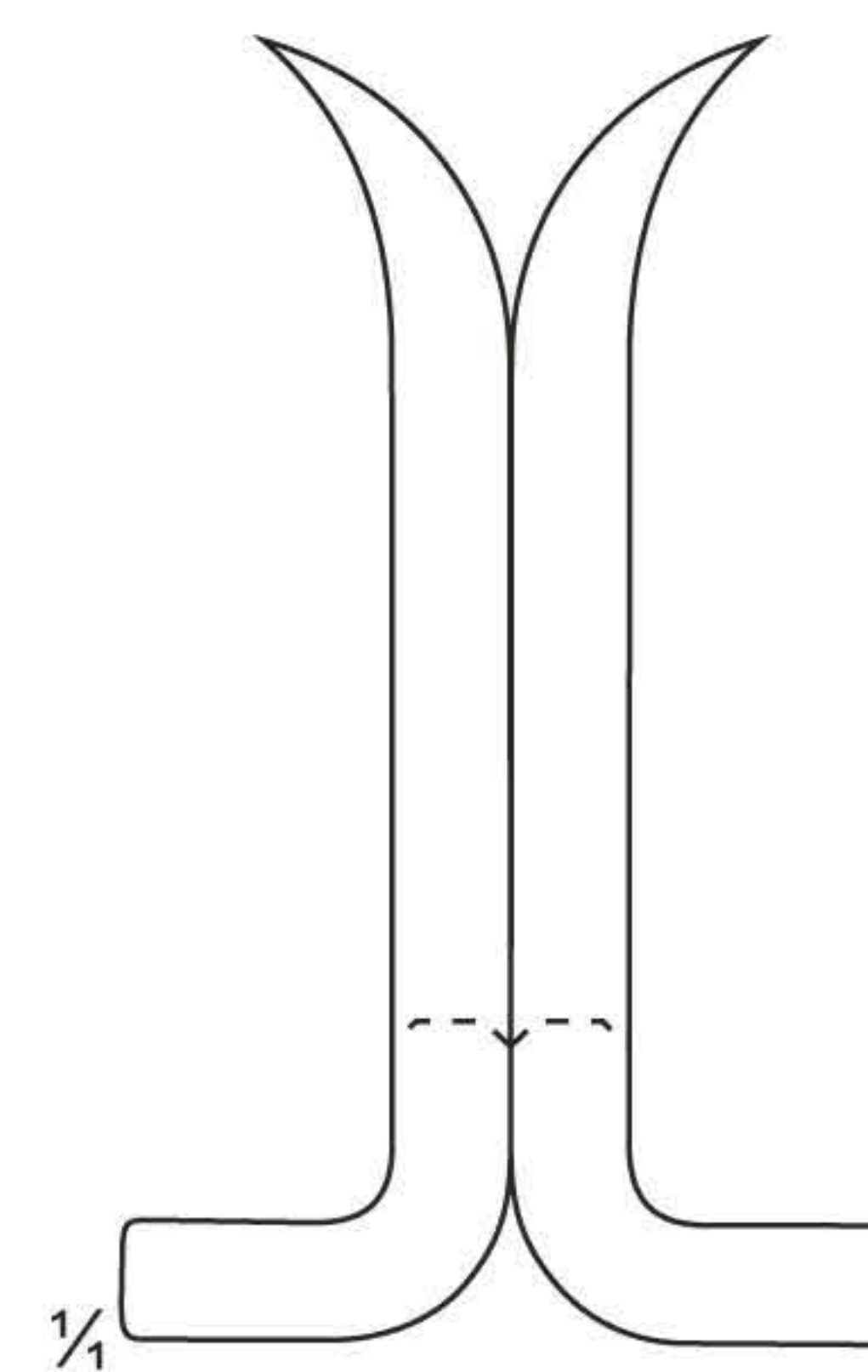
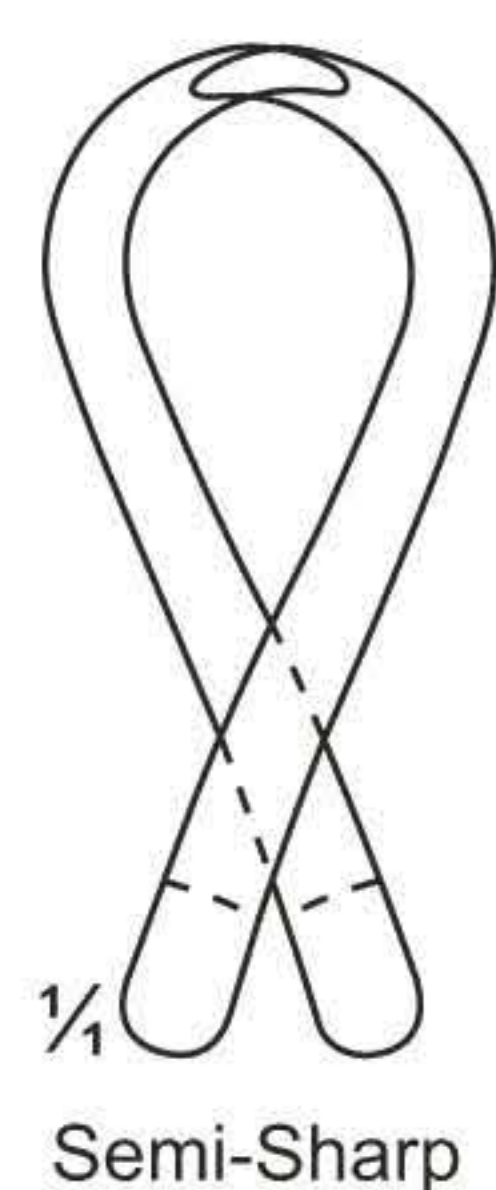
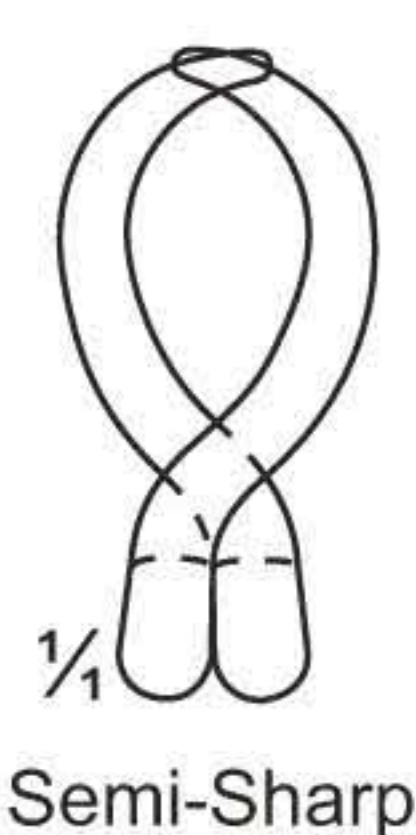
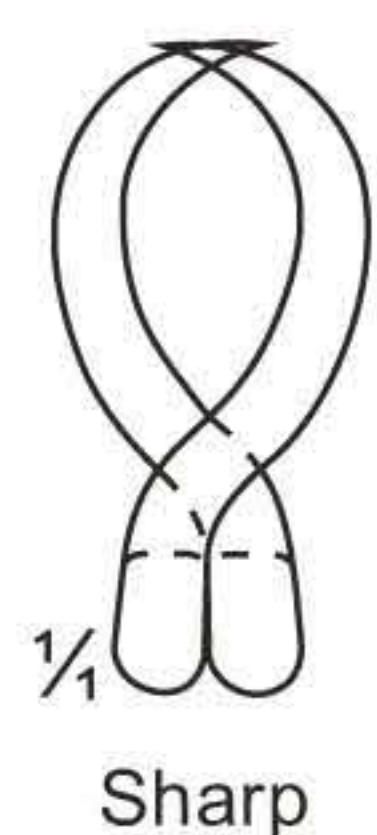

UG-1016  
BECKMANN-ADSON  
Sharp  
310 mm



08-456  
BECKMANN-ADSON  
Semi-Sharp  
310 mm



UG-1018  
ADSON  
Semi-Sharp  
320 mm



UG-1019  
BECKMANN-EATON  
Sharp  
320 mm

# Special Retractors



UG-1021  
JOLL ( FRIEDMAN )  
Thyroid- and Vaginal Retractor  
155 mm

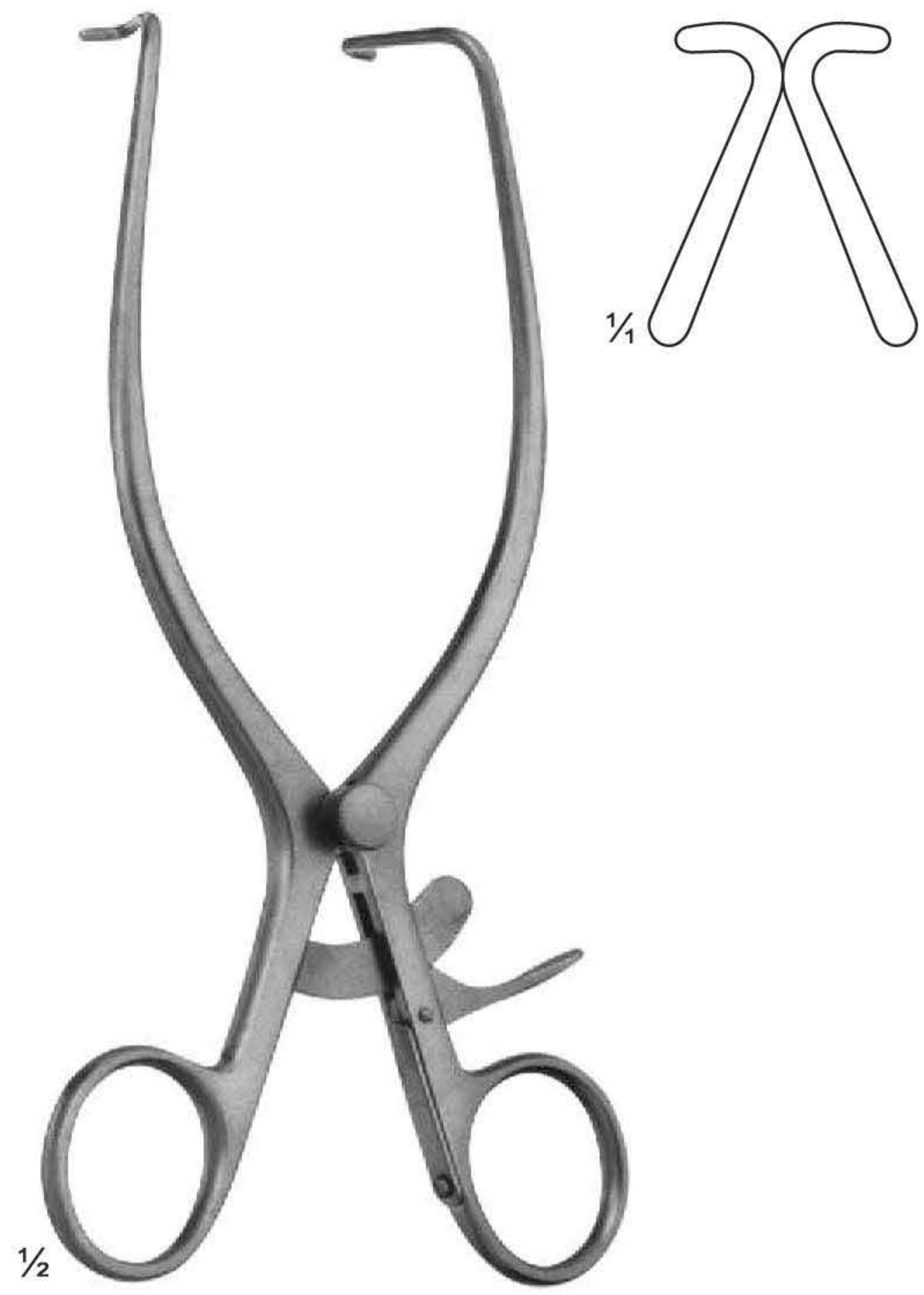

UG-1023  
JACKSON BURROWS  
Retractor, blunt  
185 mm

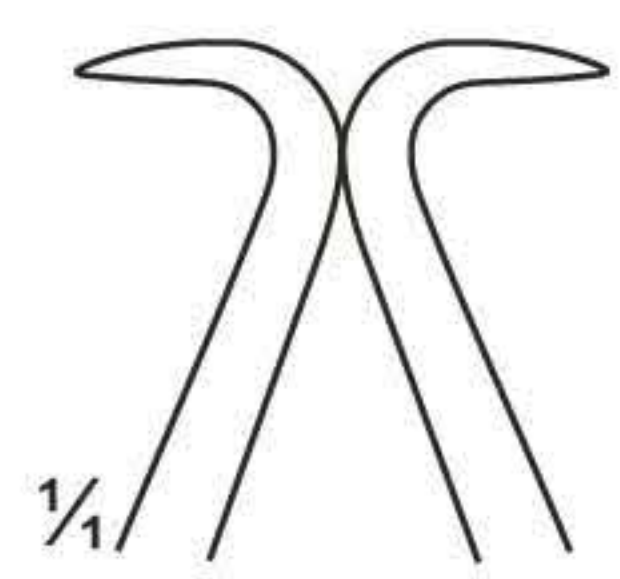

UG-1025  
GELPI  
Vaginal Retractor  
135 mm

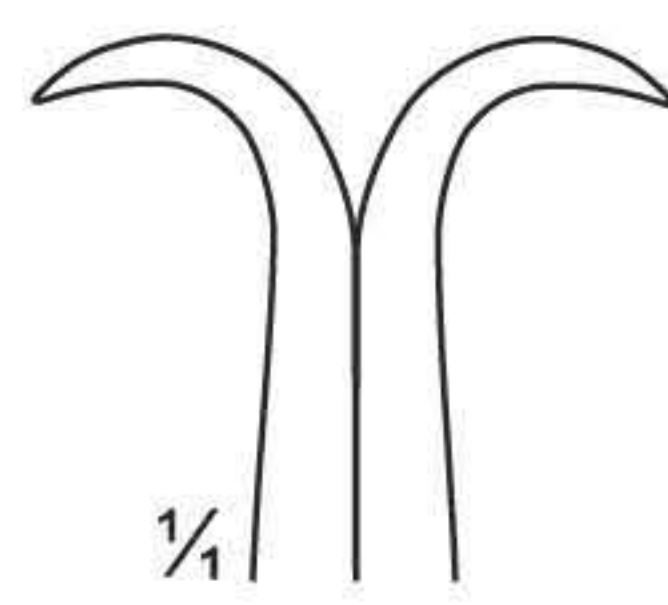

UG-1026  
GELPI  
Skin- and Vaginal Retractor  
175 mm

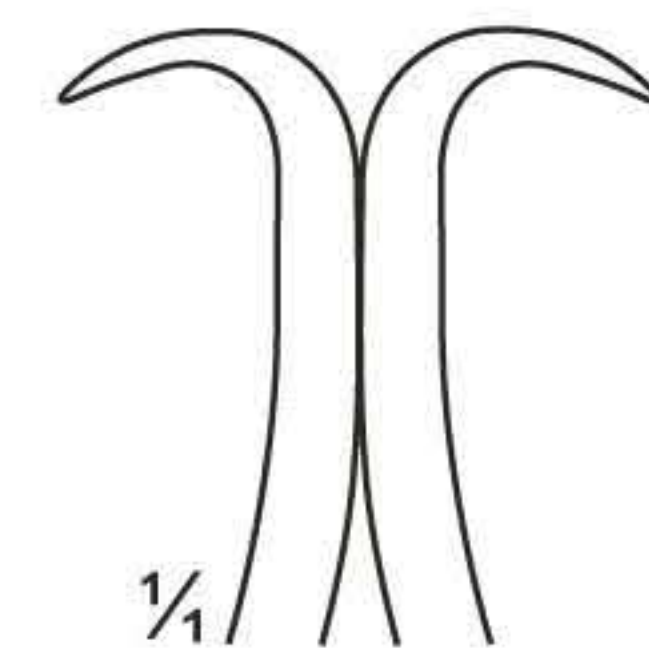

UG-1027  
DE BAKEY  
Femur Retractor  
145 mm

## Self Retaining Retractors for Laminectomy and other Operations

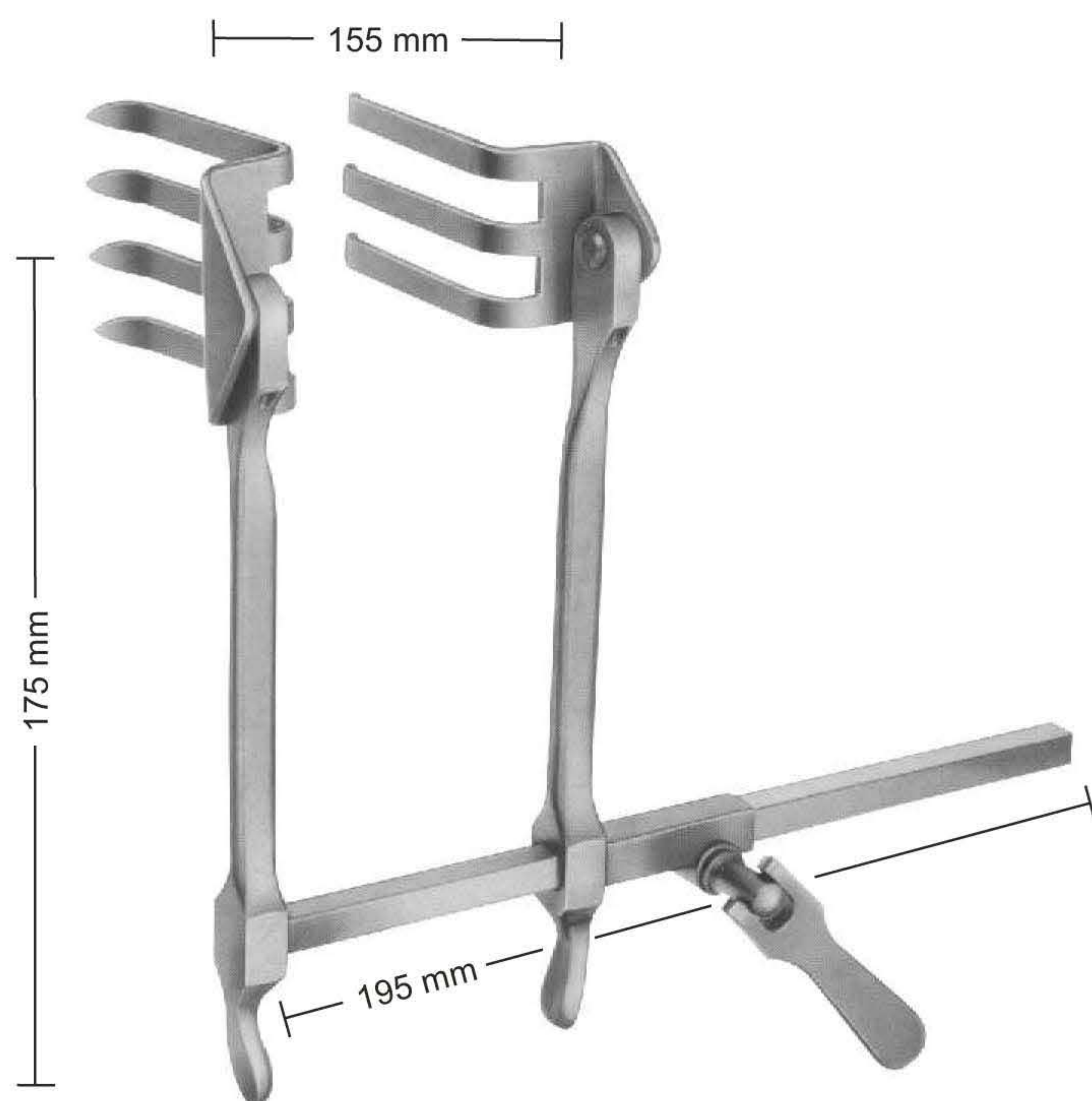

UG-1031  
SCOVILLE-RICHTER  
Retractor with 1 pair  
blades reversible type.  
The Retractor bar and  
shanks may be easily  
rotated 180° when  
blades are in situ.

## Retractors for Cervical Spine

---



UG-1036  
CLOWARD modif.  
Spreader Only

# Amputating Knives, Cartilage Knives, Autopsy Knives

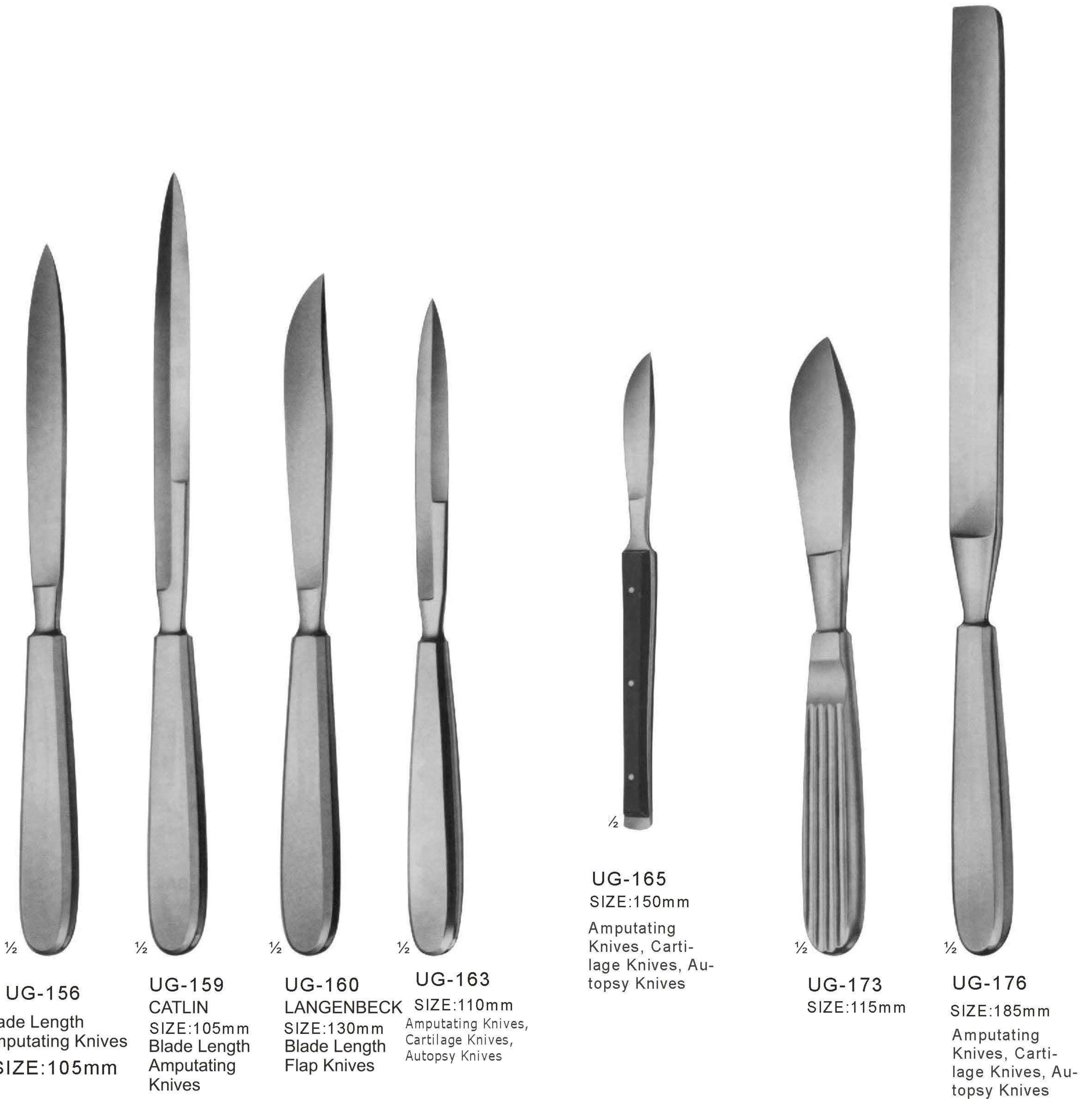

# Retractors for Cervical Vertebral Column

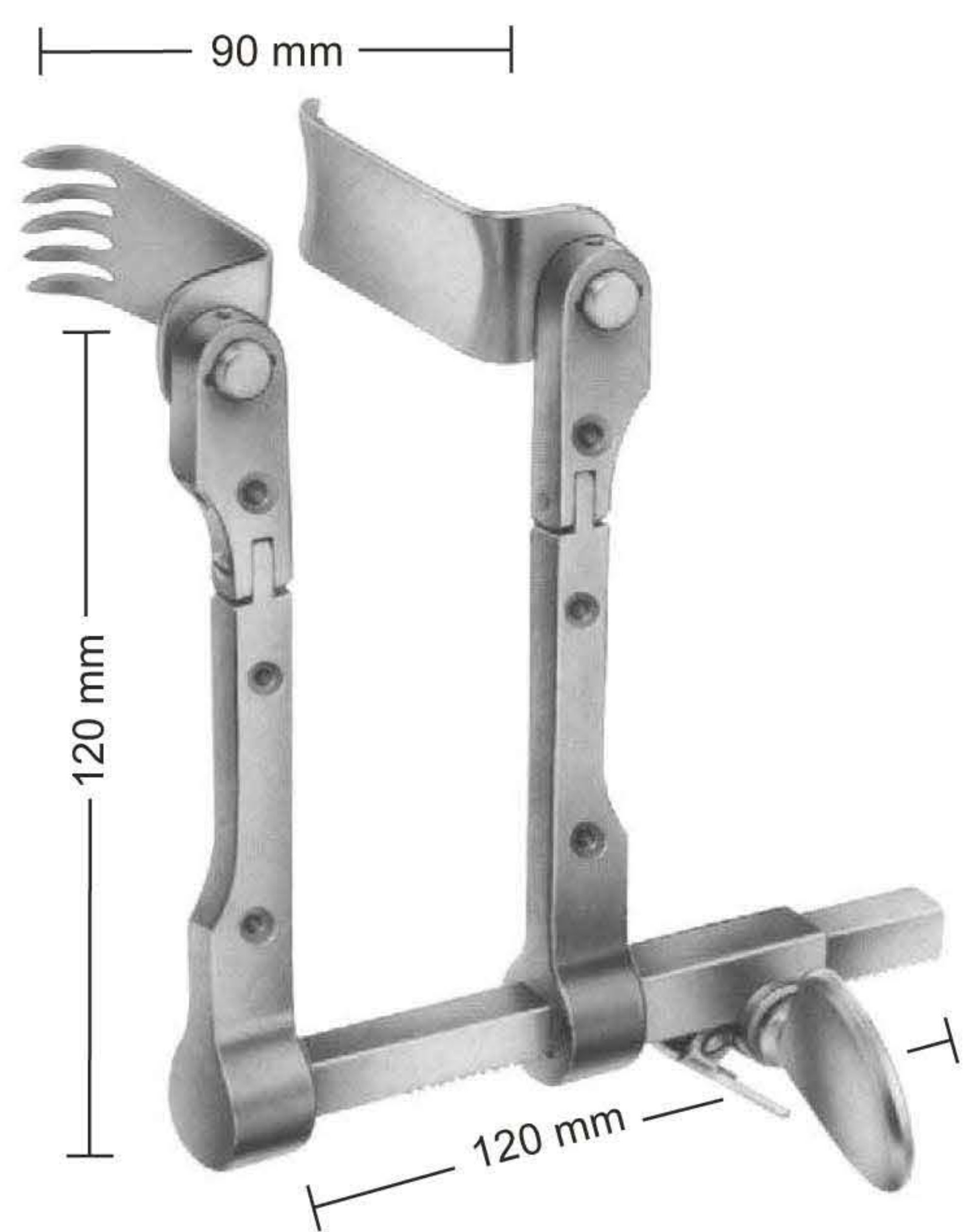

UG-1043  
CASPAR  
Retractor, adjustable,  
consisting of: 5 medial  
blades, 5 Lateral blades.

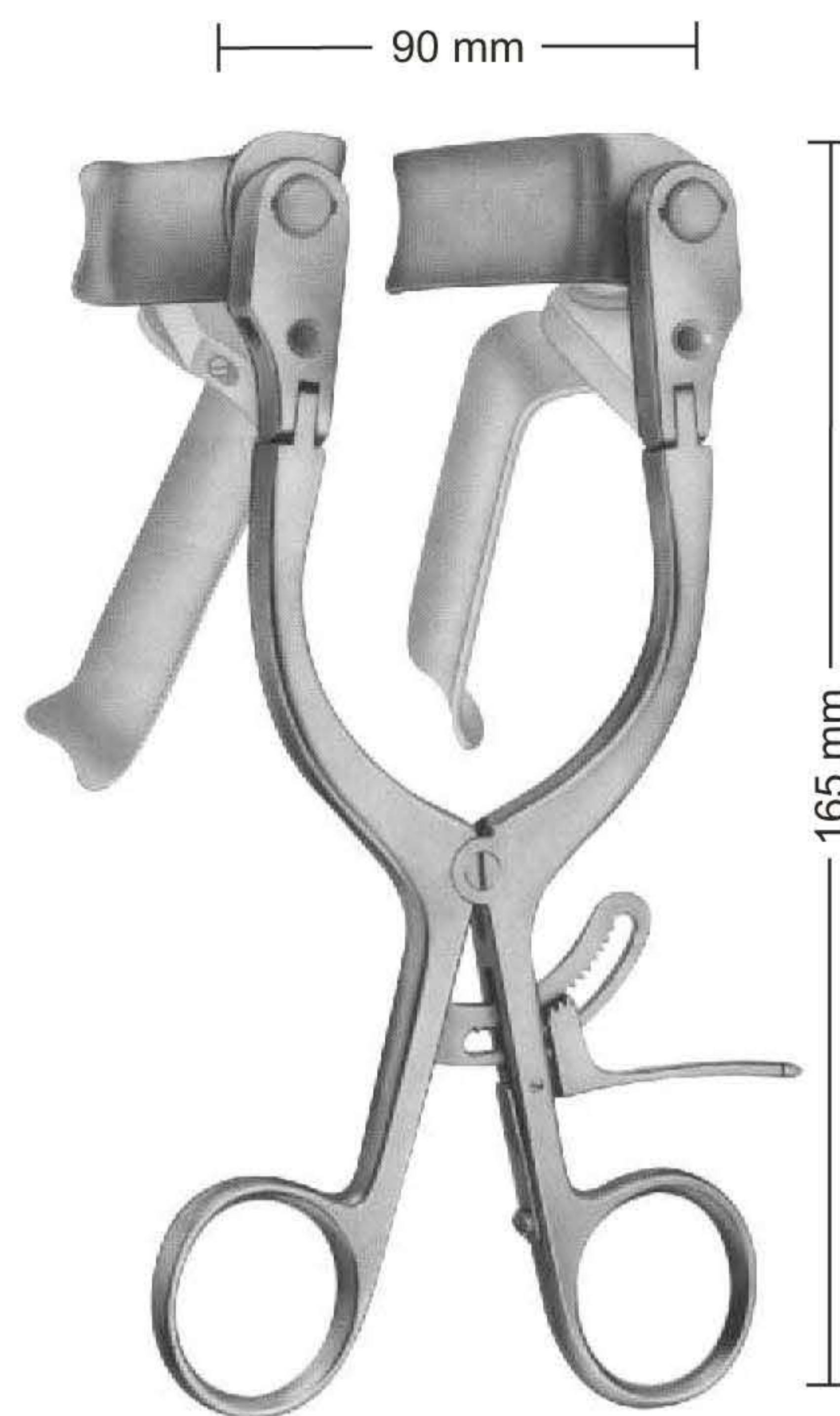

UG-1044  
CASPAR  
Counter retractor, adjustable,  
consisting of: 5 blades.

# Lamina Spreaders

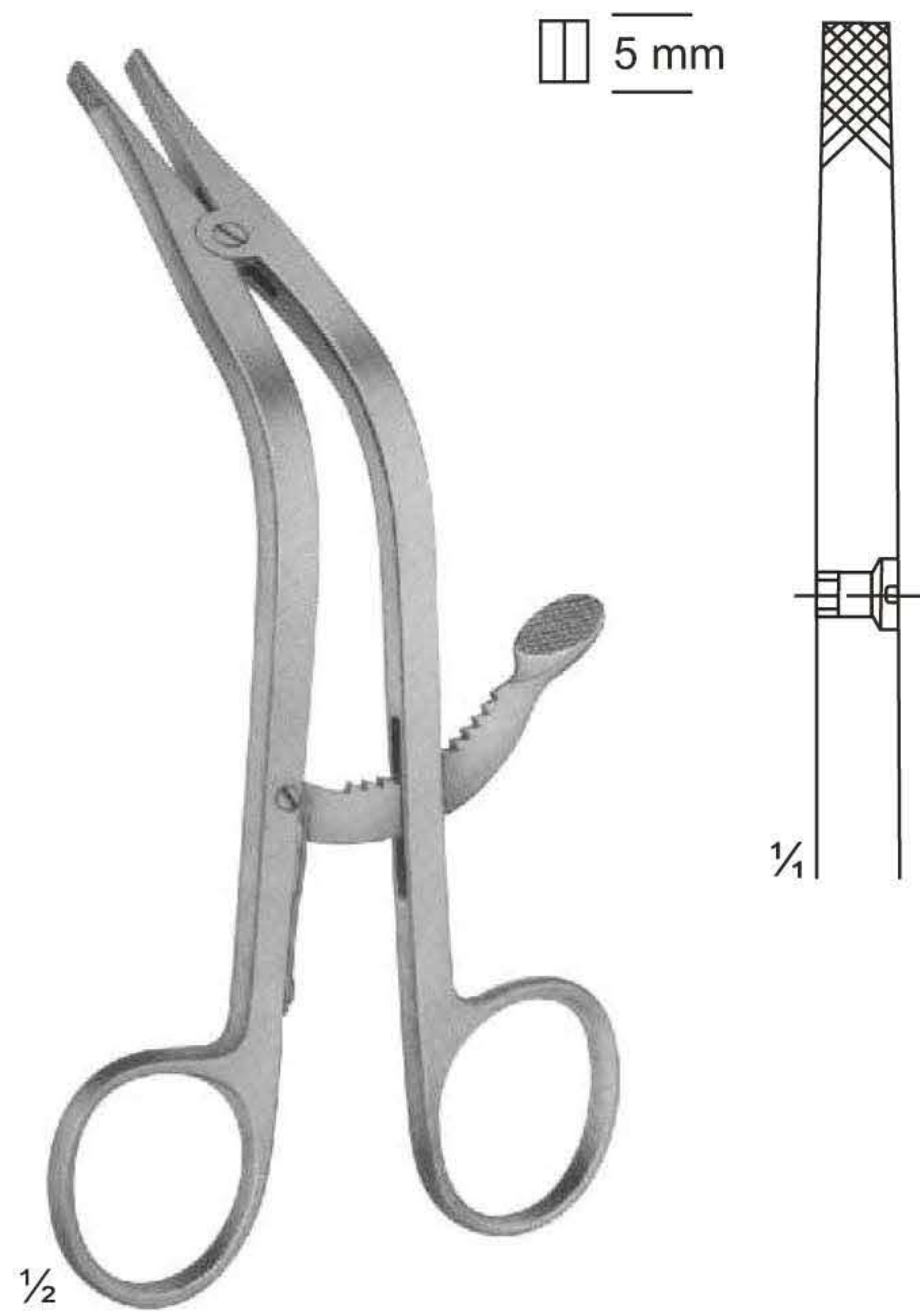

UG-1051  
CLOWARD  
155 mm



UG-1052  
CLOWARD  
135 mm

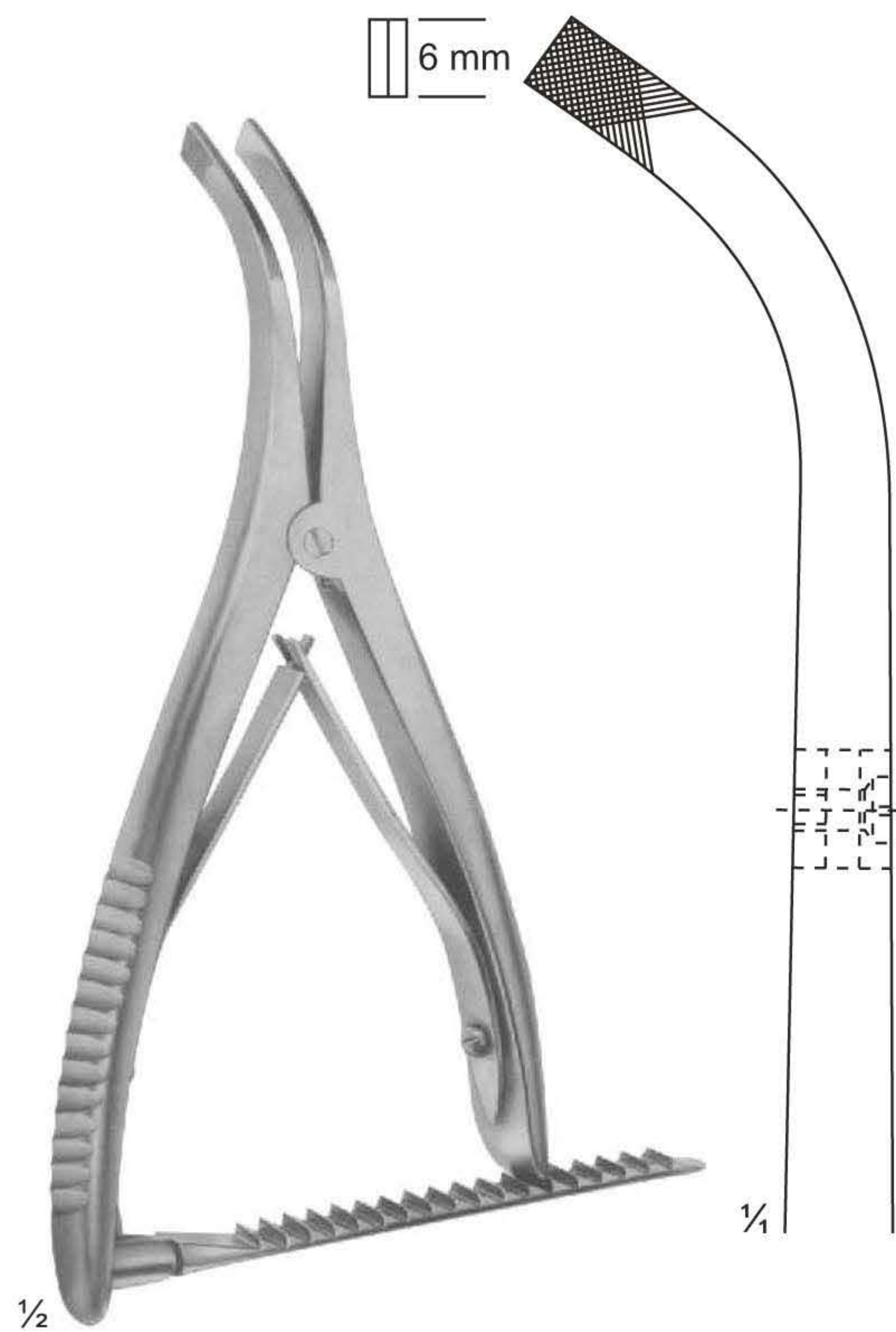

UG-1054  
INGE  
170 mm

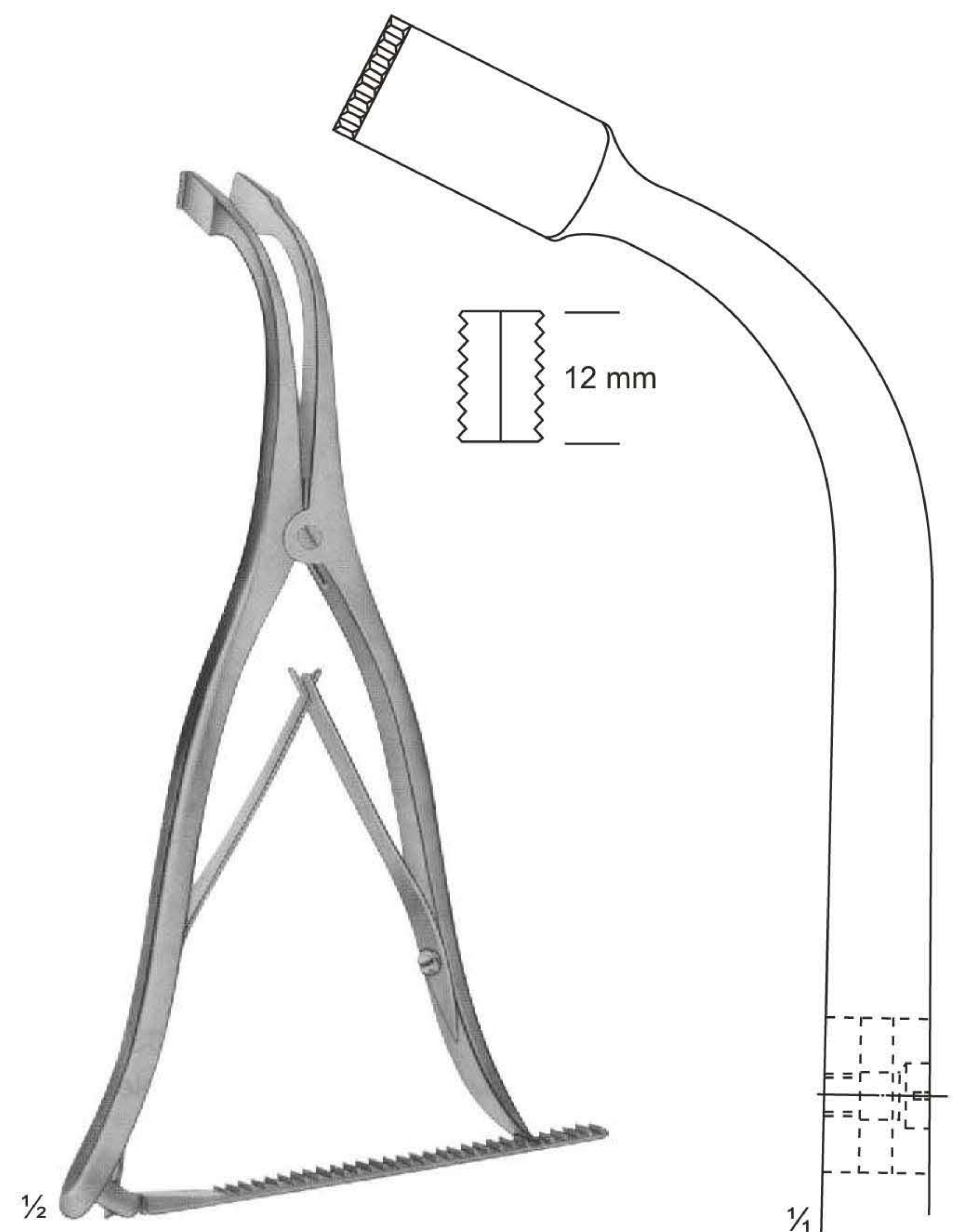

UG-1055  
INGE  
275 mm

# Abdominal Retractors

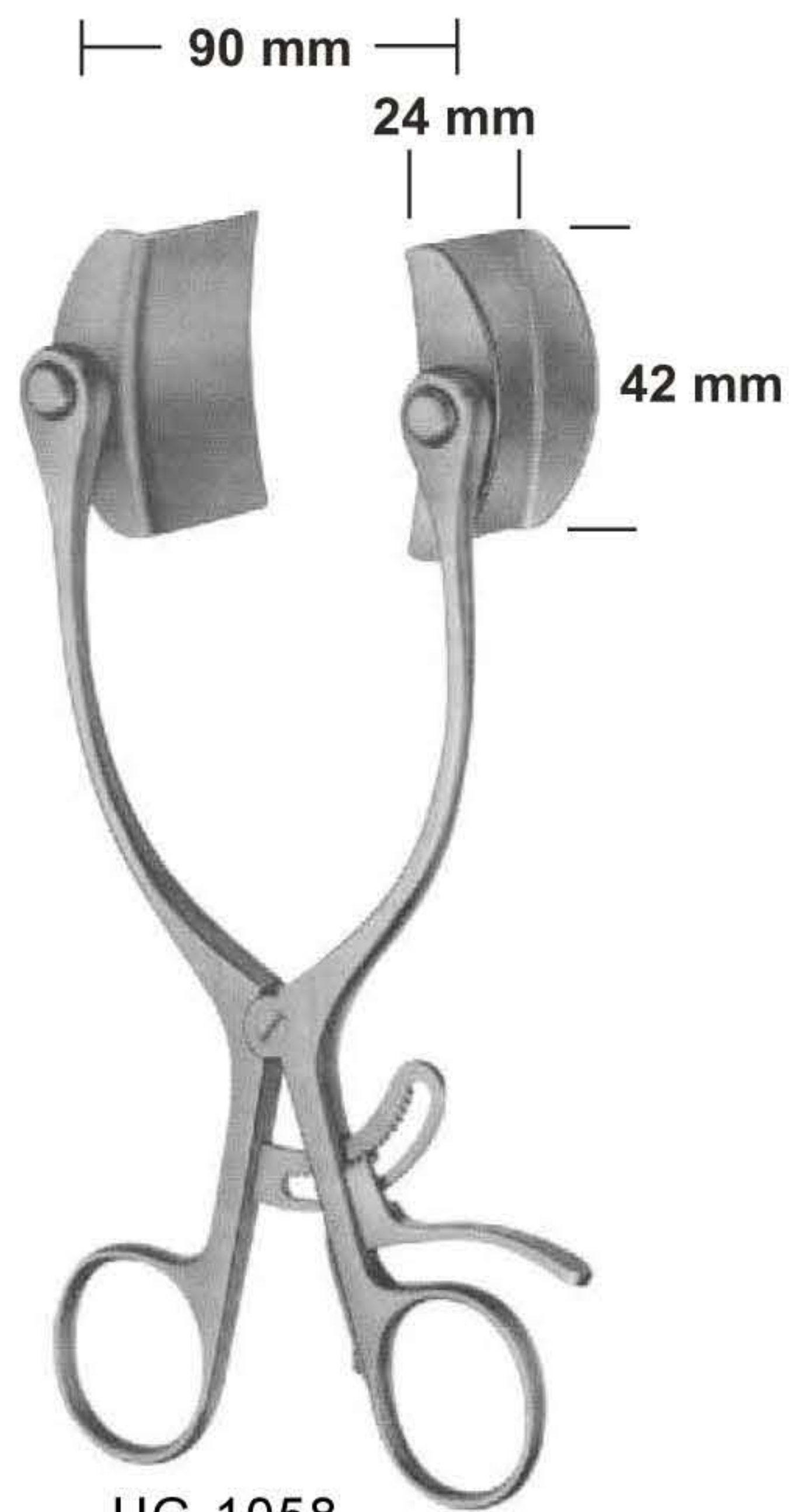

UG-1058  
BABY-COLLIN  
with 2 pair of blades

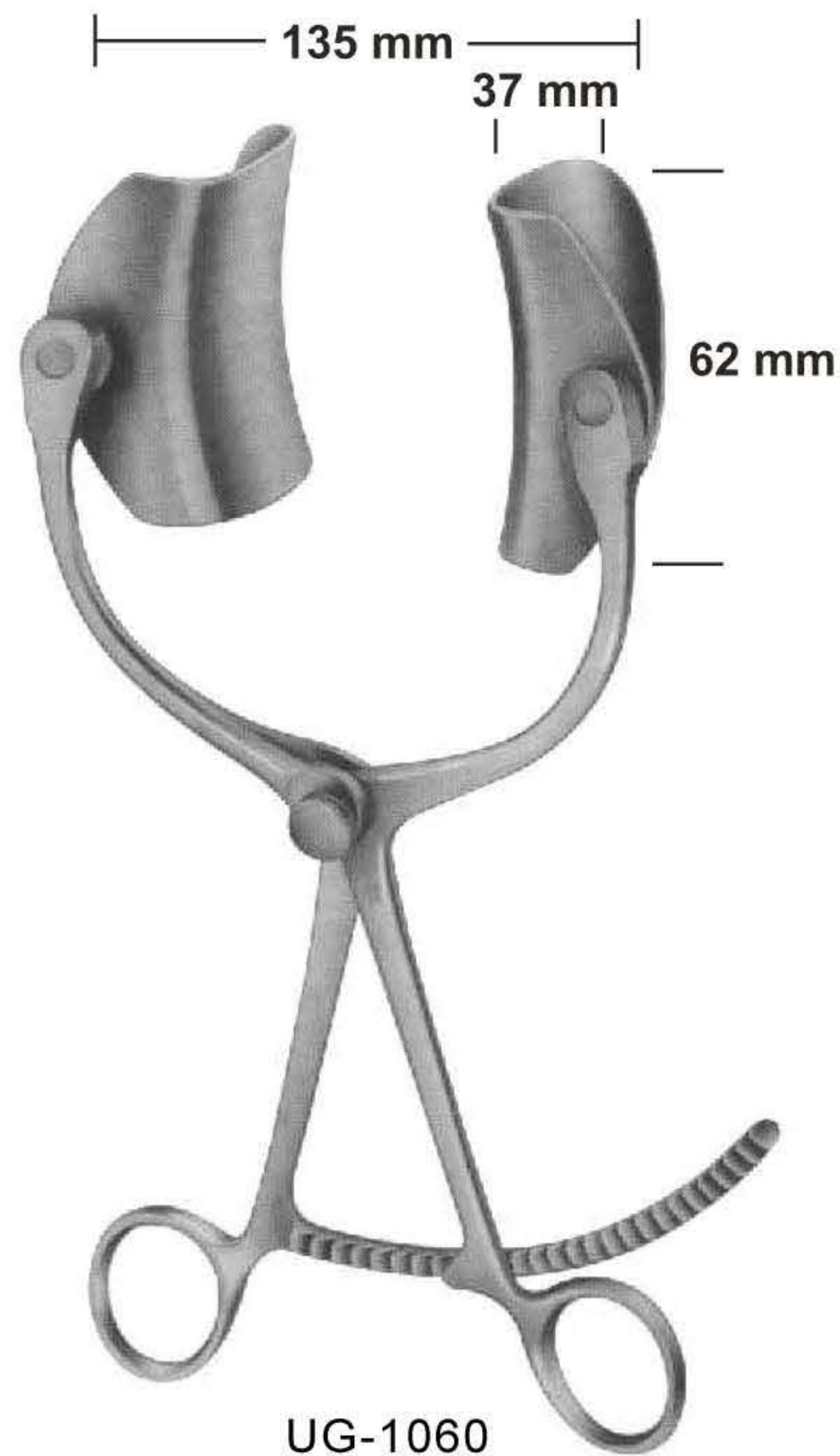

UG-1060  
COLLIN  
complete



UG-1063  
COLLIN  
complete



UG-1067  
RICARD  
complete



UG-1069  
HOLZBACH  
Complete



# Abdominal Baldes

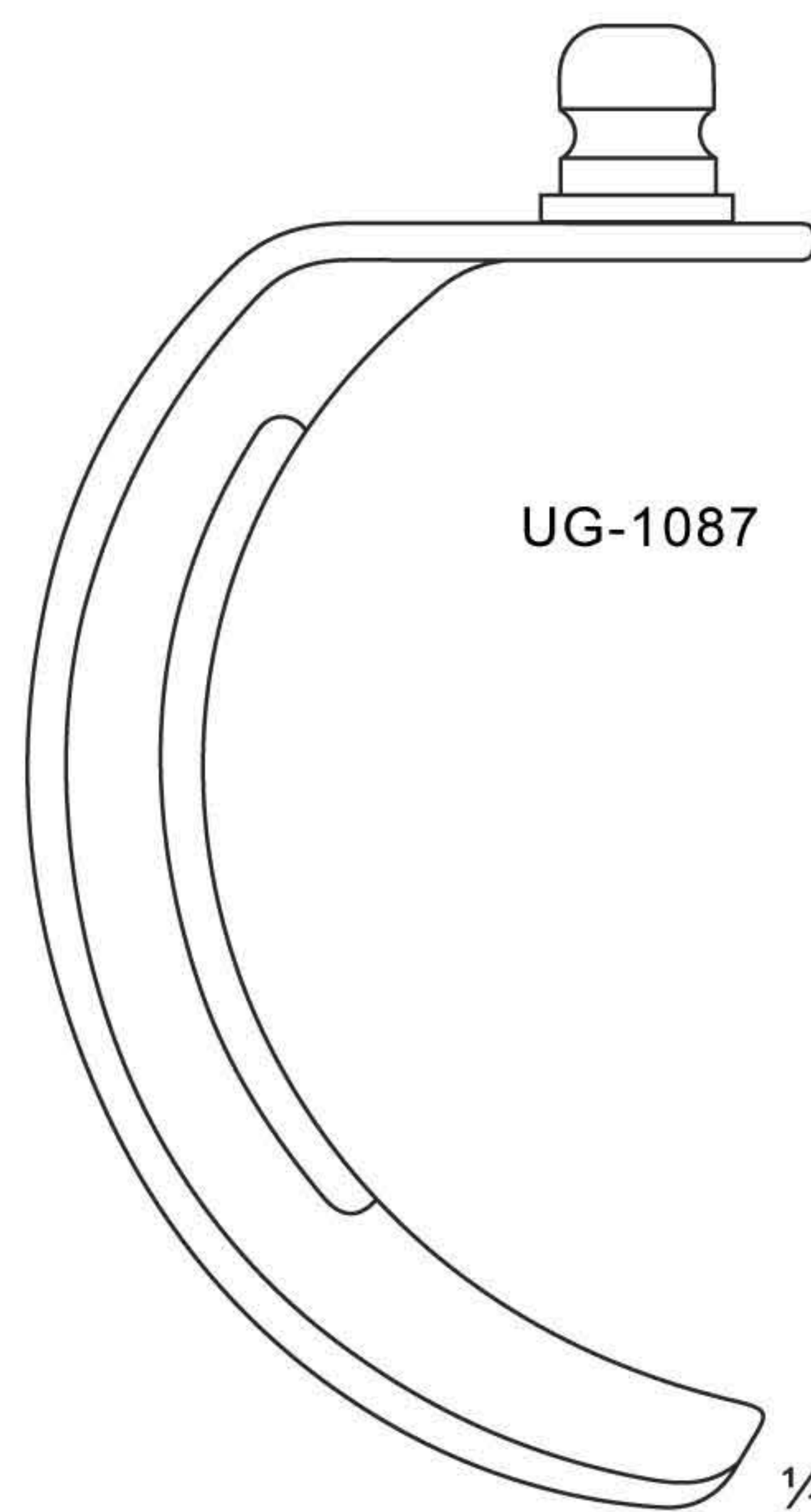
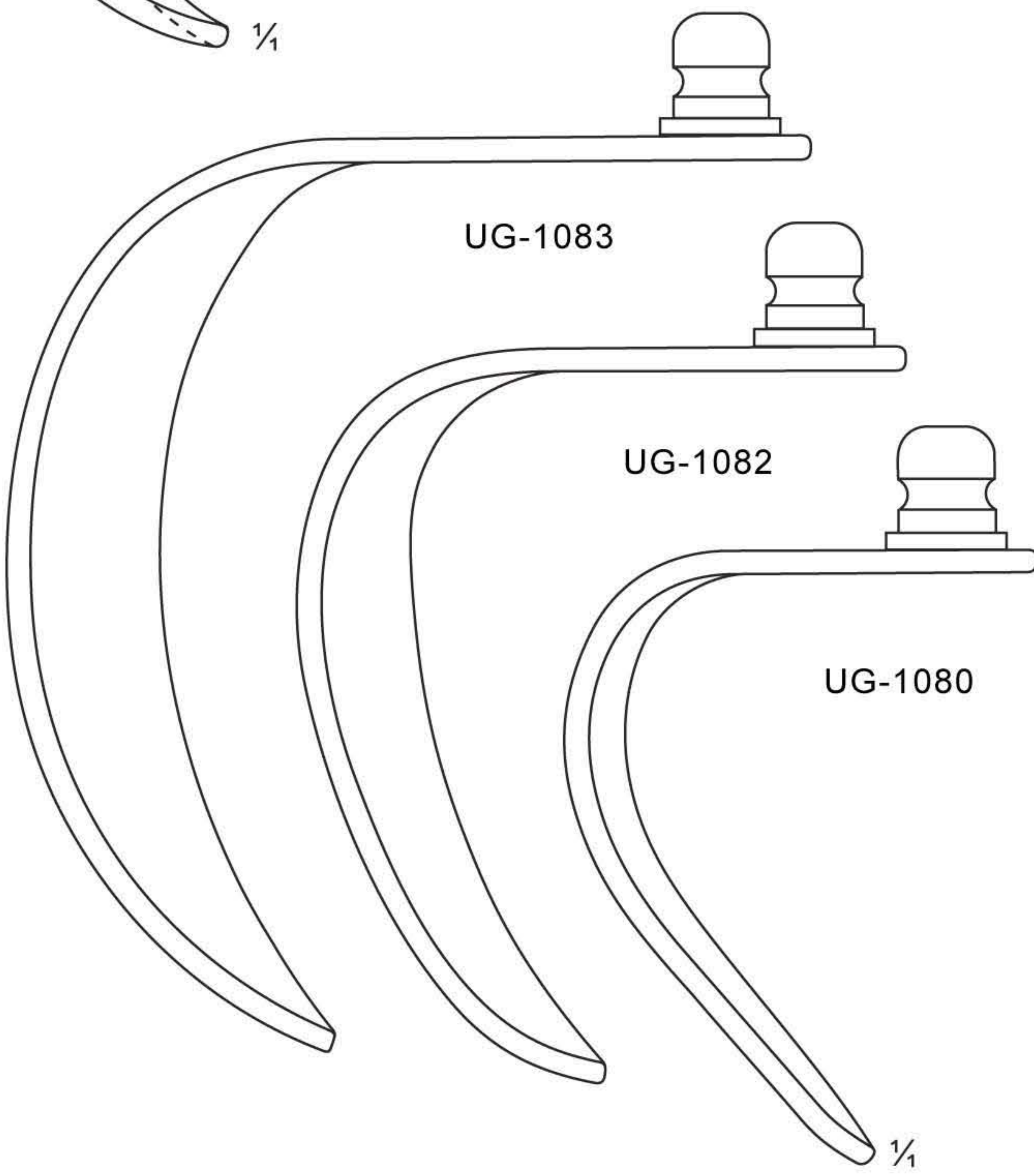
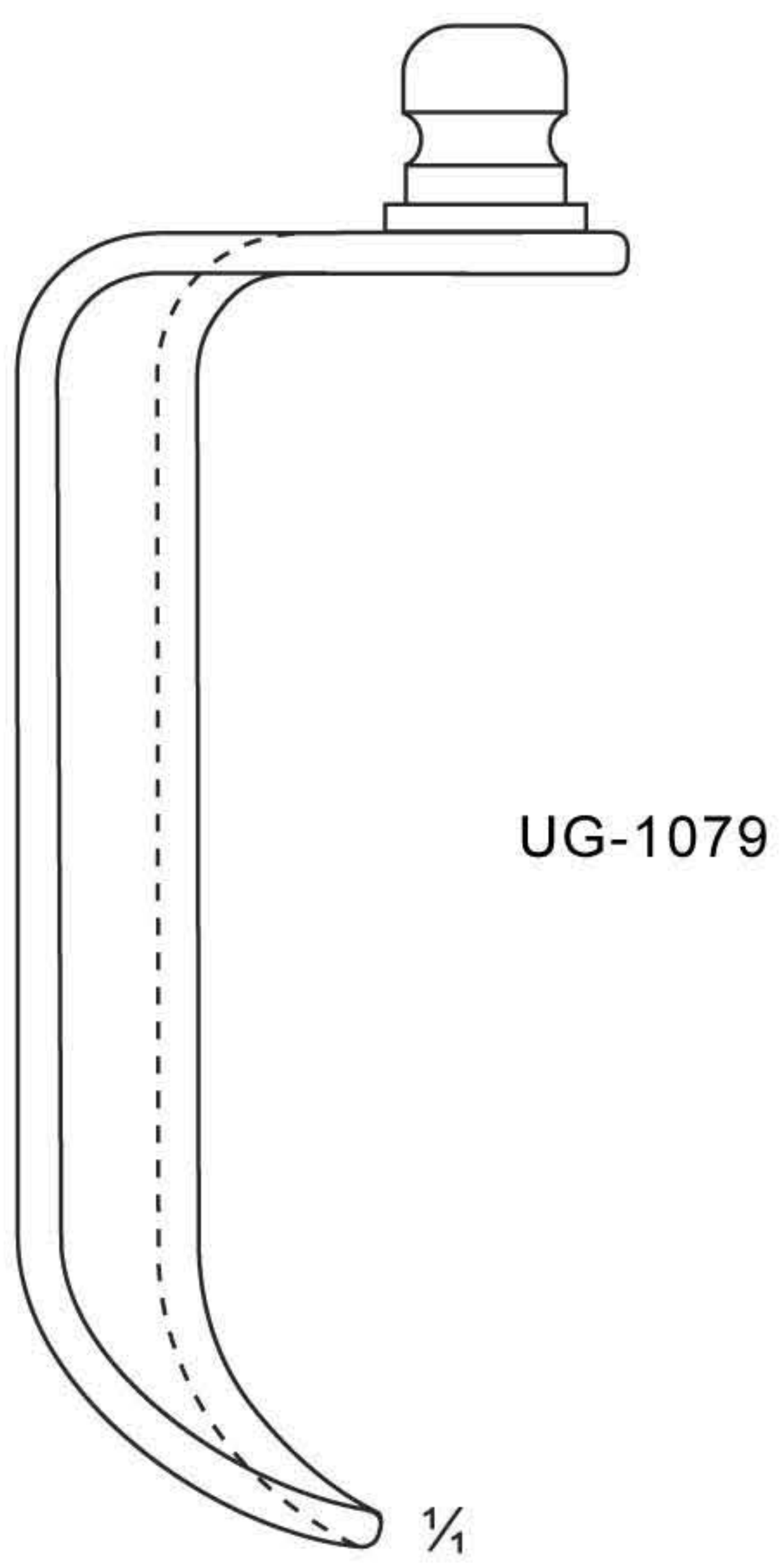
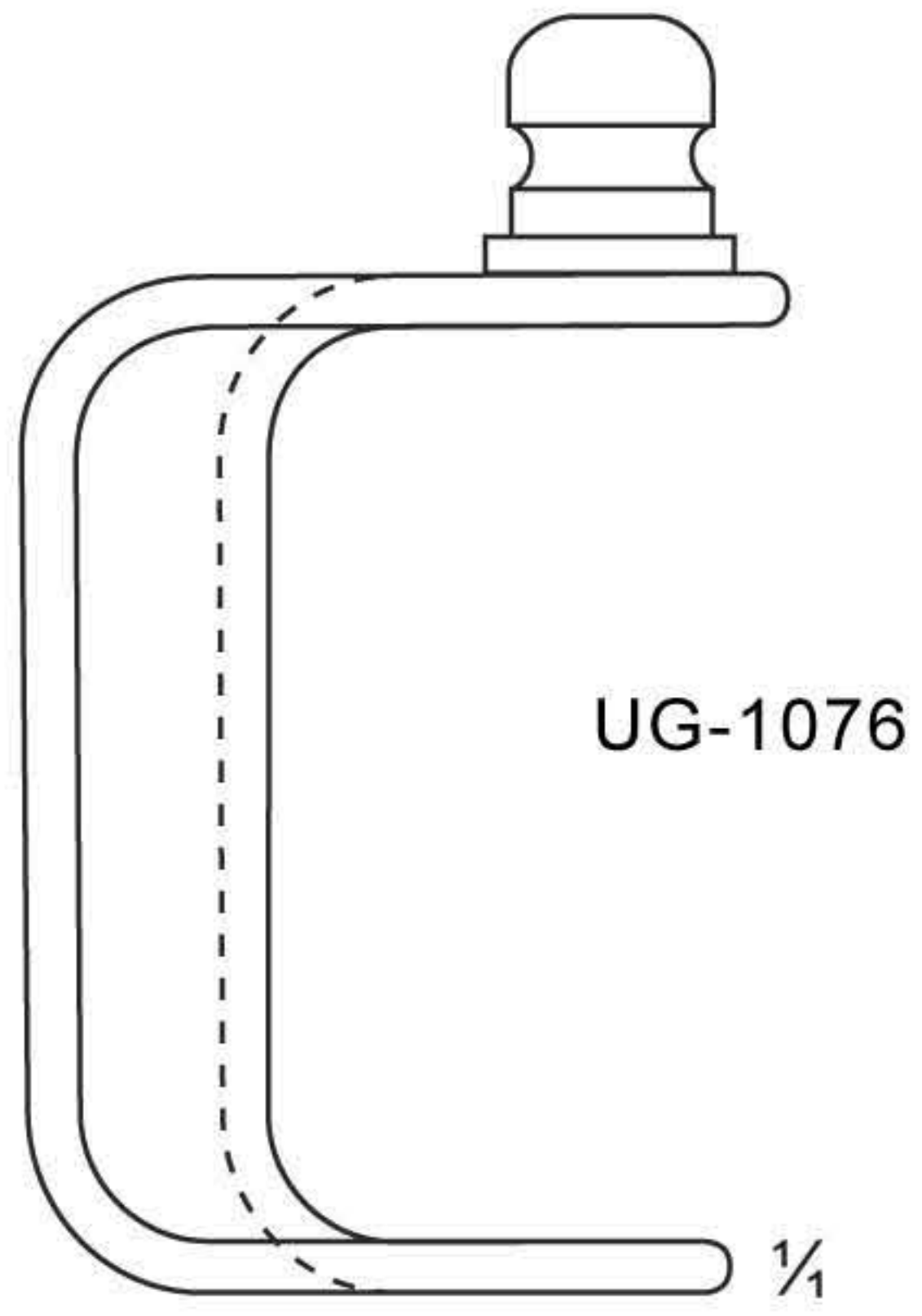

# Abdominal Retractors

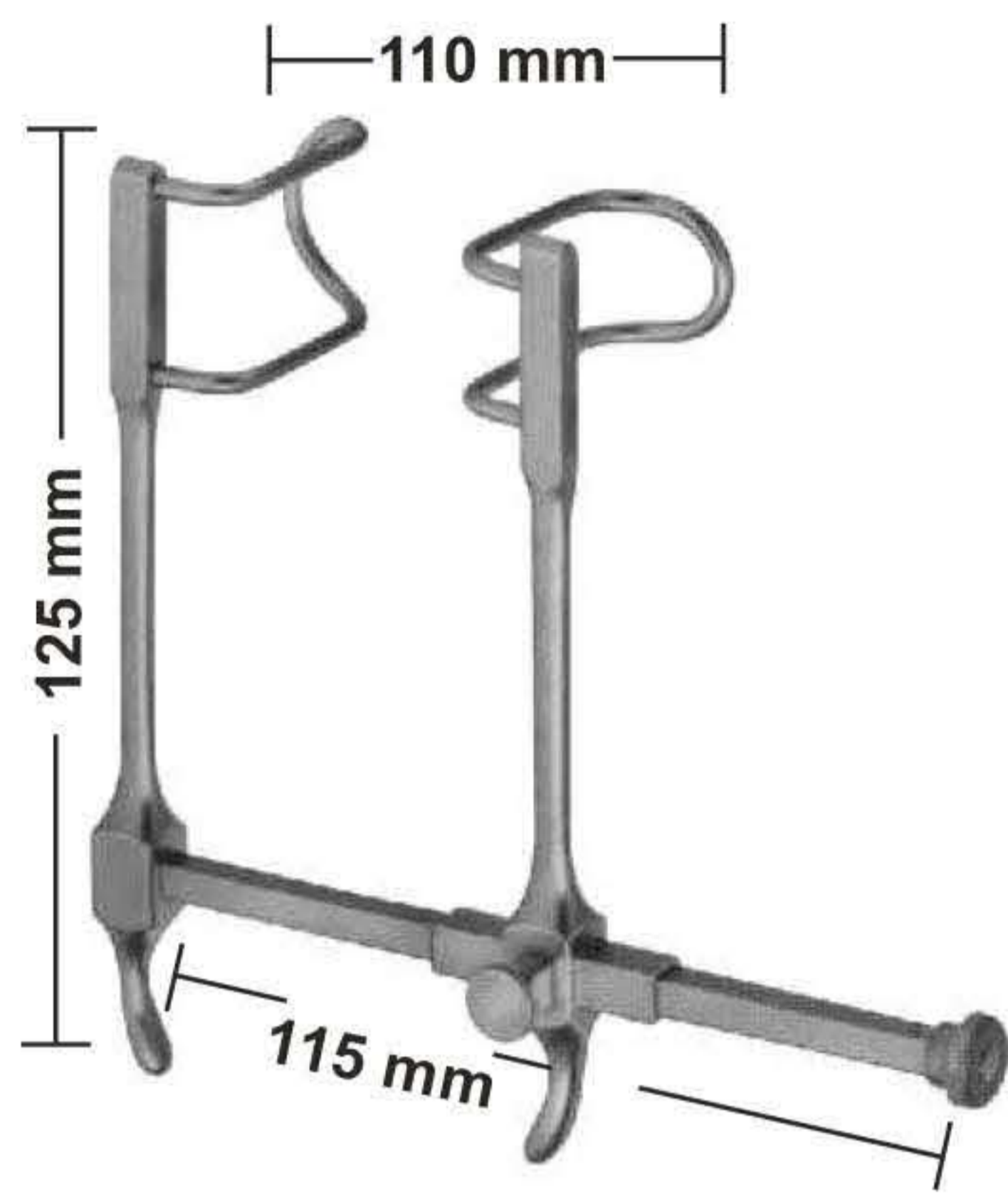

UG-1090  
GOSSET  
Blades:38 mm deep

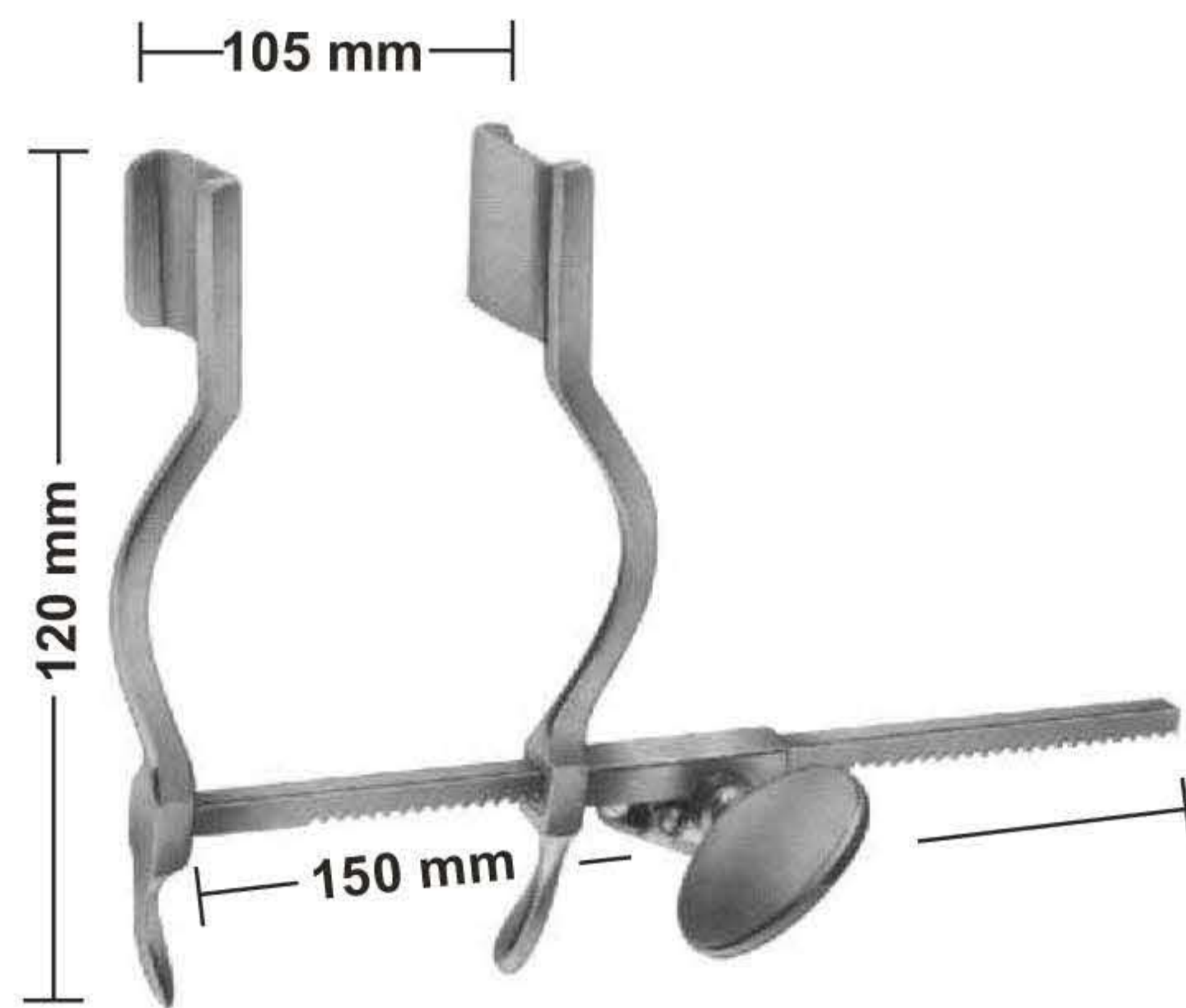

UG-1092  
HERTZLER  
Blades 20 X 25 mm

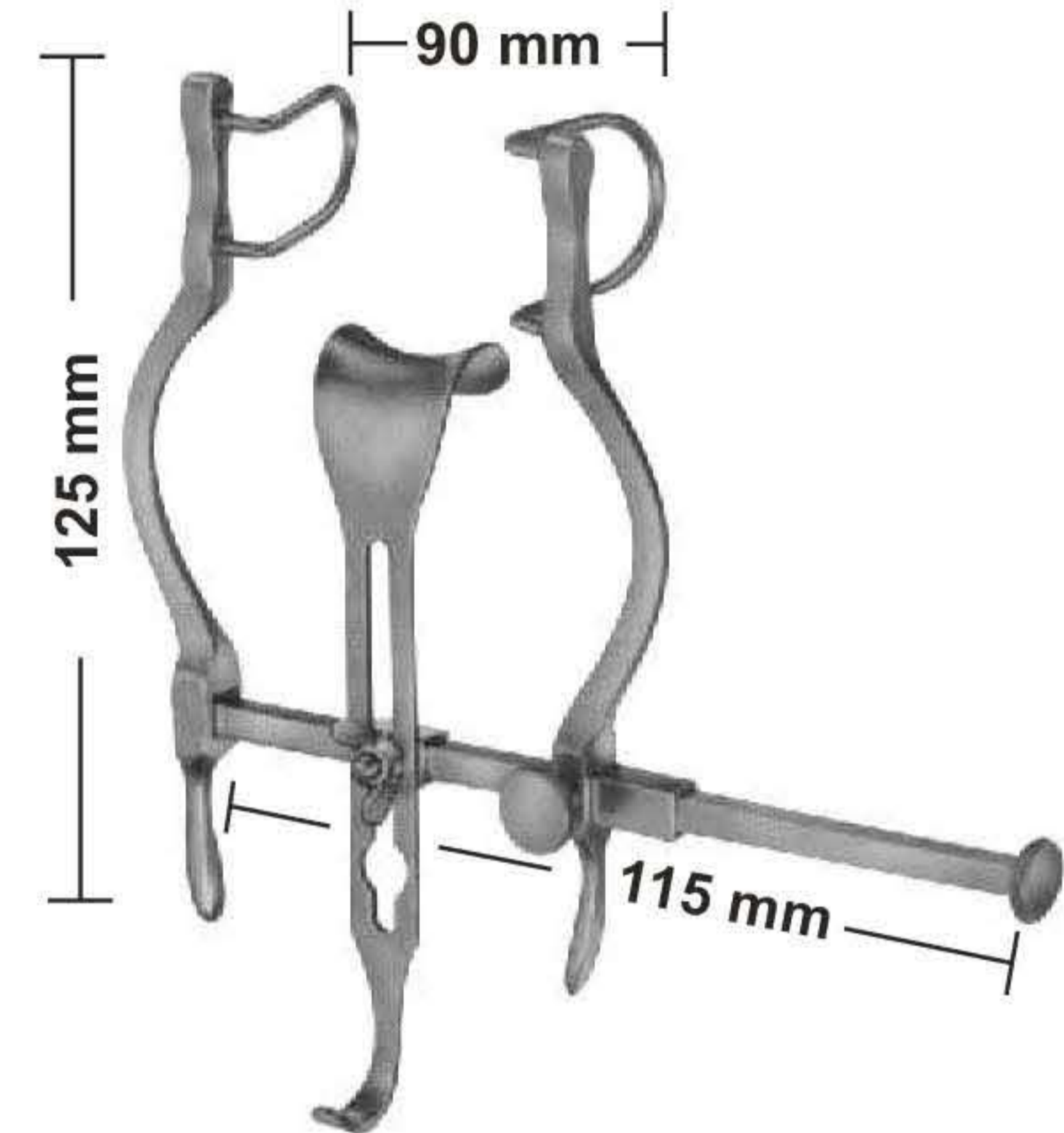

UG-1094  
BALFOUR-BABY  
Lateral blades 27 mm deep  
Center blade 21x24 mm

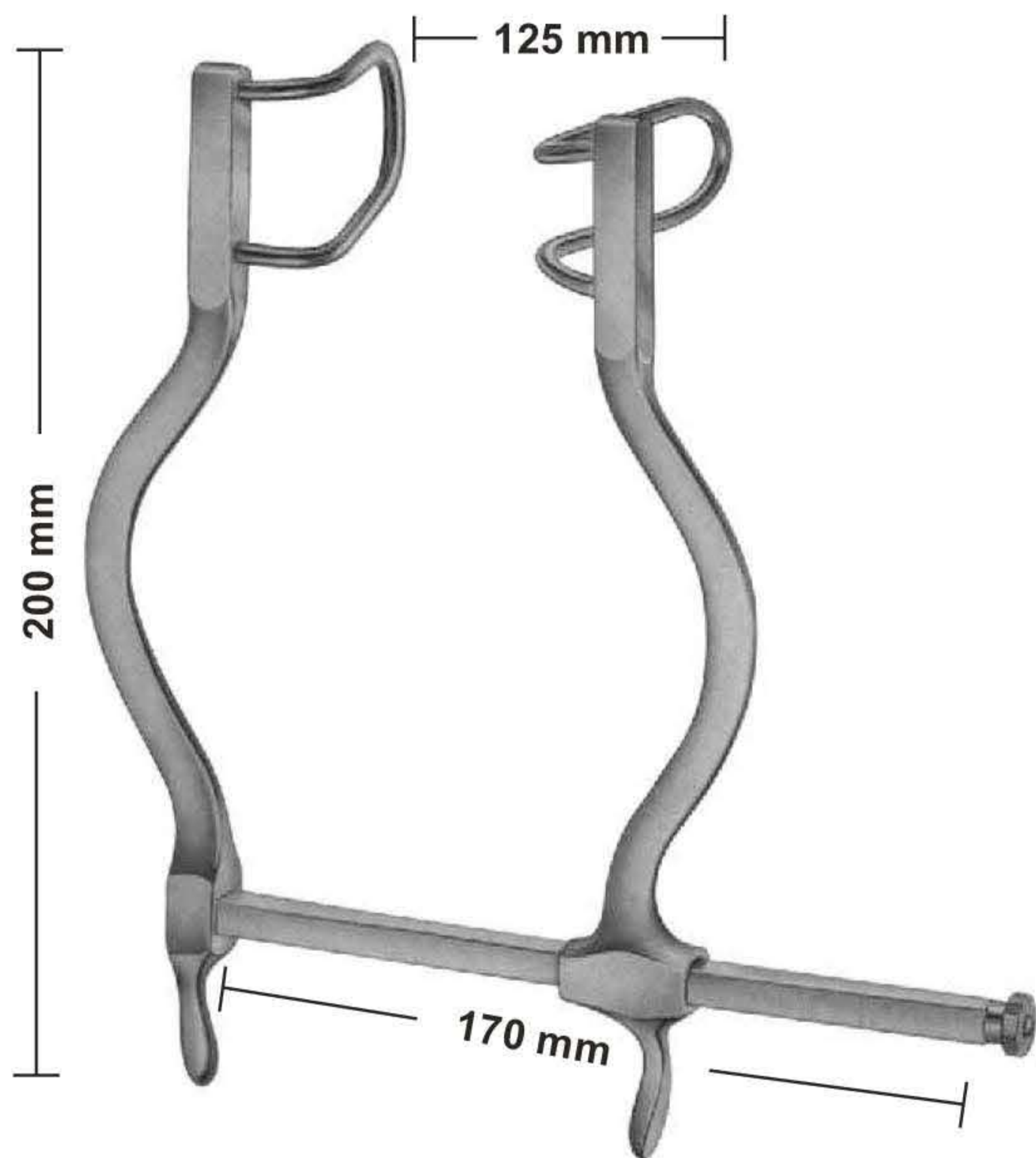

UG-1096  
GOSSET  
Blades:55mm deep

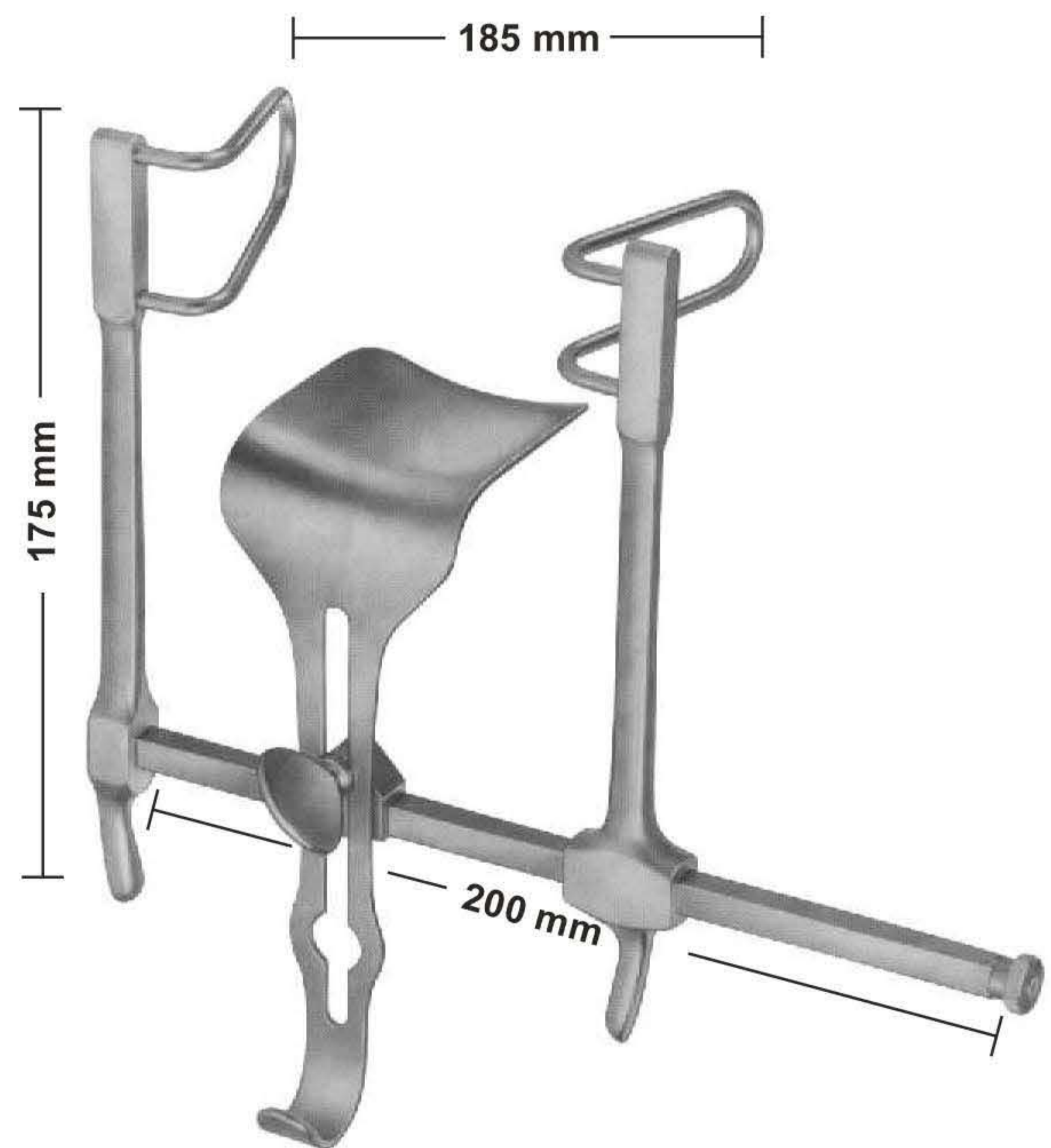

UG-1098  
GOSSET  
Lateral blades 58 mm deep  
Center blade 59 x 57 mm

# Abdominal Retractors

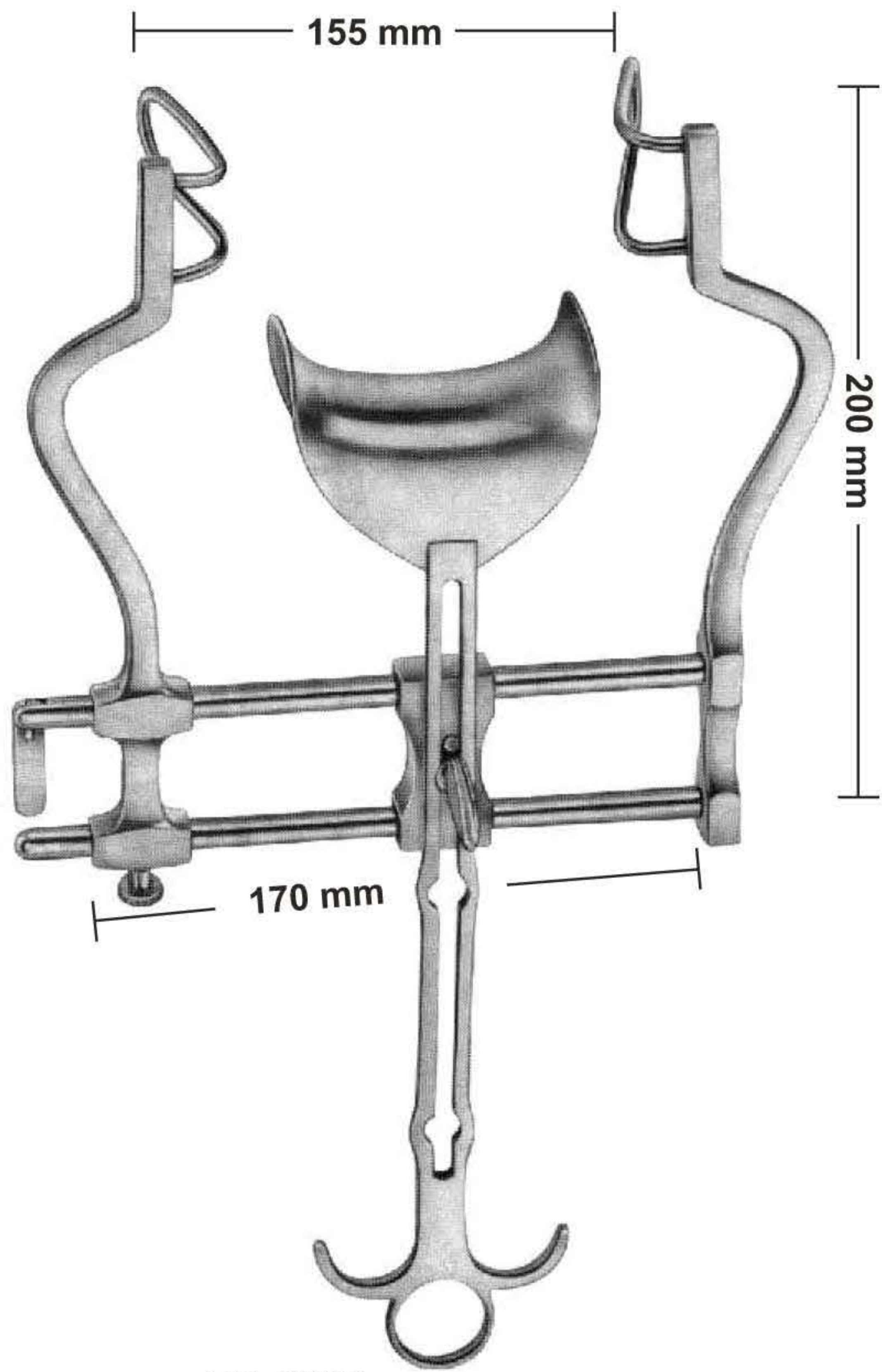

UG-1099  
BALFOUR  
Lateral blades 60 mm deep  
Center blade 47 x 80 mm

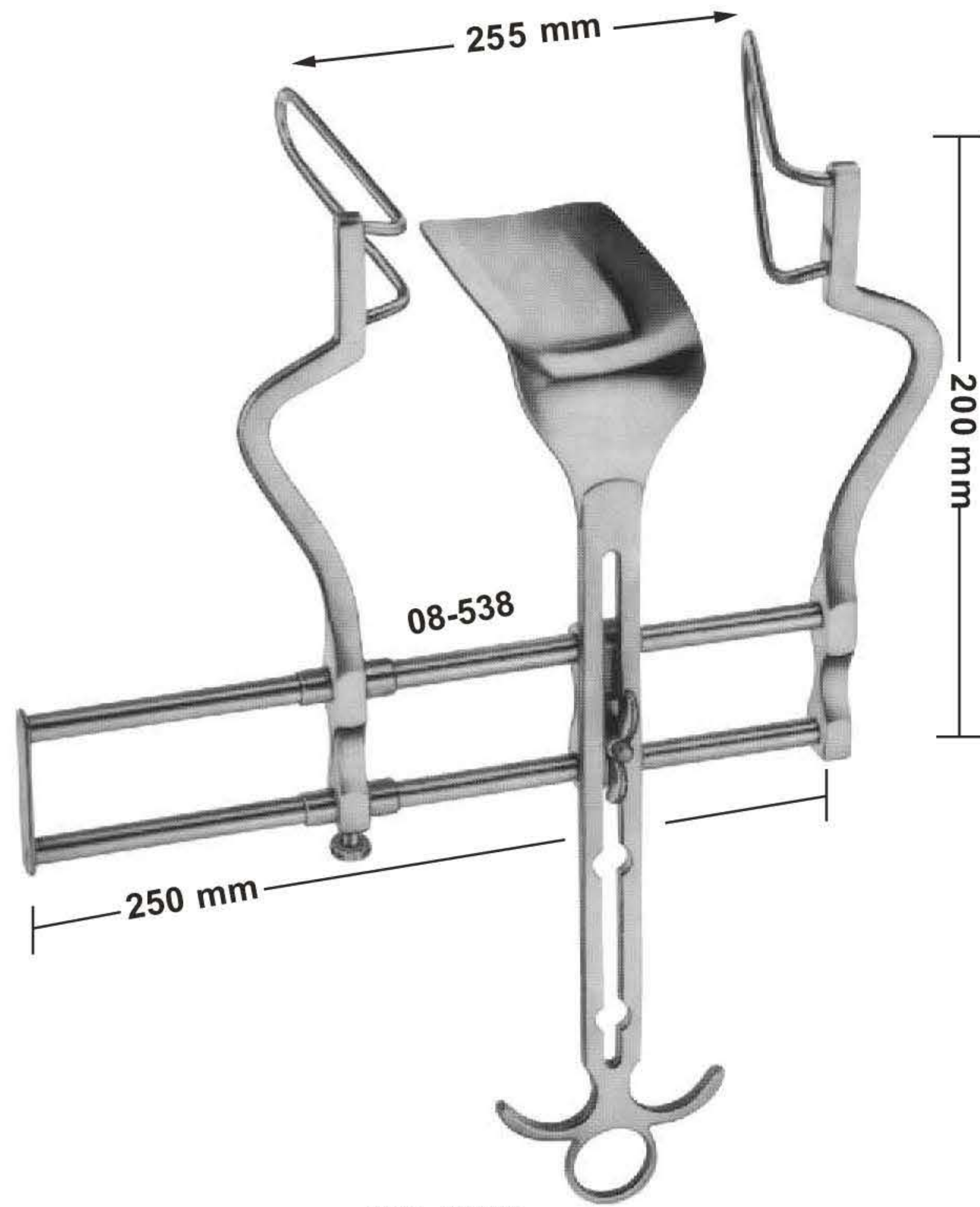

UG-1100  
BALFOUR  
Lateral blades 105 mm deep  
Center blade 107x 59 mm

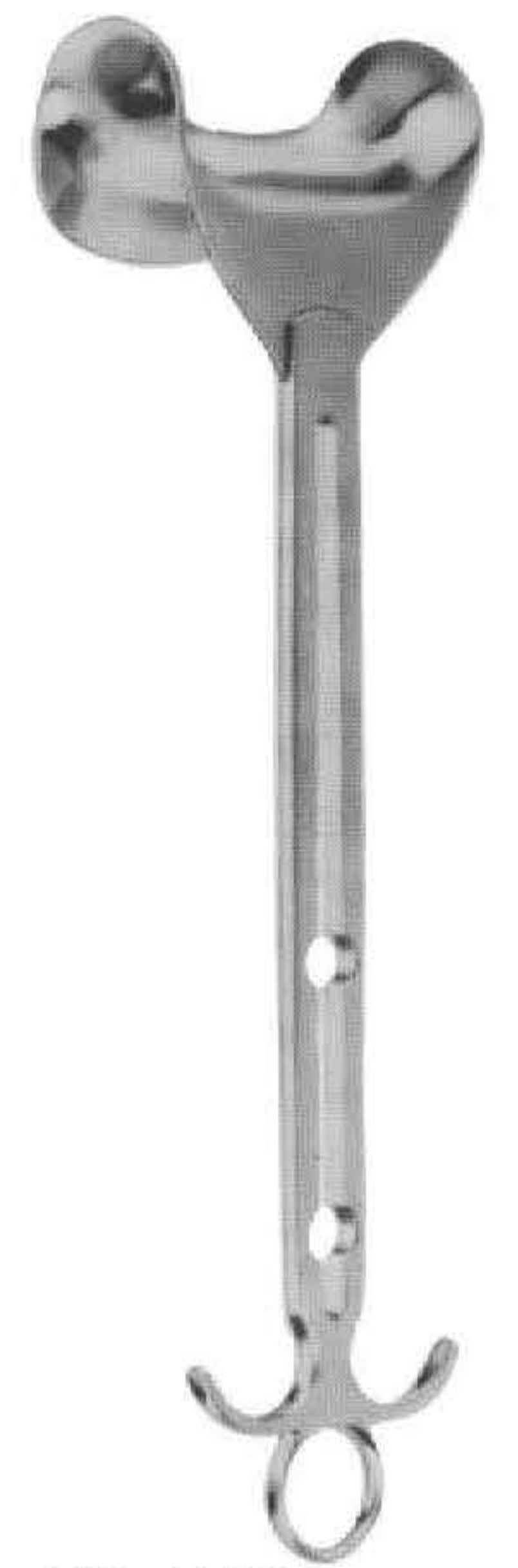

UG-1103  
Center blade only  
54x80 mm

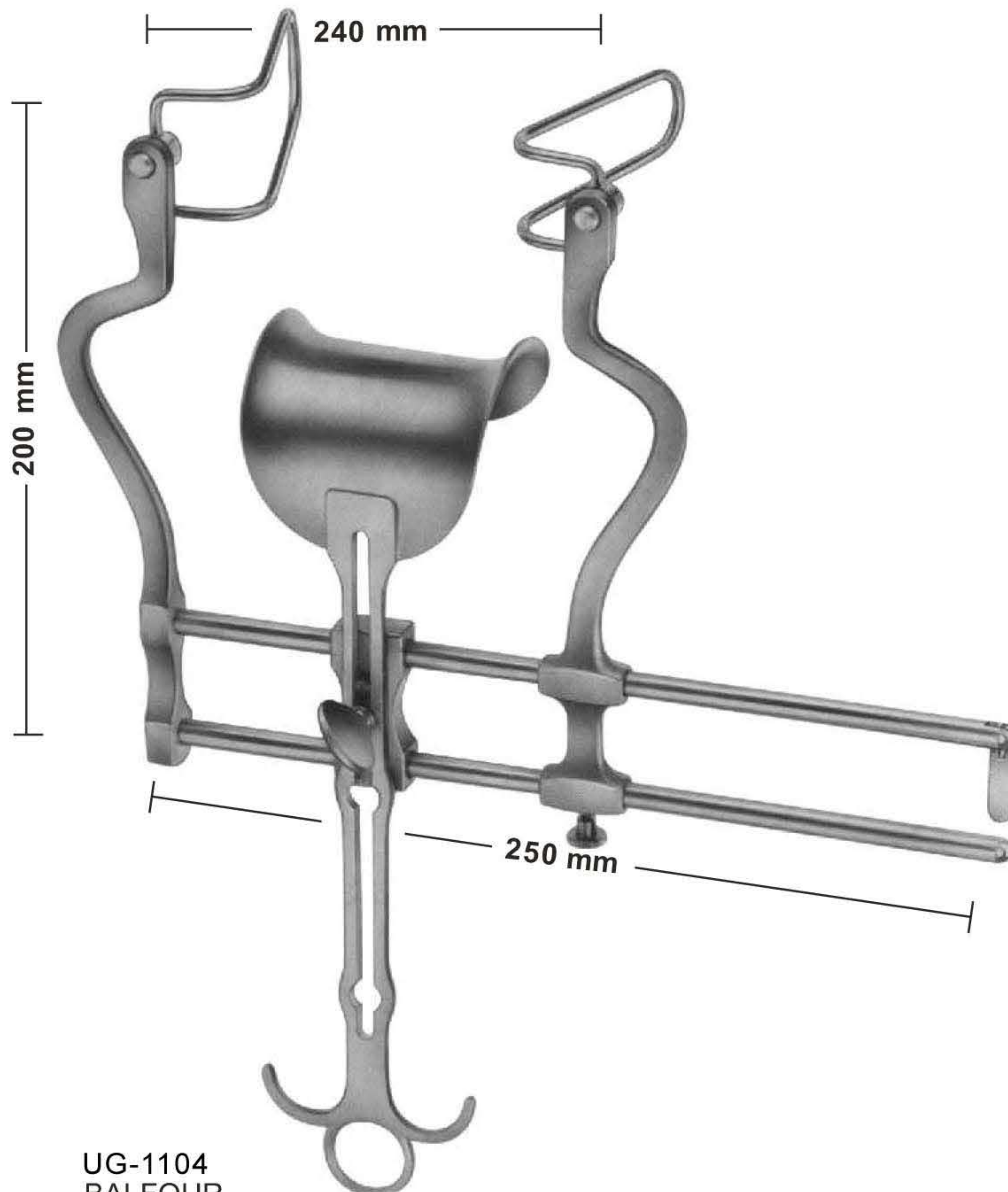

UG-1104  
BALFOUR

Spreader only	<b>08-540</b>	<b>08-541</b>	<b>08-542</b>	<b>08-543</b>
Lateral blades	50 mm	60 mm	75 mm	90 mm
Center blade	47 x 80 mm	62x76 mm	80x80 mm	80x80 mm

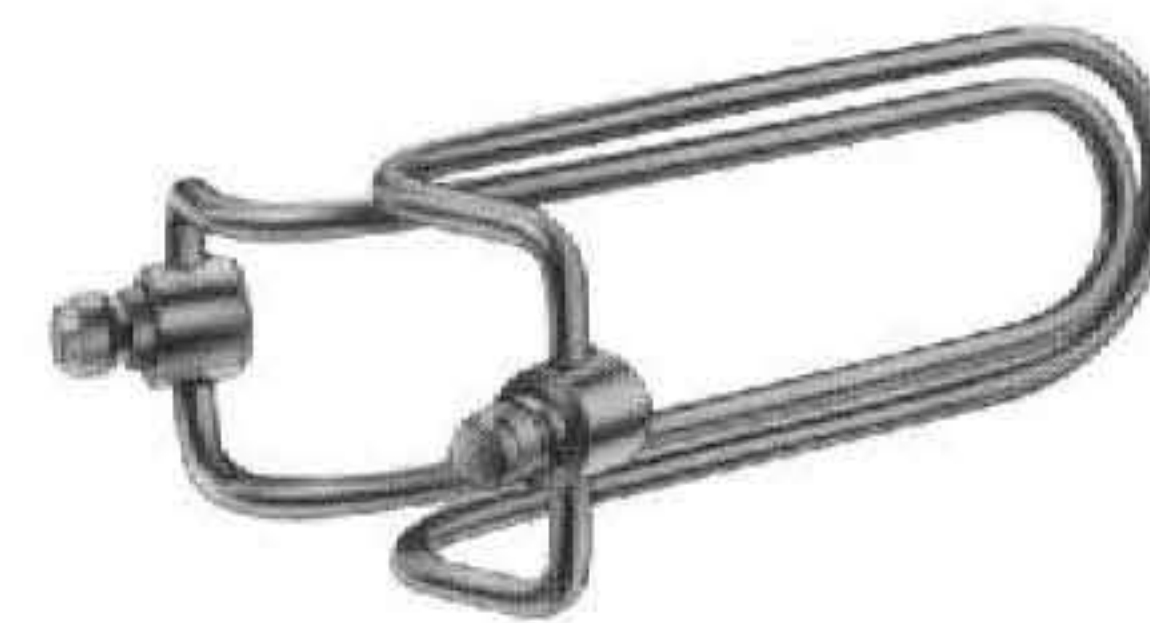

Sales Unit of blades:PR = pair

- Lateral blades
- 08-544** 50 mm deep
- 08-545** 60 mm deep
- 08-546** 75 mm deep
- 08-547** 90 mm deep

# Abdominal Retractors

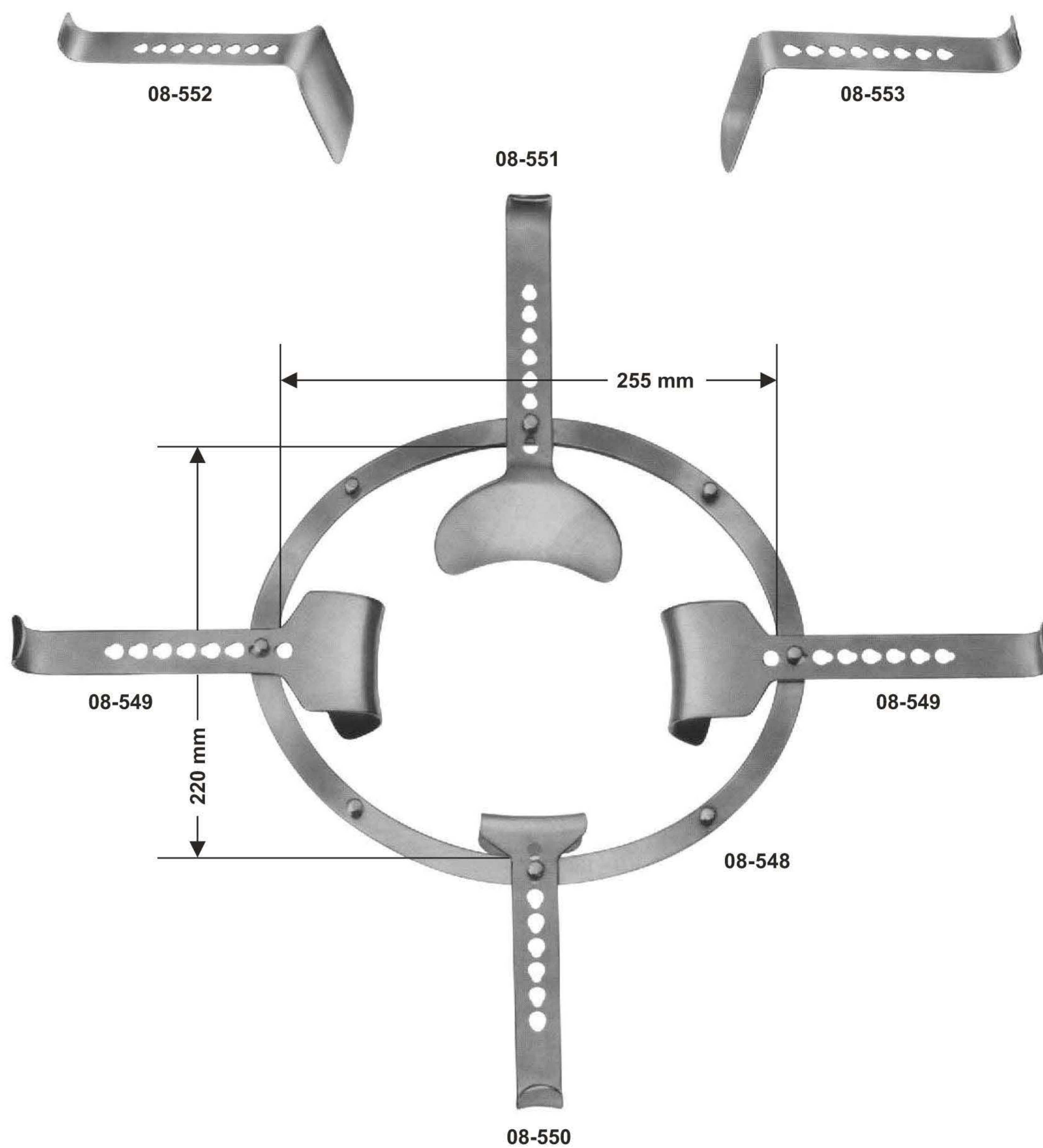

UG-1110

SEMM

consisting of:

- 08-548** 1 frame 225 x 220 mm
- 08-549** 2 blades 46 x 64 mm
- 08-550** 1 blade 53 x 54 mm  
(for bladder)
- 08-551** 1 blade 82 x 97 mm  
(for intestine)
- 08-552** 1 blade 98 x 51 mm  
(for intestine)
- 08-553** 1 blade, narrow  
107 x 36 mm

# Abdominal Retractors

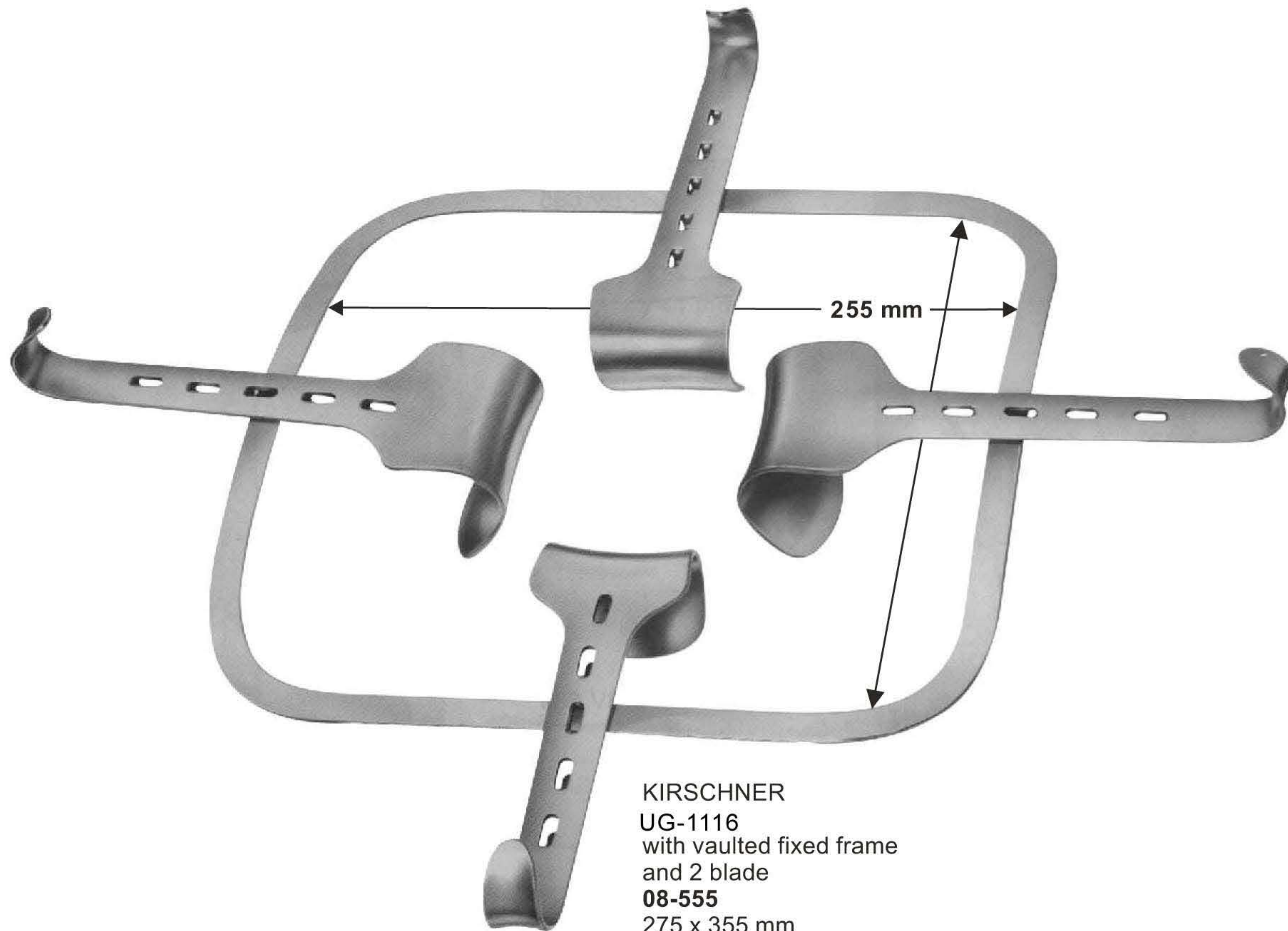

KIRSCHNER  
 UG-1116  
 with vaulted fixed frame  
 and 2 blade  
**08-555**  
 275 x 355 mm  
 Frame only, over-sized  
**08-556**  
 295 x 275 mm  
 Frame only



UG-1120  
 KIRSCHNER  
 64 x 80 mm



UG-1121  
 KIRSCHNER-BALFOUR  
 80x 82 mm



UG-1122  
 KIRSCHNER  
**08-559** 90x 69mm  
**08-560** 92x 95mm  
**08-561** 78x 58mm



UG-1124  
 KIRSCHNER  
**08-562** 108x42mm  
**08-563** 91x 55mm  
**08-564** 121x 55mm

# Intestinal and Tissue Grasping Forceps

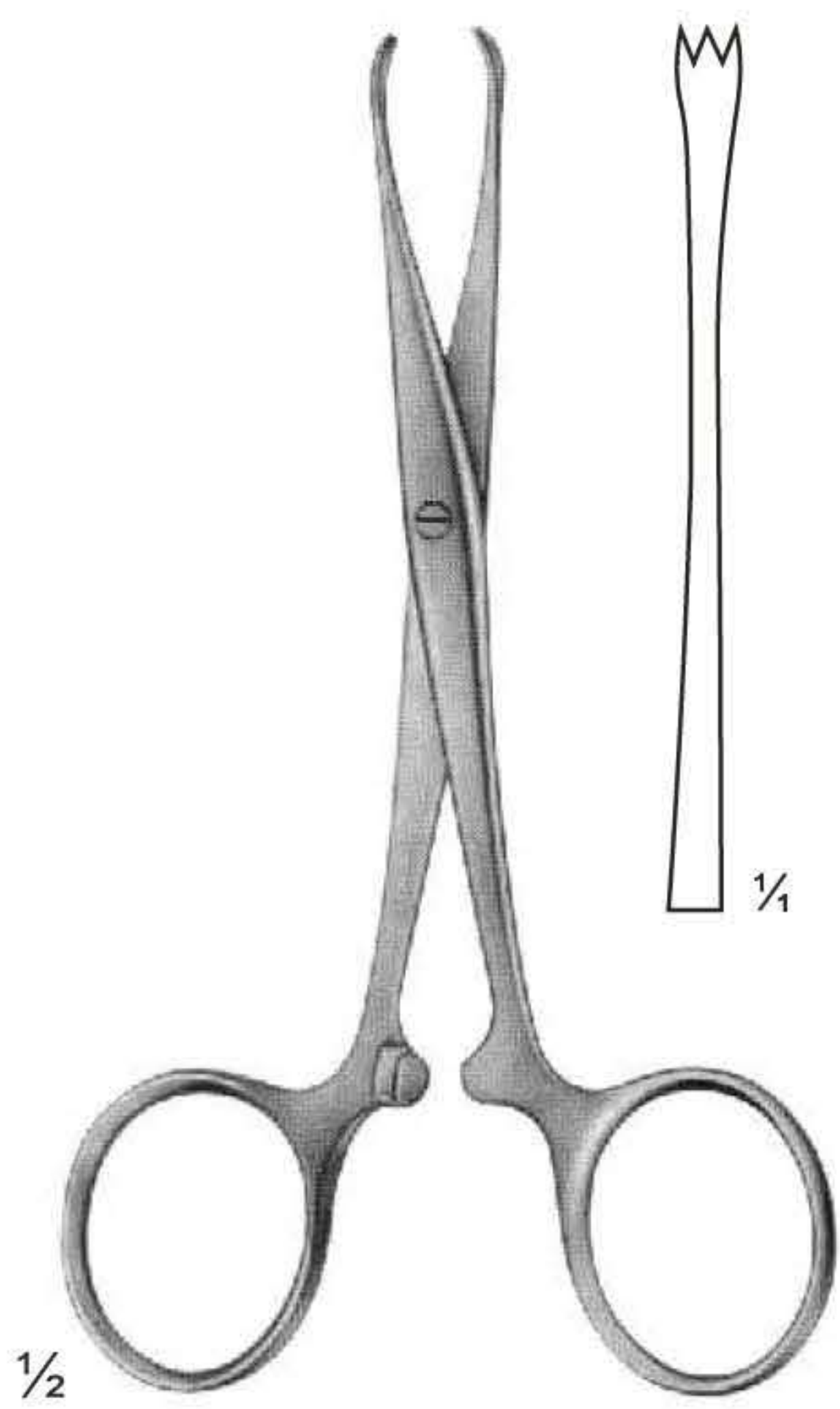

**UG-1127**  
**CHAPUT**  
 2 X 3 teeth, sharp  
 125 mm,

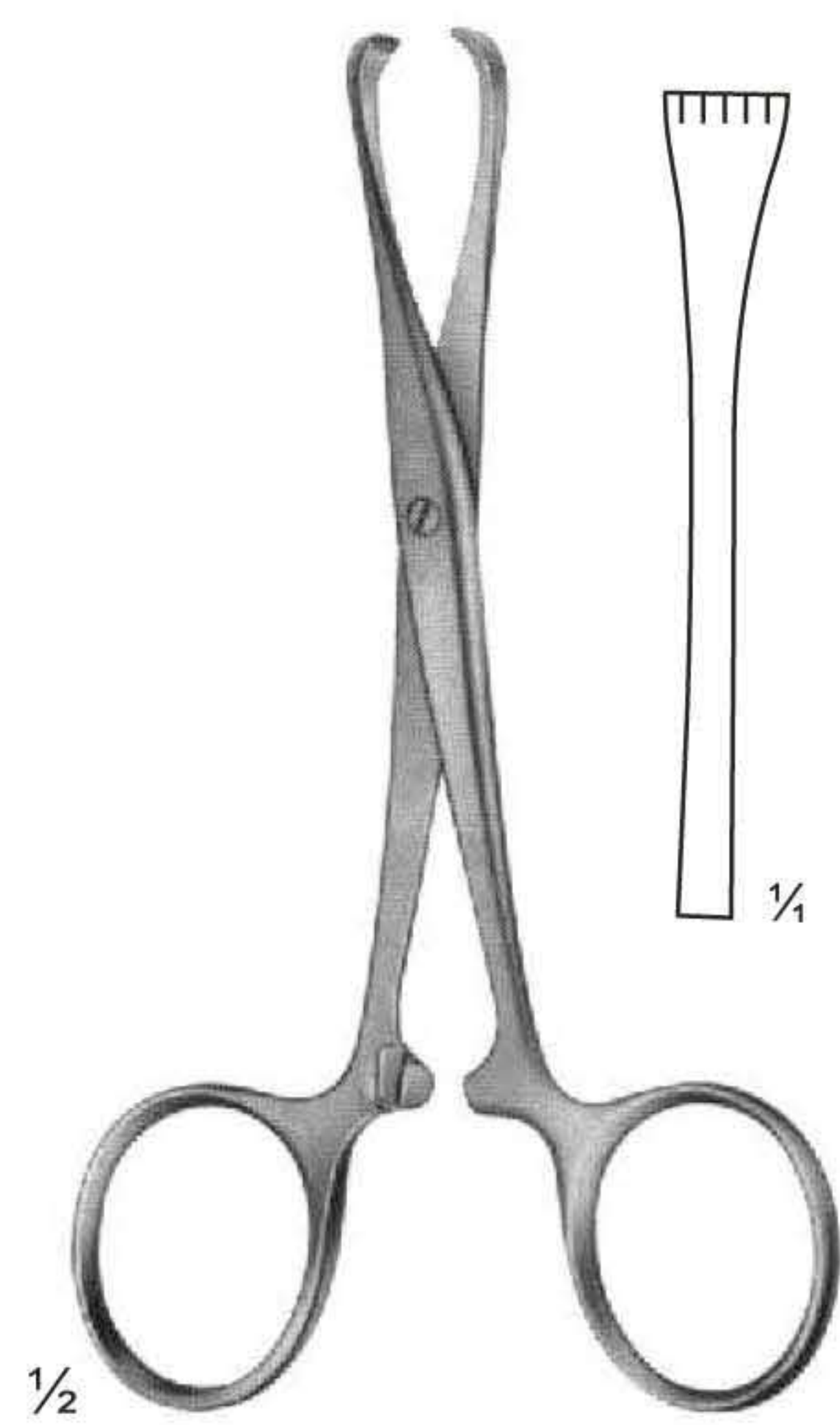

**UG-1128**  
**TUFFIER**  
 5 X 6 teeth, sharp  
 125 mm,

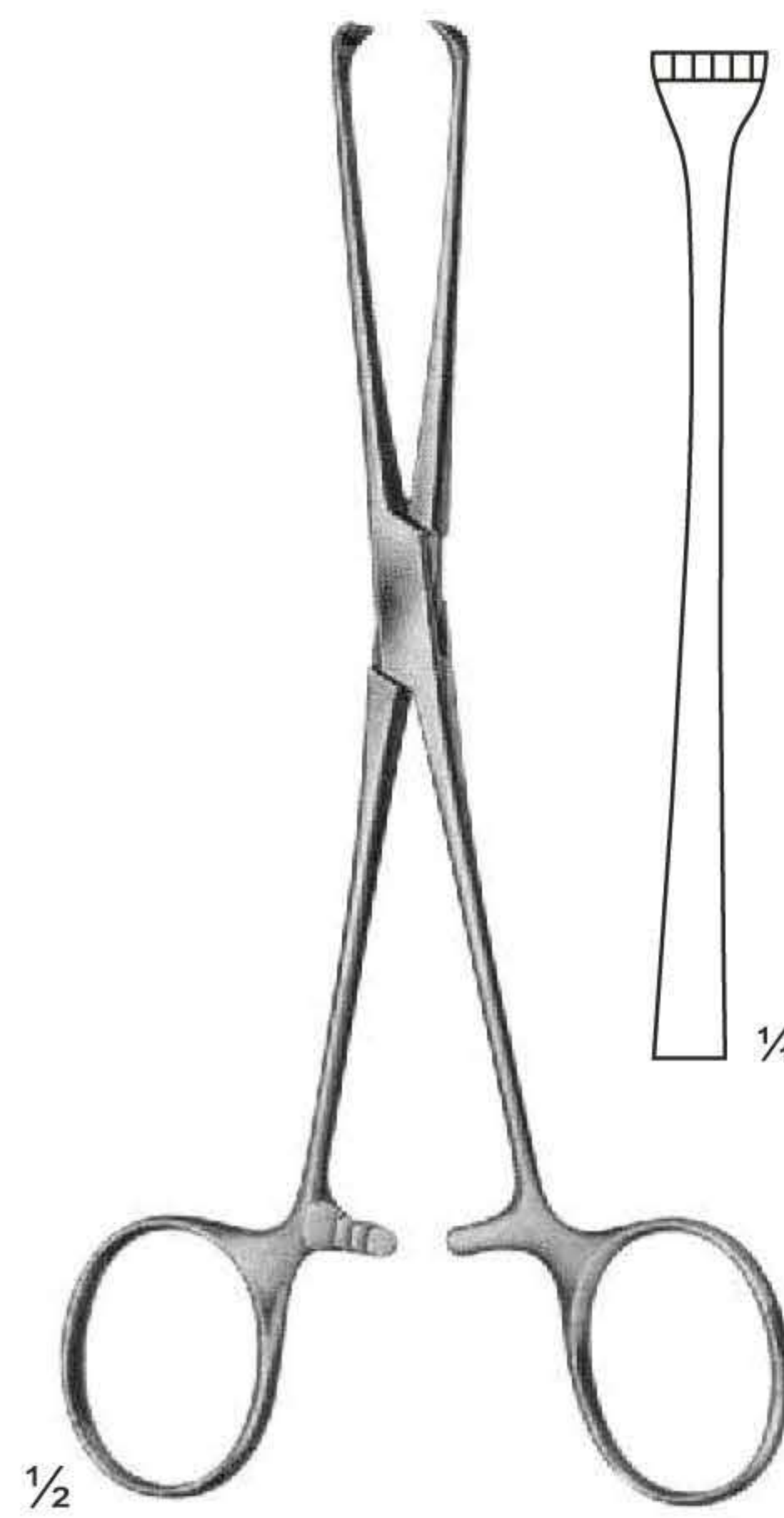

**UG-1129**  
**BOYS-ALLIS**  
 5 X 6 teeth, sharp  
 155 mm,

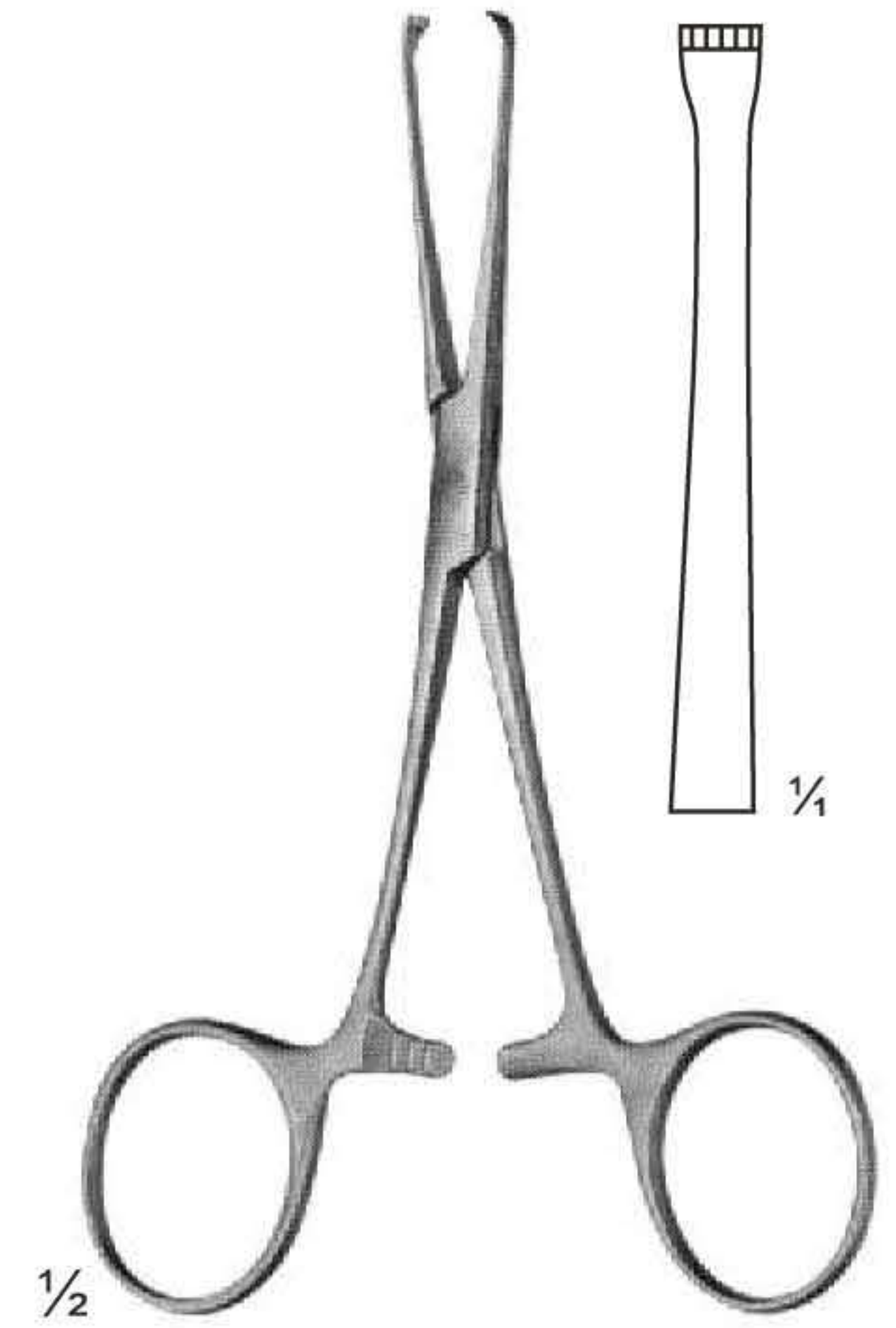

**UG-1130**  
**ALLIS**  
 4 X 5 teeth  
 155 mm,



**UG-1131**  
**ALLIS**  
 155 mm,  
 4 X 5 teeth



**UG-1132**  
**ALLIS**  
 190 mm,  
 255 mm,  
 5 X 6 teeth



**UG-1133**  
**JUDD-ALLIS**  
 3 X 4 teeth  
 195 mm,

# Intestinal Grasping Forceps

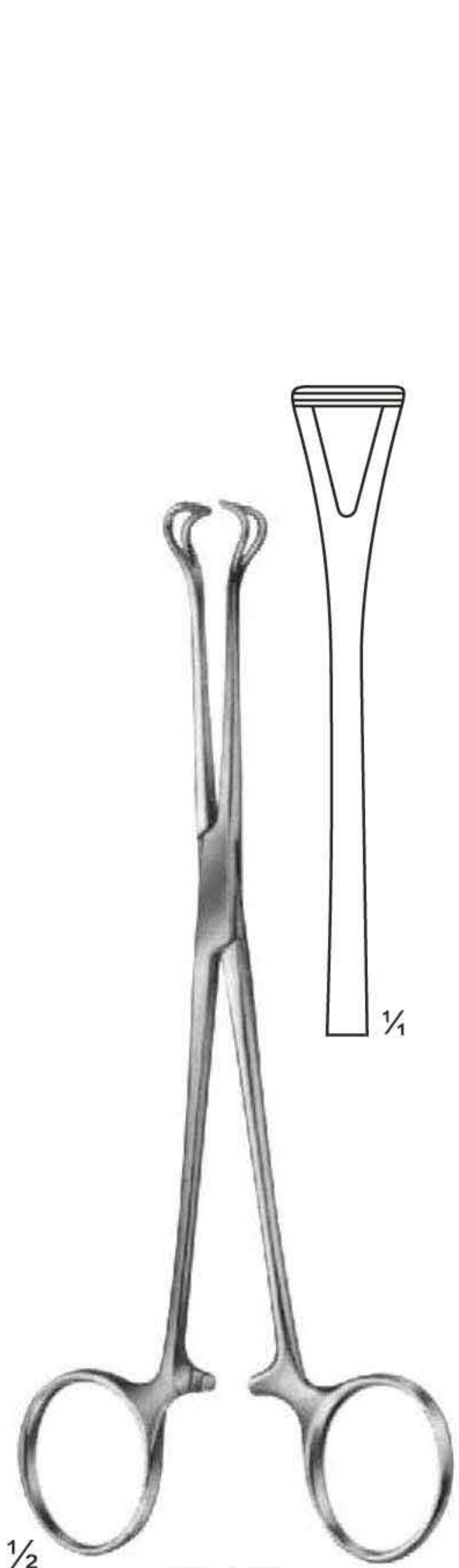

$\frac{1}{2}$   
**UG-1135**  
 BABCOCK  
 155 mm



$\frac{1}{2}$   
**UG-1136**  
 BABCOCK

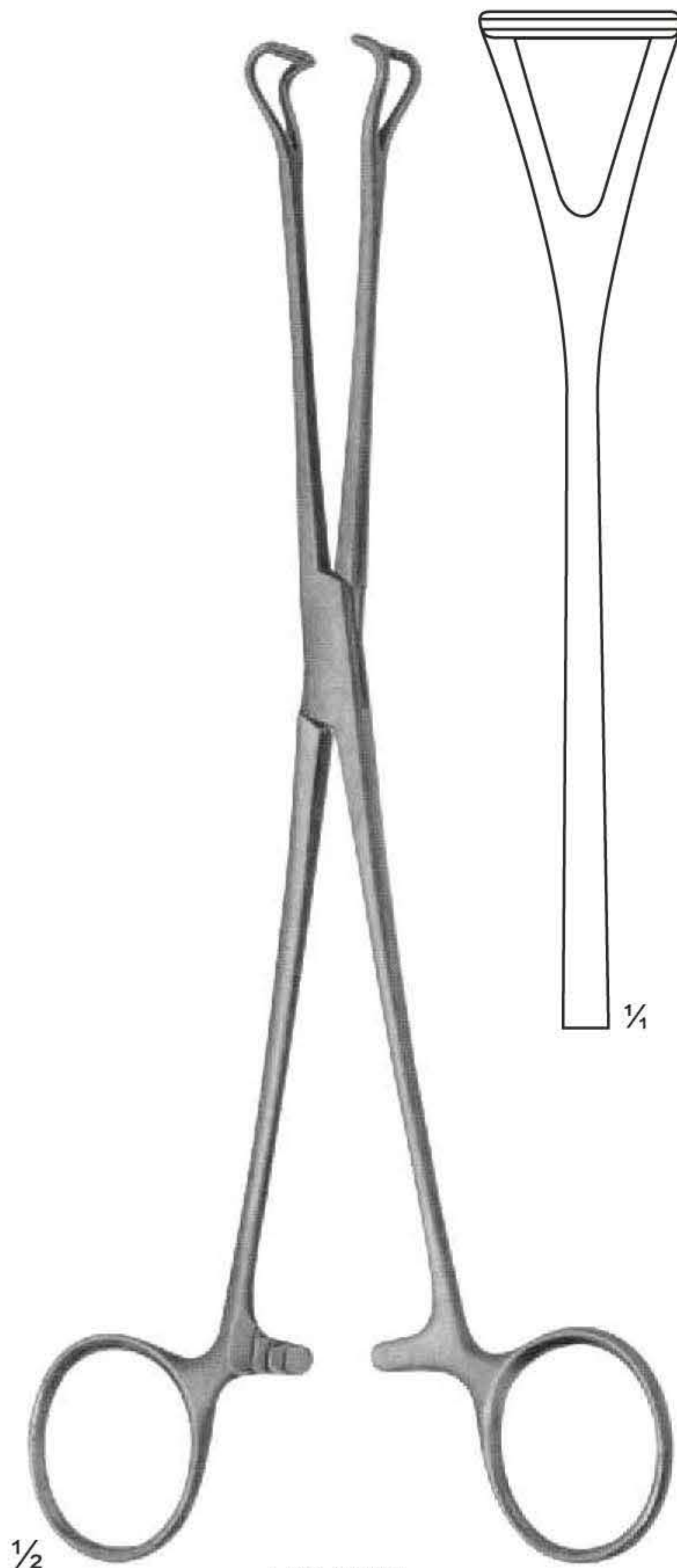

$\frac{1}{2}$   
**UG-1138**  
 BABCOCK  
 220 mm

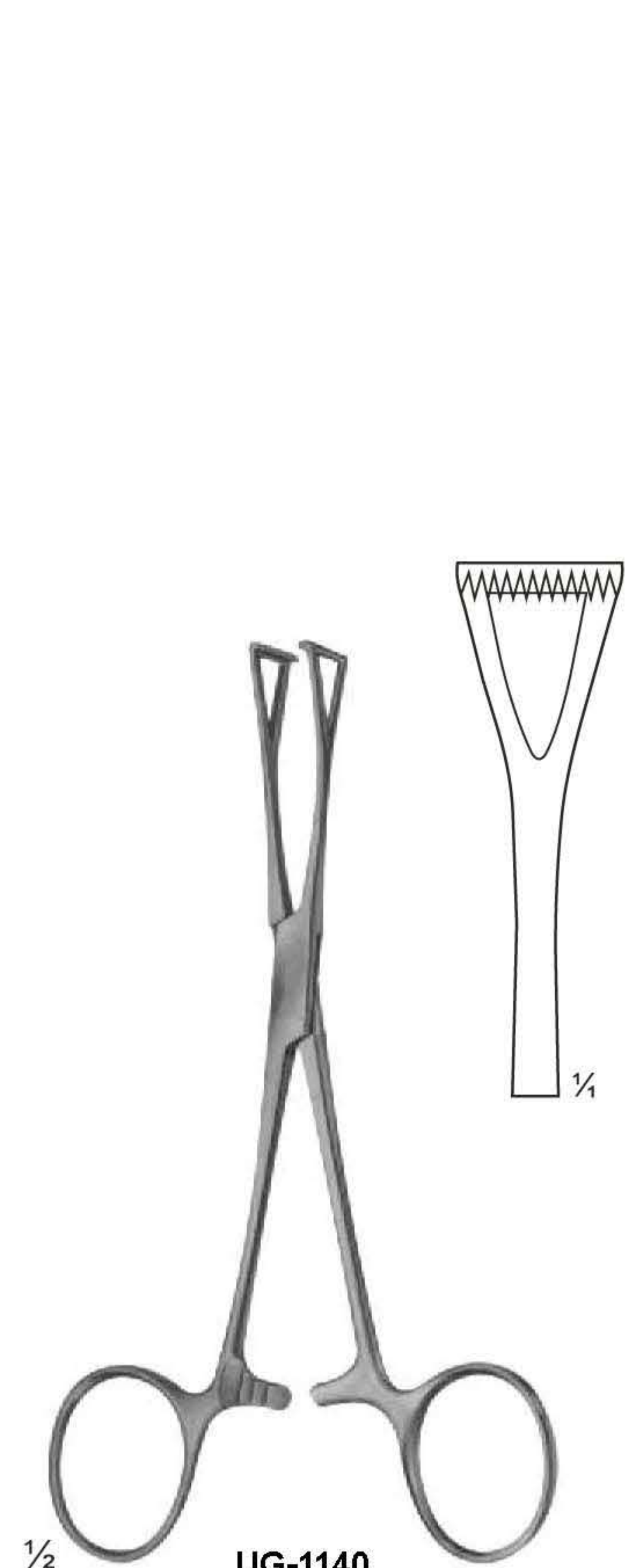

$\frac{1}{2}$   
**UG-1140**  
 COLLIN  
 140 mm,

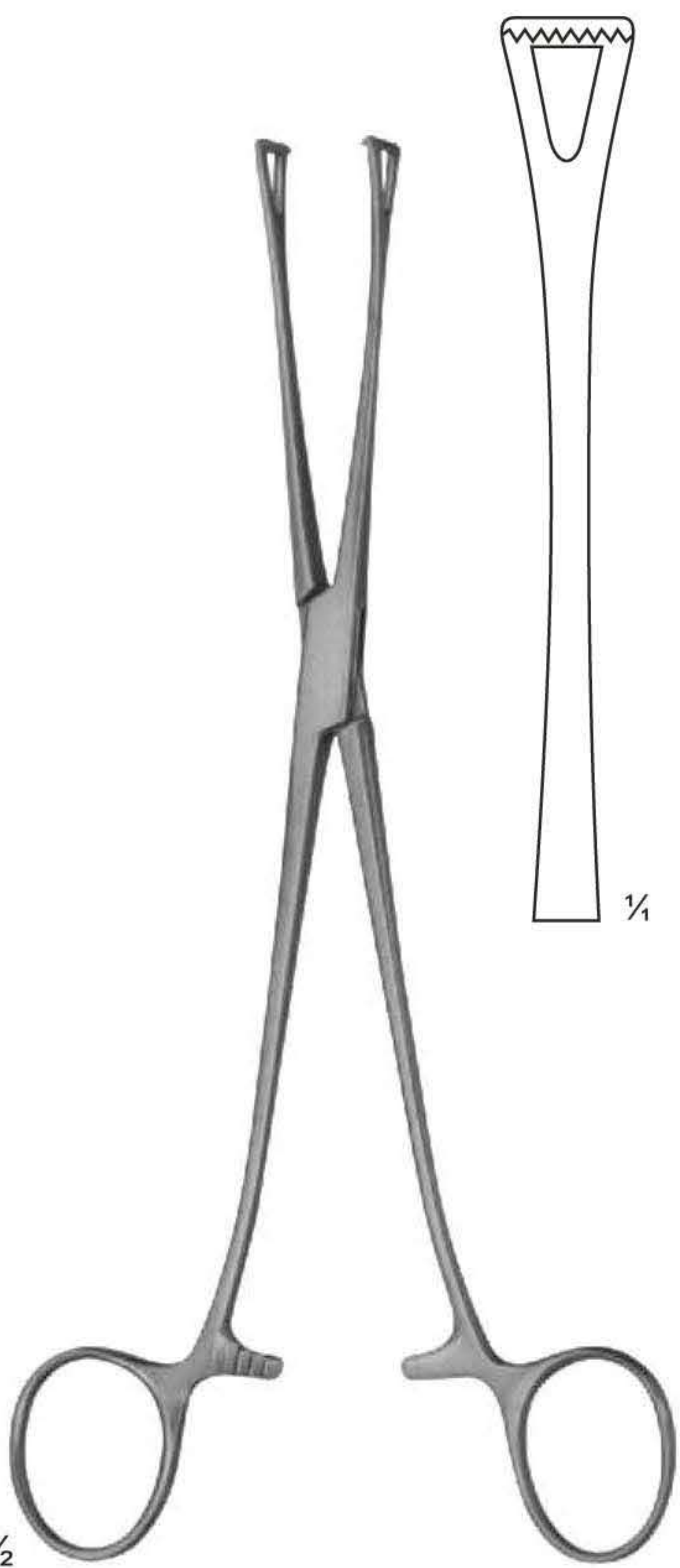

$\frac{1}{2}$   
**UG-1141**  
 LOCKWOOD  
 200 mm,

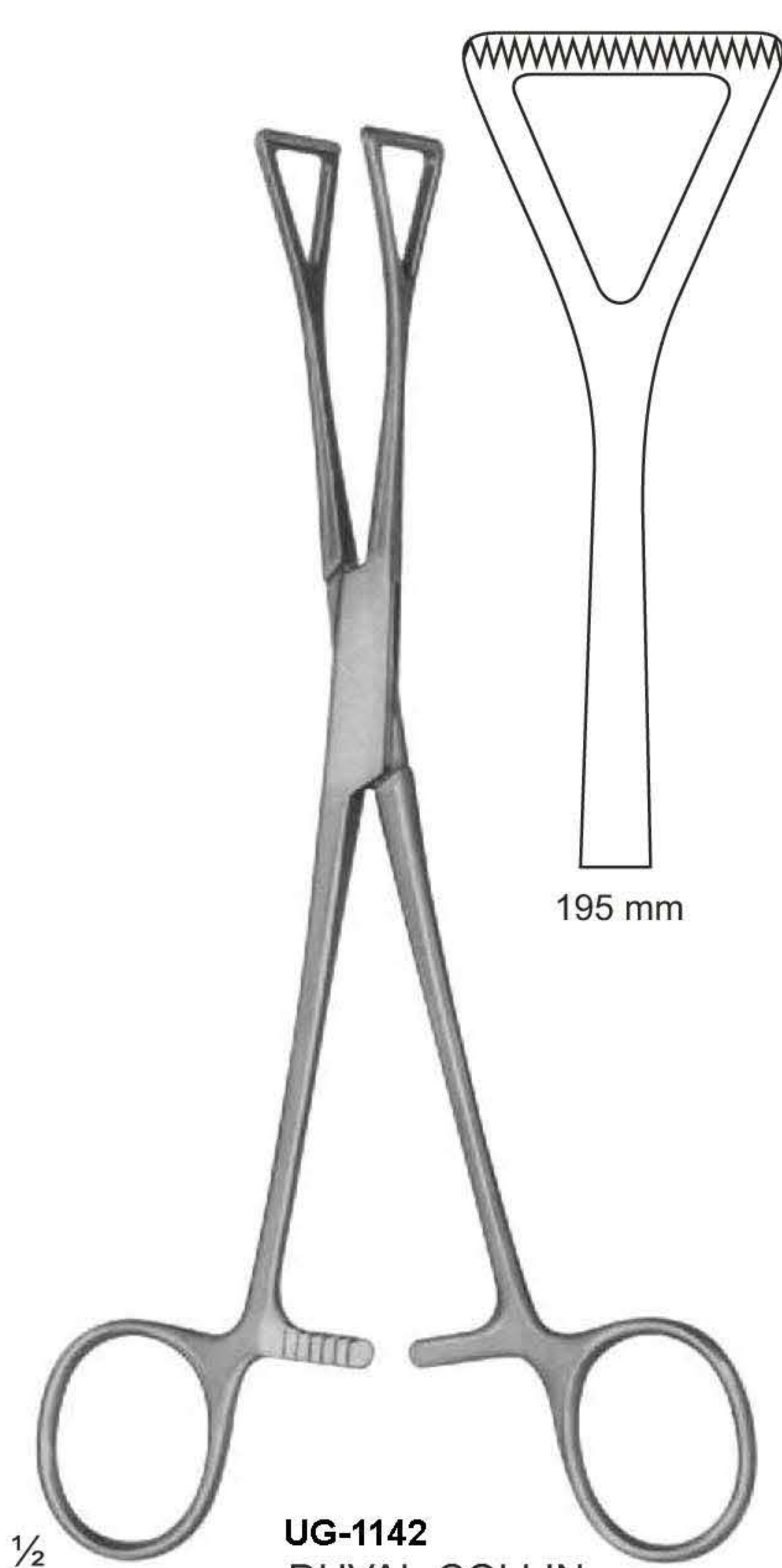

$\frac{1}{2}$   
**UG-1142**  
 DUVAL-COLLIN  
 195 mm  
 200 mm

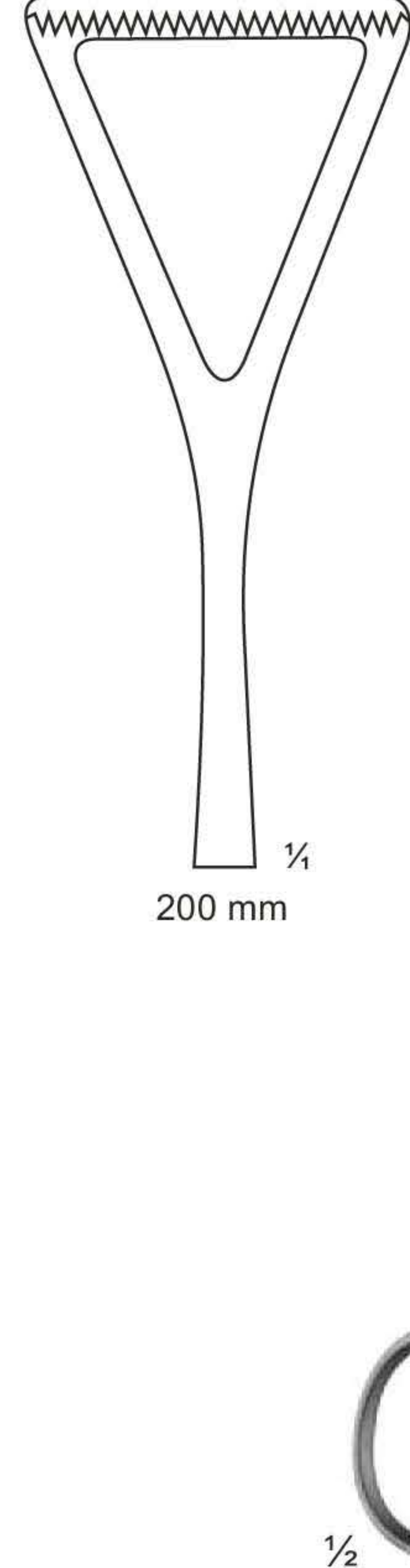

$\frac{1}{2}$   
**UG-1143**  
 DUVAL  
 230 mm,

# Cone Knives, Myomatome, Trigeminal & Tonsil Knives



**UG-179**  
**AYRE**  
 Size: 200mm  
 Cone Knife

**UG-182**  
 Size: 120mm  
 Cone Knife

**UG-185**  
**SEGOND**  
 Size: 115mm  
 Myomatome

**UG-186**  
**OLIVECRONA**  
 Size: 110mm  
 Trigeminal  
 Knife

**UG-189**  
**CONE**  
 Size: 55 mm  
 Trigeminal  
 Knife

**UG-190**  
**FOWLER**  
 Size: 115mm  
 Tonsil Knife

**UG-191**  
**ABRAHAM**  
 Size: 115mm  
 Tonsil Knife

**UG-192**  
**BRUNINGS**  
 Size: 115mm  
 Tonsil Knife



# Organ - Tissue Grasping, Dissecting & Intestinal Forceps



**UG-1146**  
LANE

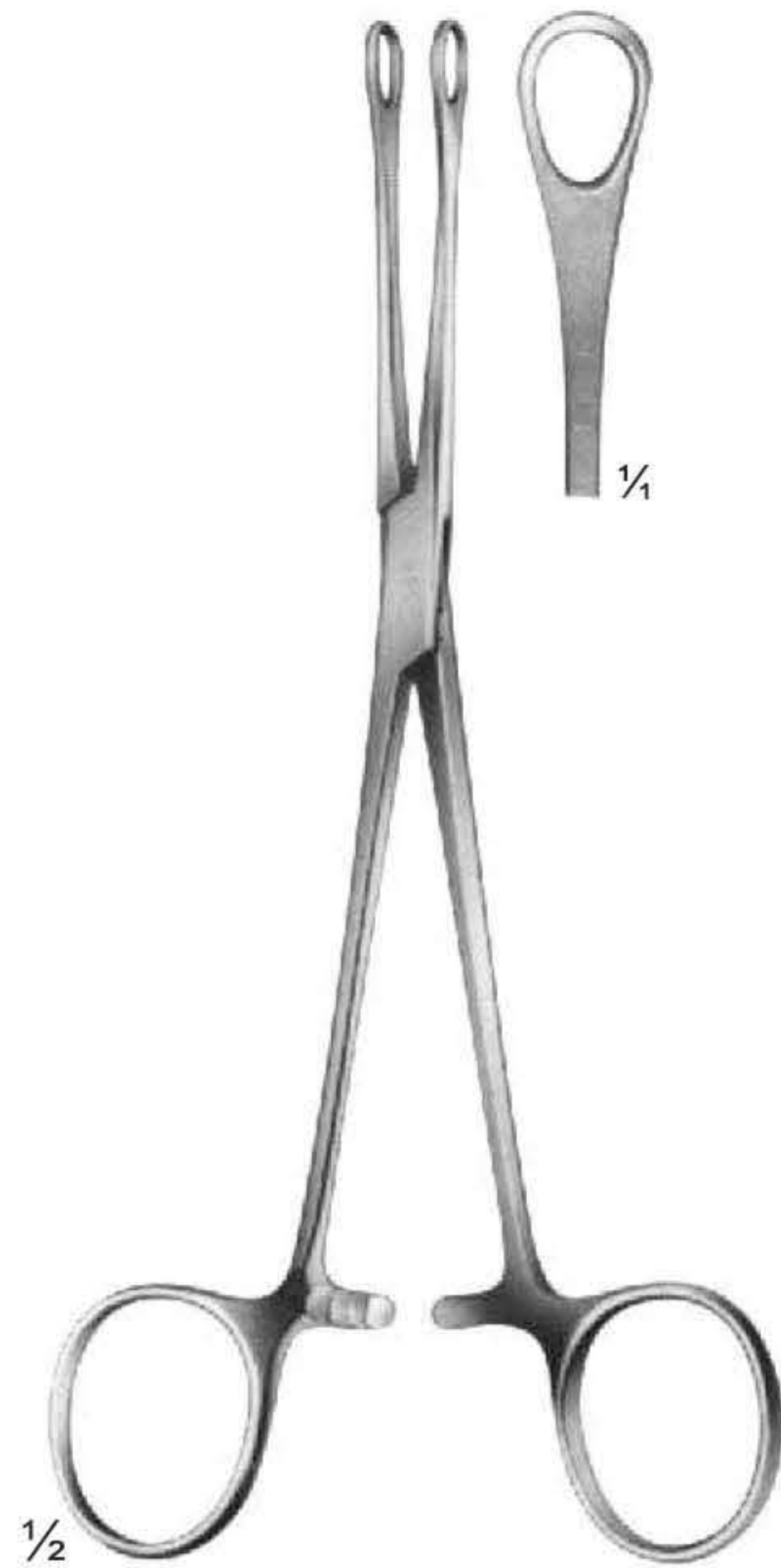

**UG-1147**  
WILLIAMS  
160 mm



**UG-1148**  
DENIS  
BROWNE  
190 mm

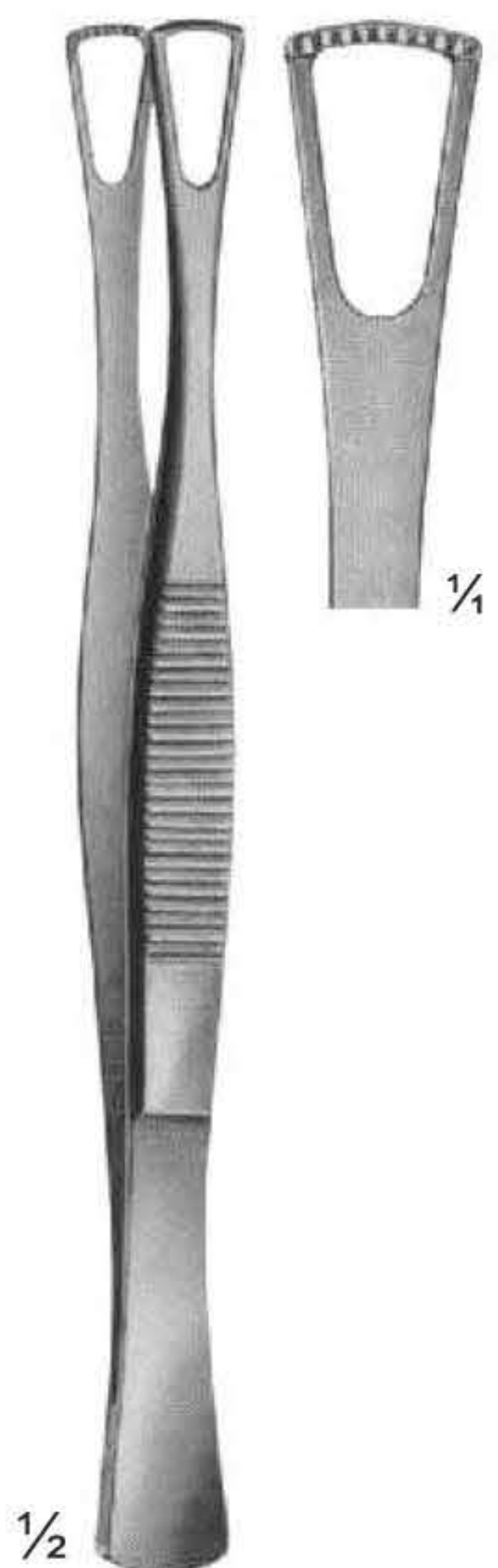

**UG-1149**  
DUVAL  
140 mm

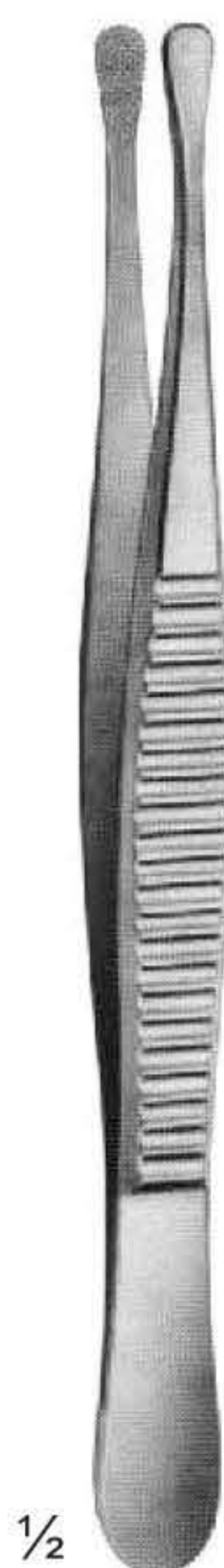

**UG-1150**  
WANGENSTEEN  
150 mm

230 mm



**UG-1152**  
WANGENSTEEN  
150 mm

230 mm

# Organ - Tissue Grasping, Dissecting & Intestinal Forceps

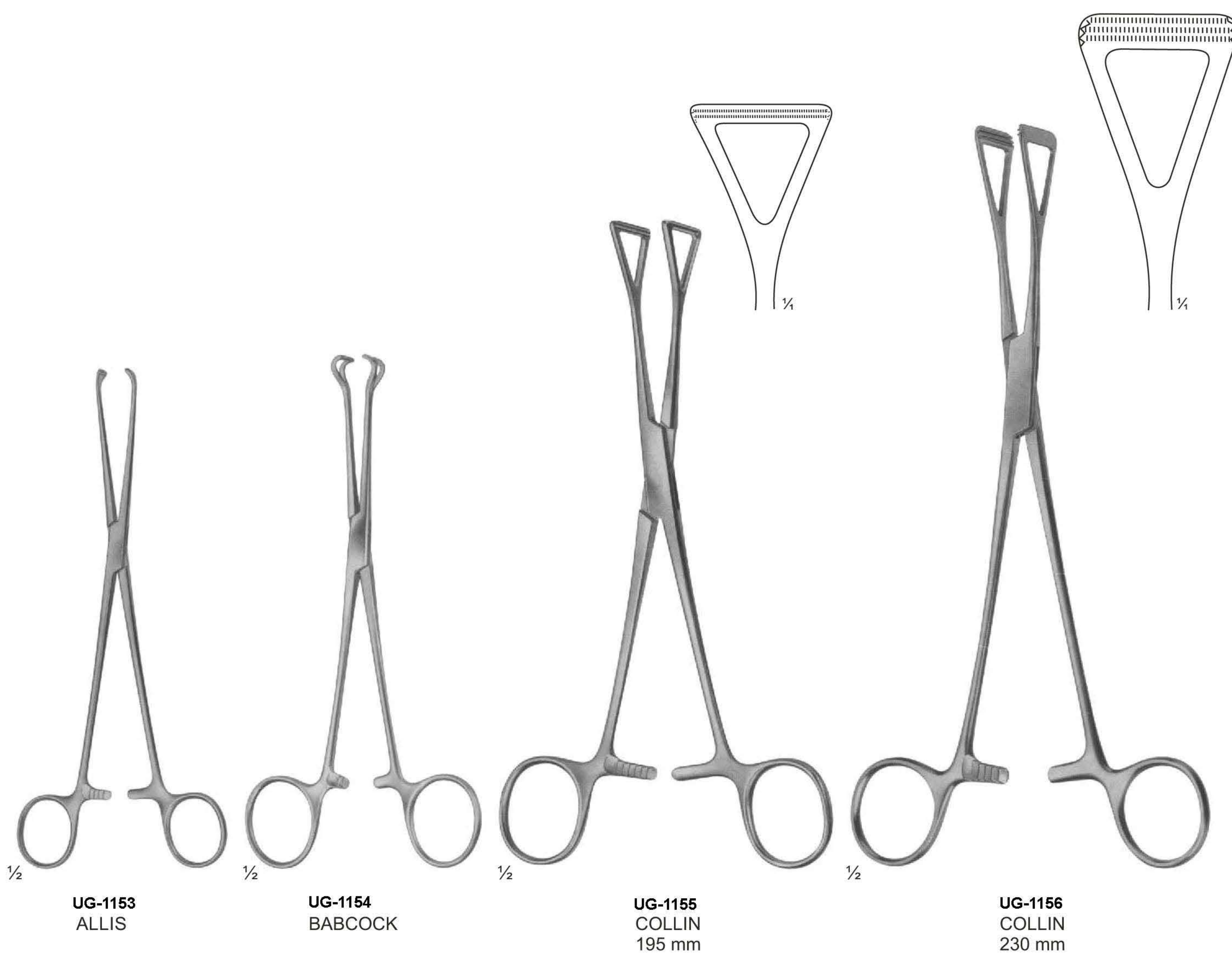

# Ultra - Light - Forceps, Dissecting Forceps



1/2

**UG-1157** 150 mm  
200 mm  
240 mm  
300 mm



1/2

DE BAKEY  
**UG-1158** 150 mm  
200 mm  
240 mm  
300 mm



1/2

DE BAKEY  
**UG-1159** 150 mm  
200 mm  
240 mm  
300 mm

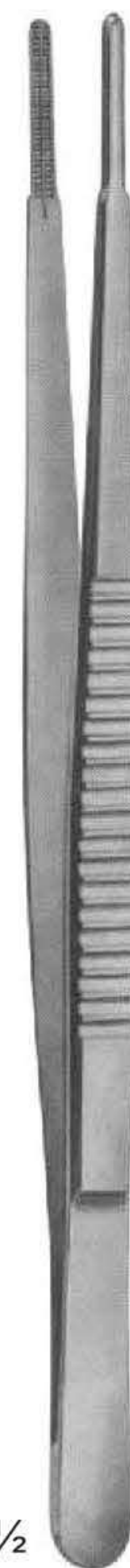

1/2

DE BAKEY  
**UG-1160** 200 mm  
240 mm  
300 mm

# Intestinal Clamps for Children



½

**UG-1161**  
BAINBRIDGE  
155 mm



½

**UG-1162**  
ALLEN  
155 mm



½

**UG-1165**  
BABY-KOCHER  
very elastic blades  
130 mm

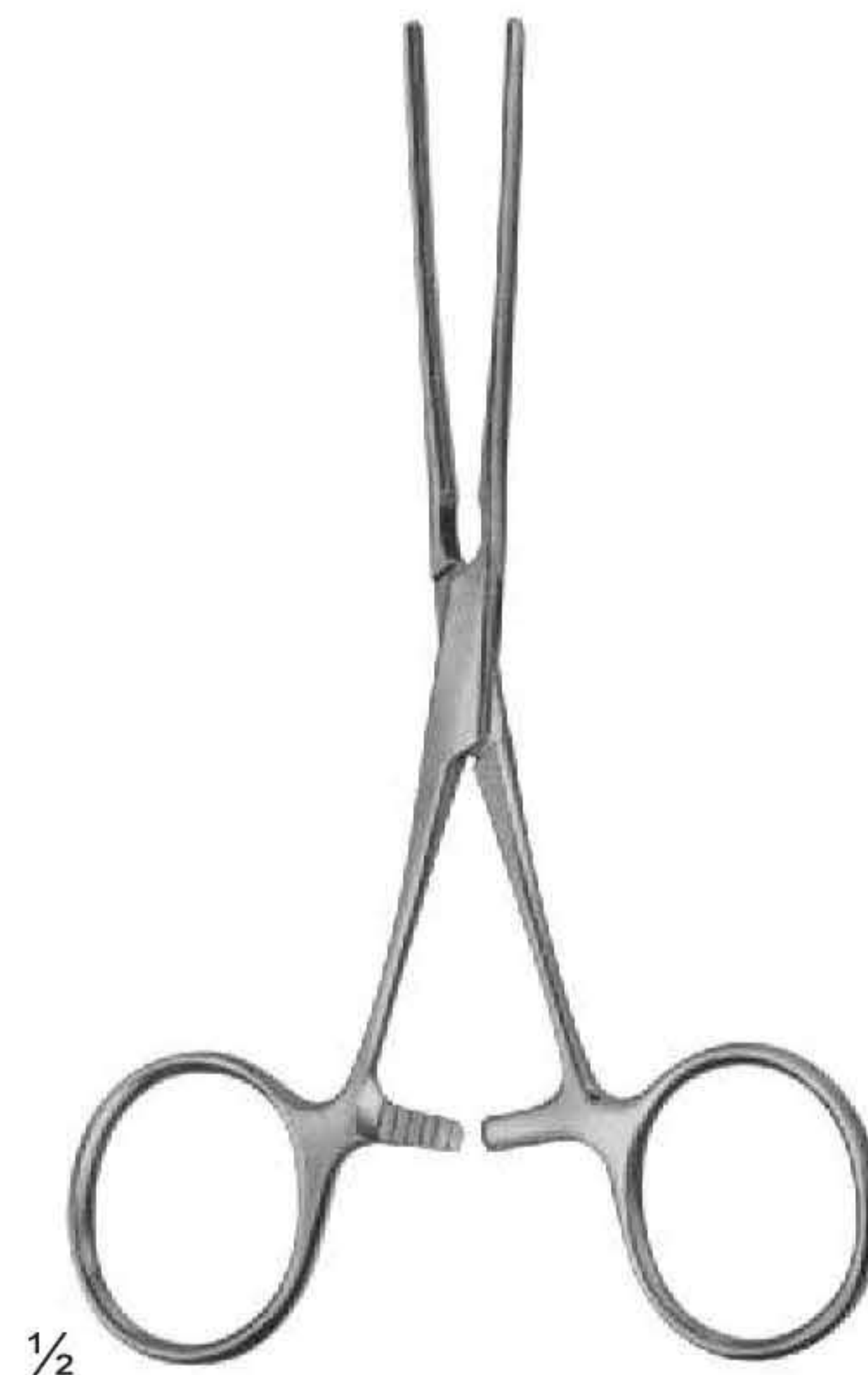

½

**UG-1167**  
BABY-KOCHER  
with elastic blades  
130 mm

## Intestinal Clamps, Soft Elastic



1/2

**UG-1169**  
DOYEN  
elastic  
165 mm



1/2

**UG-1171**  
DOYEN  
with elastic blades  
170 mm



1/2

**UG-1172**  
HARTMANN  
with elastic blades  
200 mm



1/2

**UG-1174**  
HARTMANN  
with elastic blades  
200 mm

# Intestinal Clamps, Soft elastic



**UG-1175**  
KOCHER  
with elastic blades  
210 mm  
230 mm



**UG-1178**  
DOYEN  
with elastic blades  
210 mm

## Intestinal Clamps, Soft elastic

---



$\frac{1}{2}$  **UG-1179**  
DOYEN  
with elastic blades  
235 mm

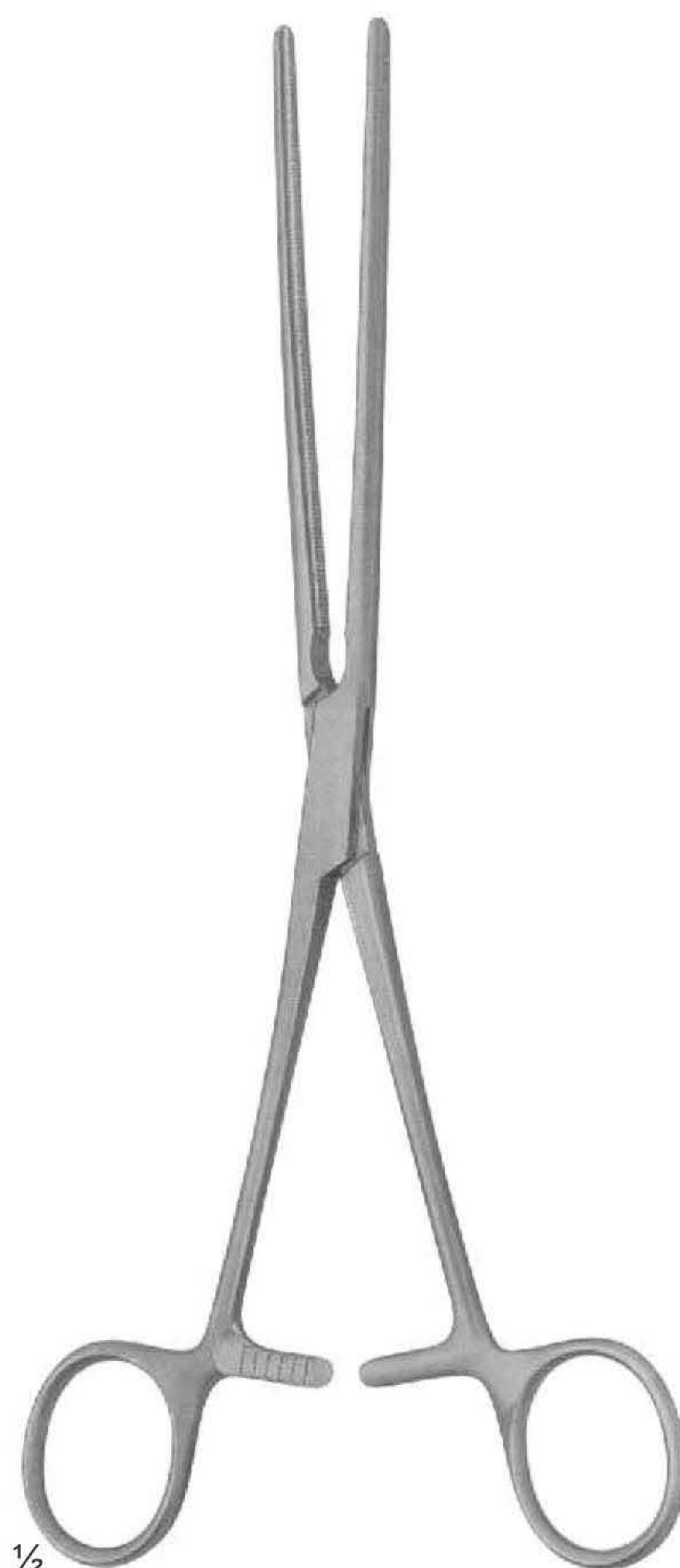

$\frac{1}{2}$  **UG-1182**  
DOYEN  
with elastic blades  
230 mm

## Intestinal Clamps, Soft elastic

---



1/2

**UG-1183**  
KOCHER  
with very elastic blades



## Intestinal Clamps, Soft elastic

---



½

**UG-1184**  
KOCHER  
with very elastic blades

# Intestinal Clamps



**UG-1189**  
NUSSBAUM  
with elastic blades  
250 mm

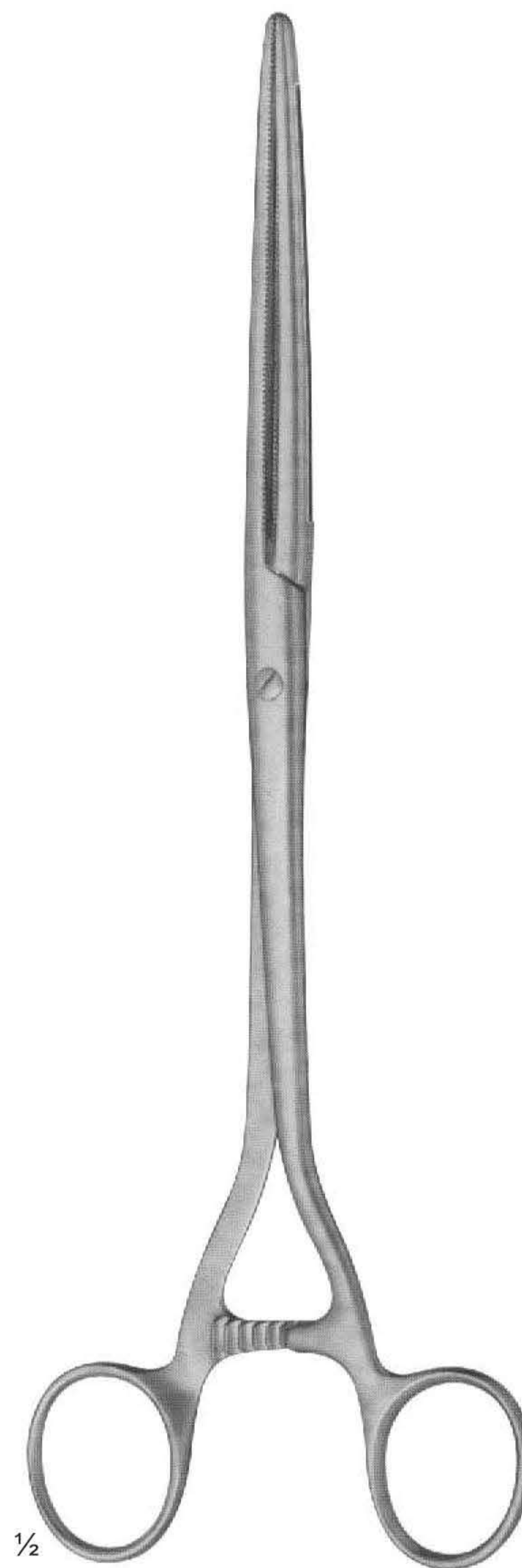

**UG-1192**  
MOYNIHAN  
280 mm

# Scalpels, Dura Knives & Comedone Extractors



**UG-194**  
**JOSEPH**  
**SIZE:125mm**

Double Edged  
Nasal Knives, Pointed

1/4



**UG-196**  
**ZIEGLER**

1/4



**UG-200**  
**VIDAL**  
Lupus Scraper

1/2

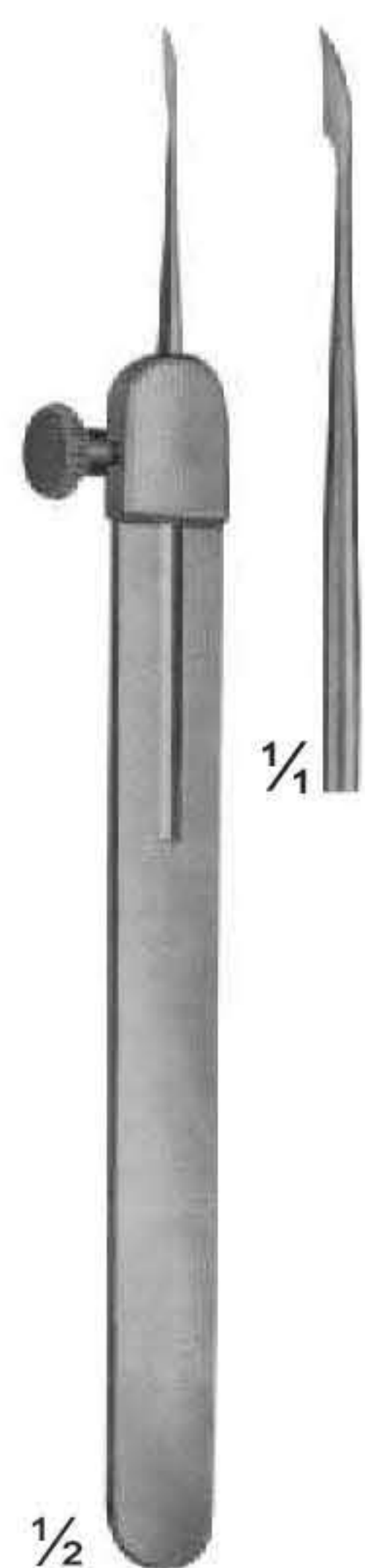

**UG-201**  
**MONCORPS**  
Milium Knives  
**SIZE:130mm**

1/2

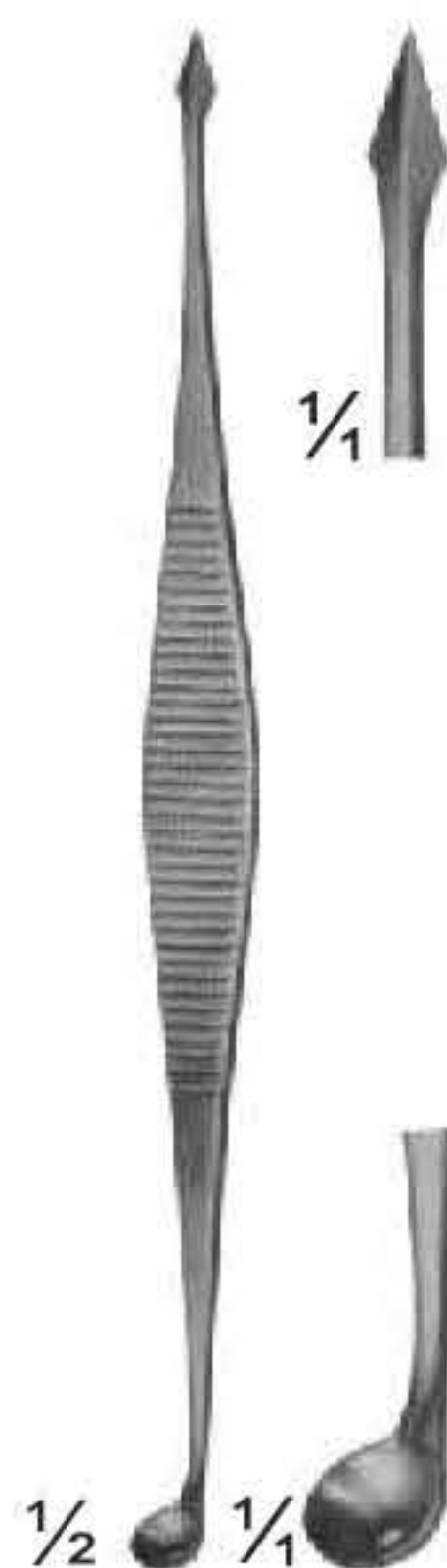

**UG-202**  
**SAALFELD**  
**SIZE:195mm**

1/2

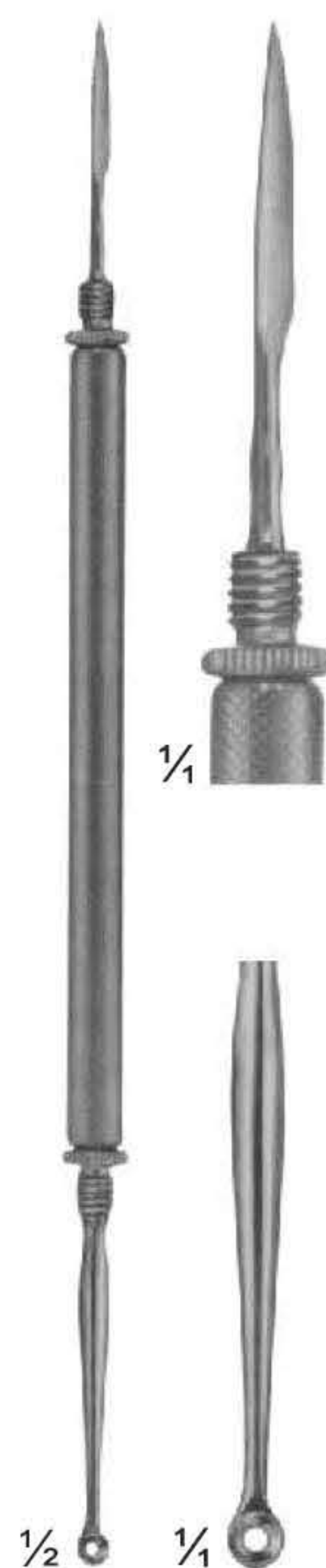

**UG-203**  
**HEBRA**  
Size: Metal  
handle"

1/2

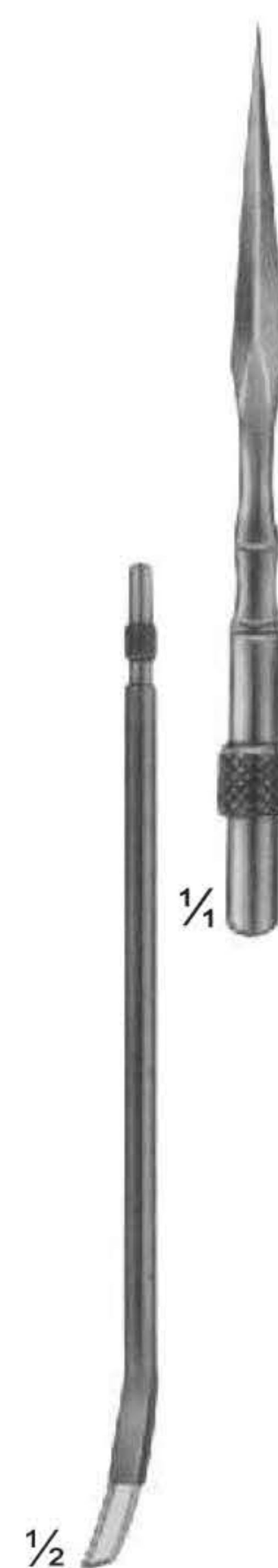

**UG-205**  
Scalpels, Dura  
Knives &  
Comedone Ex-  
tractors

1/2



**UG-206**  
**UNNA**  
**SIZE:235mm**

1/2

# Intestinal Clamps



$\frac{1}{2}$  **UG-1196**  
MAYO-ROBSON  
hard elastic  
250 mm

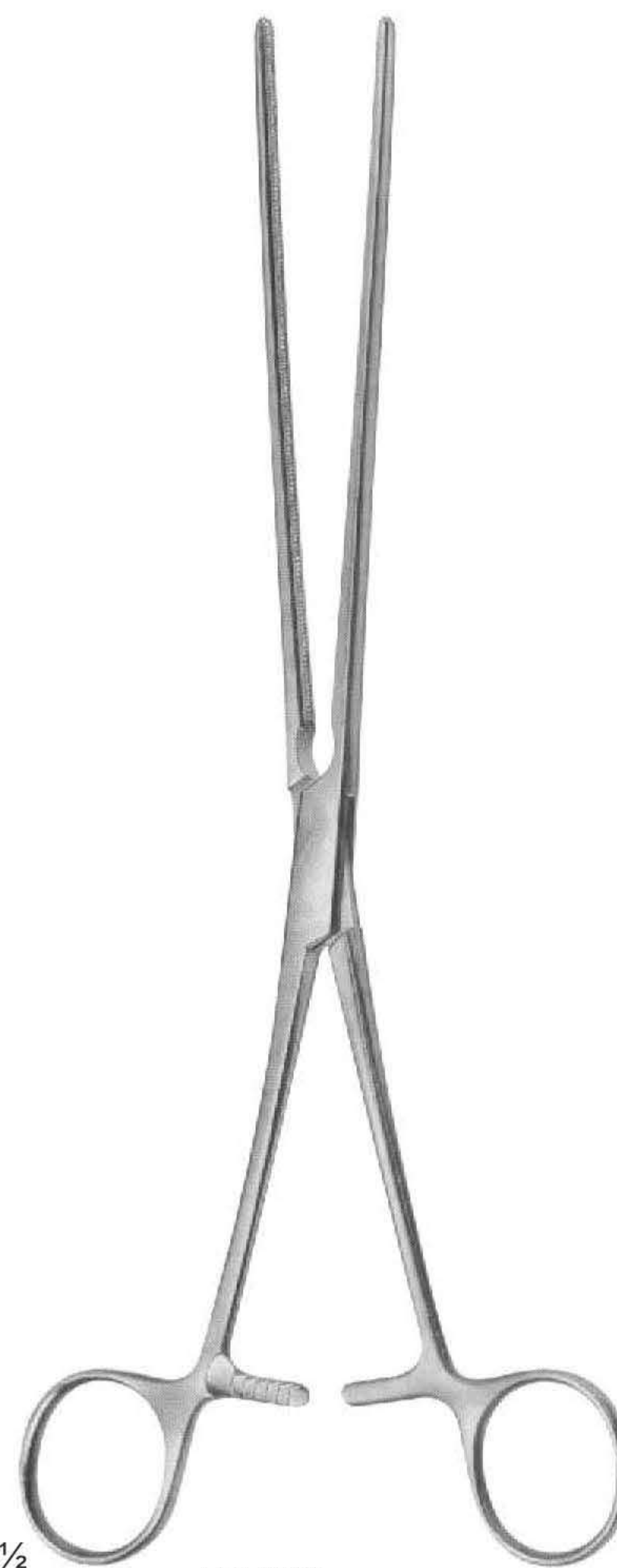

$\frac{1}{2}$  **UG-1199**  
MAYO-ROBSON  
250 mm

# Gastro-Intestinal Forceps, twin



**UG-1205**  
LANE  
300 mm

**UG-1207**  
LANE  
300 mm

# Stomach Clamps



**UG-1215**  
SCUDDER  
330 mm



**UG-1218**  
KLEINSCHMIDT  
Spur crushers and  
Appendectomy clamps  
130 mm

# Intestinal and Pylorus Clamps



**UG-1221**  
PAYR  
Intestinal clamp  
light pattern,  
for children  
180 mm

**UG-1223**  
PAYR  
200 mm

**UG-1224**  
PAYR  
275 mm

**UG-1226**  
PAYR  
Pylorus clamp  
315 mm

# Anastomosis Forceps



**UG-1231**  
PARKER-KERR  
anastomosis forceps  
for colon resection  
180 mm



**UG-1232**  
DICK  
pressure clamps  
180 mm



# Sigmoid Anastomosis Forceps



**UG-1262**  
230 mm



**UG-1263**  
LLOYD-DAVIS  
315 mm

# Sigmoid Anastomosis Forceps

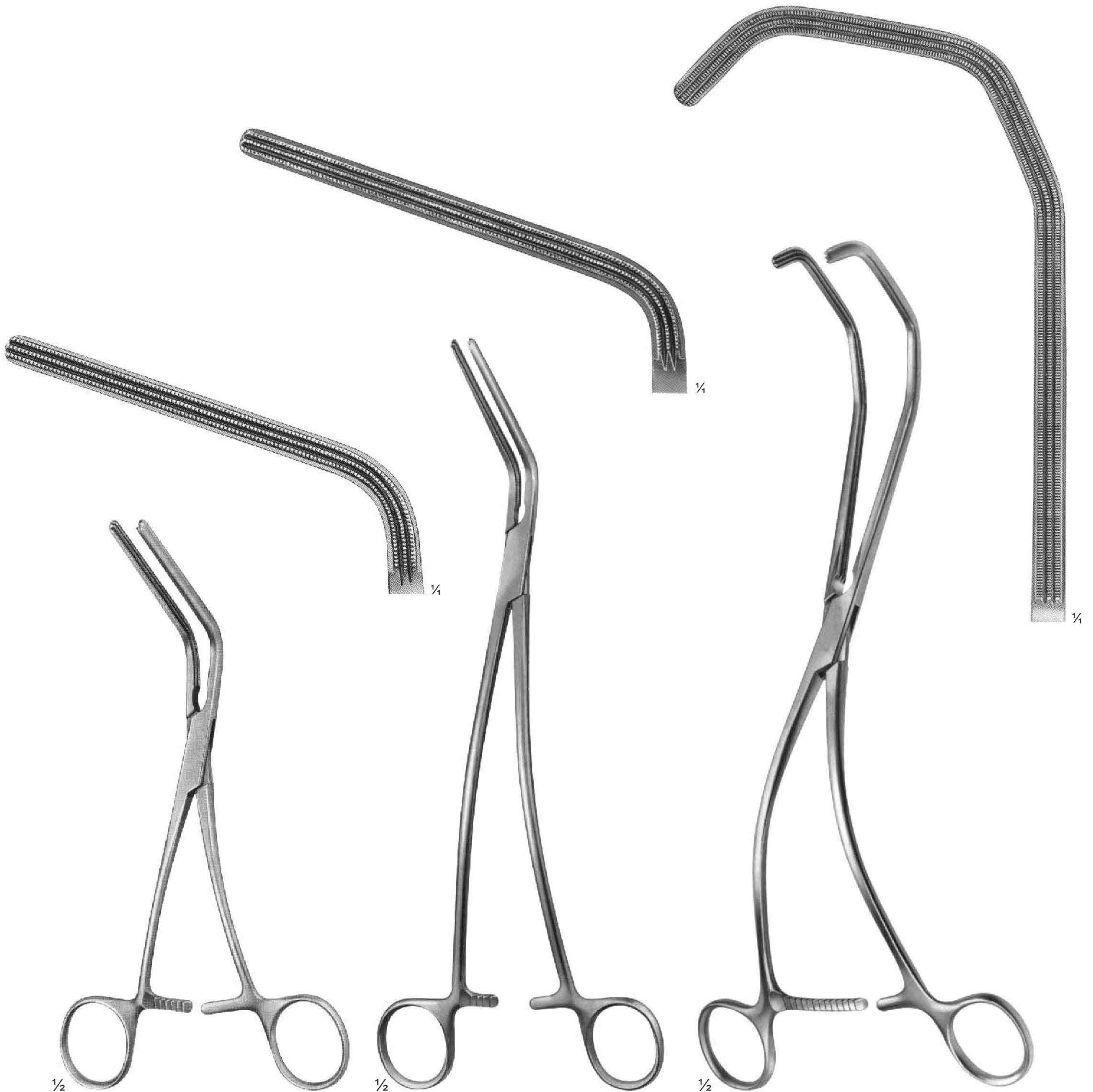

**UG-1264**  
MORRIS  
175 mm

**UG-1265**  
DE BAKEY  
(MORRIS modif.)  
240 mm

**UG-1266**  
KERSTING  
270 mm

# Rectal Specula

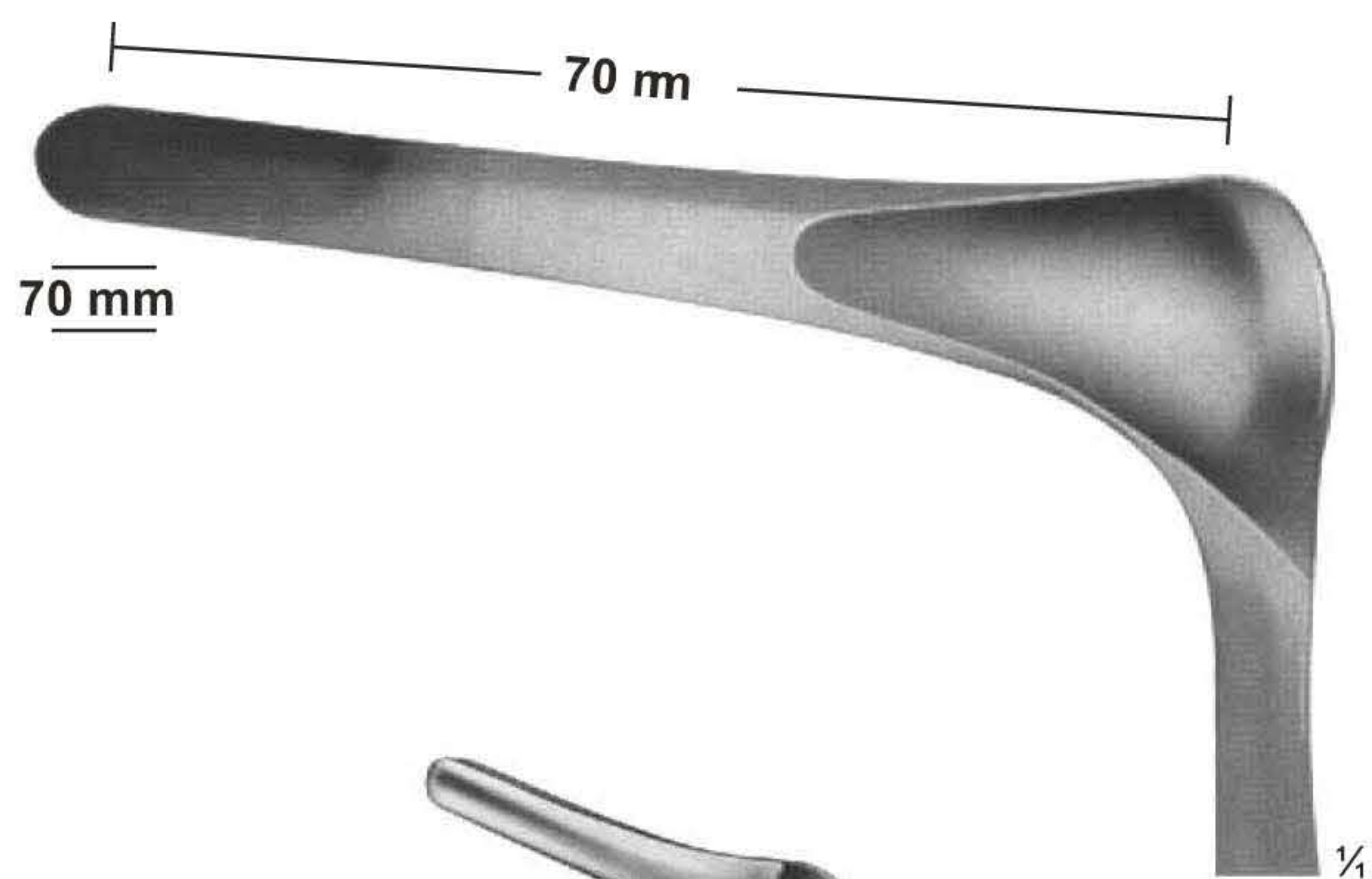

**UG-1267**  
KILLIAN  
for children  
145 mm



**UG-1268**  
SIMS  
160 mm



**UG-1269**  
SIMS  
160 mm

# Rectal Specula



1/2

UG-1272



25 mm

80 mm

1/2

UG-1277  
PRATT  
205 mm

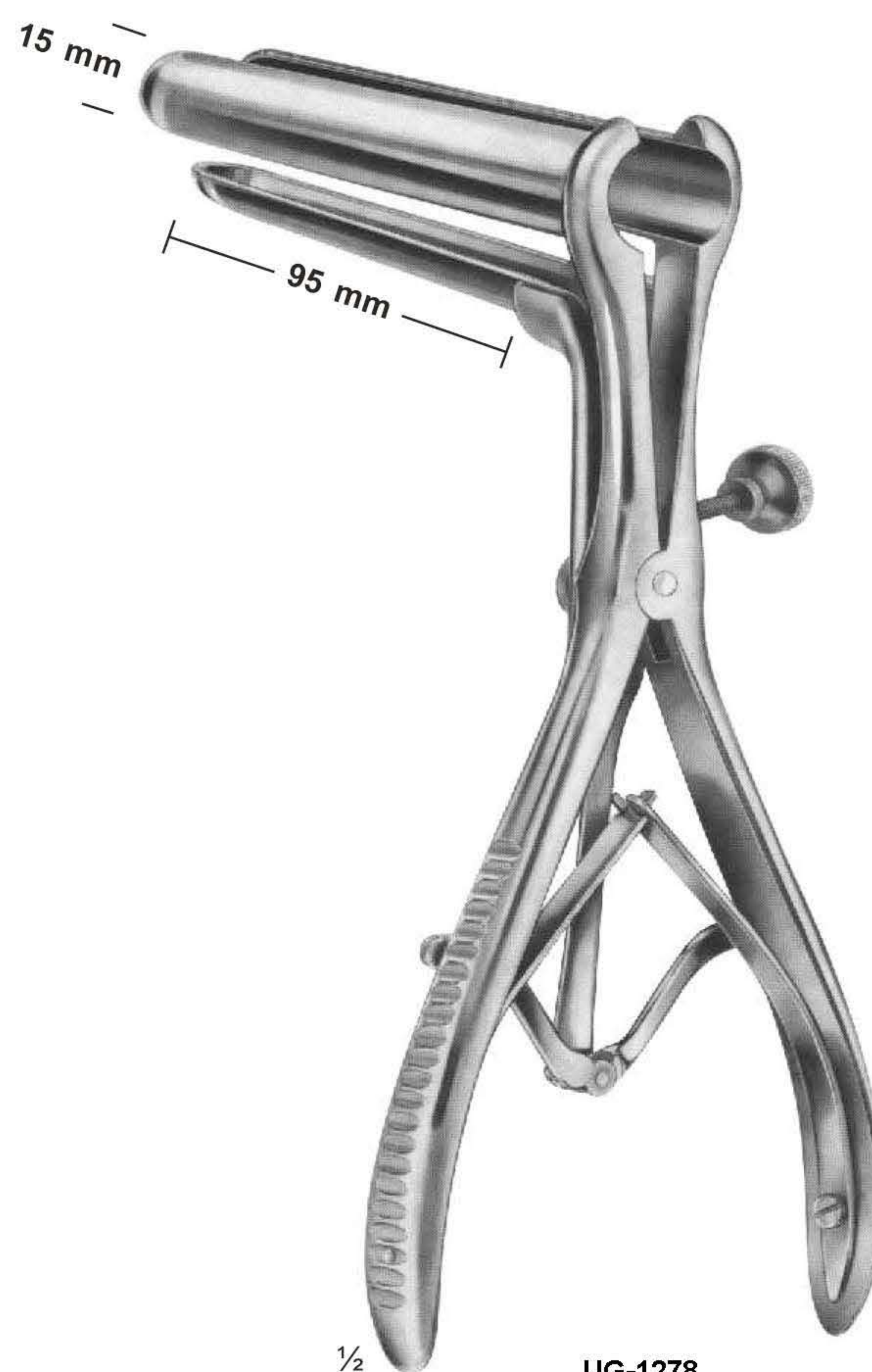

15 mm

95 mm

1/2

UG-1278  
MATHIEU  
215 mm

# Anusscopes-Sphincteroscopes



**UG-1280**  
IVES-FANSLER  
Anuscope  
145 mm



**UG-1282**  
KELLY  
Sphincteroscope  
160 mm

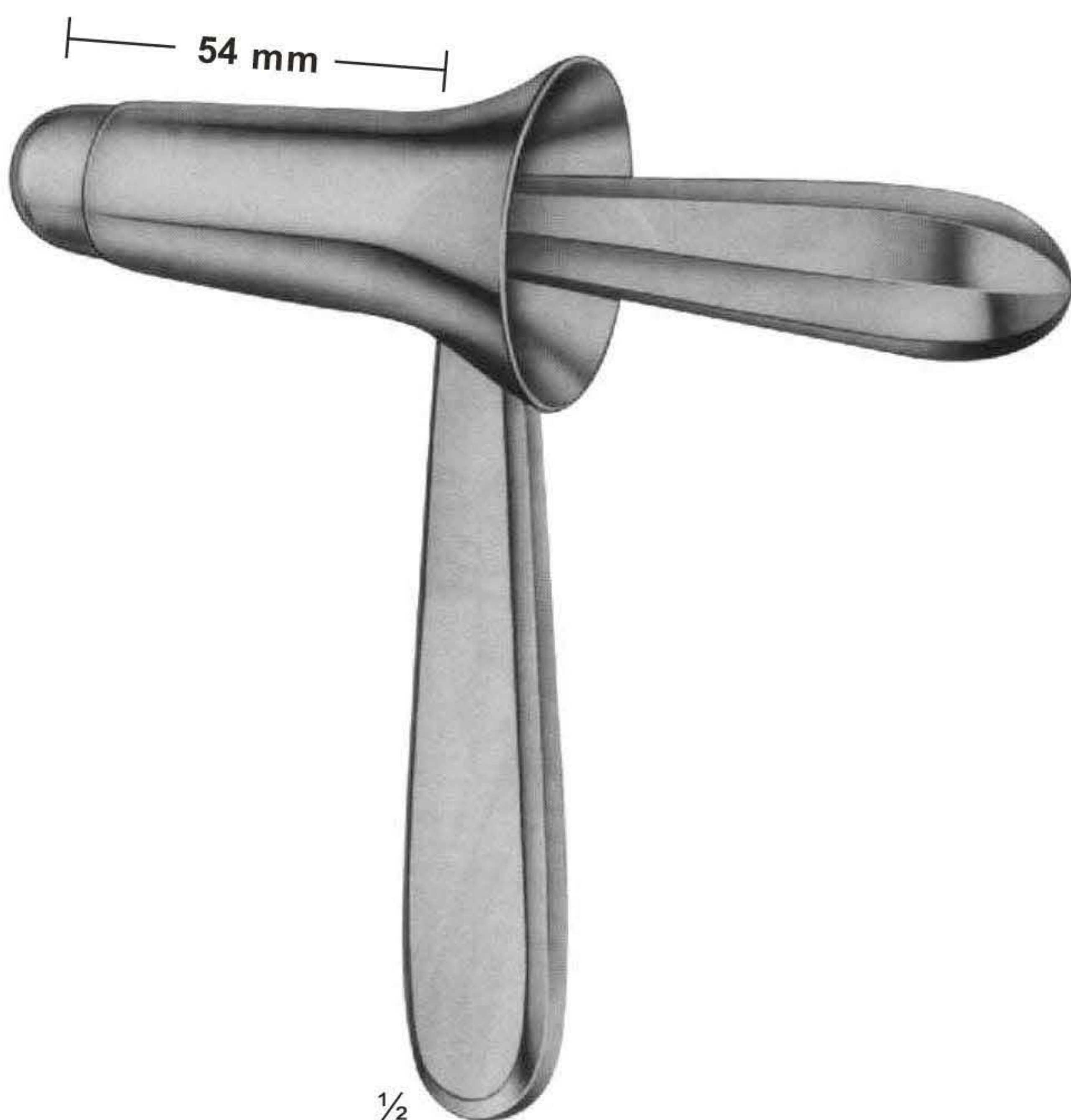

**UG-1284**  
KELLY  
Sphincteroscope  
160 mm

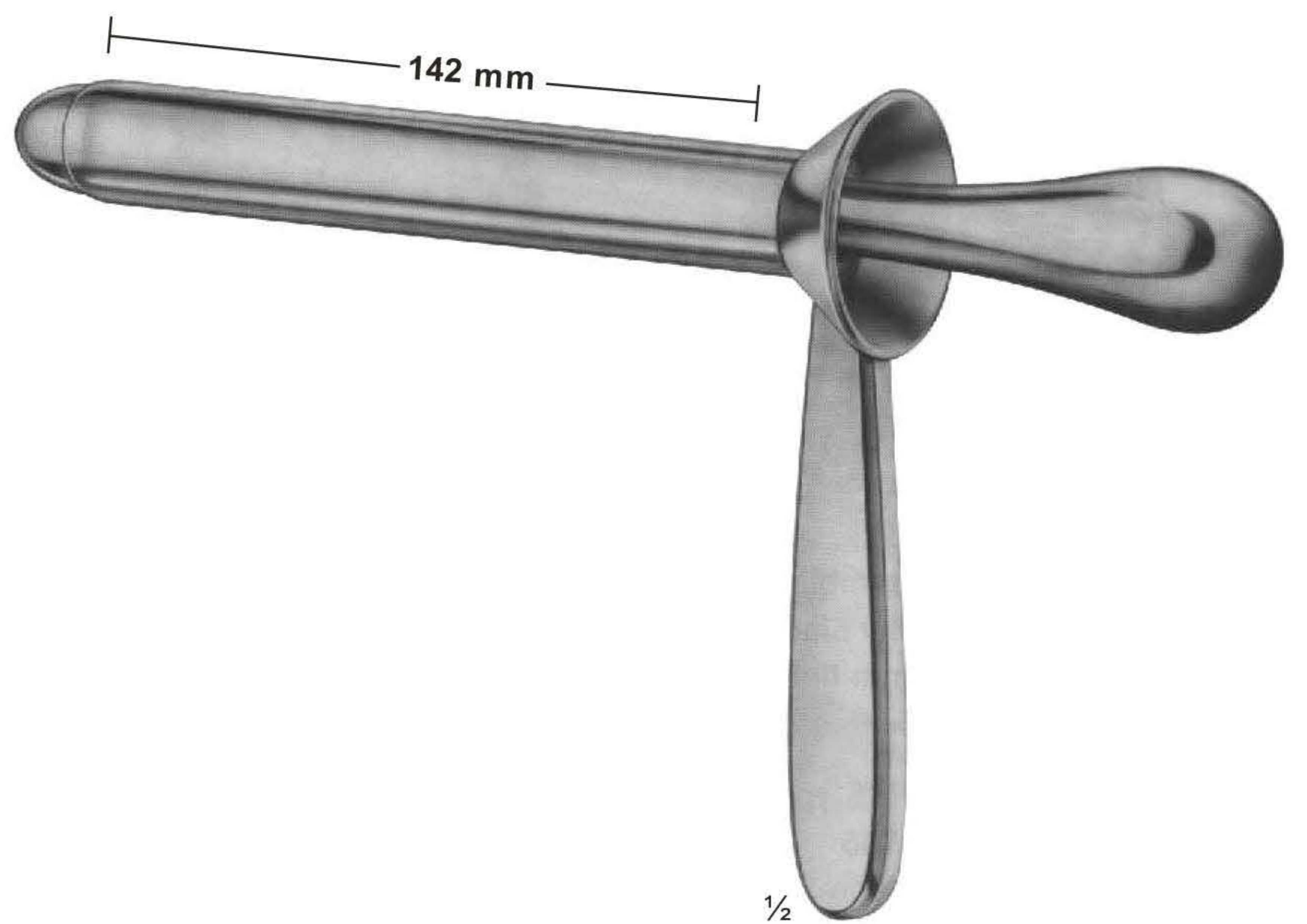

**UG-1285**  
KELLY  
Proctoscope  
160 mm

# Razor Blade Holders & Breakers



**UG-207**  
**TROUTMAN-CHRIS**  
 SIZE:150mm

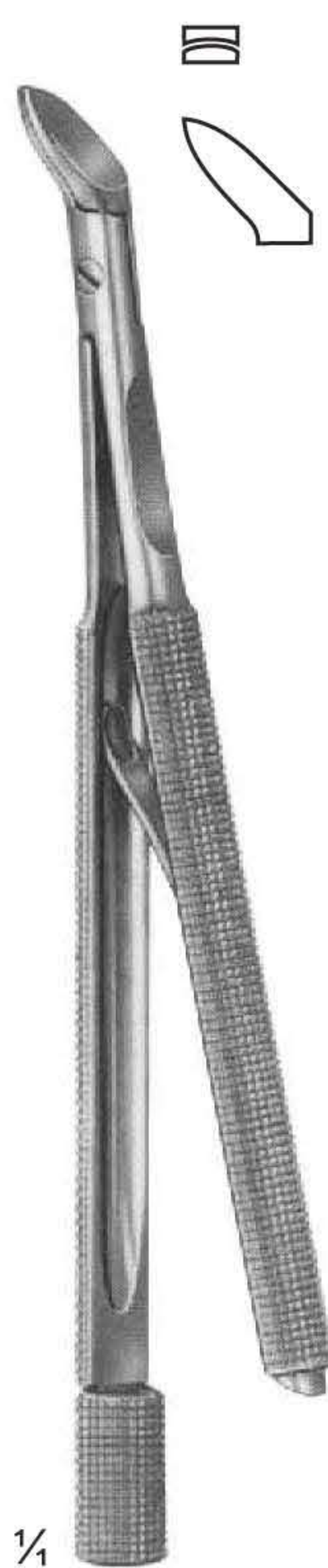

**UG-209**  
**TROUTMAN-CHRIS**  
 SIZE:200mm



**UG-210**  
 SIZE:230mm

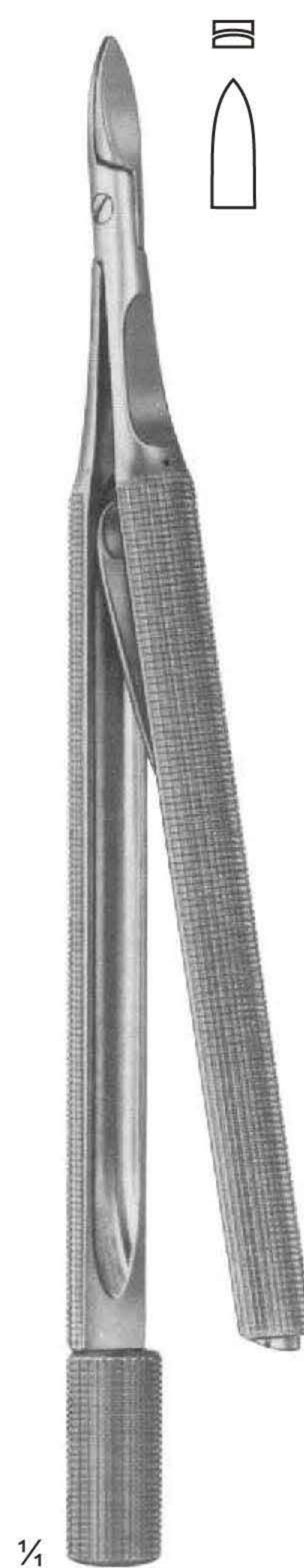

**UG-212**  
**CASTROVIEJO**  
 SIZE:300mm



**UG-213**  
 SIZE:270mm

# Biopsy forceps for rectum

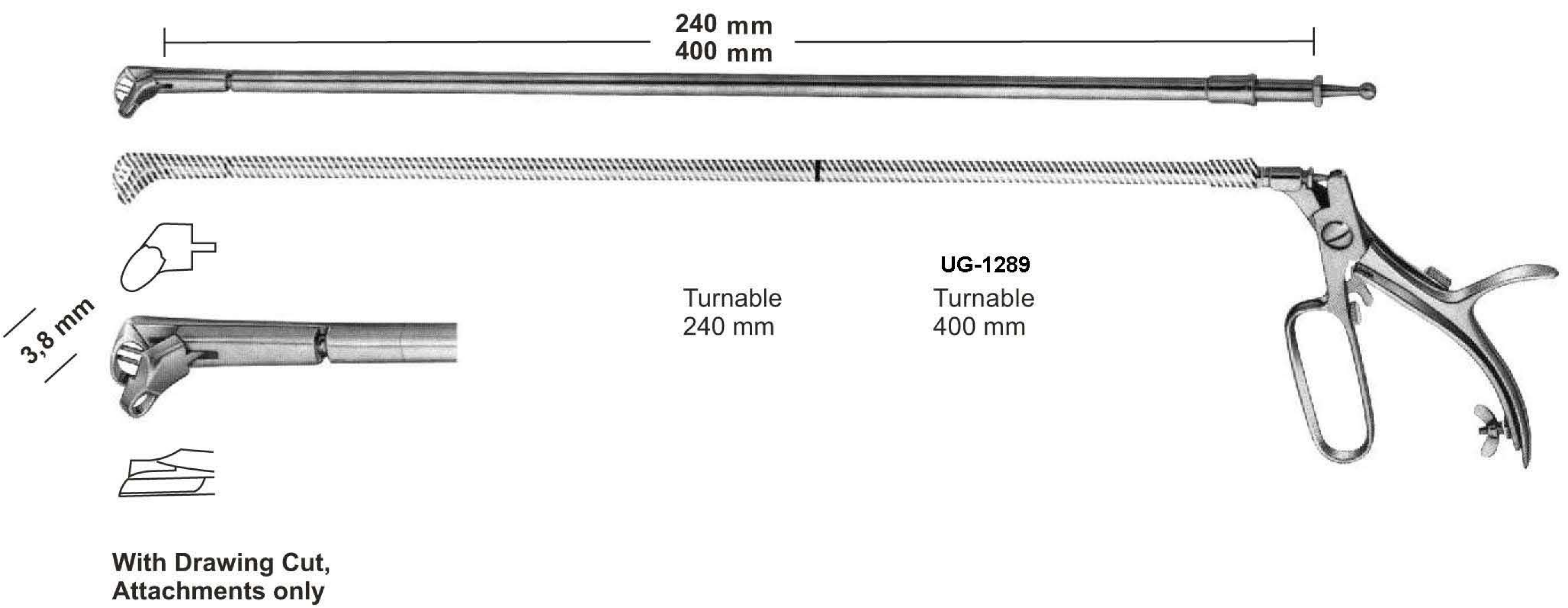
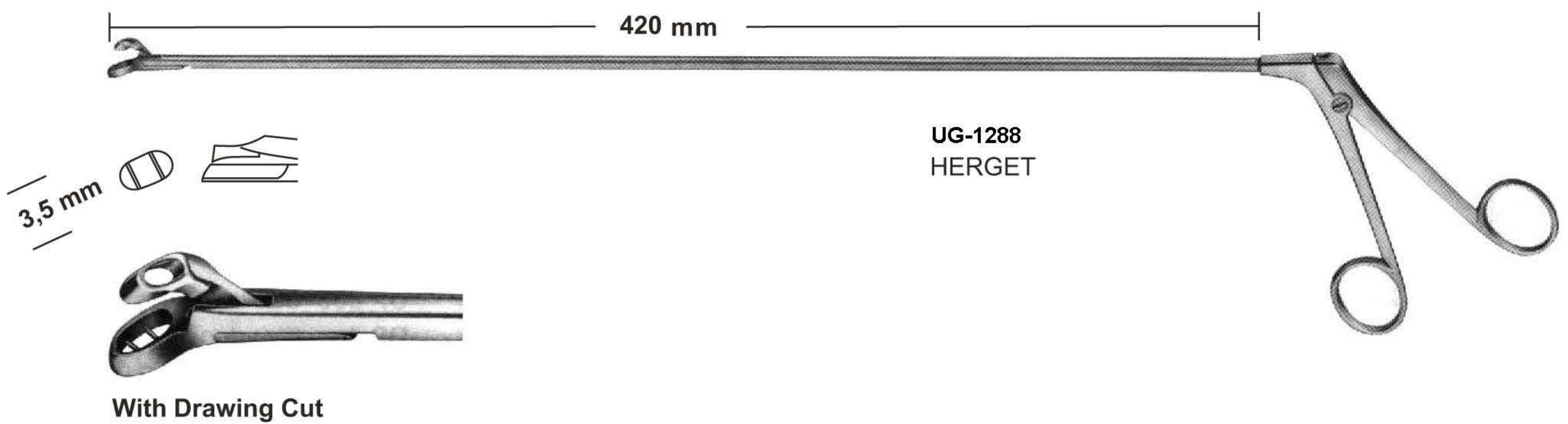
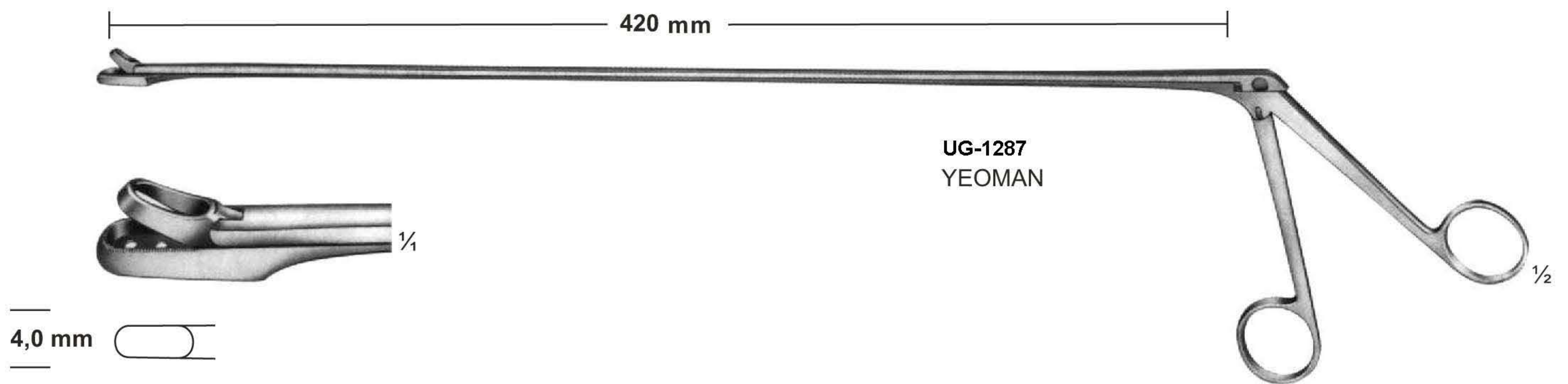
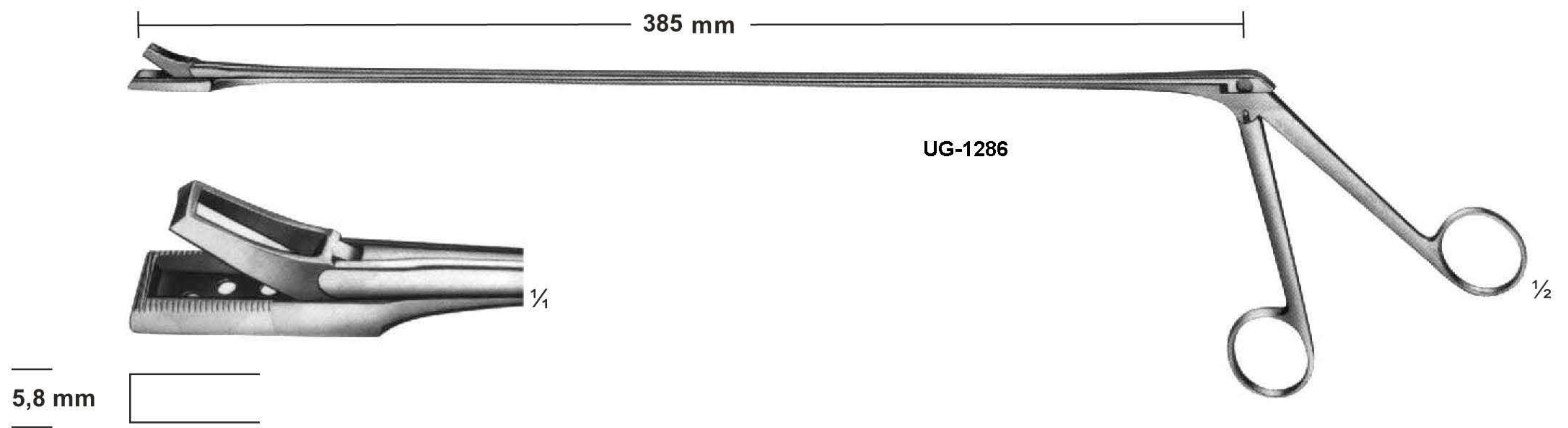

# Biopsy Forceps & Swab Holders

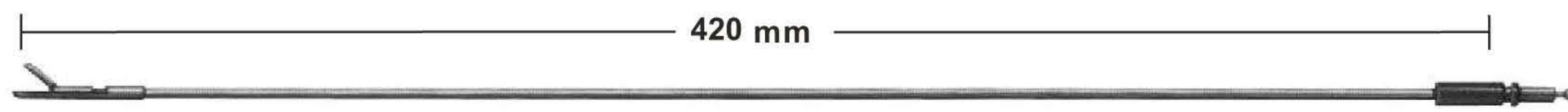

**UG-1291**  
Handle for 119 - 120 - 121 - 122



**UG-1292**  
Biopsy Forceps, spoon-shaped  
oval jaws, straight.

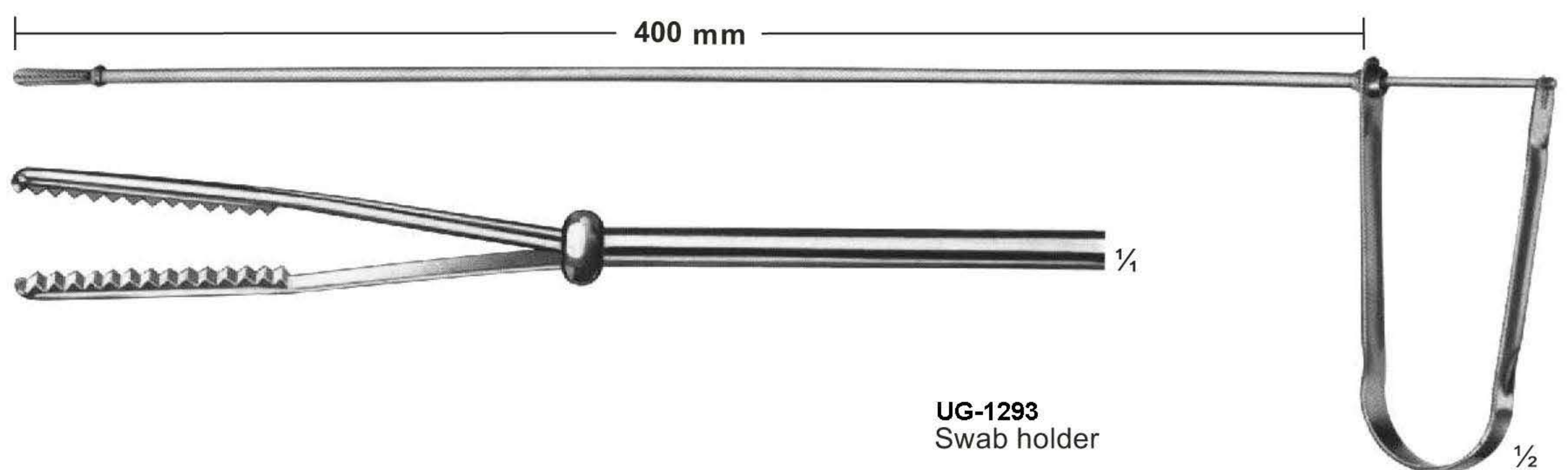

**UG-1293**  
Swab holder



# Haemorrhoidal Forceps

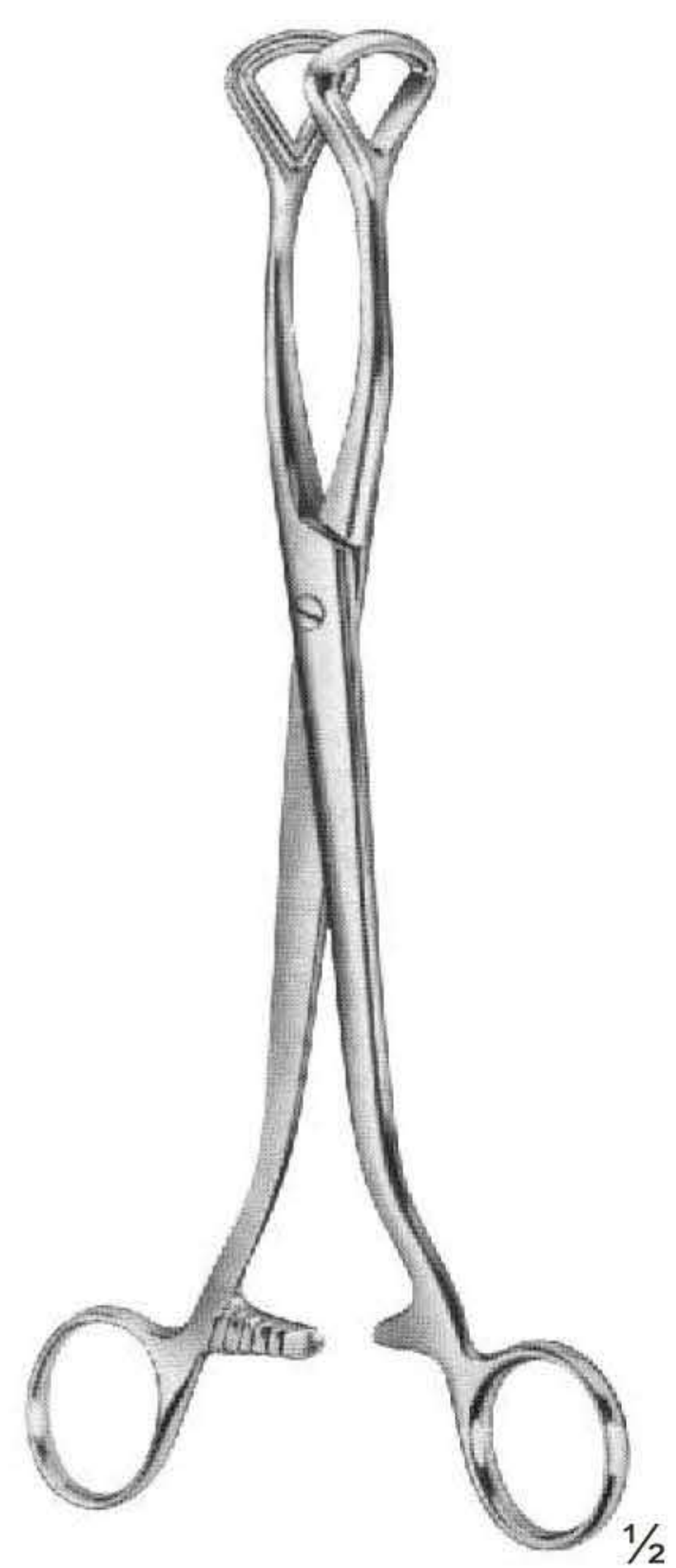

**UG-1294**  
LUER

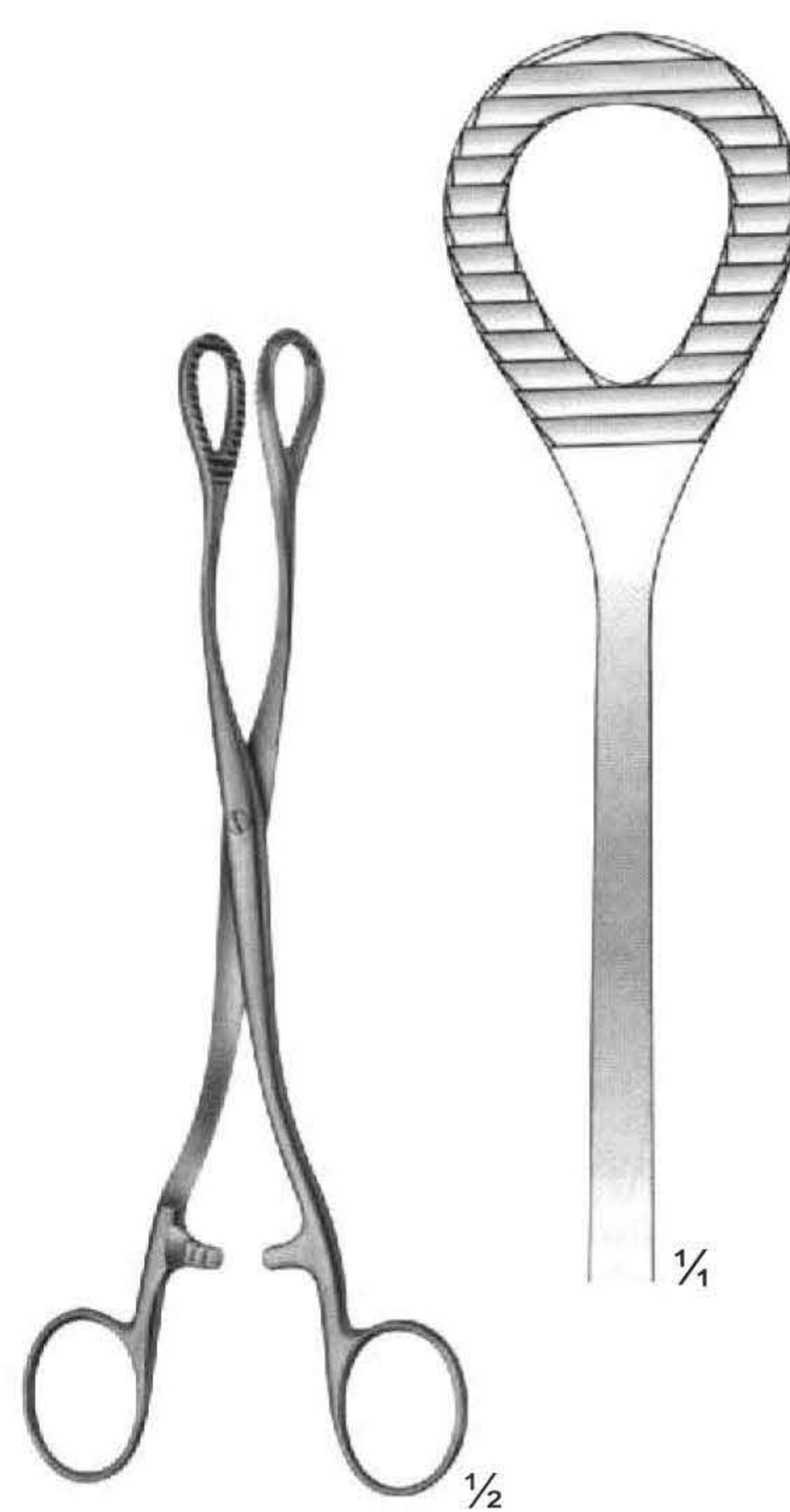

**UG-1295**  
HEYWOOD-SMITH  
200 mm



**UG-1296**  
HEYWOOD-SMITH  
modif  
200 mm

# Haemorrhoidal Forceps



**UG-1300**  
250 mm  
270 mm



**UG-1303**  
FERGUSON  
200 mm



**UG-1304**  
RUDD  
Haemorrhoidal ligator  
with loading  
attachment and 100  
ligature rubber rings  
315 mm

# Gall Duct Forceps



UG-1007  
LOWER  
180 mm



UG-1009  
LAHEY ( SWEET )  
190 mm

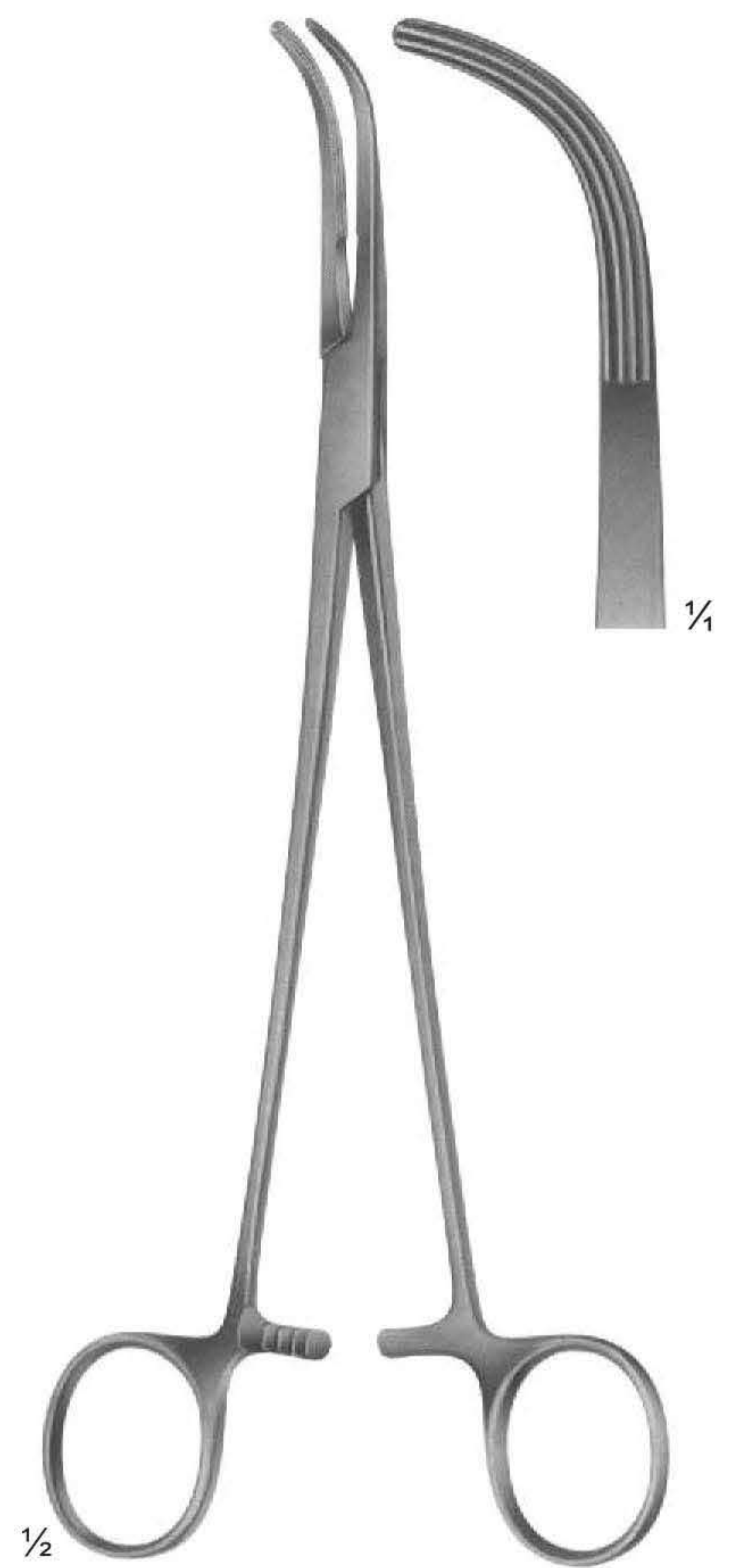

UG-1011  
LAHEY  
220 mm



UG-1012  
DESJARDINS  
Gall duct-and cystic forceps  
210 mm

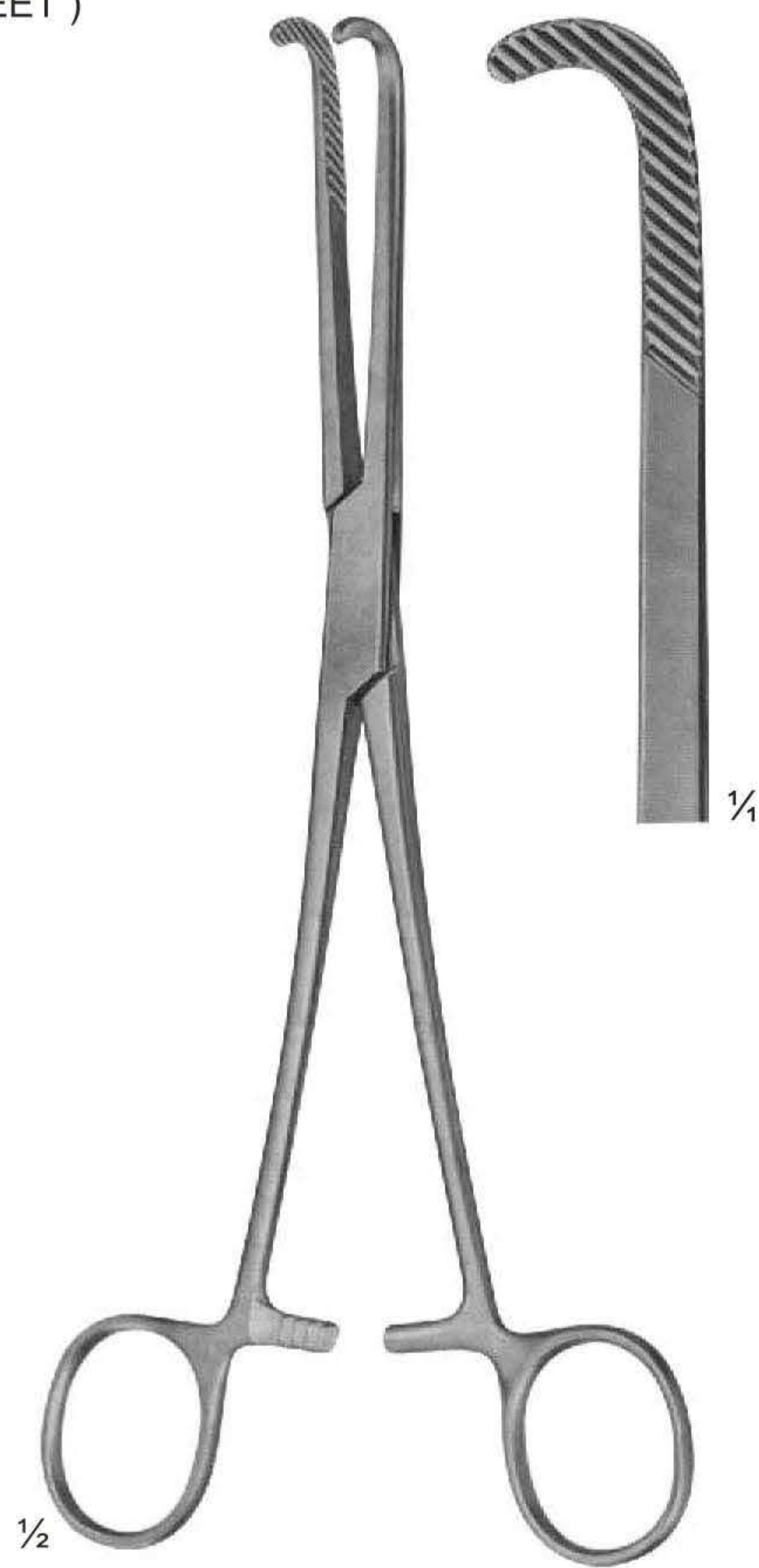

UG-1014  
NISSEN  
Gall duct-and cystic forceps  
215 mm

## Gall Duct Forceps and Choledochus Forceps

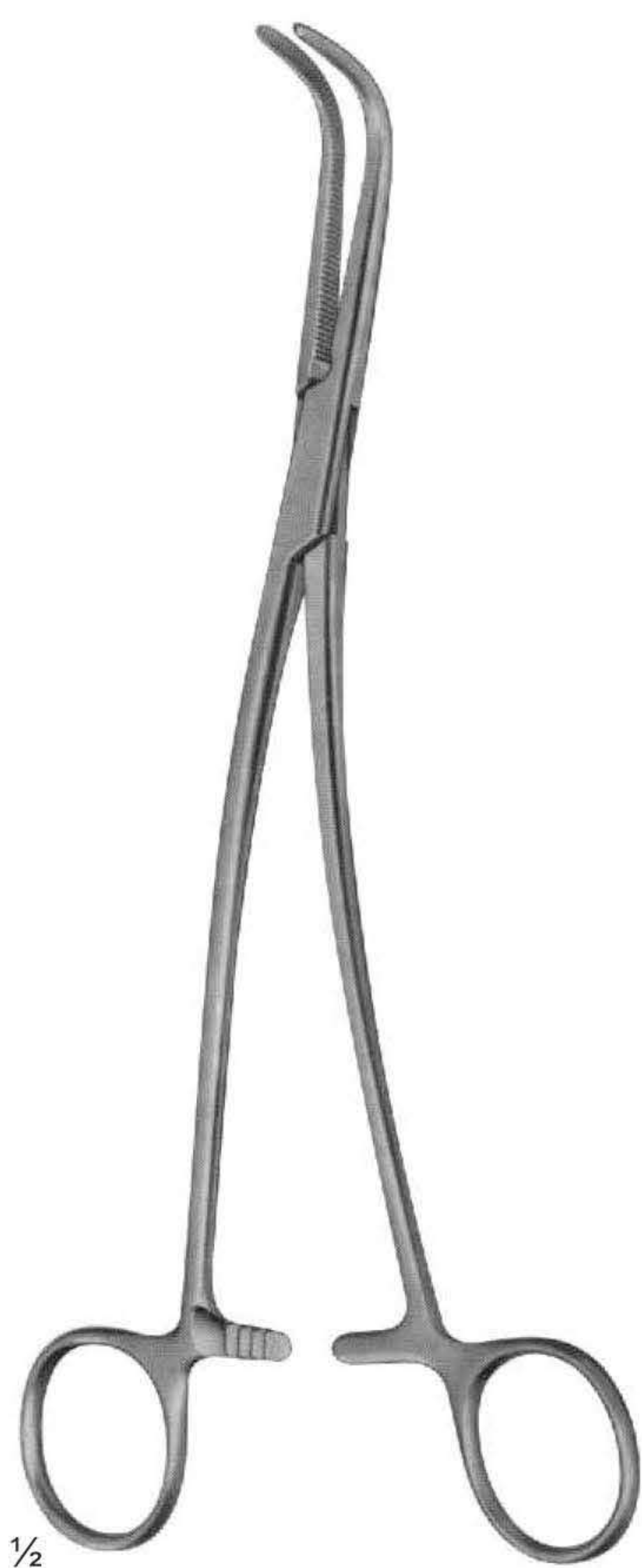

UG-1017  
GRAY  
180 mm



UG-1020  
MIXTER  
Gall duct-and cystic forceps  
230 mm



UG-1022  
FOERSTER-BALLENGER  
240 mm

# Gall Bladder Forceps and Gall Duct Scissors

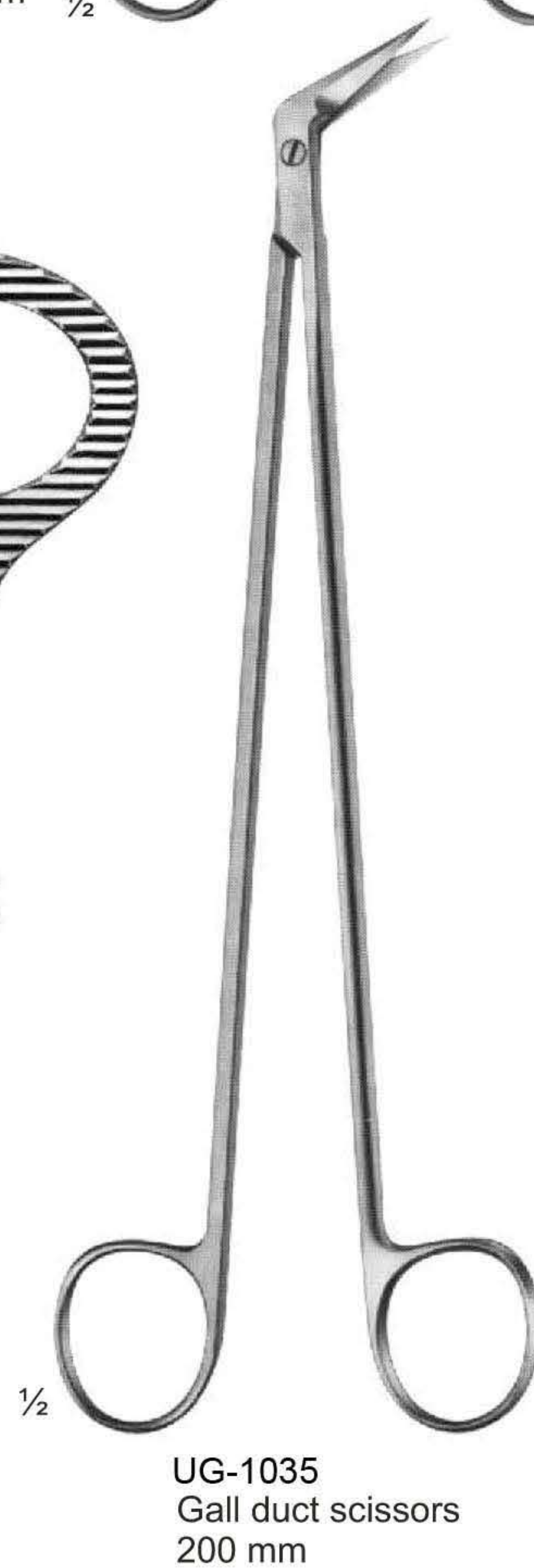
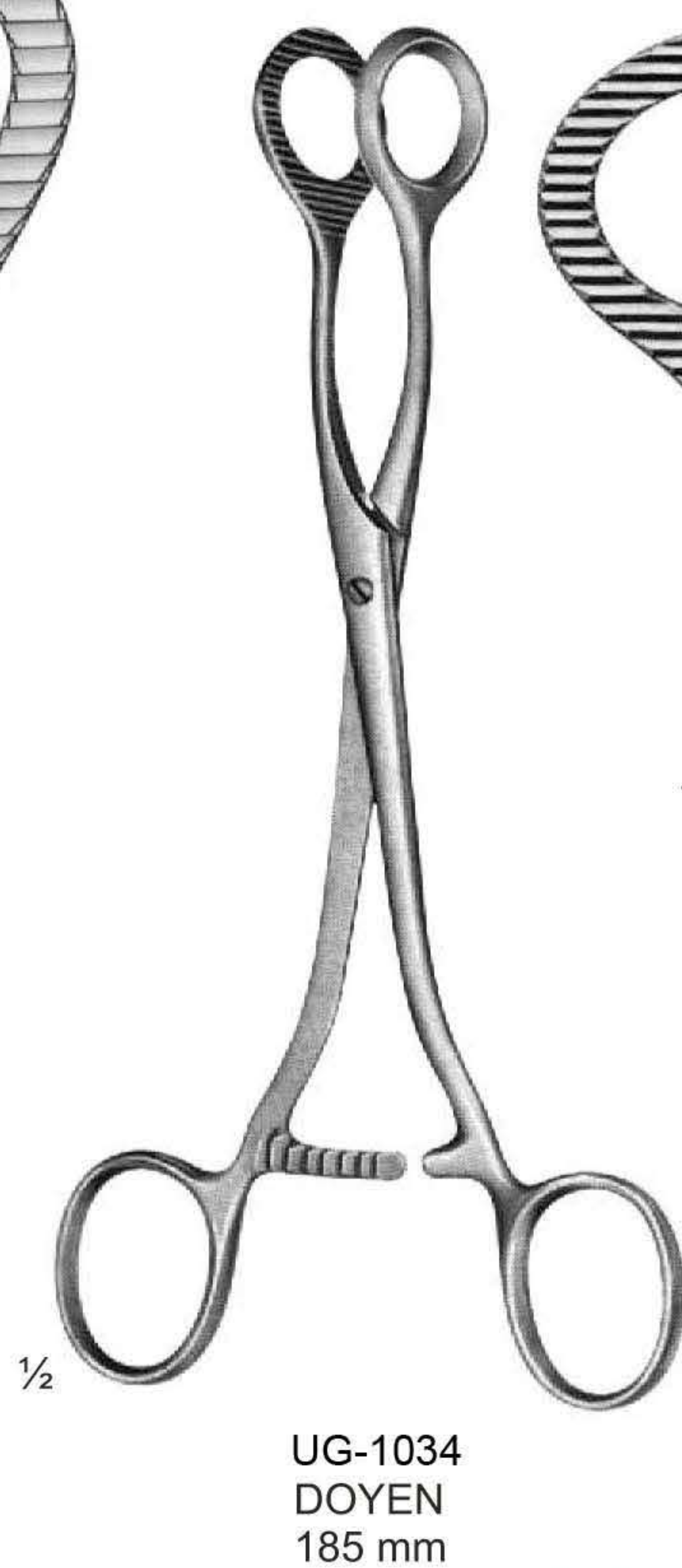
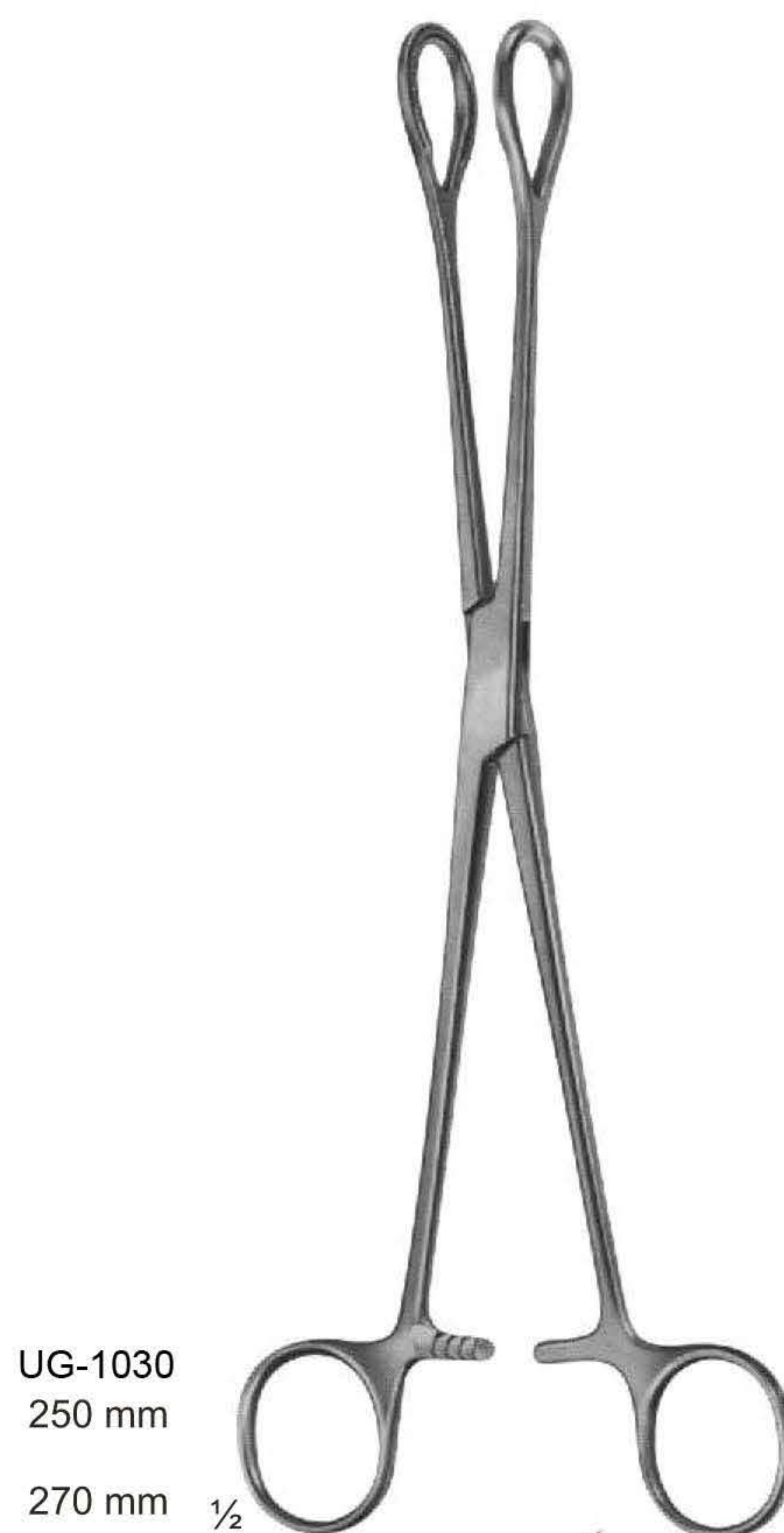
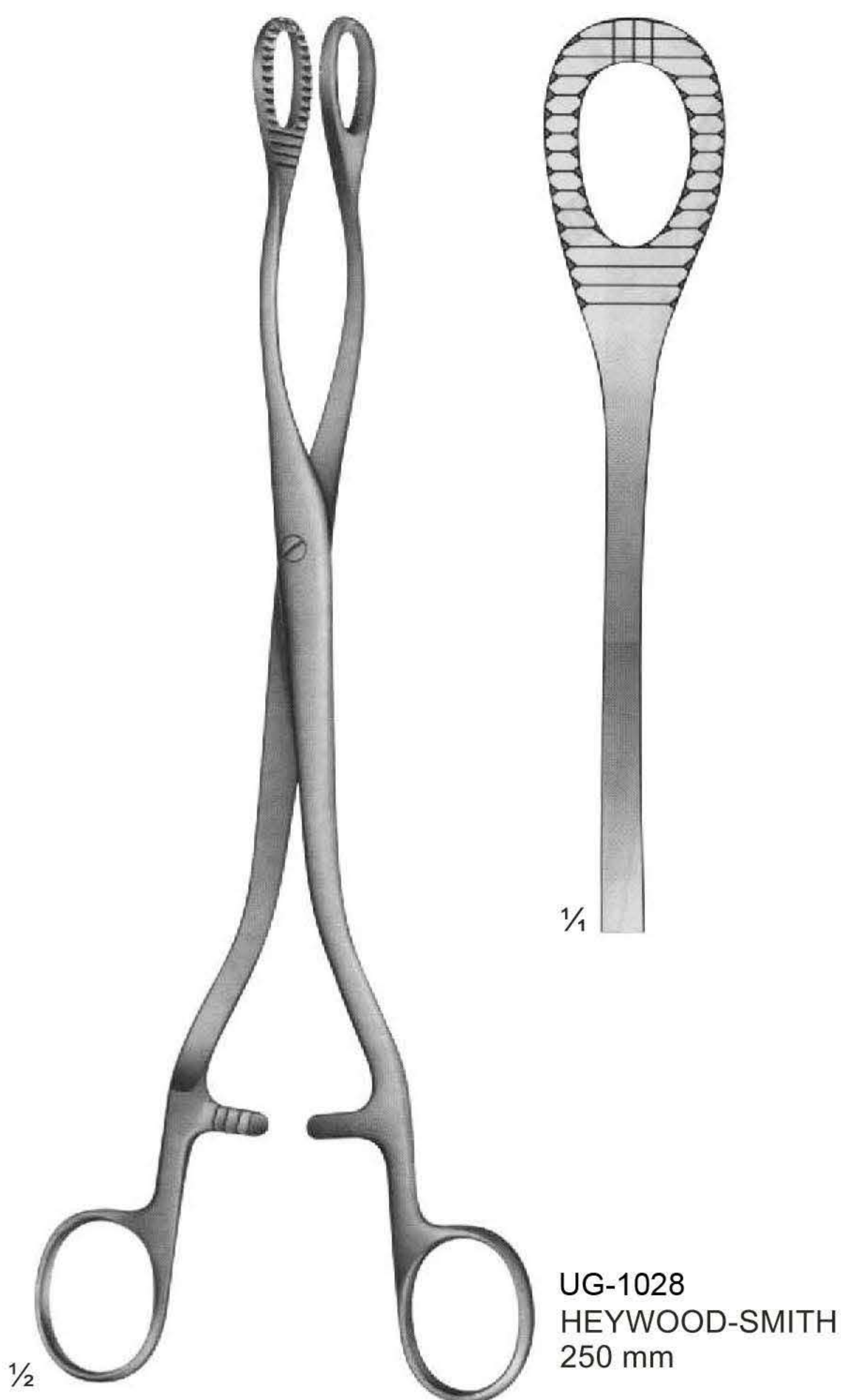

# Gall Duct Probes

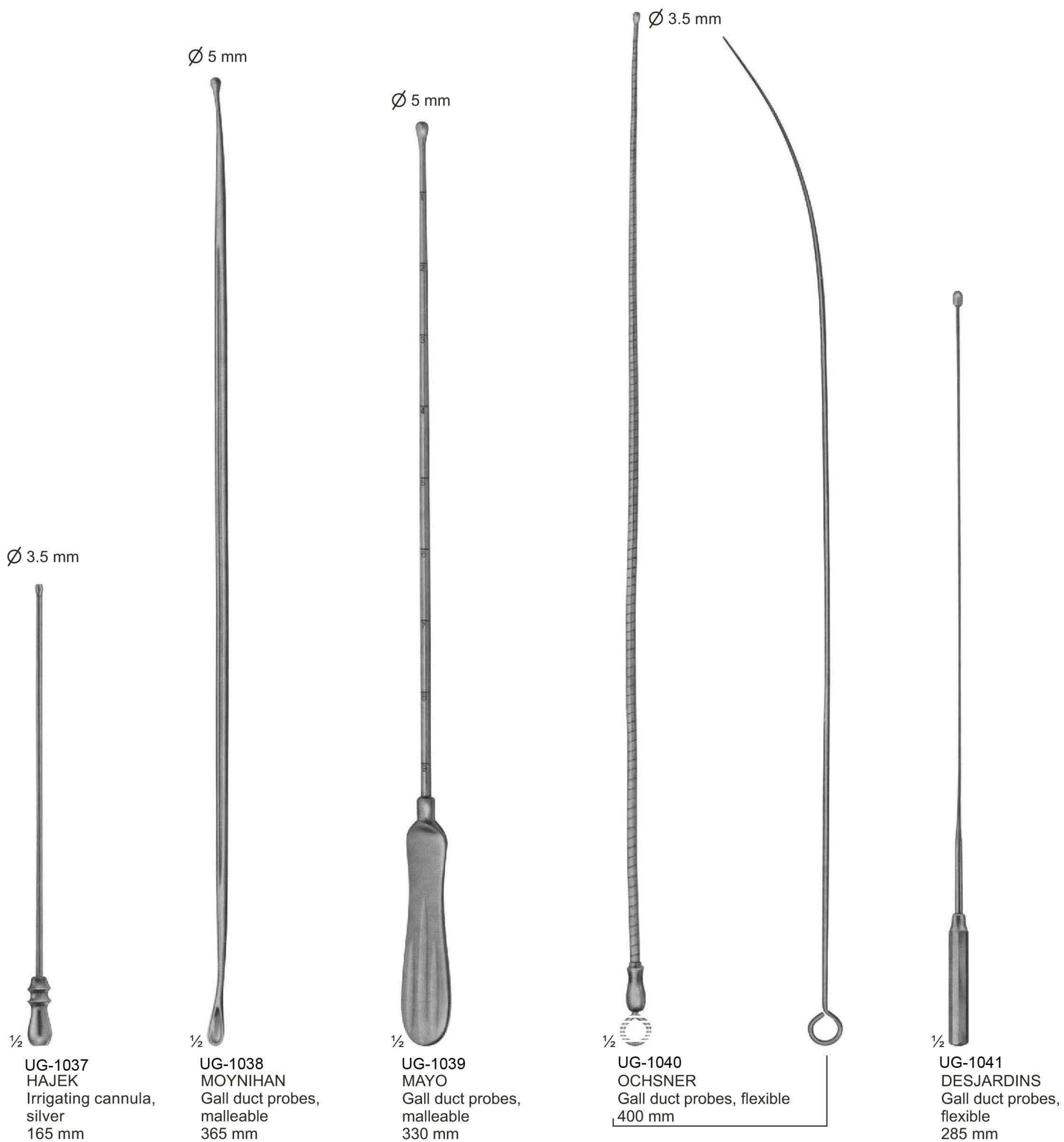

# Gall Duct Dilators & Gall Stone Scoops



UG-1042  
DITTEL  
Metall bougies and  
dilating sounds, stiff  
345 mm



UG-1045  
BAKES  
Common bile duct  
dilators, malleable  
315 mm, 320 mm



UG-1053  
DESJARDINS  
Probes and catch  
with flexible schaft  
300 mm



UG-1061  
LUER-KORTE modif  
with malleable shaft  
310 mm

# Gall Stone Forceps

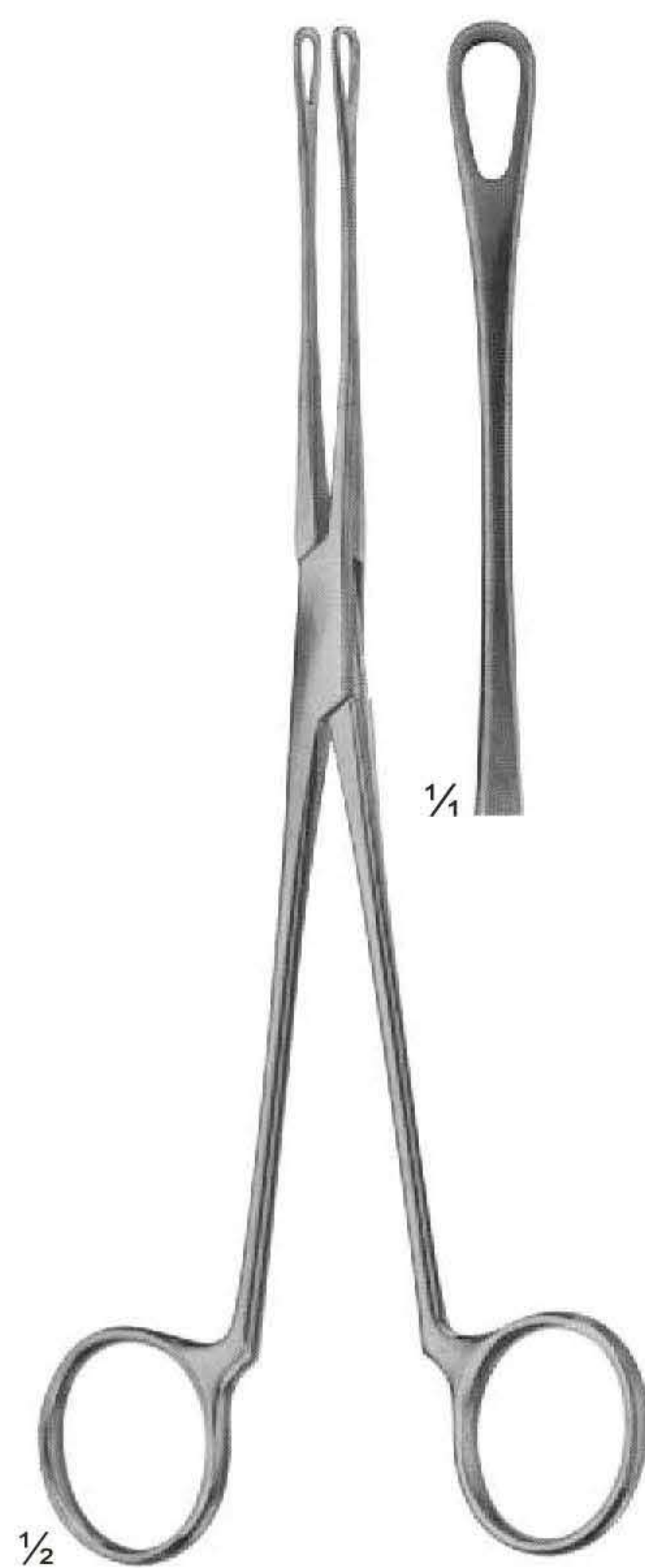

UG-1071  
BLAKE  
205 mm

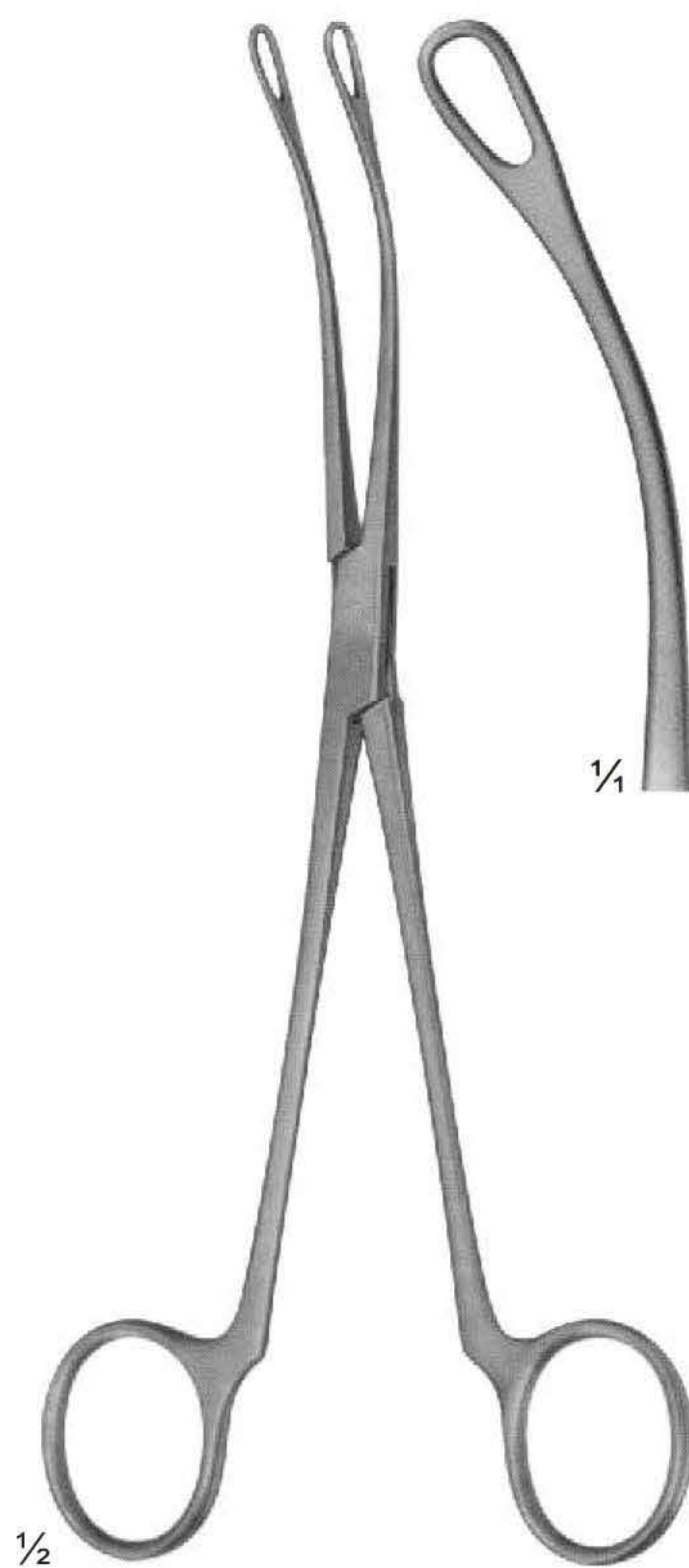

UG-1073  
BLAKE  
205 mm

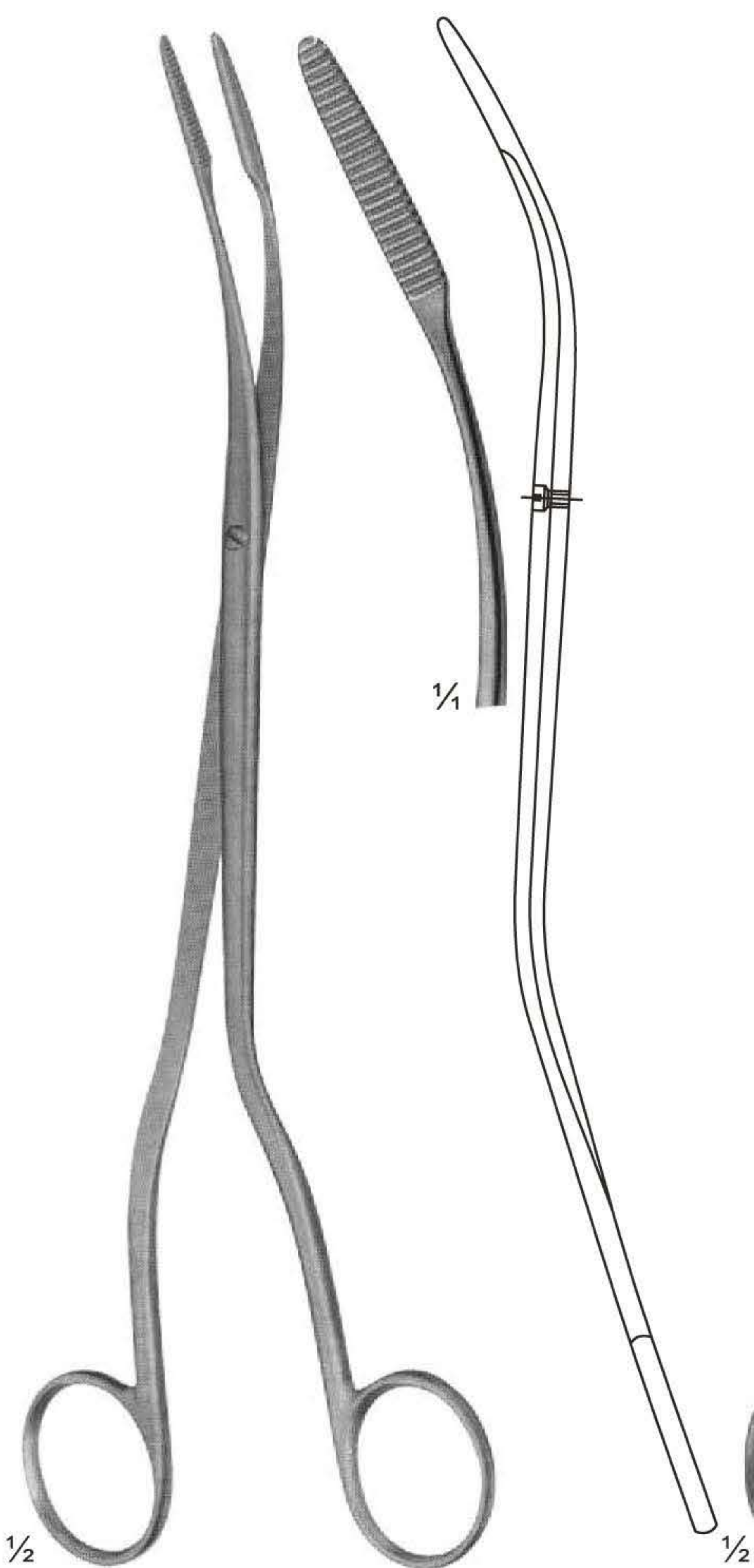

UG-1075  
CZERNY  
245 mm

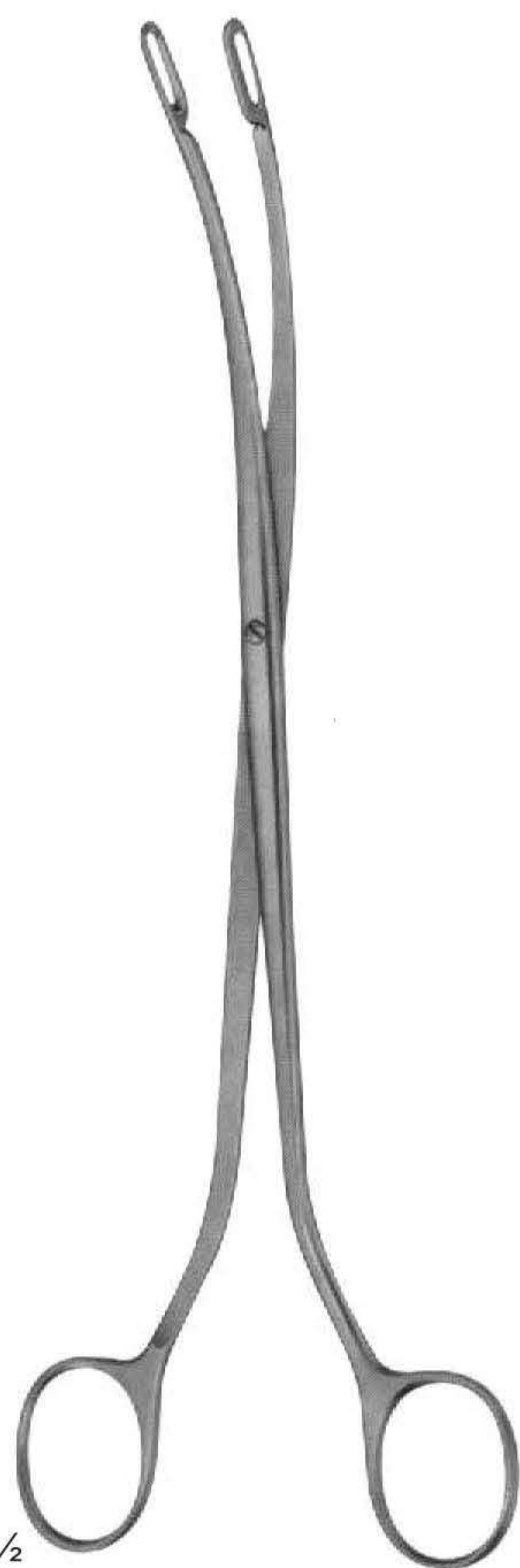

UG-1077  
DESJARDINS  
225 mm

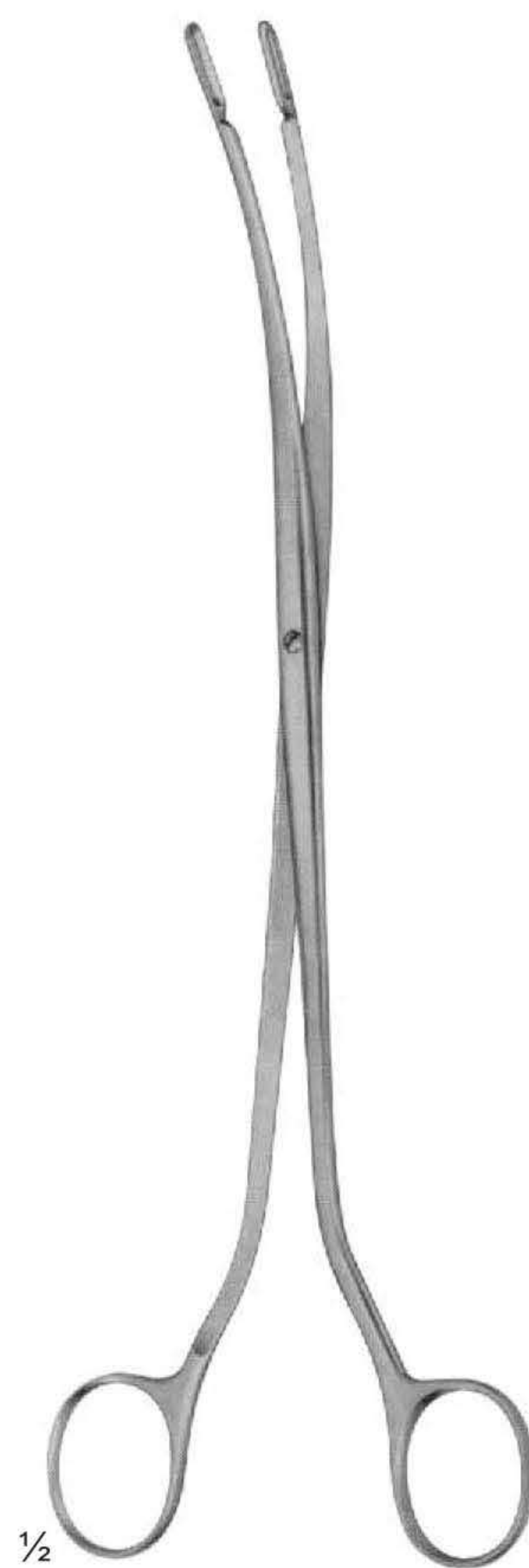

UG-1078  
DESJARDINS  
Extremely delicate patterns



# Scalpel Handles

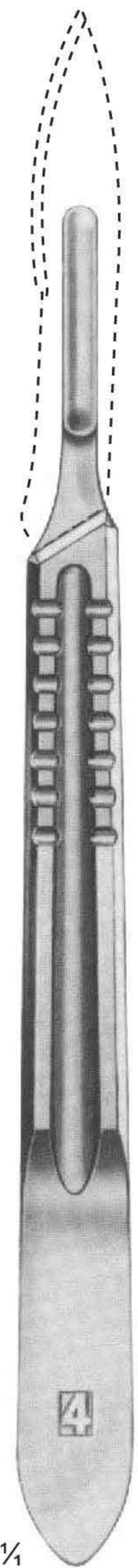

¼  
UG-216  
STANDARD  
SIZE:130mm



¼  
UG-218  
Double Handel  
SIZE:230mm



¼  
UG-230  
Straight  
SIZE:200mm

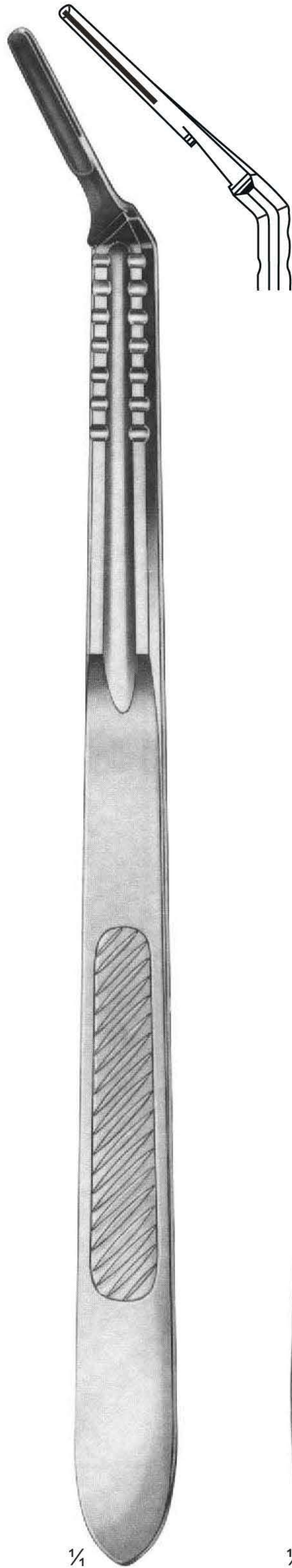

¼  
UG-221  
SIZE:215mm  
Scalpel  
Handles



¼  
UG-223  
COLLIN  
SIZE:145mm

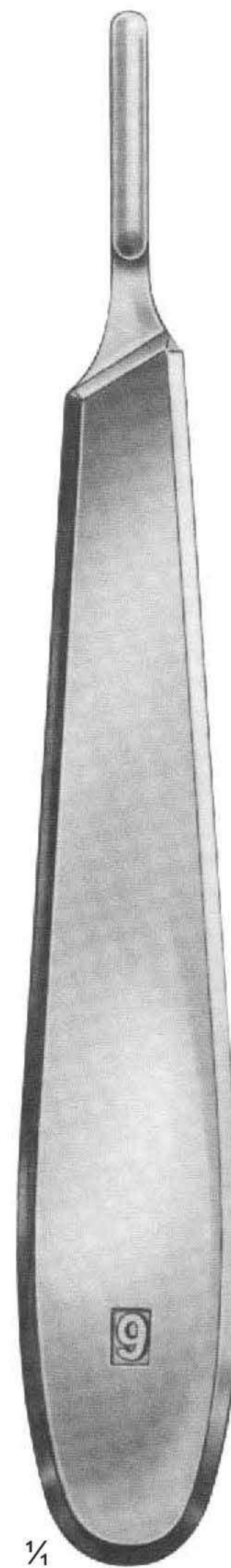

¼  
UG-224  
COLLIN  
SIZE:115mm



¼  
UG-226  
Plastic  
SIZE:115mm

# Scalpel Handles

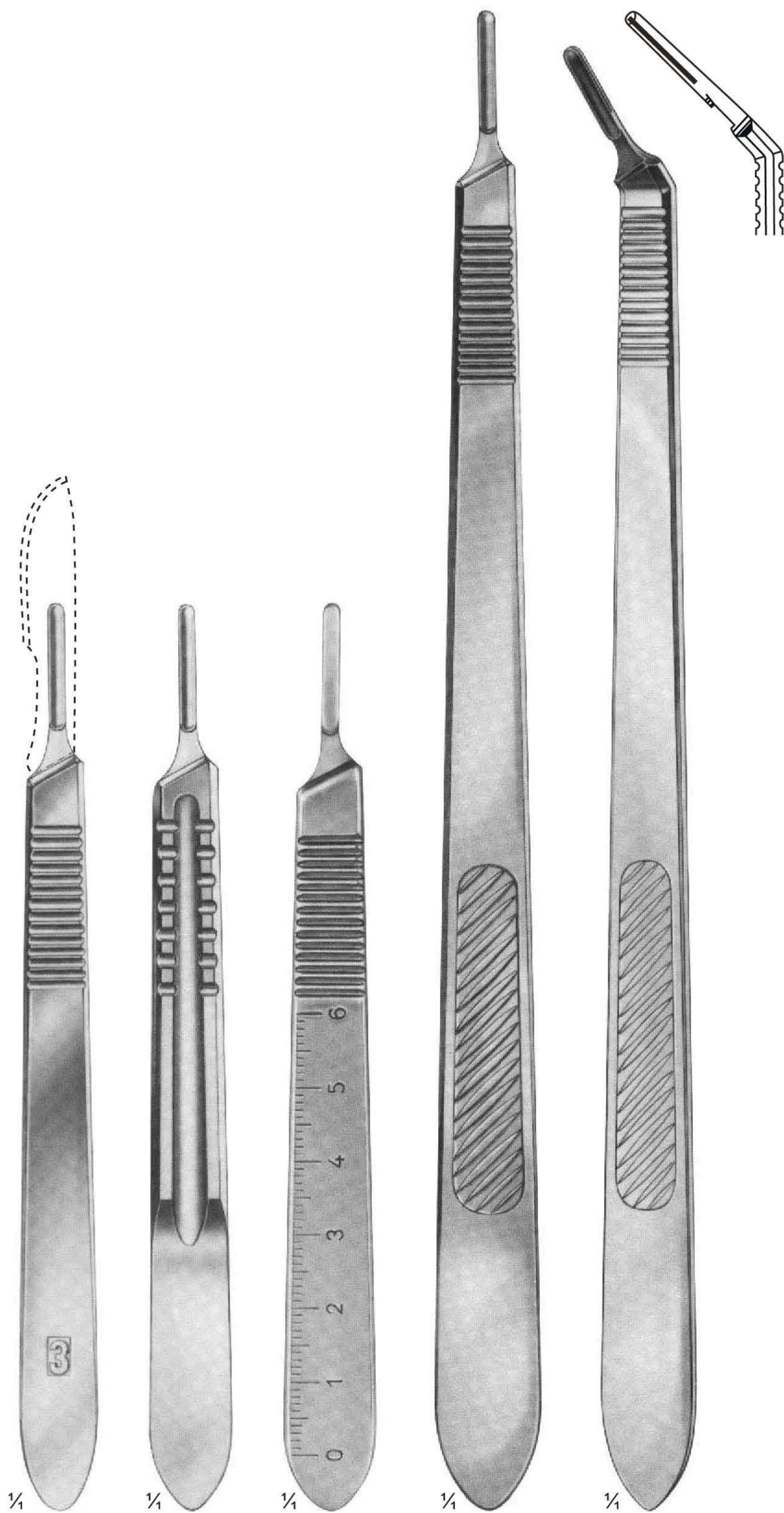

$\frac{1}{4}$  UG-228 STANDARD No. 3 SIZE: 100mm  
 $\frac{1}{4}$  UG-229 No. 3 SIZE: 135mm  
 $\frac{1}{4}$  UG-230 No. 3 SIZE: 130mm

$\frac{1}{4}$  UG-232 No. 3 L  
 $\frac{1}{4}$  UG-235 No. 3 L SIZE: 145mm

## Micro Scissors, "Spring Type" Flat Handles



1/2

**UG-022**  
VANNAS  
Size: 85 mm



1/2

**UG-028**  
CASTROVIEJO  
Size: 95 mm



1/2

**UG-031**  
NOYES  
Size: 125 mm



1/2

**UG-032**  
WECKER  
Eye Scissor  
Size: 110 mm



1/2

**UG-033**  
CASTROVIEJO  
Eye Scissor  
Size: 115 mm



1/2

**UG-036**  
CASTROVIEJO  
Eye Scissor  
Size: 110 mm

# Micro Scissors, "Spring Type" Flat Handles



1/2  
**UG-043**  
 Size: 120 mm

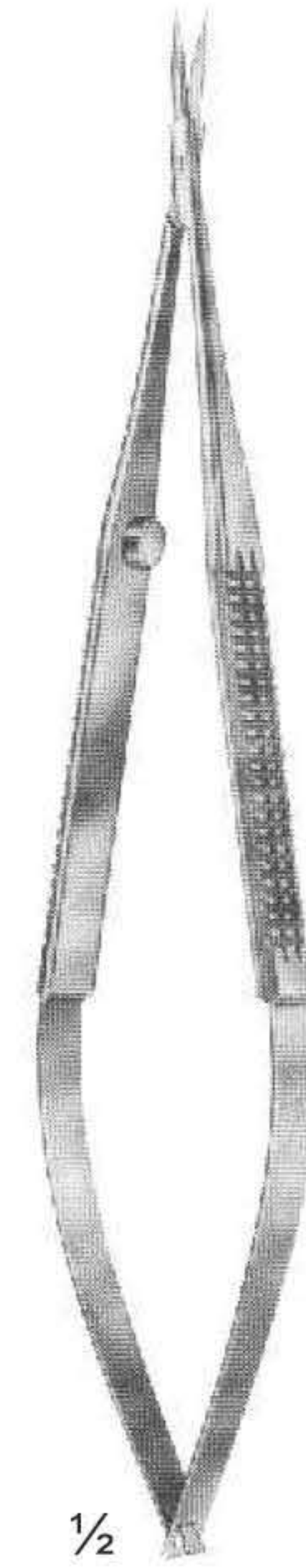

1/2  
**UG-046**  
 VANNAS  
 Size: 160 mm

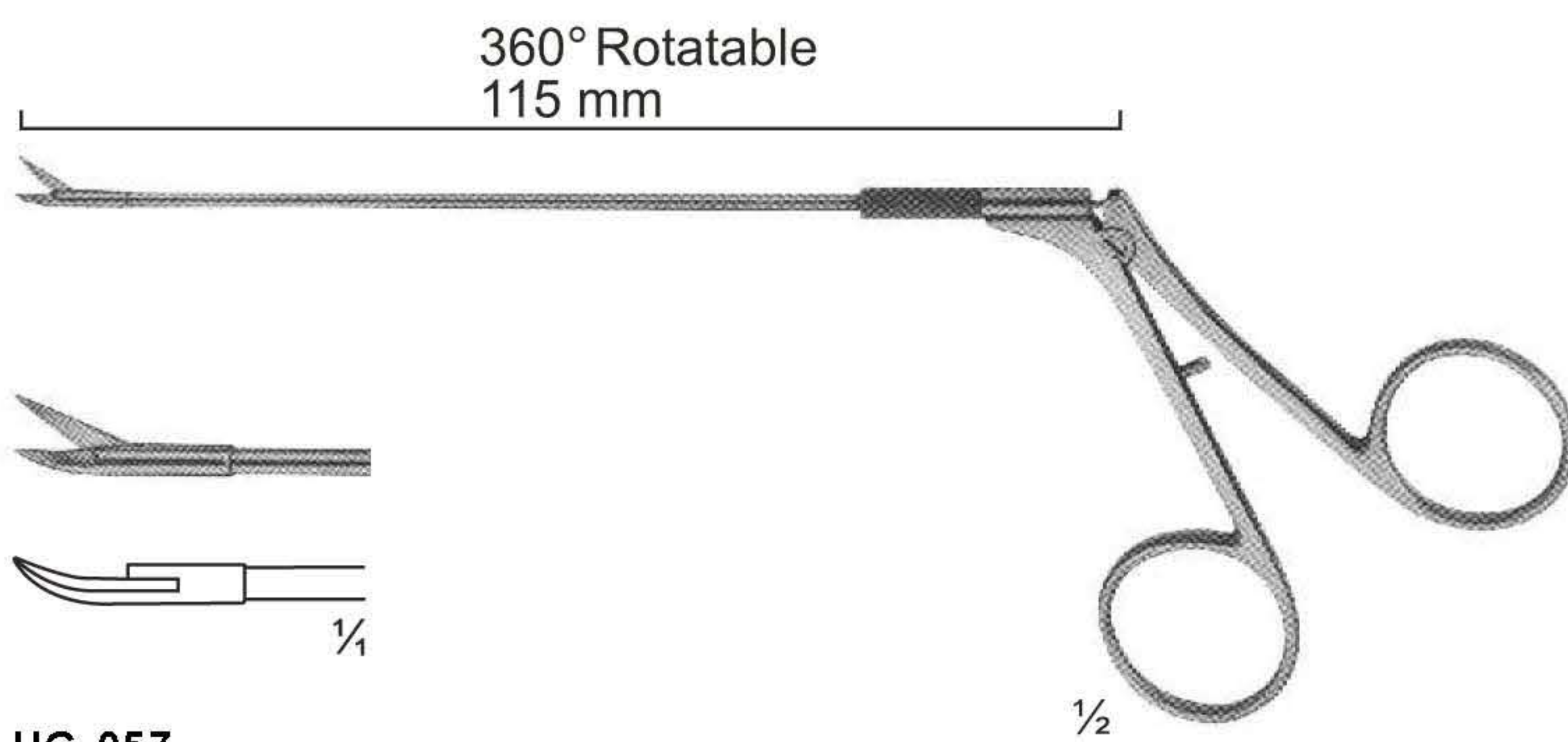

360° Rotatable  
 115 mm  
 1/4  
**UG-057**  
 CASPAR  
 Micro Scissor Curved  
 Size: 115 mm



1/2  
**UG-061**  
 Micro Dissecting Scissor  
 Size: 145 mm

# Micro Scissors, "Spring Type" Bayonet Shape

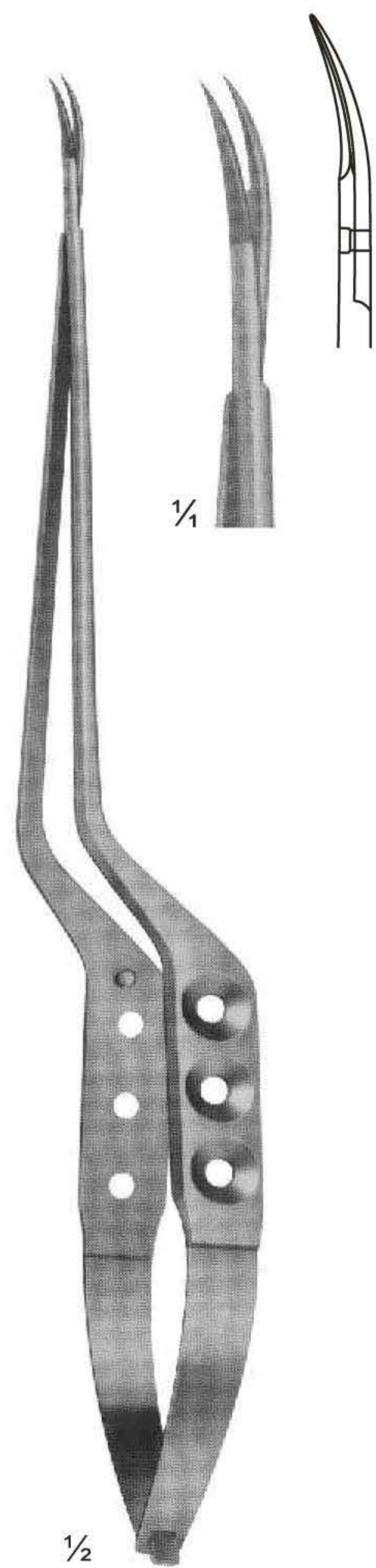

**UG-069**  
YASARGIL  
Size: 245 mm

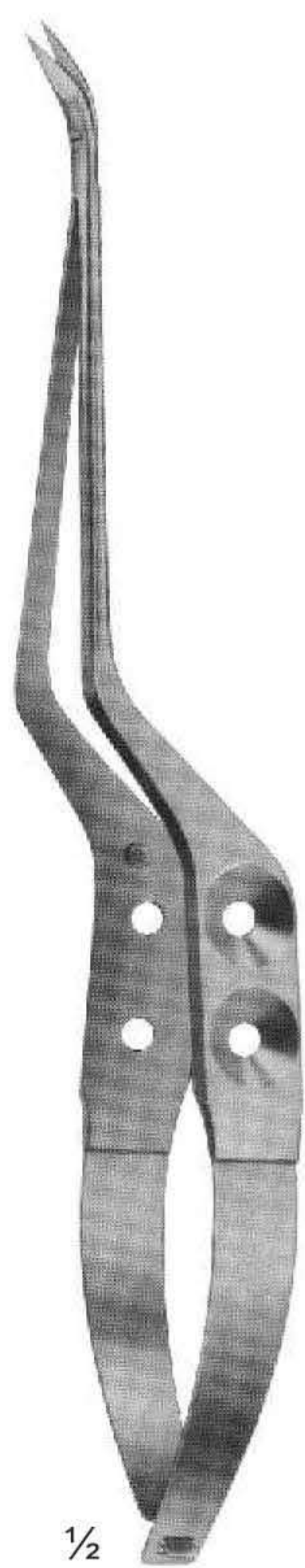

**UG-070**  
Laterally Angled  
Size: 200 mm

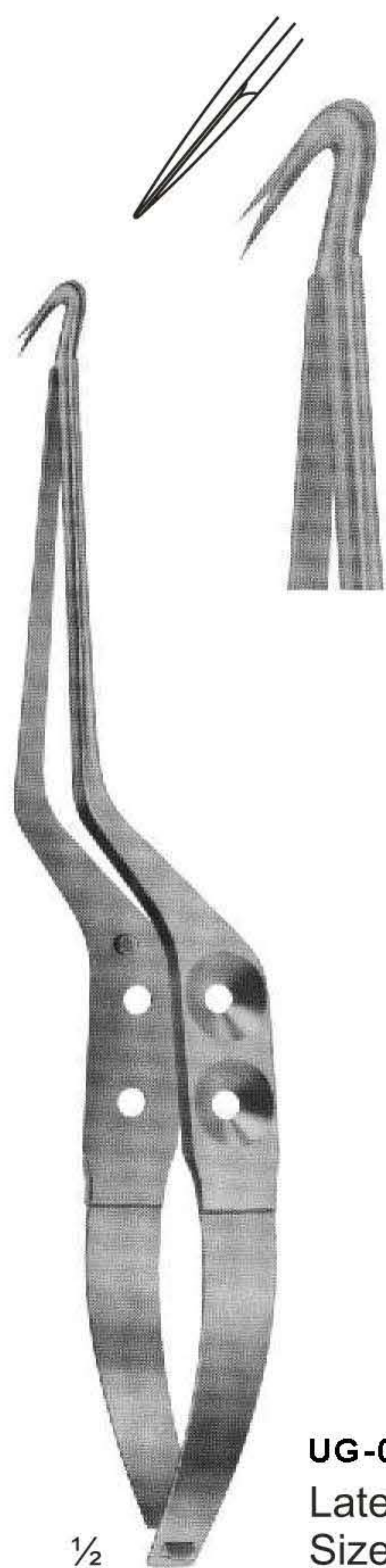

**UG-073**  
Laterally Angled  
Size: 190 mm



**UG-074**  
YASARGIL  
Size: 225 mm

## Delicate Scissors

---



**UG-077**  
Size: 120 mm



**UG-089**  
STEVENS  
Dissecting Scissors  
Size: 115 mm



**UG-092**  
METZENBAUM  
Dissecting Scissors  
Size: 145 mm

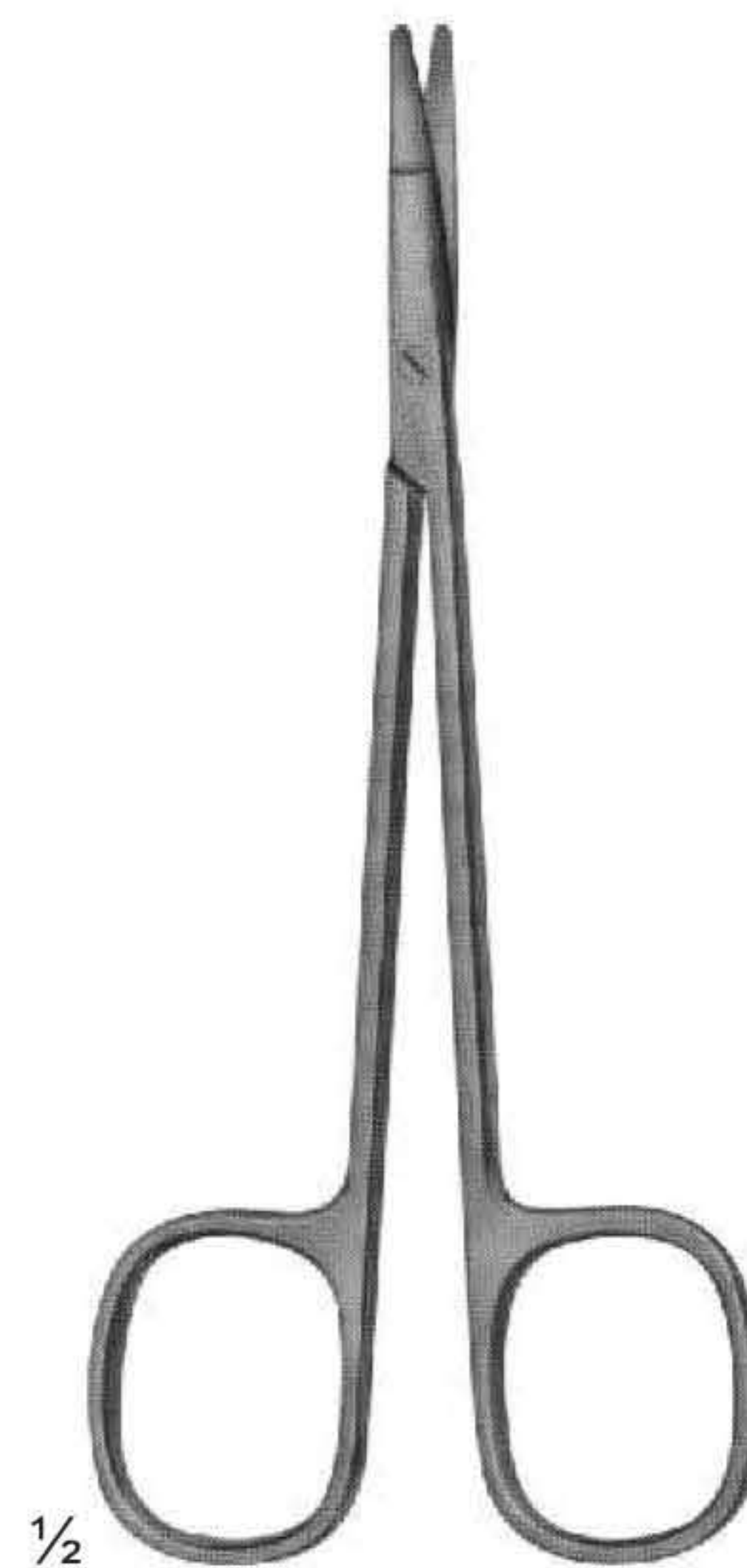

**UG-095**  
Special flat points for  
dissecting and  
undermining the skin  
Size: 145 mm

## Delicate Scissors

---



**UG-099**  
Size: 90 mm



**UG-103**  
Size: 95 mm



**UG-113**  
Size: 105 mm



**UG-119**  
Size: 120 mm



**UG-124**  
Size: 115 mm



**UG-127**  
Size: 120 mm



**UG-127**  
Size: 130 mm



# Delicate Scissors



**UG-134**  
**JOSEPH**  
Size: 150 mm

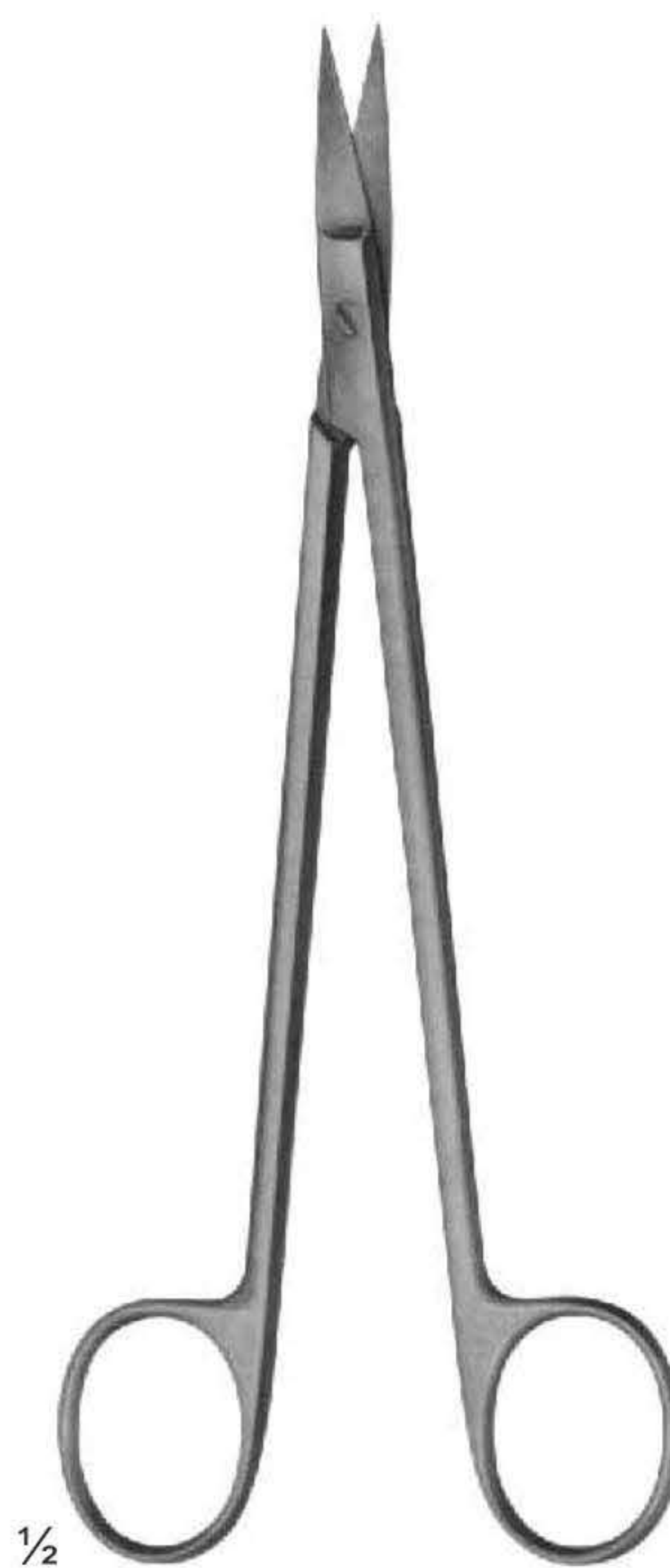

**UG-138**  
**KELLY**  
Size: 175 mm

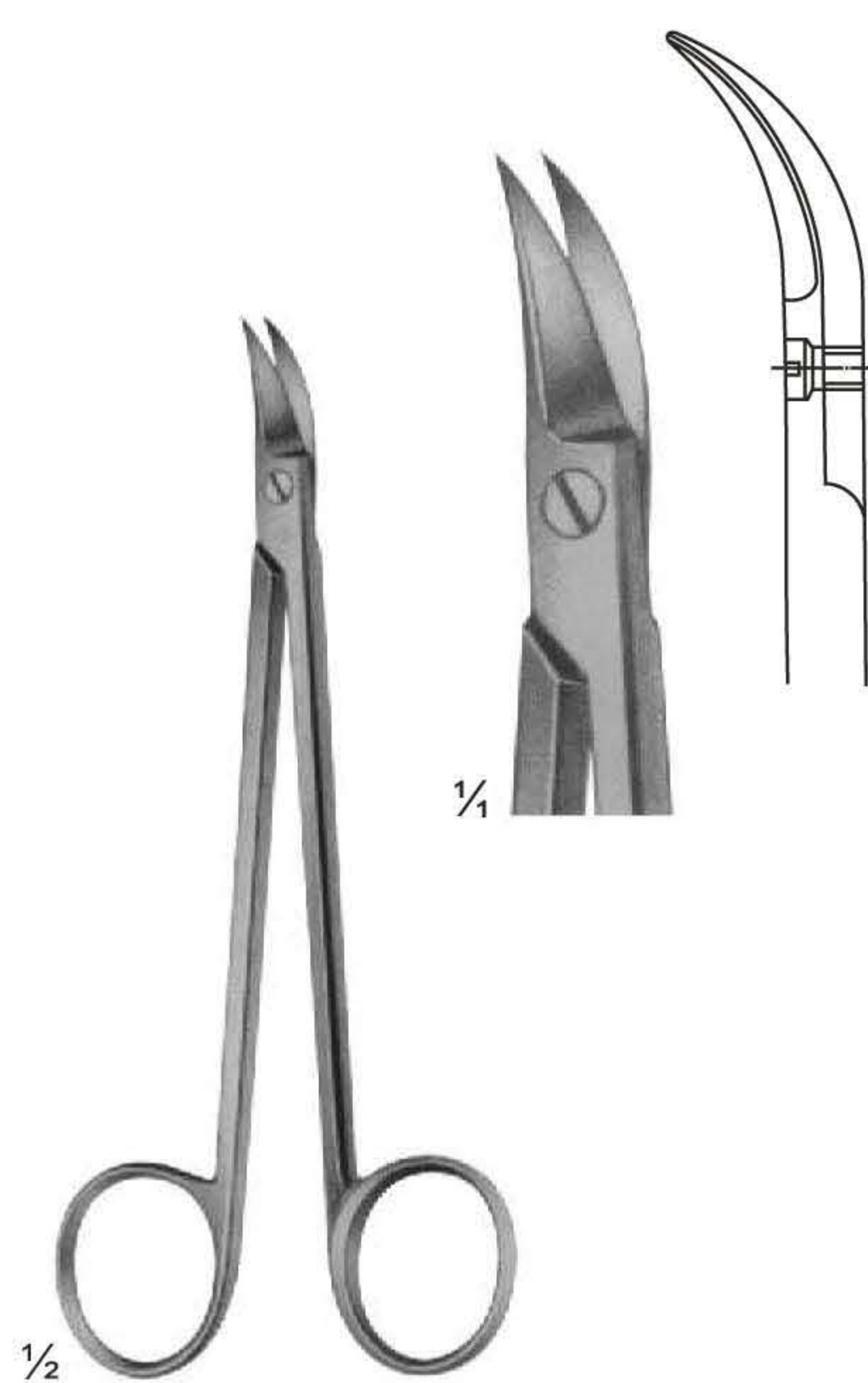

**UG-141**  
**QUINBY**  
Size: 130 mm

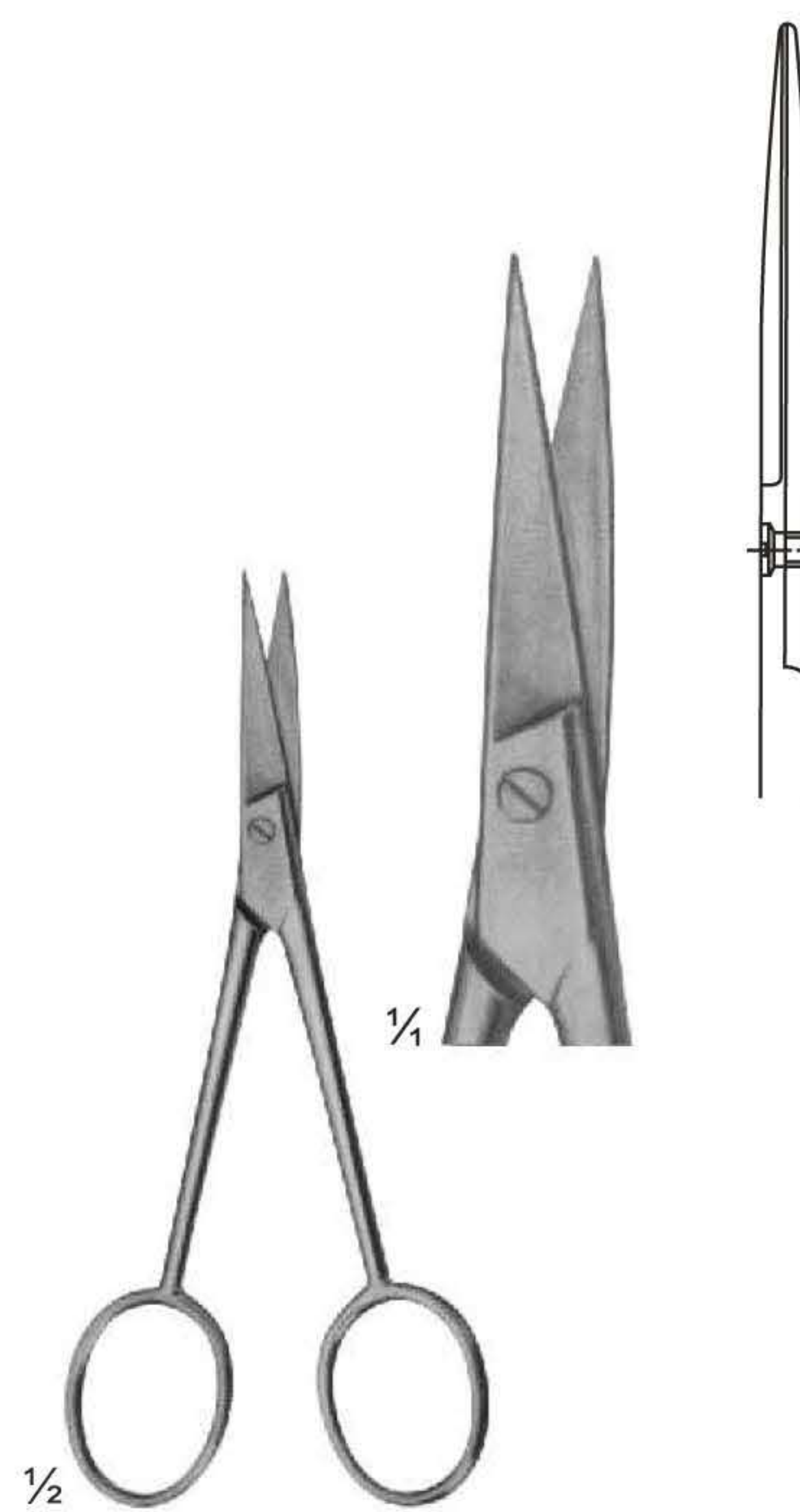

**UG-142**  
Size: 110 mm

# Surgical Scissors

---

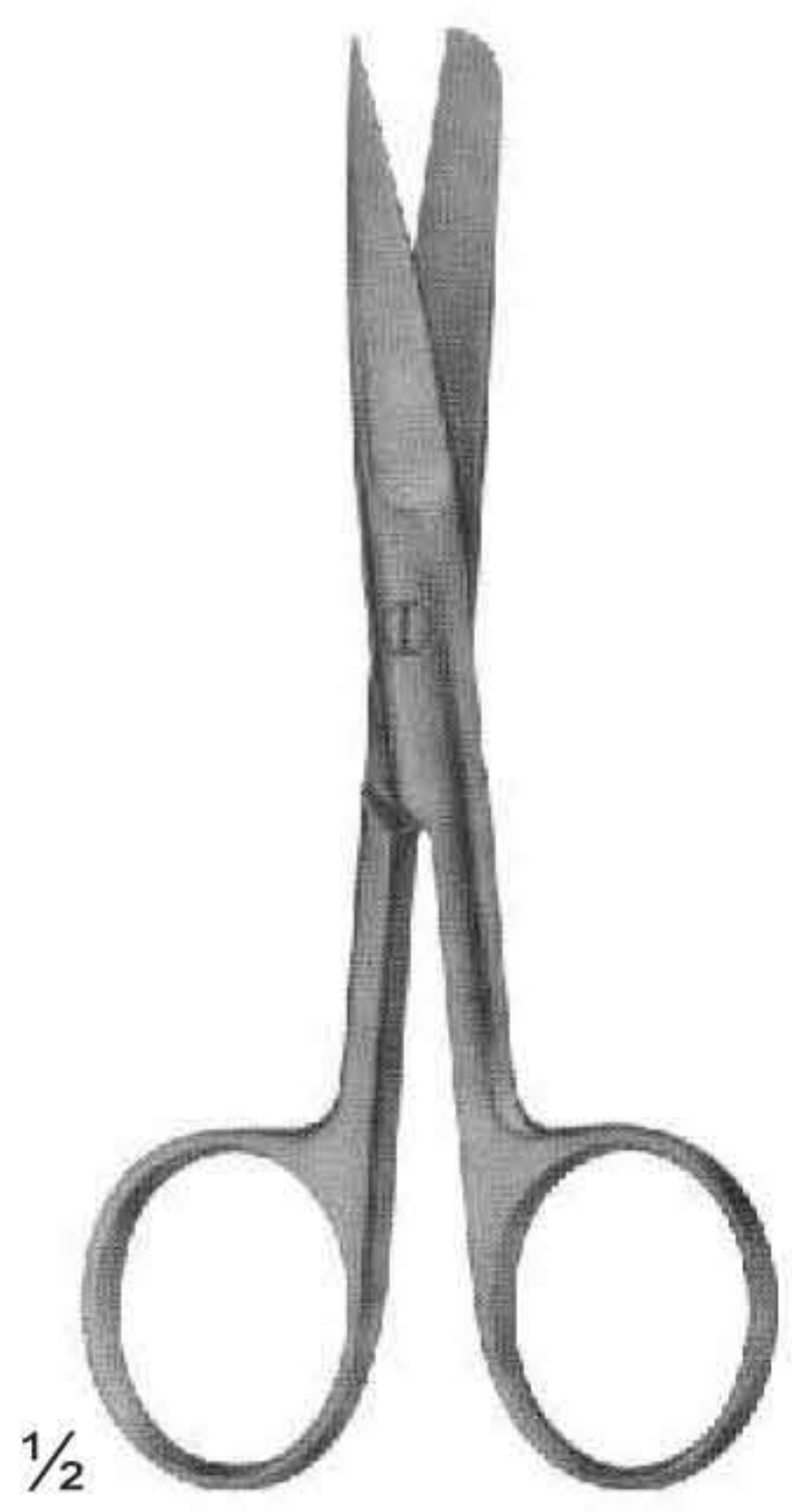

**UG-147**

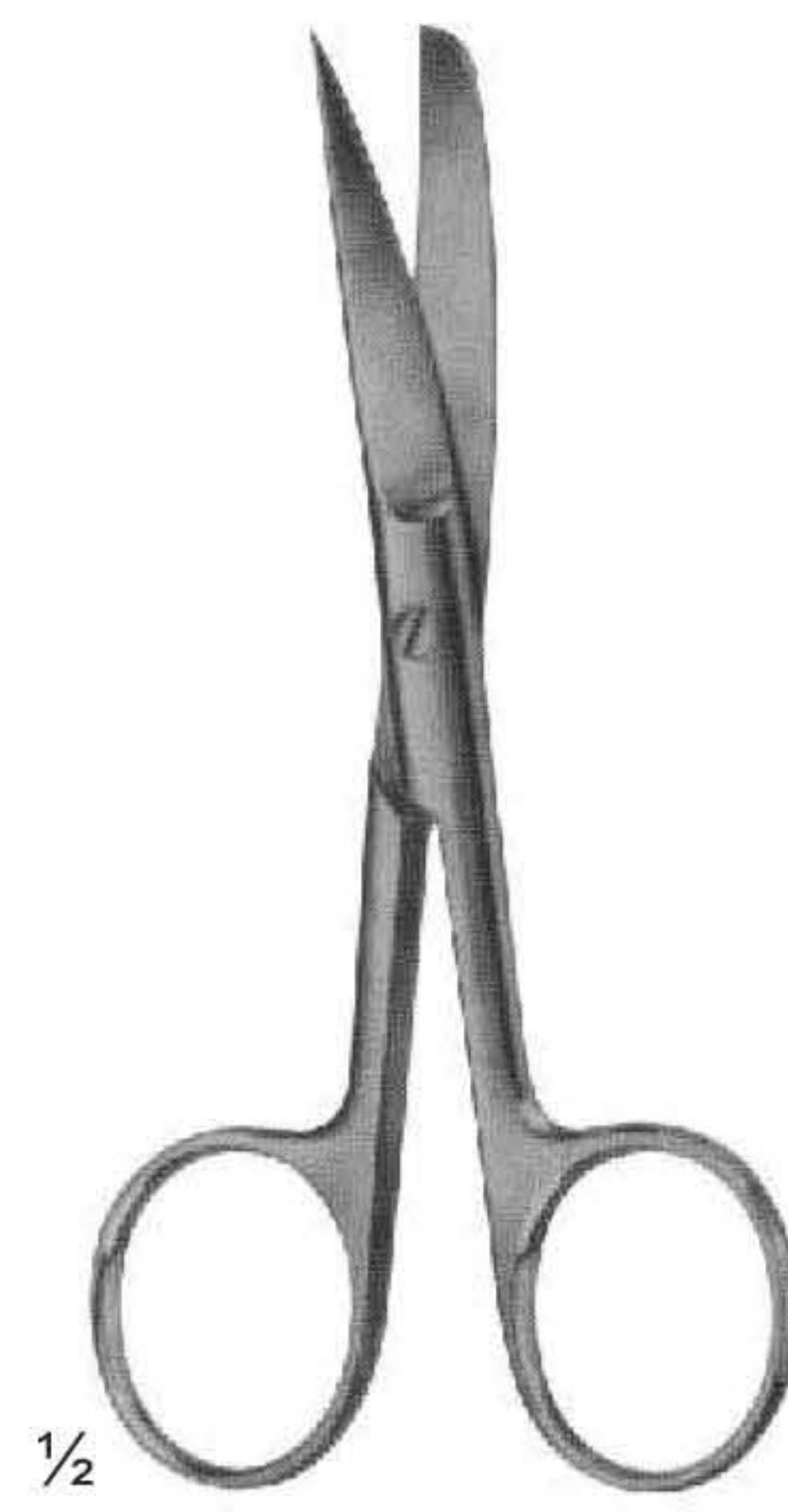

**UG-152**



**UG-154**  
Slender Types



**UG-157**  
For Wound Edges  
1 Blade Serrated

# Surgical Scissors

---



**UG-161**



**UG-164 COOPER**



**UG-166**  
Standard Types



**UG-168**  
Standard Types

# Surgical Scissors

---

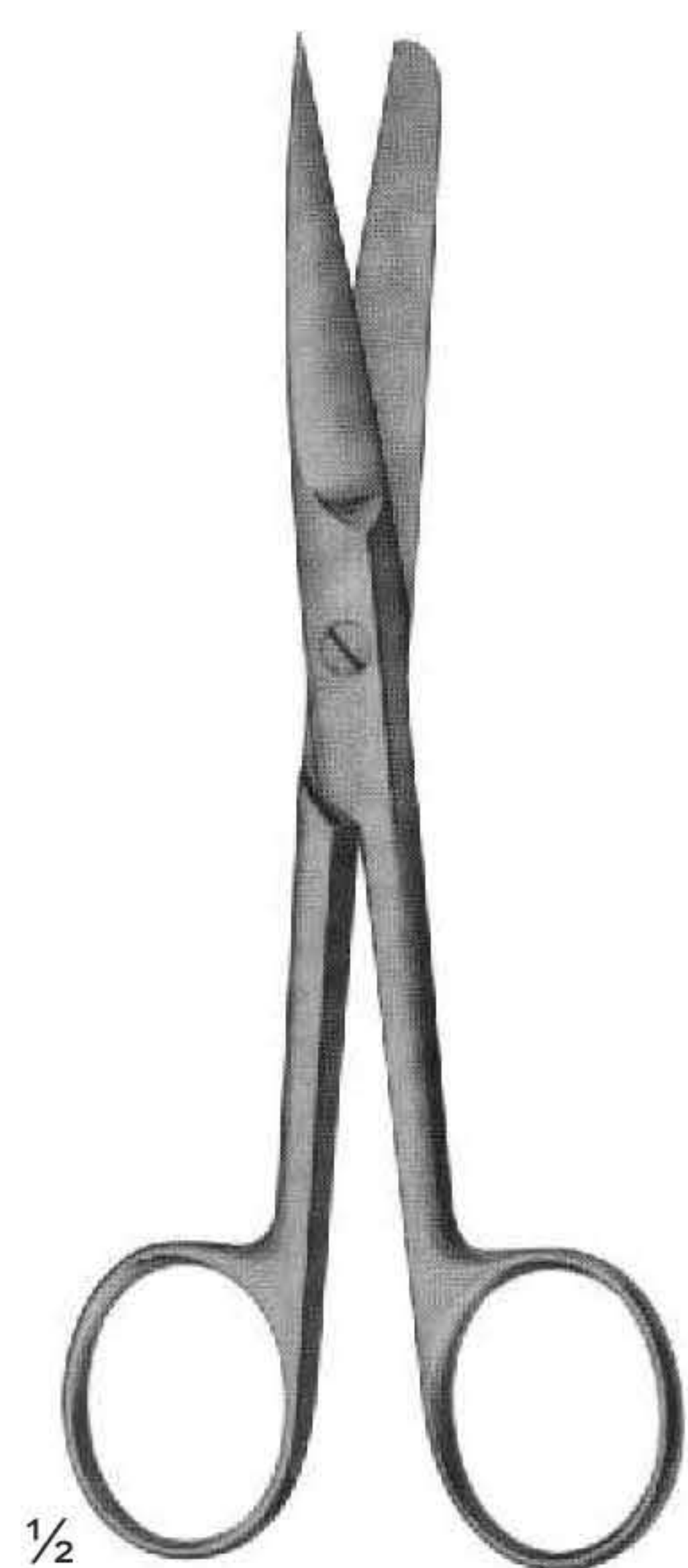

**UG-171**

DEAVER  
With flat lock



**UG-175**

Incision Scissors

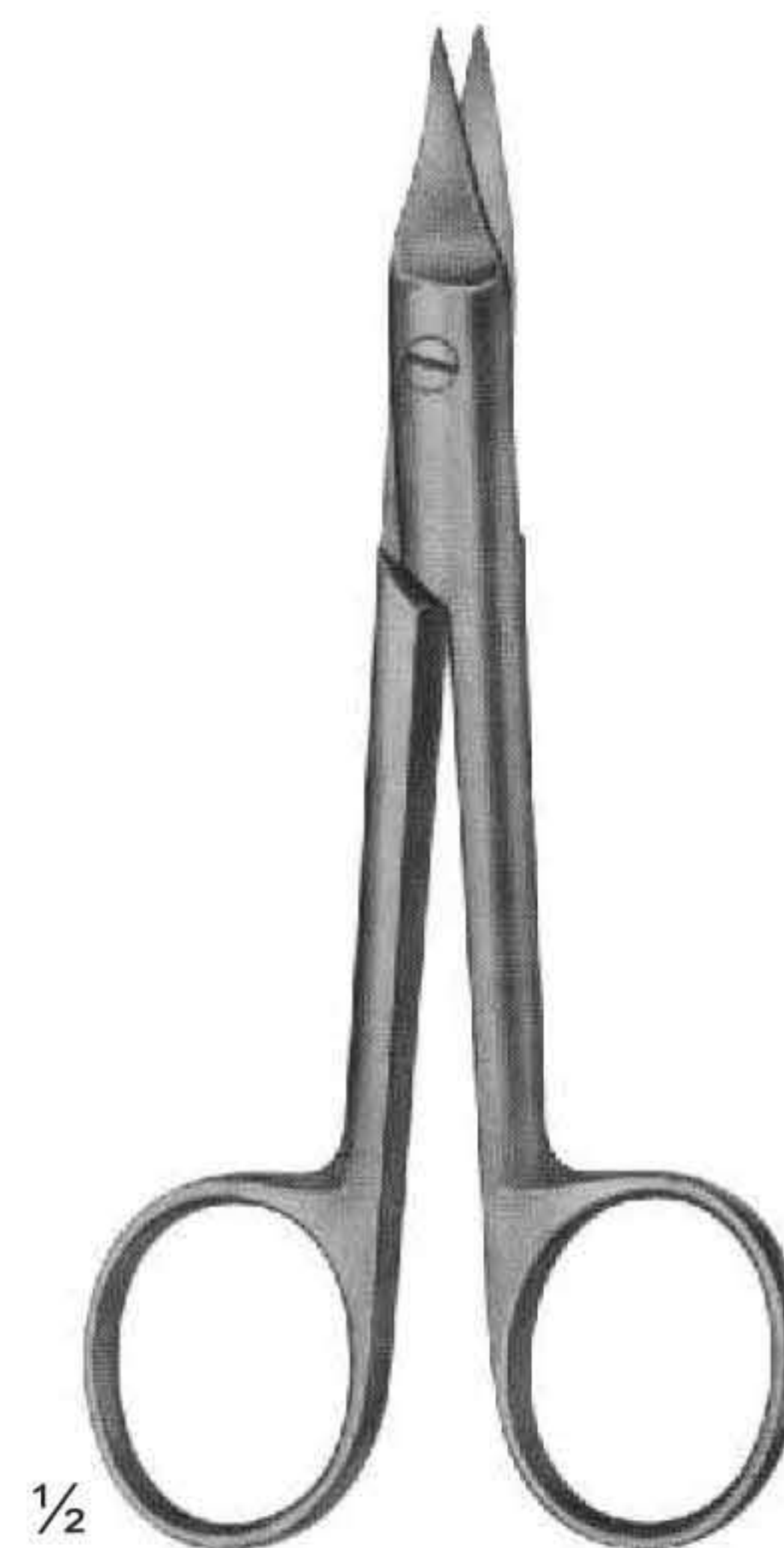

**UG-188**

SYSTRUNK  
Nail Splitting Scissors

# Dissecting Scissors

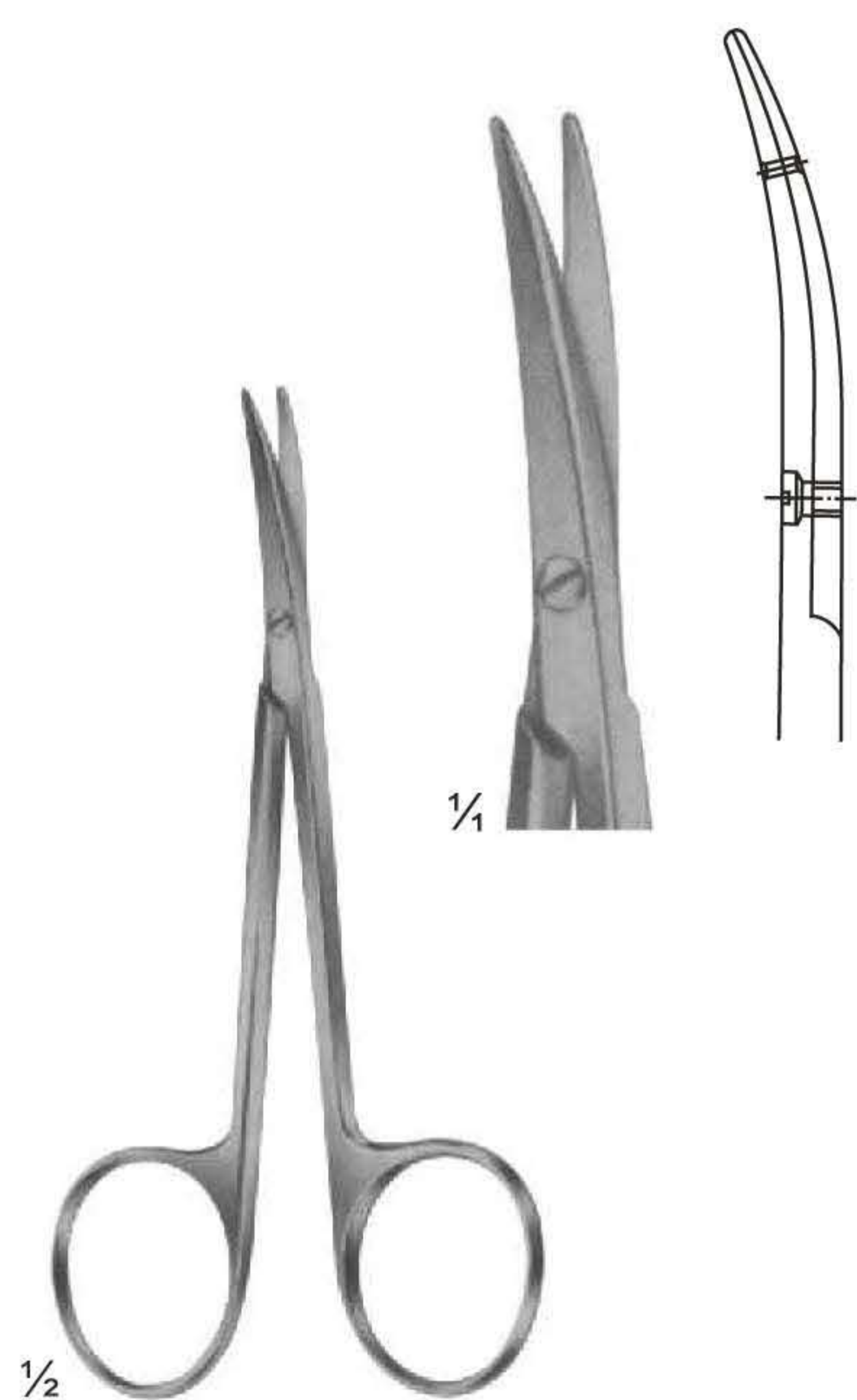

**UG-195**  
LITTLER  
Dissecting Scissors  
Tips with eye for suture  
Size: 115 mm

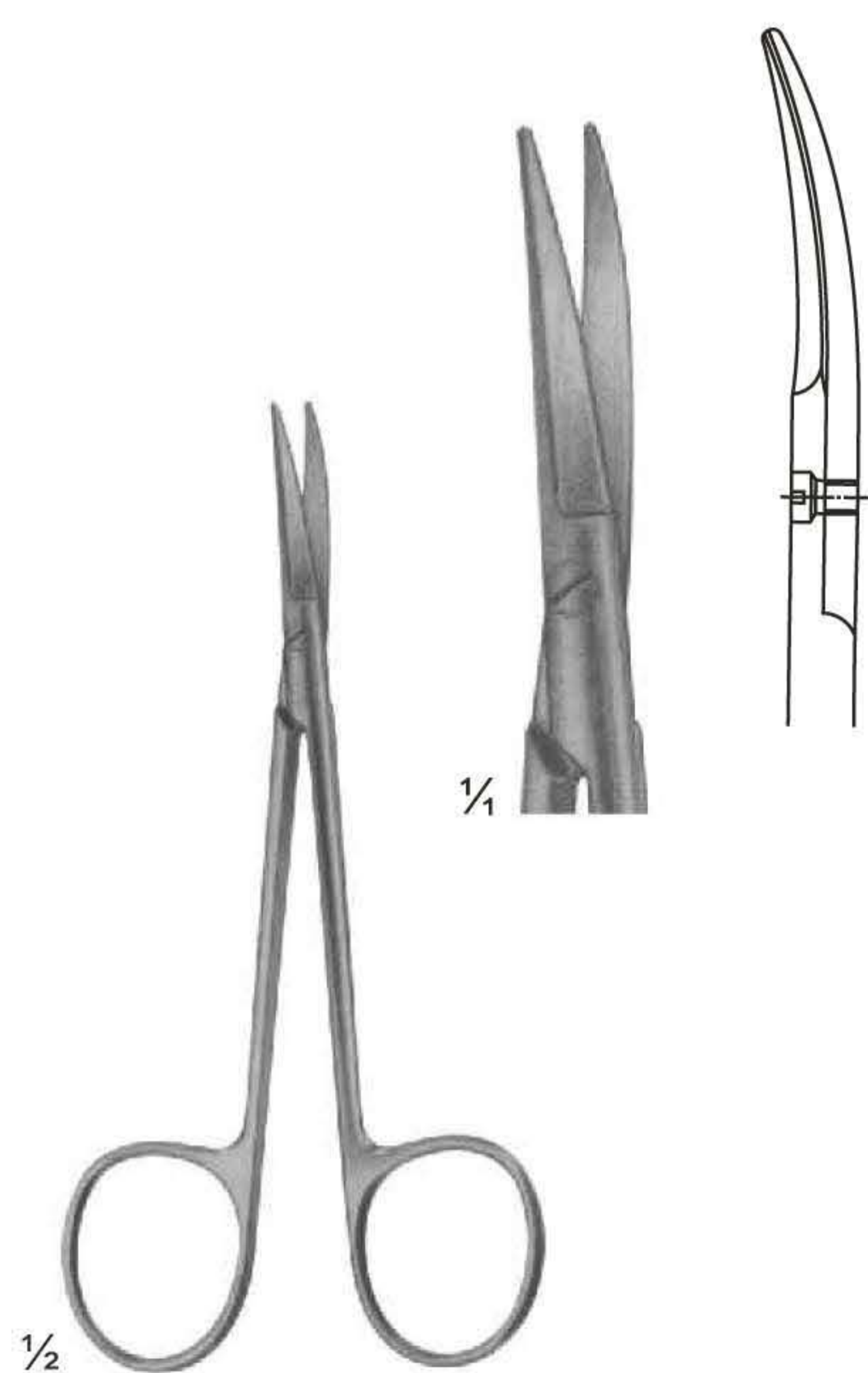

**UG-197**  
COTTLE  
Bulldog Scissors  
Size: 115 mm



**UG-199**  
STEVENS  
Vessel and tendon Scissors  
Size: 100 mm

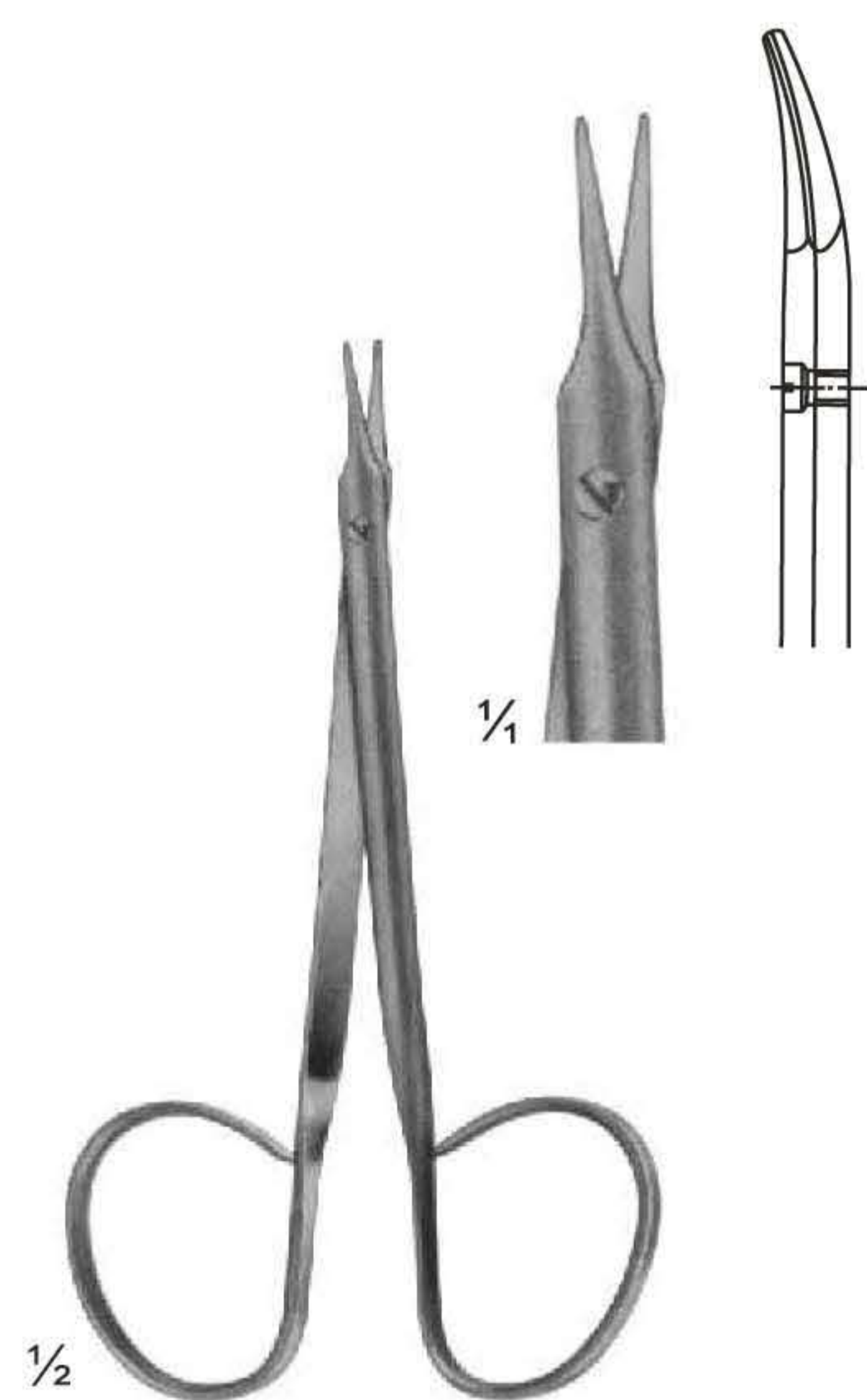

**UG-366**  
STEVENS  
Fine Dissecting Scissors  
Size: 110 mm



**UG-369**  
STEVENS  
Vessel and tendon Scissors  
Size: 110 mm

# Dissecting Scissors

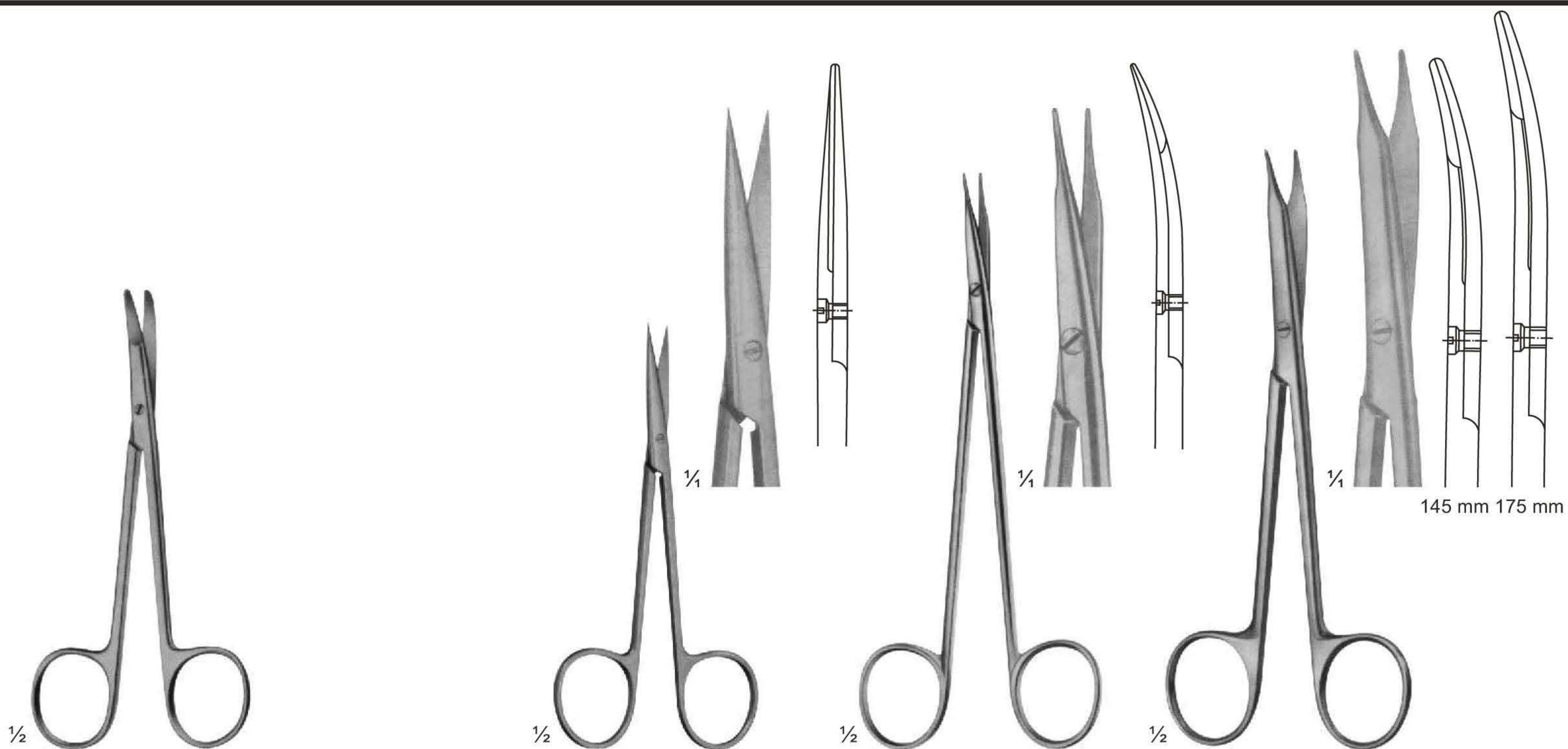

**UG-433**  
**KILNER**  
 Special flat points for dissecting  
 and undermining the skin

**UG-436**  
**KILNER**  
 Fine dissecting scissors  
 Size: 115 mm

**UG-437**  
**JAMESON**  
 Dissecting scissors  
 Size: 150 mm

**UG-439**  
**REYNOLDS**  
 Dissecting scissors  
 Size: 145 - 175 mm

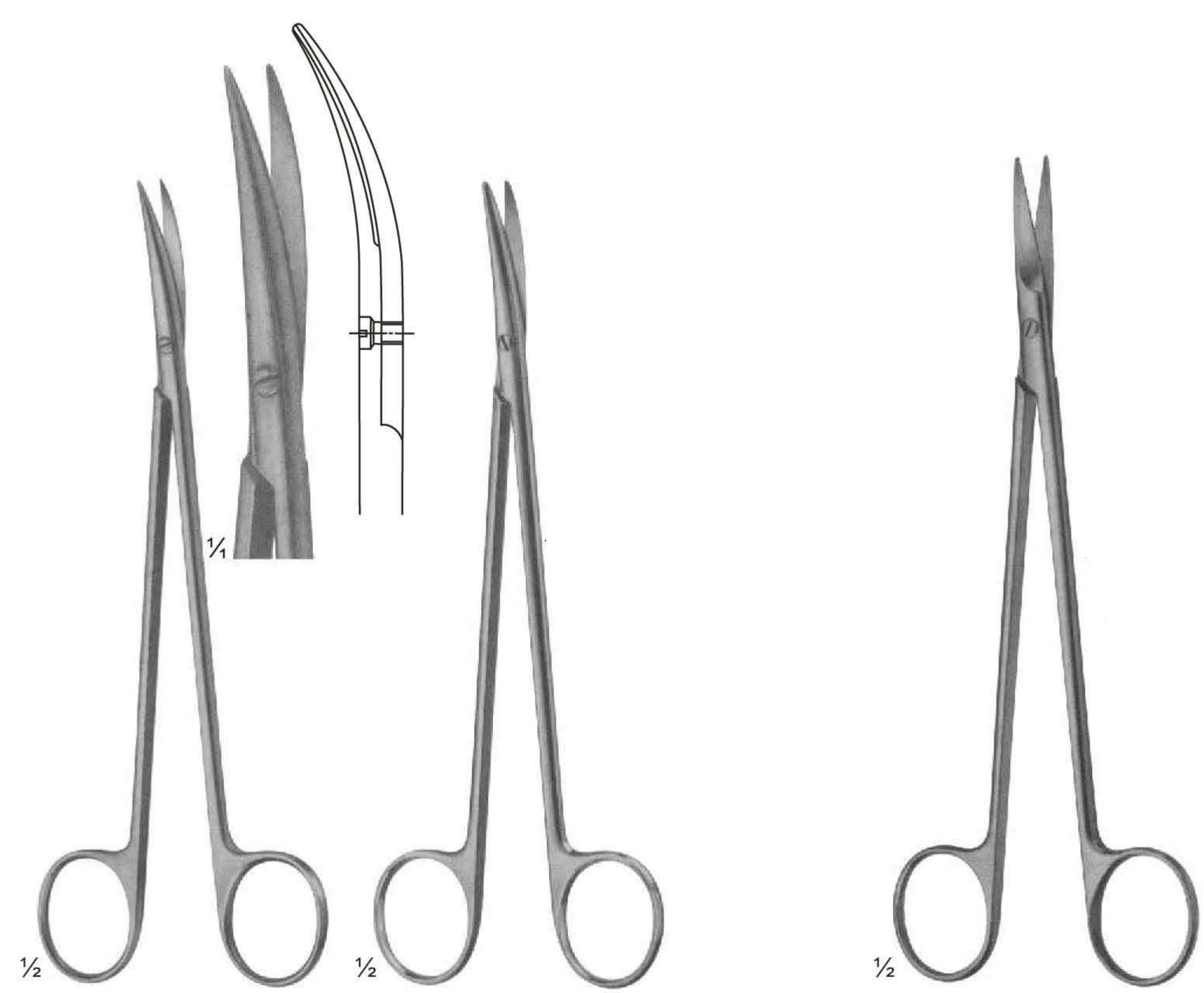

**UG-442**  
**DE BAKEY**  
 Ateriotomy scissors  
 Size: 175 mm

**UG-445**  
**TOENNISADSON**  
 Dissecting scissors  
 Size: 175 mm

**UG-448**  
**TOENNIS**  
 Dissecting scissors  
 Size: 150 mm

# Dissecting & Surgical Scissors

---



$\frac{1}{2}$   
**UG-449**  
FOMON  
Lower lateral scissors



$\frac{1}{2}$   
**UG-451**  
LANDOLT  
Enucleation scissors  
Size



$\frac{1}{2}$   
**UG-453**  
MAYO



$\frac{1}{2}$   
**UG-457**  
MAYO-STILLE

# Dissecting Scissors



**UG-461**  
MAYO-STILLE  
With chamfered blades

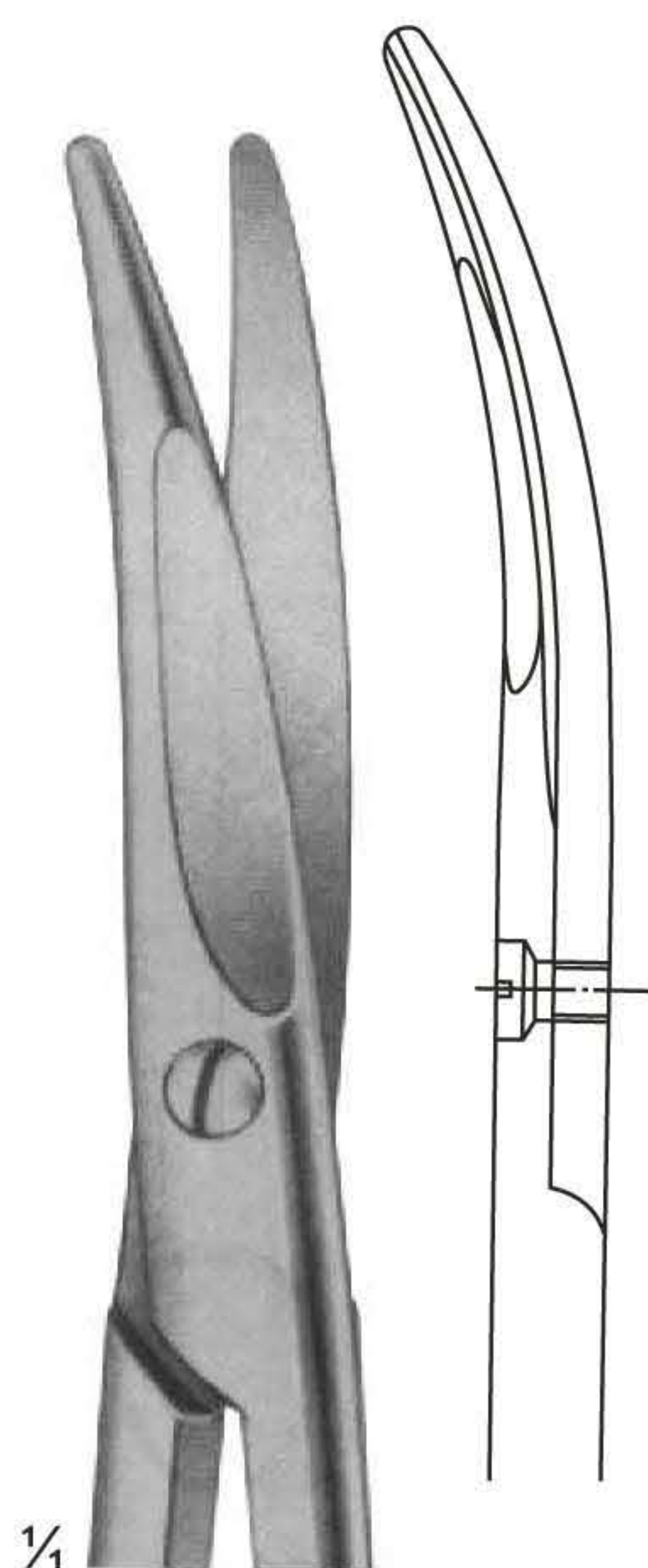

MAYO-STILLE  
**UG-463**  
Size: 140 mm

Size: 170 mm



MAYO  
With chamfered blades  
**UG-465**



**UG-469**  
MAYO-NOBLE  
Broad pattern



**UG-472**  
MAYO-HARRINGTON



# Dissecting Scissors

---



**UG-475**  
STILLE  
Size: 150 mm



**UG-478**  
LEXER  
Narrow  
Size: 165 mm

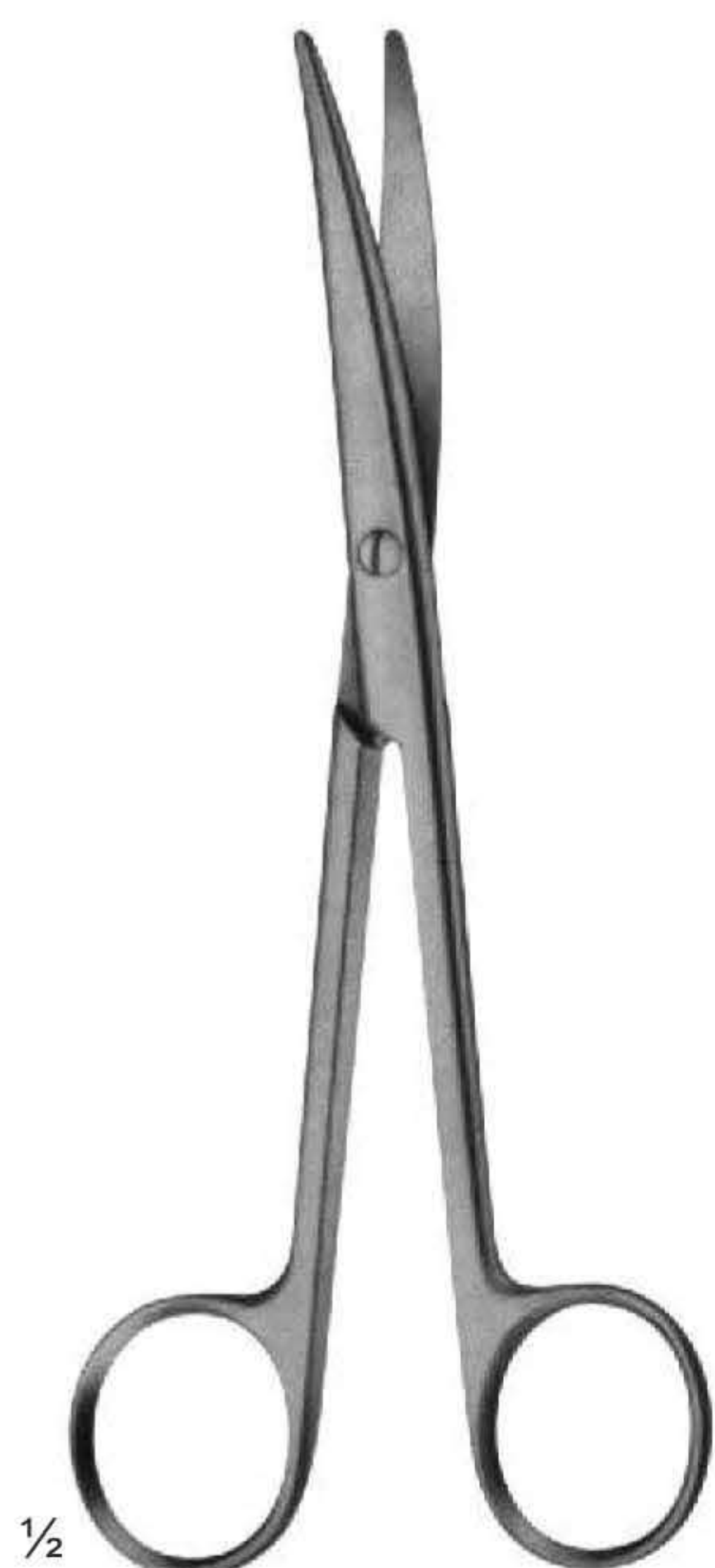

**UG-480**  
MAYO-LEXER  
Standard



**UG-481**  
MAYO

# Dissecting Scissors

---



$\frac{1}{2}$   
**UG-486**  
BABY - METZENBAUM



$\frac{1}{2}$   
**UG-491**  
METZENBAUM



$\frac{1}{2}$   
**UG-503**  
NELSON - METZENBAUM

# Vessel Scissors



**UG-518**  
DE BAKEY  
Size: 155 mm

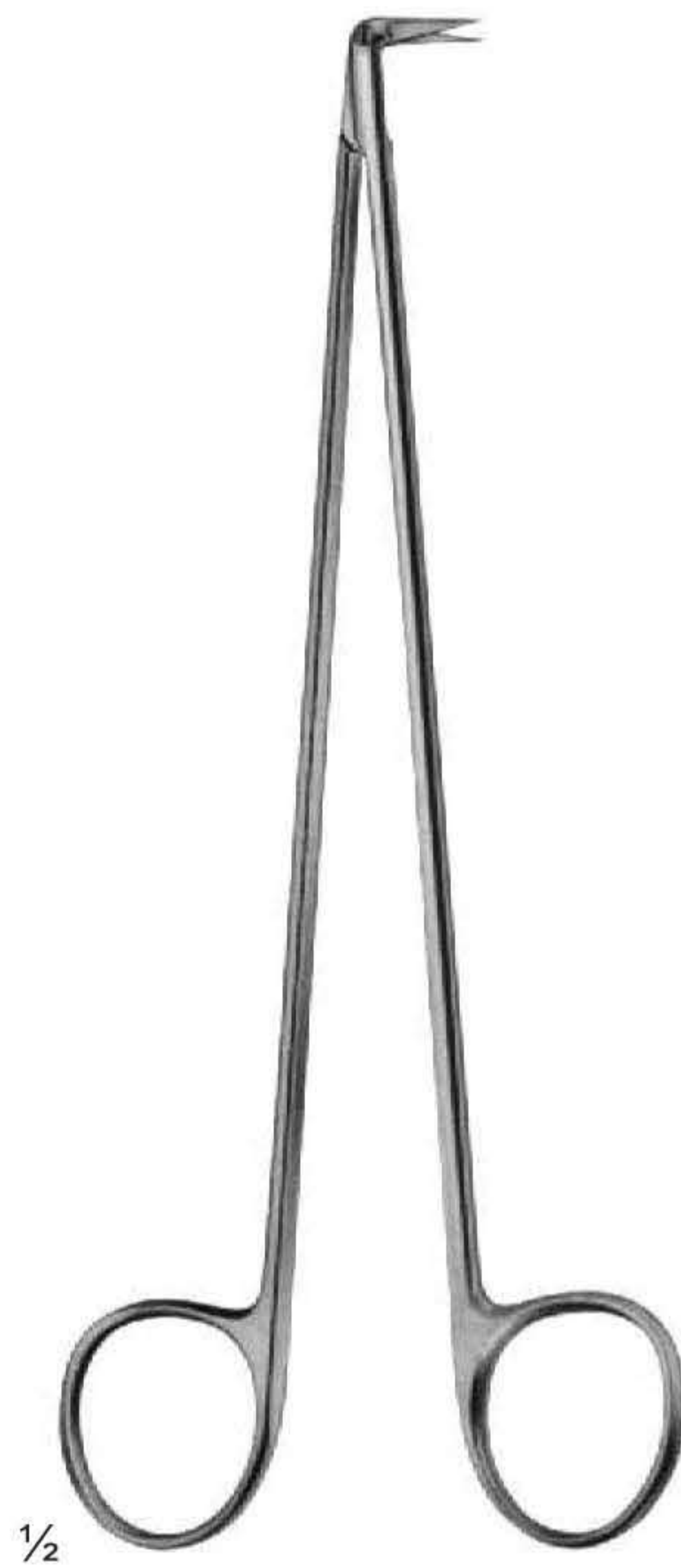

**UG-534**  
DIETRICH  
Size: 170 mm

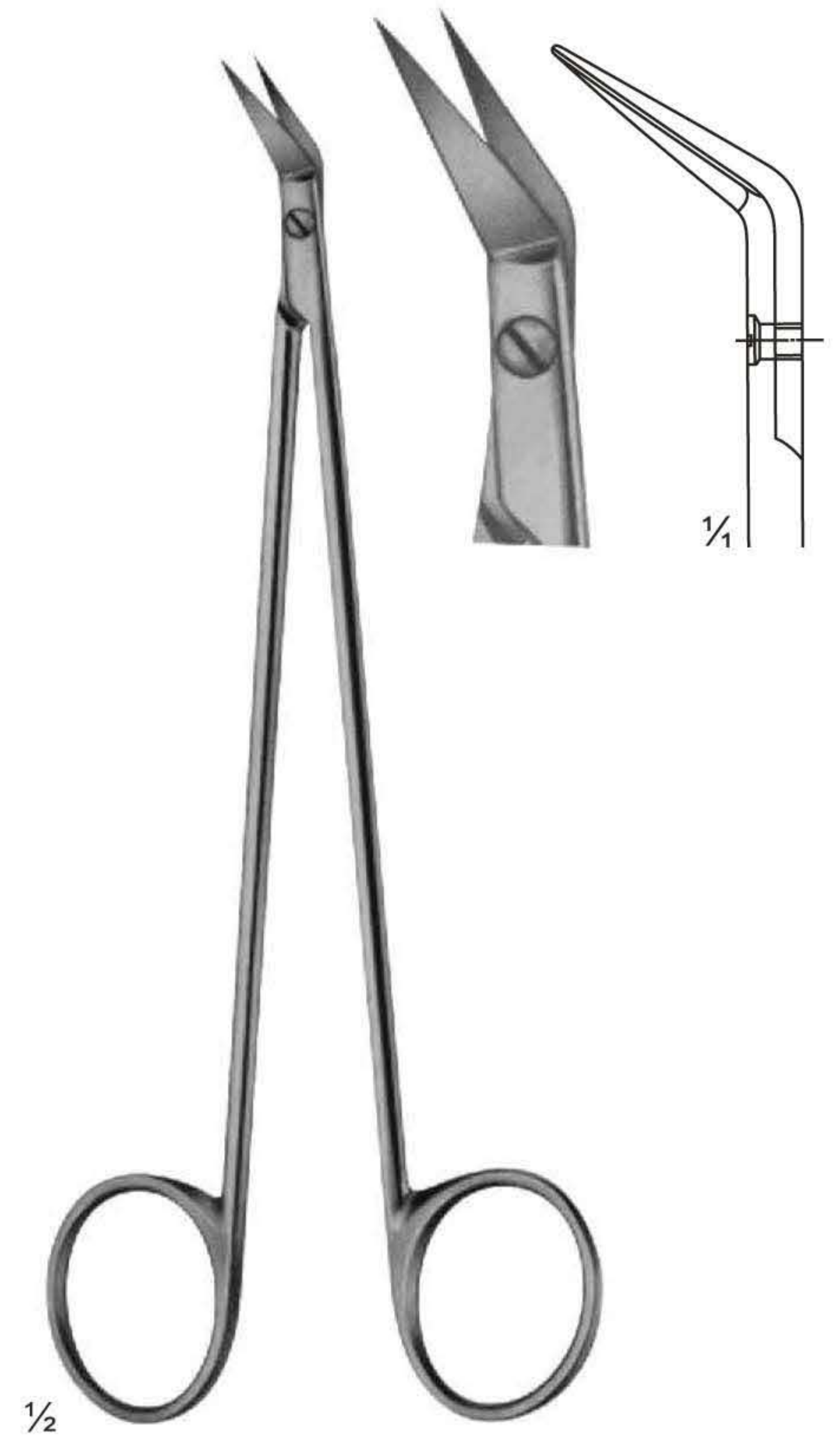

**UG-536**  
POTTS-SMITH  
Size: 180 mm

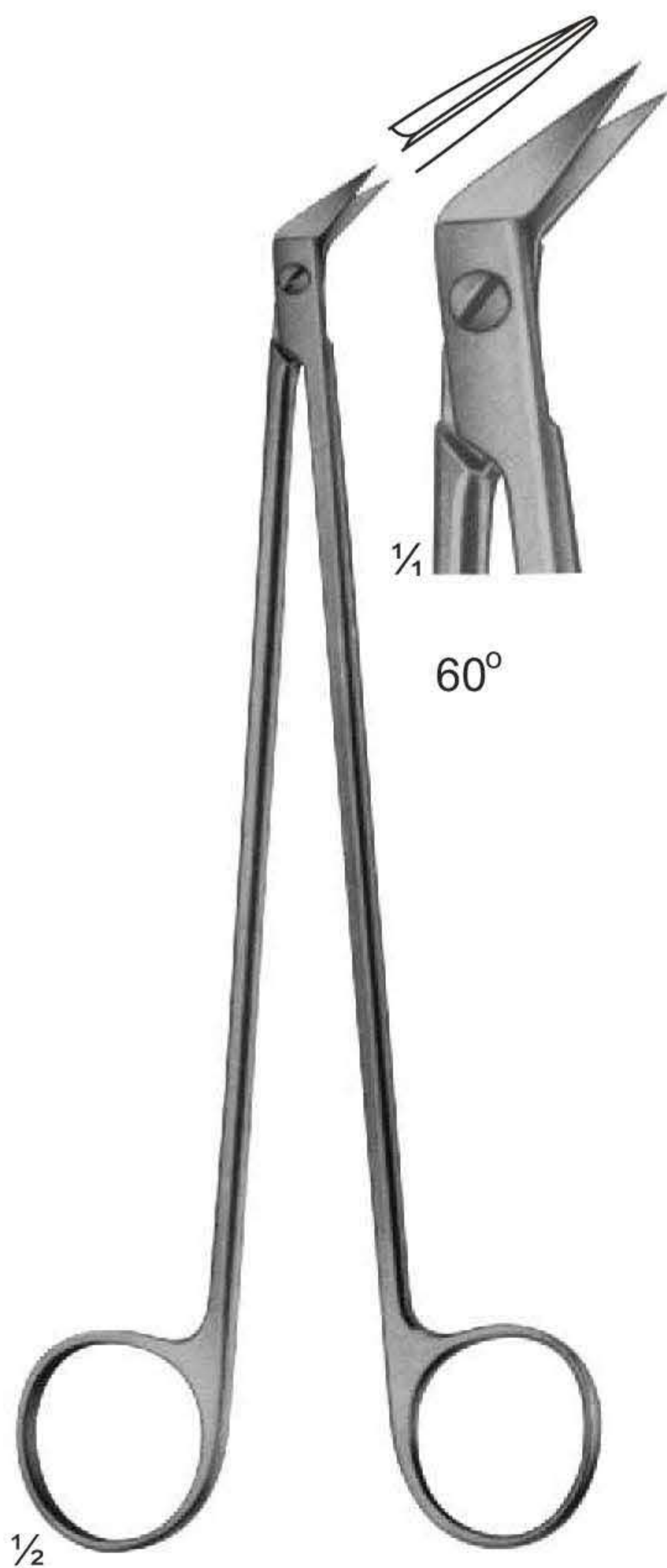

**UG-538**  
POTTS-SMITH  
Size: 180 mm



**UG-539**  
DEBAKEY  
Size: 155 mm

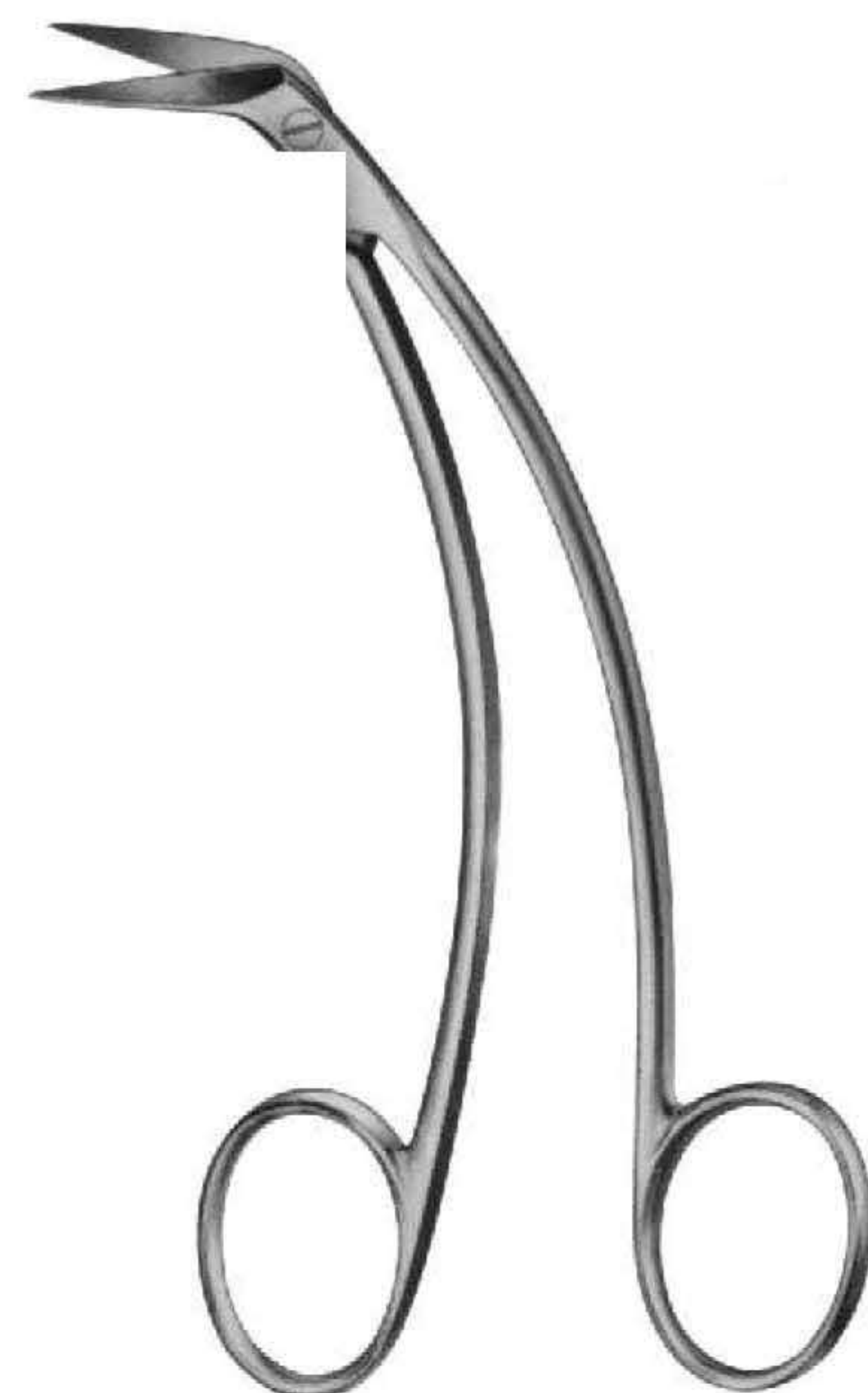

**UG-542**  
FAVOLORO  
Size: 140 mm

# Cardiovascular and Neuro-Surgery Scissors



**UG-552**  
OLIVECRONA  
Dura Scissors

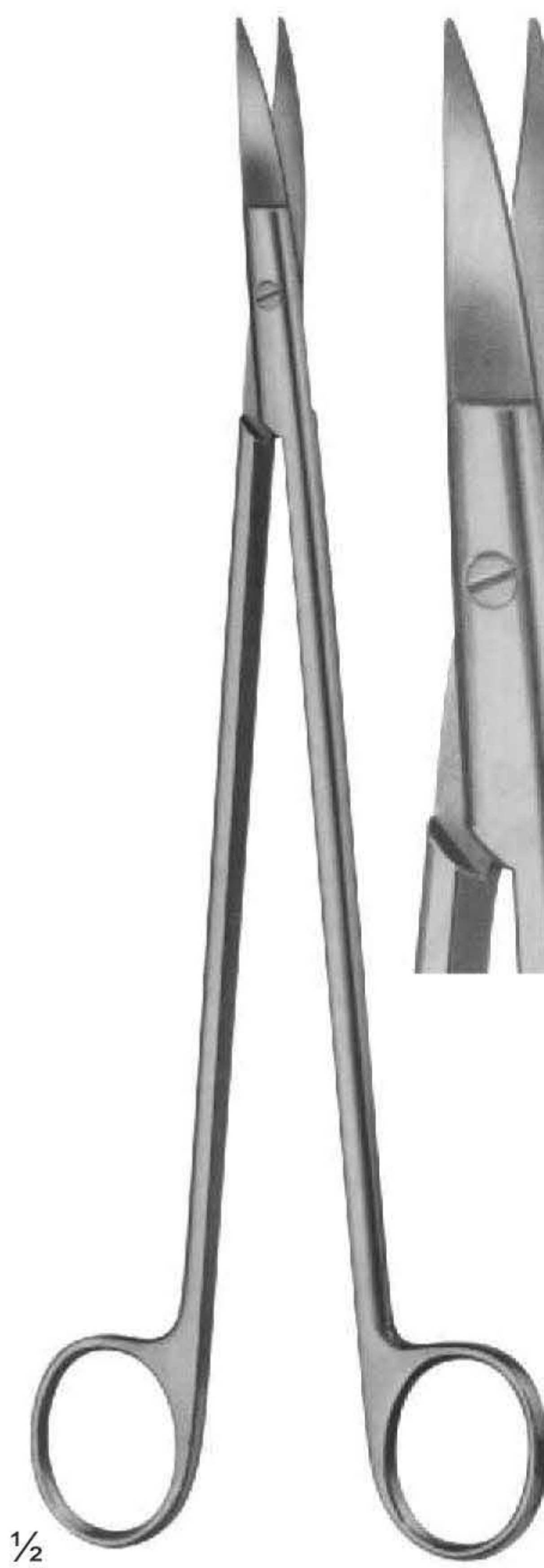

**UG-555**  
STRULLY  
Pointed  
Size: 220 mm

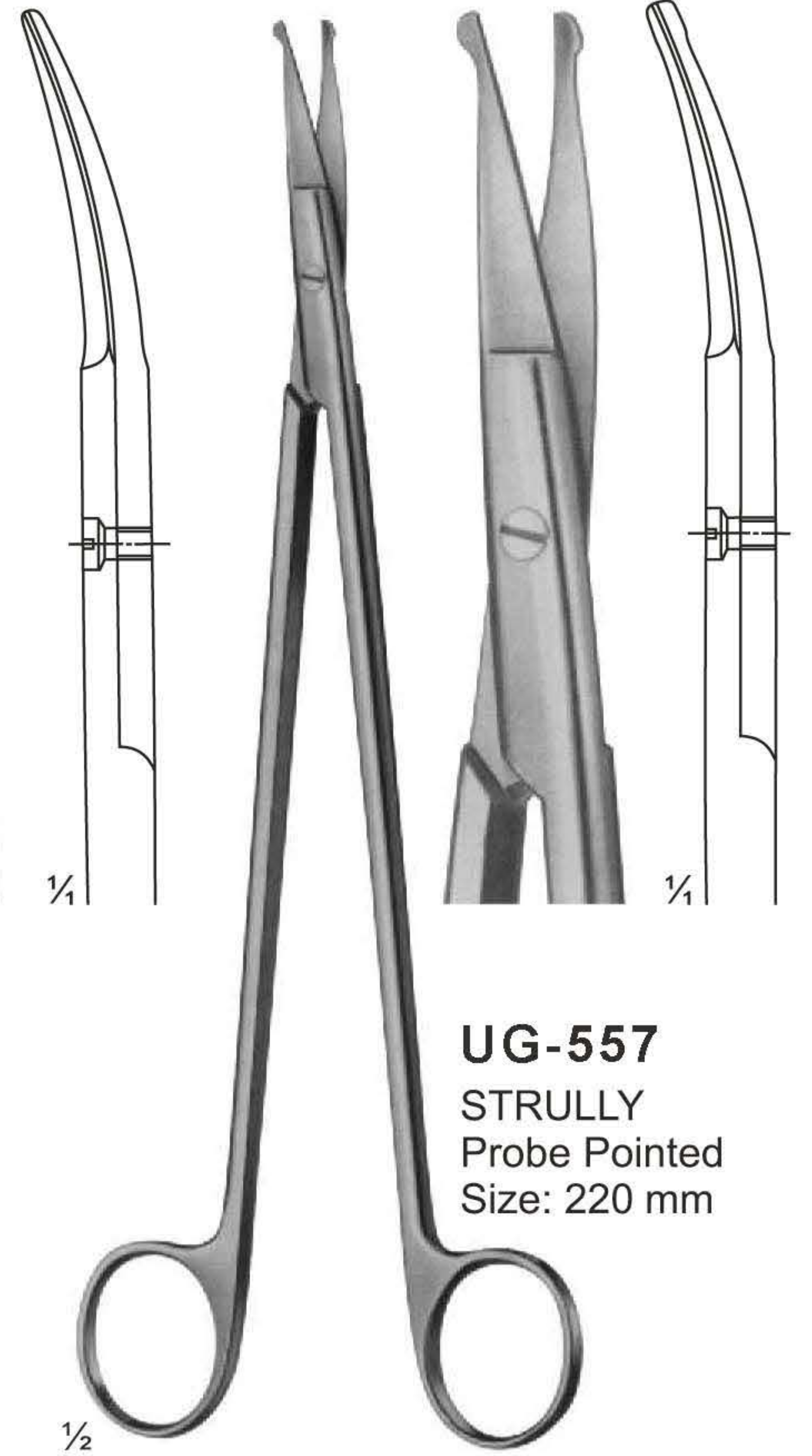

**UG-557**  
STRULLY  
Probe Pointed  
Size: 220 mm

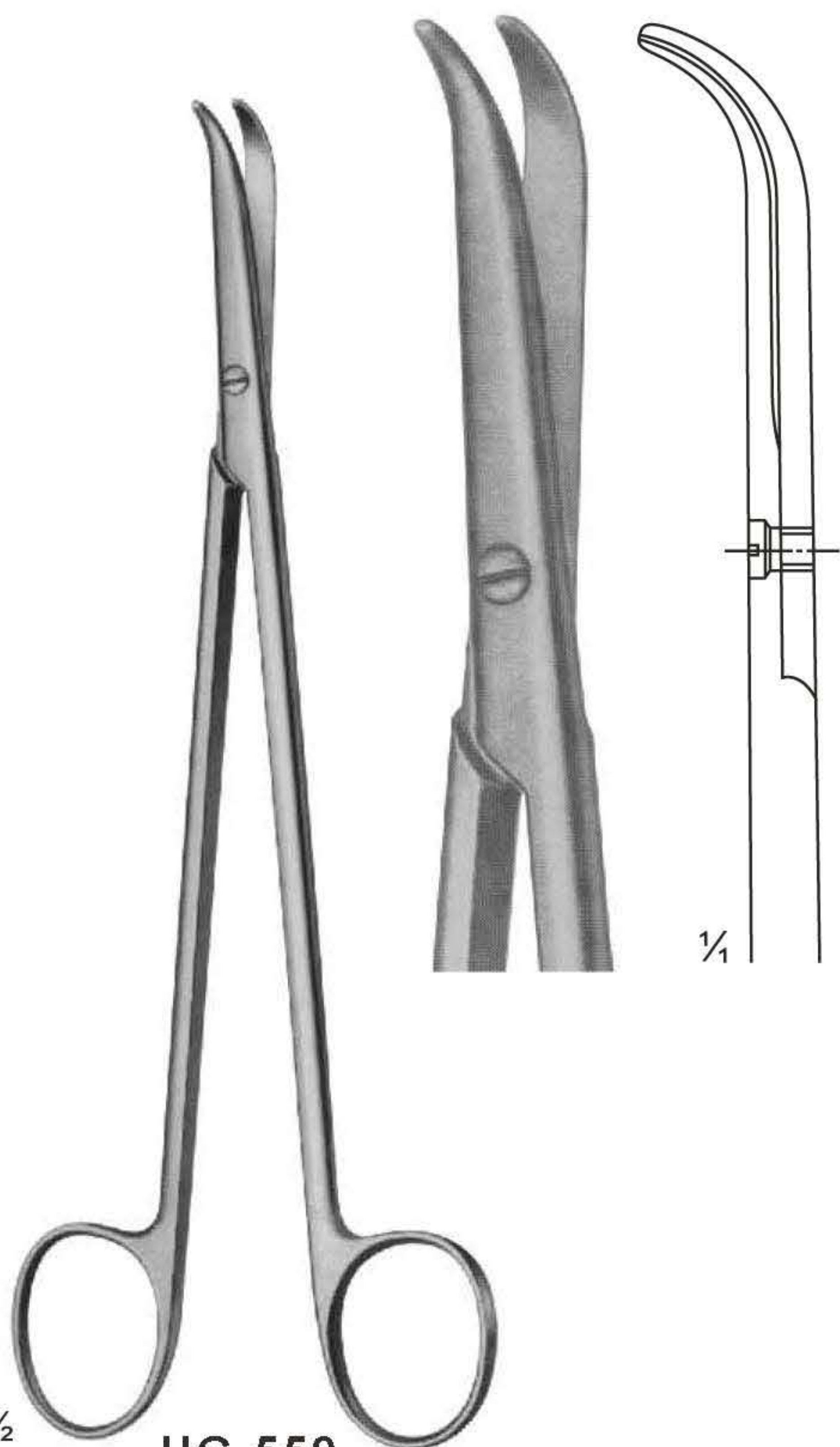

**UG-559**  
THOREK  
Size: 180 mm

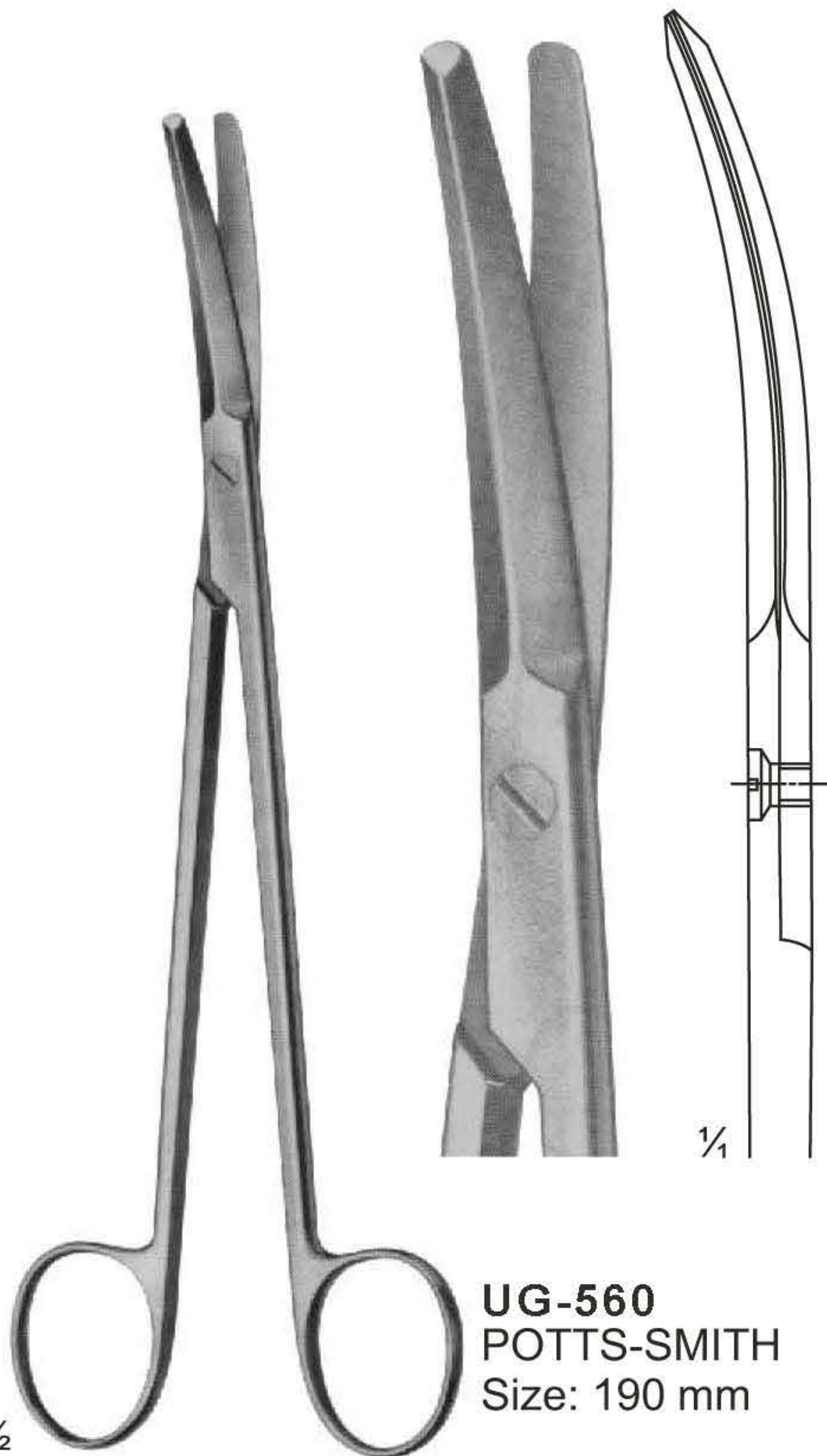

**UG-560**  
POTTS-SMITH  
Size: 190 mm

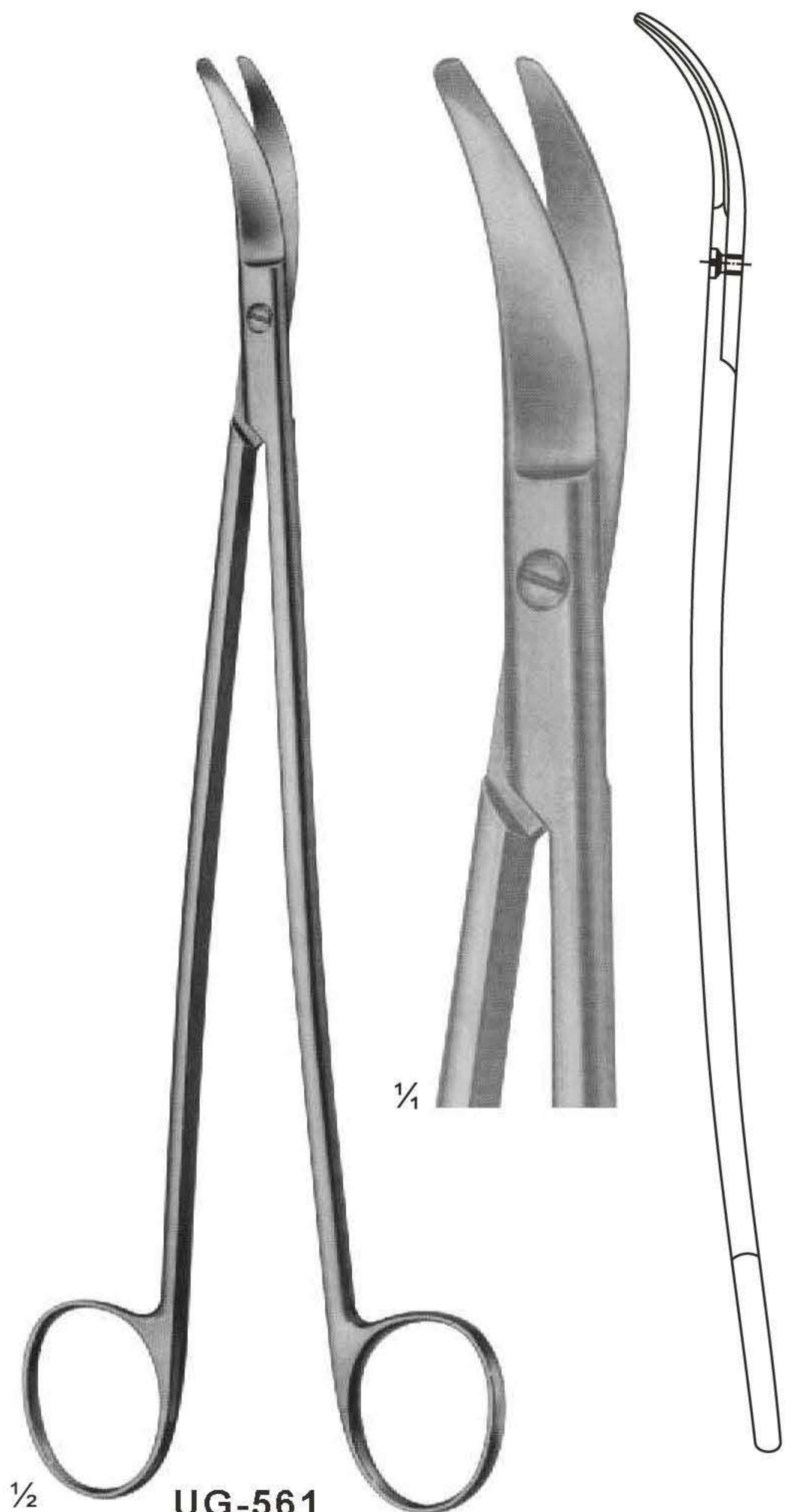

**UG-561**  
SATINSKY  
Size: 245 mm

# Delicate, Nasal and Tonsil Scissors

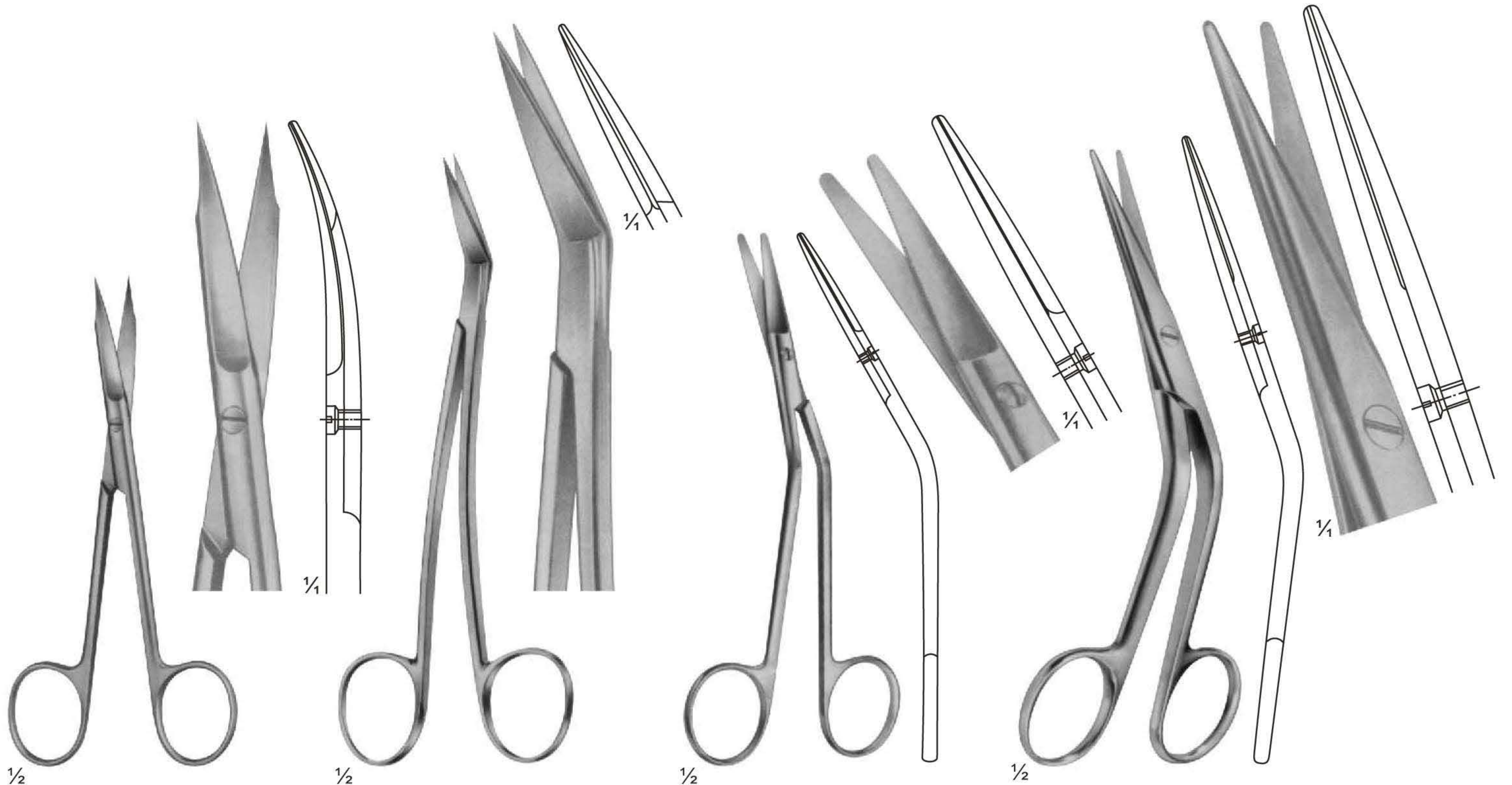

**UG-565**  
1 Finely Toothed Blade  
Size: 130 mm

**UG-567**  
LOCKLIN  
Curved Sideways,  
1 Toothed Blade  
Size: 155 mm

**UG-568**  
FOMON  
Blades Serrated  
Size: 145 mm

**UG-569**  
COTTLE  
Size: 165 mm

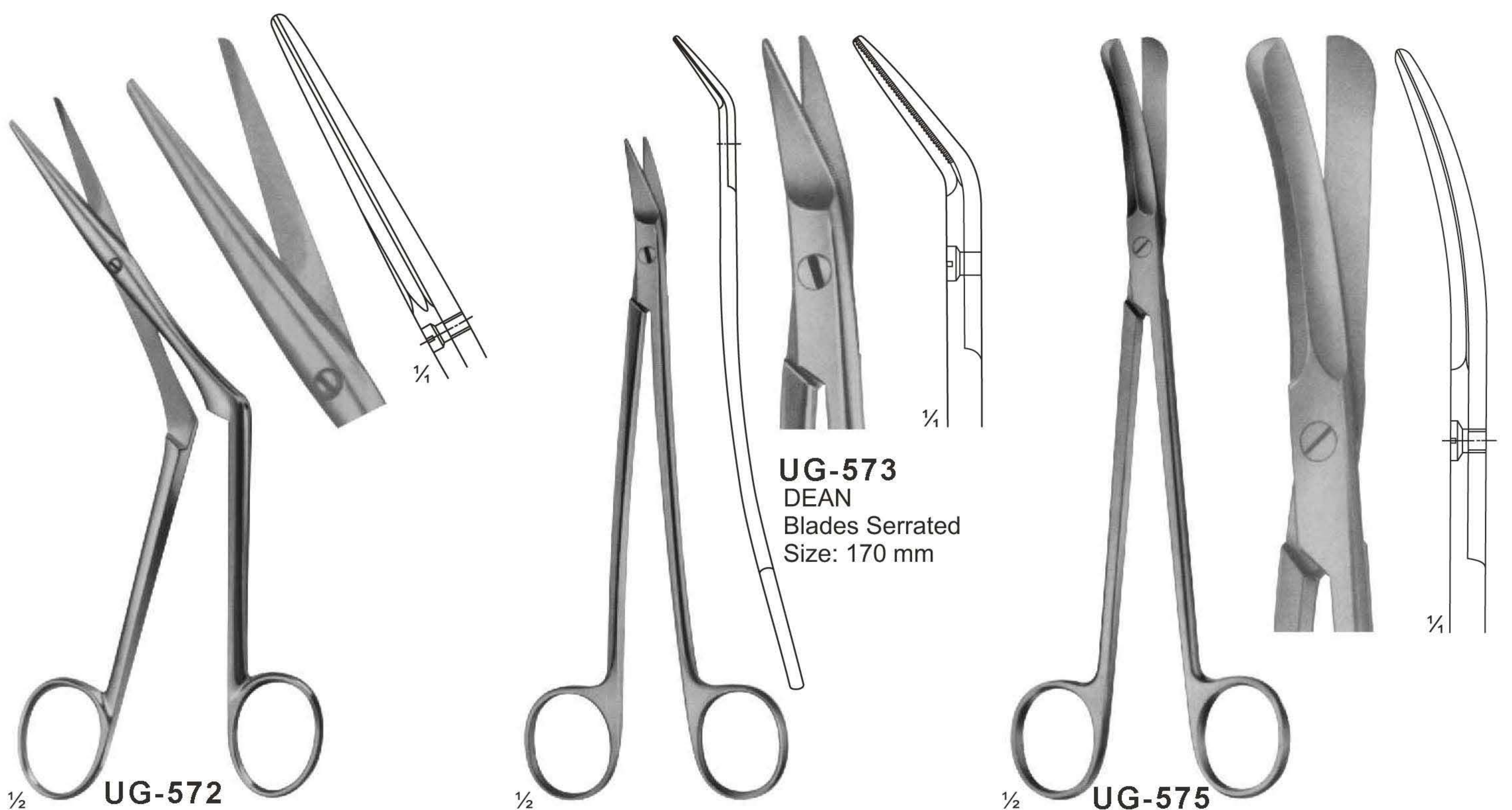

**UG-572**  
HEYMANN-KNIGHT  
Size: 175 mm

**UG-573**  
DEAN  
Blades Serrated  
Size: 170 mm

**UG-575**  
GOOD  
Size: 195 mm

# Bone Shears



**UG-577**  
KILLIAN  
Size: 200 mm

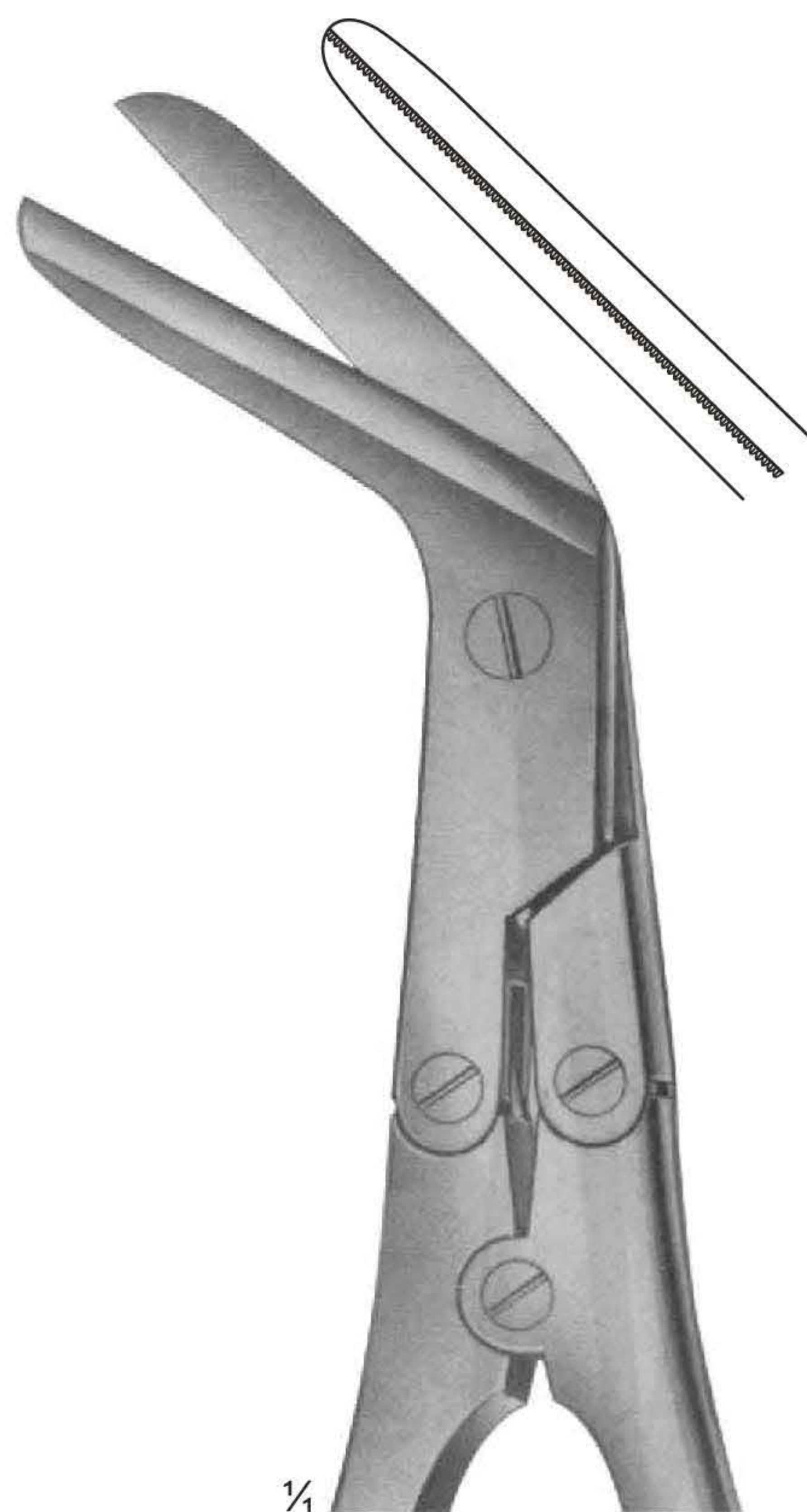

**UG-579**

# Operating and Gynaecology Scissors



$\frac{1}{2}$   
**UG-581**  
SIMS



$\frac{1}{2}$   
**UG-610**  
SIMS



$\frac{1}{2}$   
**UG-611**  
SIMS

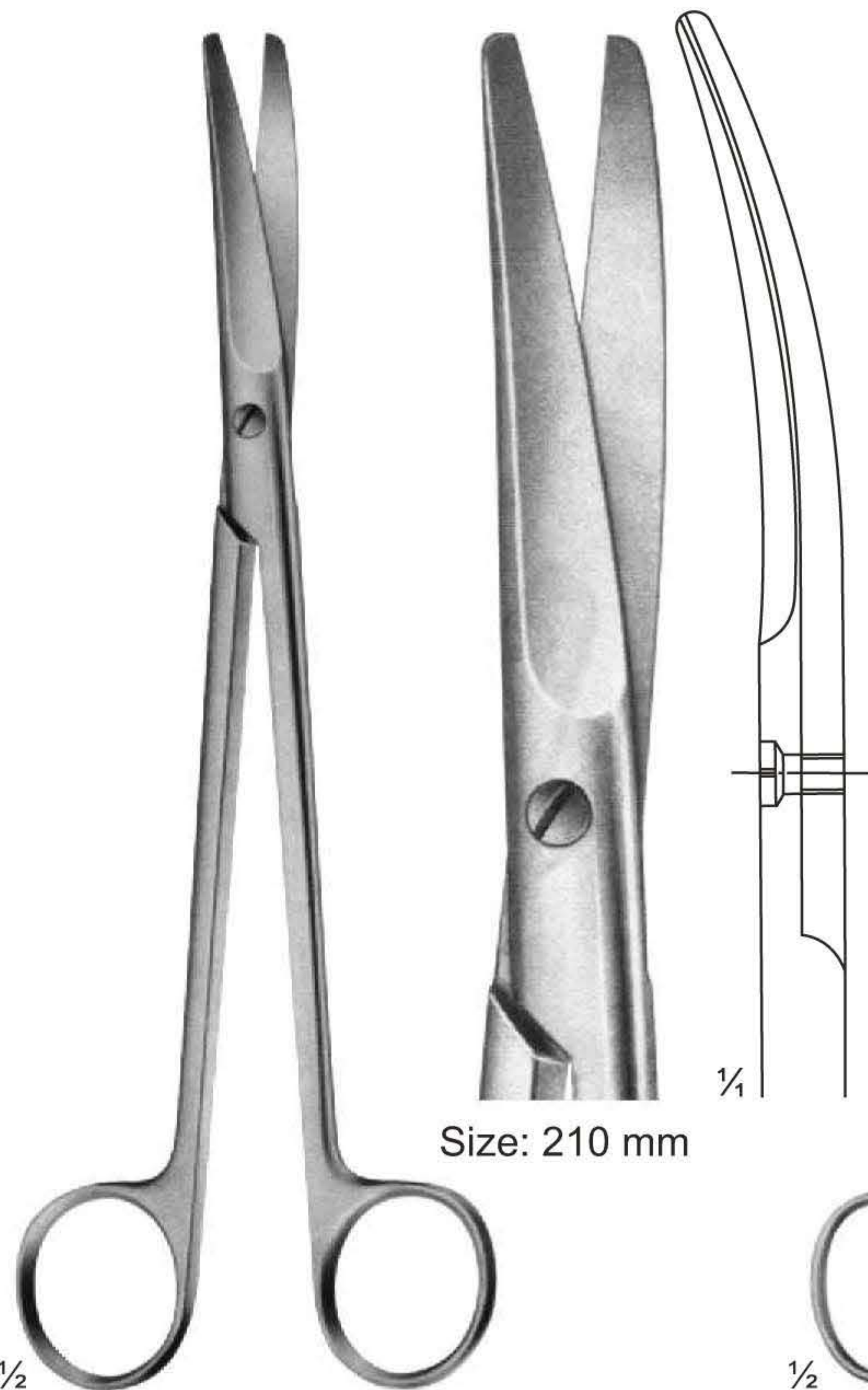

$\frac{1}{2}$   
**UG-612**  
SIMS

Size: 210 mm

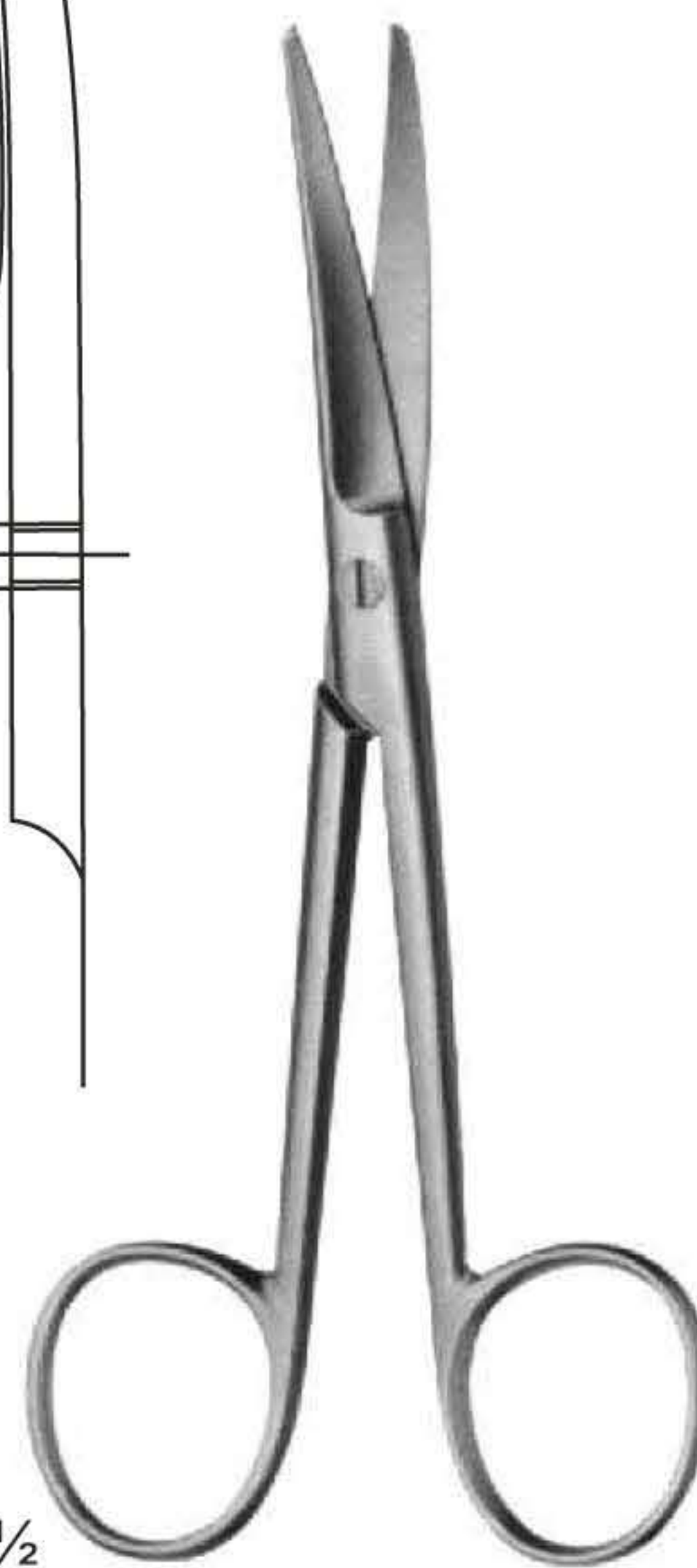

$\frac{1}{2}$   
**UG-614**  
WERTHEIM

# Operating and Gynaecology Scissors

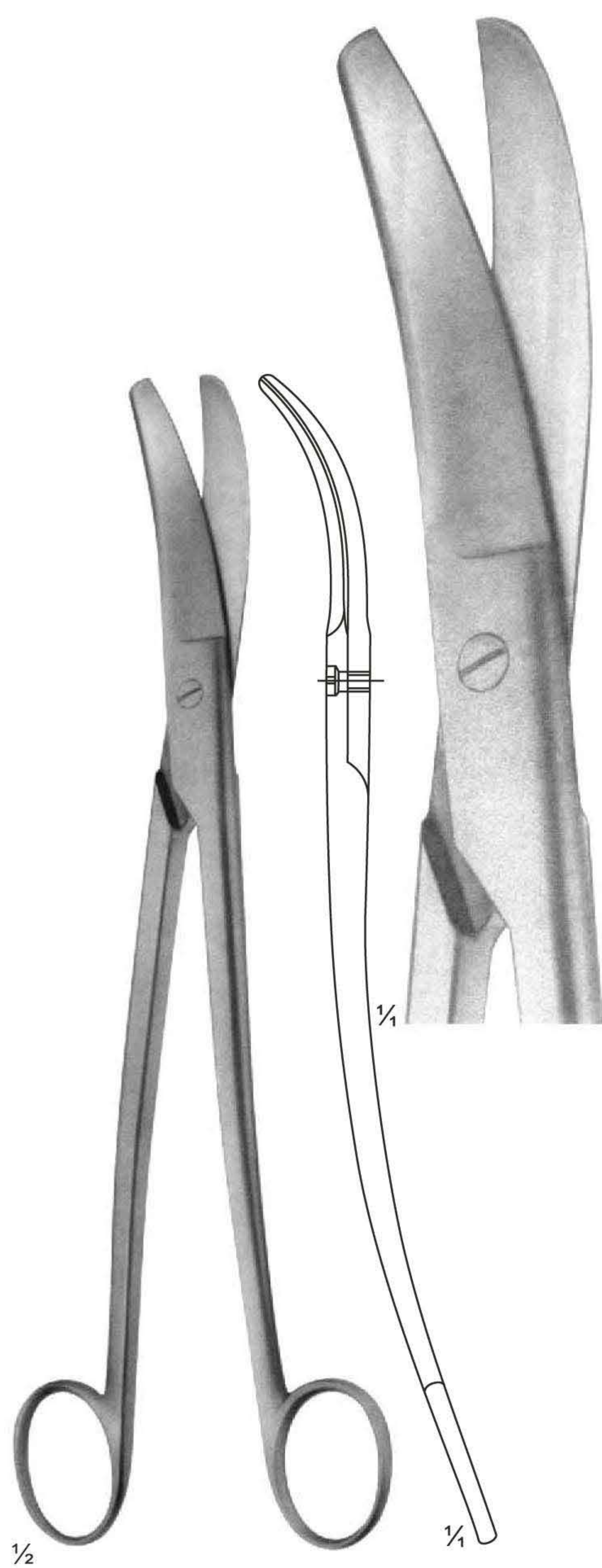

**UG-615**  
SIEBOLD  
Uterine Scissors  
Size: 245 mm

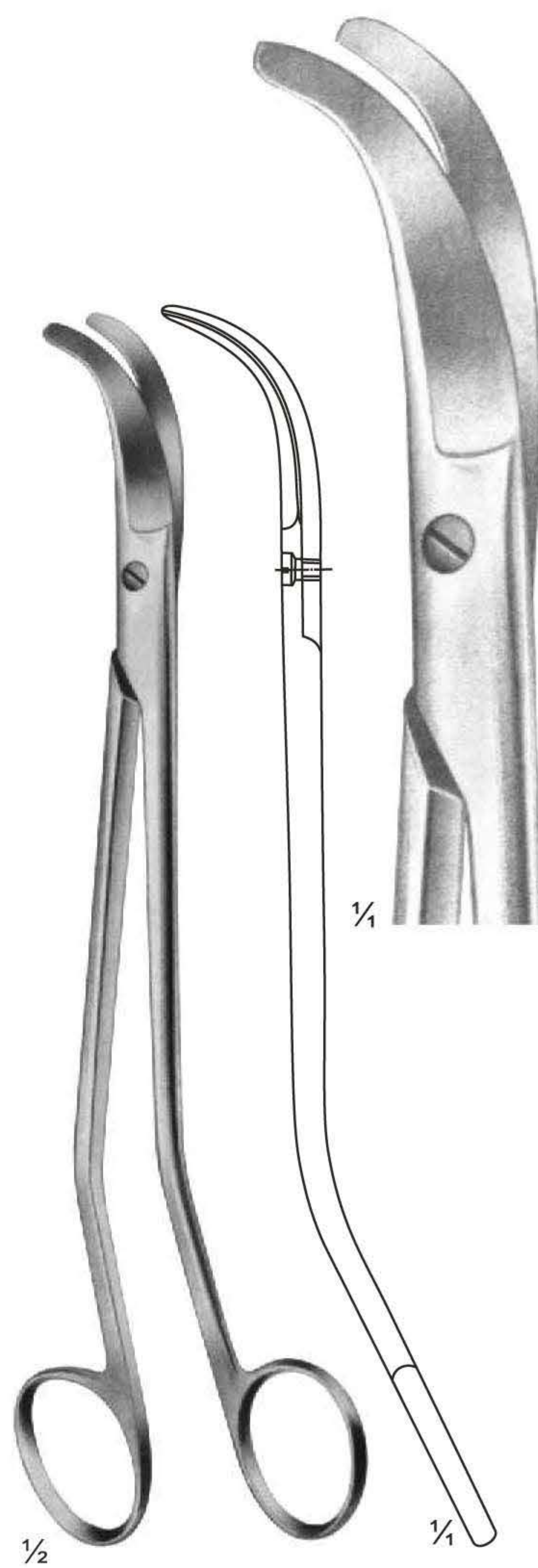

**UG-617**  
BOZEMANN  
Uterine Scissors  
Size: 220 mm

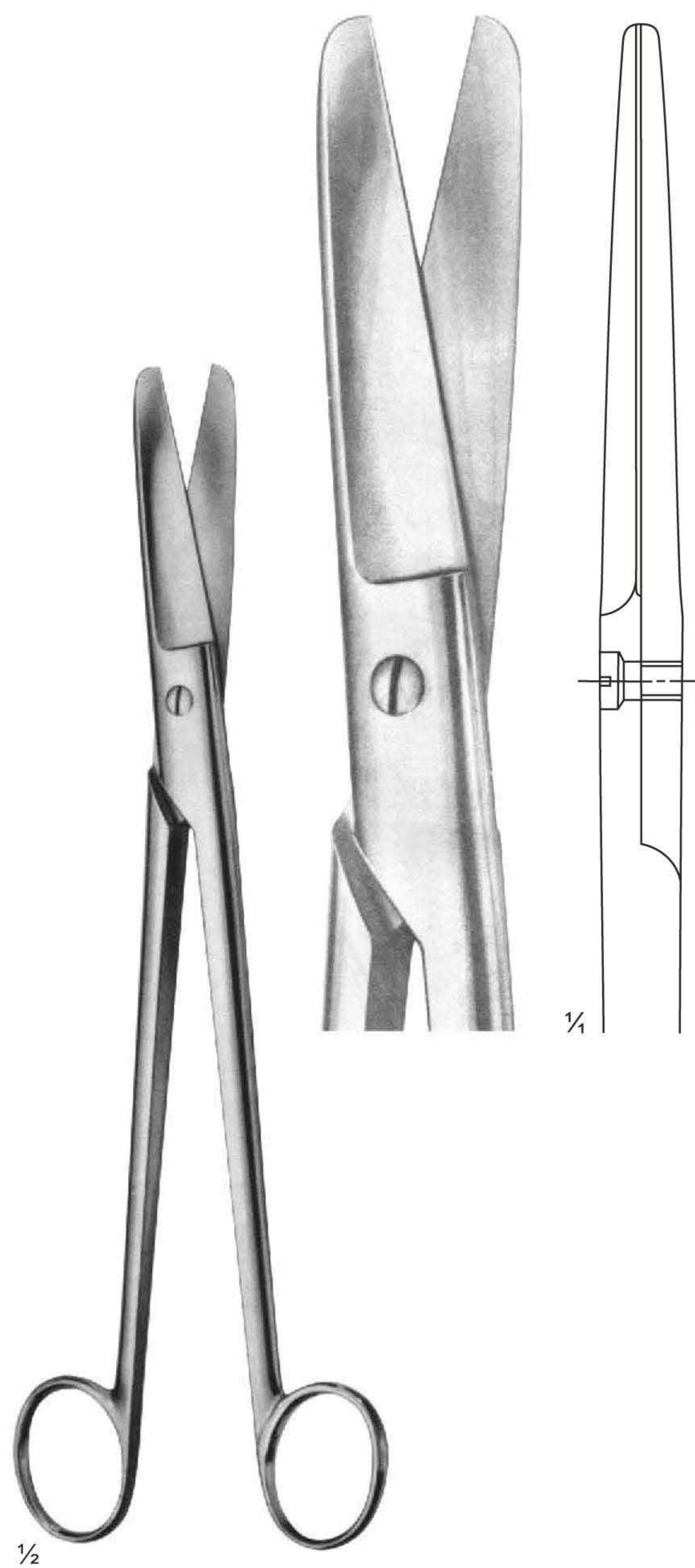

**UG-618**  
SIMS-SIEBOLD  
Uterine Scissors  
Size: 250 mm



# Operating and Gynaecology Scissors

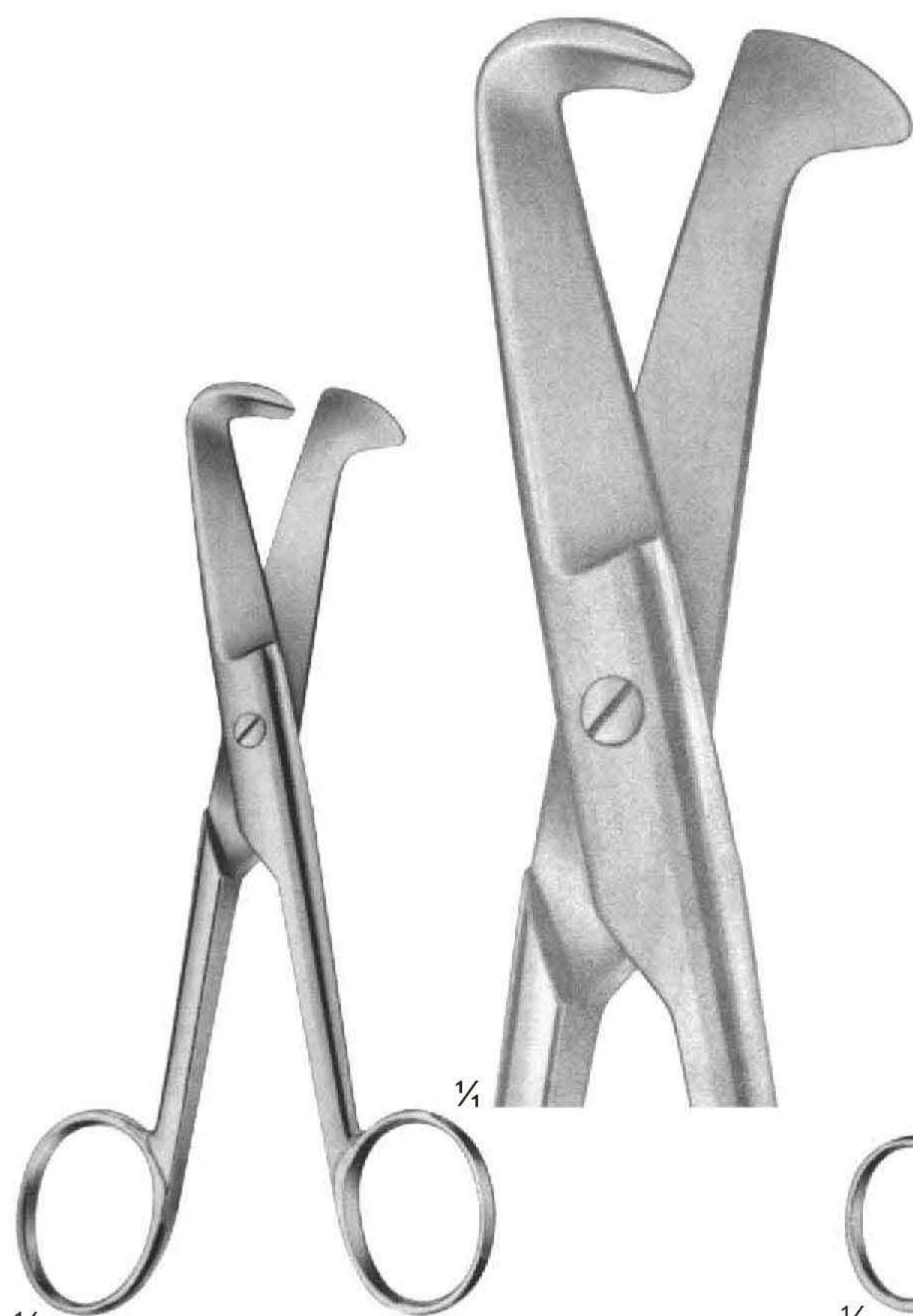

**UG-619**  
 SCHUMACHER  
 Umbilical Cord Scissors  
 Size: 155 mm



**UG-620**  
 Umbilical Cord Scissors  
 Size: 105 mm

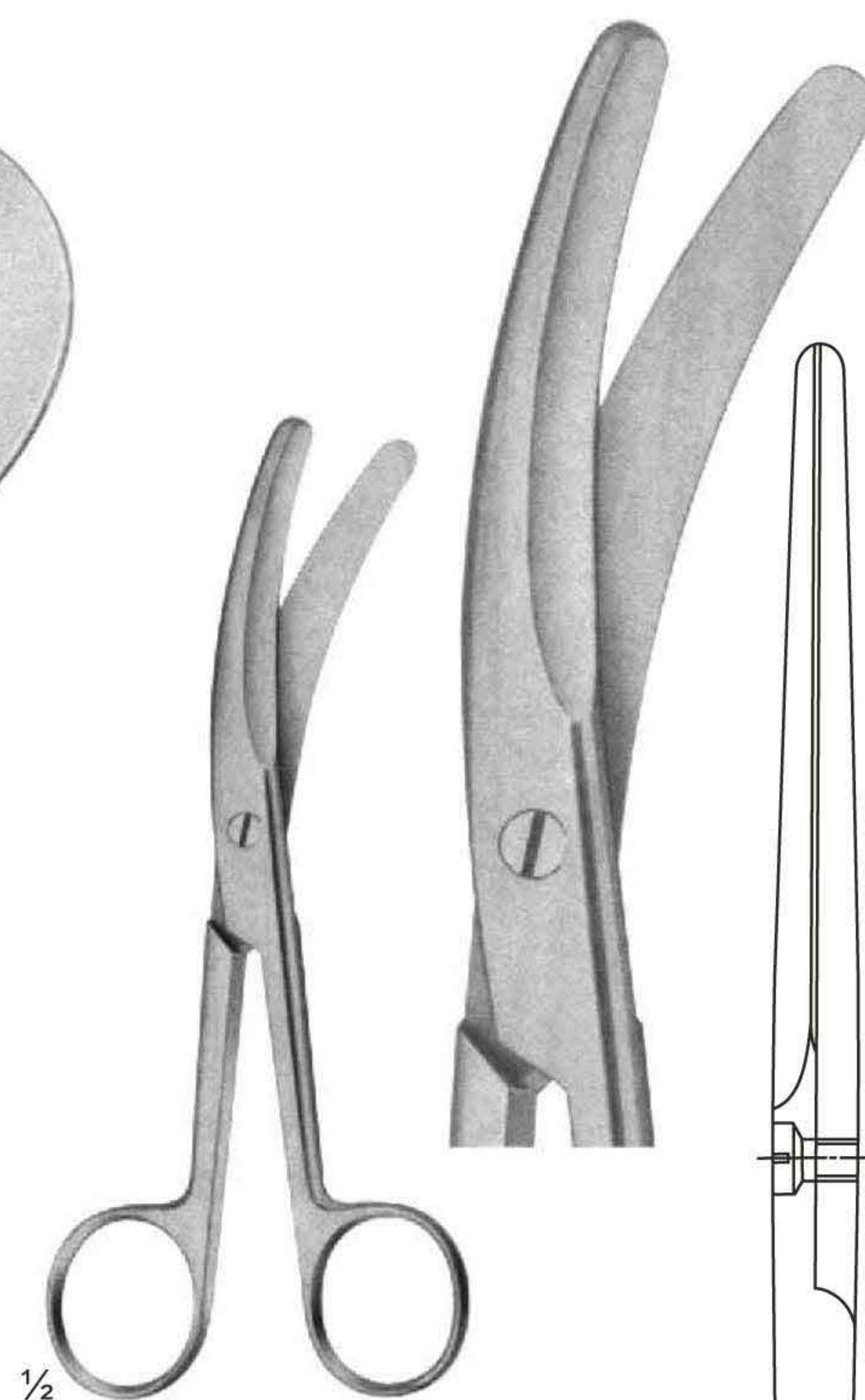

**UG-623**  
 Umbilical Cord Scissors

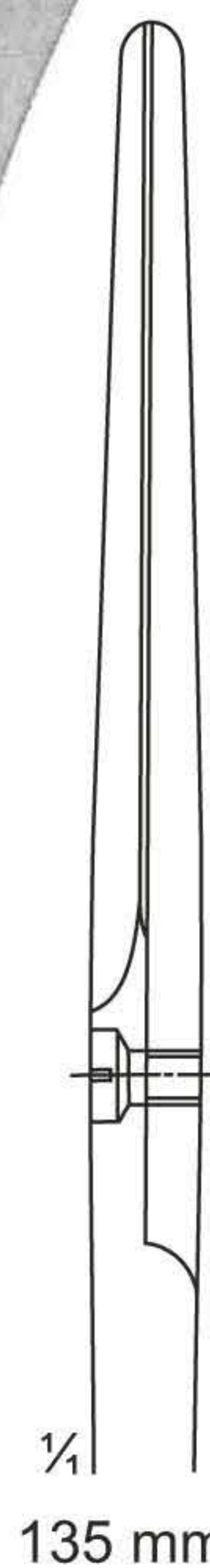

135 mm



**UG-624**  
 BRAUN-STADLER  
 Empisiotomy Scissors



**UG-626**  
 DAMMSCHERE  
 Empisiotomy Scissors  
 240 mm

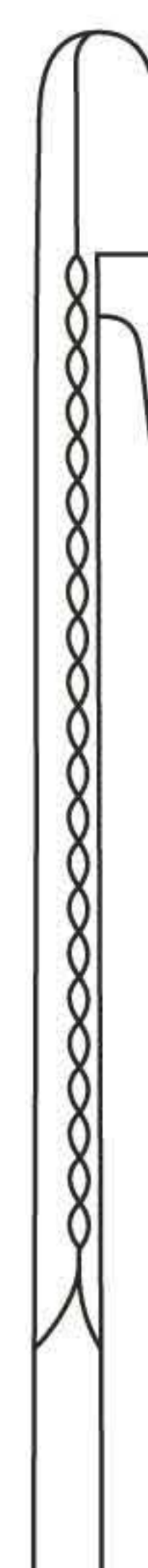

# Bowel Scissors, Cartilage Scissors

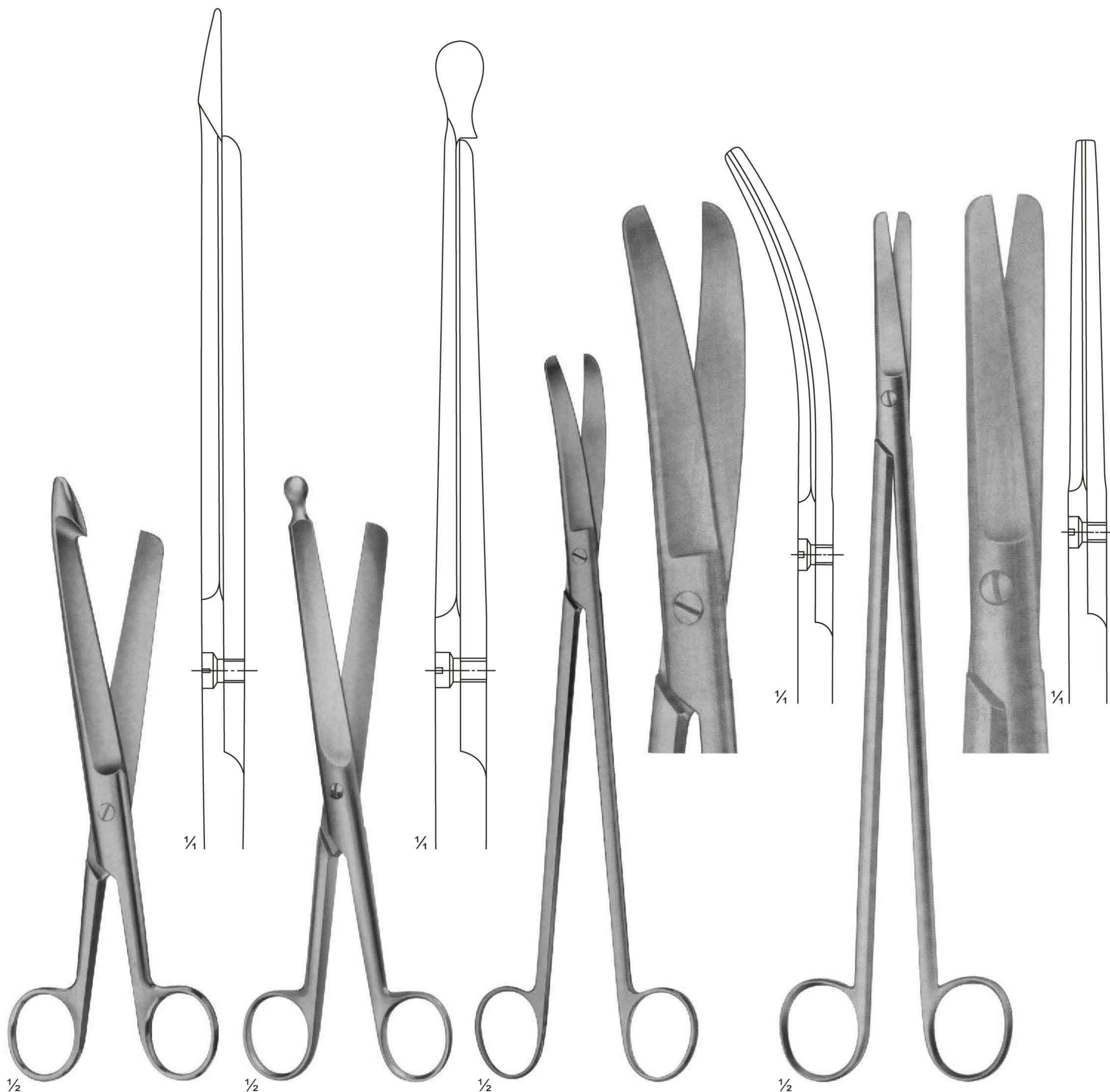

**UG-628**  
DAMMSCHERE  
Bowel Scissors  
Size: 210 mm

**UG-629**  
DAMMSCHERE  
Bowel Scissors  
Size: 210 mm

**UG-630**  
LLOYD-DAVIES  
(GOLIGHER'S)  
Rectal Scissors  
Size: 255 mm

**UG-631**  
STELZNER  
Rectal Scissors  
Size: 310 mm

# Ligature Scissors

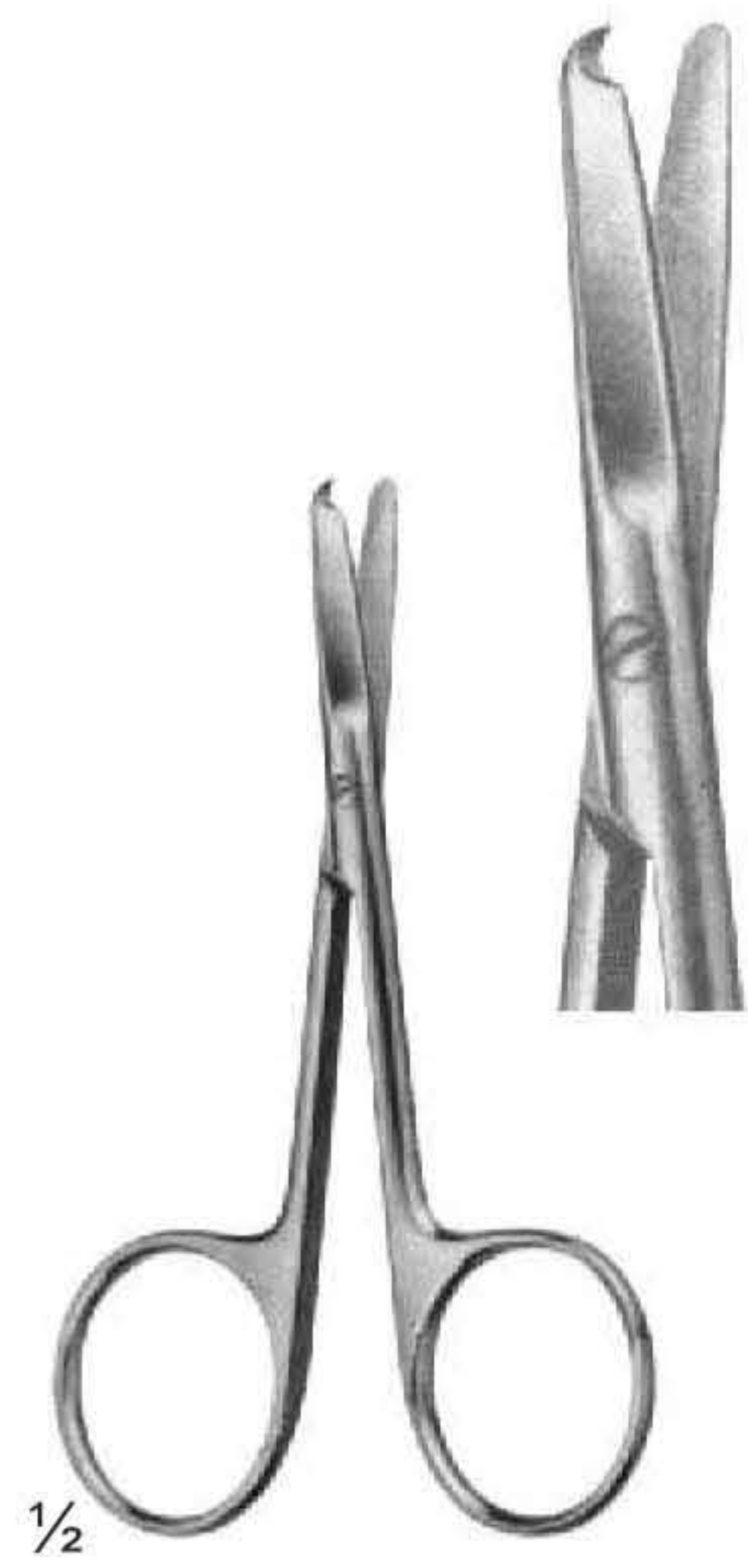

**UG-633**  
SPENCER

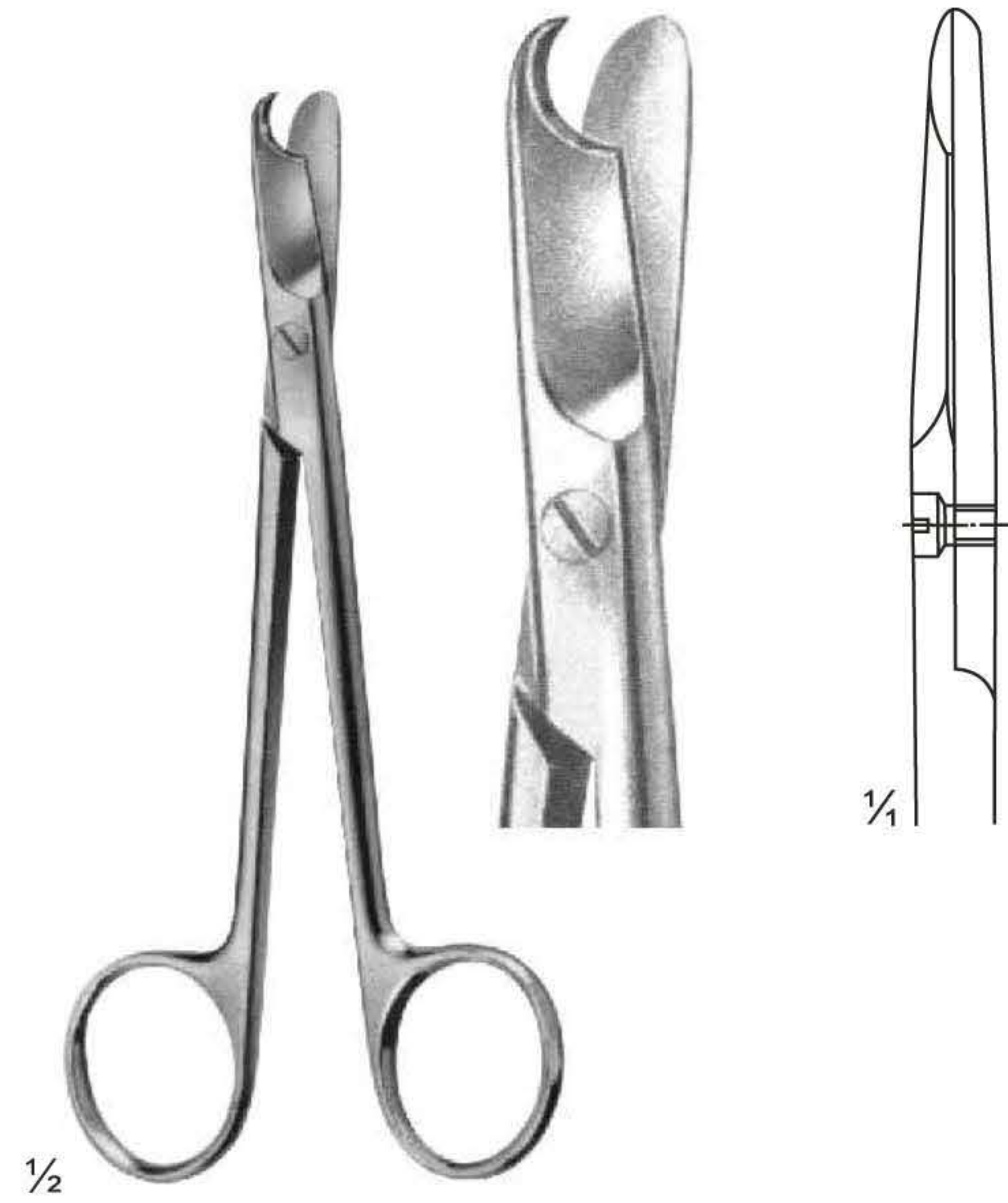

**UG-635**  
LITTAUER  
Size: 135 mm

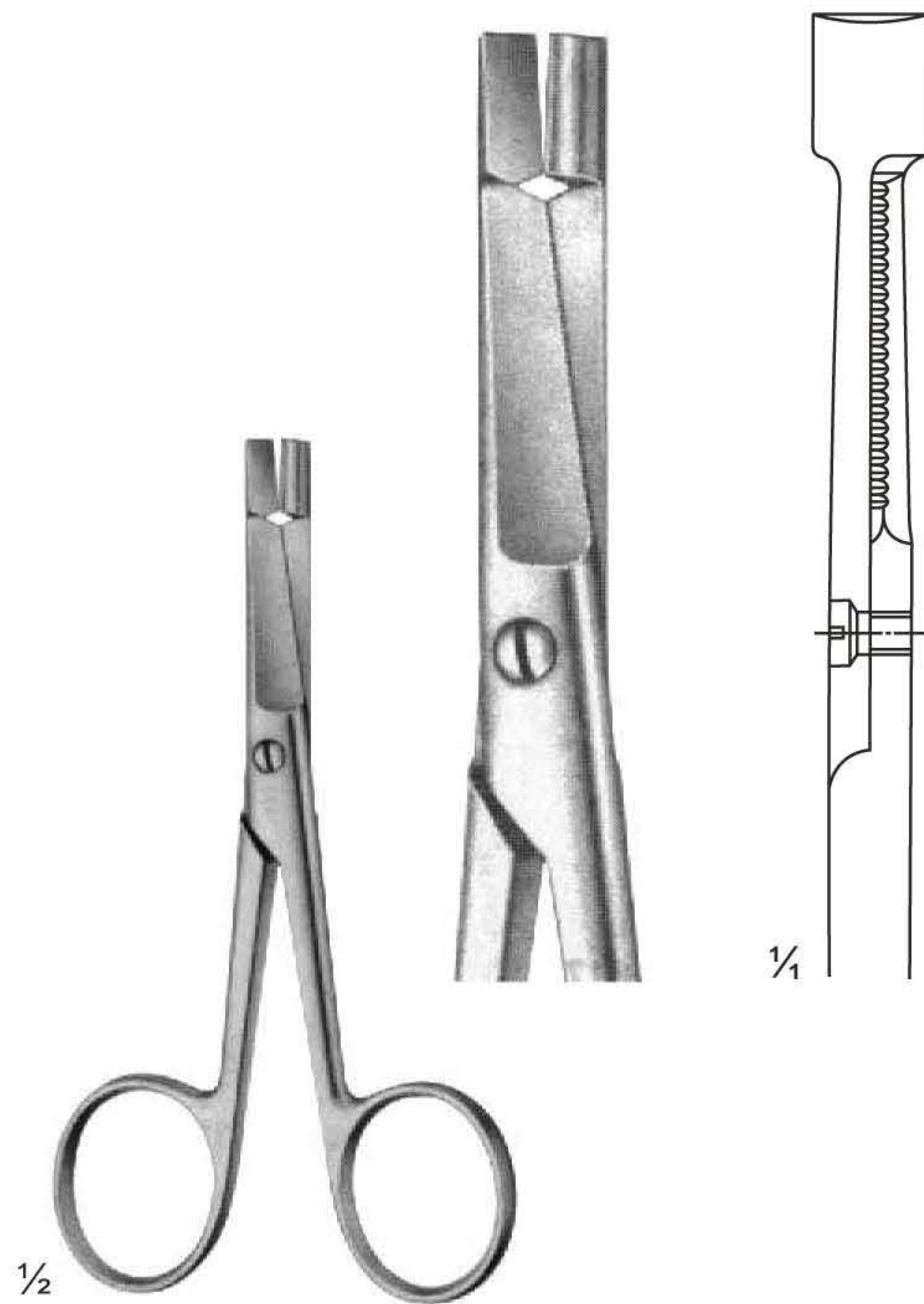

**UG-636**  
EISELSBERG  
Size: 115 mm

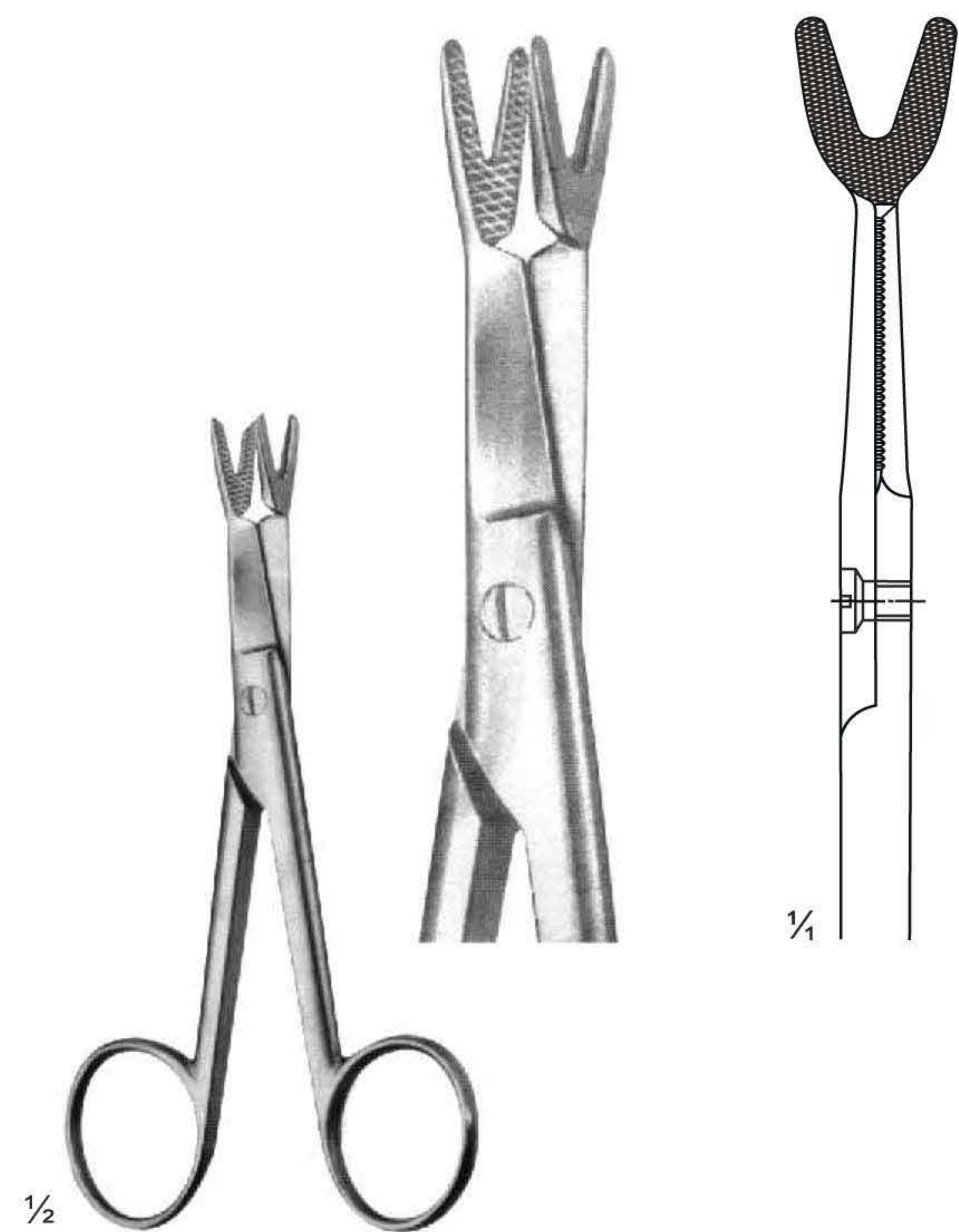

**UG-638**  
SCHOEMAKER-LOTH  
Size: 125 mm

# Wire and Plate Scissors



**UG-639**  
BEEBE  
Size: 110 mm

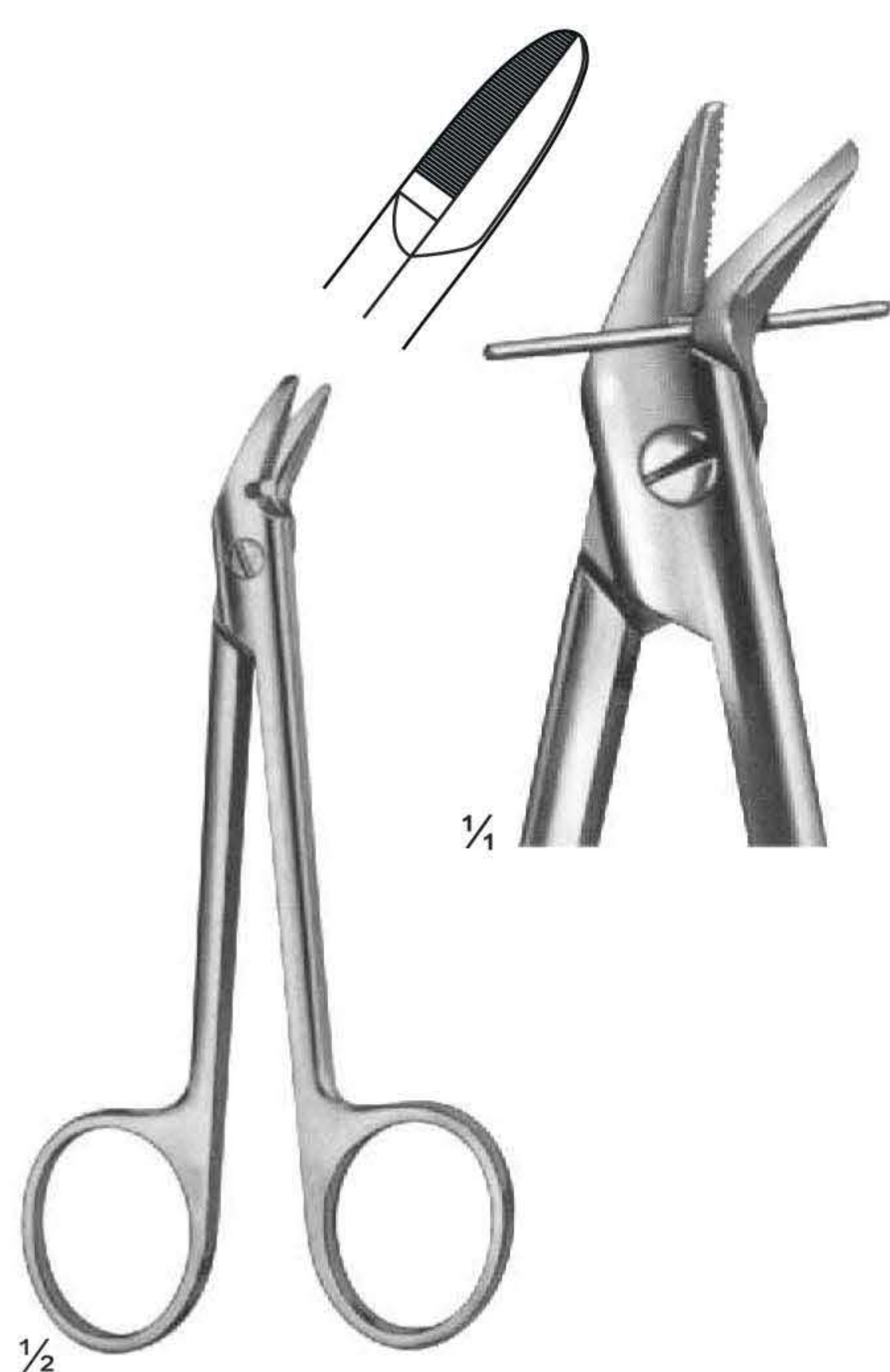

**UG-642**  
1 Blade Serrated  
Size: 120 mm

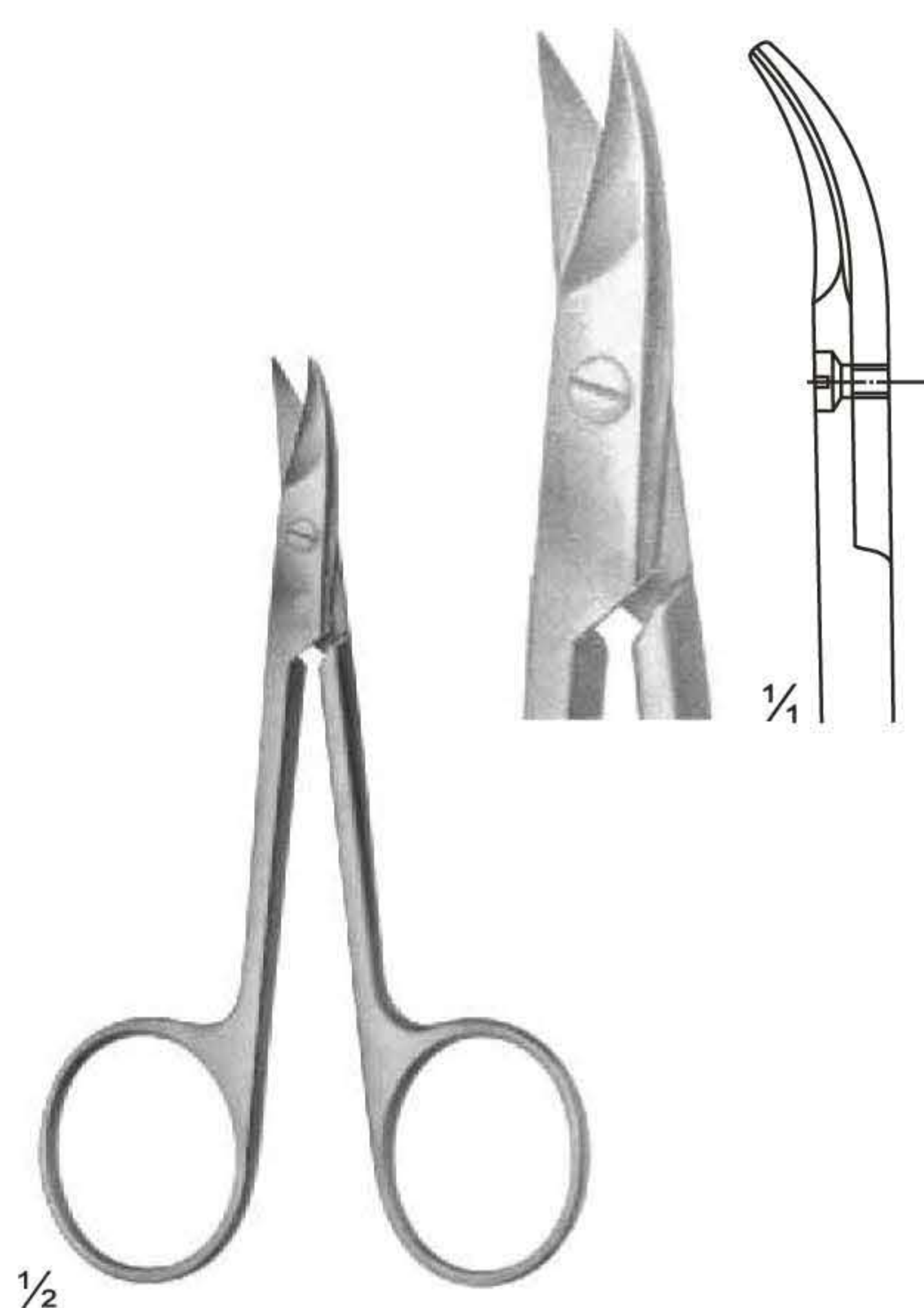

**UG-644**  
STRACK  
Size: 100 mm

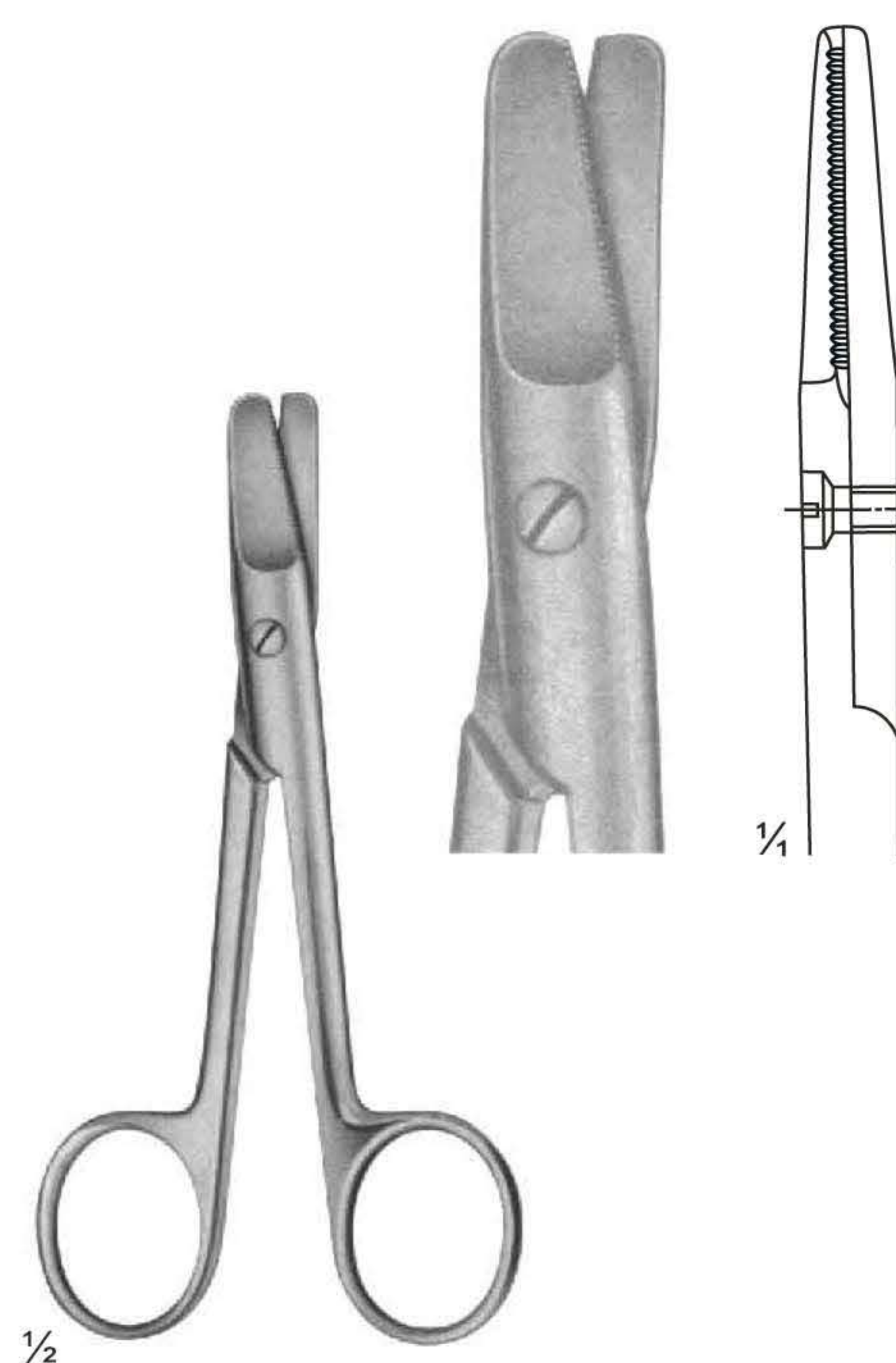

**UG-646**  
HARVEY  
Size: 125 mm

# Wire and Plate Scissors

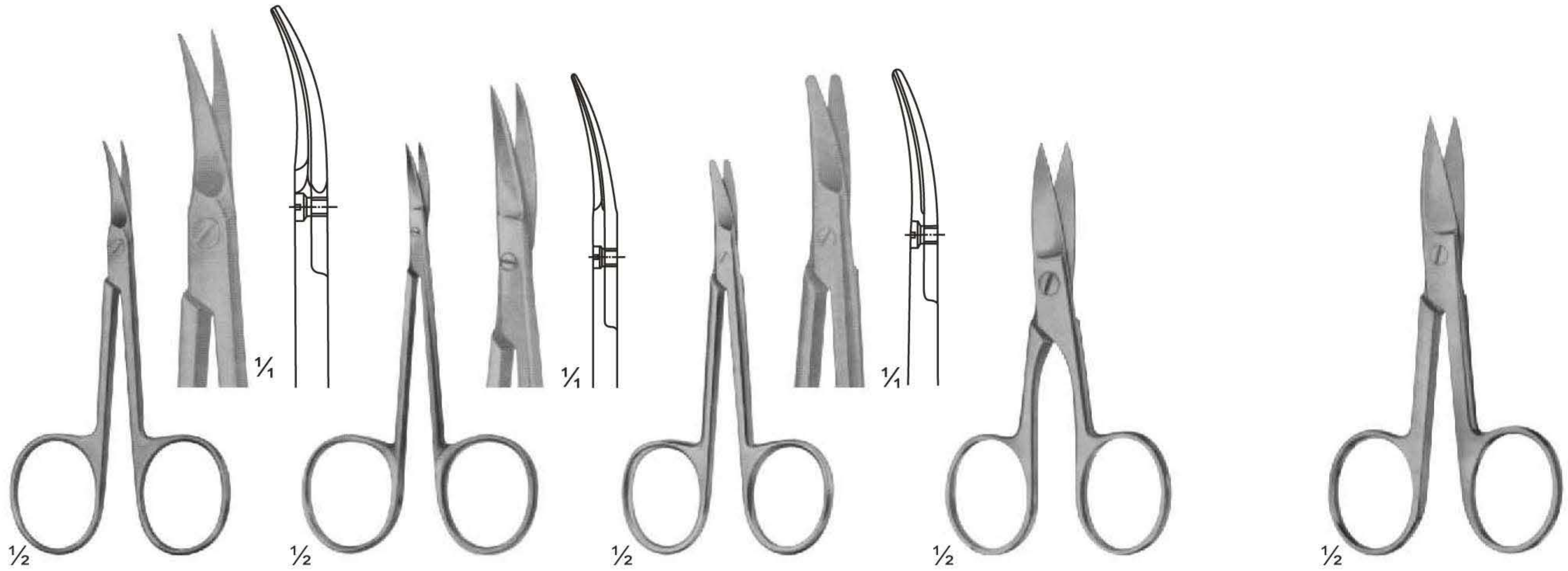

**UG-649**  
NAIL SCISSORS  
Size: 90 mm

**UG-650**  
NAIL SCISSORS  
Size: 90 mm

**UG-651**  
BABY NAIL SCISSORS  
Size: 85 mm

**UG-656**  
NAIL SCISSORS  
Size: 90 mm

**UG-657**  
NAIL SCISSORS  
Size: 90 mm

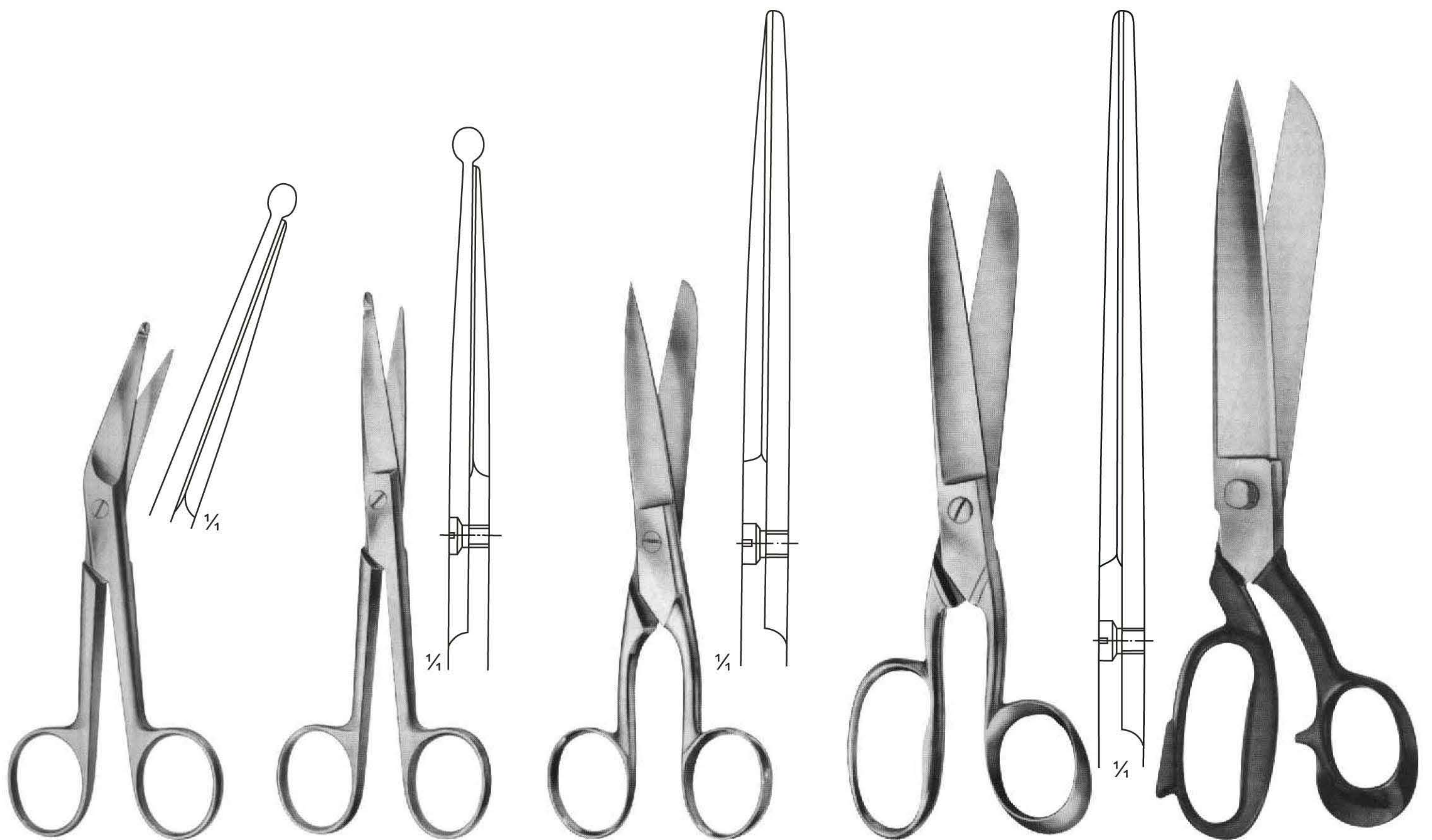

**UG-658**  
KNOWLES  
Size: 140 mm

**UG-659**  
KNOWLES  
Size: 145 mm

**UG-660**  
Size: 150 mm

**UG-661**  
SMITH  
Size: 180 mm

**UG-662**  
Size: 310 mm

# Bandage and Cloth Scissors

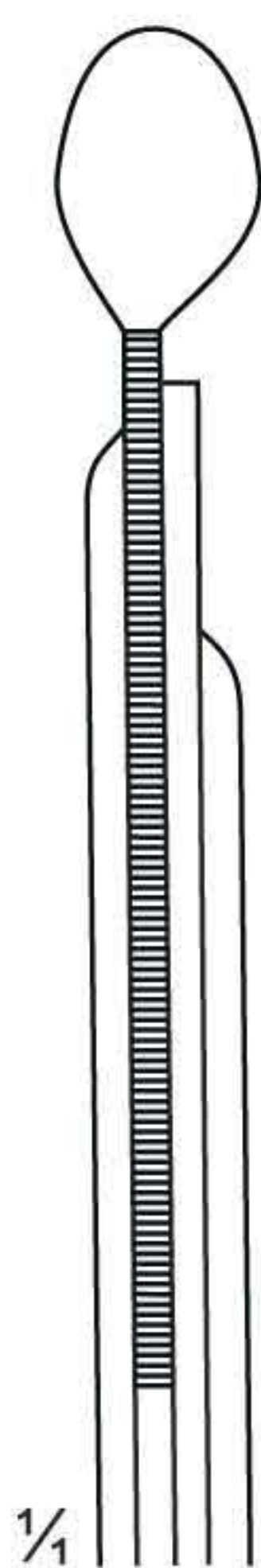

**UG-664**  
UNIVERSAL AND BANDAGE SCISSORS  
180 mm

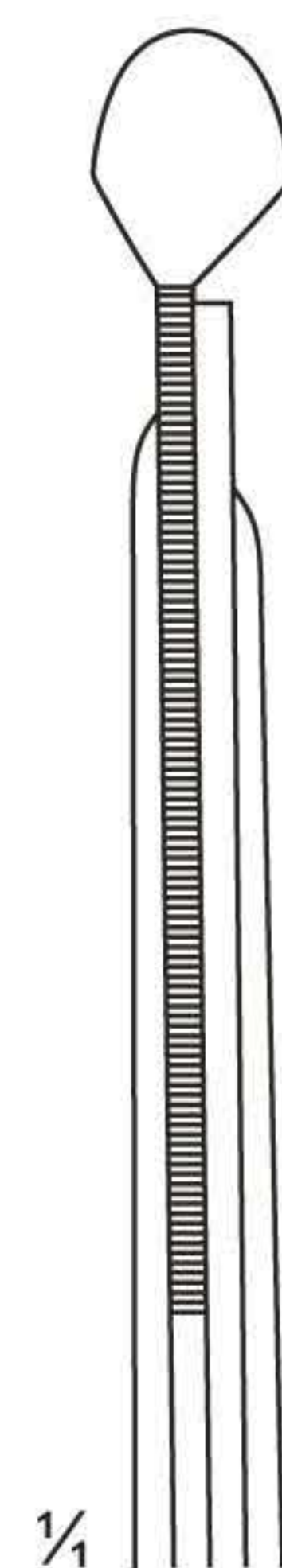
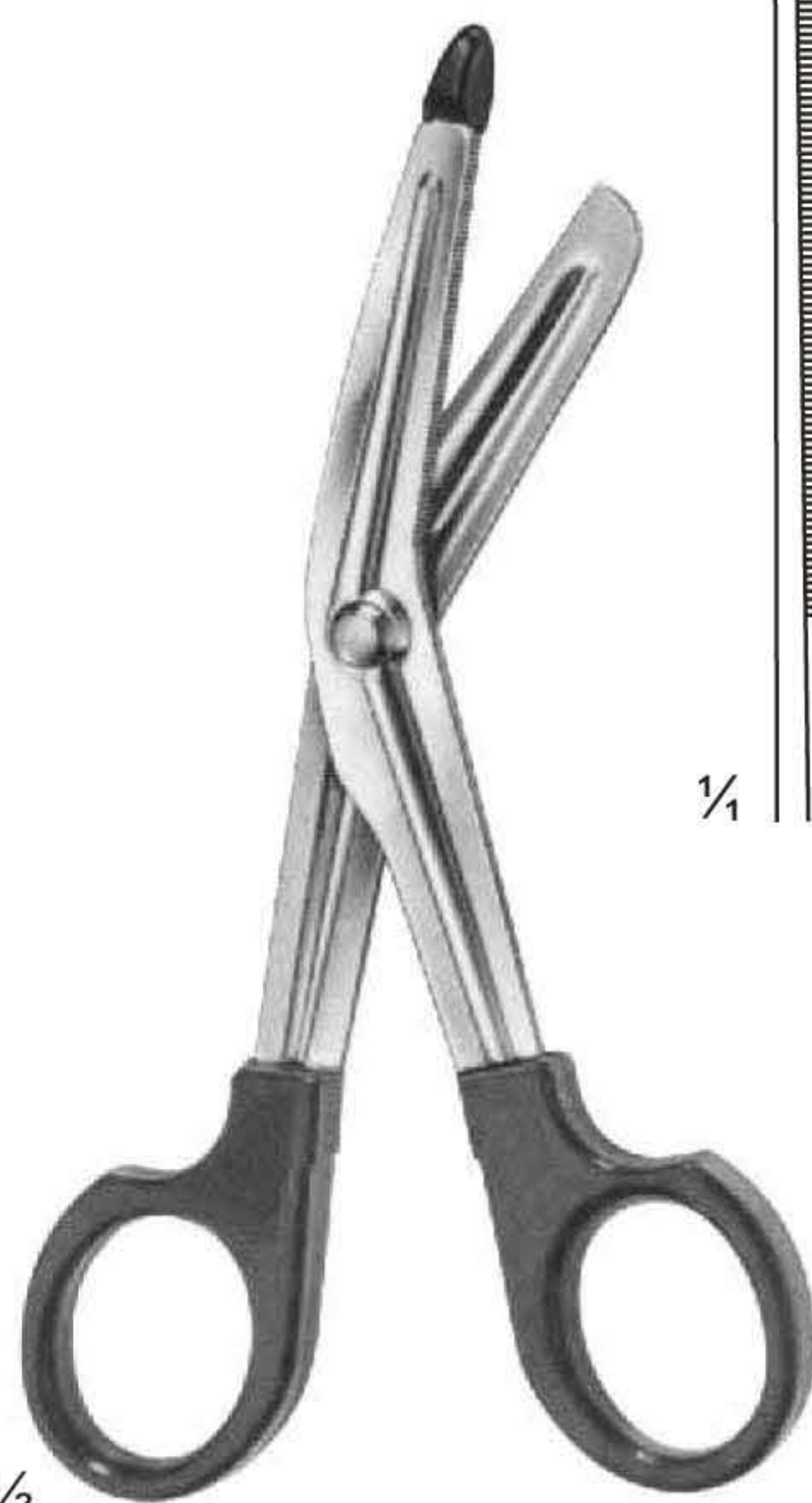

**UG-665**  
LISTER  
Size: 145 mm

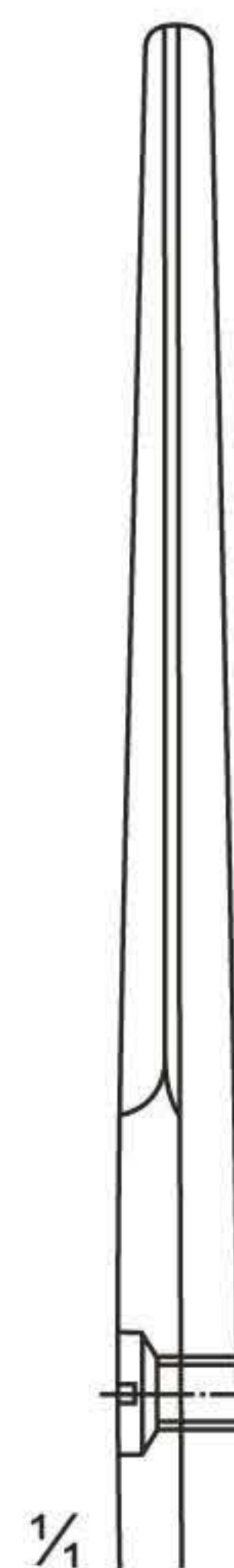
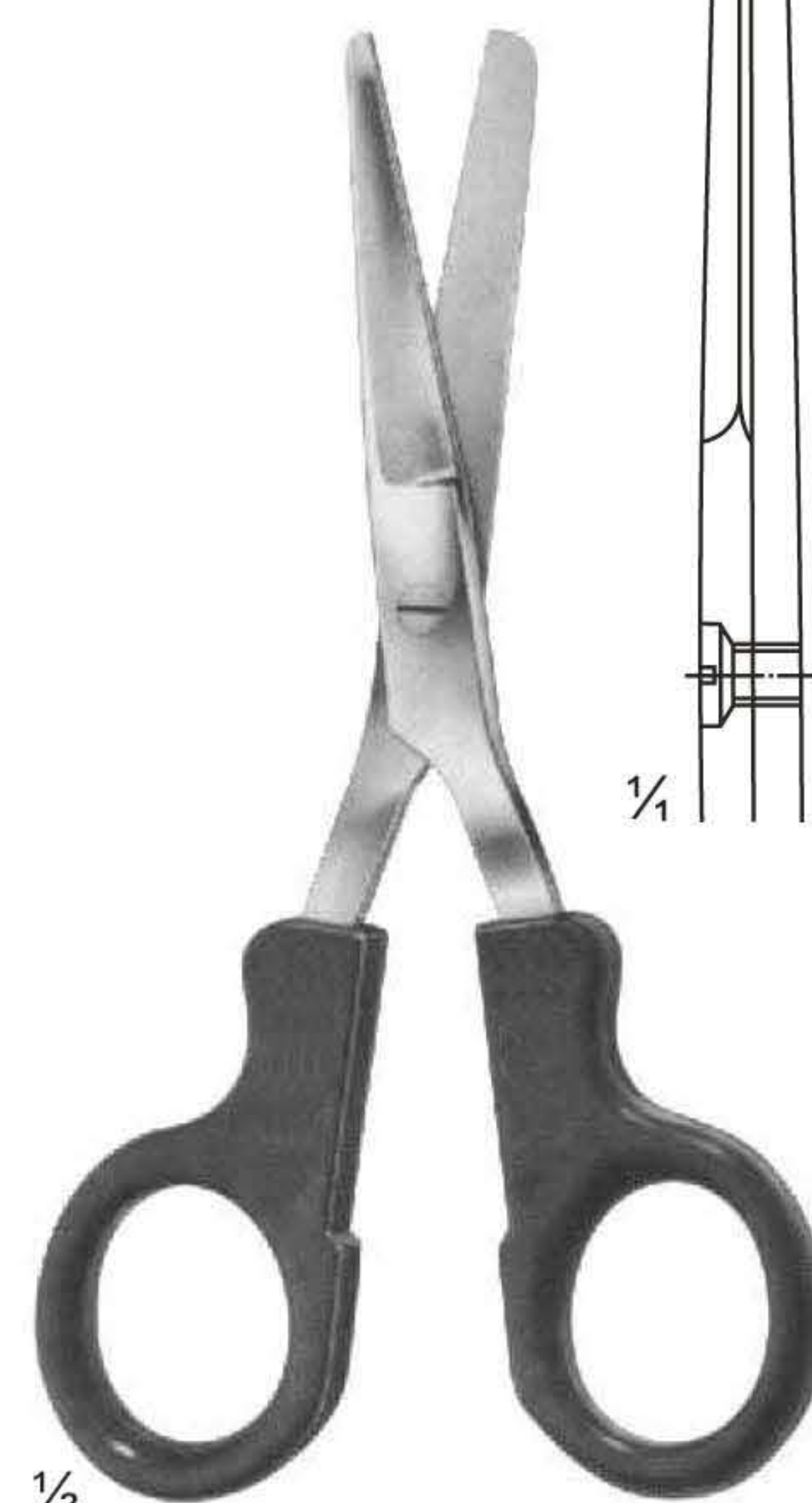

**UG-666**  
LISTER  
Size: 145 mm



**UG-667**  
LISTER



**UG-672**  
LISTER

# Bandage, Cloth and Plaster Scissors

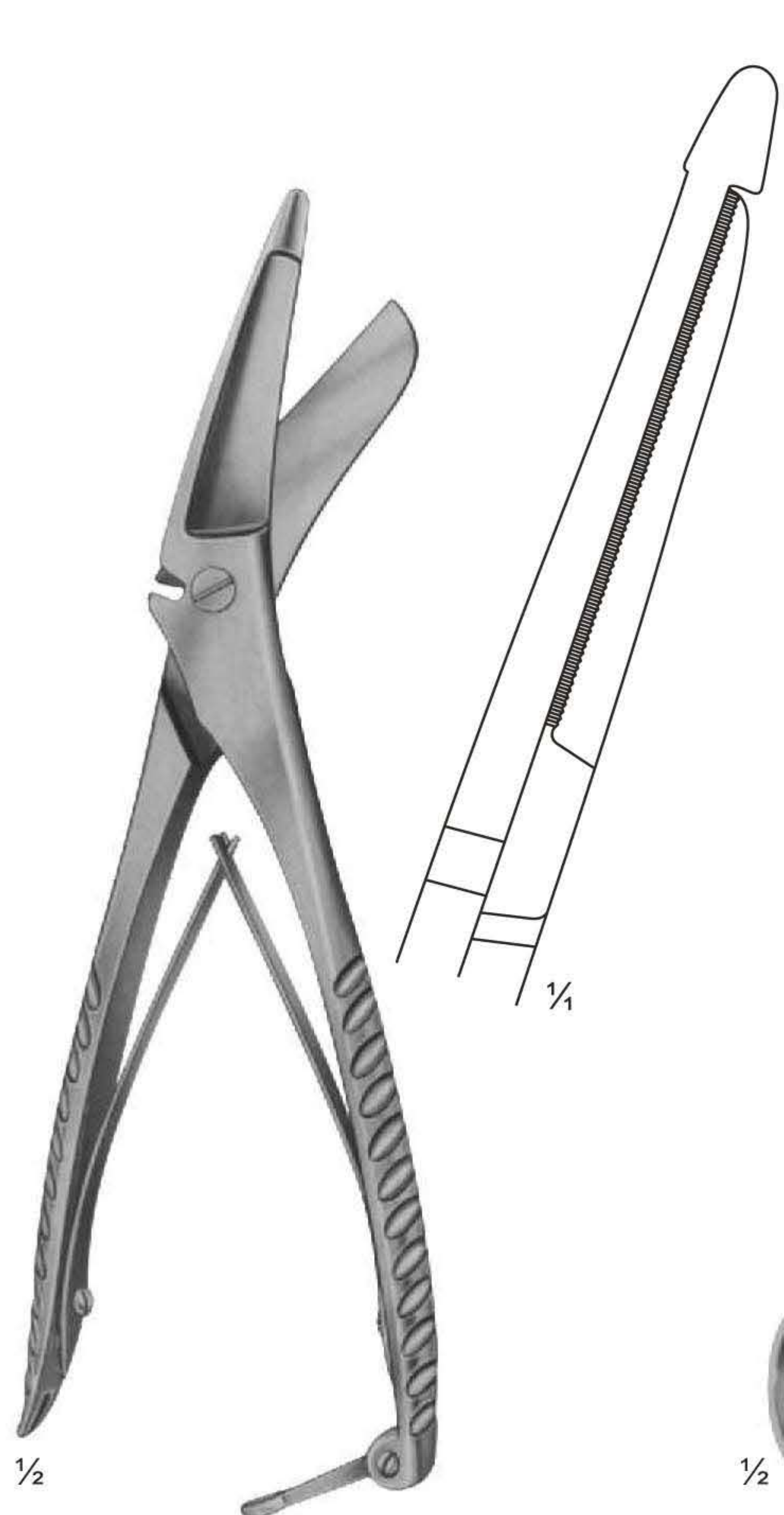

**UG-677**  
CLOTH SCISSORS  
205 mm

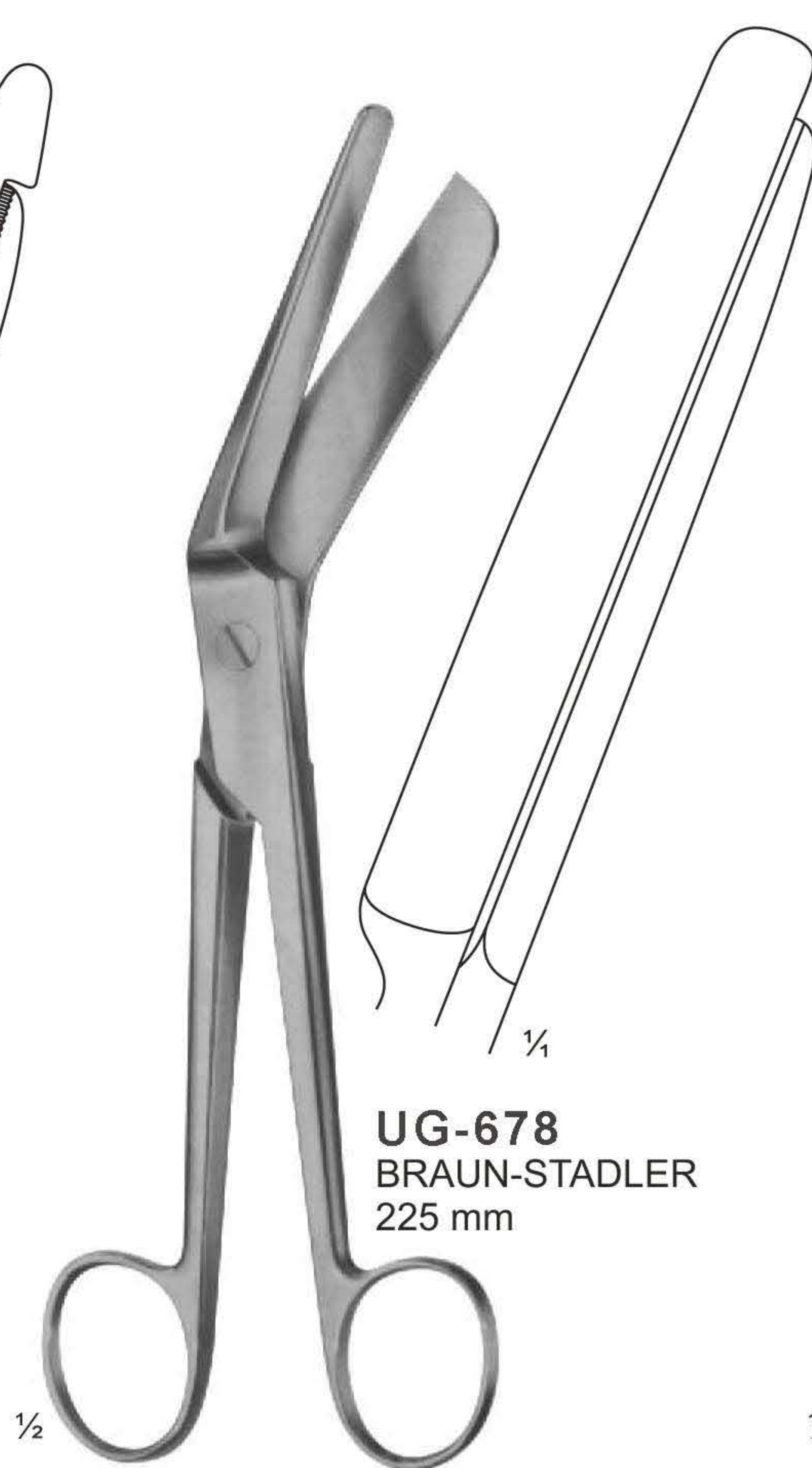

**UG-678**  
BRAUN-STADLER  
225 mm

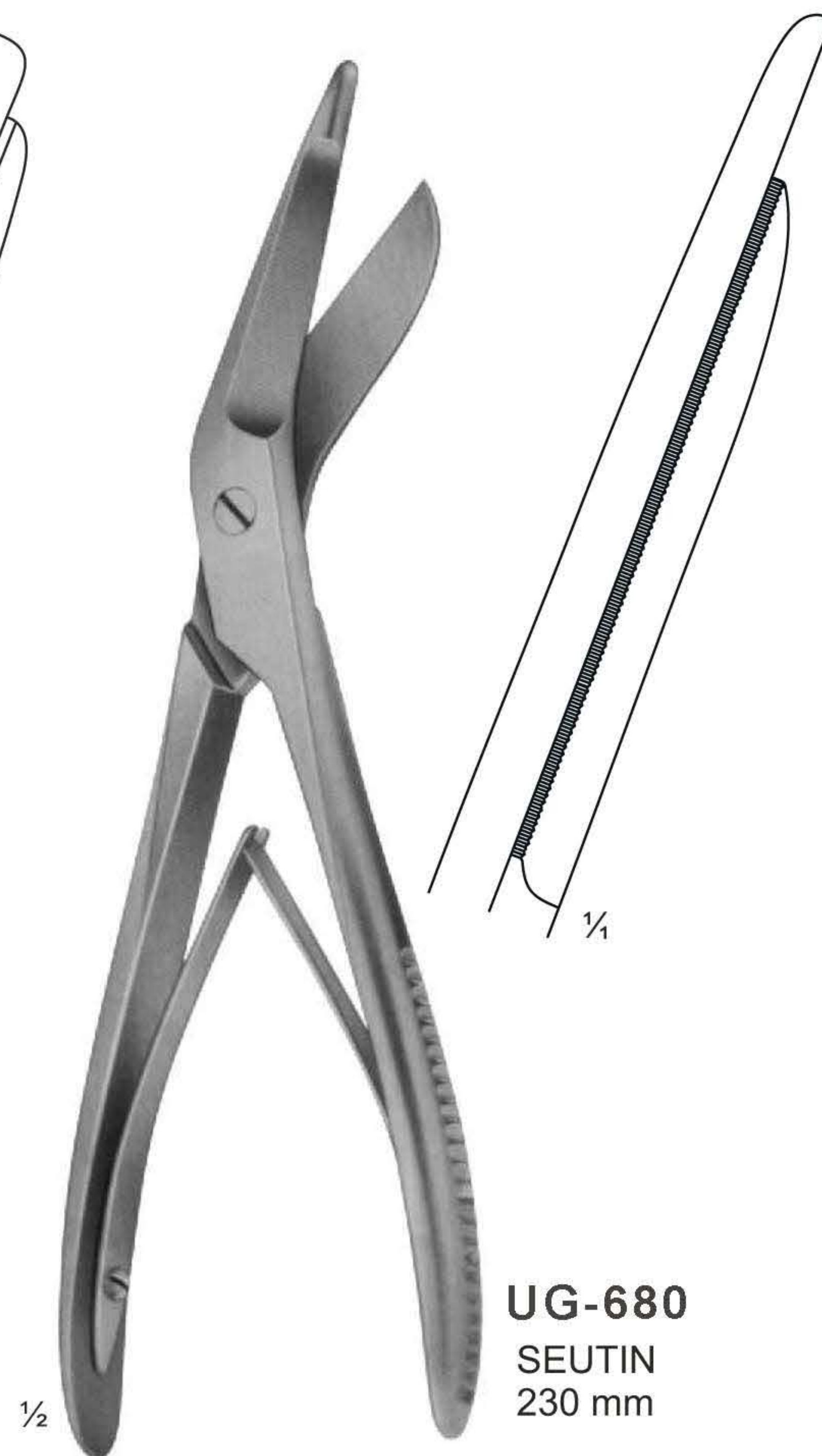

**UG-680**  
SEUTIN  
230 mm



**UG-681**  
ESMARCH

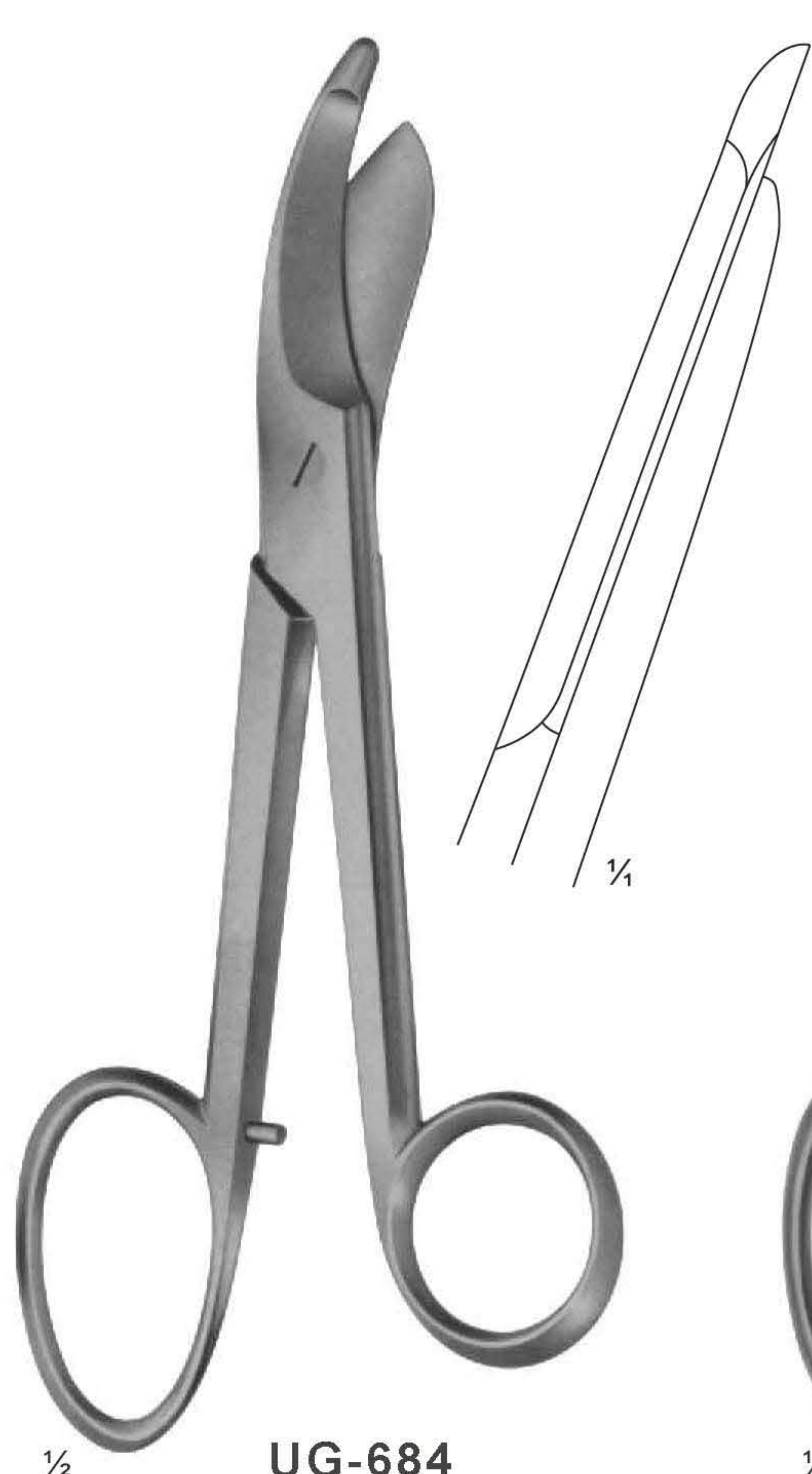

**UG-684**  
BRUNS  
235 mm

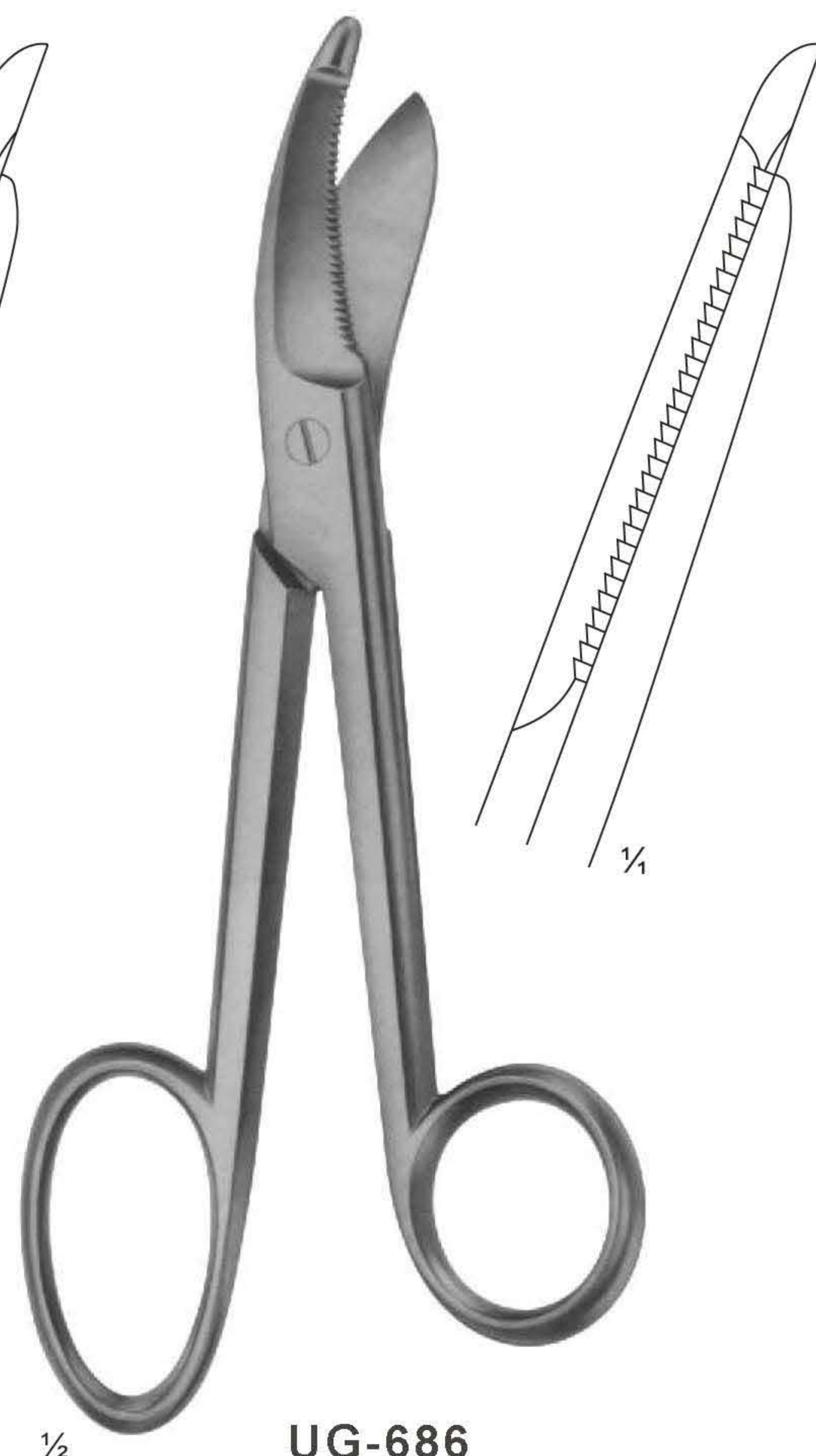

**UG-686**  
BRUNS  
235 mm

# Micro Forceps, Jeweler Types

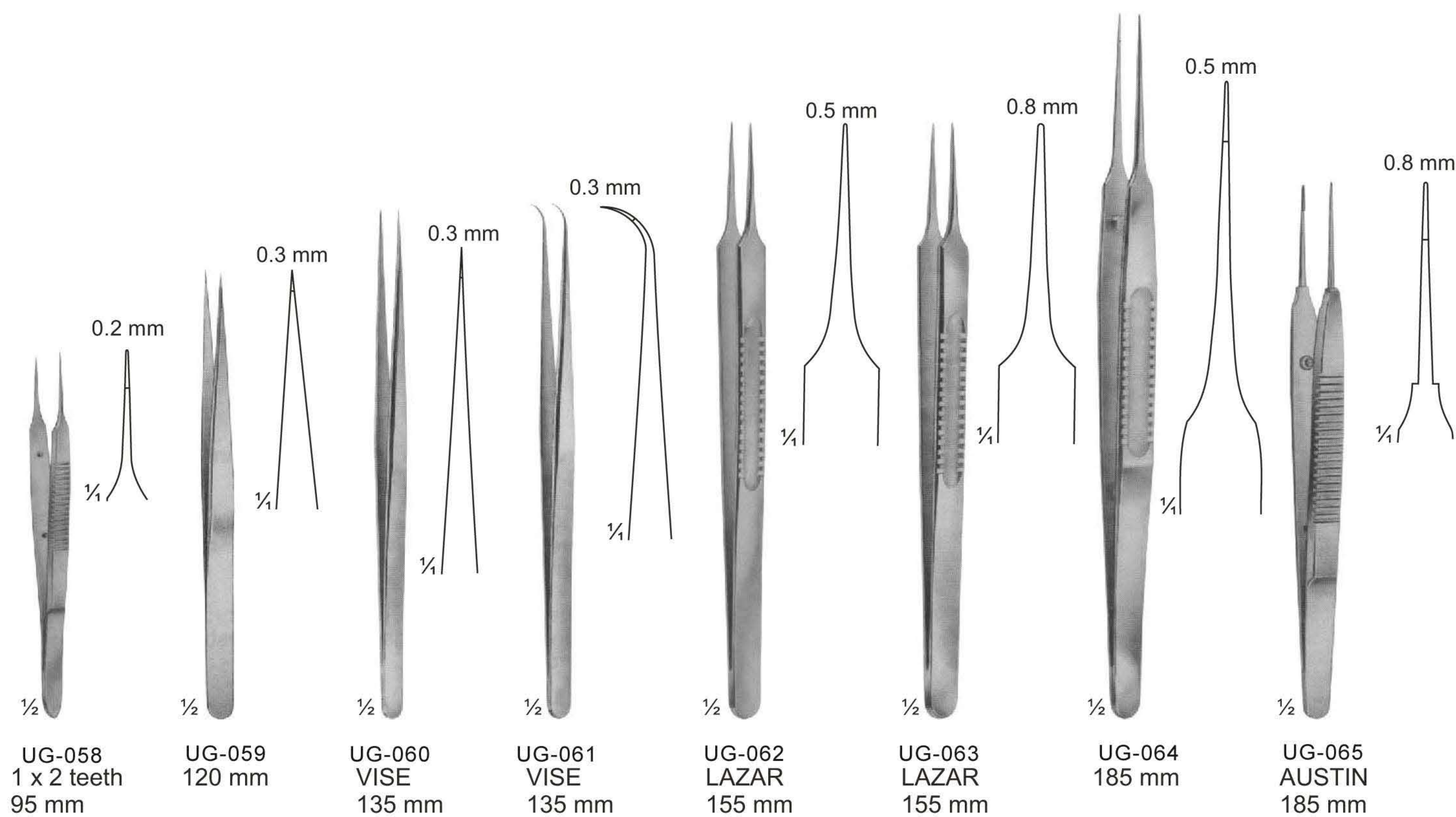
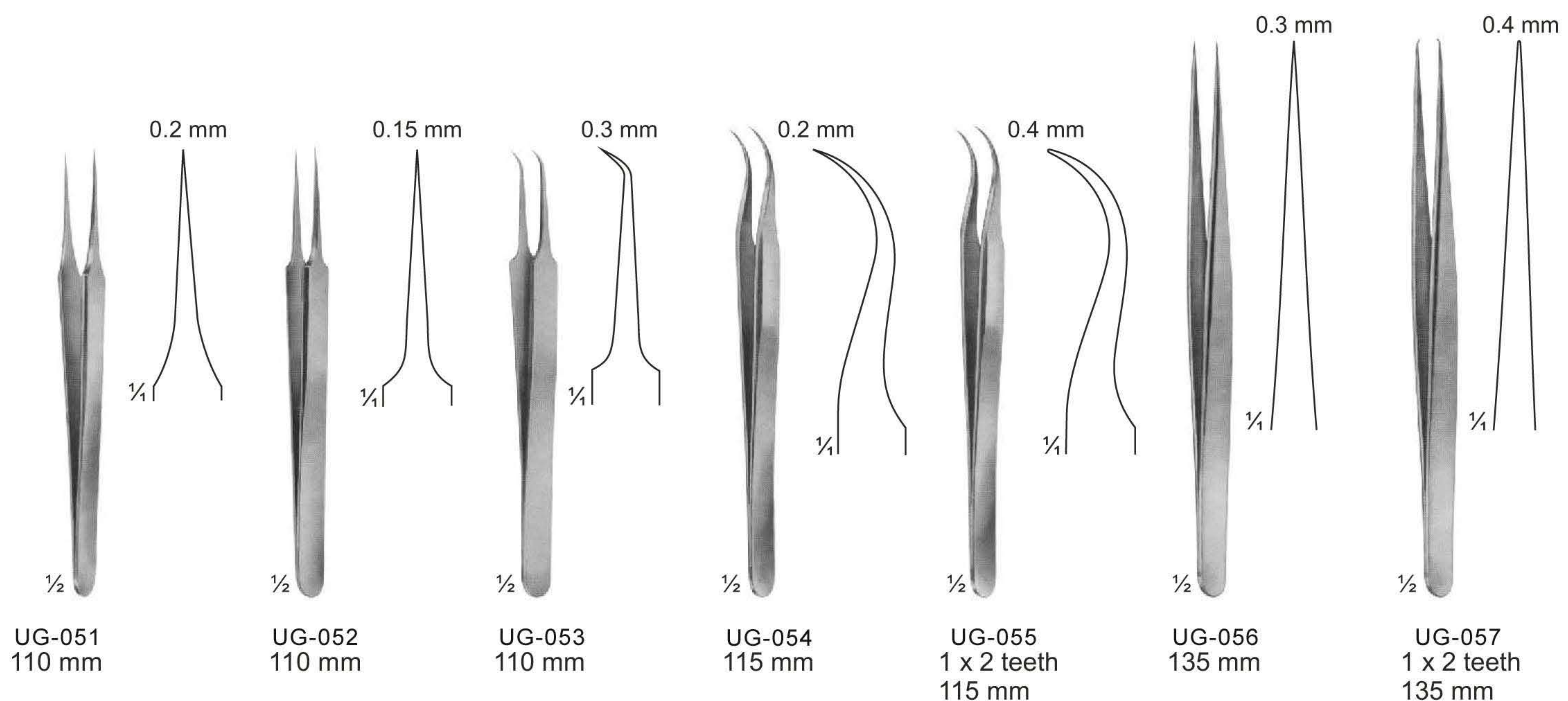



# Ligature Forceps, Micro Forceps (Light Patterns)



UG-068  
MULLER  
110 mm

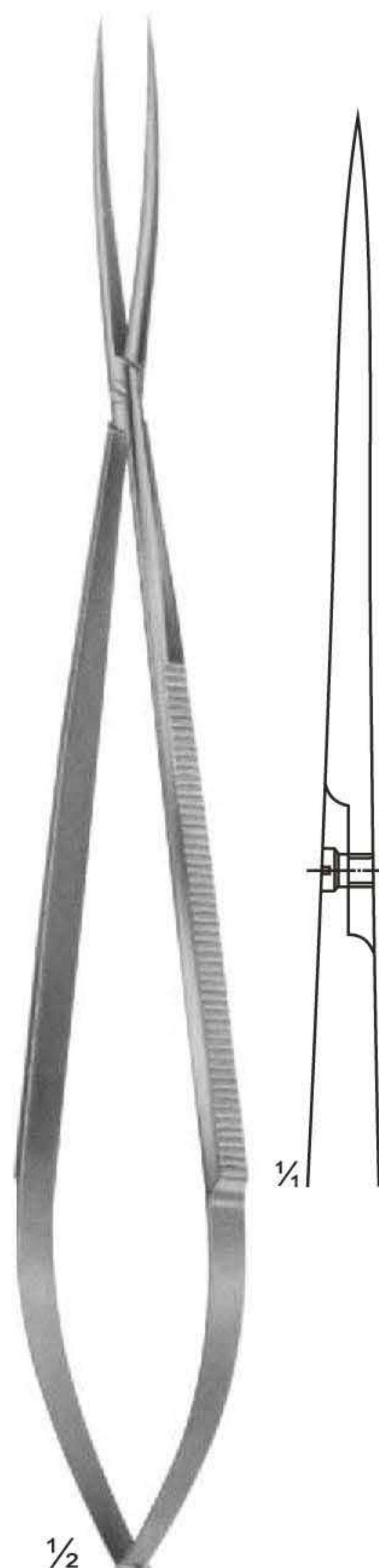

UG-071  
LIGATURE FORCEPS  
220 mm

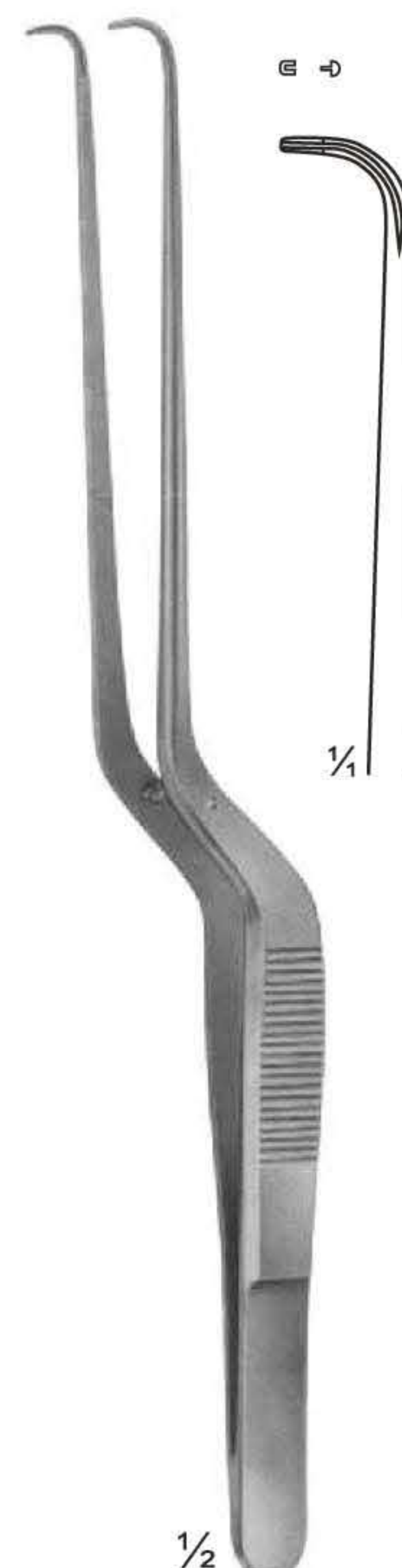

UG-072  
YASARGIL  
185 mm



UG-075  
MICRO FORCEPS  
185 mm



UG-076  
YASARGIL  
180 mm



UG-085  
YASARGIL  
200 mm



UG-086  
YASARGIL  
220 mm



UG-087  
YASARGIL  
240 mm

# Forceps for Grasping Tissue, Tumors



1/2

UG-090  
YASARGIL-SAMI  
Jaws Spoon-Shaped  
240 mm



1/2

UG-094  
YASARGIL  
Jaws Spoon-Shaped  
220 mm



1/2

UG-097  
SAMII  
Jaws Spoon-Shaped  
230 mm



1/2

UG-100  
SAMII  
Jaws Spoon-Shaped  
230 mm

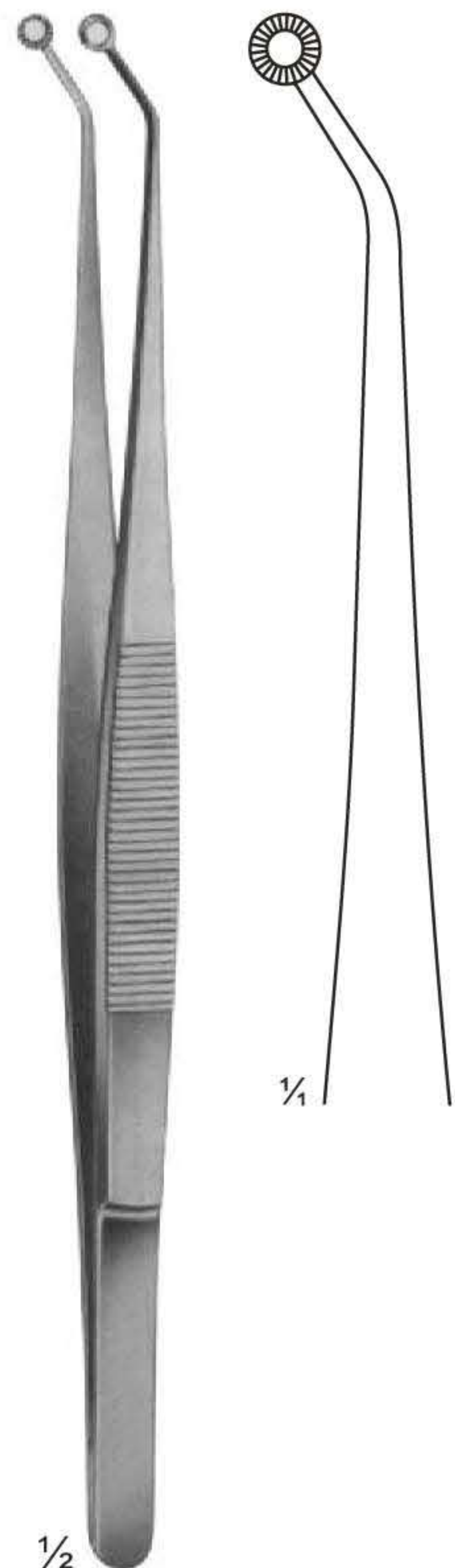

1/4

UG-104 1/2  
HUNT  
Tumor-and Vessel Forceps  
200 mm

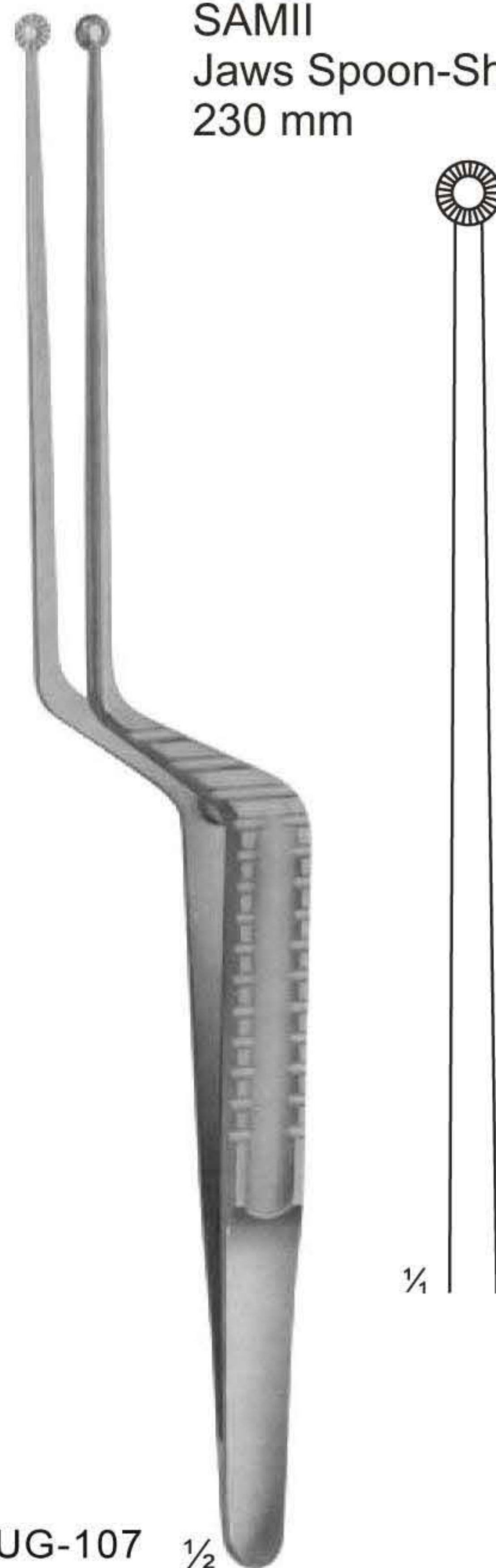

1/4

UG-107 1/2  
HUNT  
Tumor-and Vessel Forceps  
200 mm

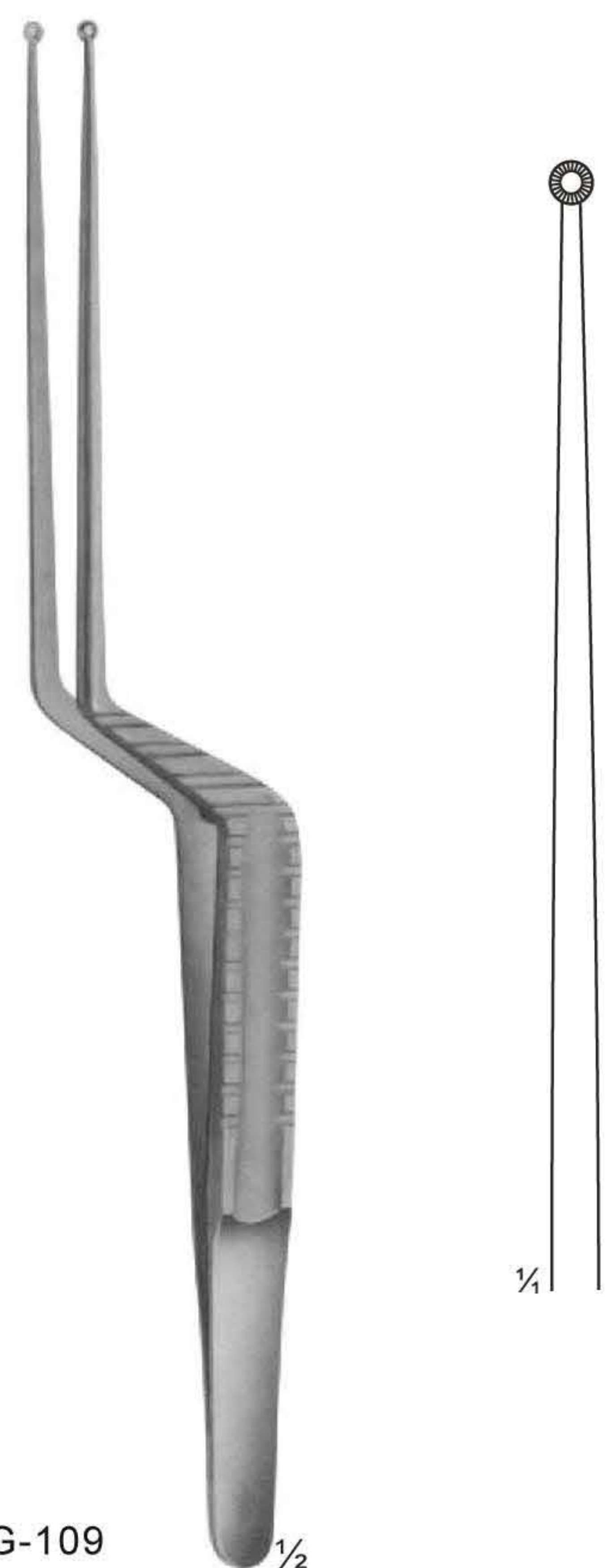

1/4

UG-109 1/2  
YASARGIL  
Tumor-and Vessel Forceps  
200 mm

# Delicate Dissecting, Microscopic, Sterilizing Forceps

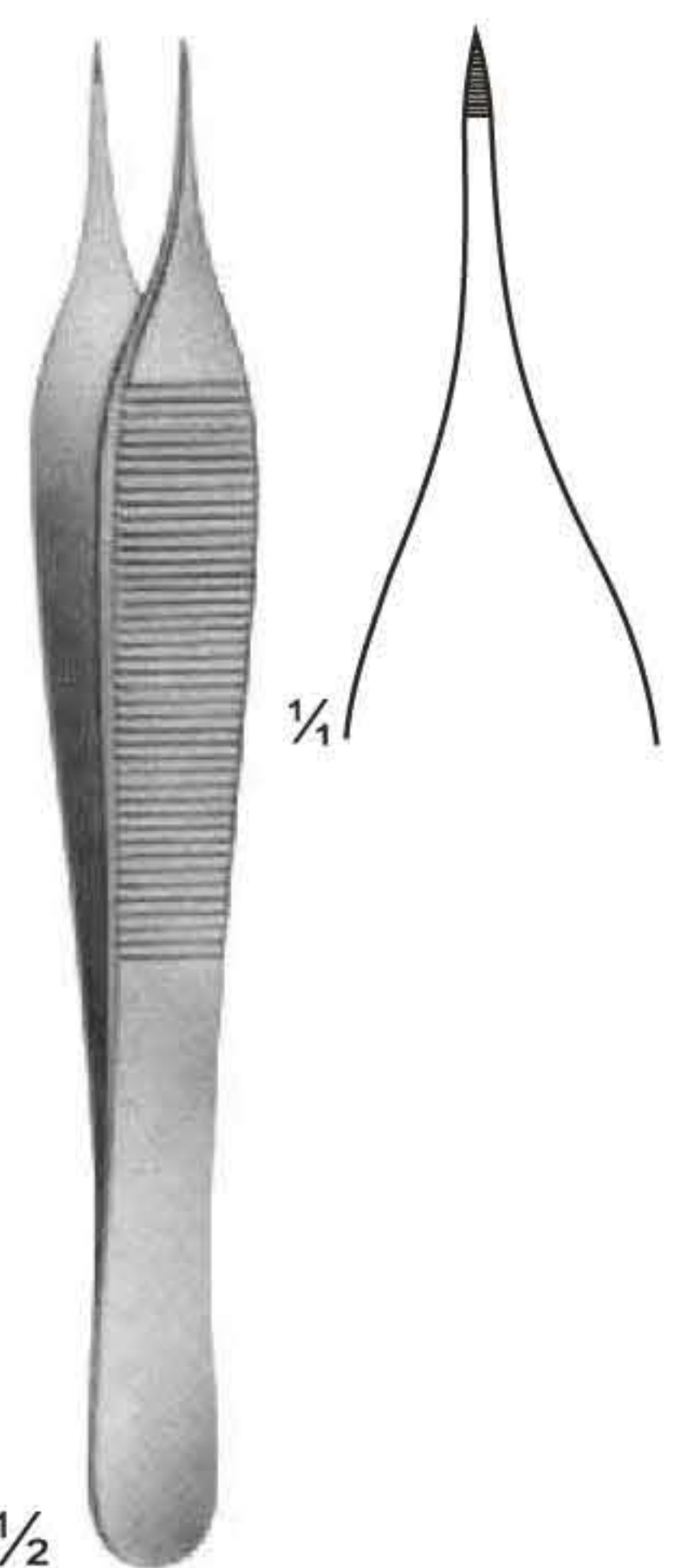

UG-112  
THORPE  
Corneal Forceps  
120 mm

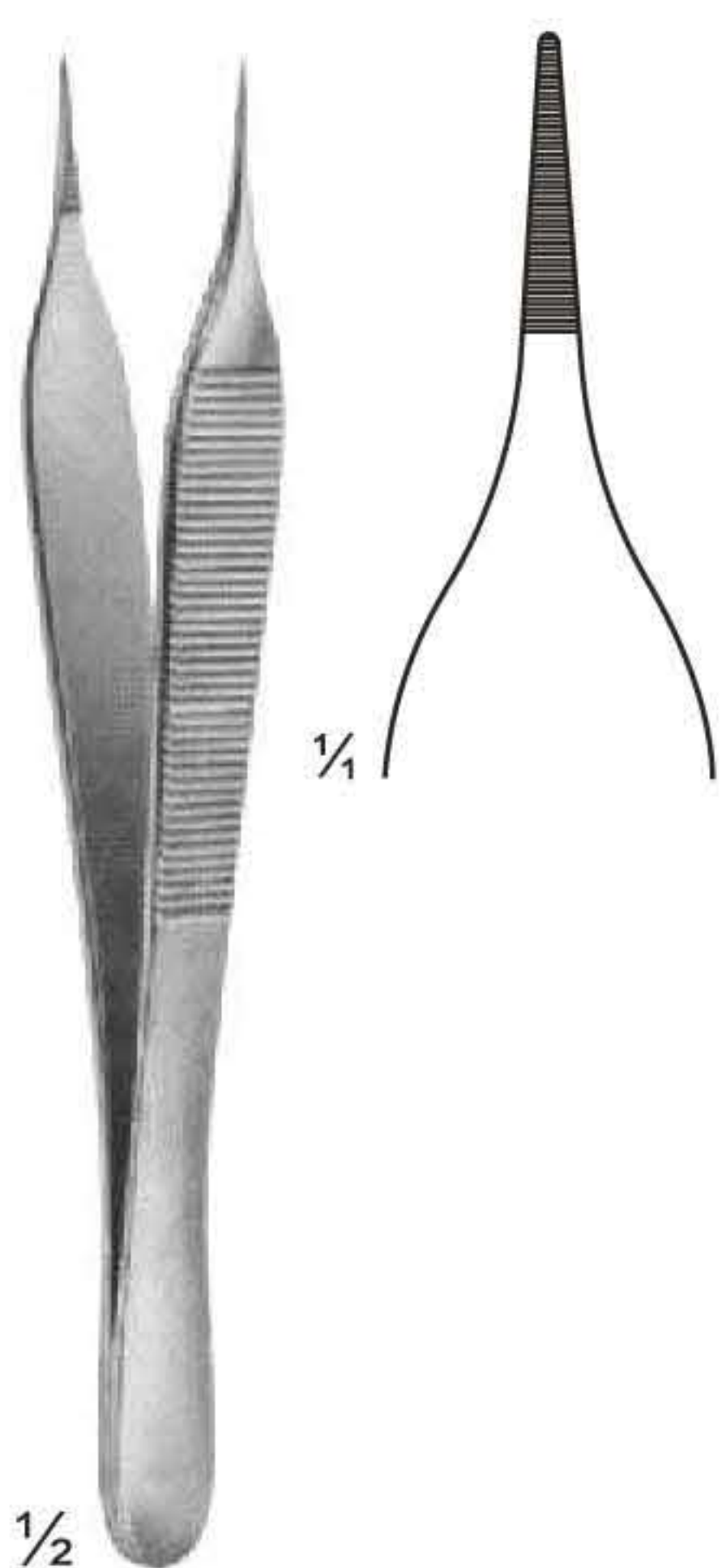

UG-115  
MICRO-ADSON  
120 mm

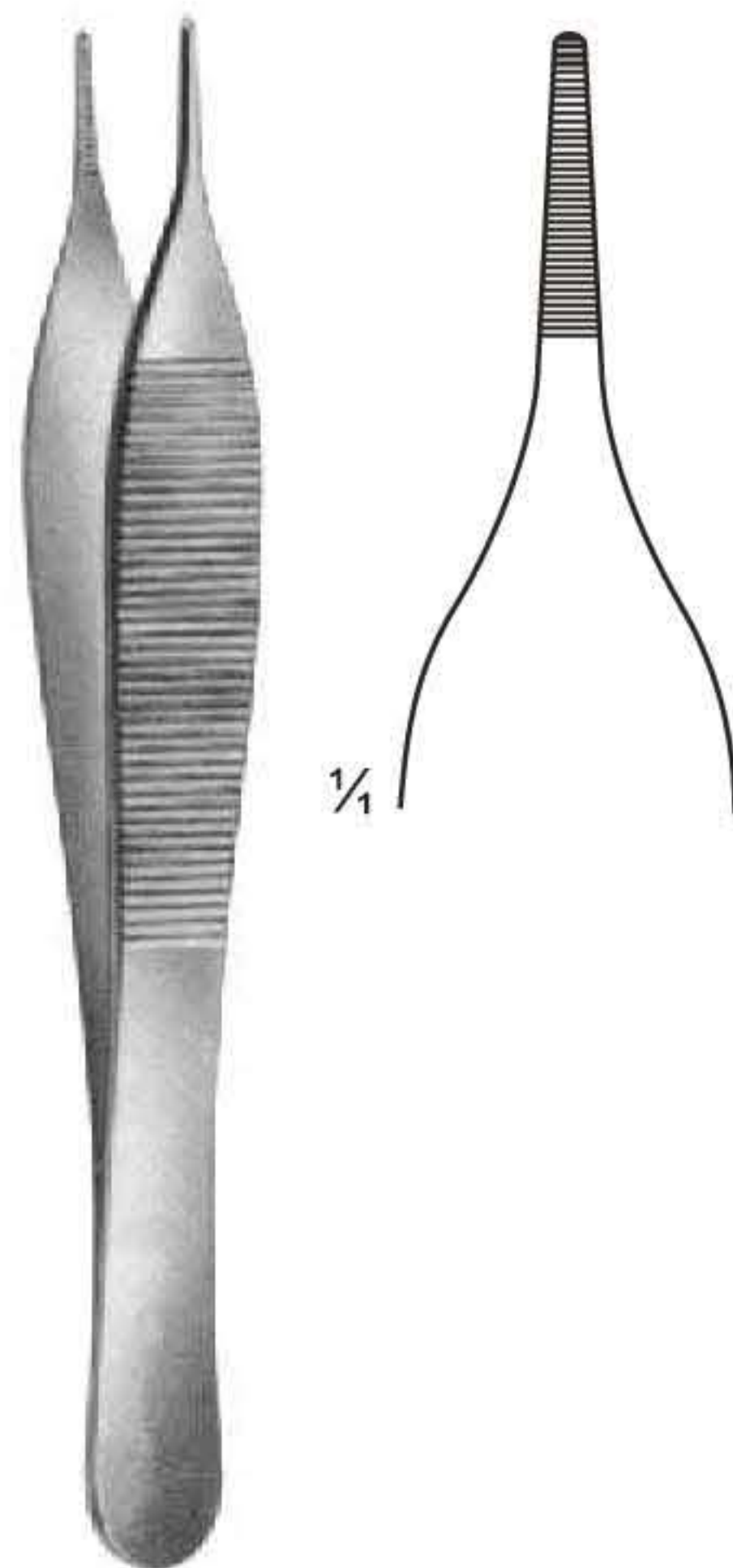

UG-116  
ADSON  
120 mm

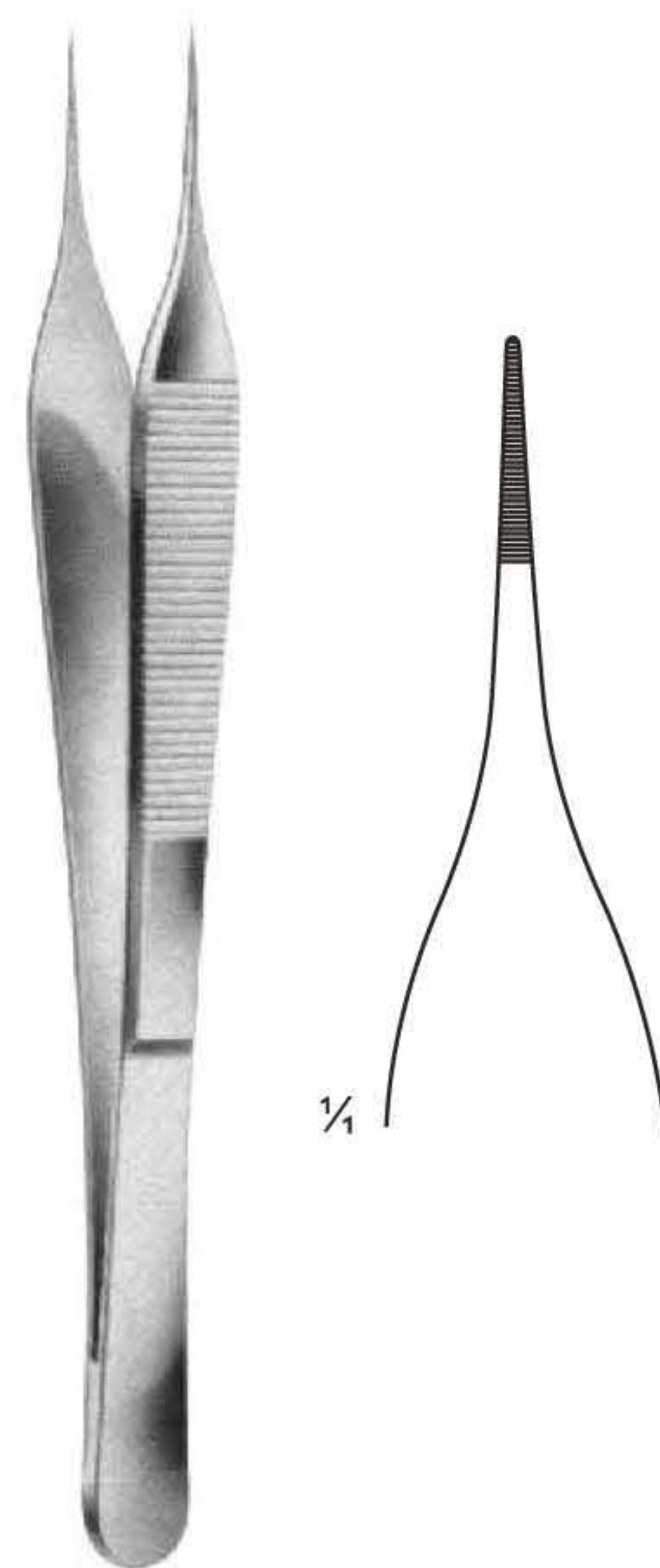

UG-117  
MICRO-ADSON  
150 mm



UG-118  
100 mm

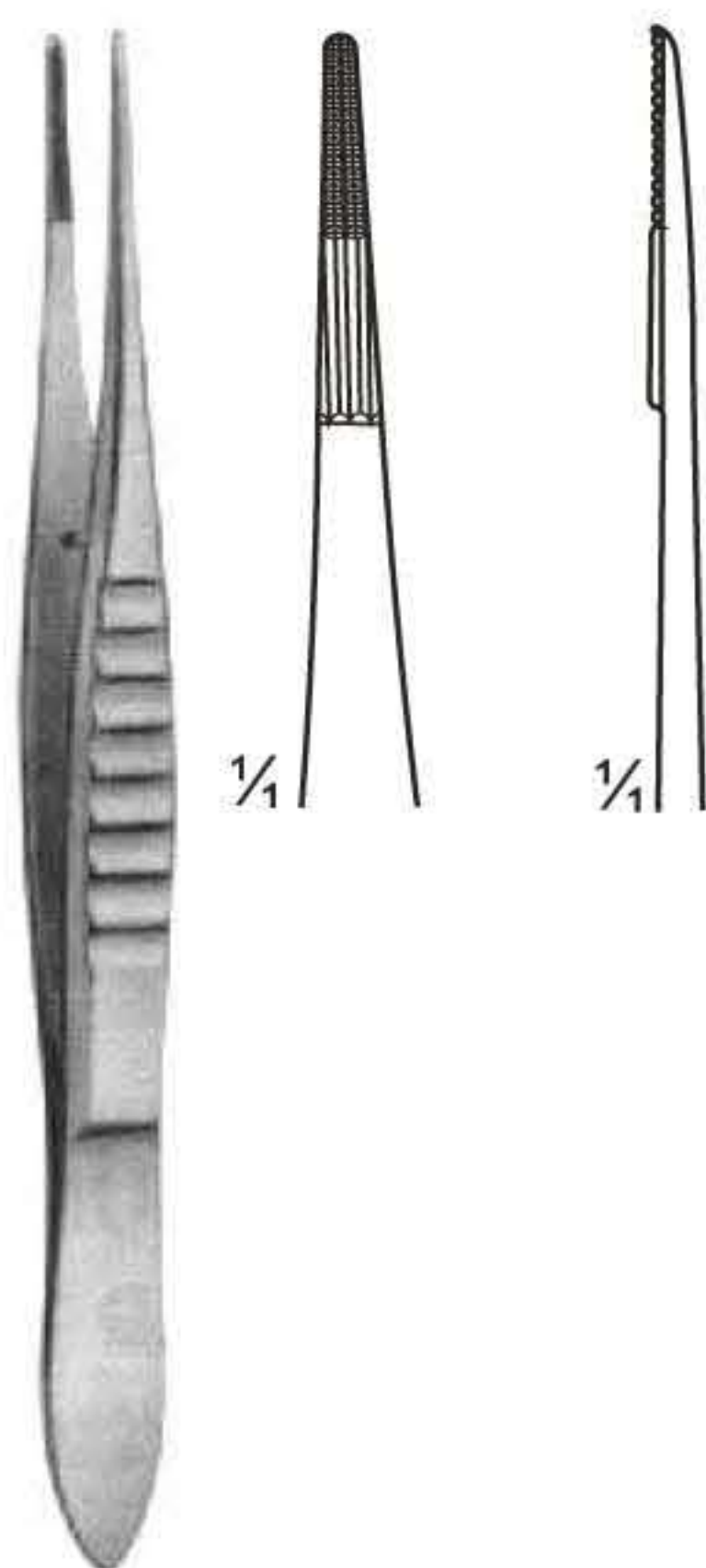

UG-120  
110 mm

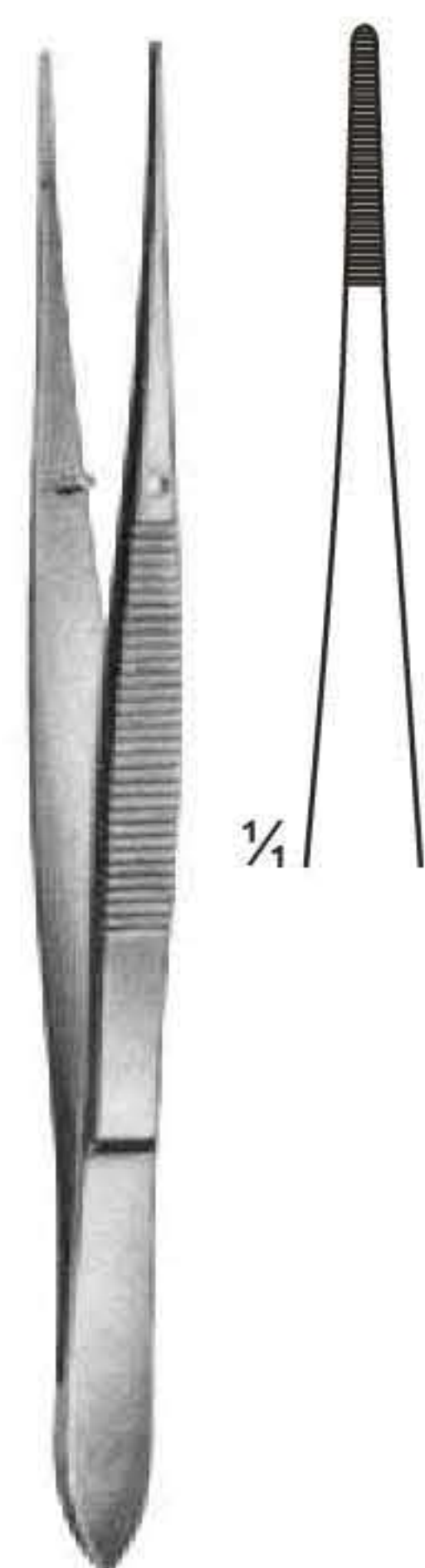

UG-121  
115 mm



UG-123

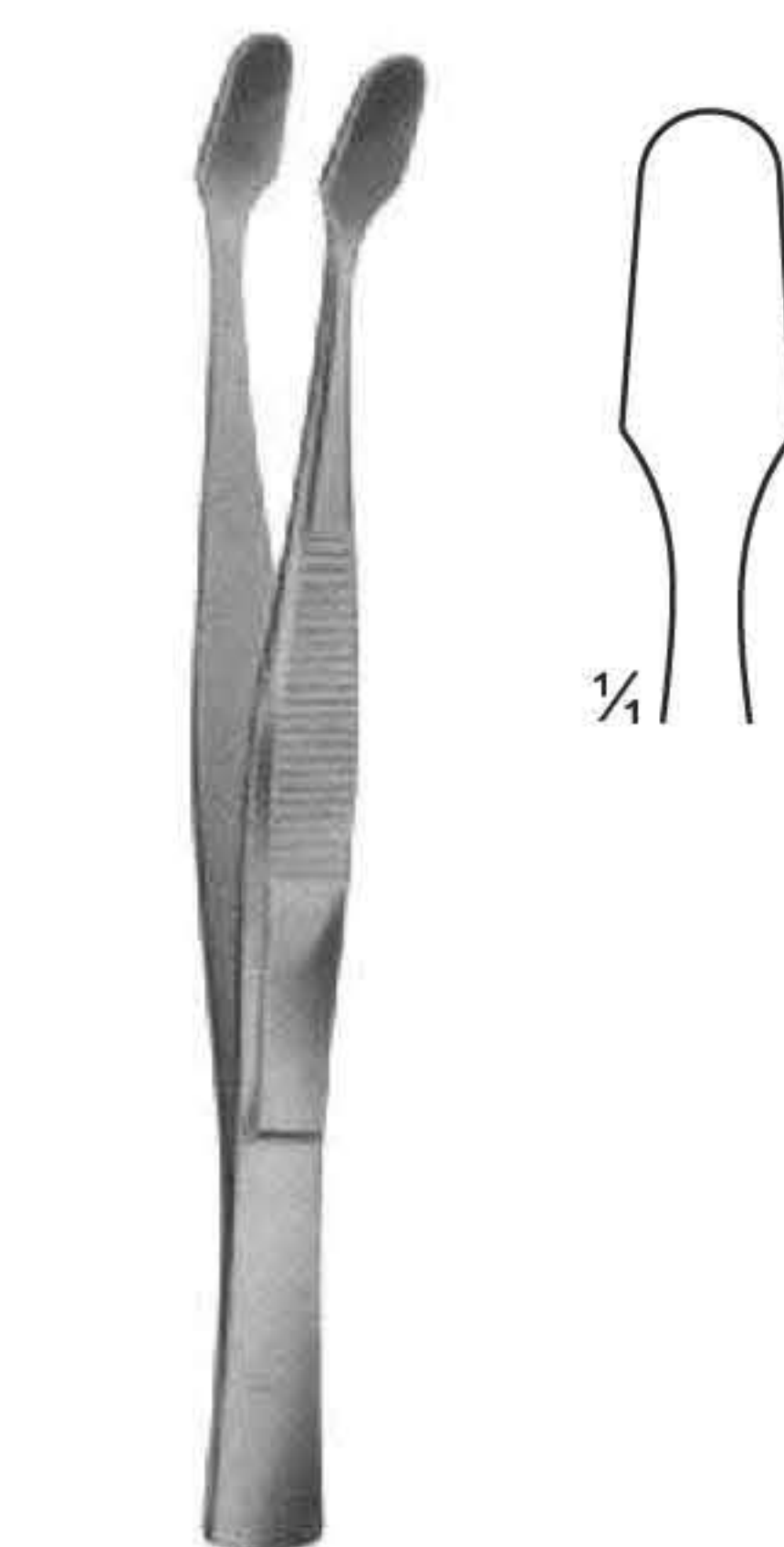

UG-135  
COVER GLASS FORCEPS  
105 mm

UG-136  
160 mm

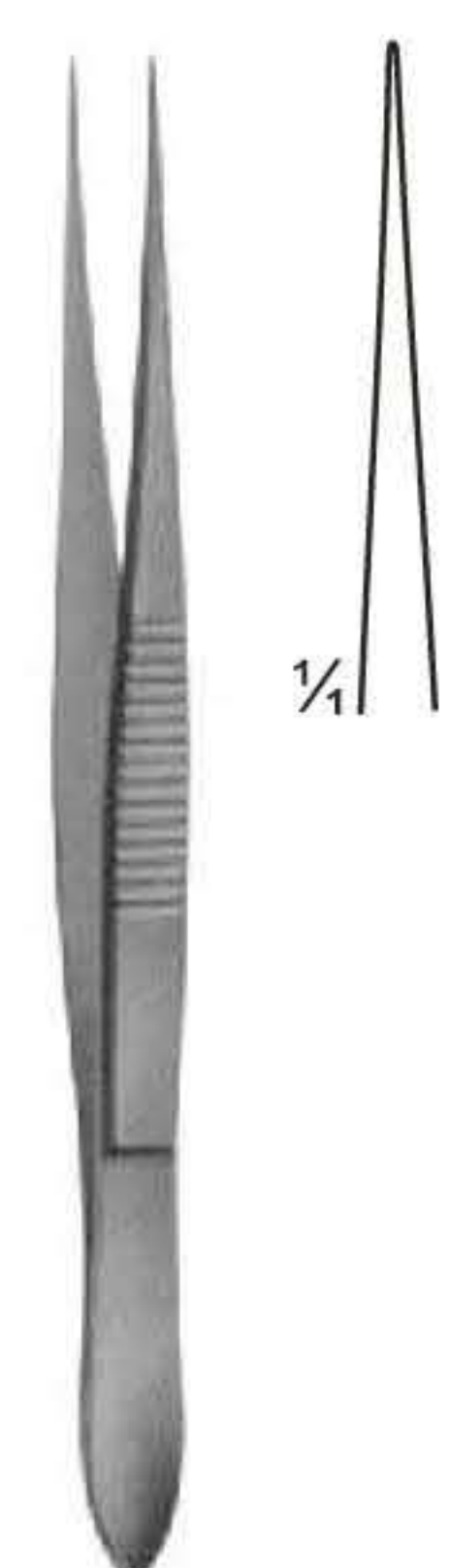

UG-130  
100 mm

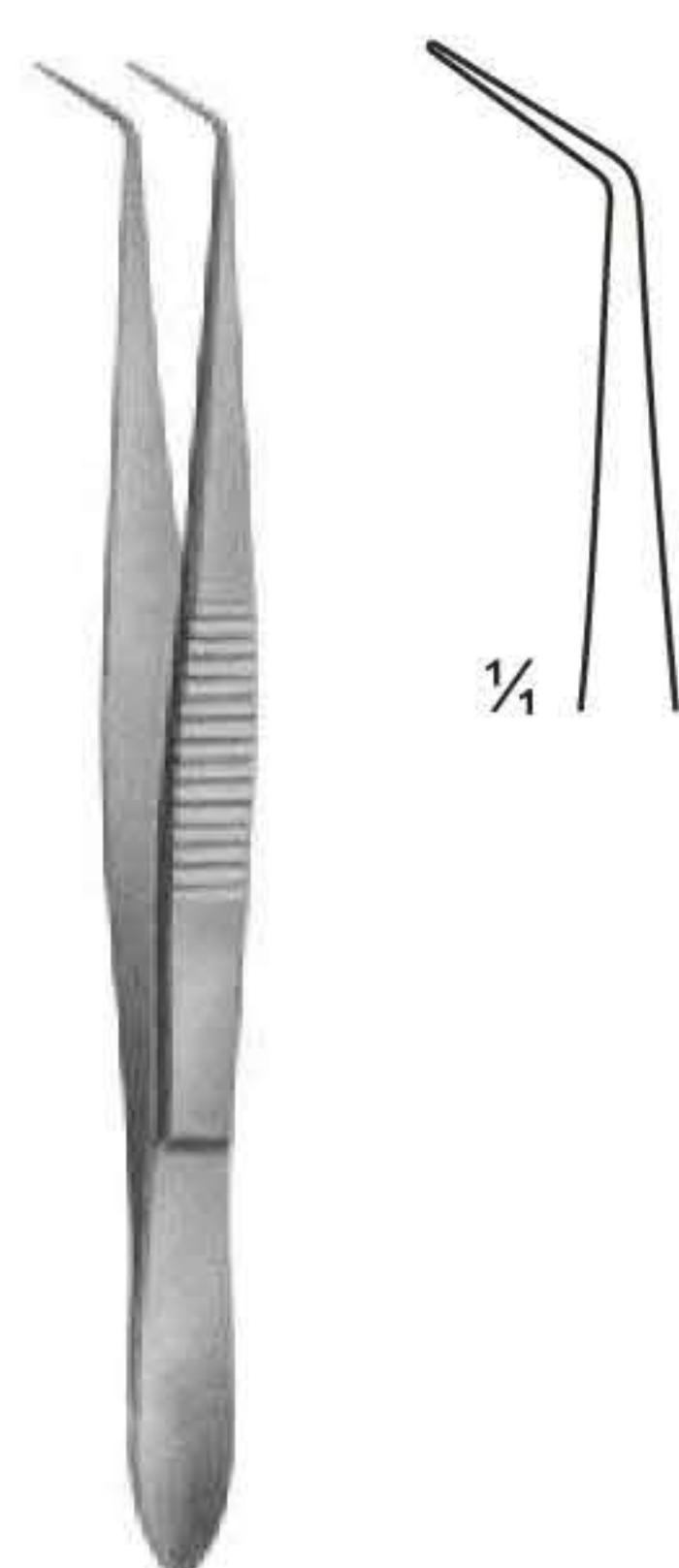

UG-131  
100 mm

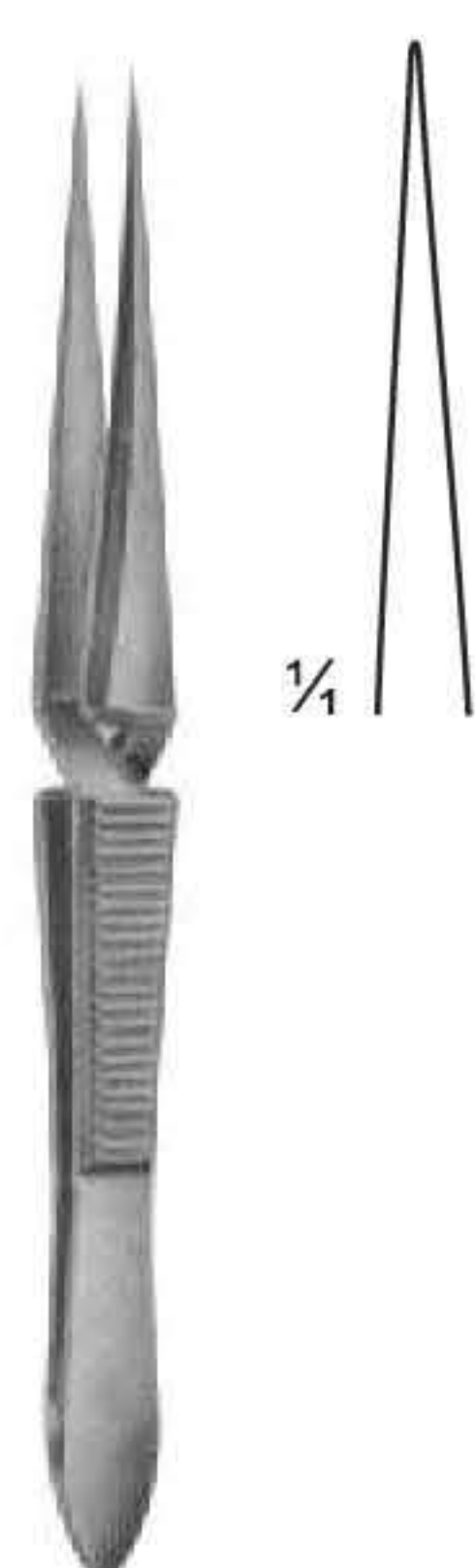

UG-132  
100 mm

# Delicate Dissecting Forceps



½  
UG-137  
SEMKEN

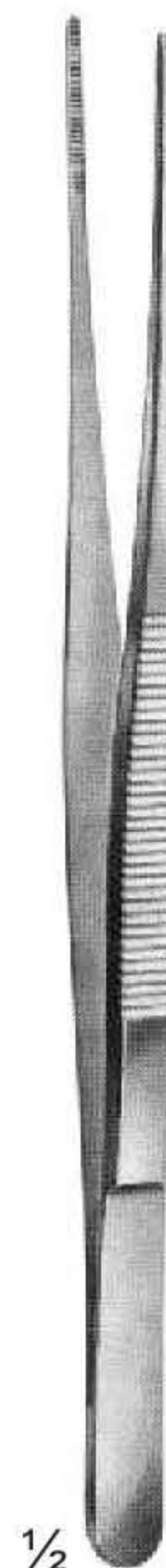

½  
UG-140



½  
UG-144  
MC INDOE

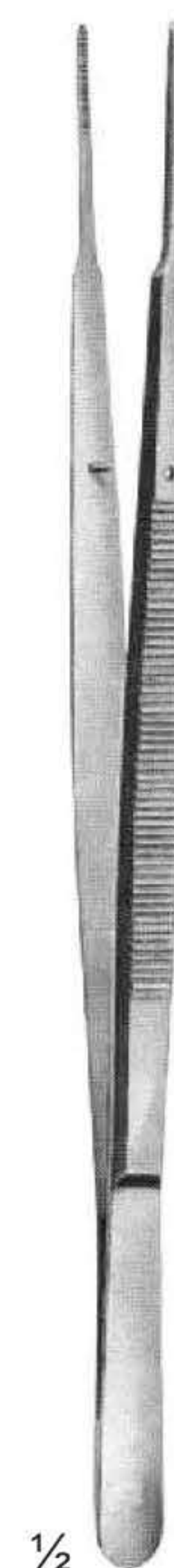

½  
UG-146  
GERALD



½  
UG-151  
CUSHING

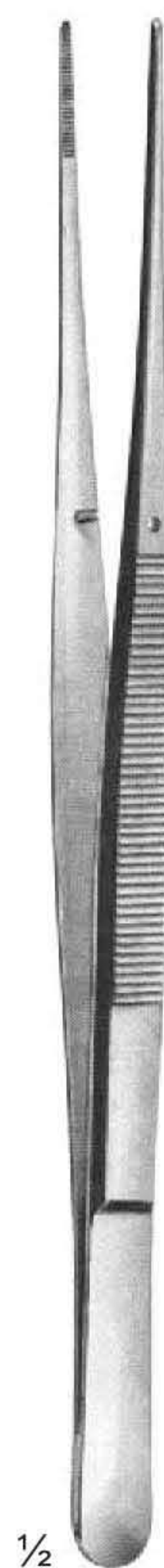

½  
UG-153  
BROPHY



½  
UG-155  
SMOOTH JAWS



½  
UG-158

# Dissecting Forceps

---



UG-162  
STANDARD



UG-167  
MEDIUM



UG-169  
MEDIUM

# Dissecting Forceps



UG-170



UG-172

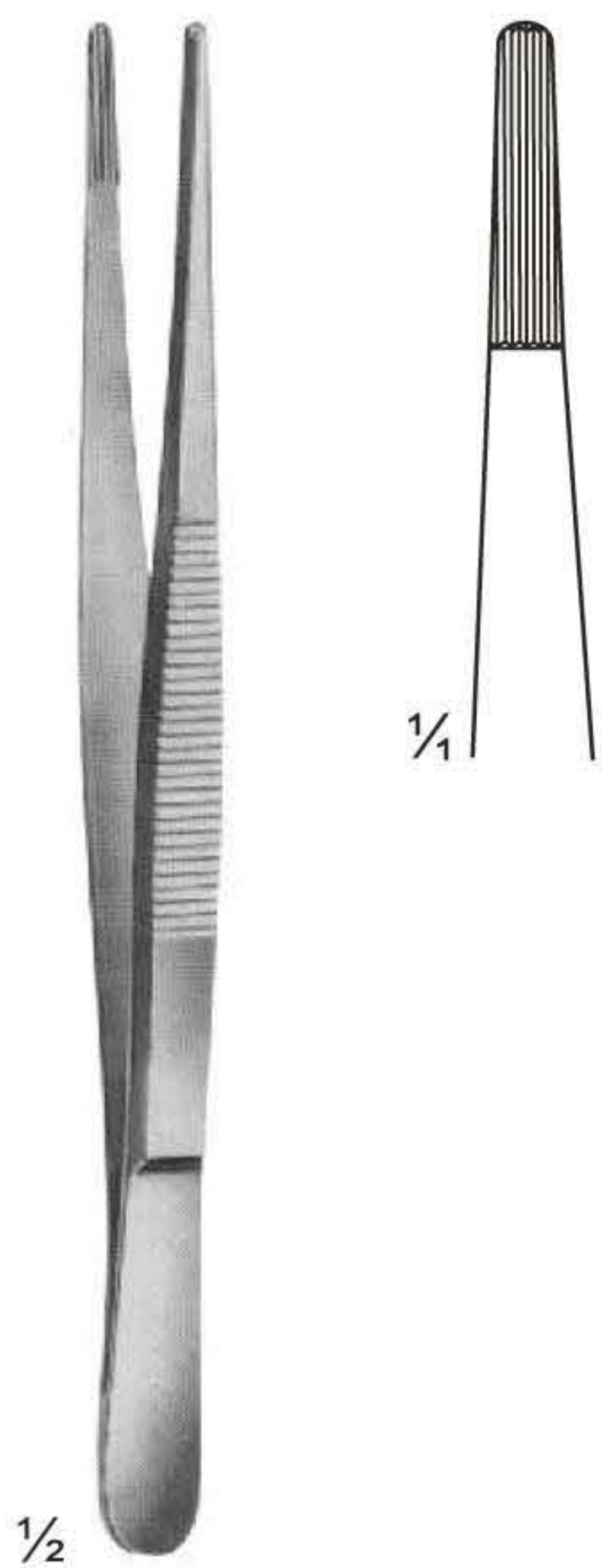

UG-174  
OCHSNER

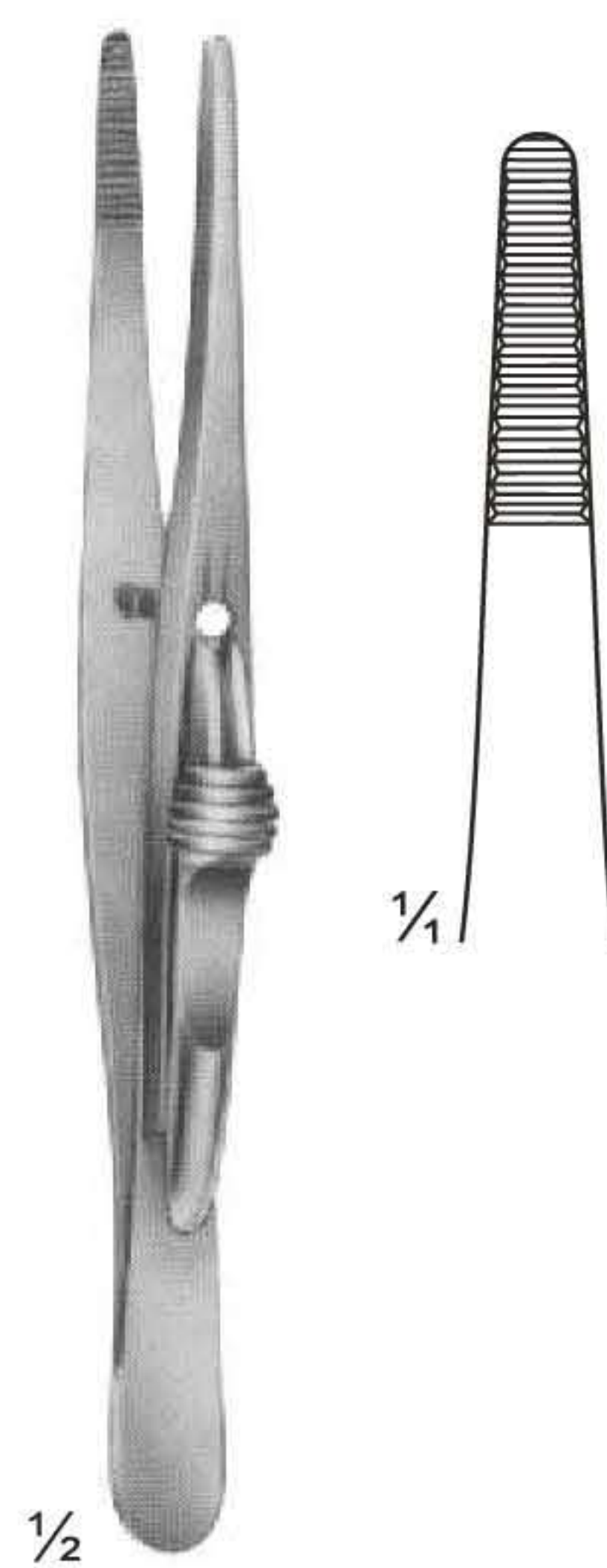

UG-177  
FRICKE

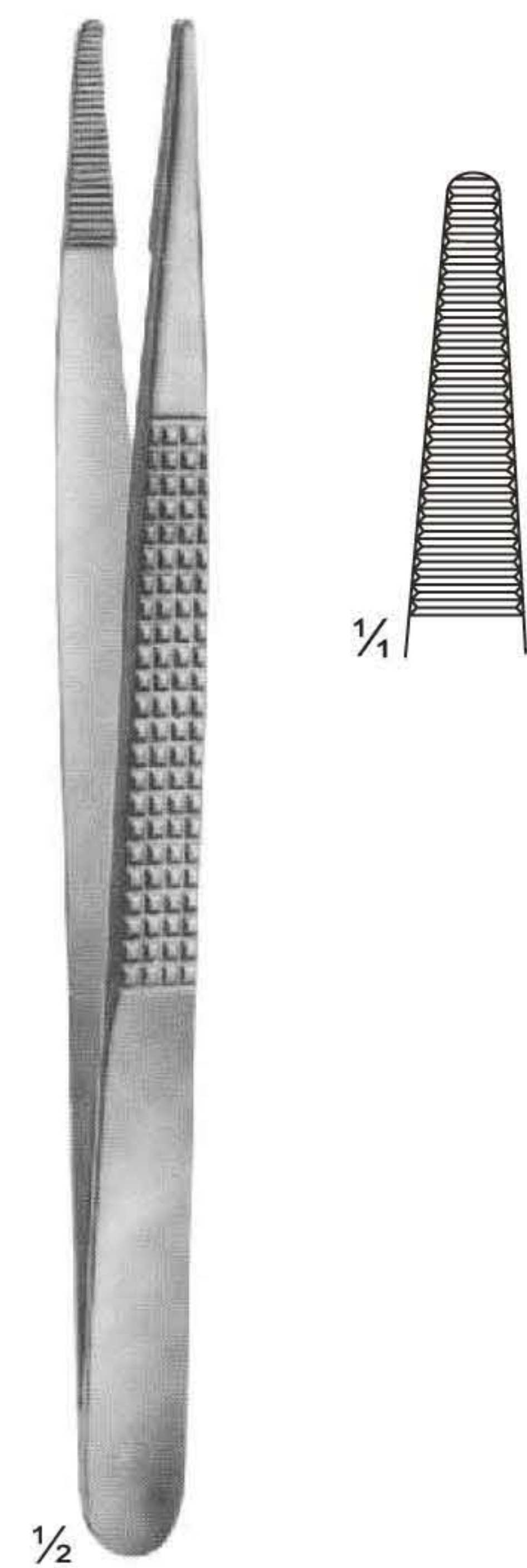

UG-178  
BONNEY

# Ultra-Light Forceps

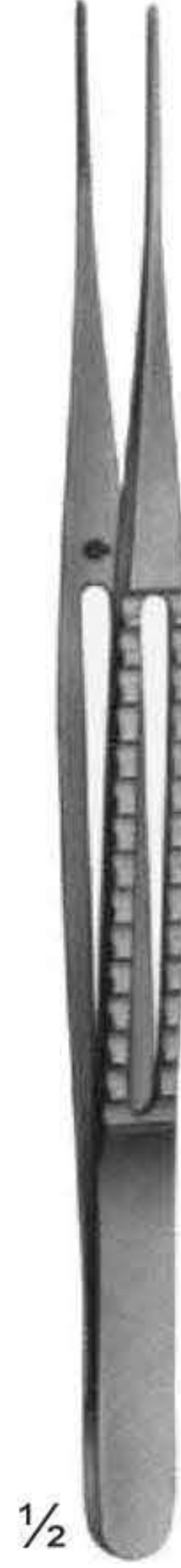

UG-180  
150 mm

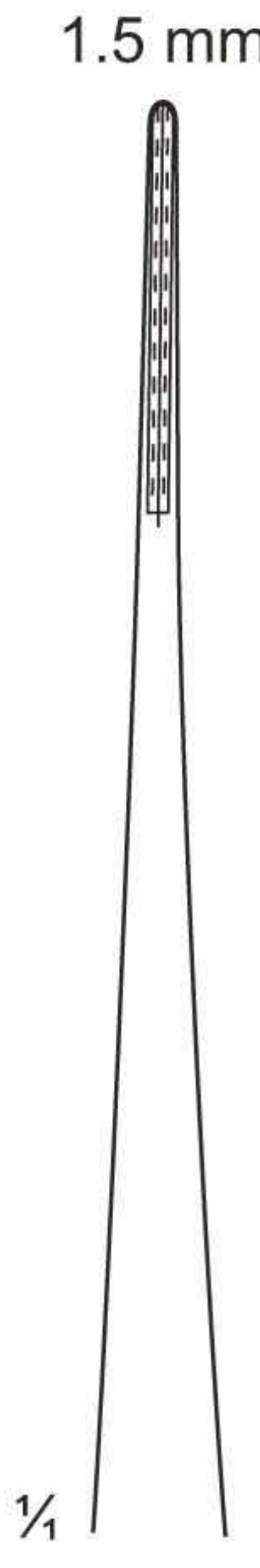

UG-181  
200 mm

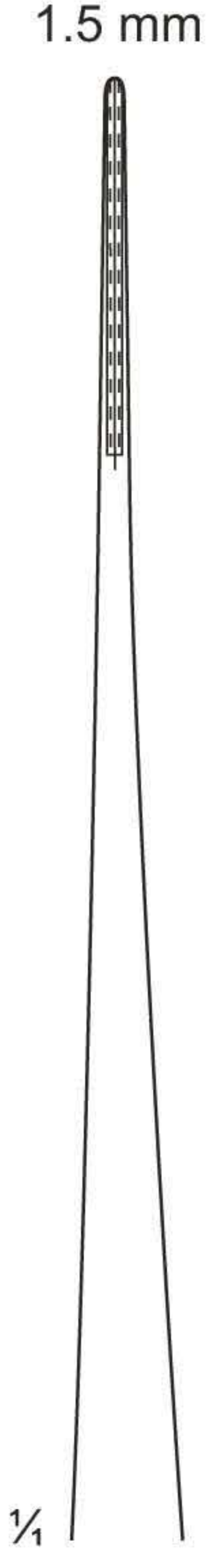
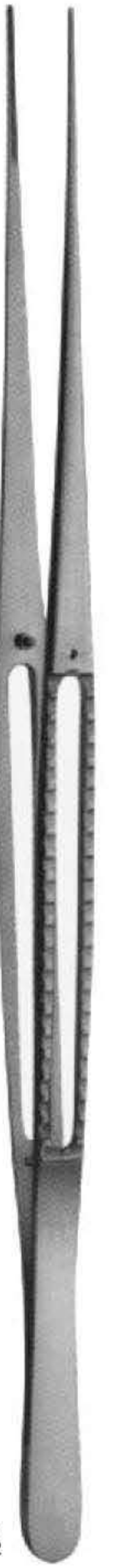

UG-183  
240 mm

# Forceps



½  
UG-187  
DE BAKEY



½  
UG-193  
DE BAKEY



½  
UG-198  
DE BAKEY

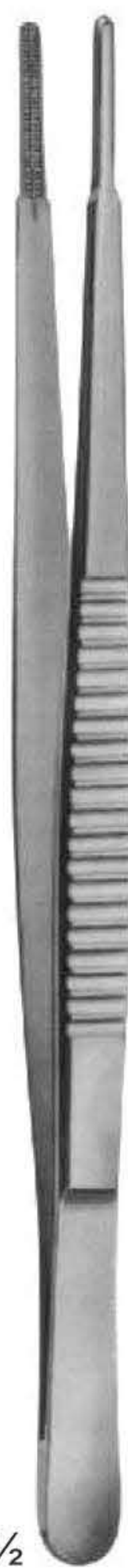

½  
UG-204  
DE BAKEY



½  
UG-208  
DE BAKEY

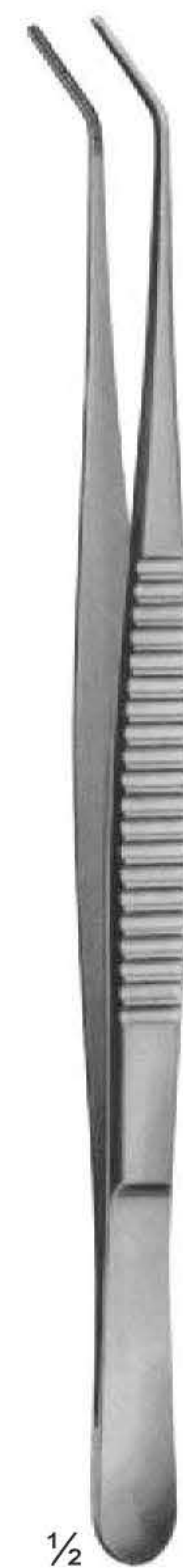

½  
UG-211  
DE BAKEY



# Forceps, Bayonet - Shaped

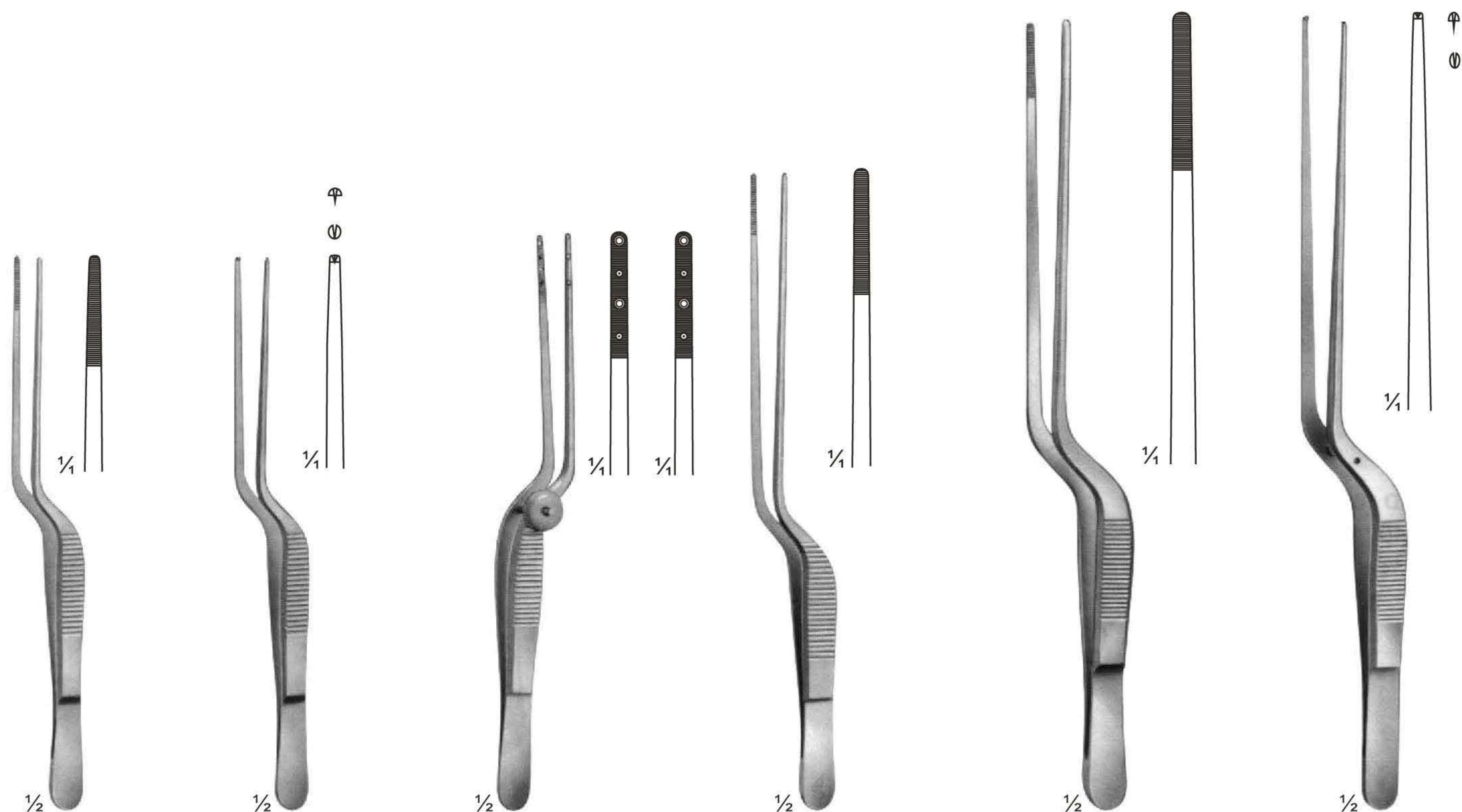

UG-214  
LUCAE  
140 mm

UG-215  
LUCAE  
1x2 teeth  
140 mm

UG-217  
COTTLE  
Forceps with  
jaws toothed  
and serrated  
140 mm

UG-220  
JANSEN  
160 mm

UG-222  
GRUENWALD  
200 mm

UG-225  
1x2 teeth  
200 mm

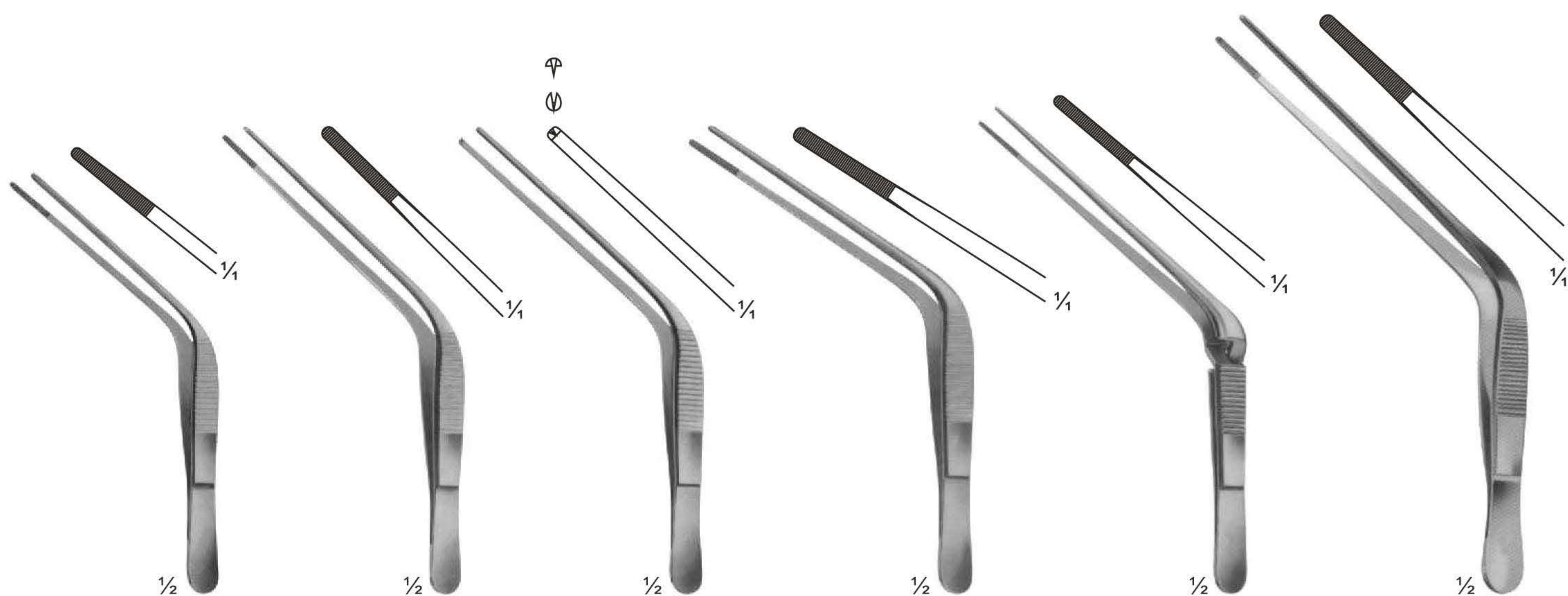

UG-227  
TROELTSCH  
100 mm

UG-231  
TROELTSCH  
115 mm

UG-233  
TROELTSCH  
1X2 teeth  
115 mm

UG-234  
WILDE  
115 mm

UG-236  
TROELTSCH  
Cross action  
120 mm

UG-237  
TROELTSCH  
140 mm

# Delicate Tissue Forceps

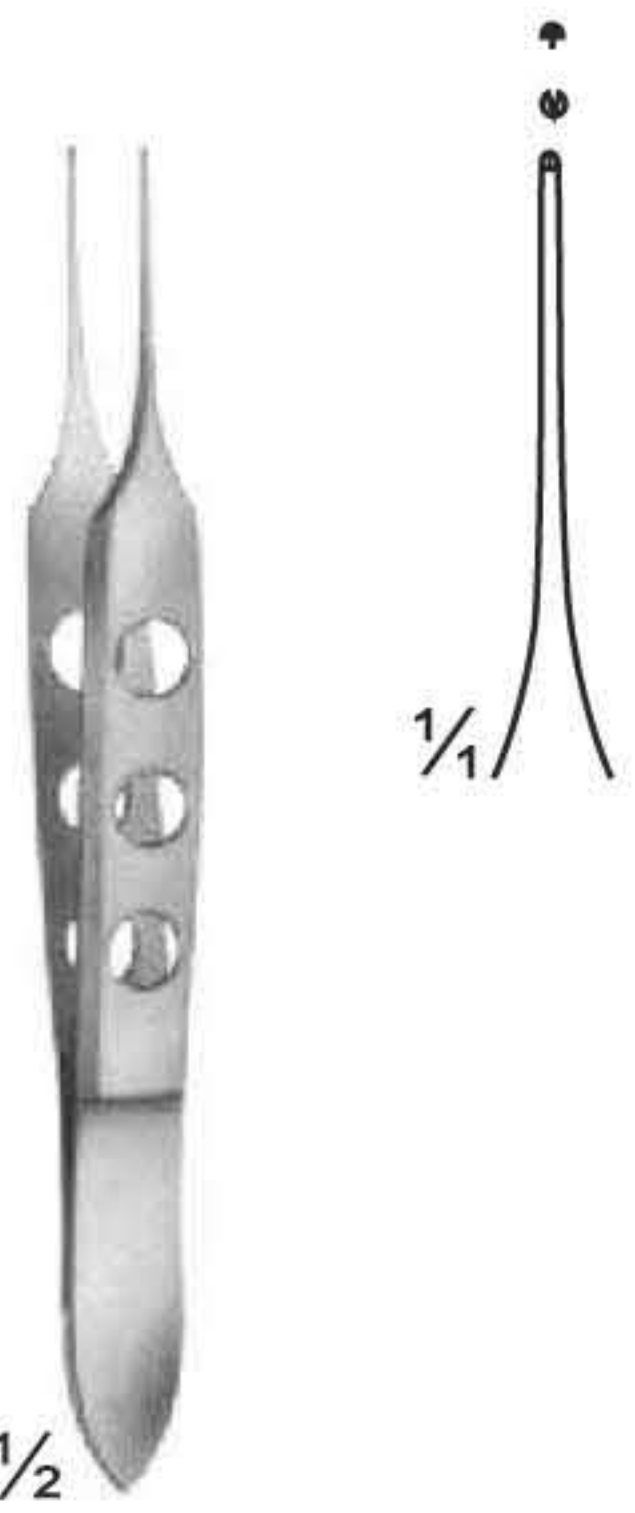

UG-238  
BISHOP-HARMON  
85 mm

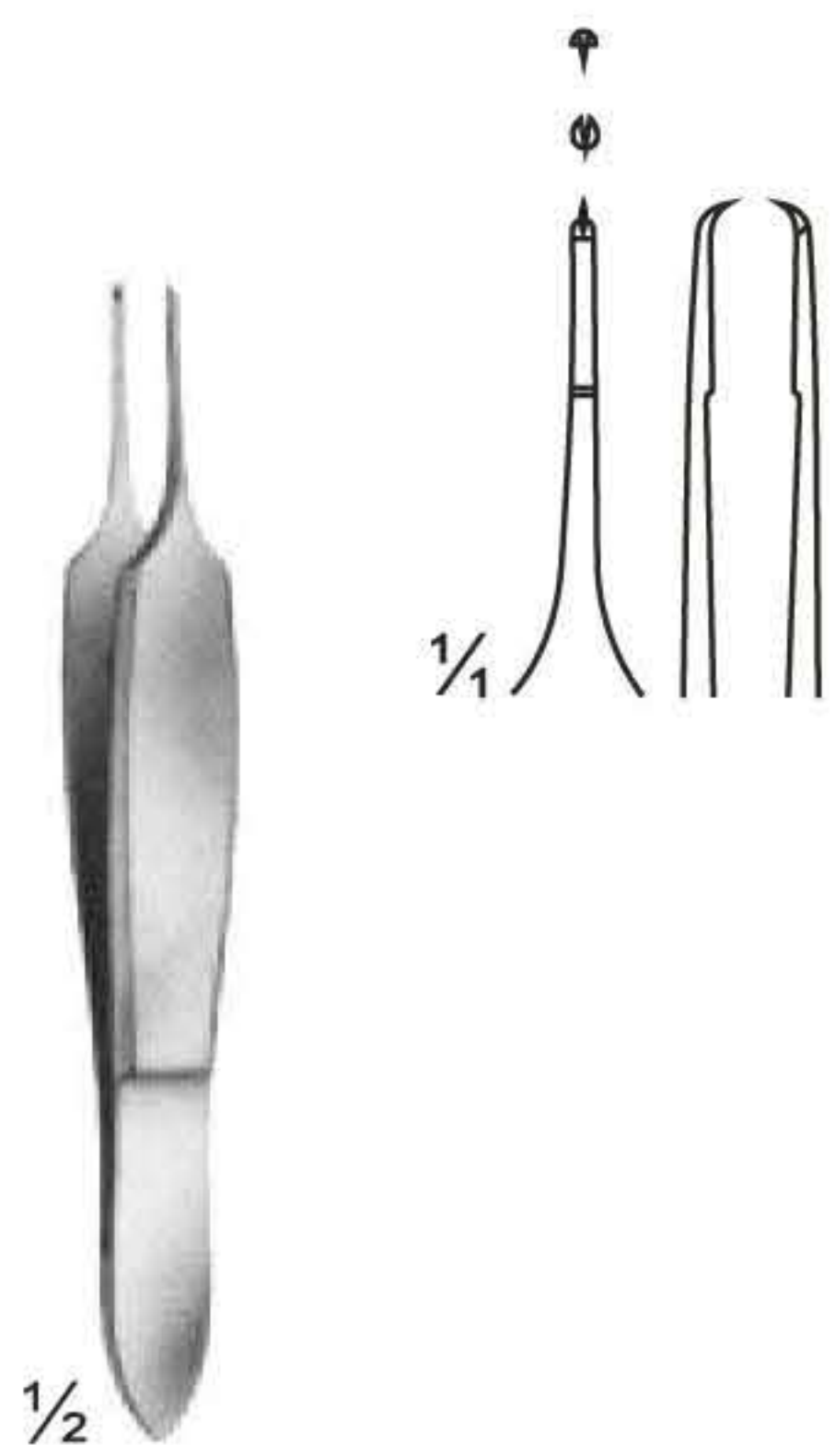

UG-239  
ST. MARTIN  
80 mm

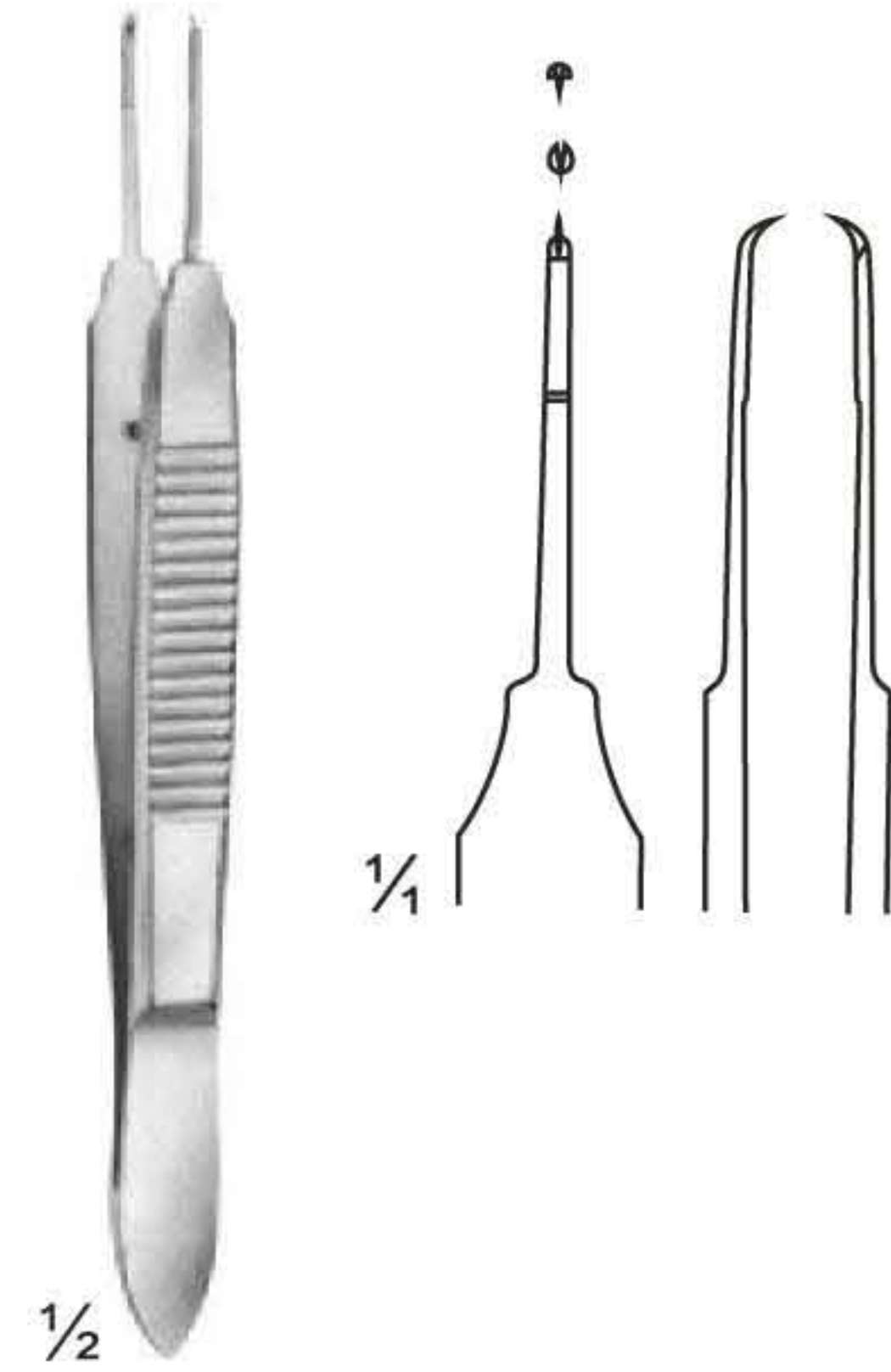

UG-240  
CASTROVIEJO  
teeth 0.9 mm  
100 mm

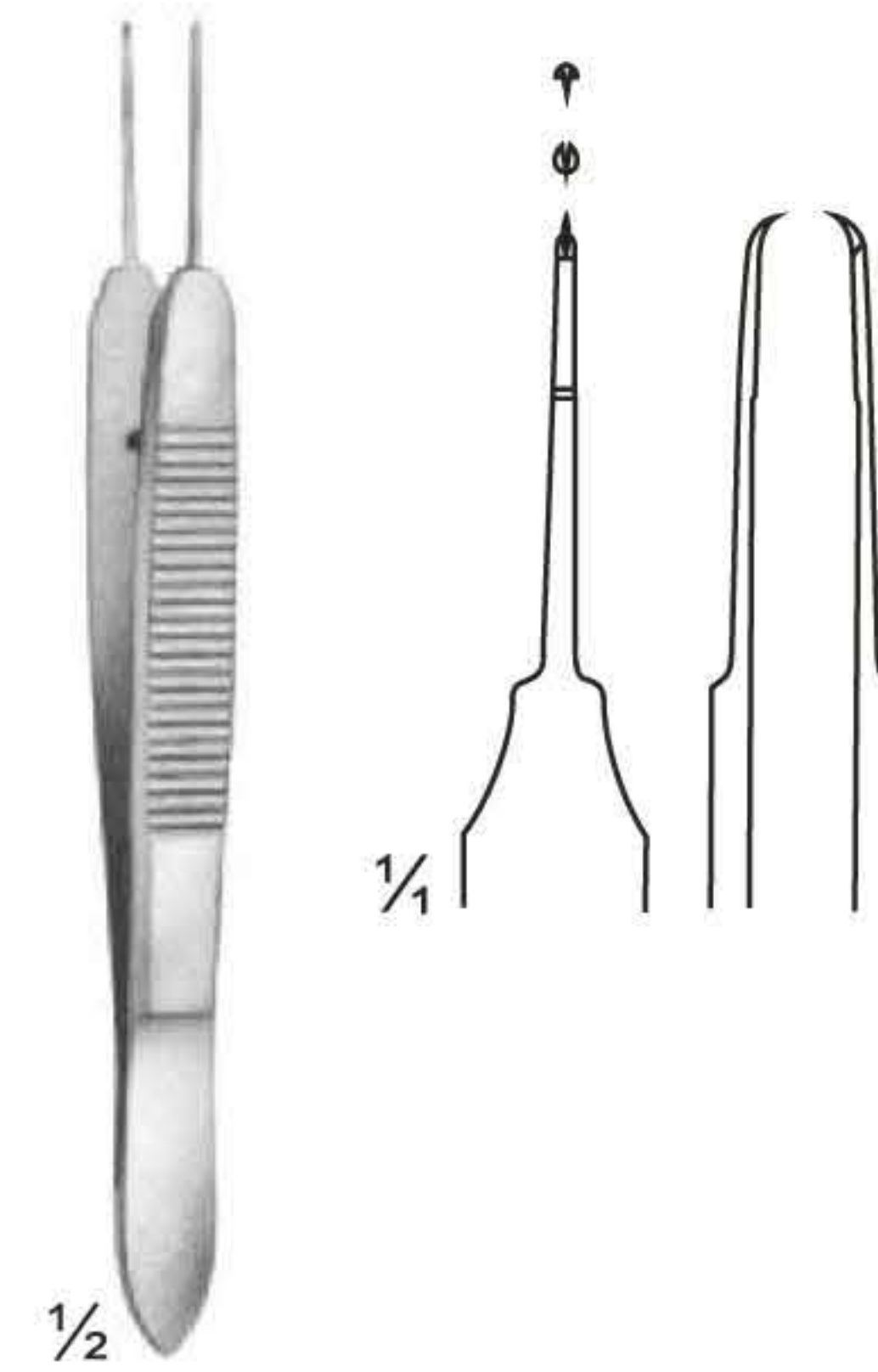

UG-241  
CASTROVIEJO  
teeth 0.5 mm  
100 mm

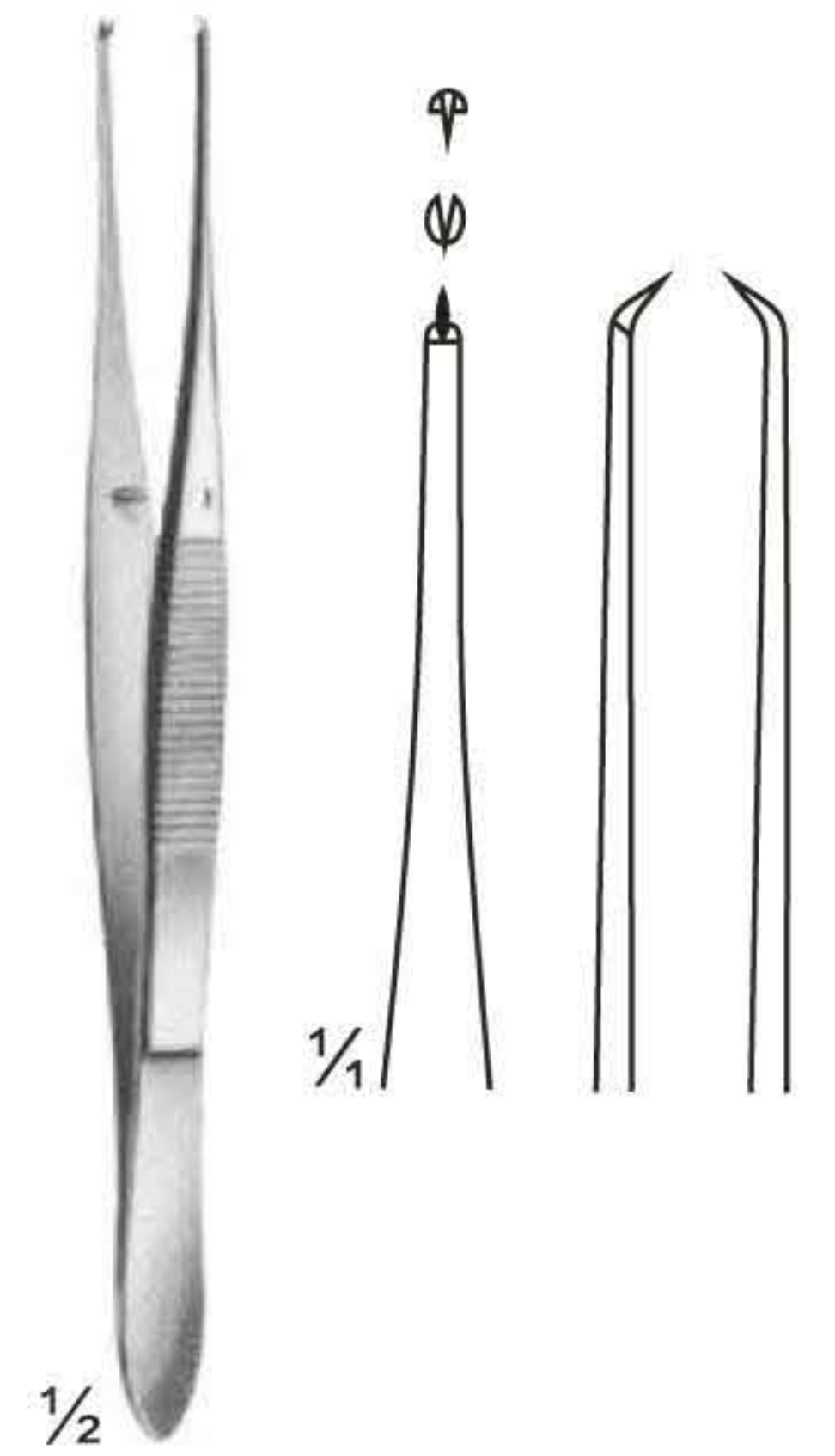

UG-247  
ELSCHING  
110 mm

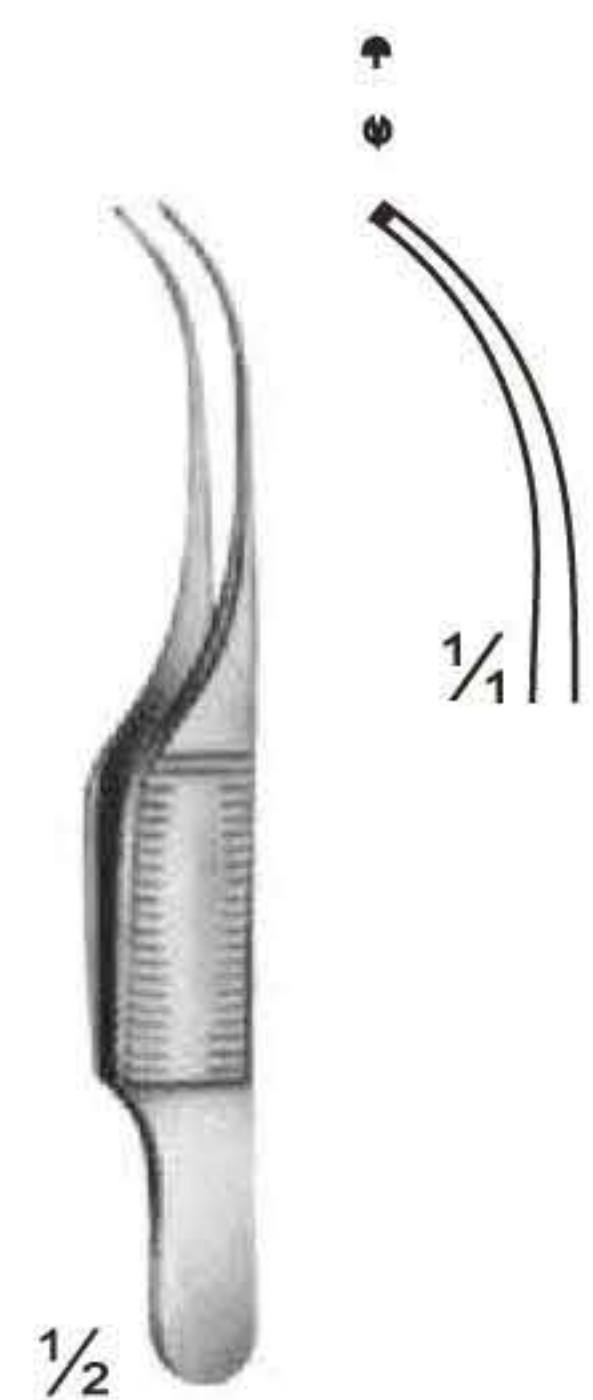

UG-248  
GILL  
75 mm

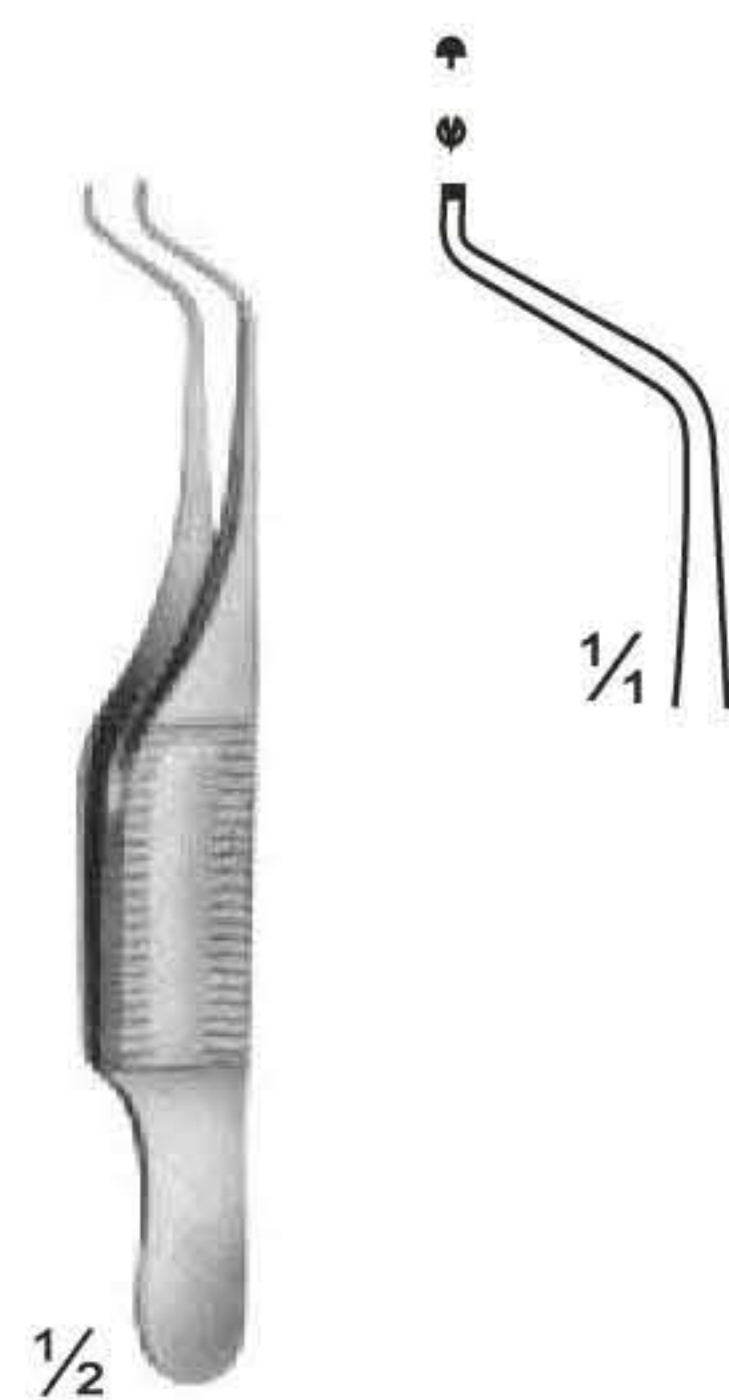

UG-249  
GILL - HESS  
75 mm

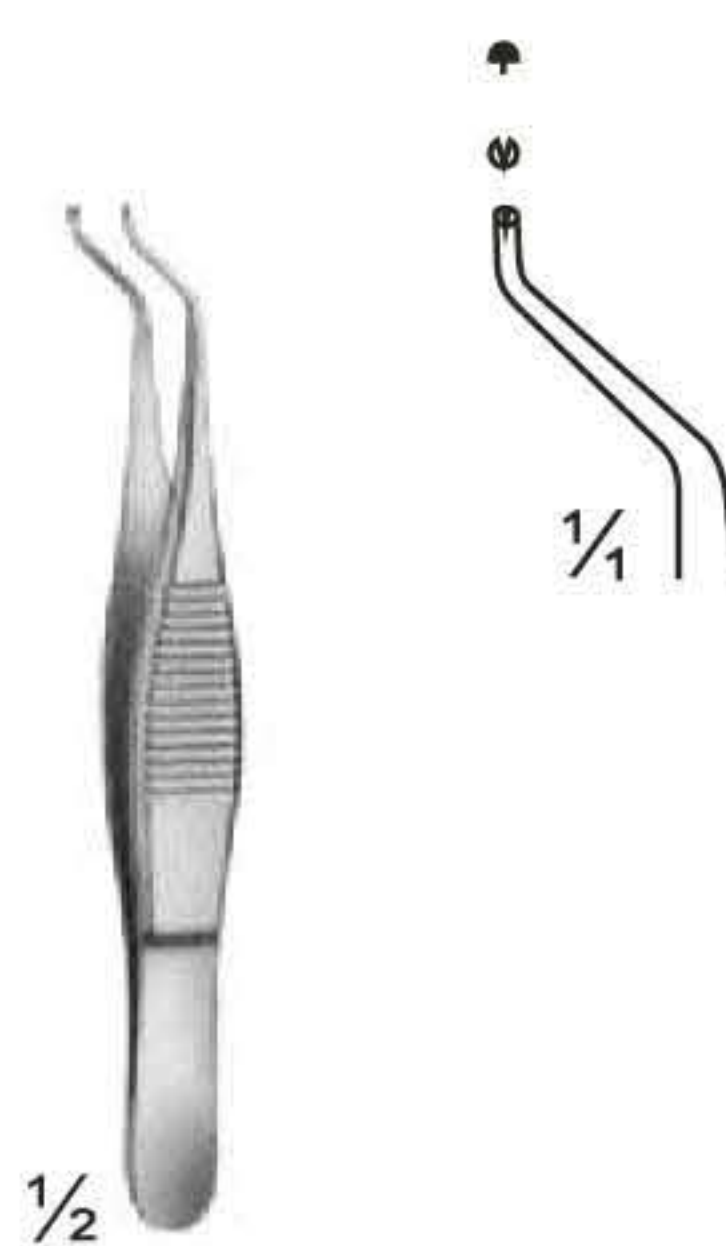

UG-249  
HESS  
70 mm

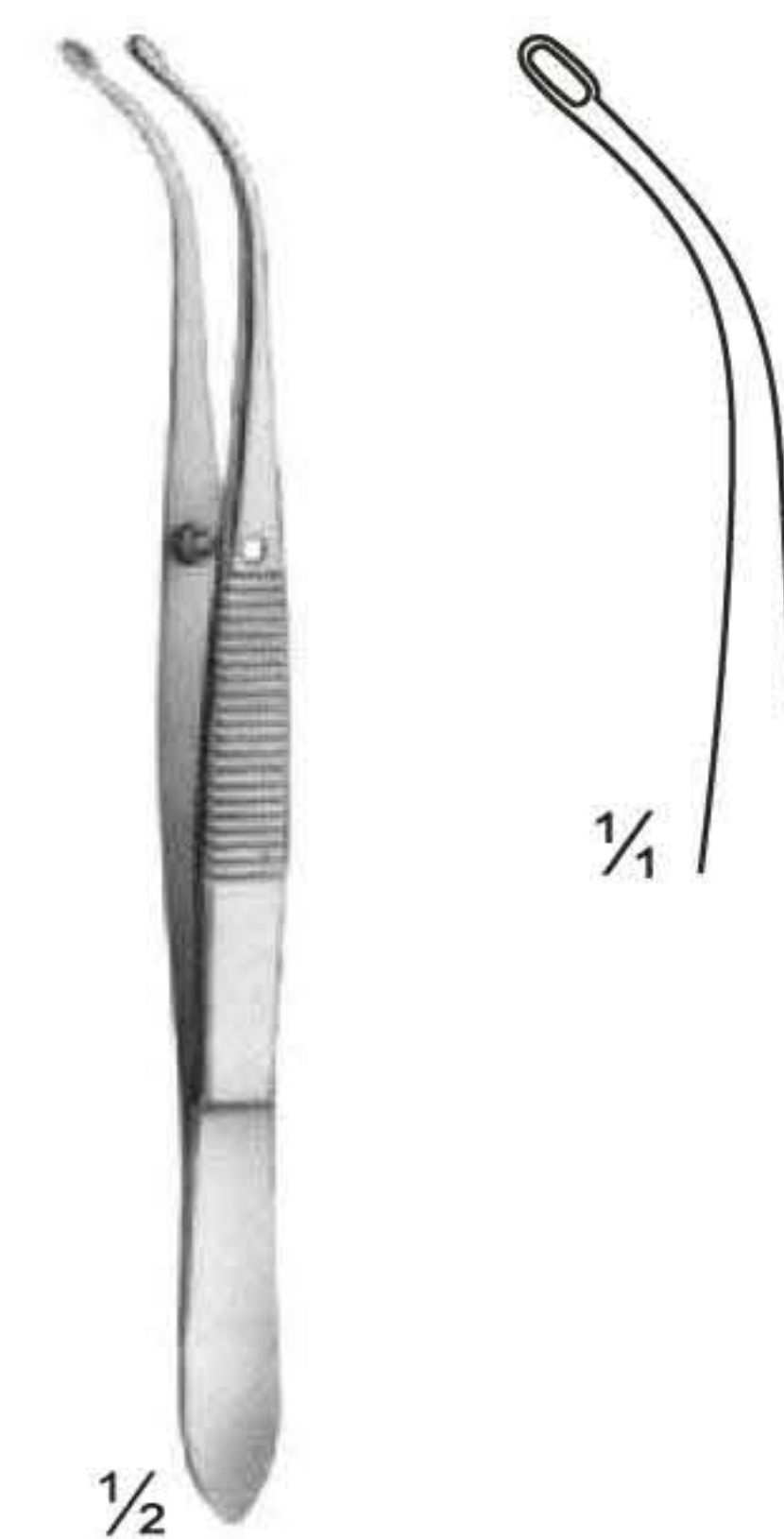

UG-250  
ARRUGA  
100 mm

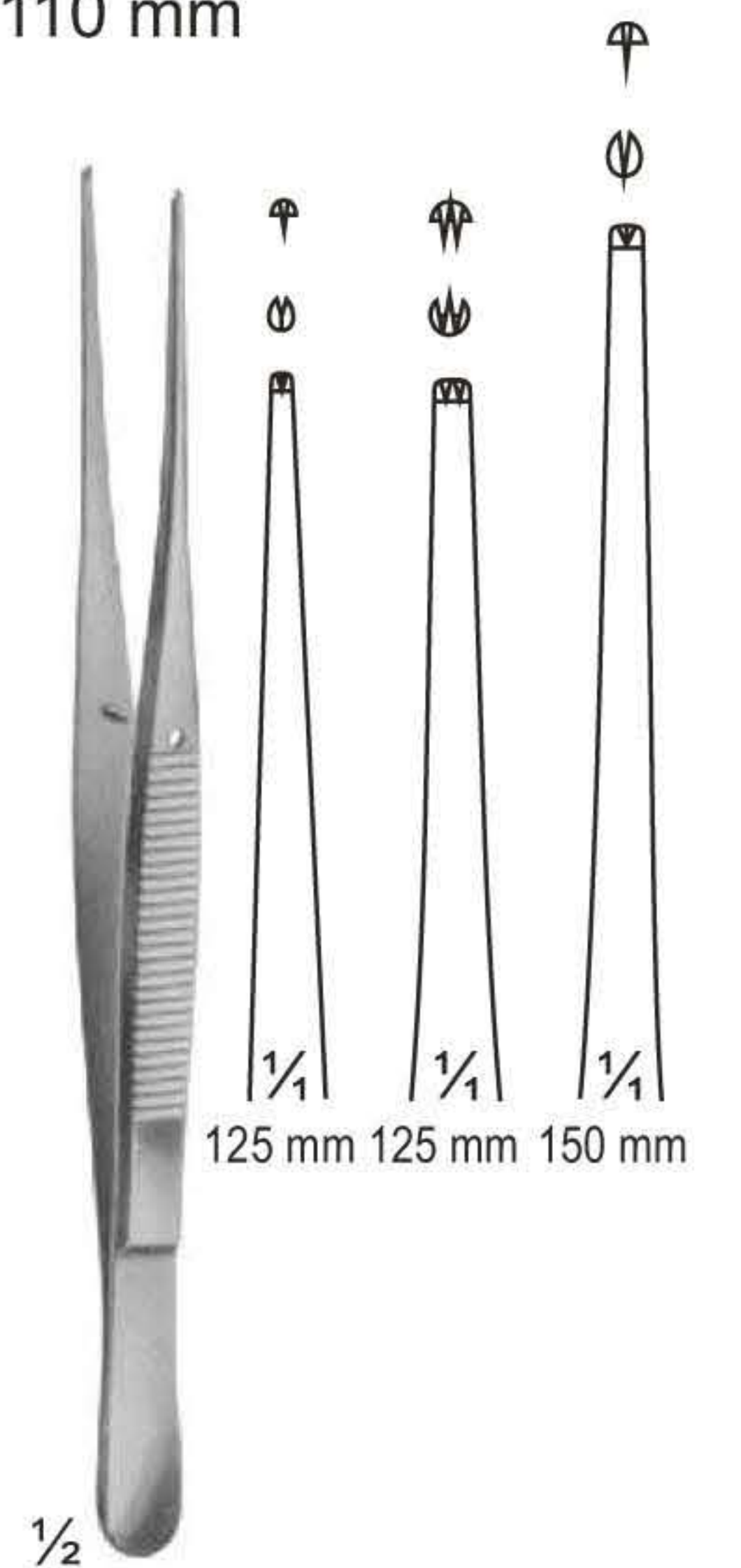

UG-251  
SEMKEN  
125 mm 125 mm 150 mm

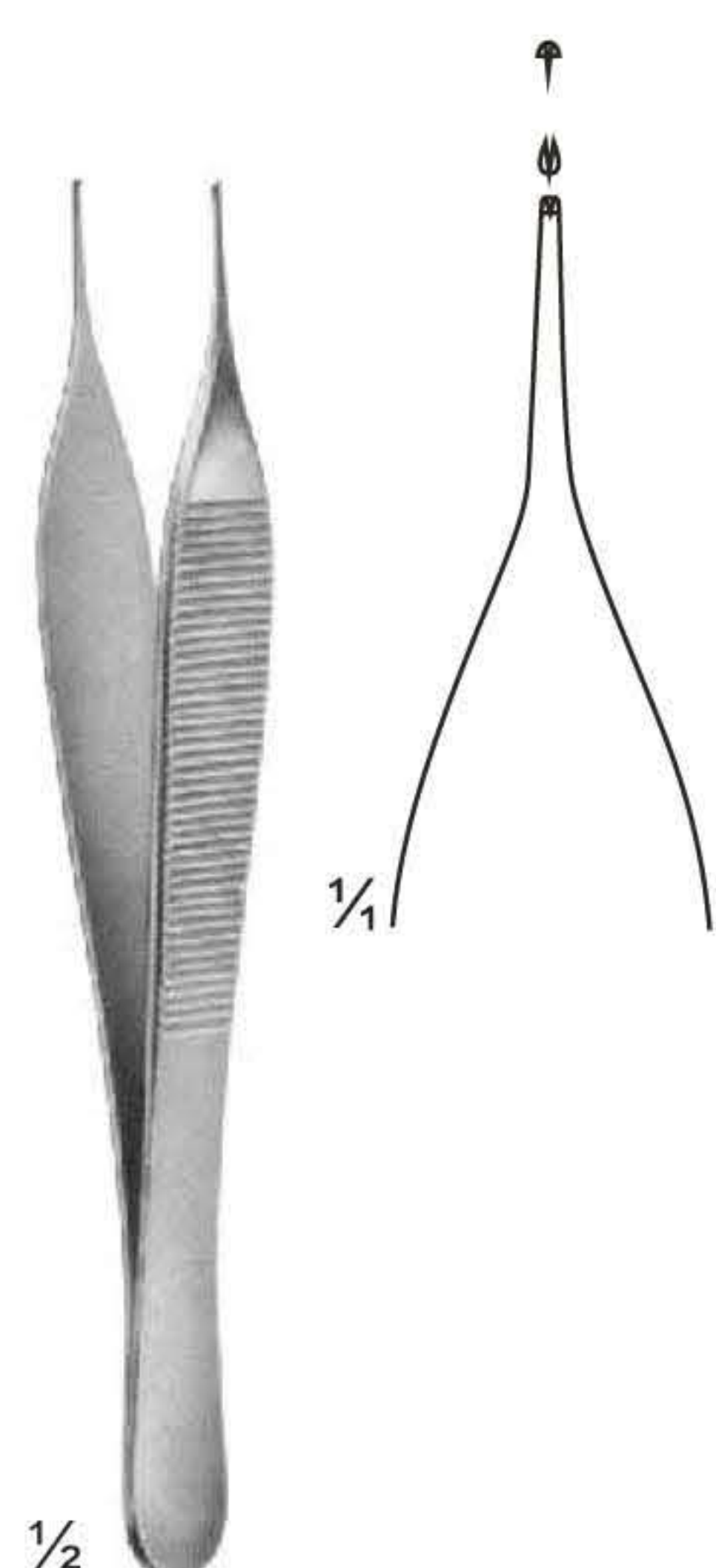

UG-252  
MICRO-ADSON  
120 mm

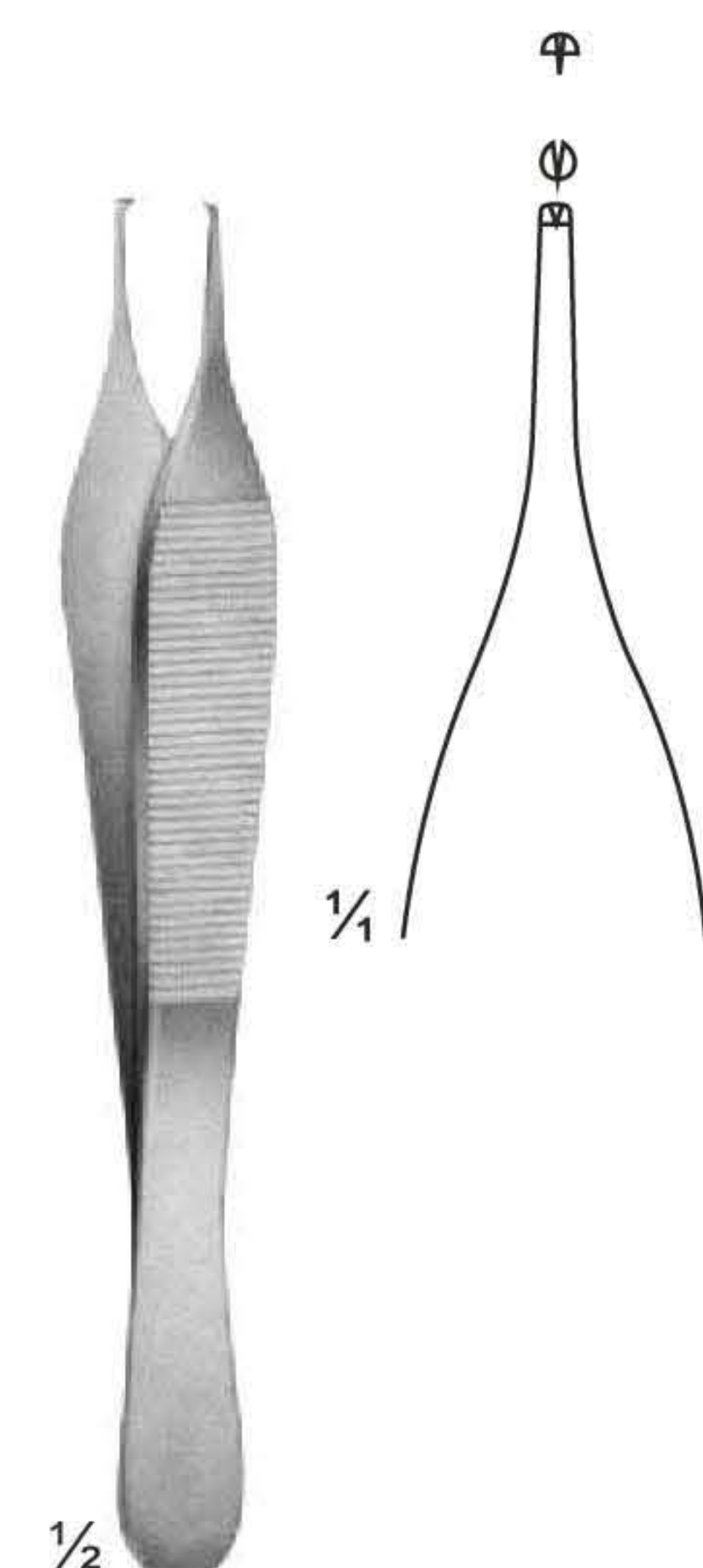

UG-253  
ADSON  
120 mm

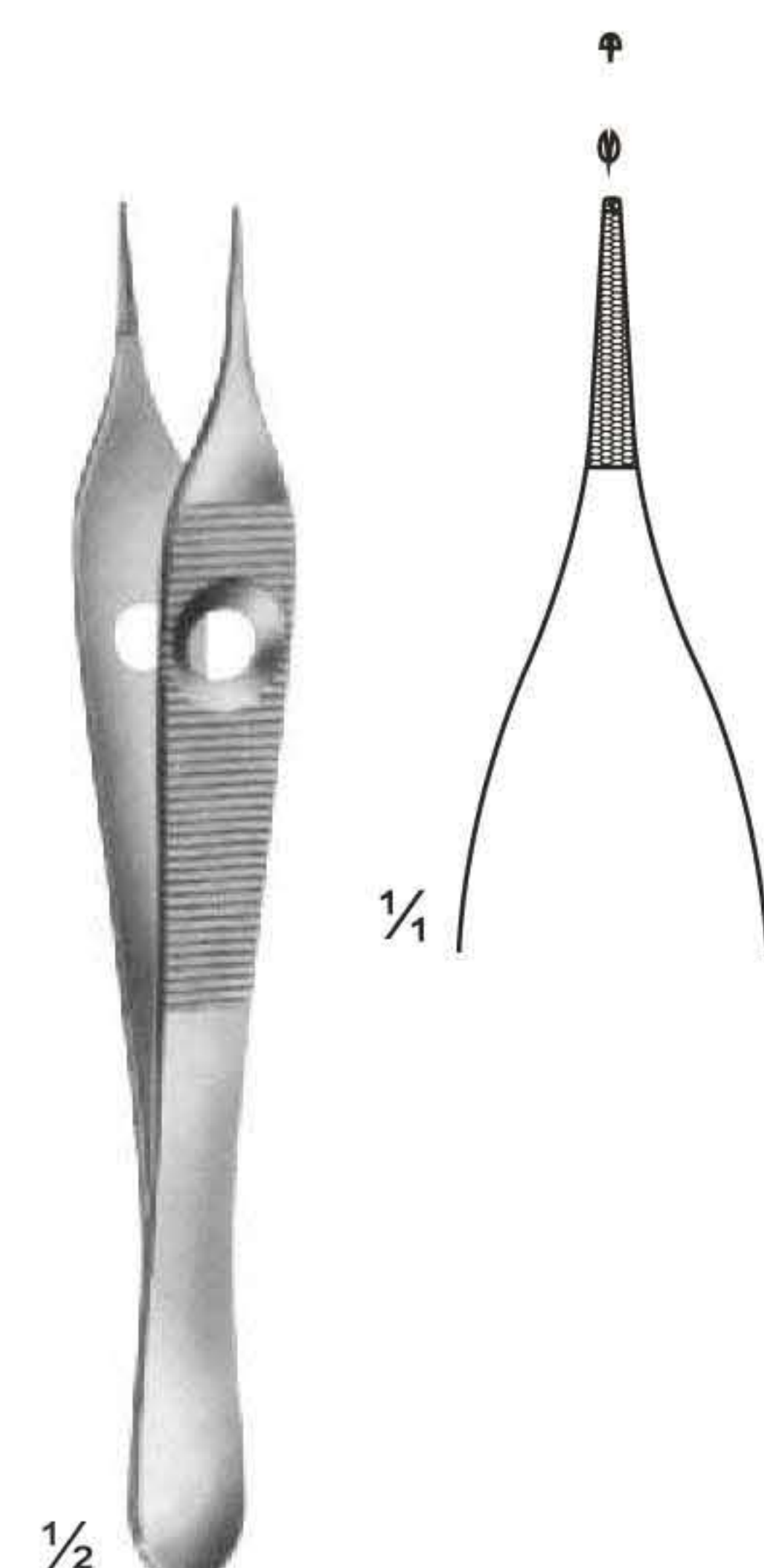

UG-254  
ADSON  
120 mm



UG-255  
ADSON  
120 mm

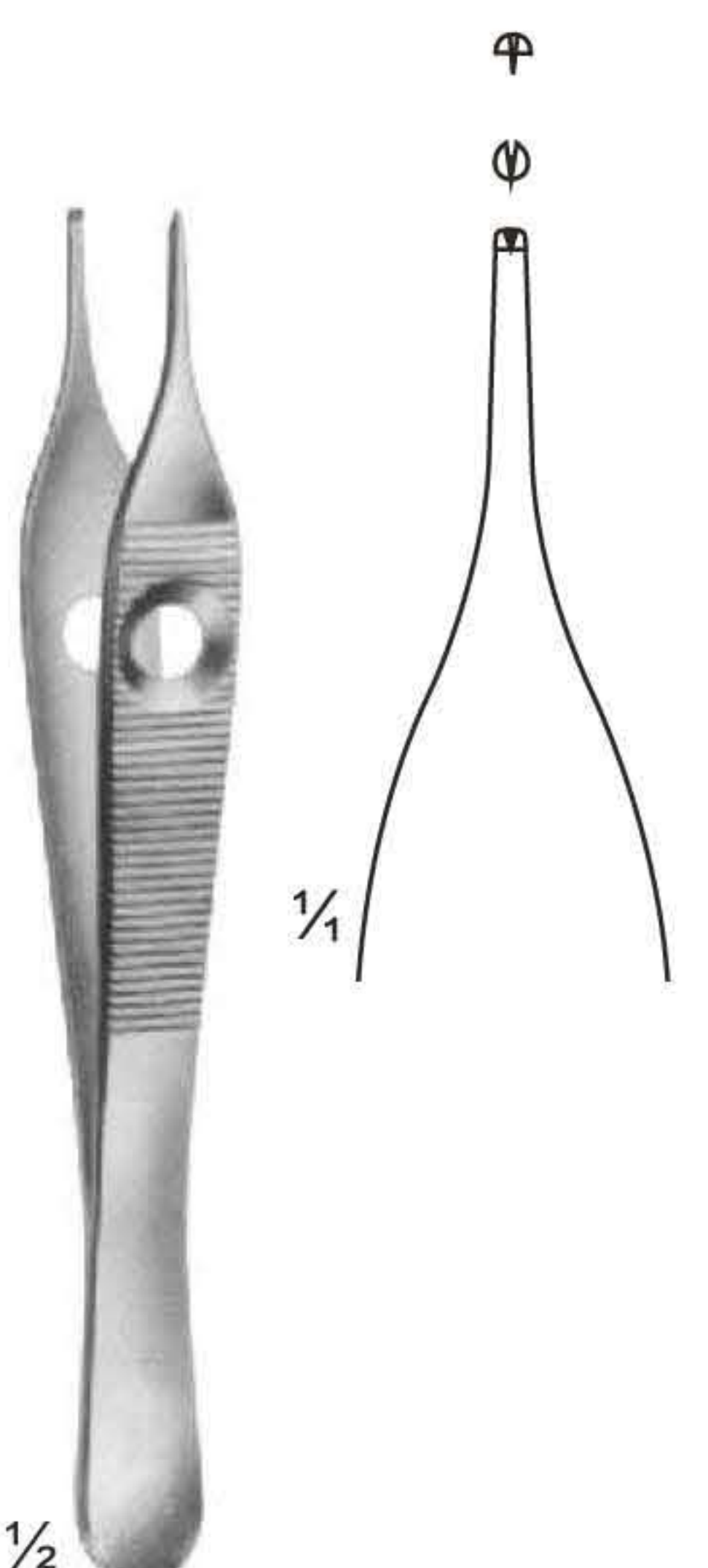

UG-256  
ADSON  
150 mm

# Tissue Forceps

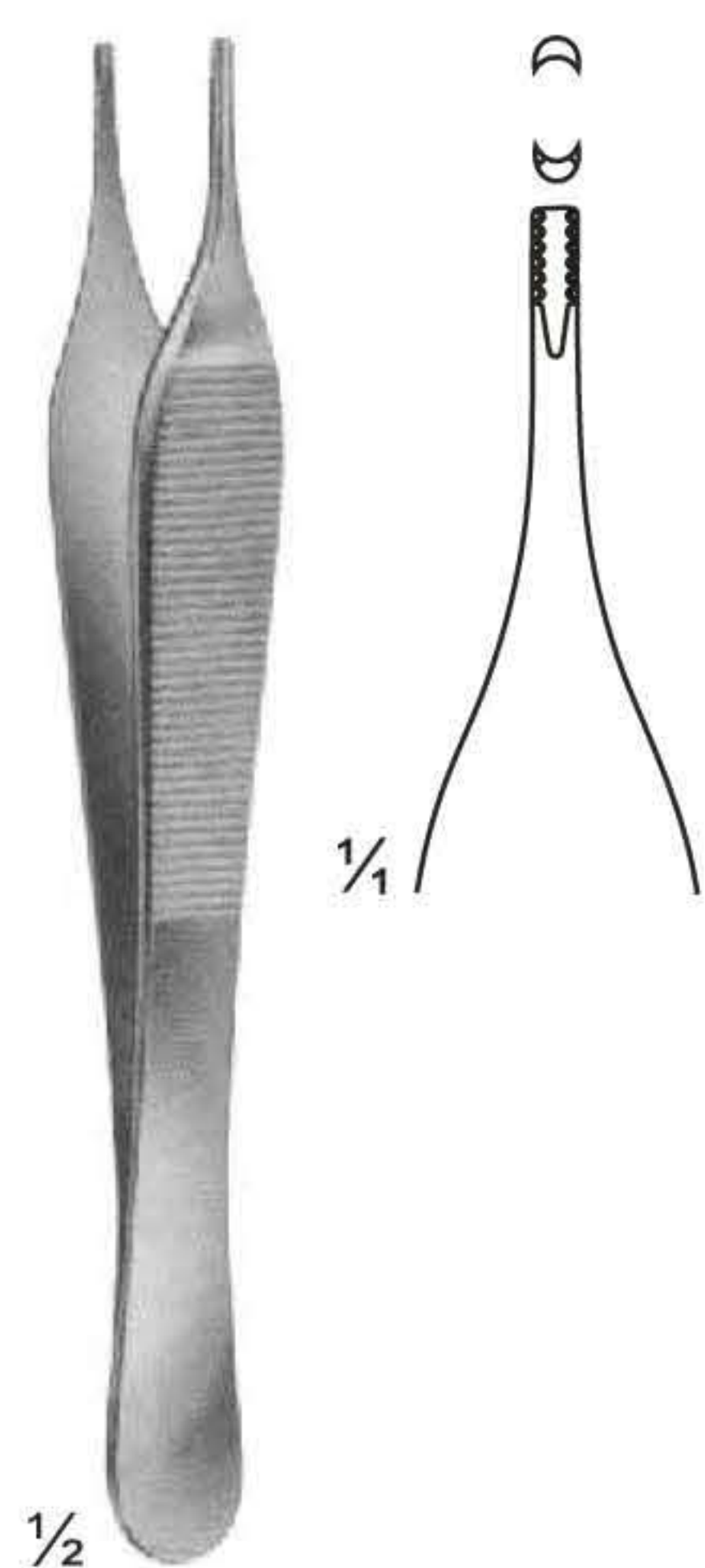

UG-257  
**ADSON - BROWN**  
Non-traumatic  
120 mm

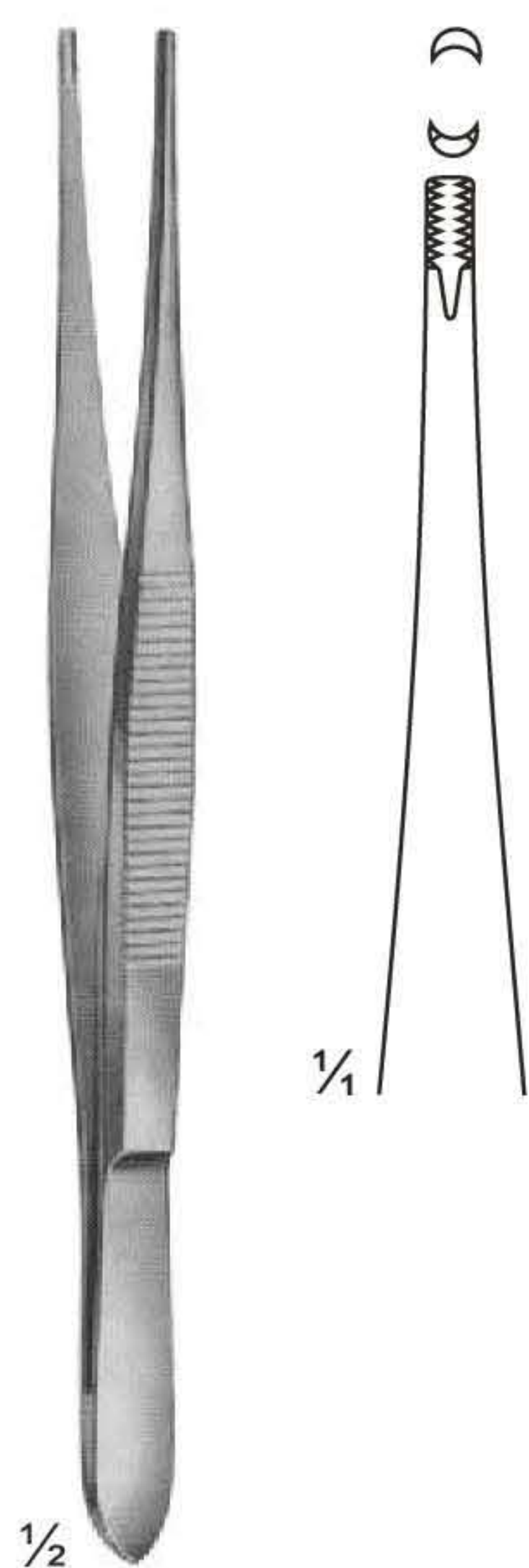

UG-258  
**BROWN**  
120 mm

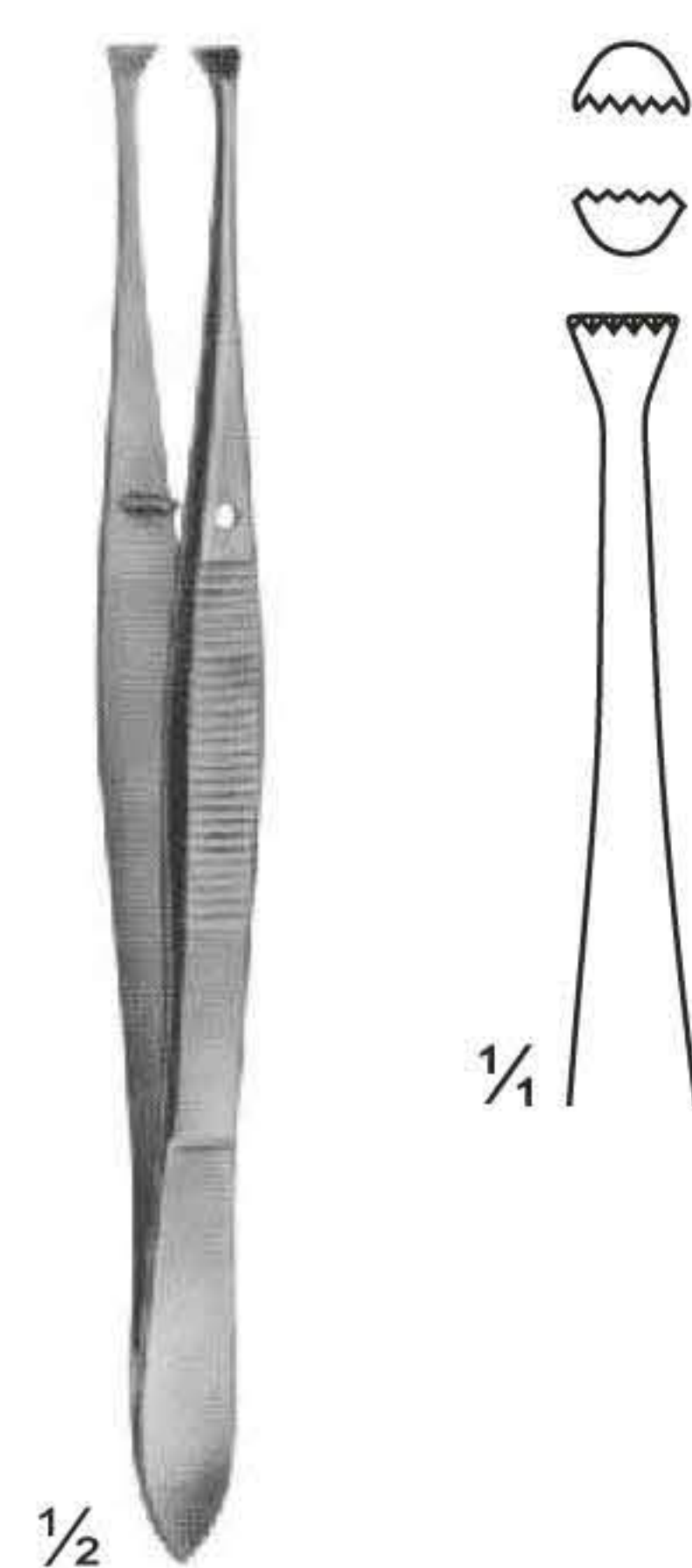

UG-259  
**GRAEFE**  
110 mm

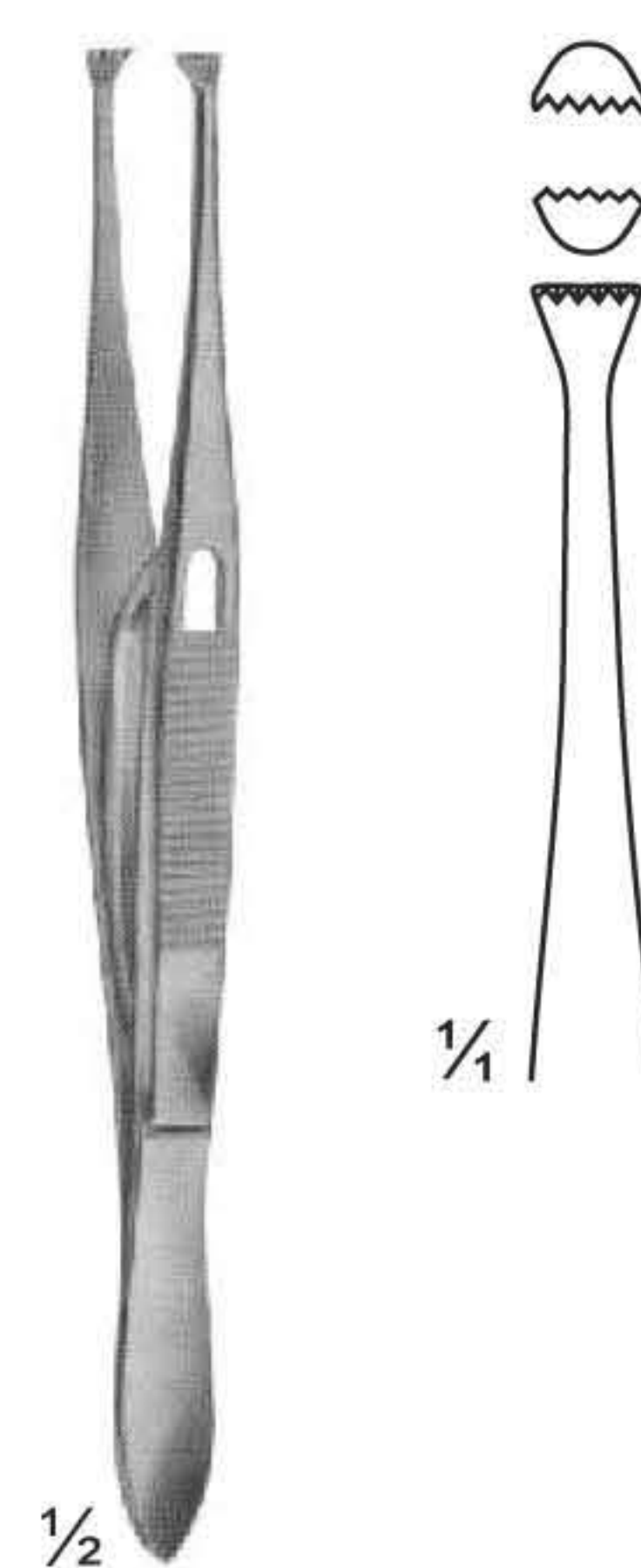

UG-260  
**GRAEFE**  
With Catch  
110 mm



UG-262  
**STANDARD**



UG-266  
**GRAEFE**  
110 mm

# Tissue Forceps



1/2  
UG-270  
3x4 teeth



1/2  
UG-272  
MC INDOE



1/2  
UG-274  
GILLIES



1/2  
UG-276  
GERALD



1/2  
UG-278  
WAUGH



1/2  
UG-281  
BROPHY

# Tissue Forceps, Lung Dissecting Forceps



1/2  
UG-285  
**LANE**



1/2  
UG-294  
**STRASSBURGER  
MODELL**

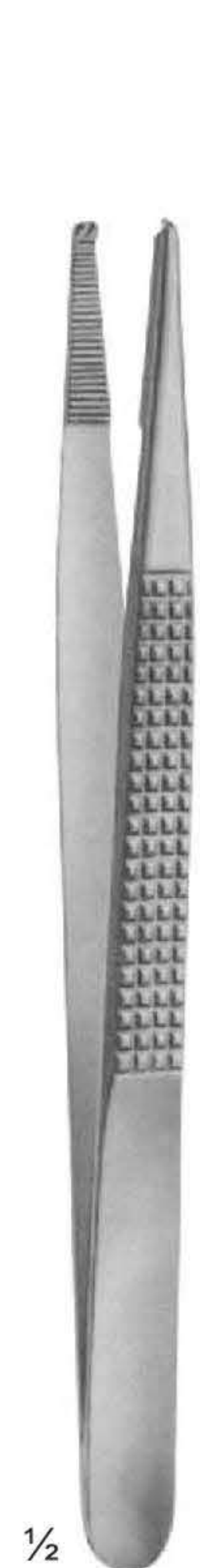

1/2  
UG-296  
**BONNEY**

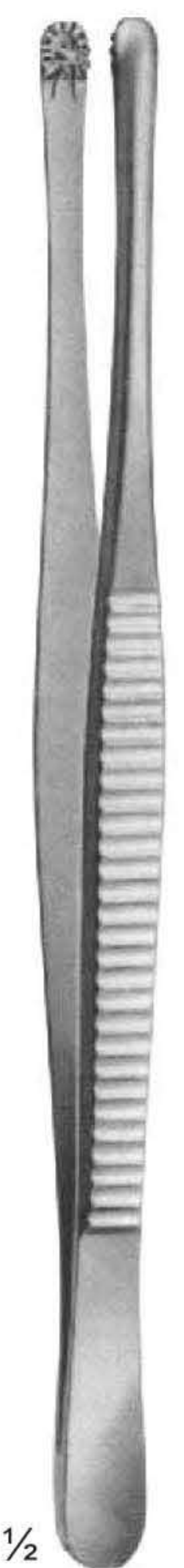

1/2  
UG-297  
**RUSS. MODELL**  
200 mm

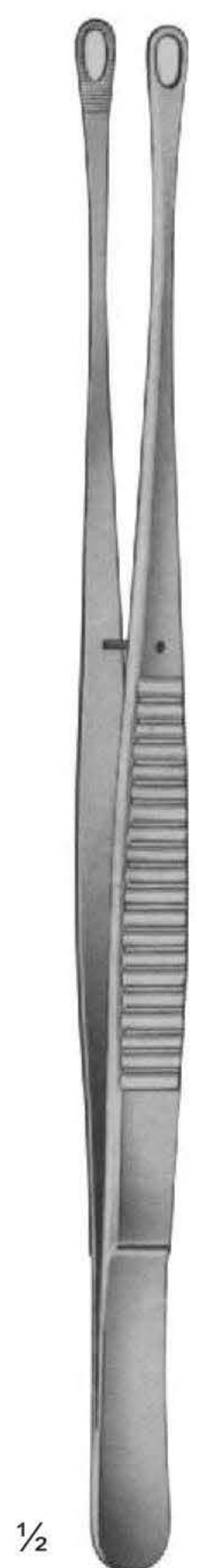

1/2  
UG-299  
**TUTTLE**  
Lung Dissecting Forceps  
230 mm

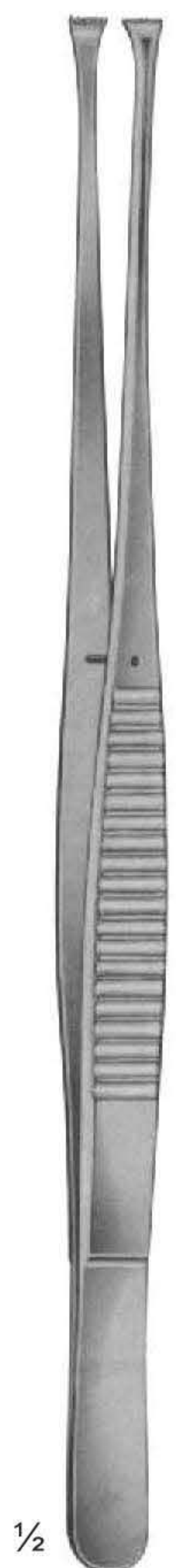

1/2  
UG-300  
**NELSON**  
Lung Dissecting Forceps  
230 mm

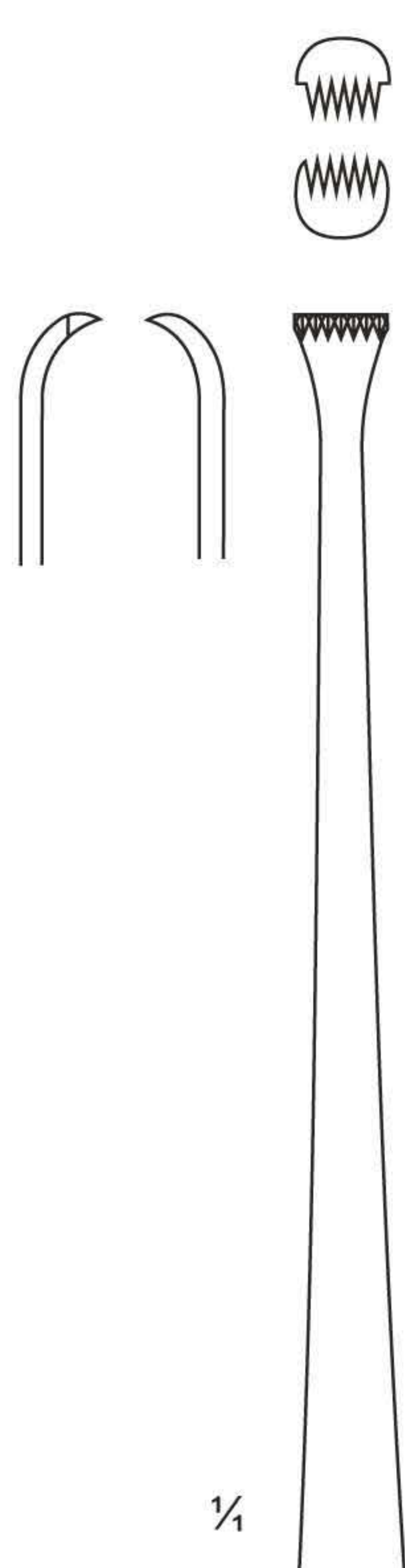

1/2  
UG-303  
**DUVAL**  
Intestinal Forceps  
140 mm

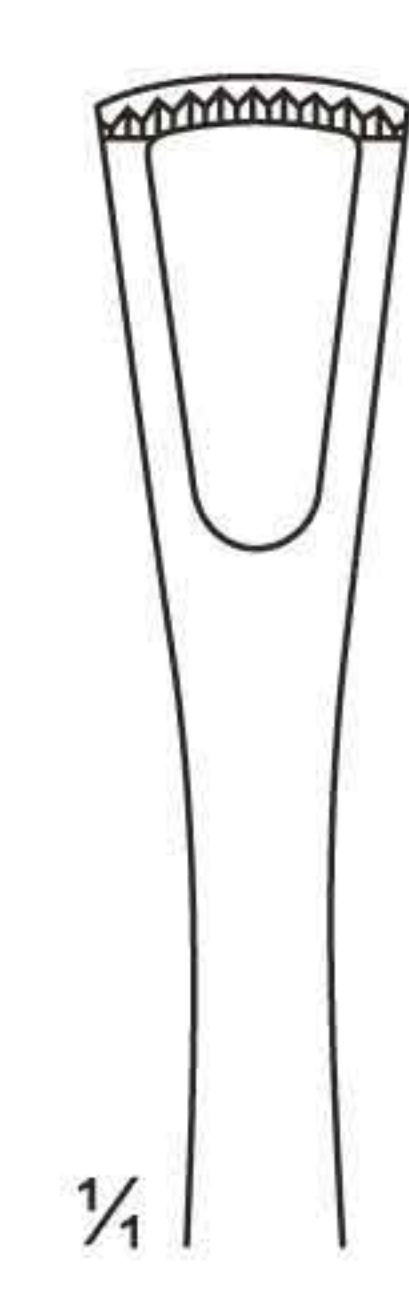

1/2  
UG-306  
**DENIS-BROWNE**  
Intestinal Forceps  
190 mm



# Splinter and Cilia Forceps

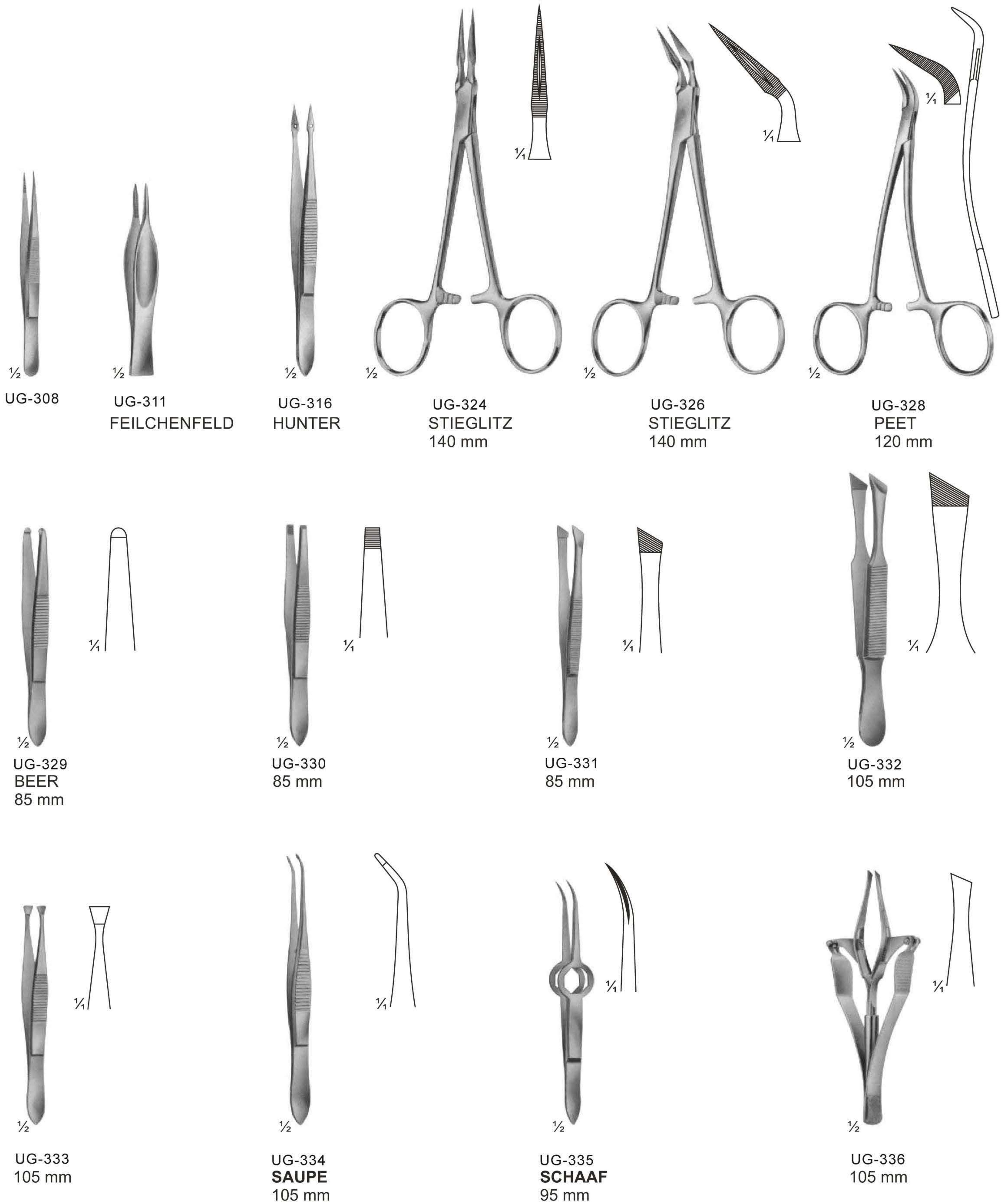

# Sponge and Dressing Forceps

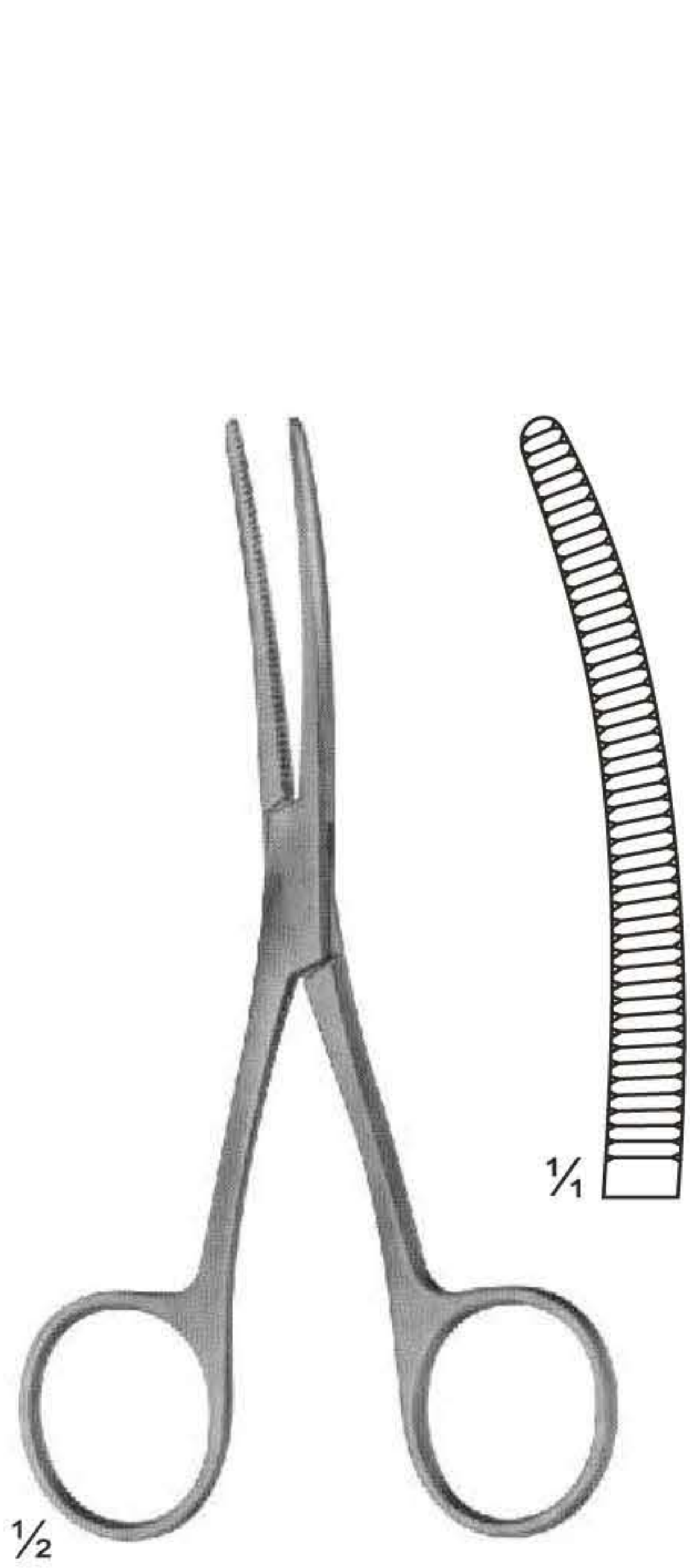

UG-337  
BRYANT  
130 mm

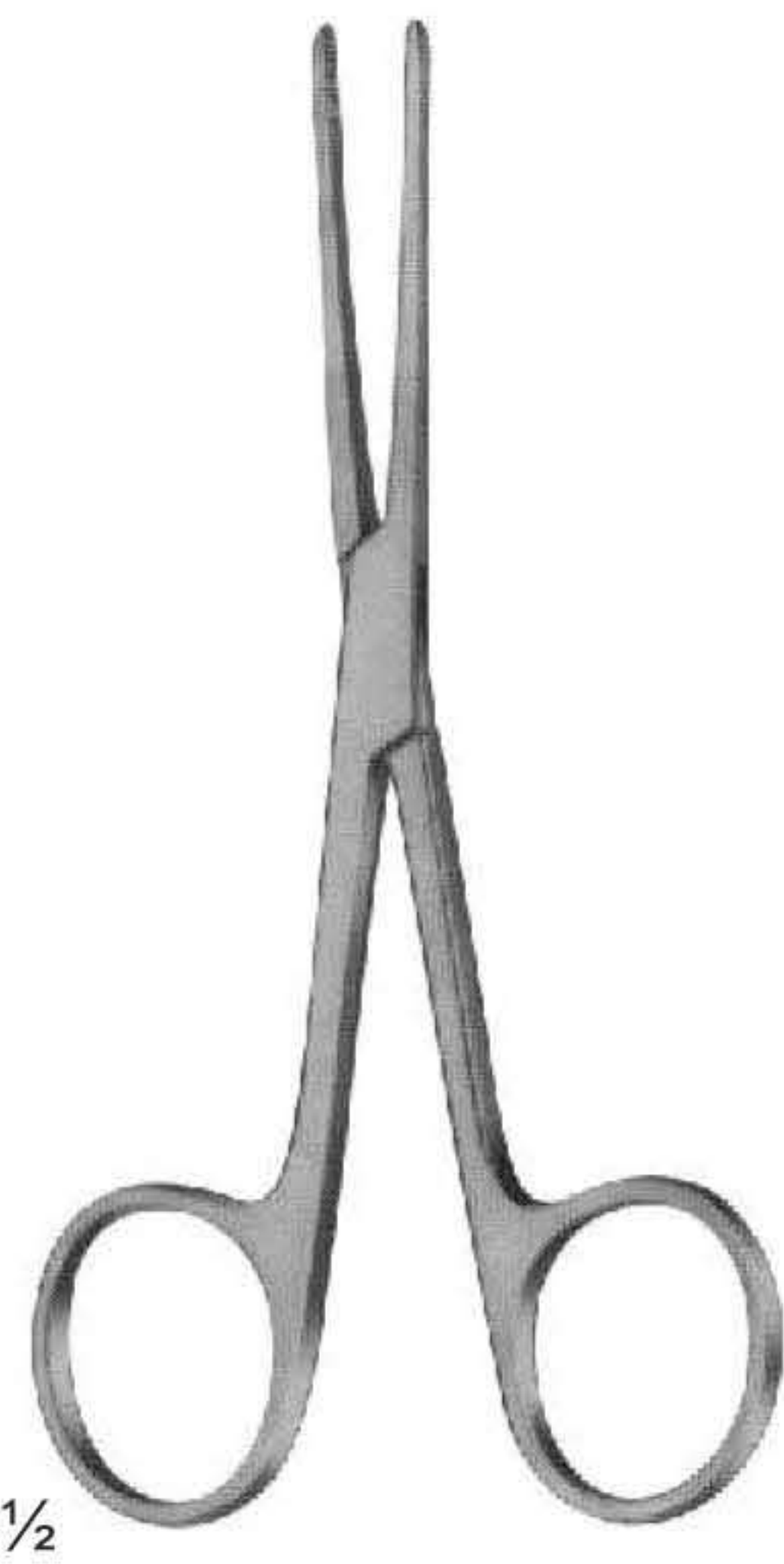

UG-338  
LISTER  
Sinus Forceps

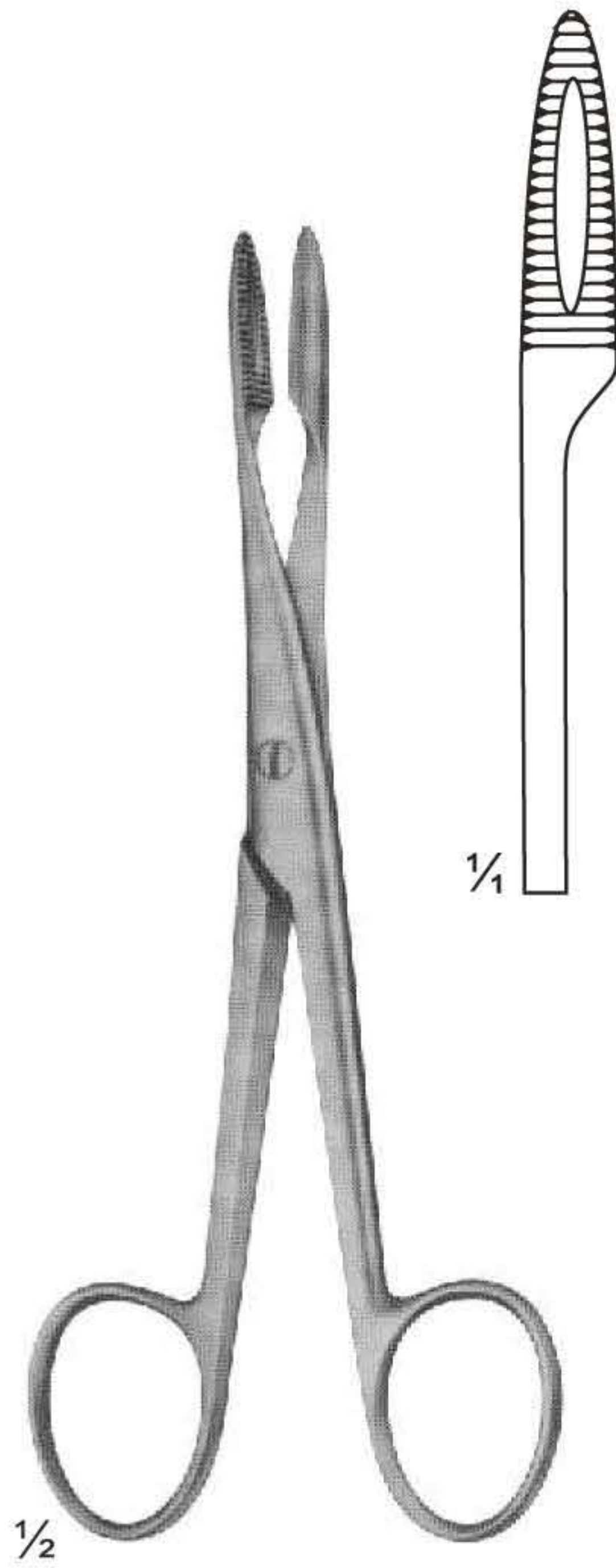

UG-343  
Without Ratchet  
145 mm

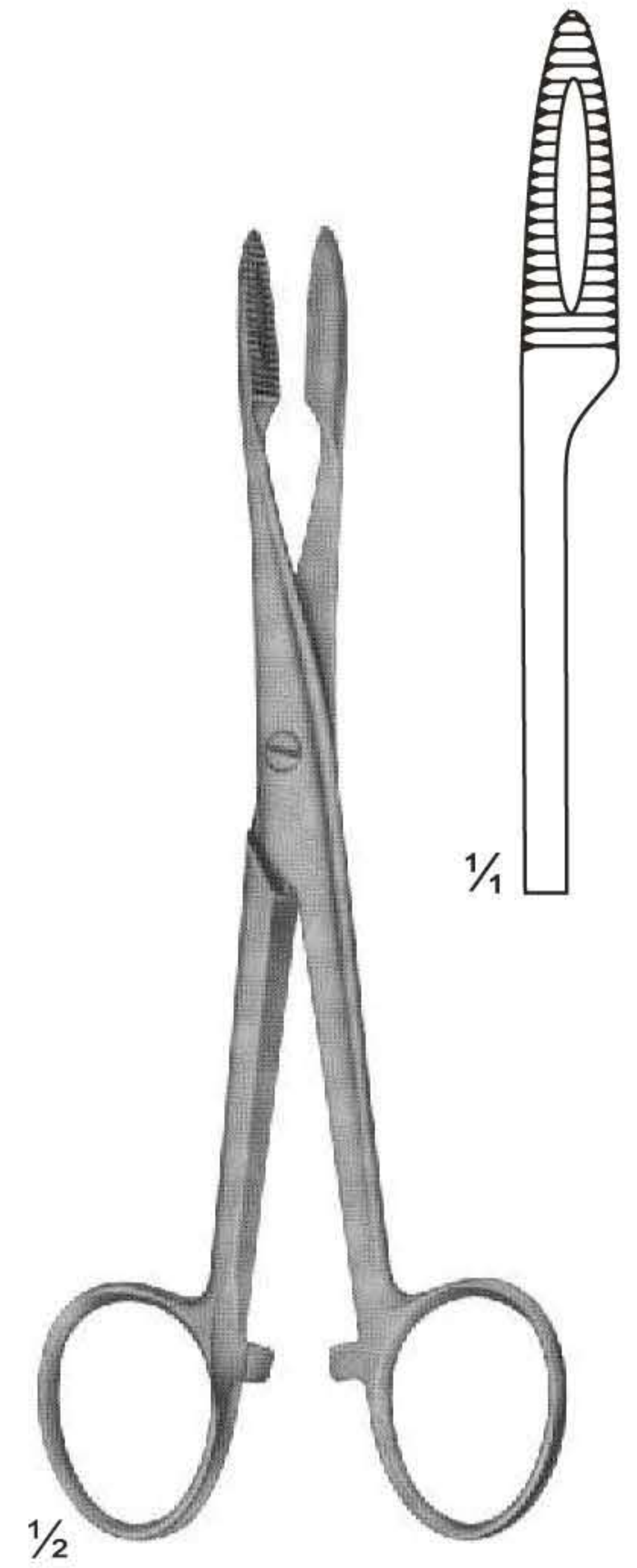

UG-345  
With Ratchet  
145 mm

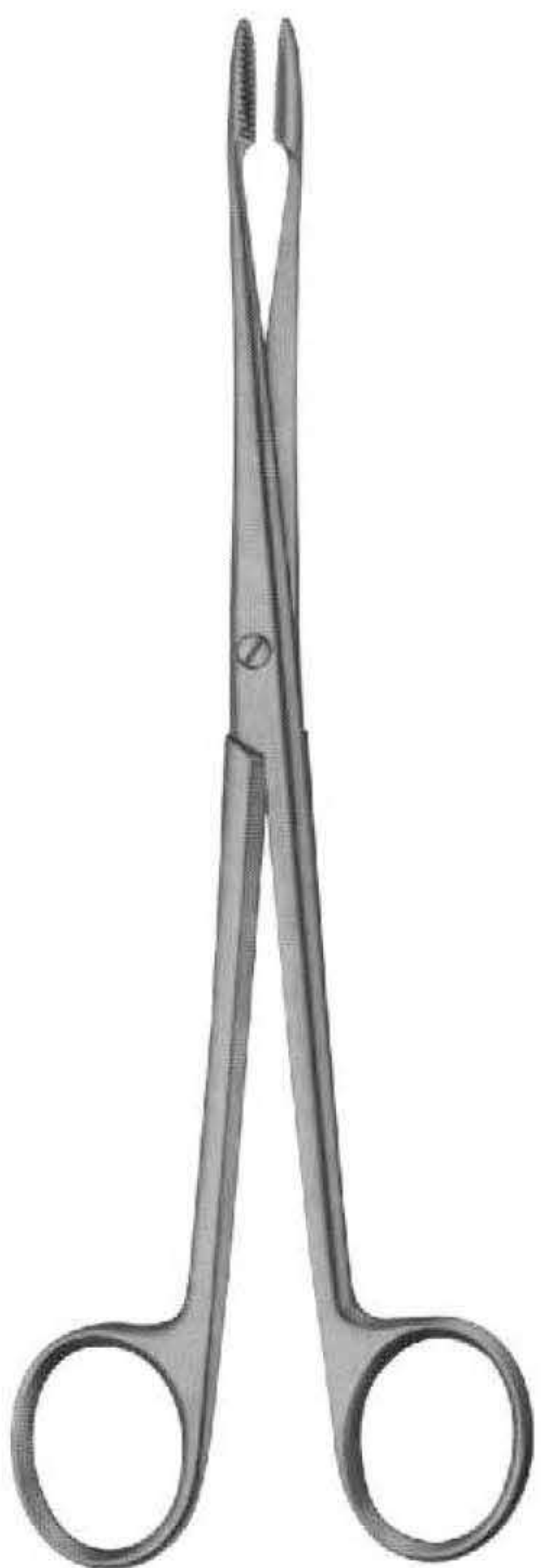

UG-350  
GROSS  
Without Ratchet  
200 mm

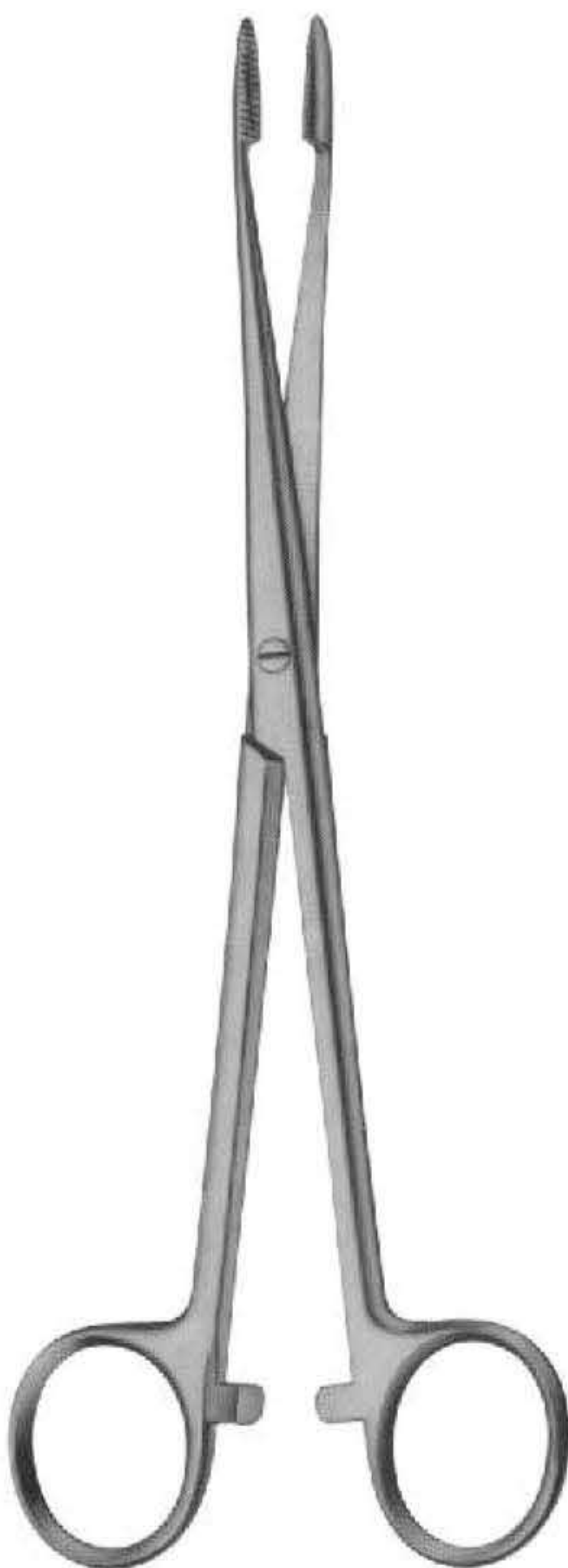

UG-355  
GROSS  
With Ratchet  
180 mm

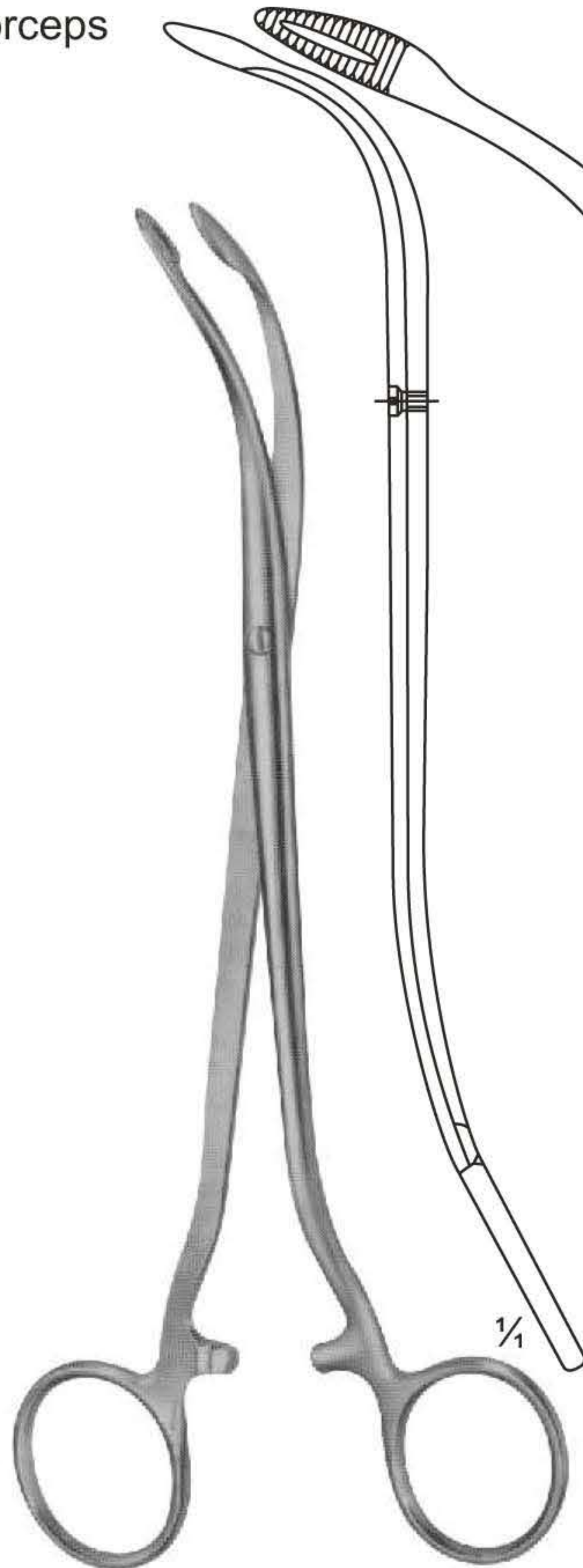

UG-359  
DUPLAY  
190 mm

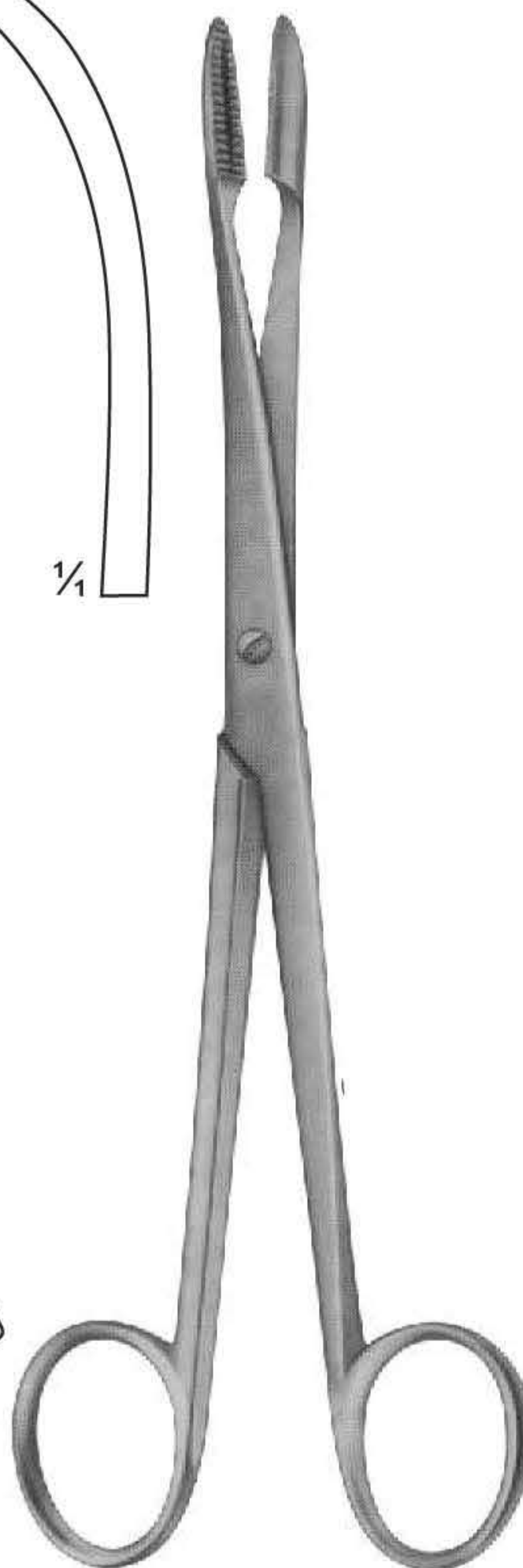

UG-362  
GROSS  
Without Ratchet  
200 mm



UG-363  
GROSS  
With Ratchet  
200 mm

## Sponge and Dressing Forceps

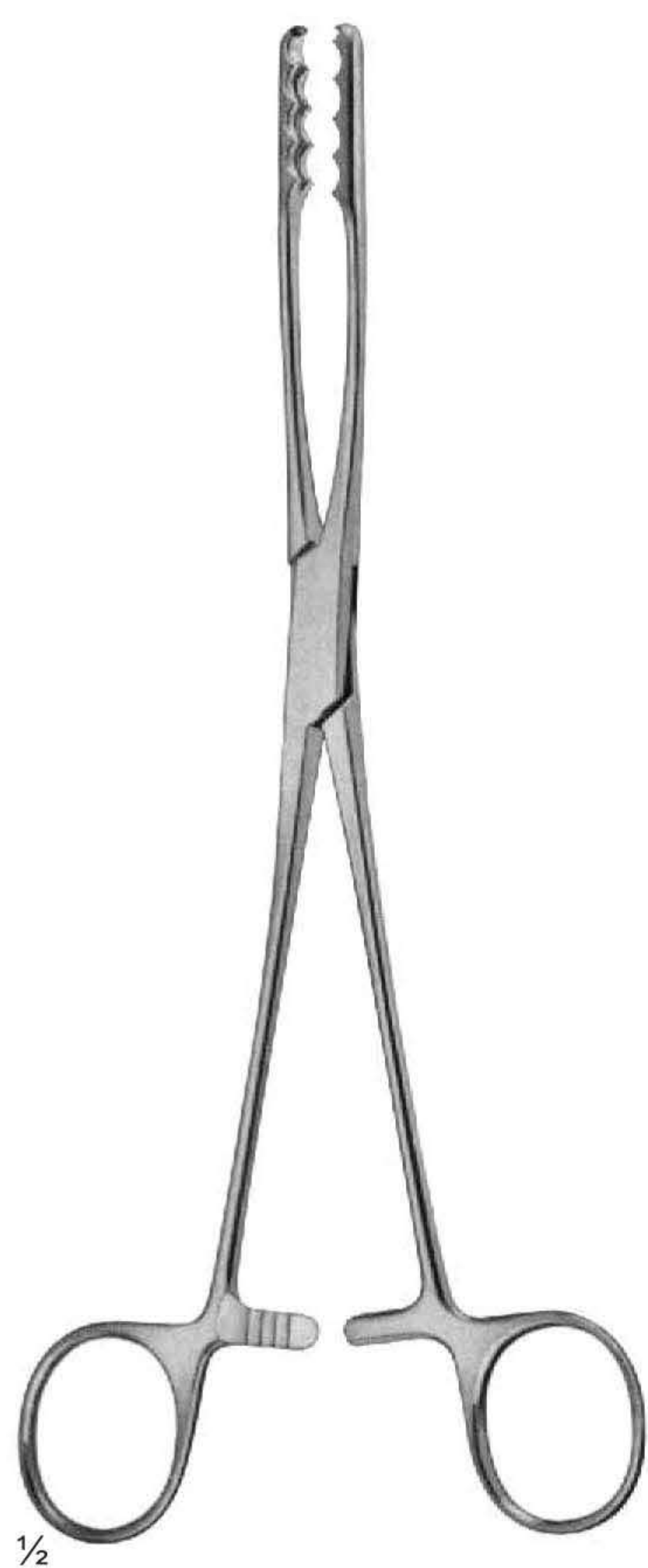

UG-365  
AESCULAP  
220 mm



UG-367  
MAIER  
Without Ratchet  
265 mm



UG-370  
MAIER  
With Ratchet  
265 mm



# Sponge and Dressing Forceps



UG-450  
SIMS-MAIER  
280 mm

UG-452  
COLLIN  
240 mm

UG-454  
CHERON  
Handles Laterally Angled  
240 mm

UG-455  
EMMET  
210 mm

# Dressing, Sponge holding, Organ and Tissue Grasping Forceps



1/2

UG-456  
FOERSTER-BALLENGER  
180 mm



1/2

UG-458  
RAMPLEY



1/2

UG-460  
FOERSTER-BALLENGER  
240 mm

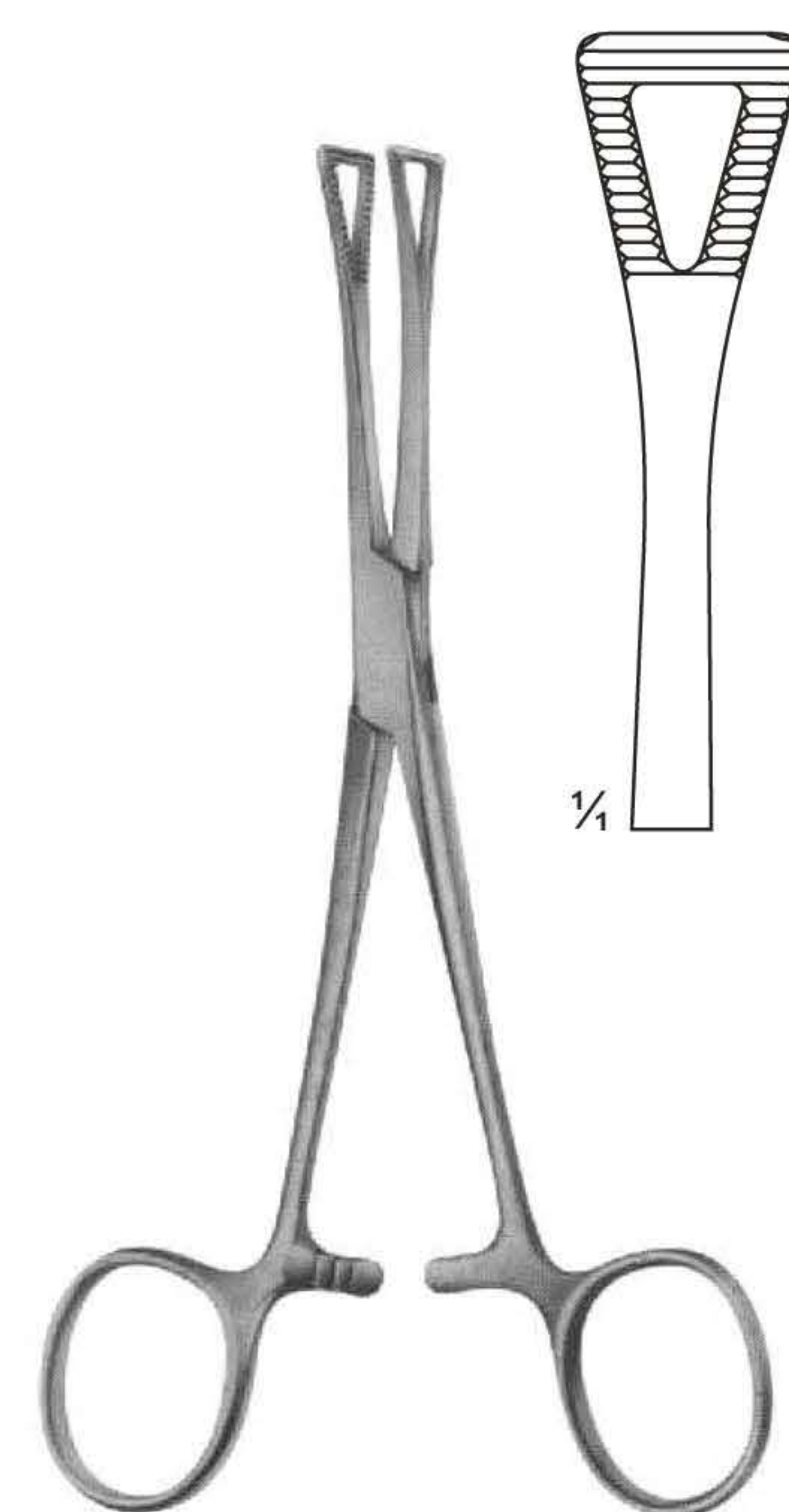

1/4

UG-462  
PENNINGTON  
155 mm

# Dressing, Sponge holding, Organ and Tissue Grasping Forceps



$\frac{1}{2}$   
UG-464  
COLLIN



$\frac{1}{2}$   
UG-466  
COLLIN

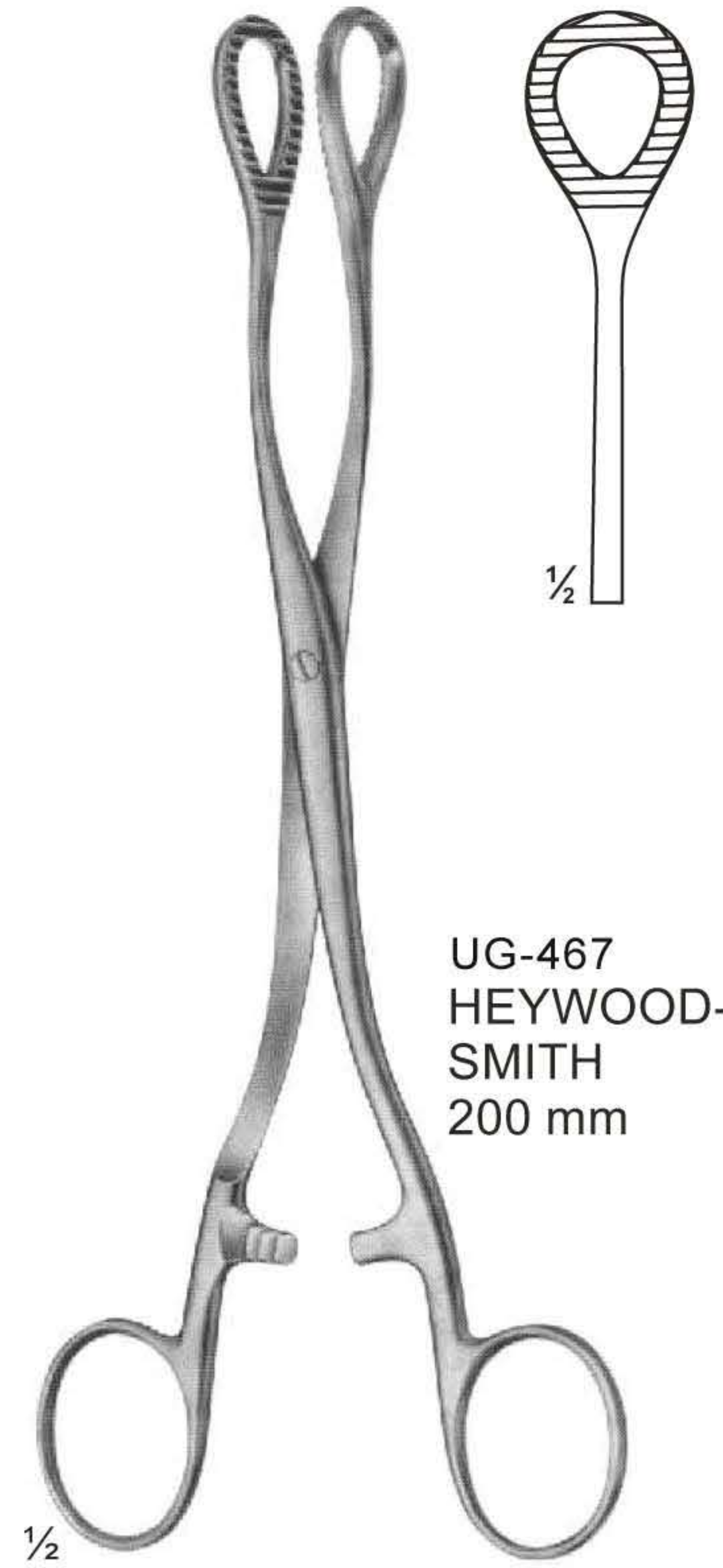

UG-467  
HEYWOOD-  
SMITH  
200 mm

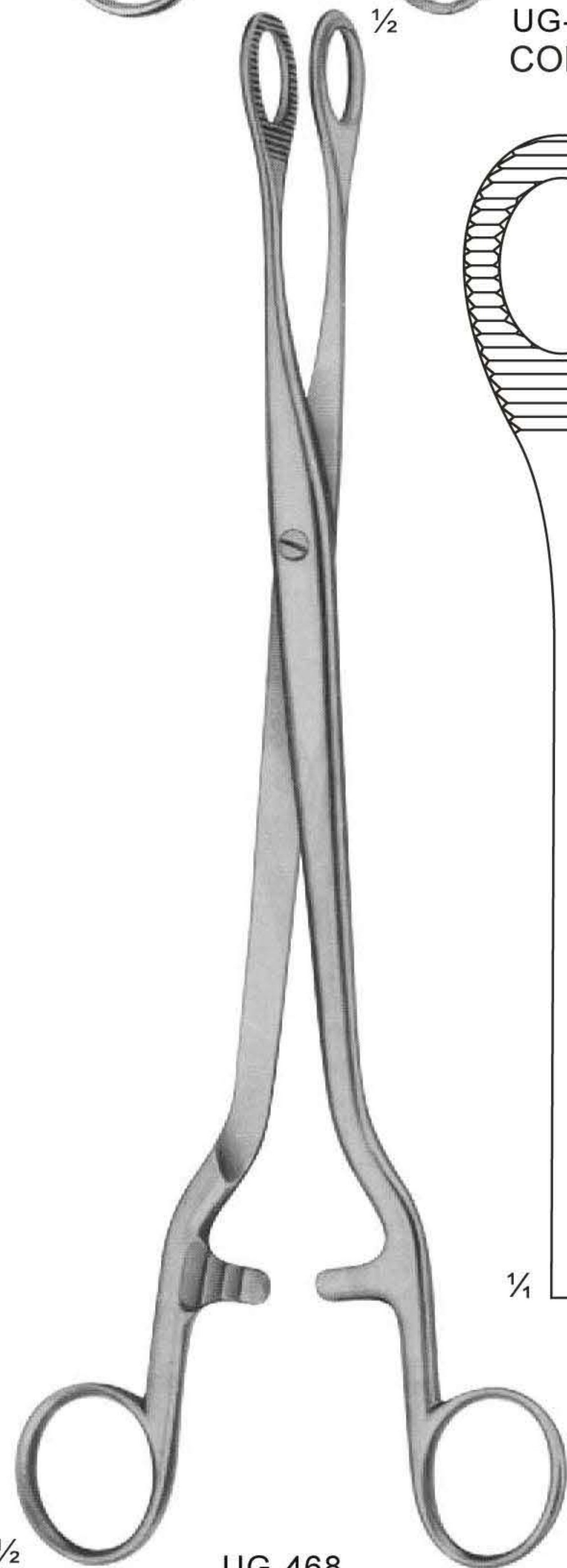

$\frac{1}{2}$   
UG-468  
NOTO  
280 mm

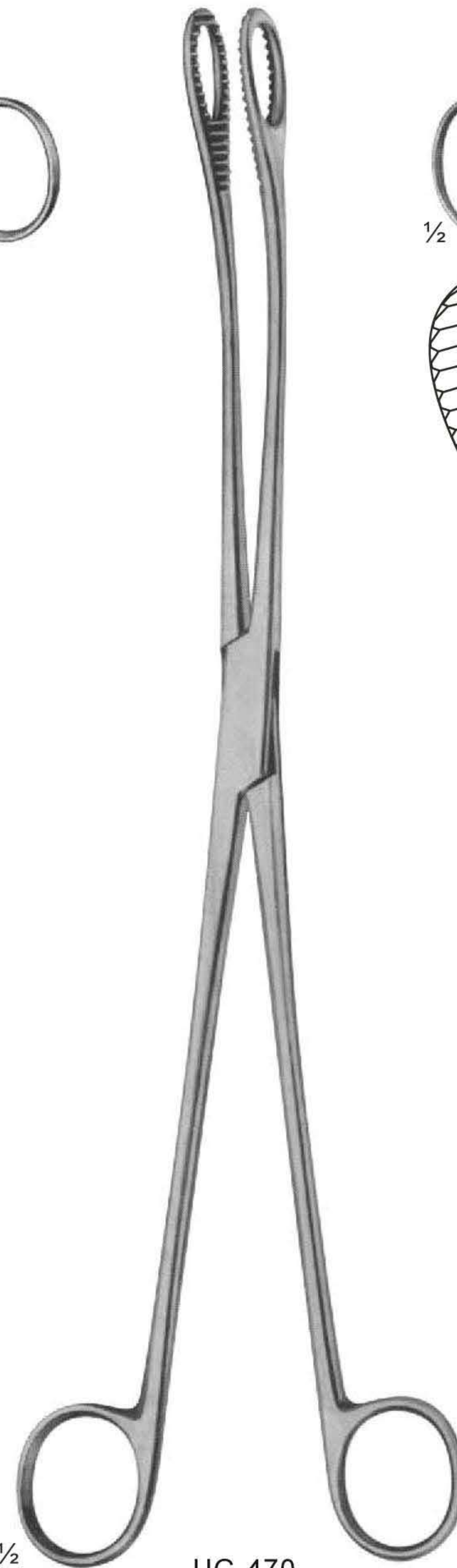

$\frac{1}{2}$   
UG-470  
KELLY  
320 mm

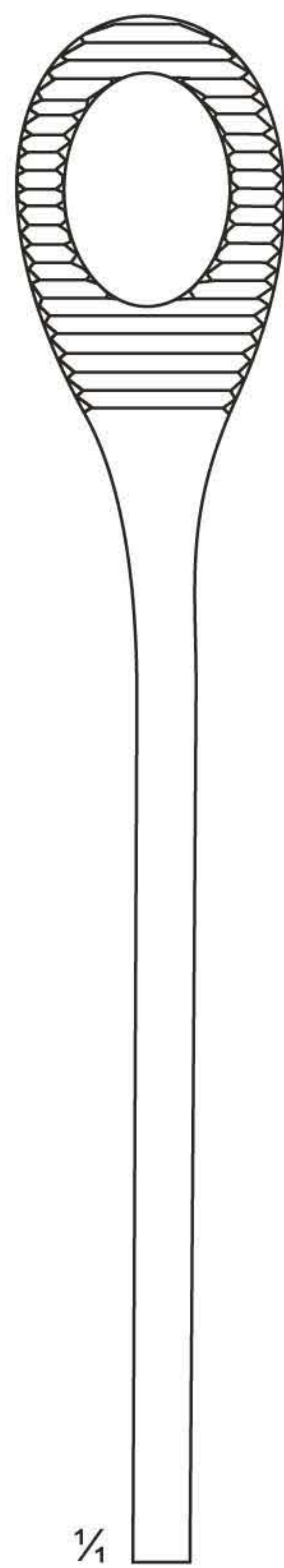

$\frac{1}{4}$

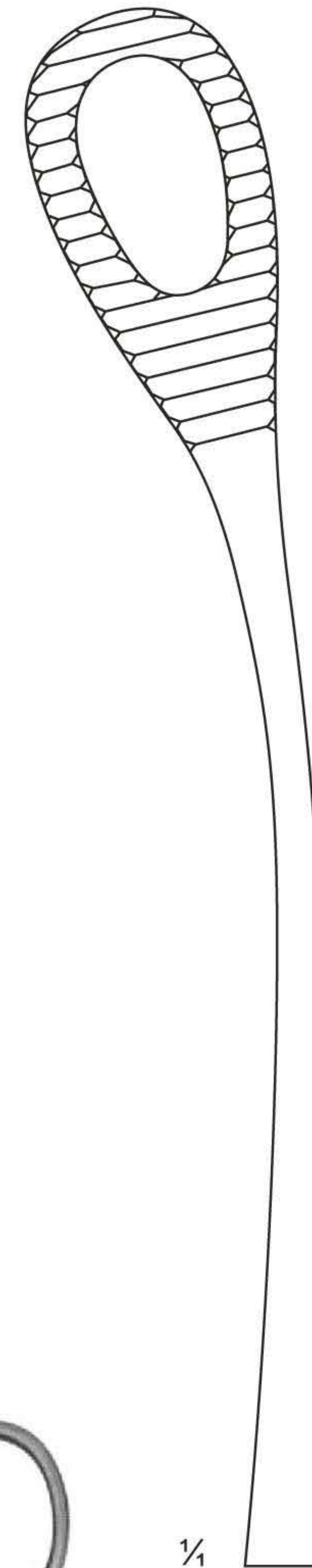

$\frac{1}{4}$

# Tendon Seizing Forceps



1/2

UG-471  
HERZ  
155 mm



1/2

UG-473  
JACKSON  
4 x 5 teeth  
150 mm

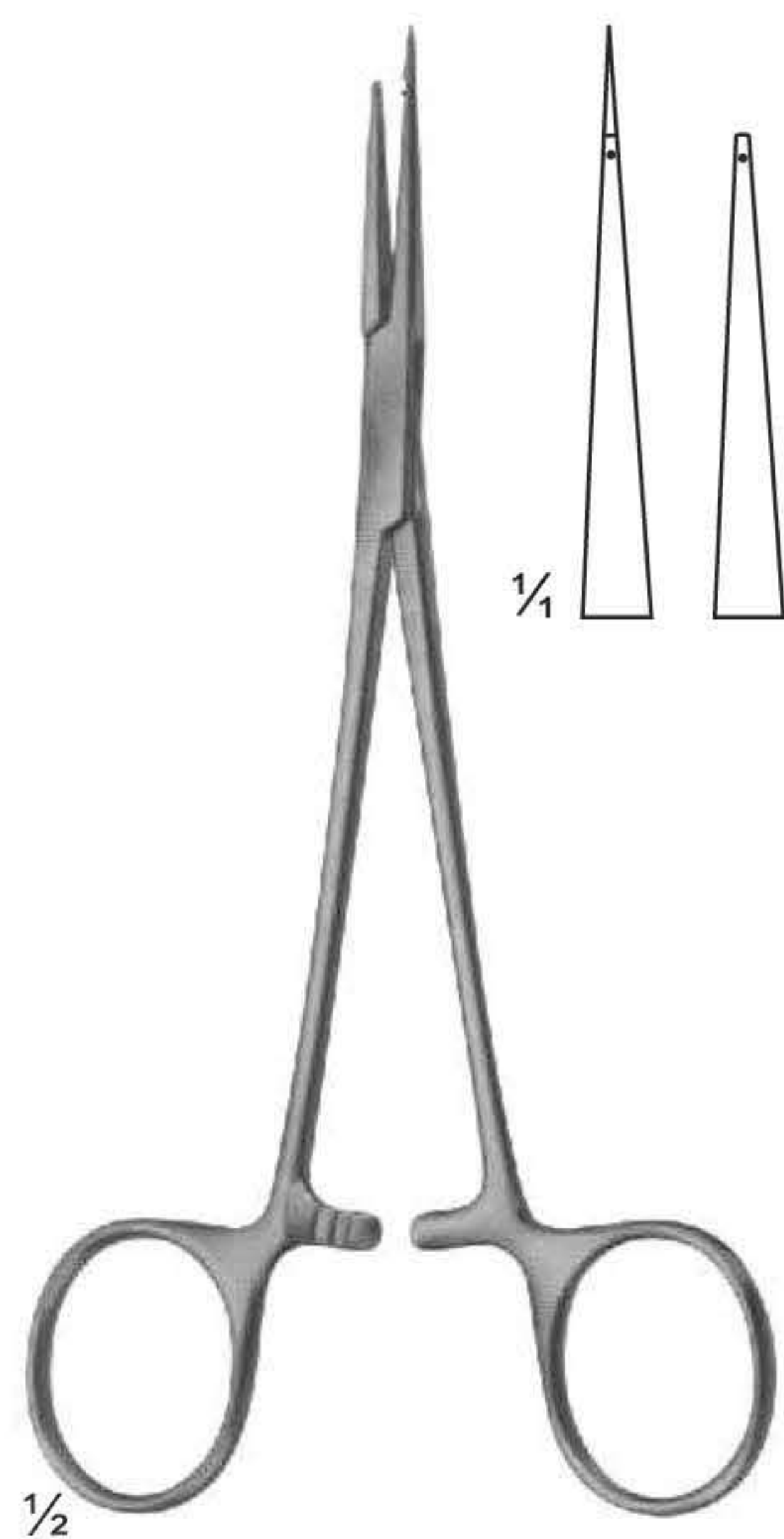

1/2

UG-474  
150 mm

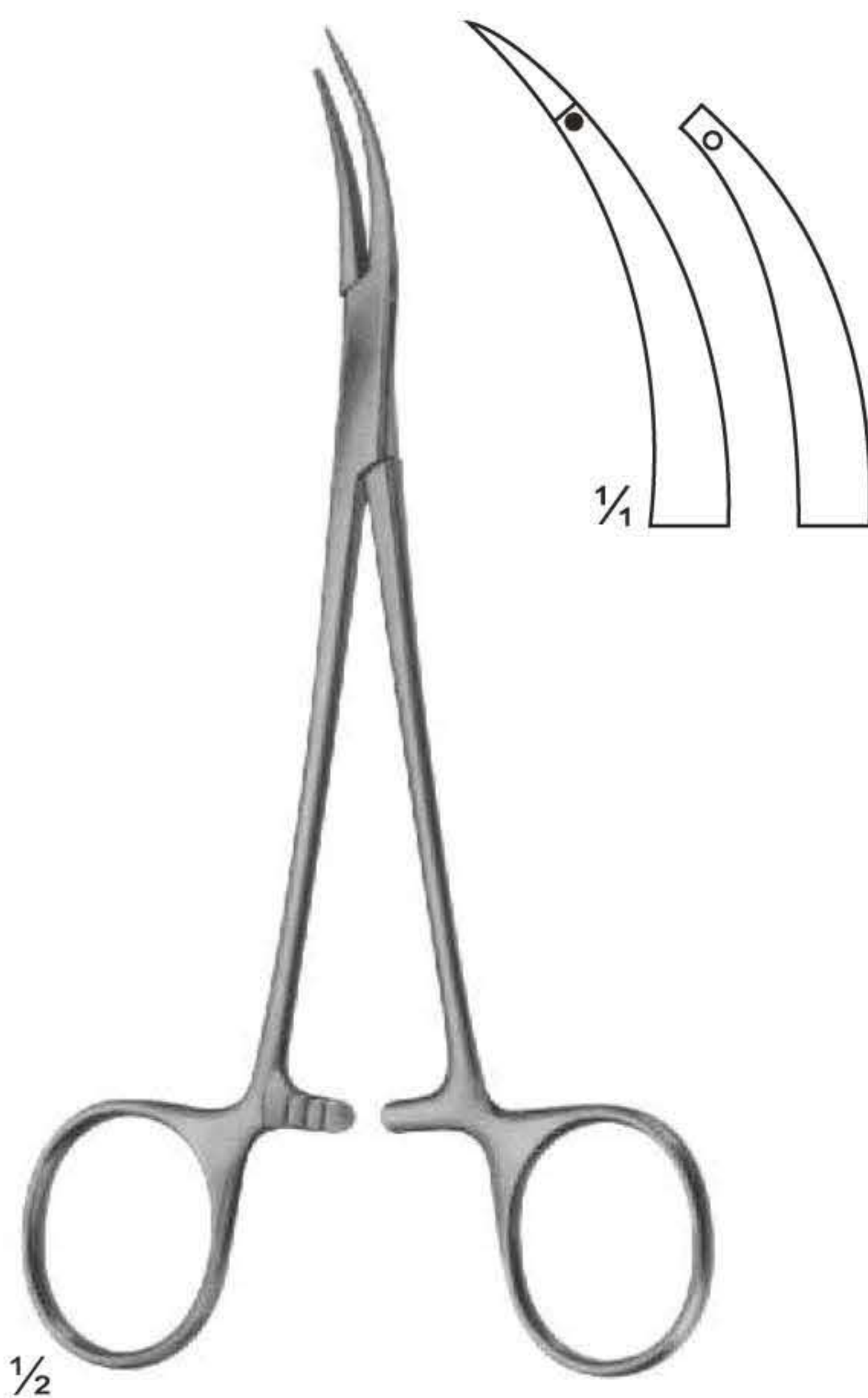

1/2

UG-476  
150 mm

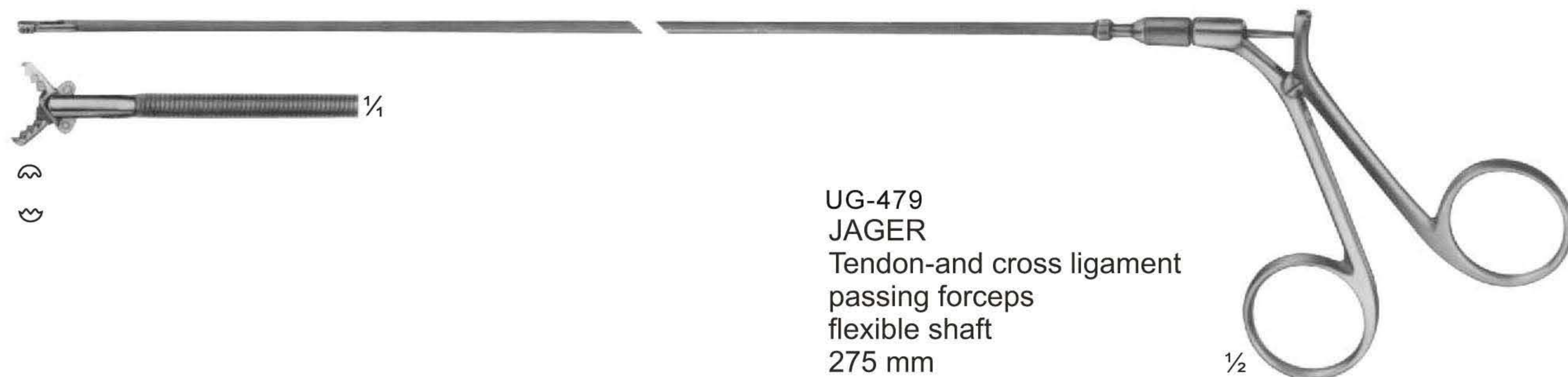

1/4

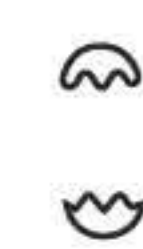

UG-479  
JAGER  
Tendon-and cross ligament  
passing forceps  
flexible shaft  
275 mm

1/2

# Artery Traction - and Tissue Grasping Forceps

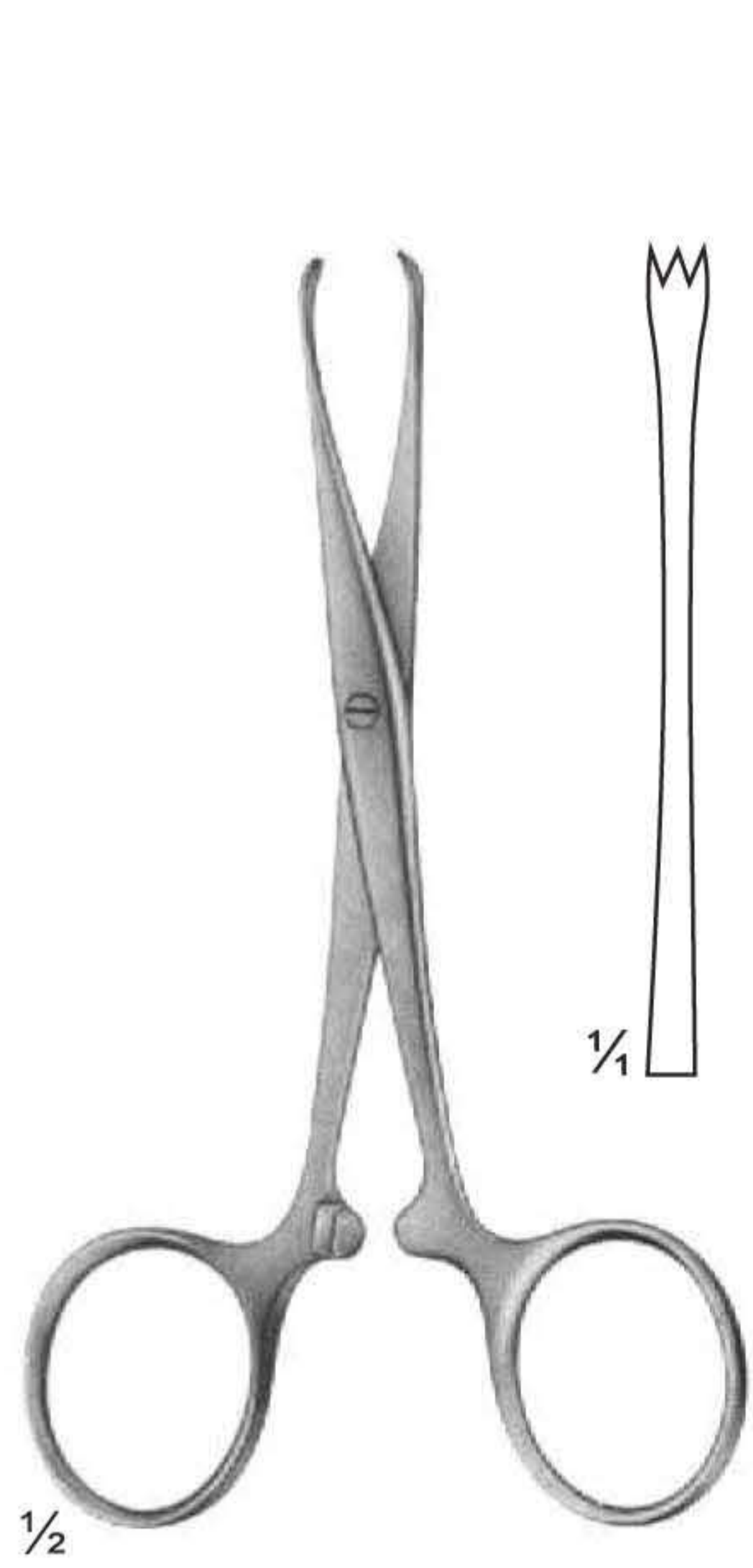

UG-482  
CHAPUT  
2 x 3 teeth  
125 mm

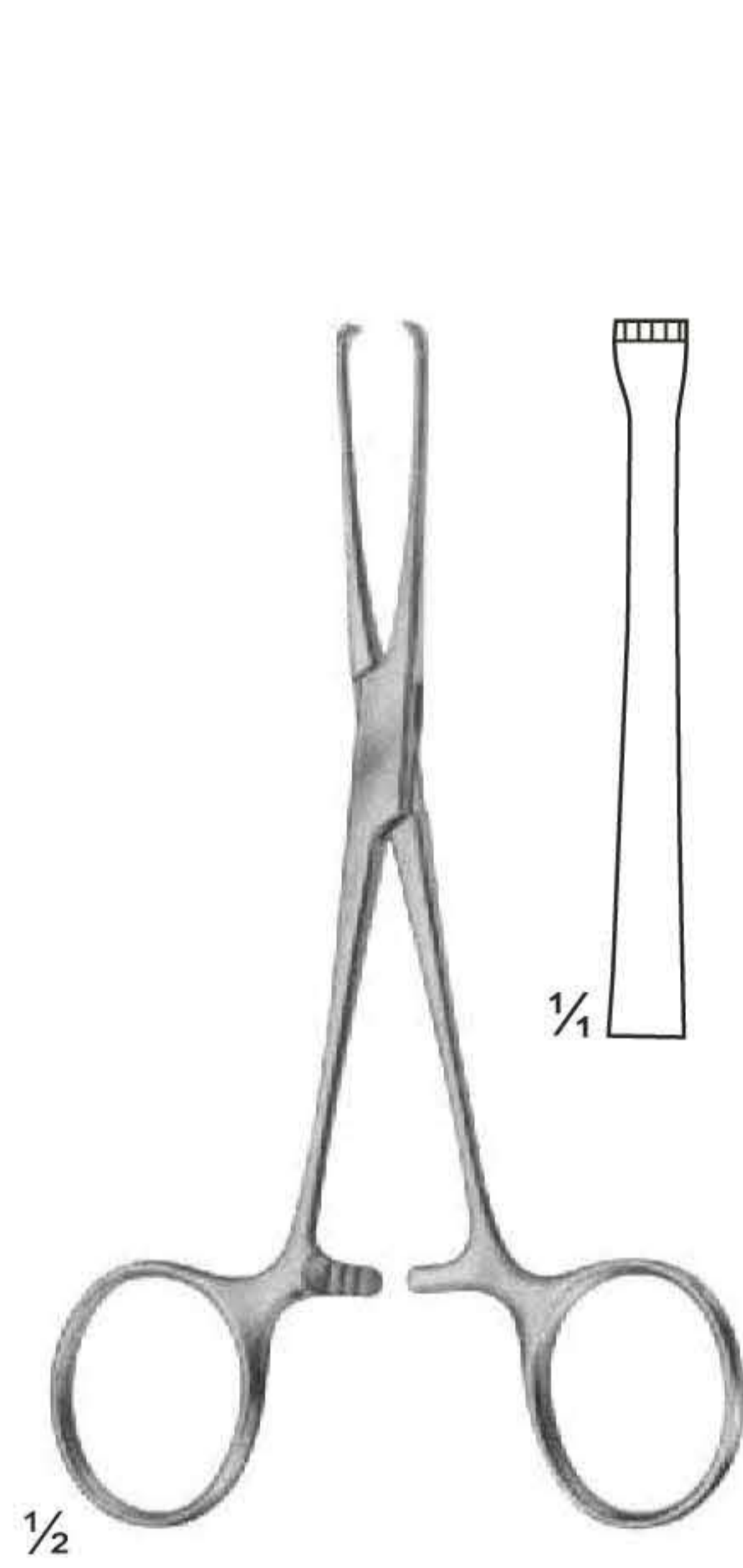

UG-483  
BABY-ALLIS  
4 x 5 teeth  
130 mm

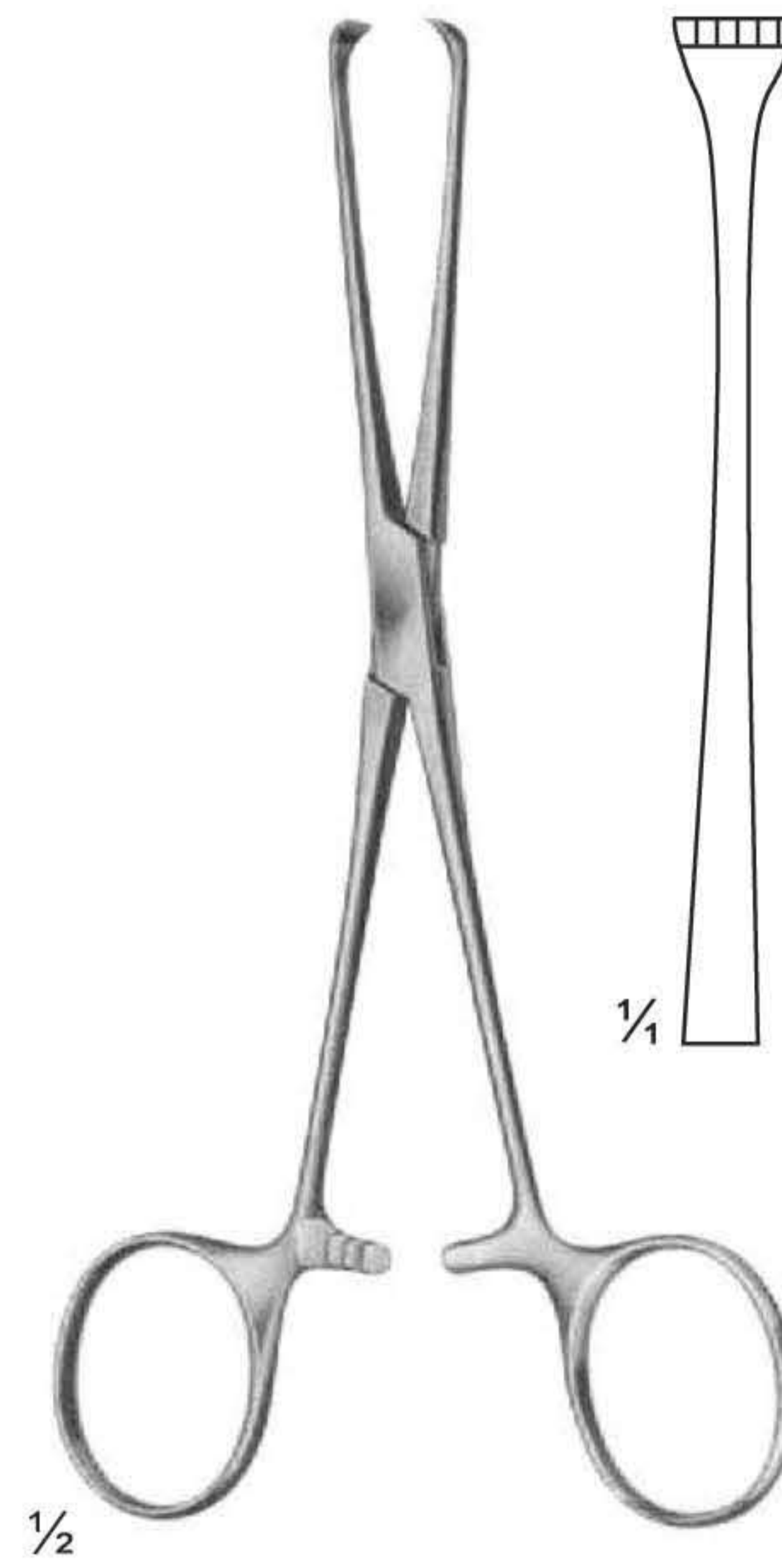

UG-484  
BOYS-ALLIS  
5 x 6 teeth  
155 mm

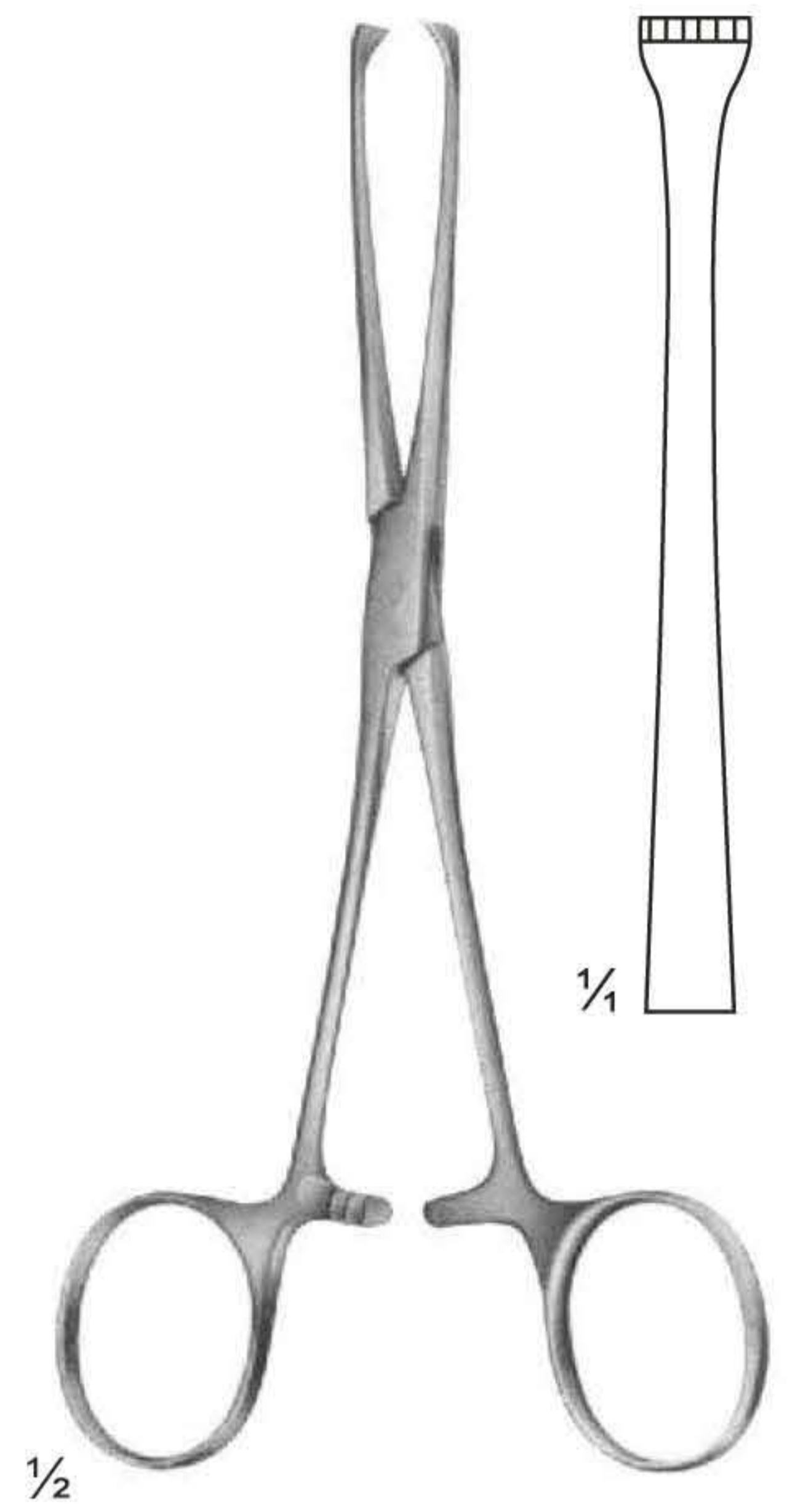

UG-485  
ALLIS  
5 x 6 teeth  
155 mm

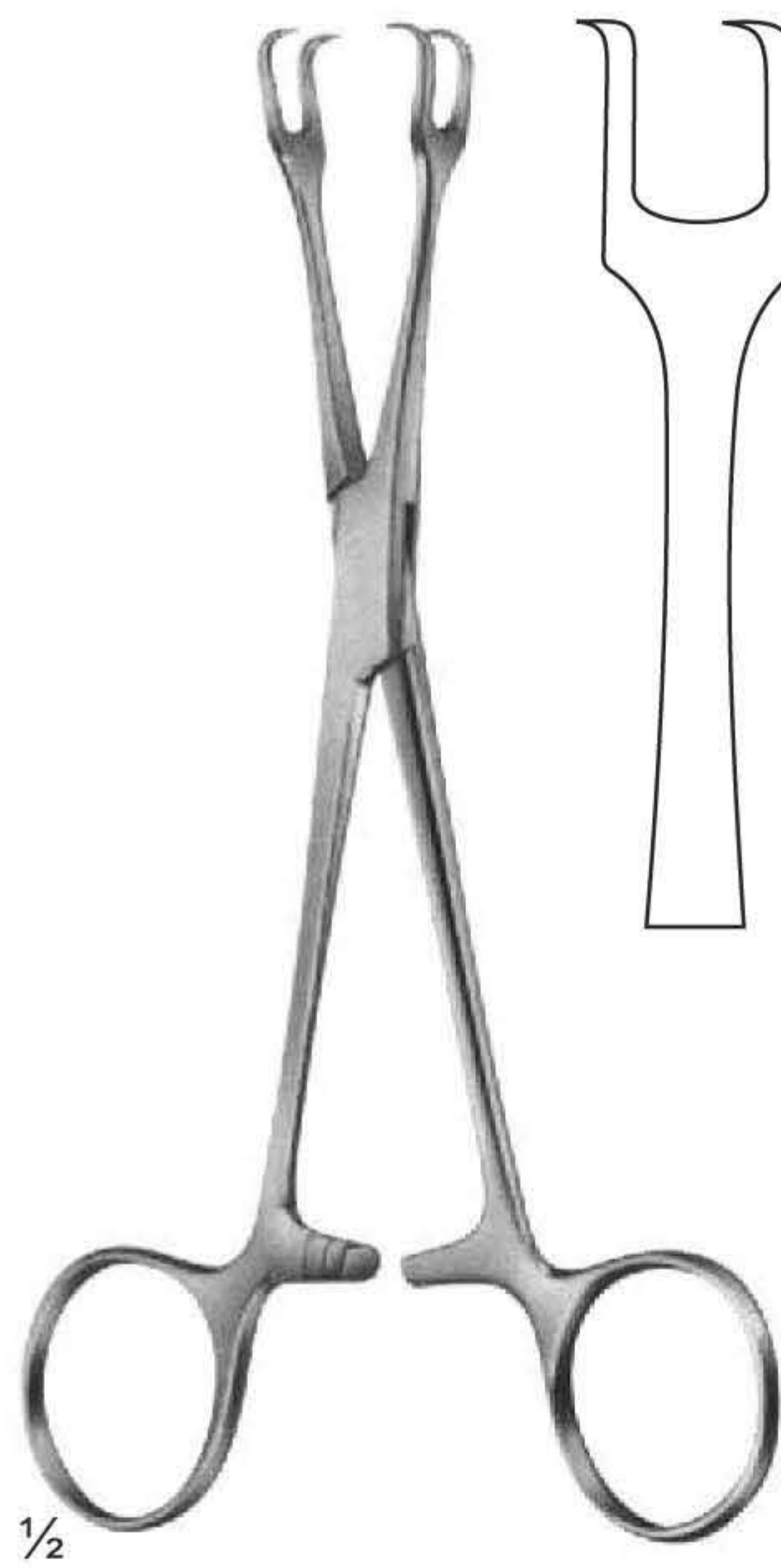

UG-487  
LAHEY  
135 mm

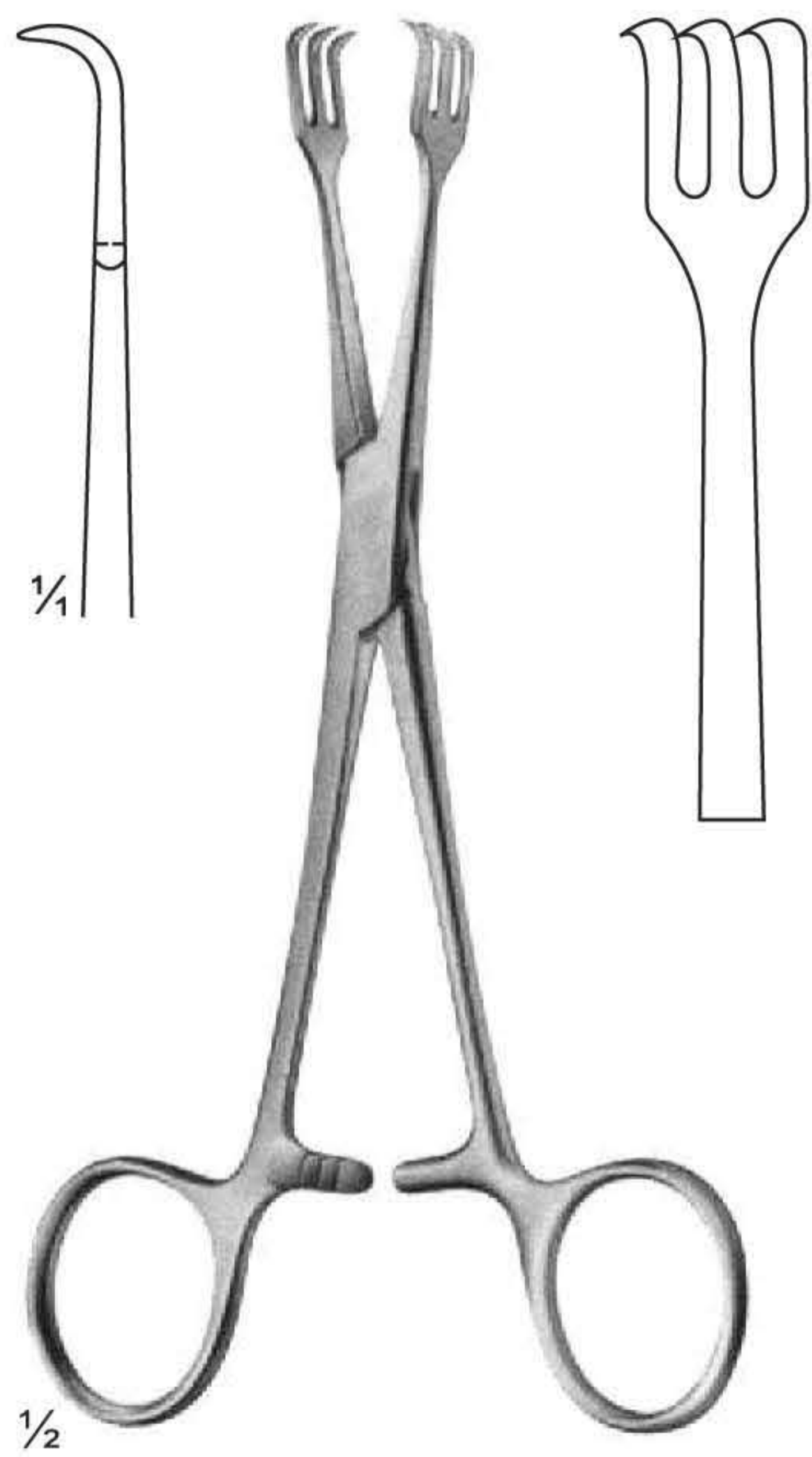

UG-488  
LAHEY  
135 mm

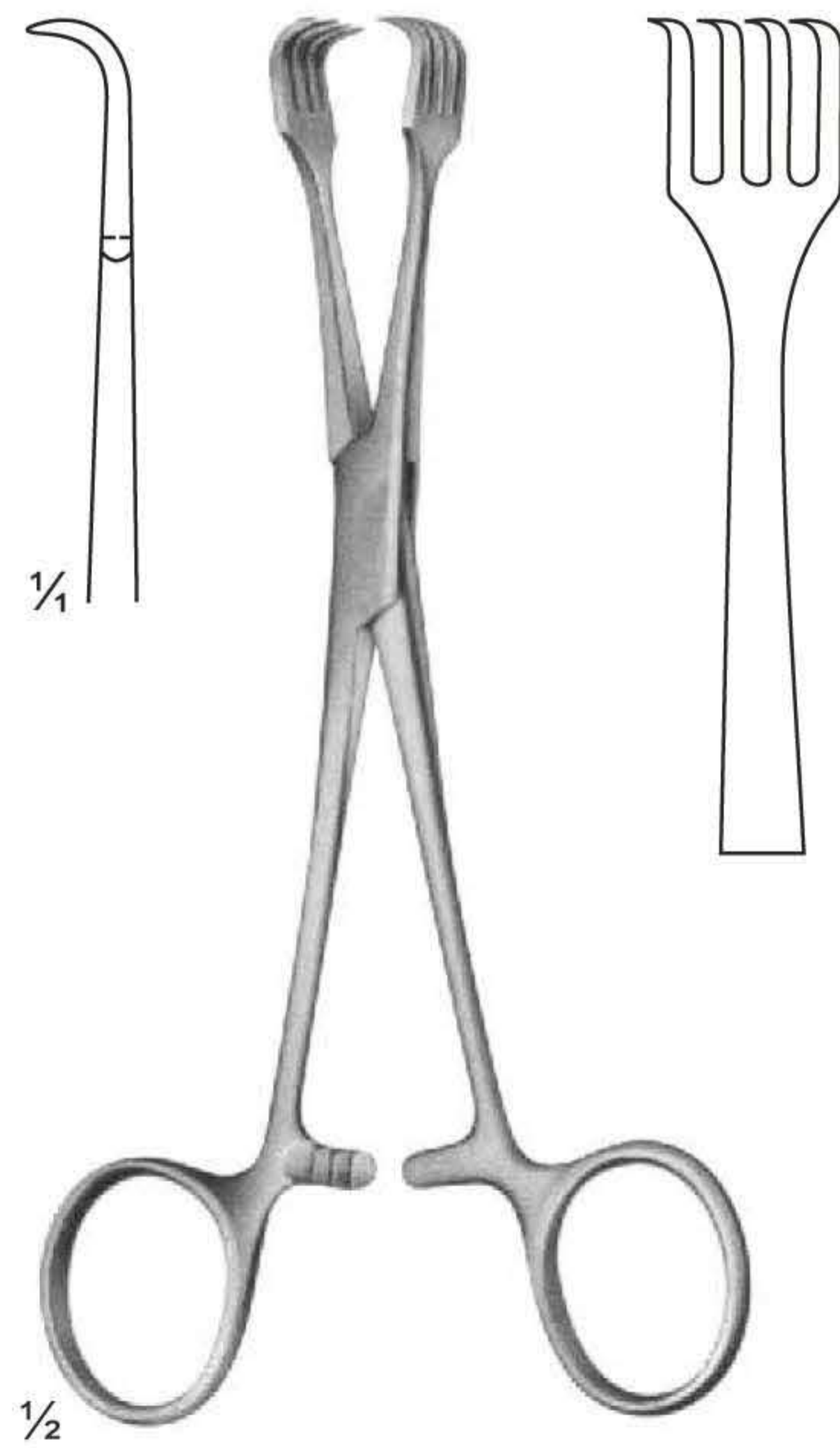

UG-489  
BRAUN  
155 mm

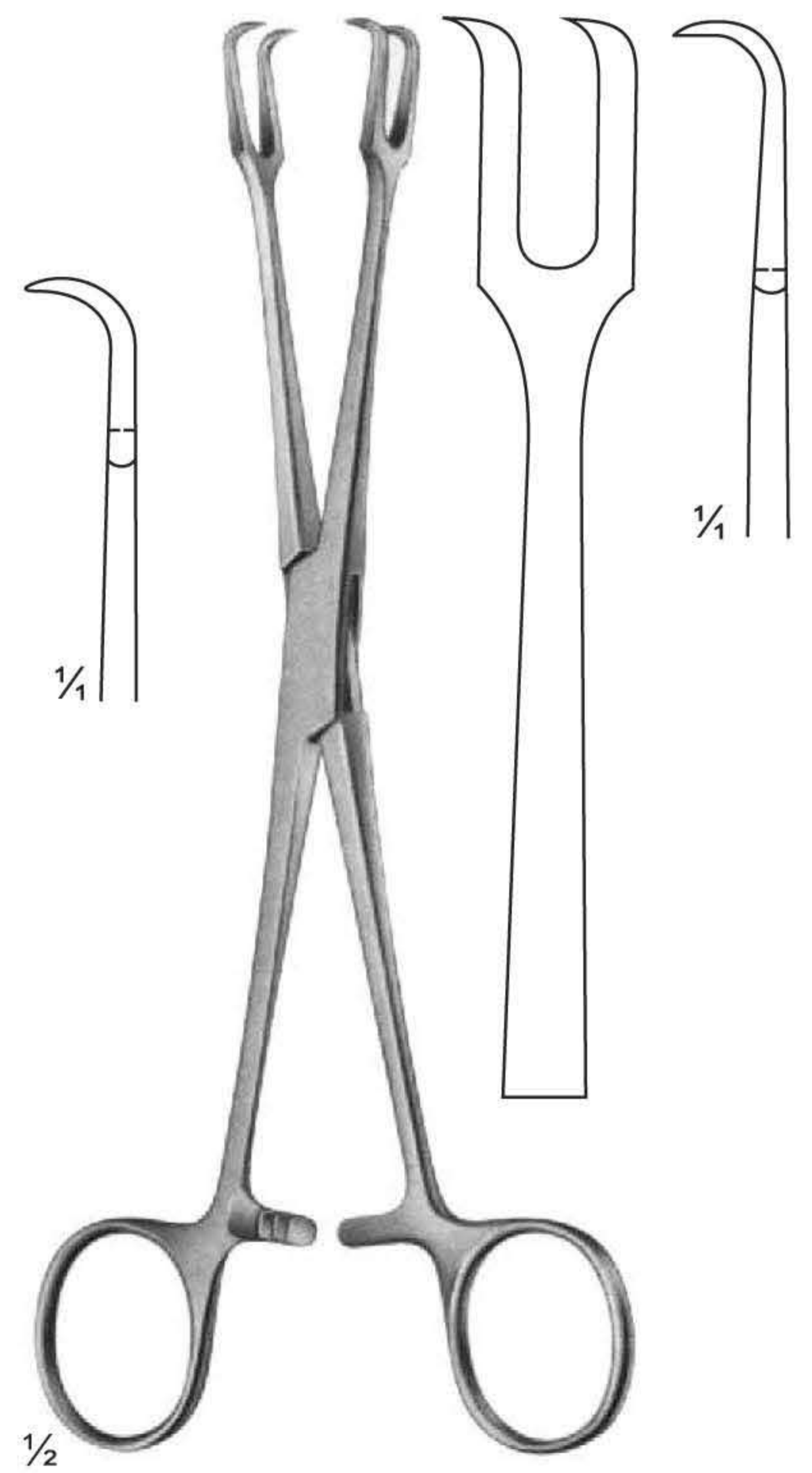

UG-490  
MUSEUX  
200 mm

# Organ - and Tissue Grasping Forceps

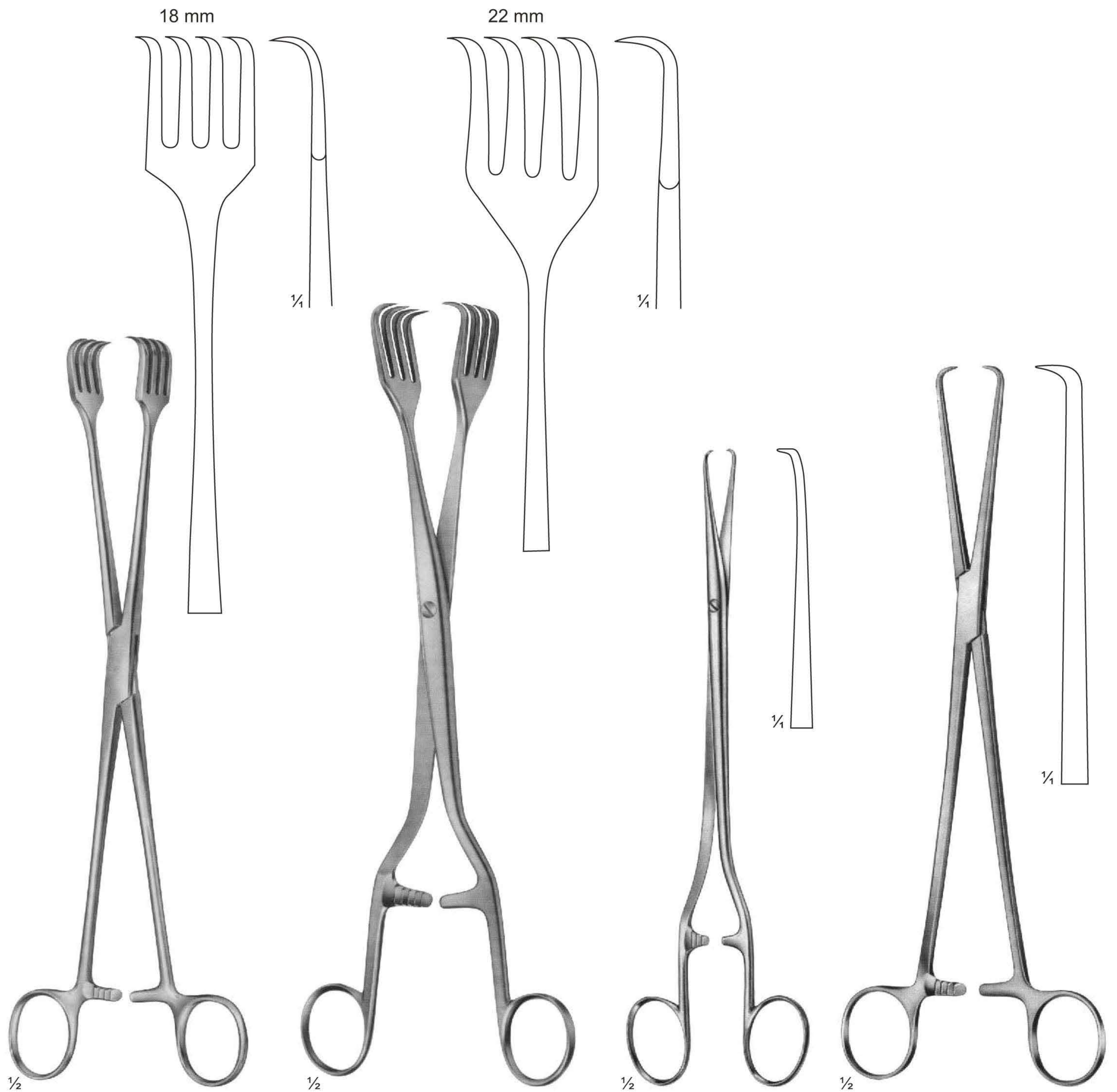

UG-492  
AESCULAP  
260 mm

UG-493  
PRATT  
270 mm

UG-494  
TIEMANN  
Bullet forceps  
220 mm

UG-495  
SCHRODER  
250 mm

# Towel Clamps

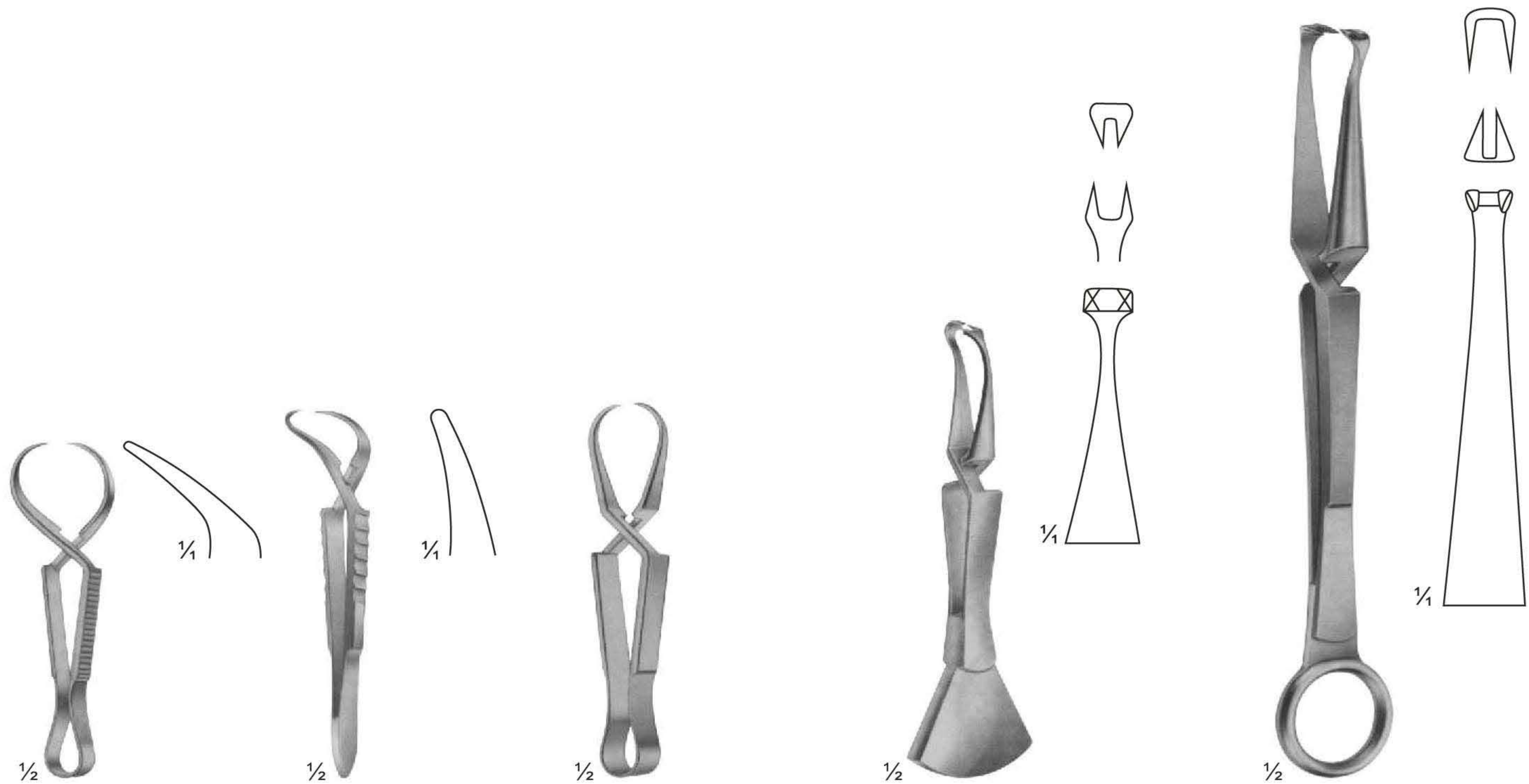

UG-496  
JONES  
85 mm

UG-498  
ENGL. MOD.  
85 mm

UG-499  
SCHAEDEL  
85 mm

UG-502  
DOYEN  
110 mm

UG-504  
DOYEN  
180 mm

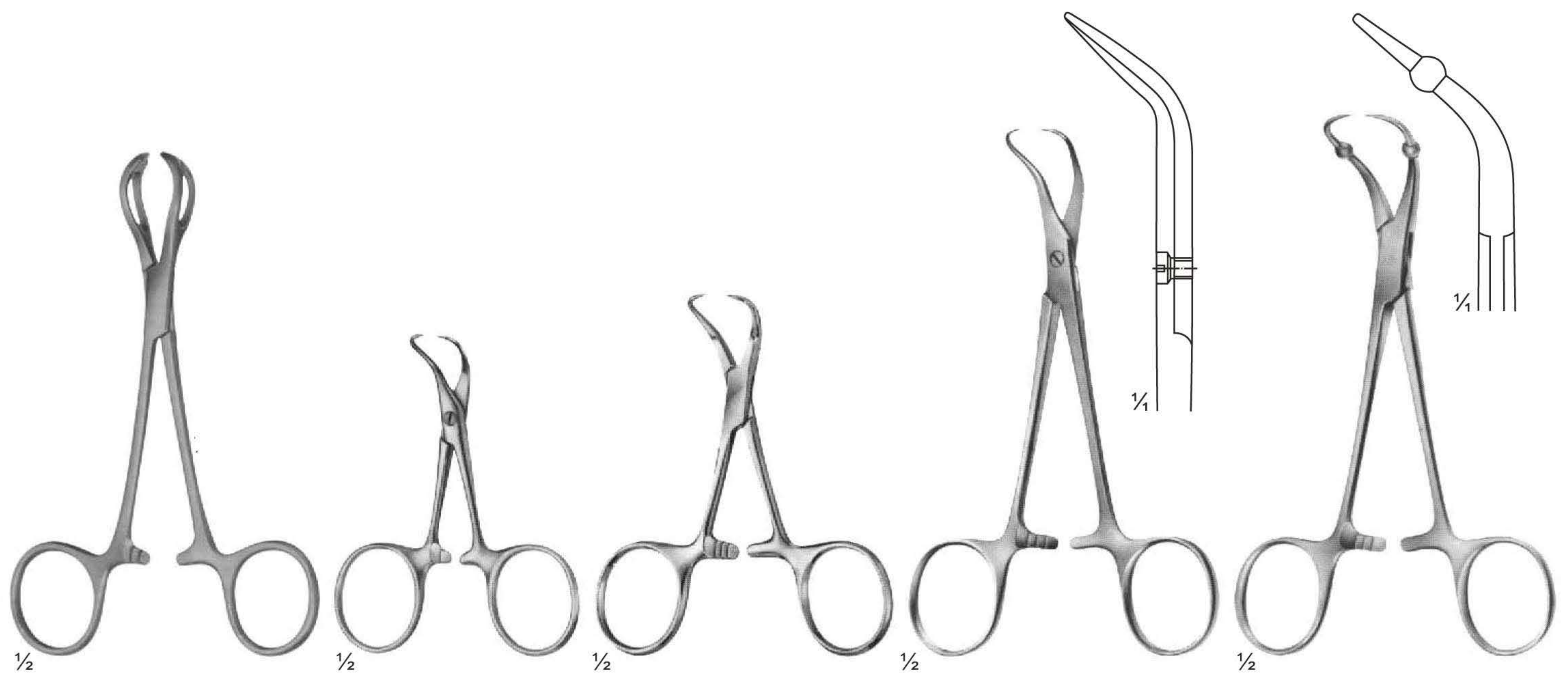

UG-508  
LANE

UG-515  
BACKHAUS

UG-516  
BACKHAUS

UG-517  
BACKHAUS-KOCHER  
135 mm

UG-520  
ROEDER  
135 mm

# Towel Clamps

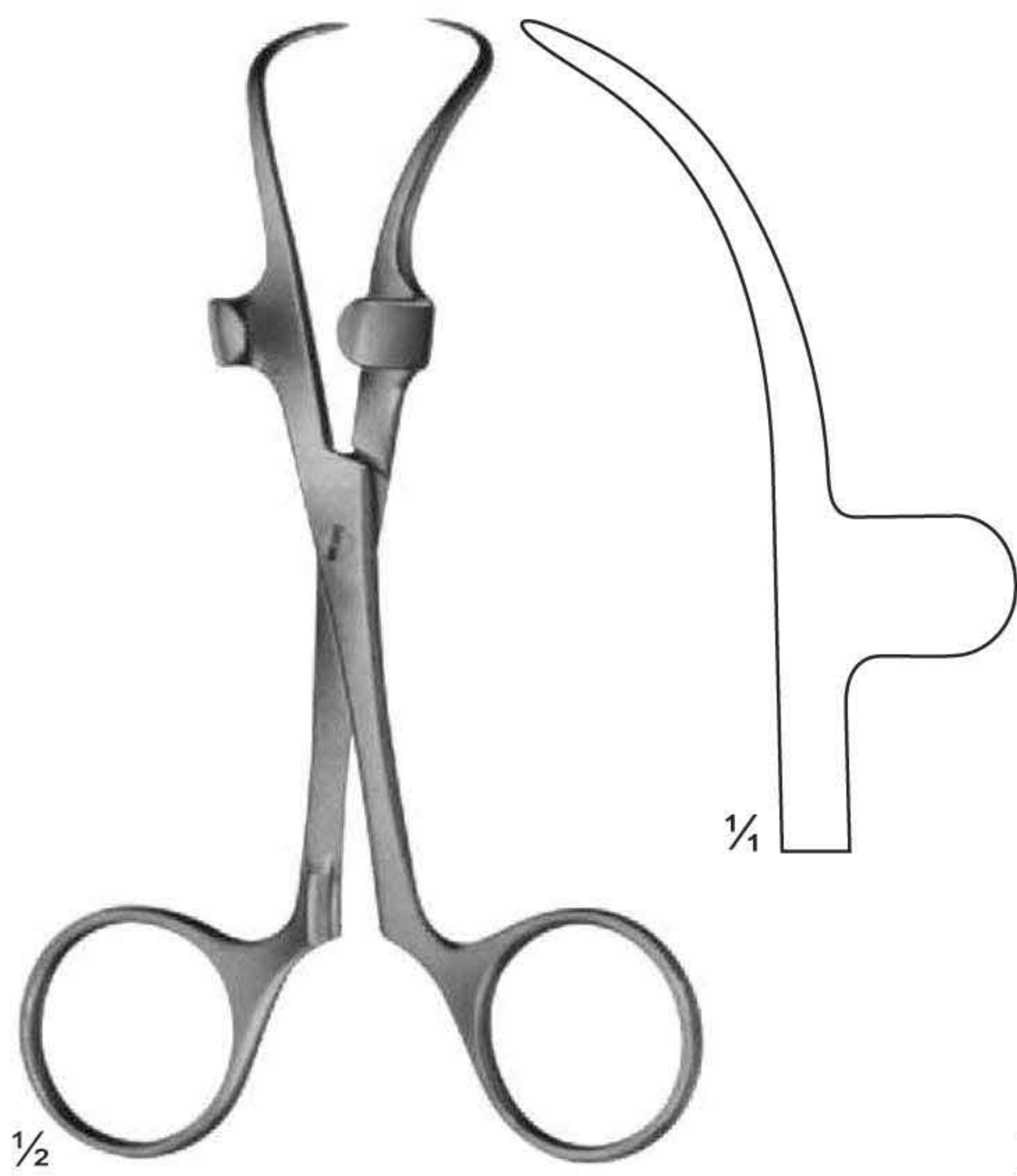

UG-522  
ROBIN  
with holders for tubing  
up to 13 mm  
135 mm

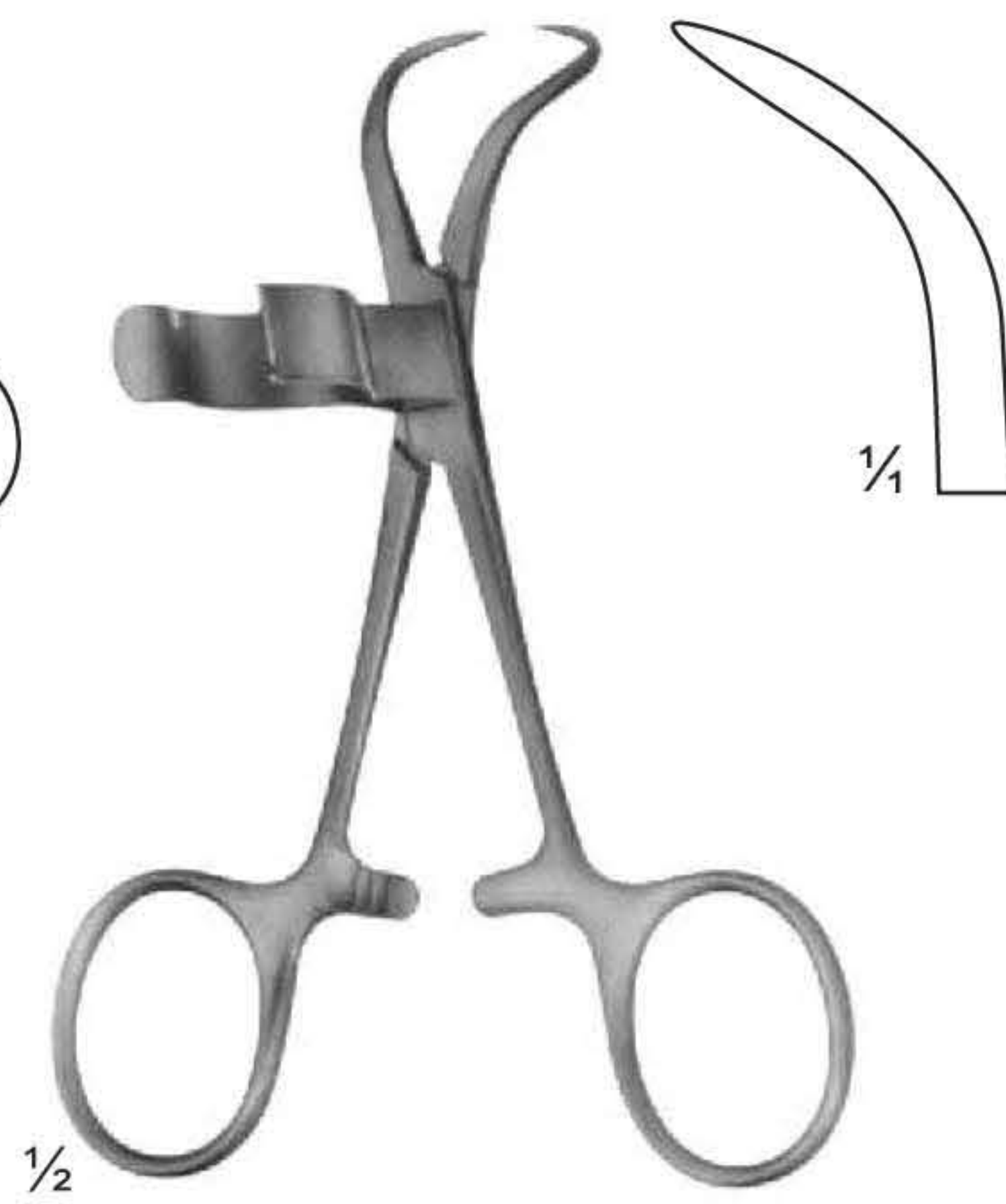

UG-524  
with clip for tubing  
up to 15 mm  
110 mm

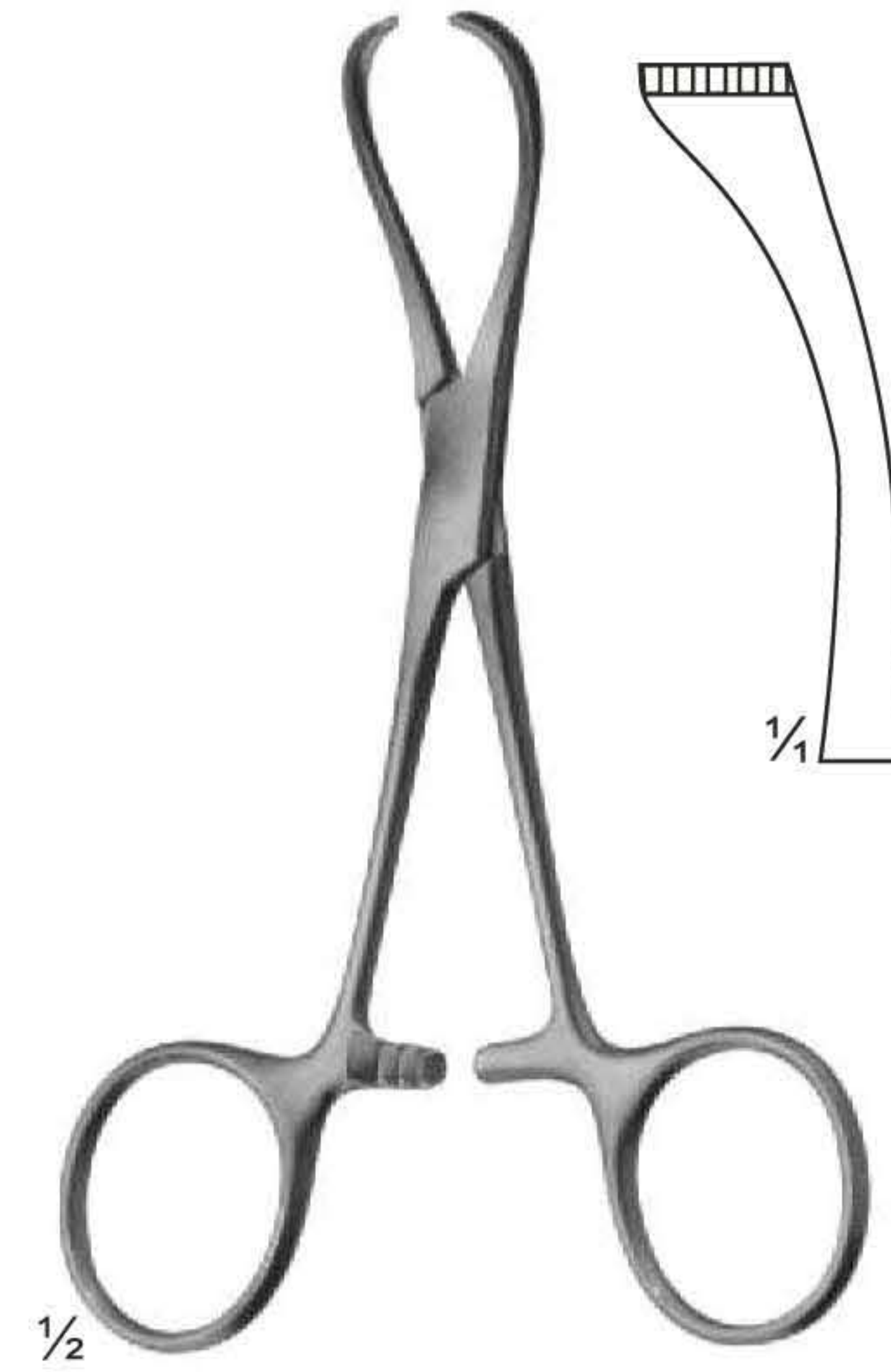

UG-527  
LORNA  
non perforating  
130 mm

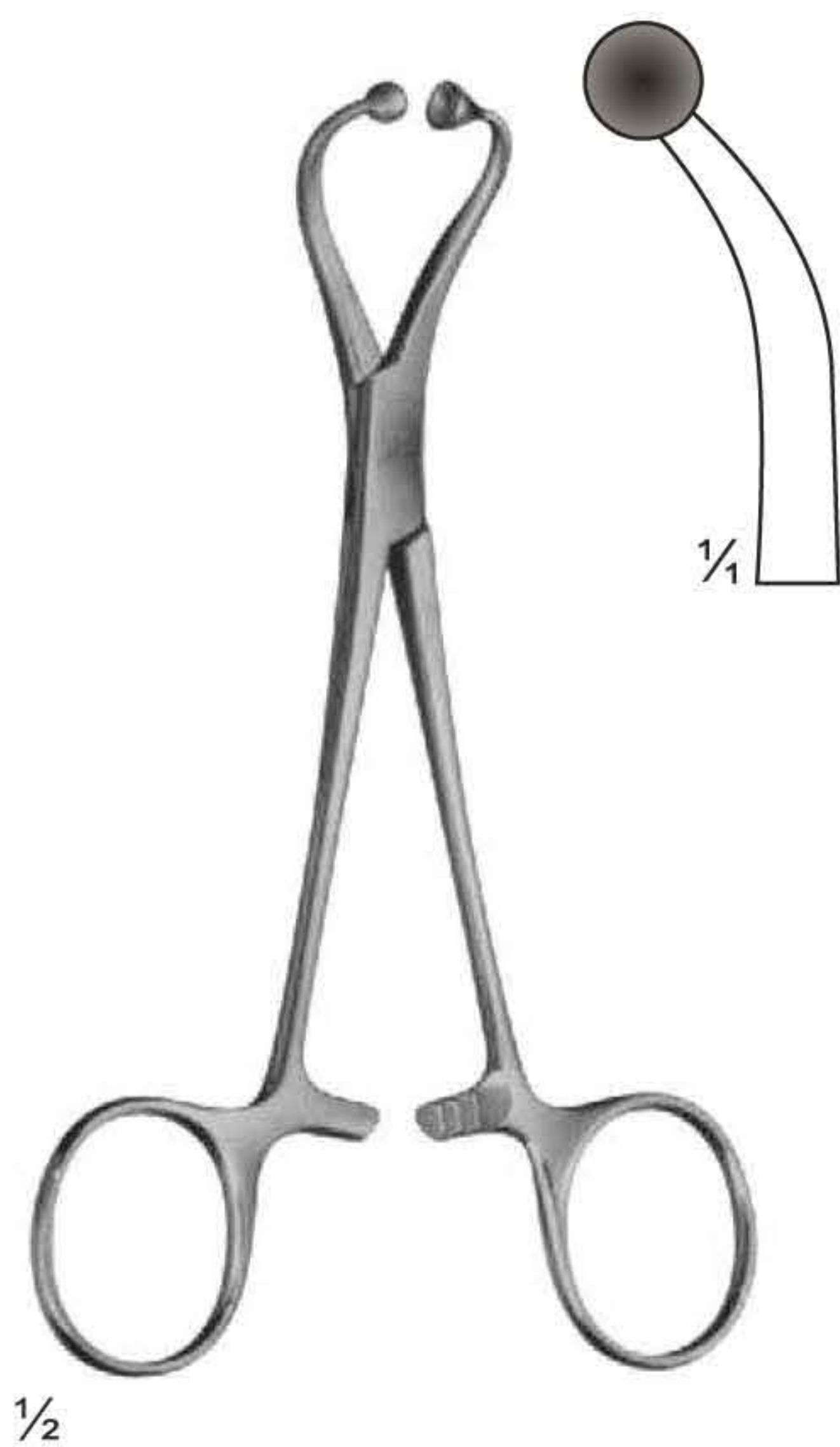

UG-528  
for paper cloths  
140 mm



UG-529  
BUNT  
105 mm



UG-531  
MAYO  
140 mm





# Delicate Haemostatic Forceps



UG-583  
CARREL  
85 mm



UG-584  
BABY-MOSQUITO  
(HARTMANN)  
100 mm



UG-585  
MICRO-HALSTED  
125 mm



UG-586  
HALSTED-MOSQUITO  
125 mm



UG-587  
PROVIDENCE-HOSPITAL  
140 mm



UG-588  
KELLY  
140 mm



UG-589  
DANDY  
Curved sideways  
140 mm

## Delicate Haemostatic Forceps



1/2

UG-591  
BABY-CRILE  
140 mm



1/2

UG-592  
CRILE  
140 mm



1/2

UG-593  
RANKIN  
160 mm



1/2

UG-594  
CRILE  
160 mm



1/2

UG-595  
ADSON  
185 mm



1/2

UG-596  
HALSTED  
185 mm

# Delicate Haemostatic Forceps



½  
UG-597  
HALSTED-MOSQUITO  
200 mm



½  
UG-598  
HEISS  
200 mm



½  
UG-599  
HALSTED  
215 mm



½  
UG-600  
BENGOLEA  
245 mm



½  
UG-601  
CRAFOORD  
245 mm

# Haemostatic Forceps

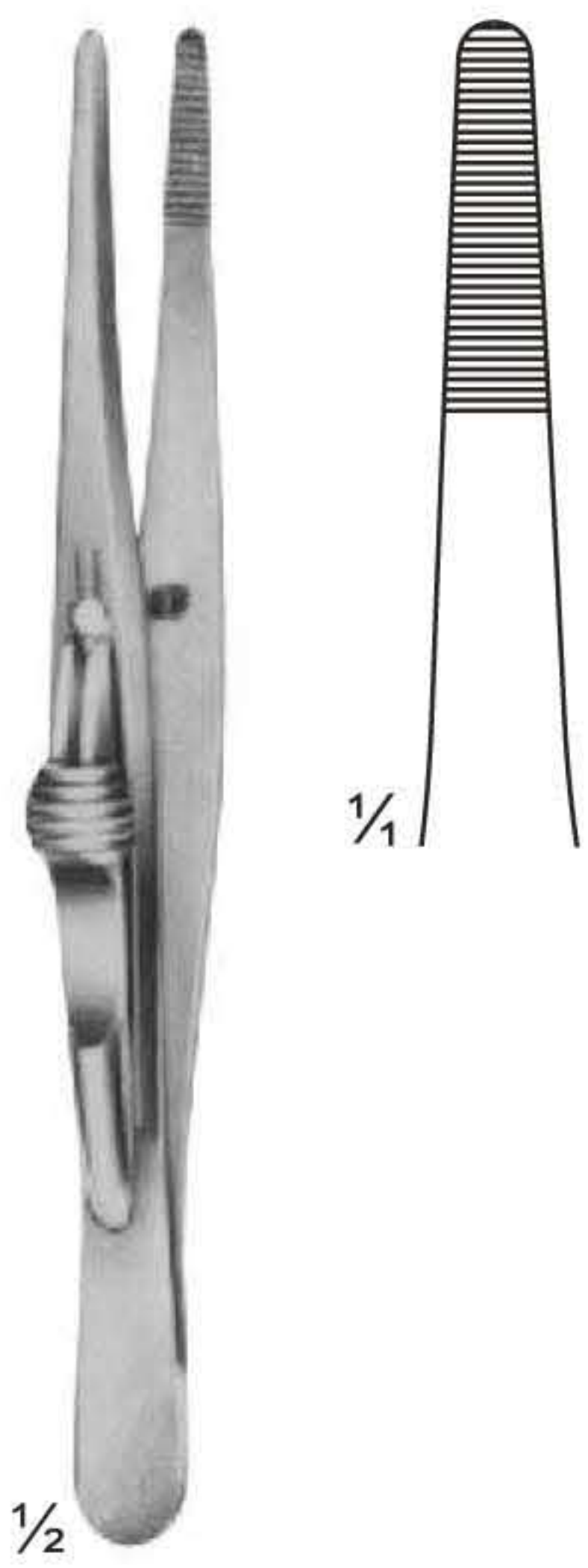

UG-602  
FRICKE  
Artery forceps  
130 mm

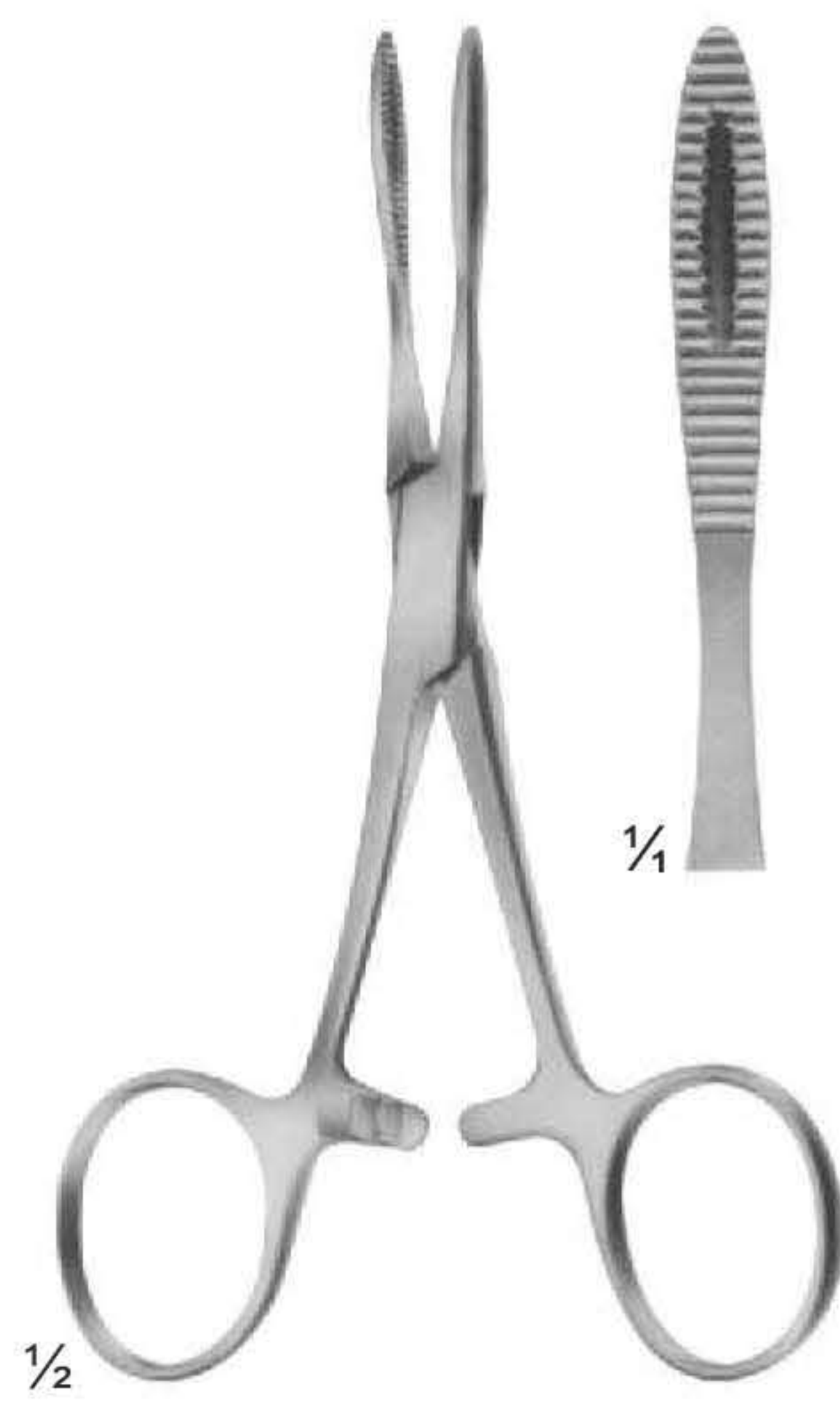

UG-603  
KRONLEIN  
130 mm

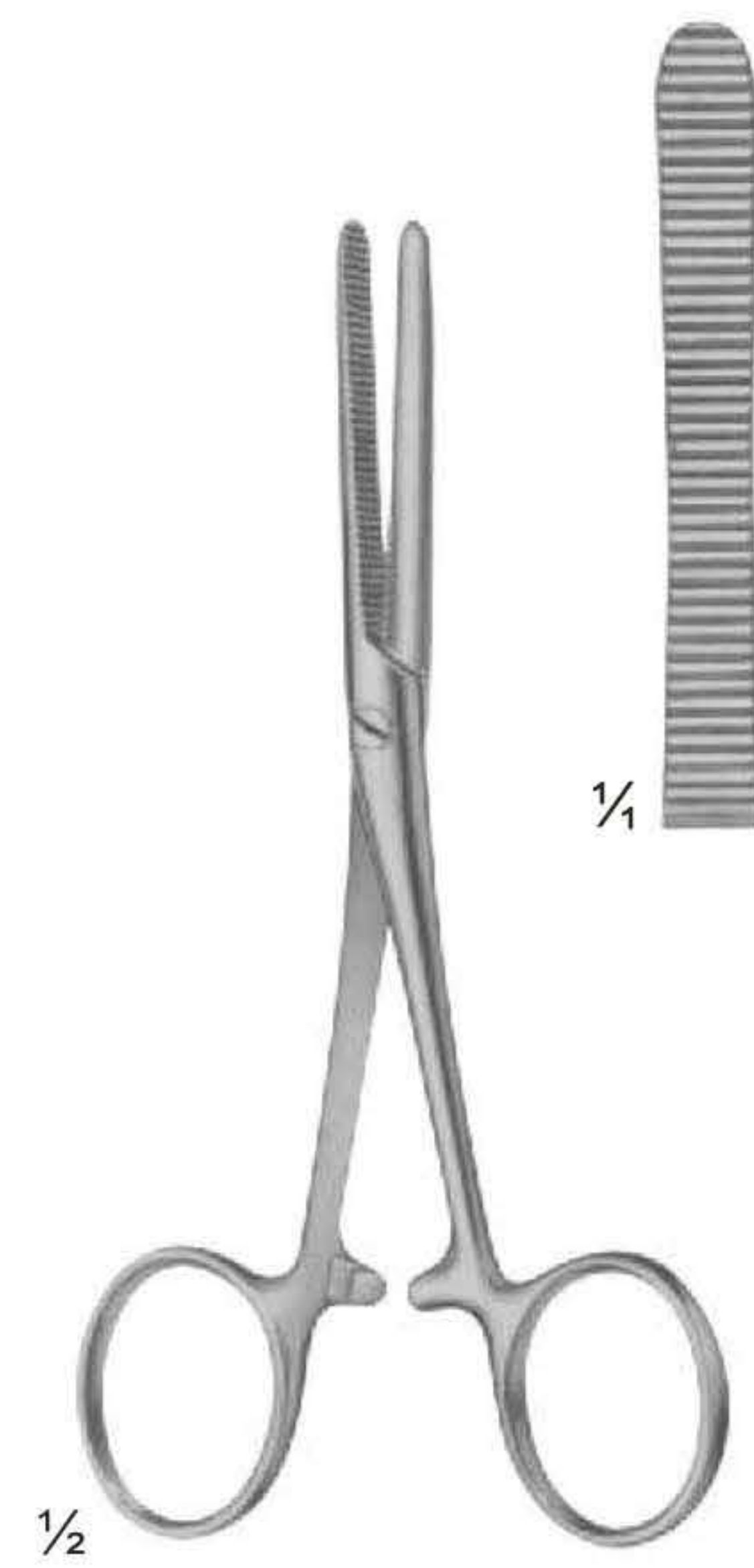

UG-604  
PEAN  
125 mm



UG-605  
PEAN

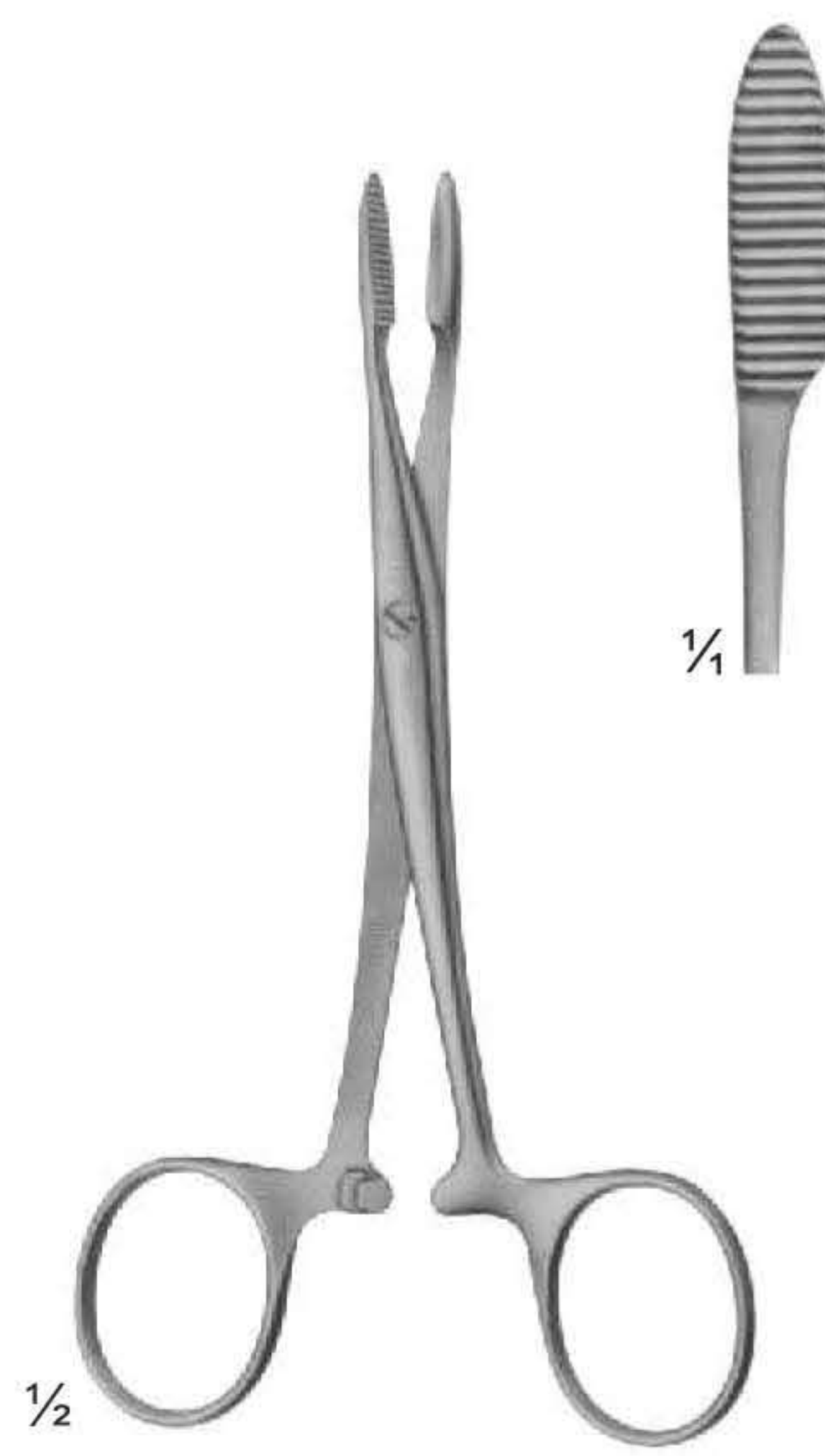

UG-606  
PEAN

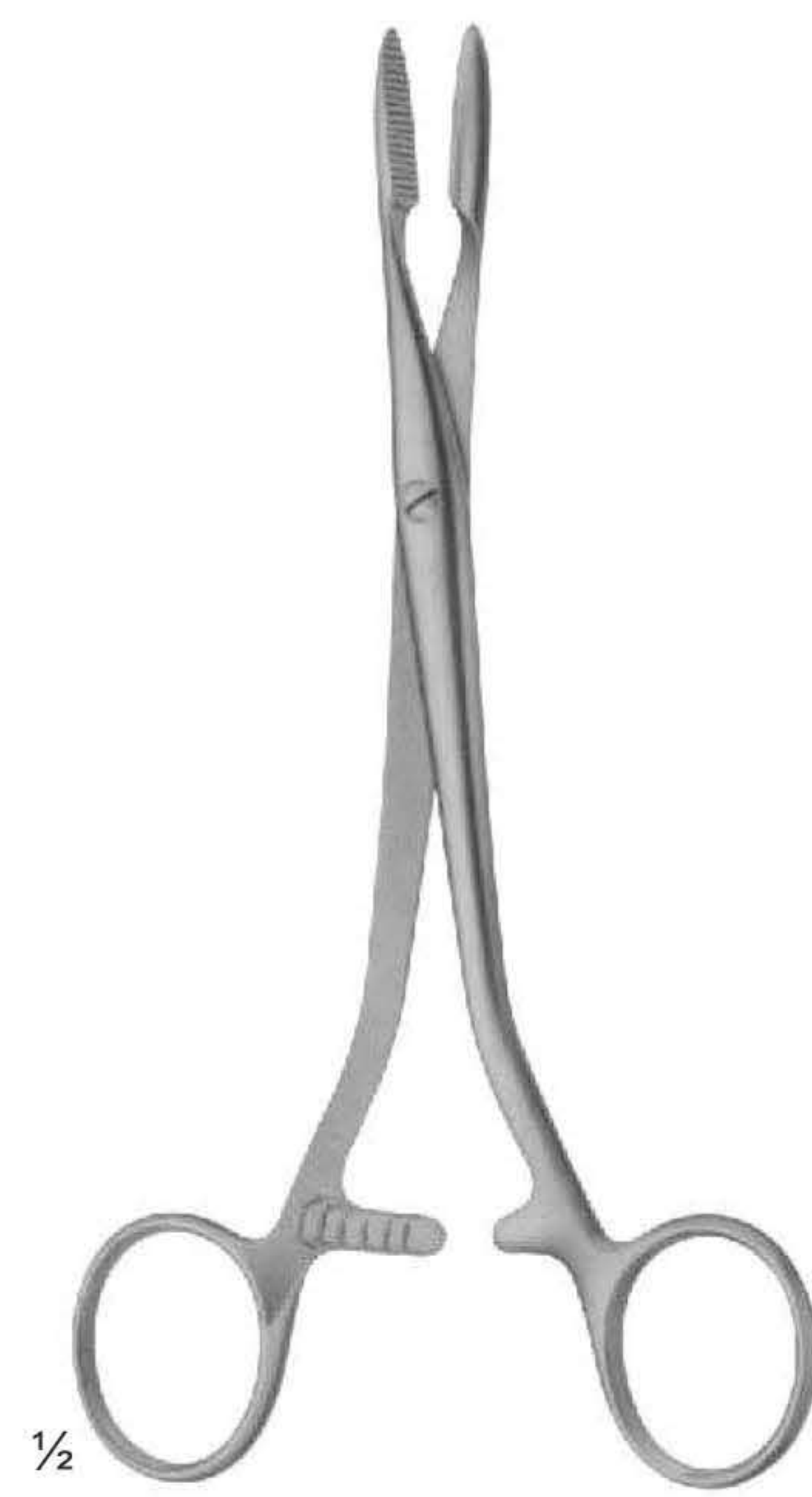

UG-607  
PEAN

# Haemostatic Forceps

---



UG-608  
PEAN  
Slender type



UG-609  
SPENCER-WELLS  
Slender type



UG-613  
ROCHESTER-PEAN

# Haemostatic Forceps



UG-616  
PEAN

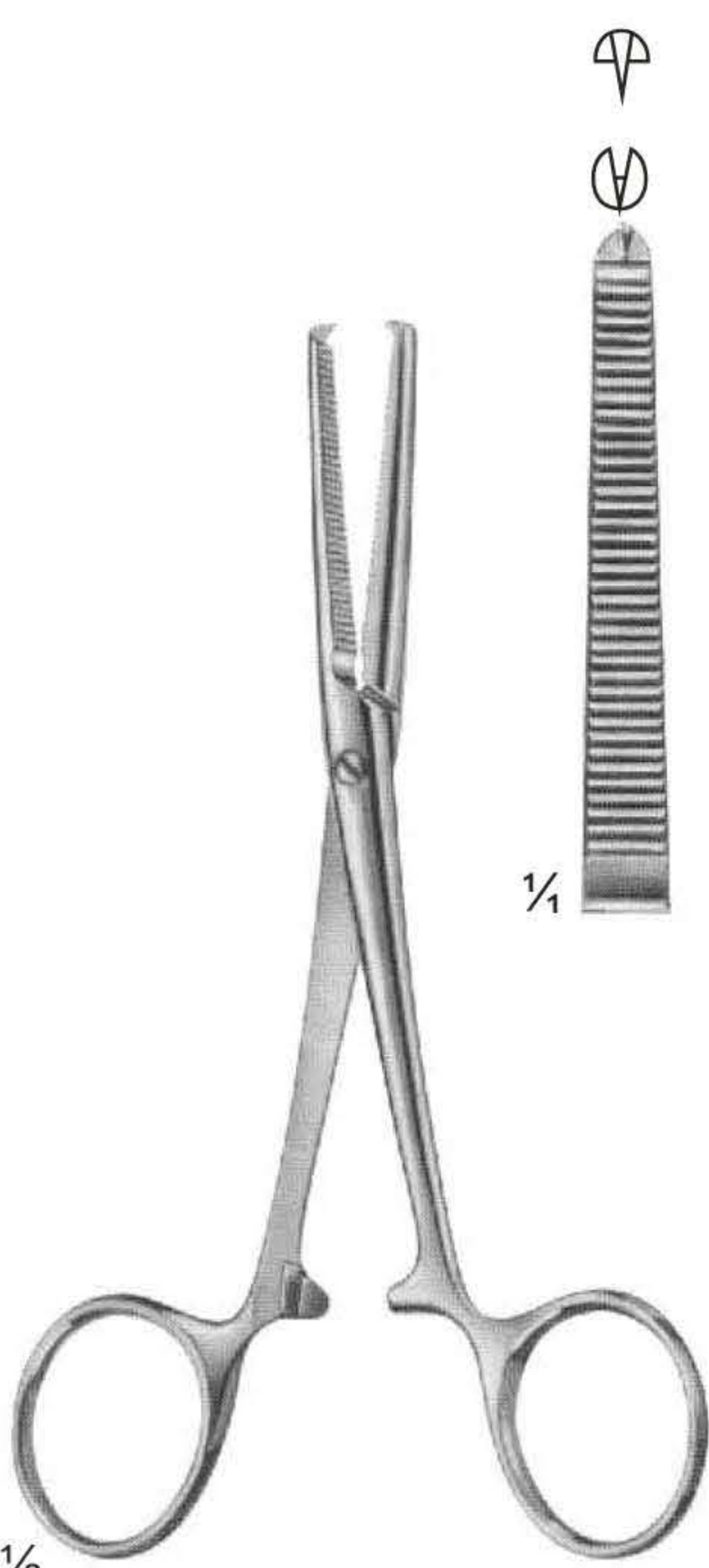

UG-621  
KOCHER  
Strong Pattern  
145 mm



UG-622  
KOCHER



UG-625  
ROCHESTER-OCHSNER  
140 mm

# Haemostatic Forceps

---



UG-627  
KOCHER-OCHSNER



# Haemostatic Forceps, Special Pattern, Tonsil Forceps



UG-632  
ROCHESTER-CARMALT

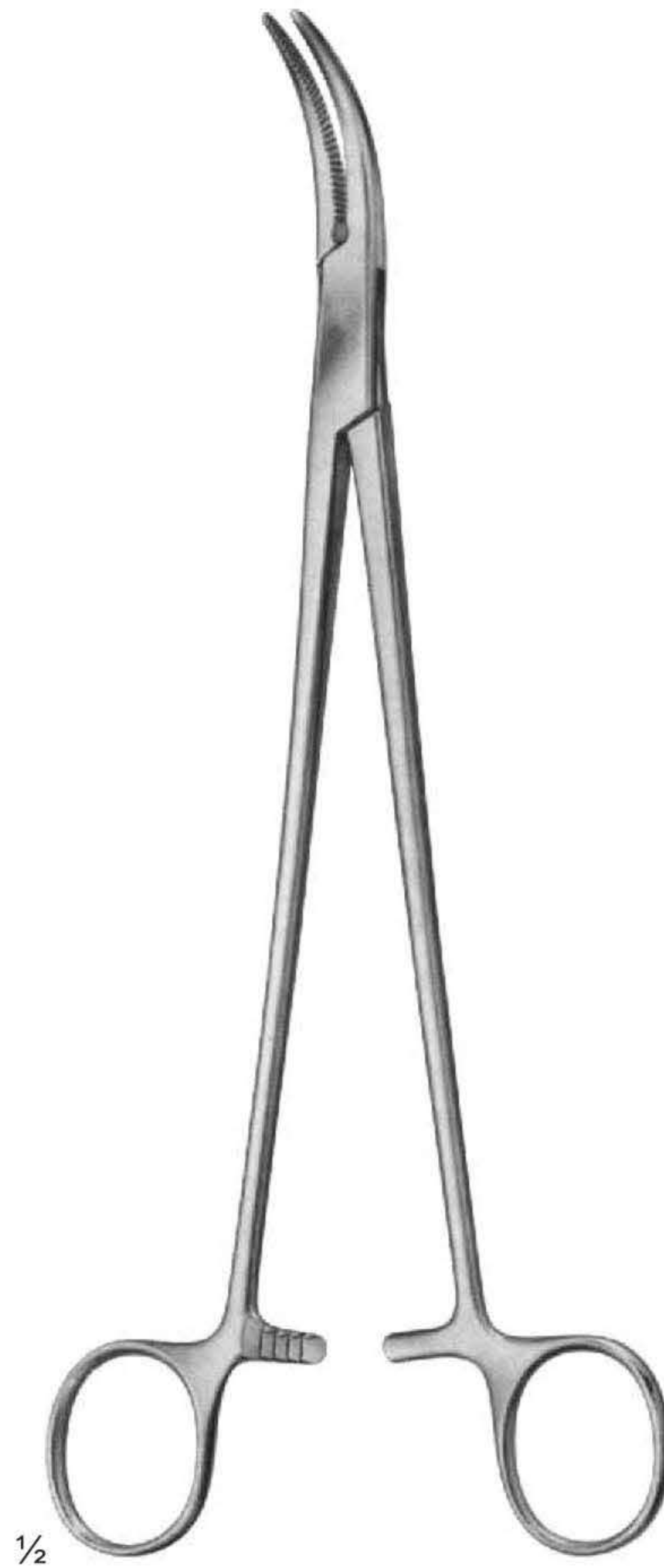

UG-634  
MOYNIHAN



UG-637  
PEAN



UG-640  
NEGUS  
190 mm

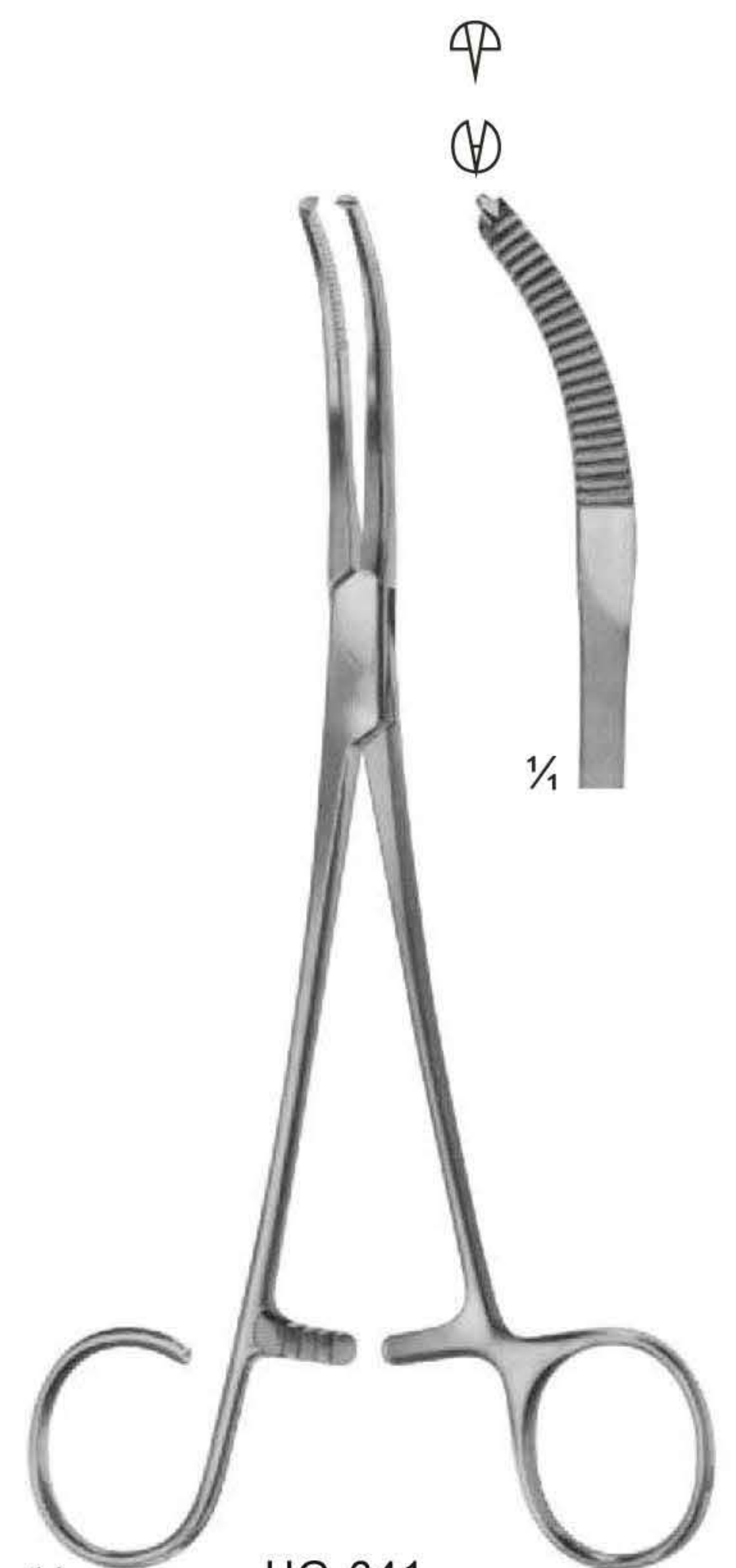

UG-641  
MIKULICZ  
185 mm

## Dissecting- and Ligature Forceps

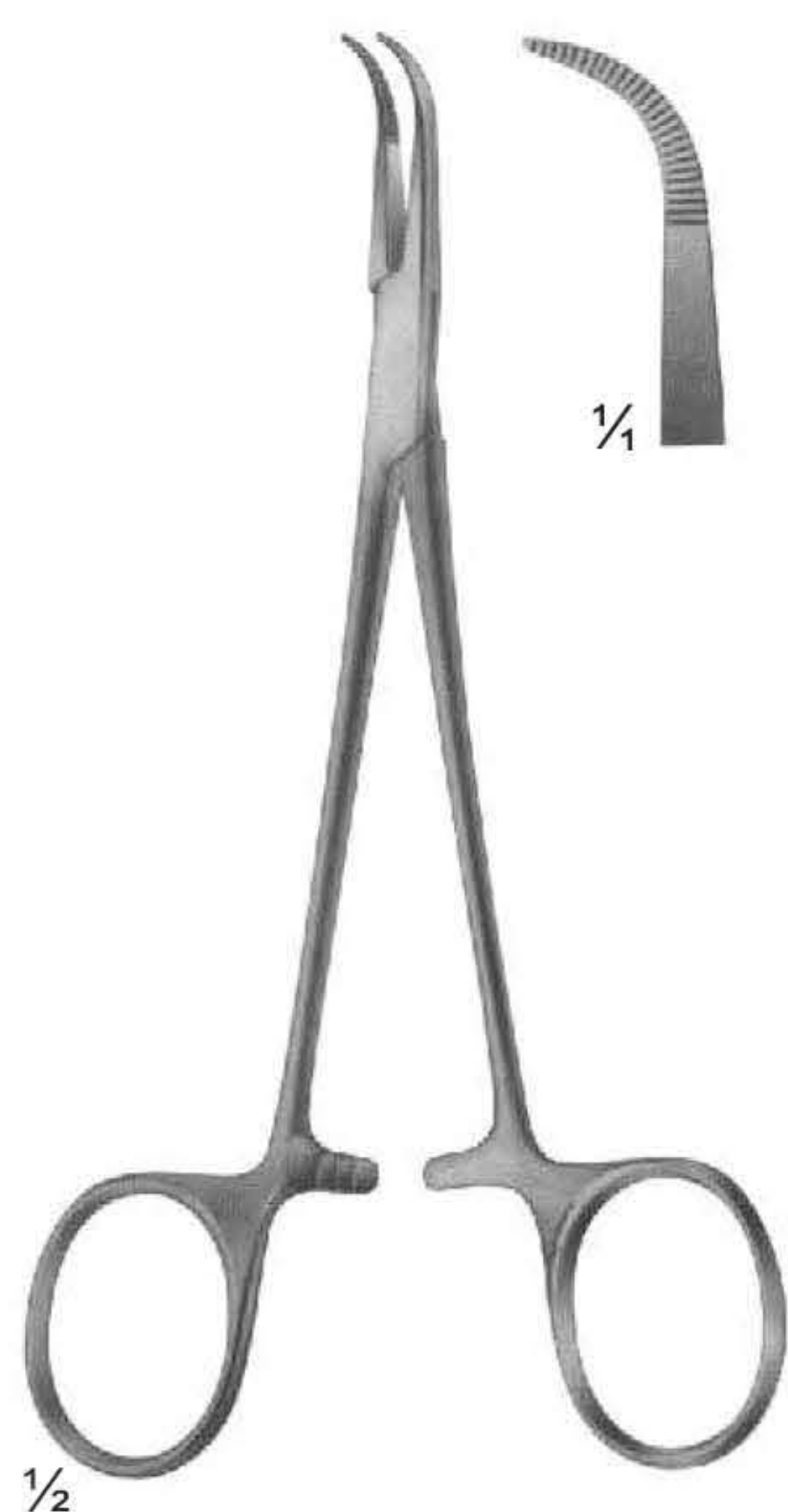

UG-643  
MICRO-ADSON  
140 mm

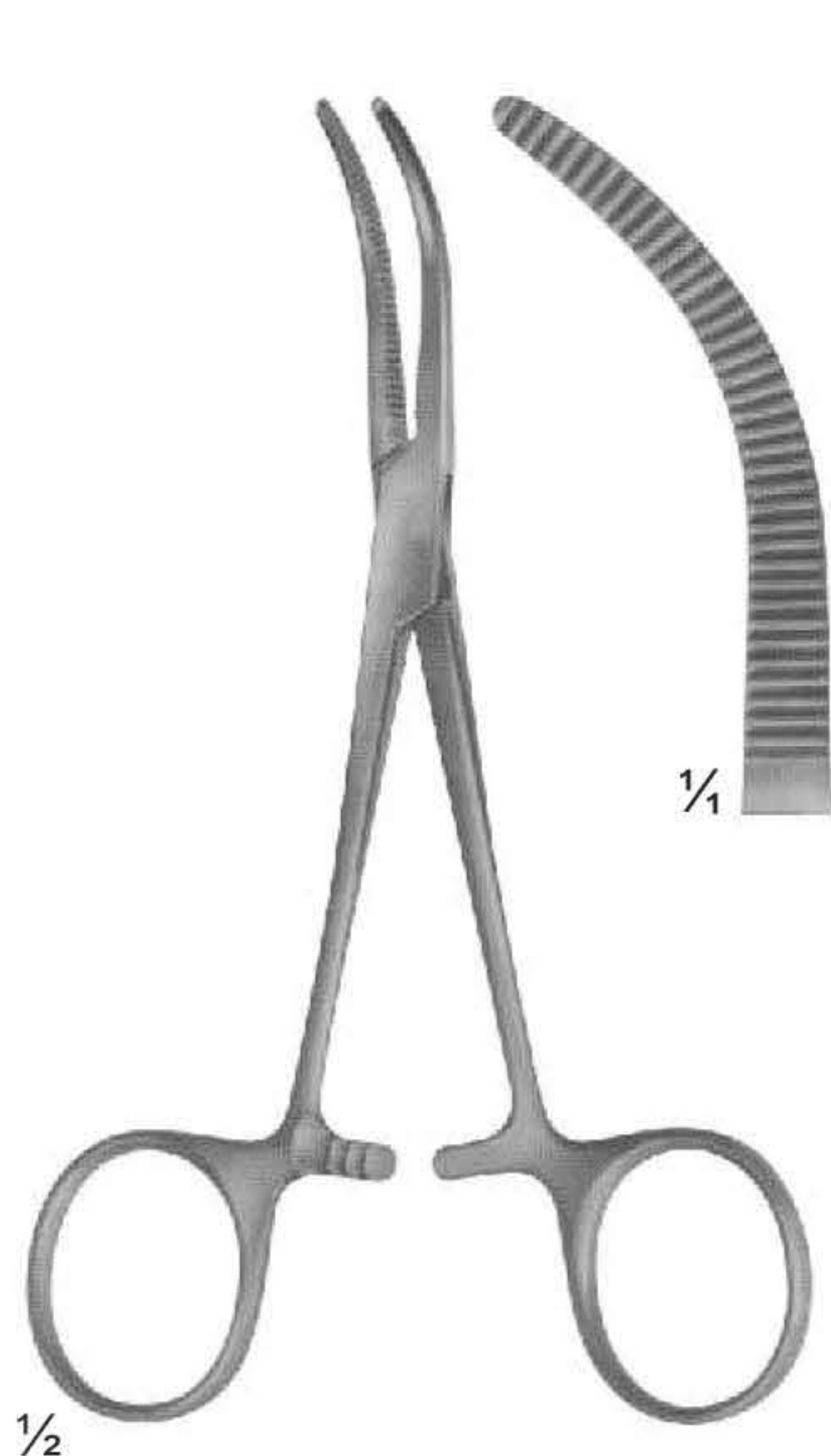

UG-645  
BABY-OVERHOLT  
135 mm



UG-647  
BABY-MIXTER

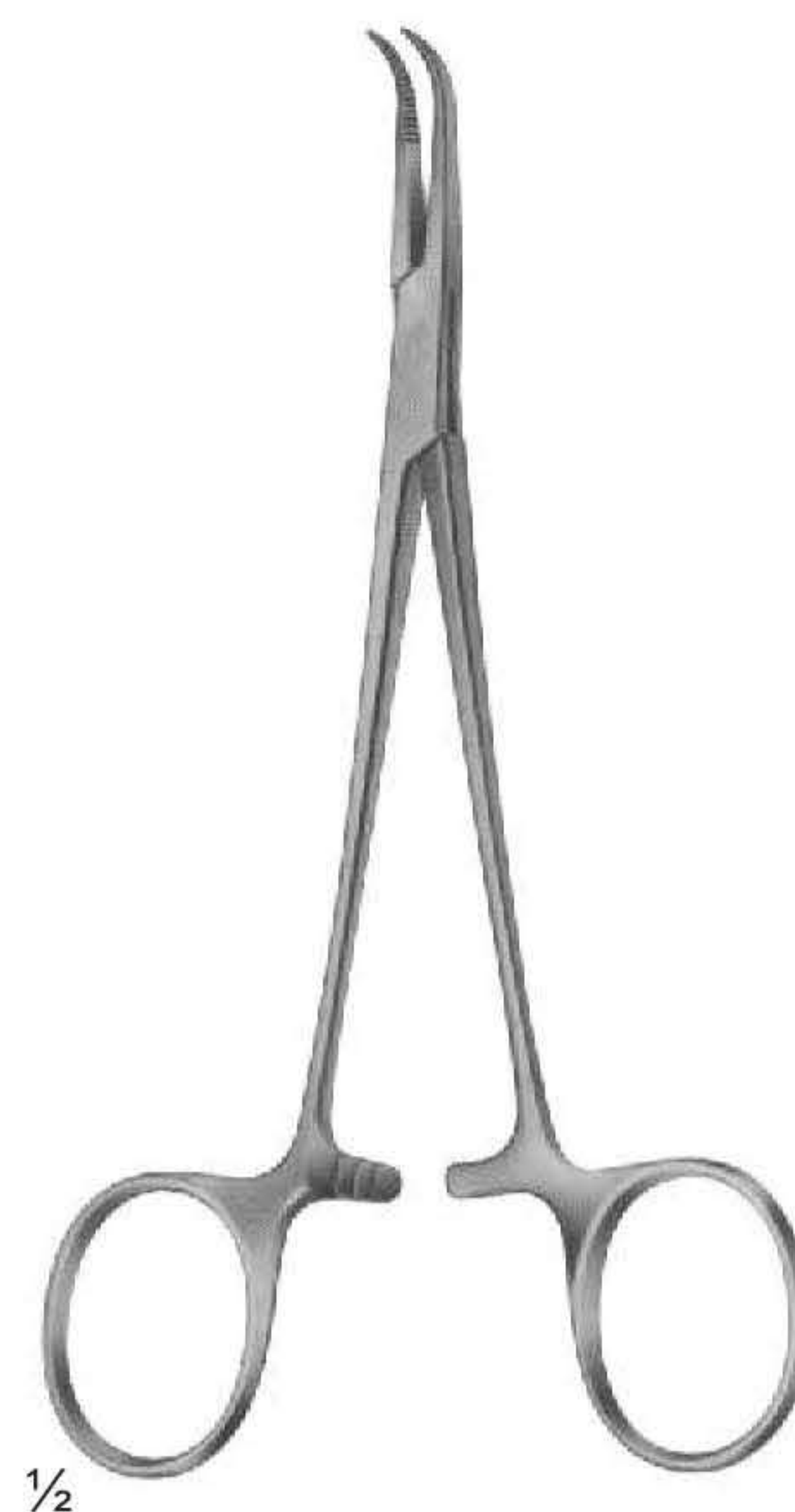

UG-648  
BABY-ADSON



UG-652  
NISSEN



UG-653  
YASARGIL  
195 mm



UG-654  
OVERHOLT-MIXTER

# Dissecting- and Ligature Forceps

---



1/2

UG-655  
OVERHOLT-GEISSENDOERFER

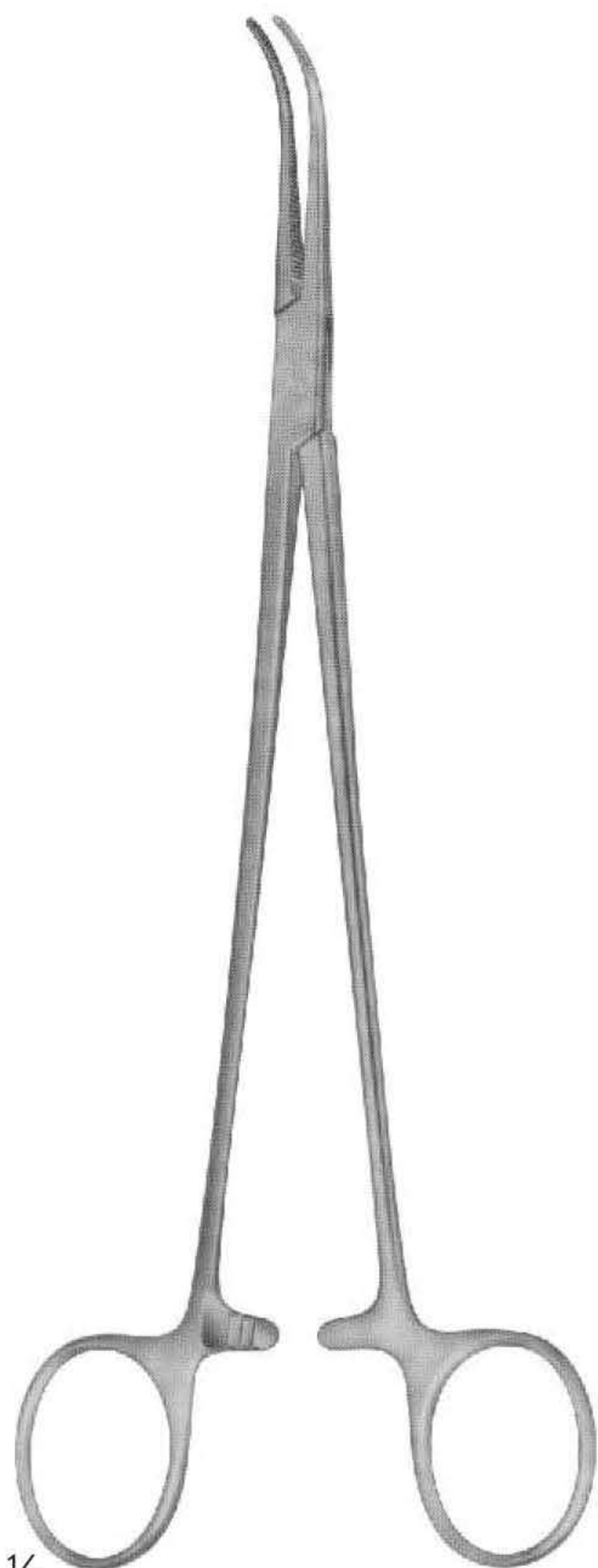

1/2

UG-663  
OVERHOLT  
fine pattern

# Dissecting- and Ligature Forceps

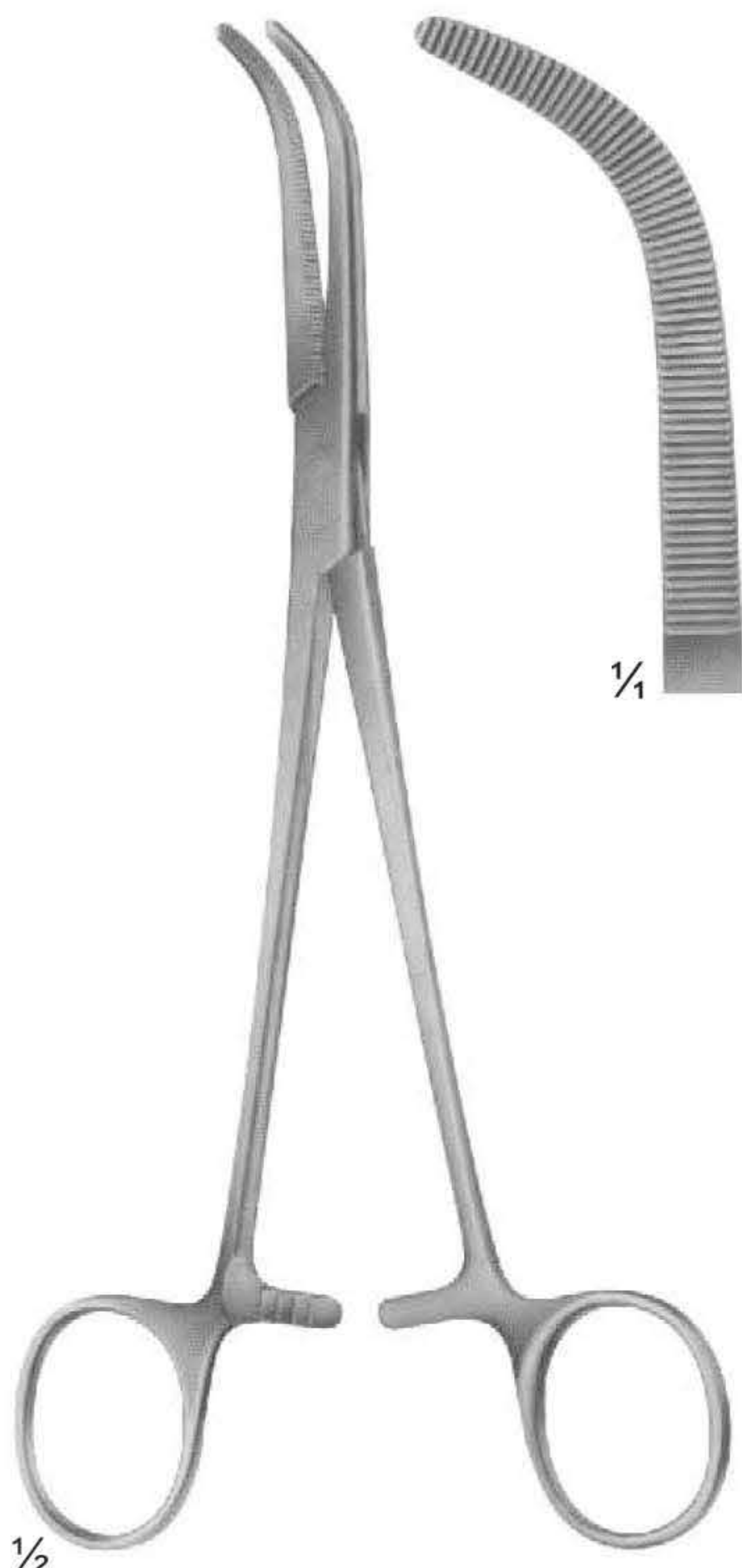

$\frac{1}{2}$   
UG-669  
MIXTER-O'SHAUGHNESSY  
190 mm

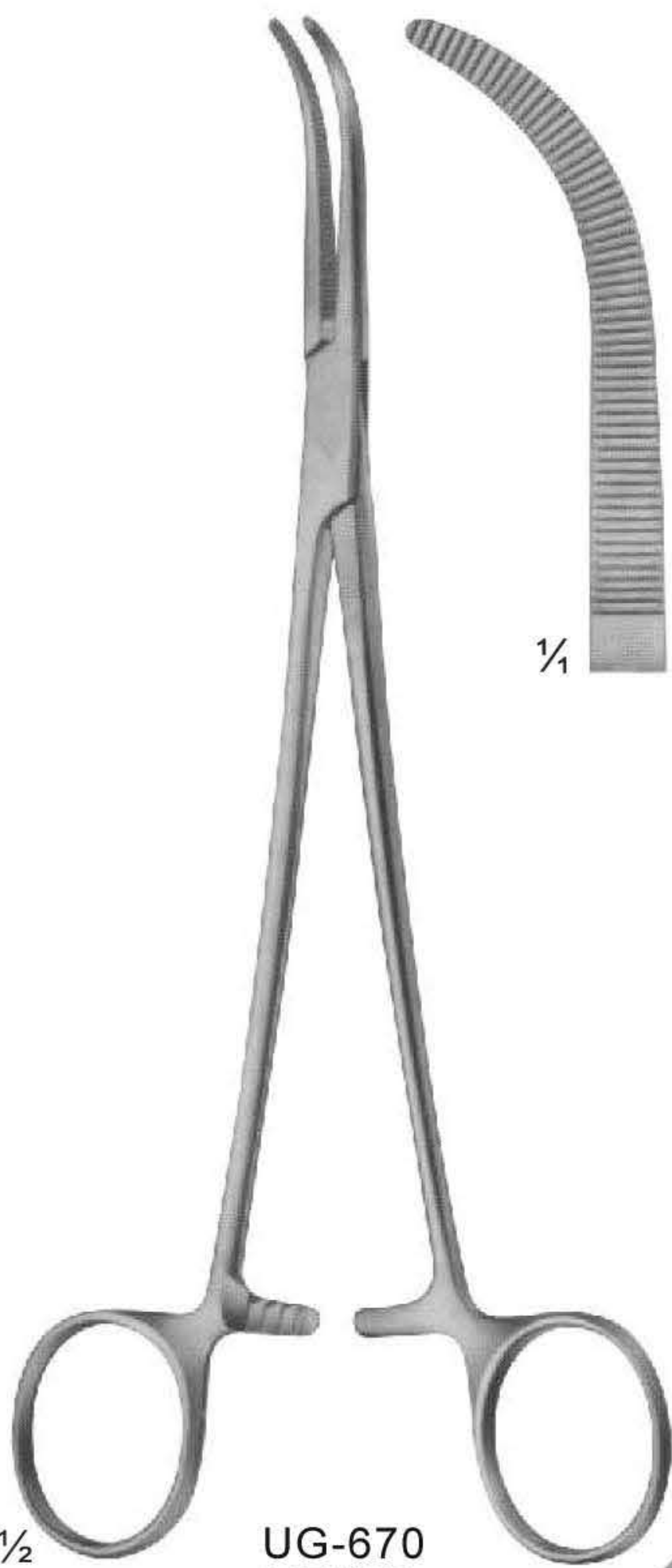

$\frac{1}{2}$   
UG-670  
HEISS  
195 mm



$\frac{1}{2}$   
UG-671  
RUMEL  
240 mm

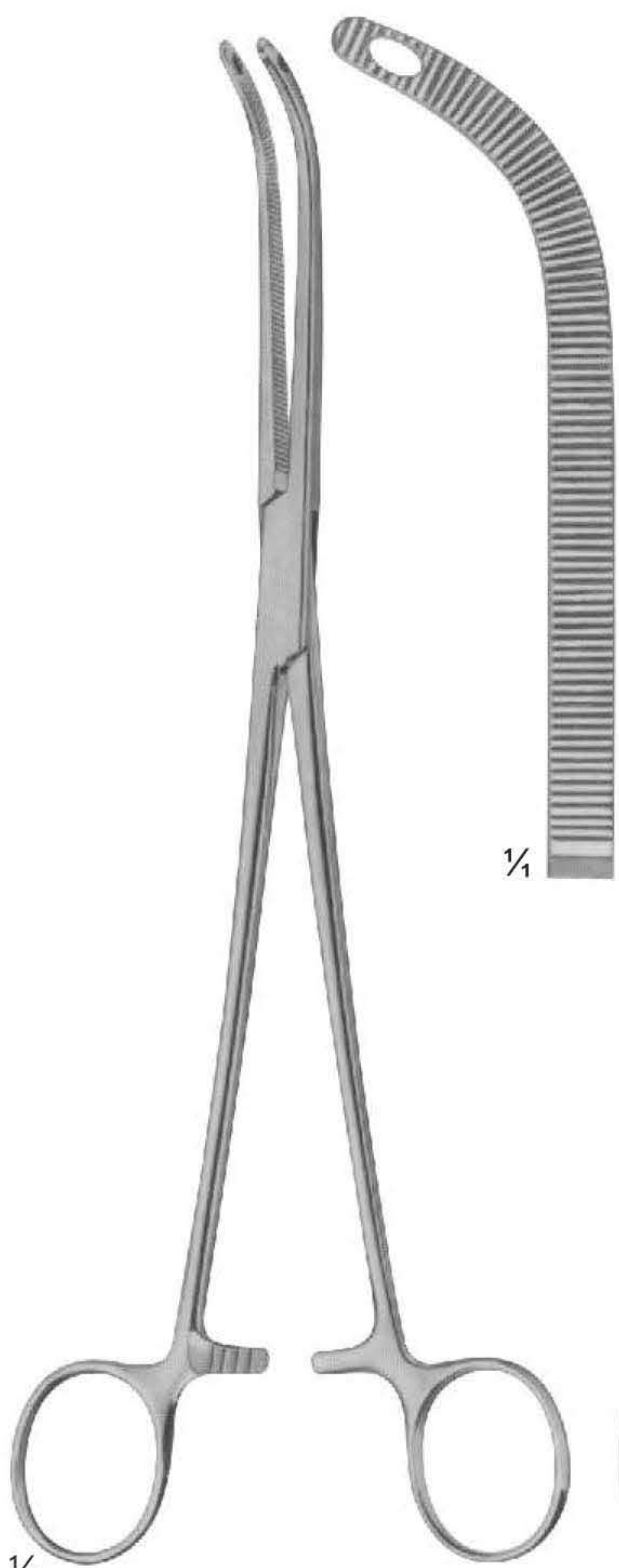

$\frac{1}{2}$   
UG-673  
FINOCHIETTO  
245 mm

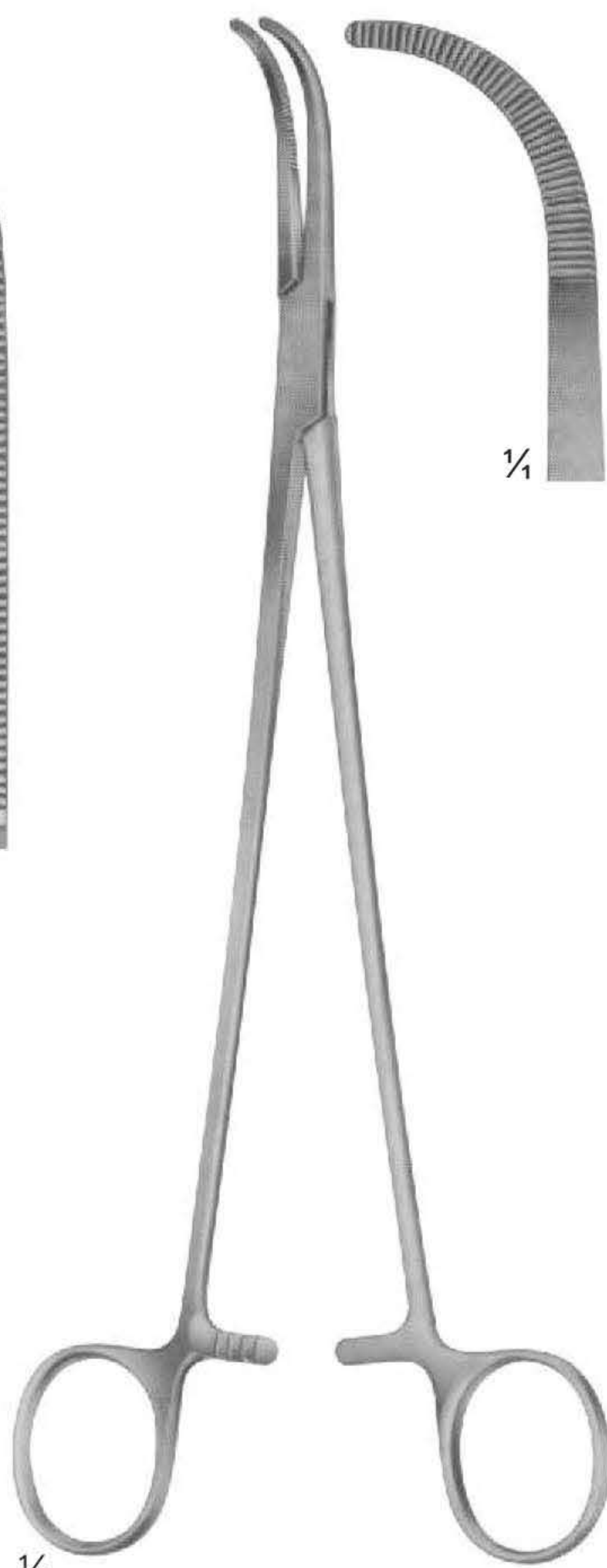

$\frac{1}{2}$   
UG-674  
MIXTER  
230 mm



$\frac{1}{3}$   
UG-675  
LAWRENCE  
270 mm



$\frac{1}{3}$   
UG-676  
ZENKER

# Dissecting- and Ligature Forceps



1/2 UG-679  
LOWER



1/2 UG-683  
LAHEY (SWEET)



1/2 UG-685  
MIXTER



1/2 UG-686  
DESJARDINS



1/2 UG-688  
GRAY

# Peritoneum Forceps

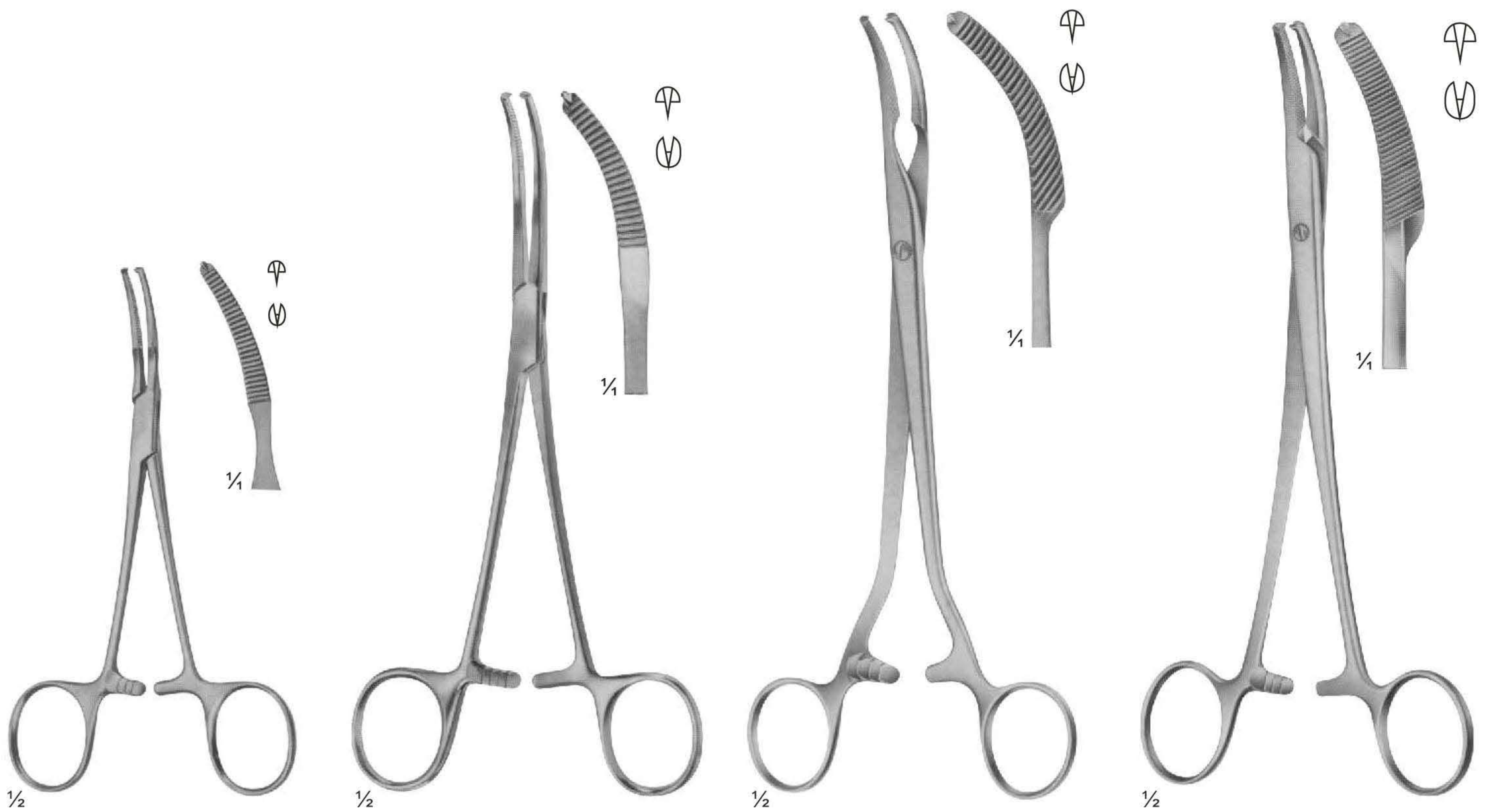

UG-689  
BABY-MIKULICZ  
140 mm

UG-690  
MIKULICZ  
185 mm

UG-691  
MIKULICZ  
205 mm

UG-692  
MIKULICZ  
200 mm

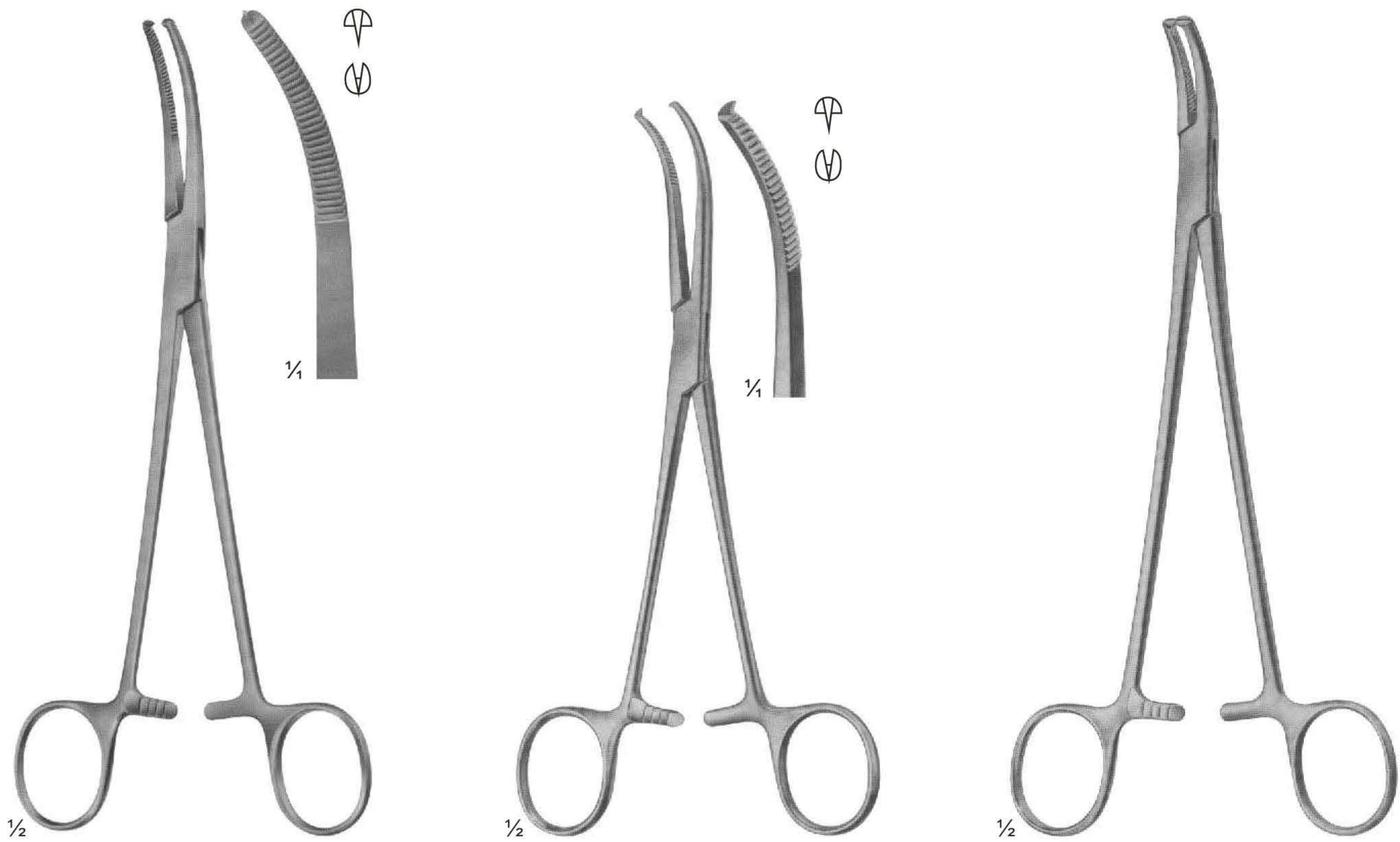

UG-693  
MIKULICZ  
205 mm

UG-694  
MIKULICZ  
185 mm

UG-695  
FAURE  
205 mm

# Hysterectomy Forceps



1/2  
UG-696  
PHANEUF



1/2  
UG-697  
HEANEY modif.



1/2  
UG-698  
HEANEY

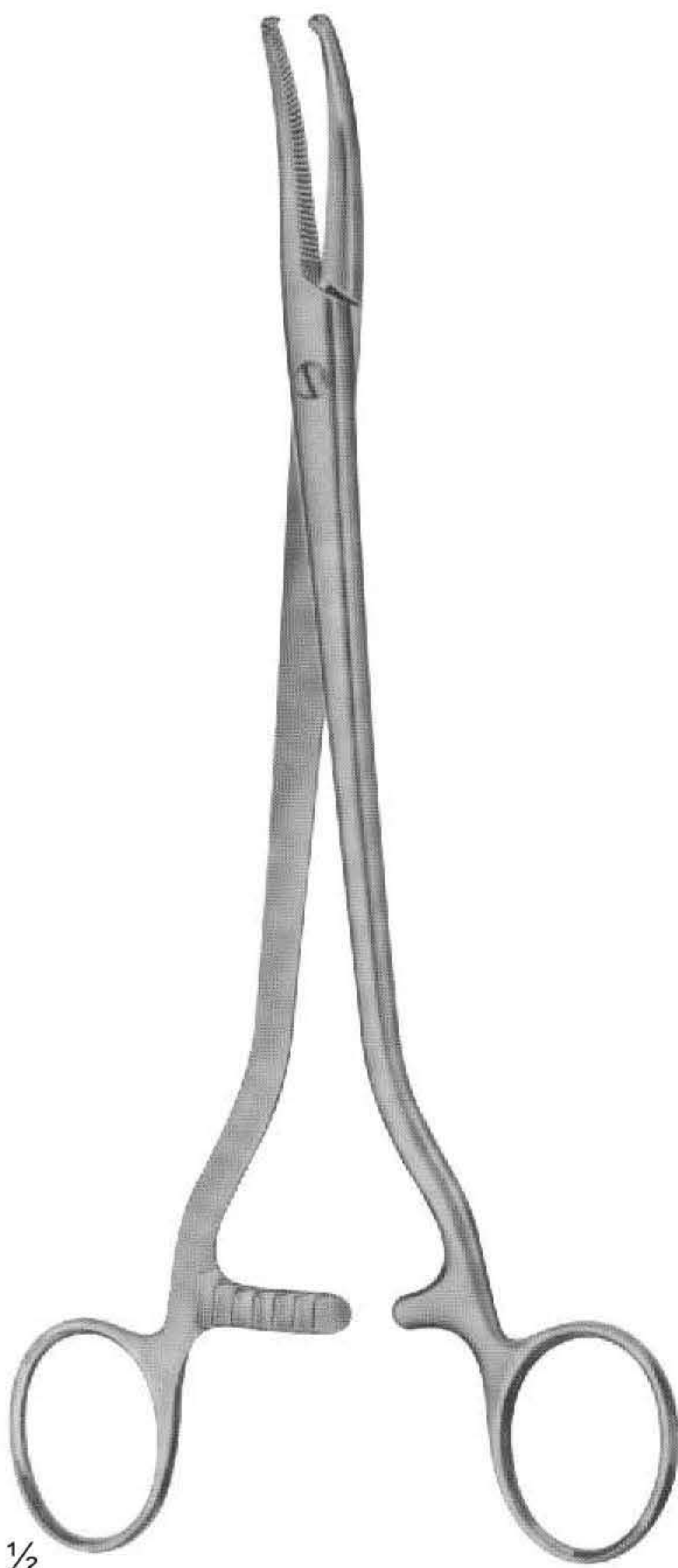

1/2  
UG-699  
WERTHEIM

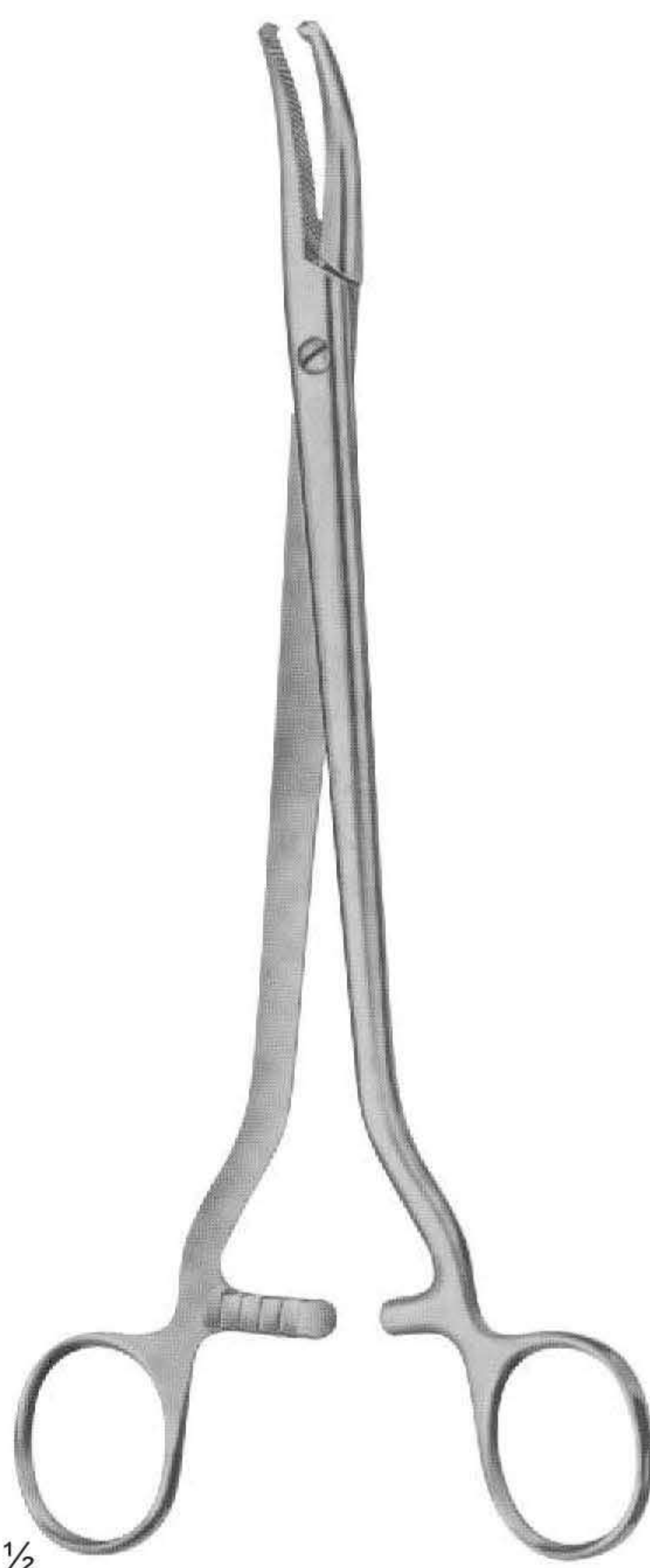

1/2  
UG-700  
WERTHEIM



1/2  
UG-701  
WERTHEIM

# Hysterectomy Forceps and Vaginal Clamps





# Hysterectomy Forceps and Vaginal Clamps and Compression Forceps



UG-704  
WERTHEIM  
Hysterectomy Forceps  
255 mm

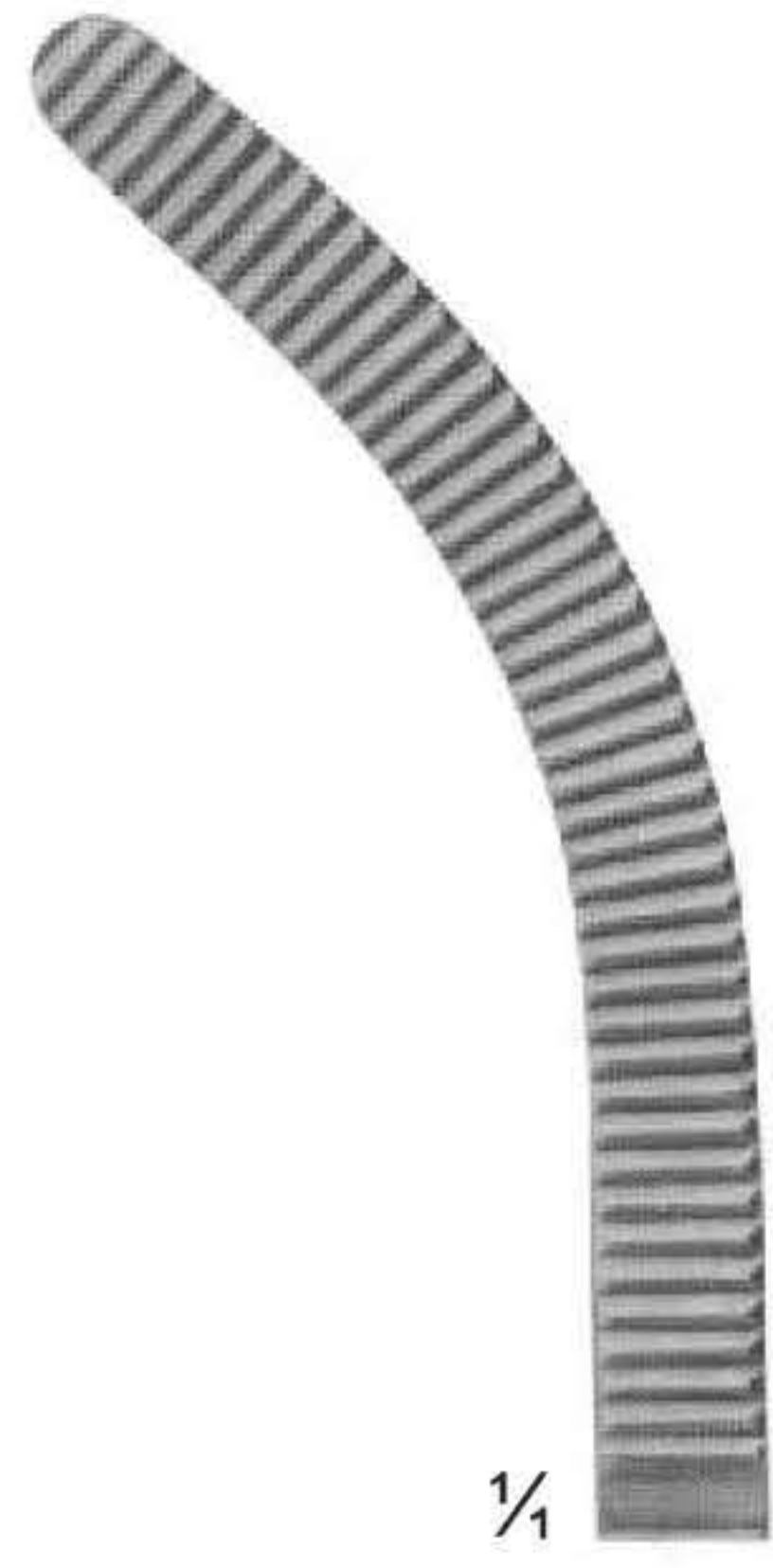

1/4

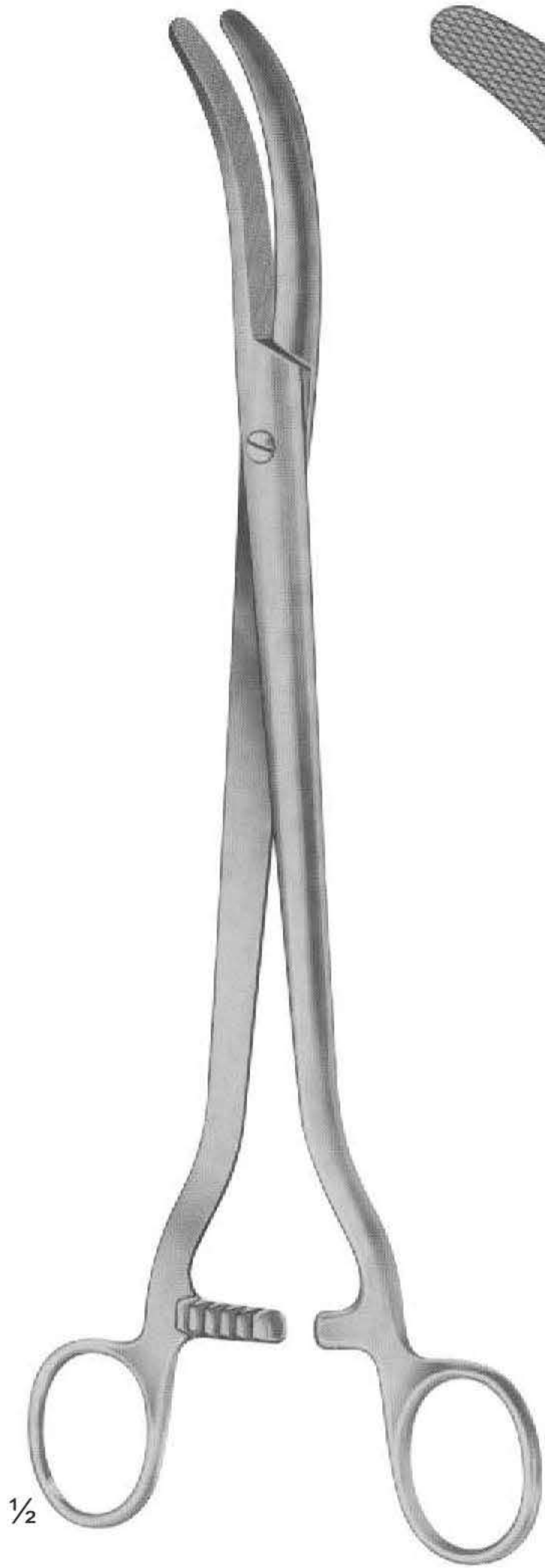

UG-705  
WERTHEIM  
Parametrium Clamp  
260 mm

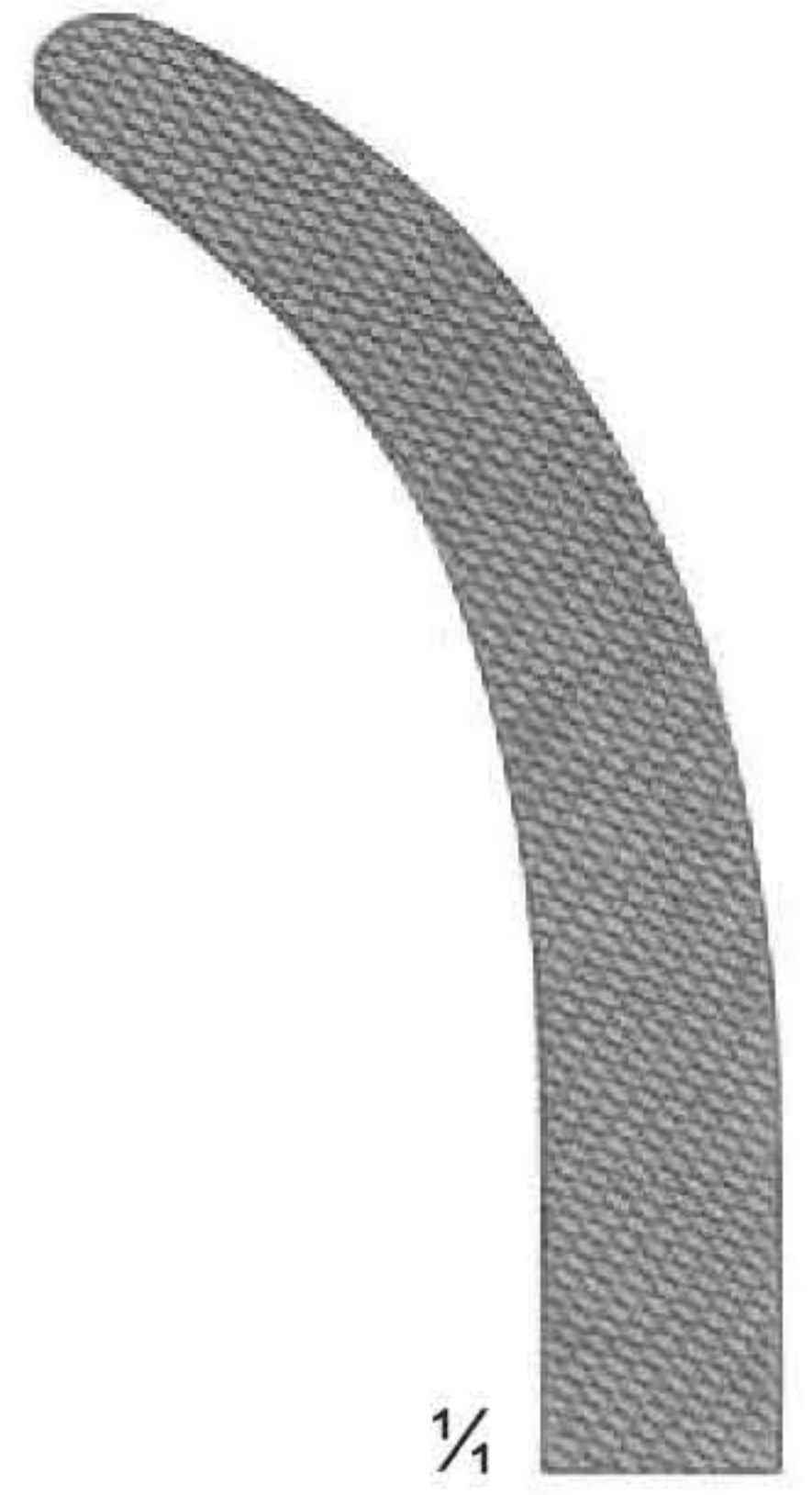

1/4

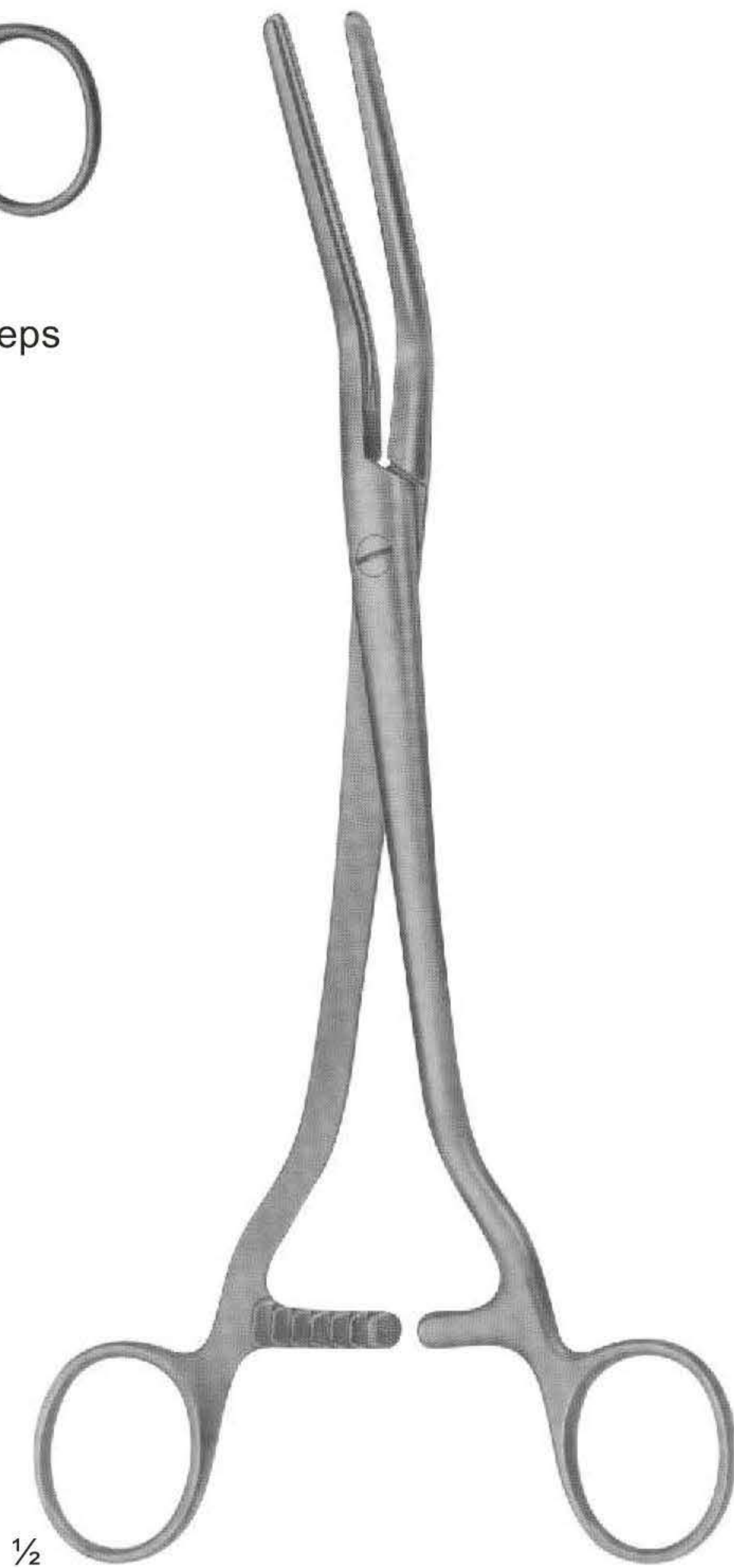

1/2

UG-706  
DICK

# Hysterectomy Forceps and Vaginal Clamps and Compression Forceps



# Needle Holders For Micro Surgery



**UG-242**  
ROHRSCHEIDER  
With copper inserts  
100 mm



**UG-243**  
KALT  
With catch  
135 mm

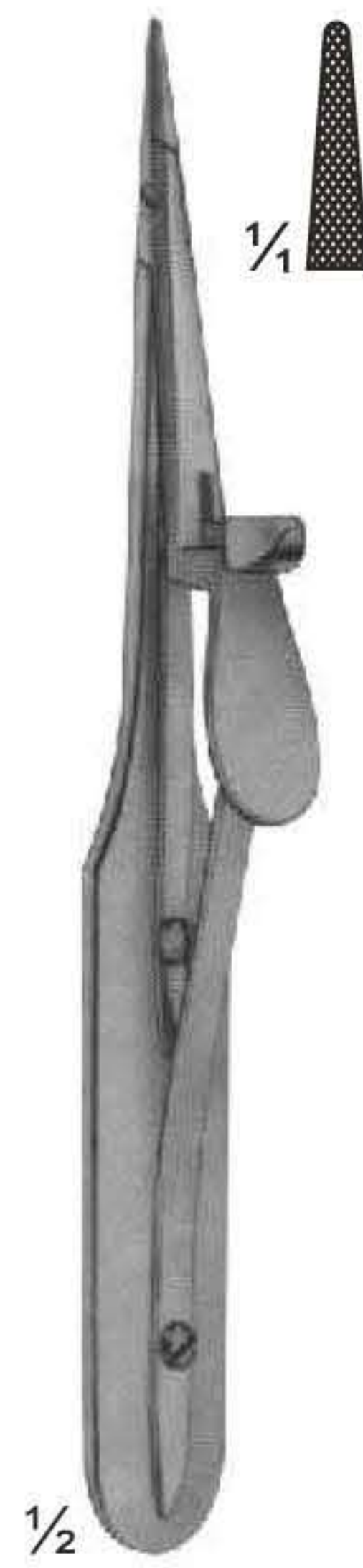

**UG-244**  
ARRUGA  
With catch  
135 mm



**UG-245**  
CASTROVIEJO  
With catch  
145 mm



**UG-246**  
CASTROVIEJO  
With Catch  
160 mm

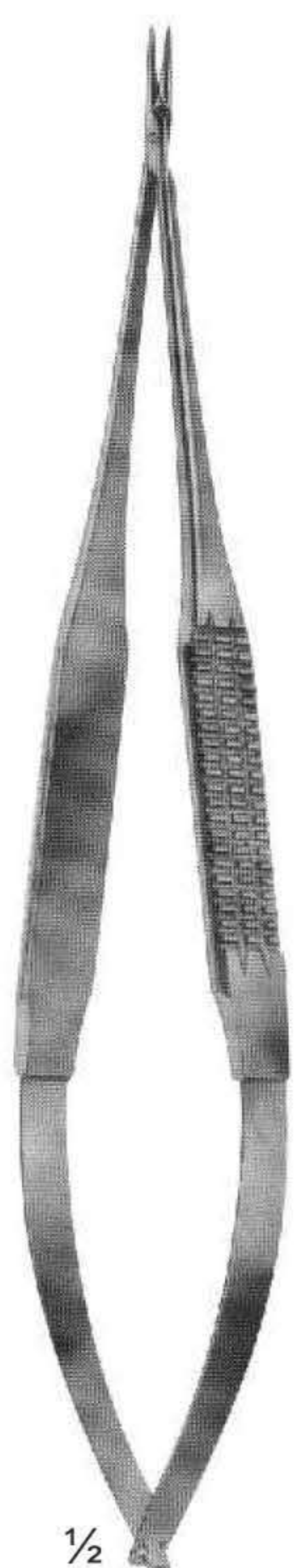

**UG-261**  
Without catch  
185 mm

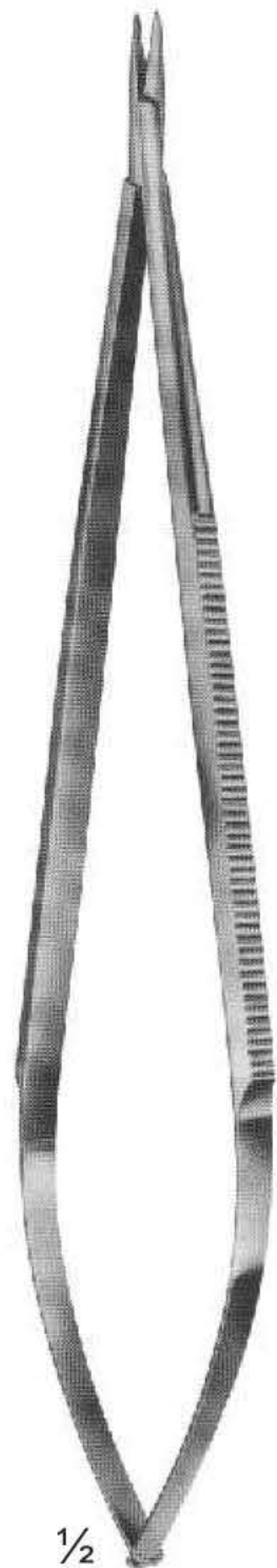

**UG-263**  
JACOBSON  
185 mm

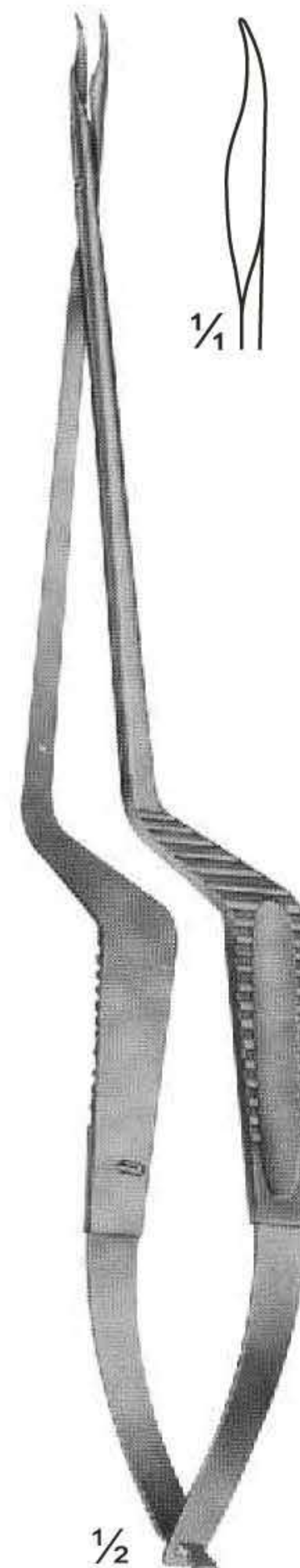

**UG-264**  
Without catch  
195 mm



**UG-265**  
YASARGIL  
With catch  
200 mm

# Micro Needle Holders With Round Handles



1/2  
**UG-267**  
 BARRAQUER  
 Without catch



1/2  
**UG-268**  
 BARRAQUER  
 Without catch  
 120 mm



1/2  
**UG-269**  
 BARRAQUER  
 With catch  
 120 mm



1/2  
**UG-271**  
 BARRAQUER  
 With Catch  
 150 mm



1/2  
**UG-273**  
 MULLER  
 With Locking  
 Mechanism  
 145 mm



1/2  
**UG-275**  
 BROCK  
 Without catch  
 150 mm



1/2  
**UG-277**  
 YASARGIL  
 200 mm



1/2  
**UG-279**  
 YASARGIL  
 225 mm



1/2  
**UG-280**  
 YASARGIL  
 245 mm

# Needle Holders

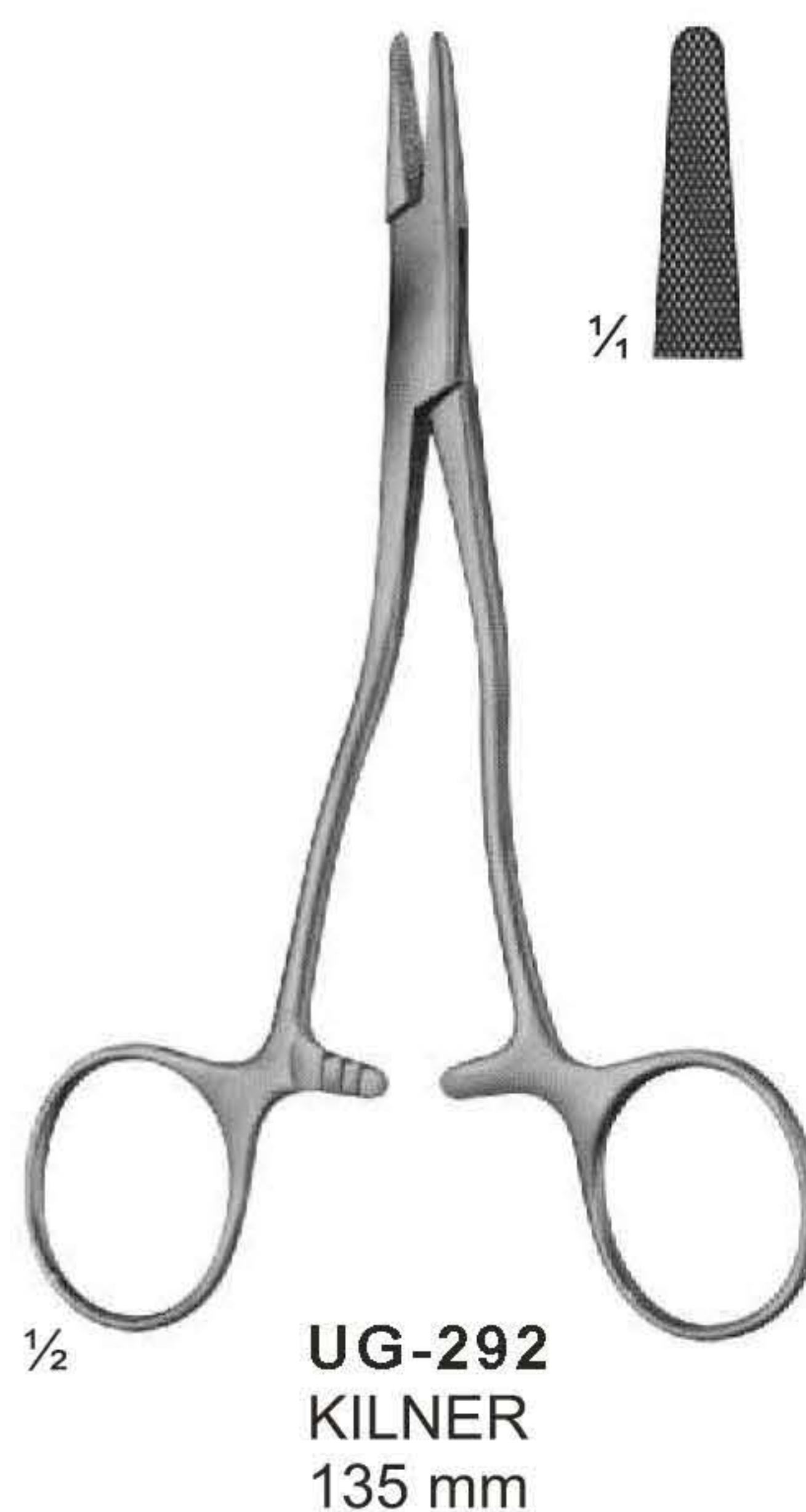
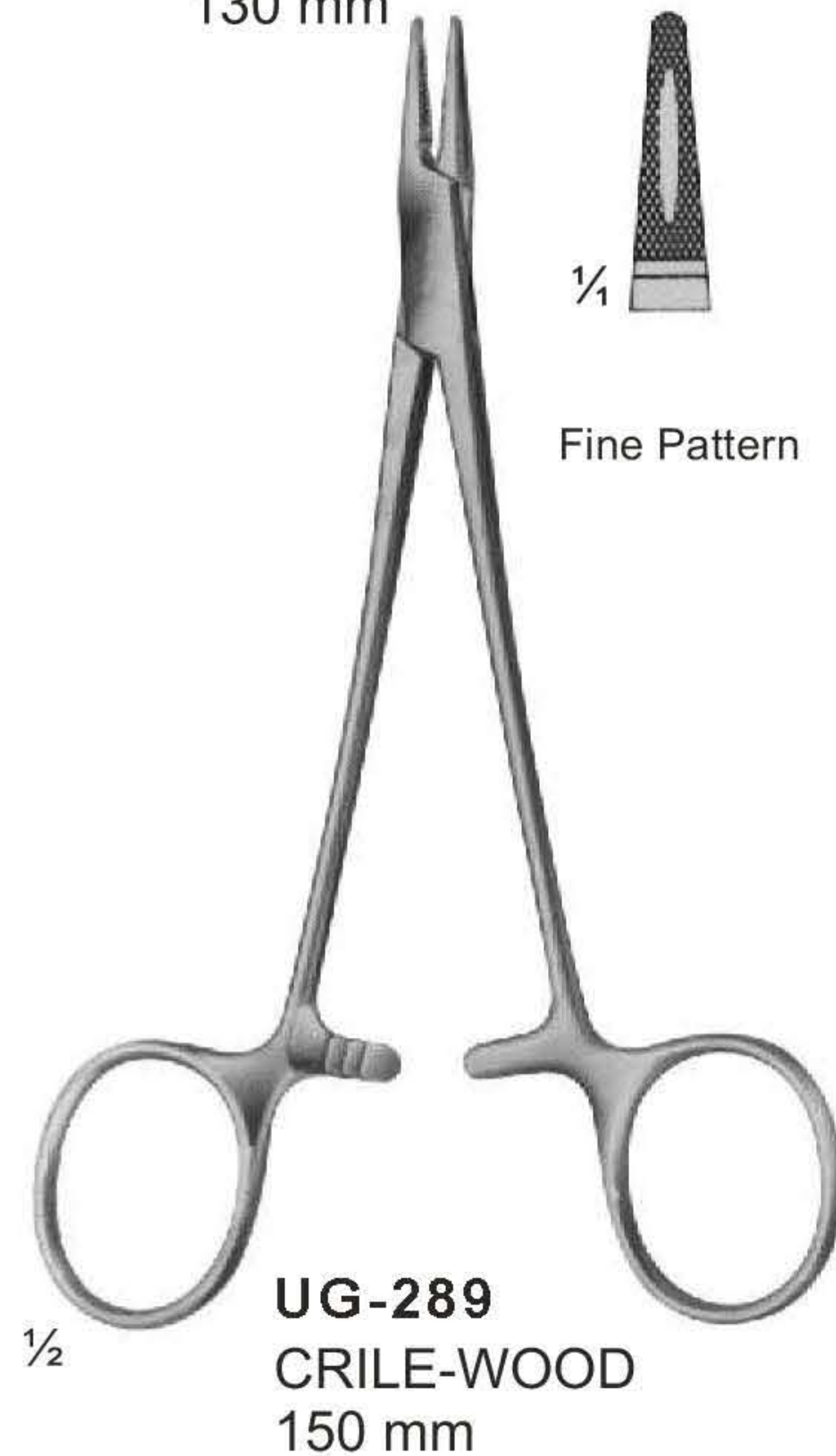
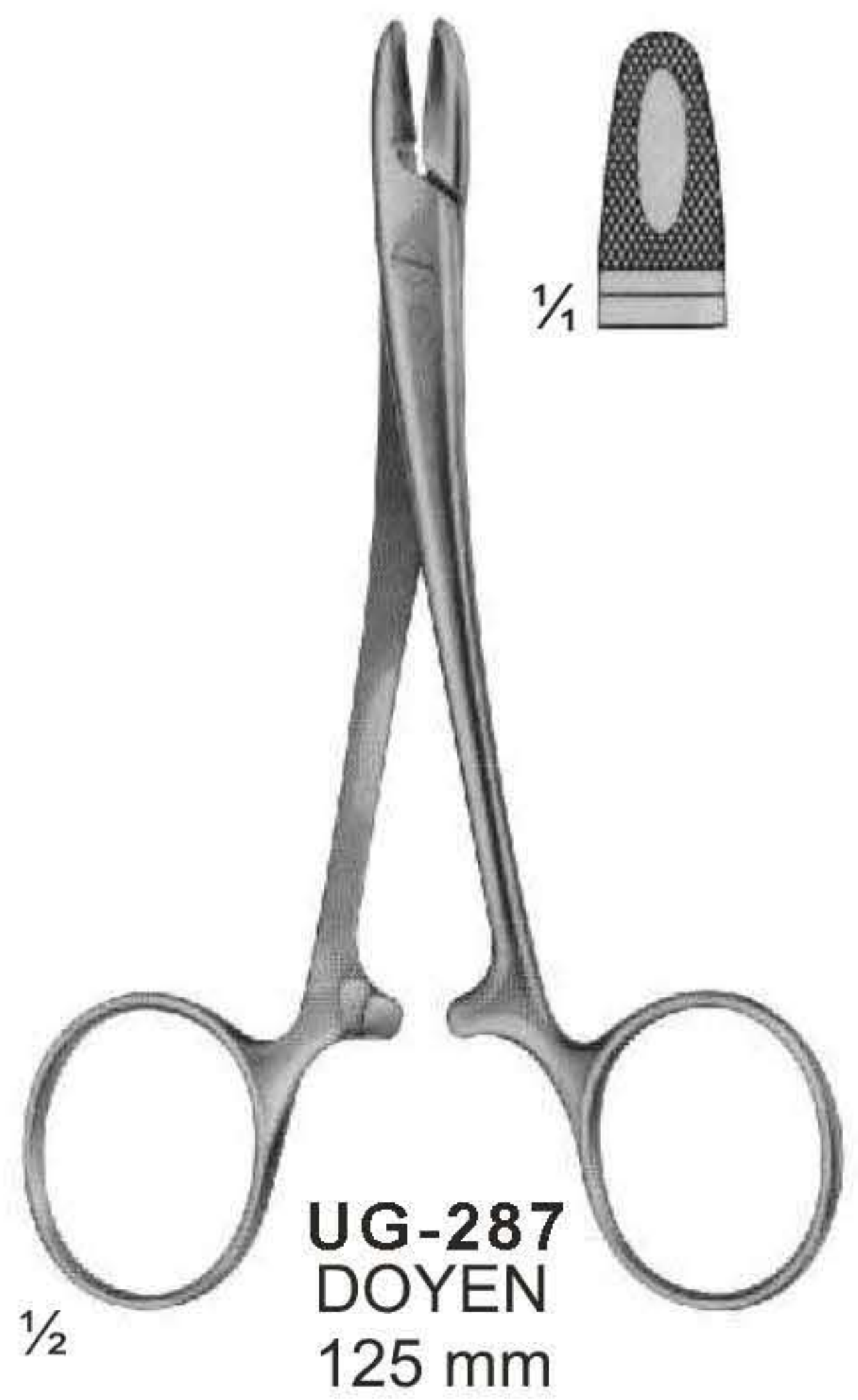
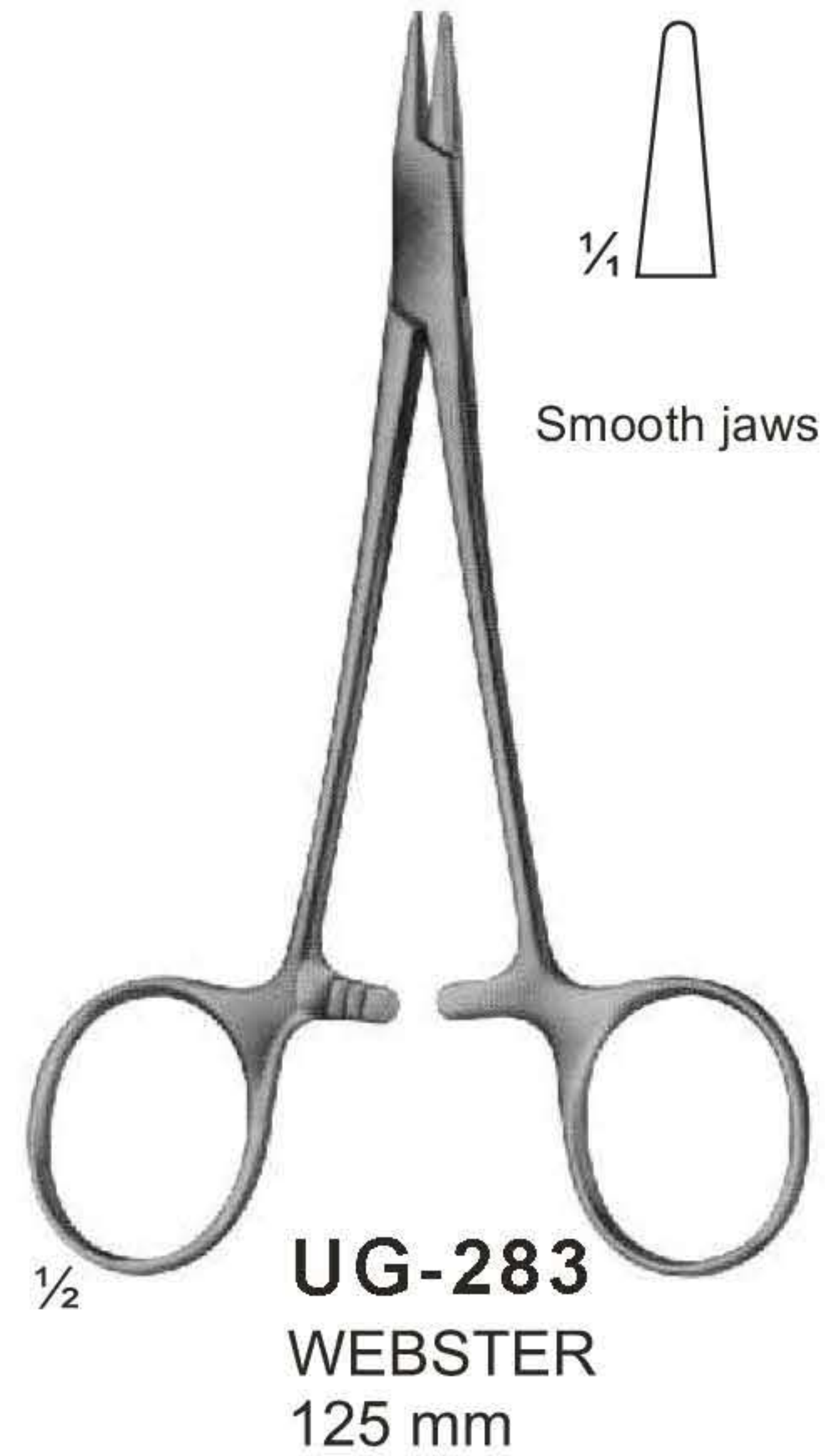

# Needle Holders



**UG-295**  
MAYO-HEGAR  
Medium fine patterns



**UG-298**  
HEGAR  
Heavy Patterns



**UG-301**  
HEANEY (HEGAR)  
200 mm



**UG-302**  
JAMESON  
230 mm



**UG-304**  
WANGENSTEEN  
275 mm



**UG-305**  
MASSON  
265 mm

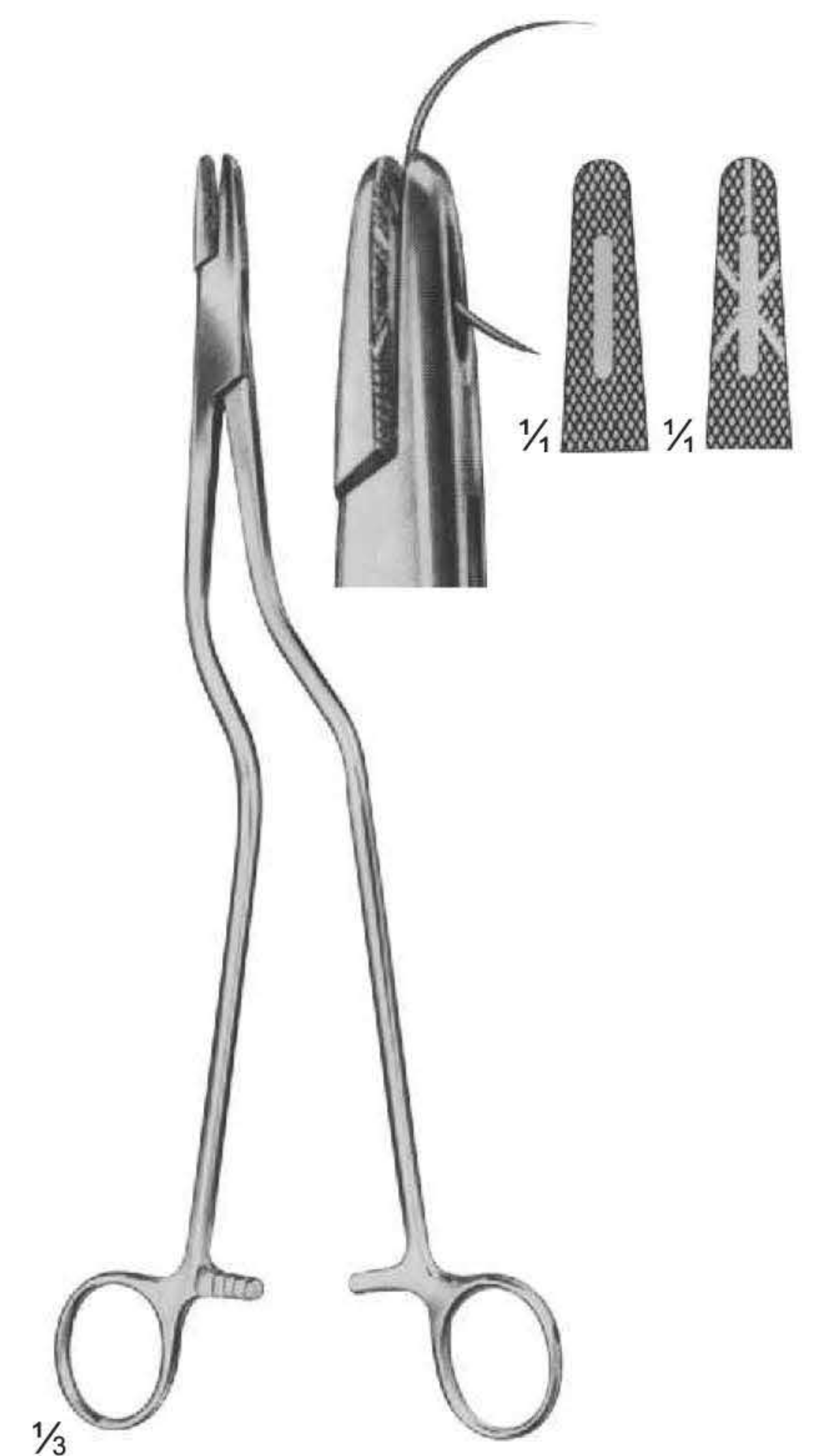

**UG-307**  
MASSON-LUETHY  
255 mm

# Needle Holders



**UG-309**  
HEGAR-OLSEN  
255 mm

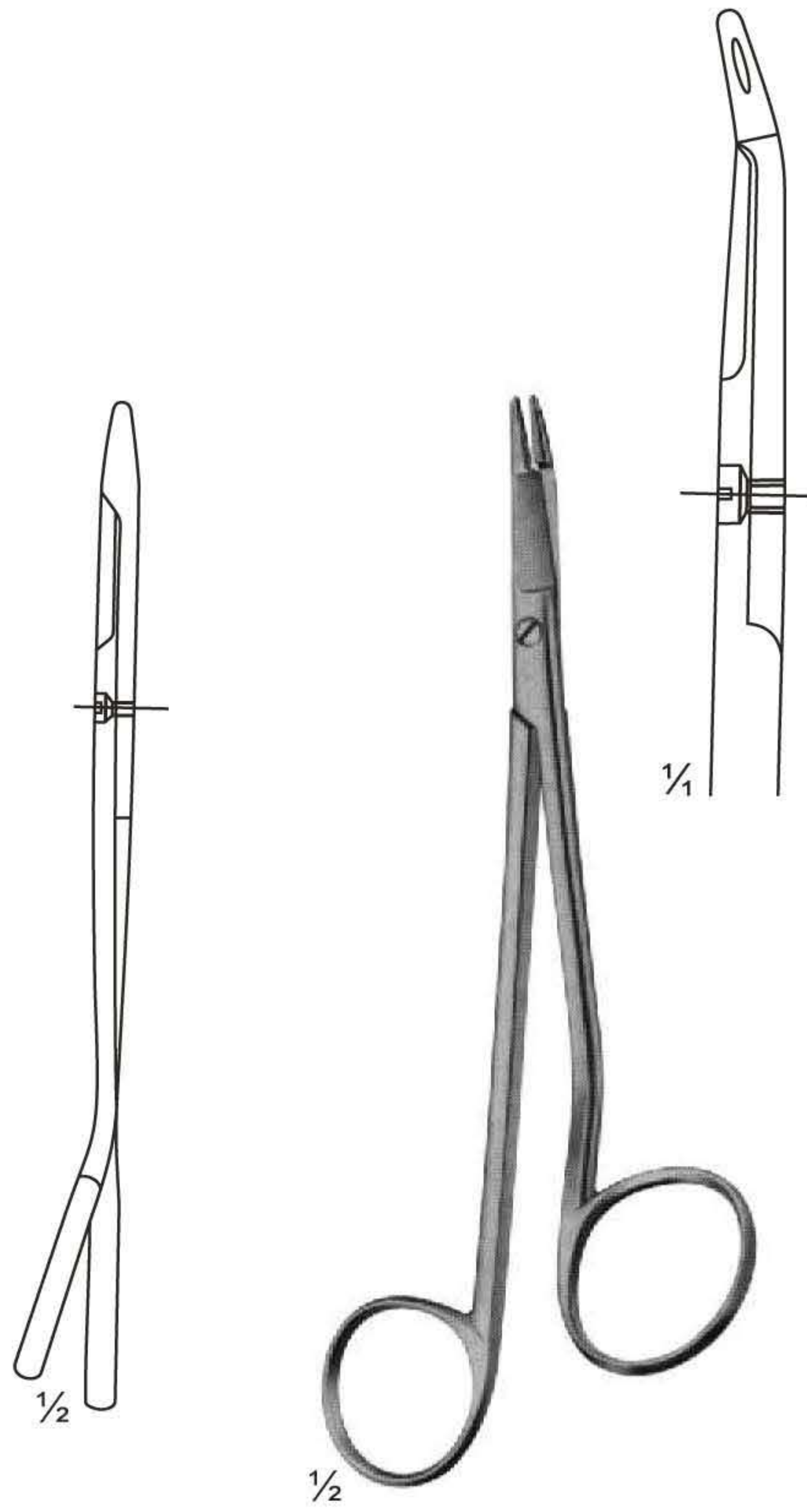

**UG-310**  
GILLIES  
150 mm

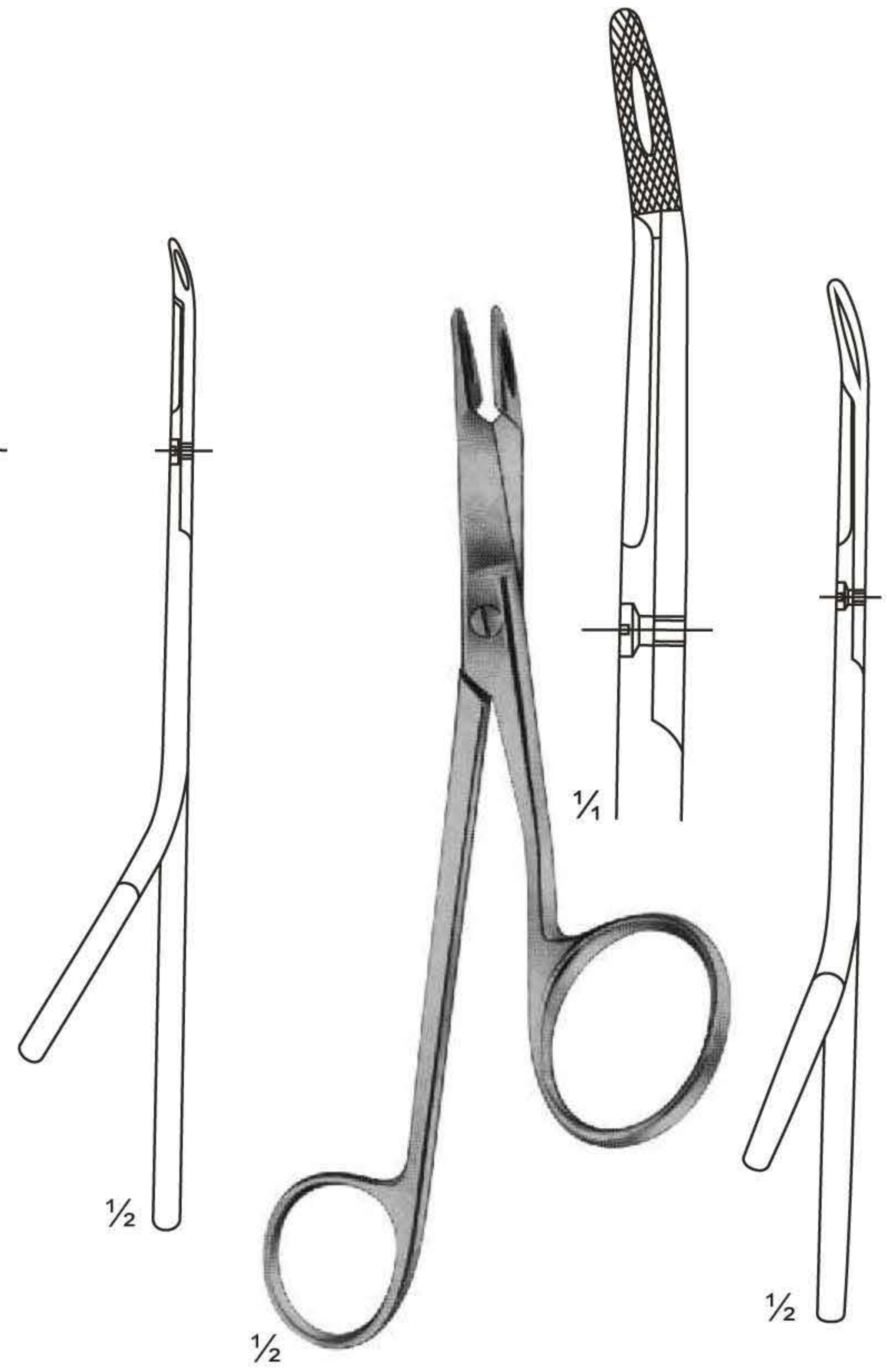

**UG-312**  
GILLIES  
160 mm

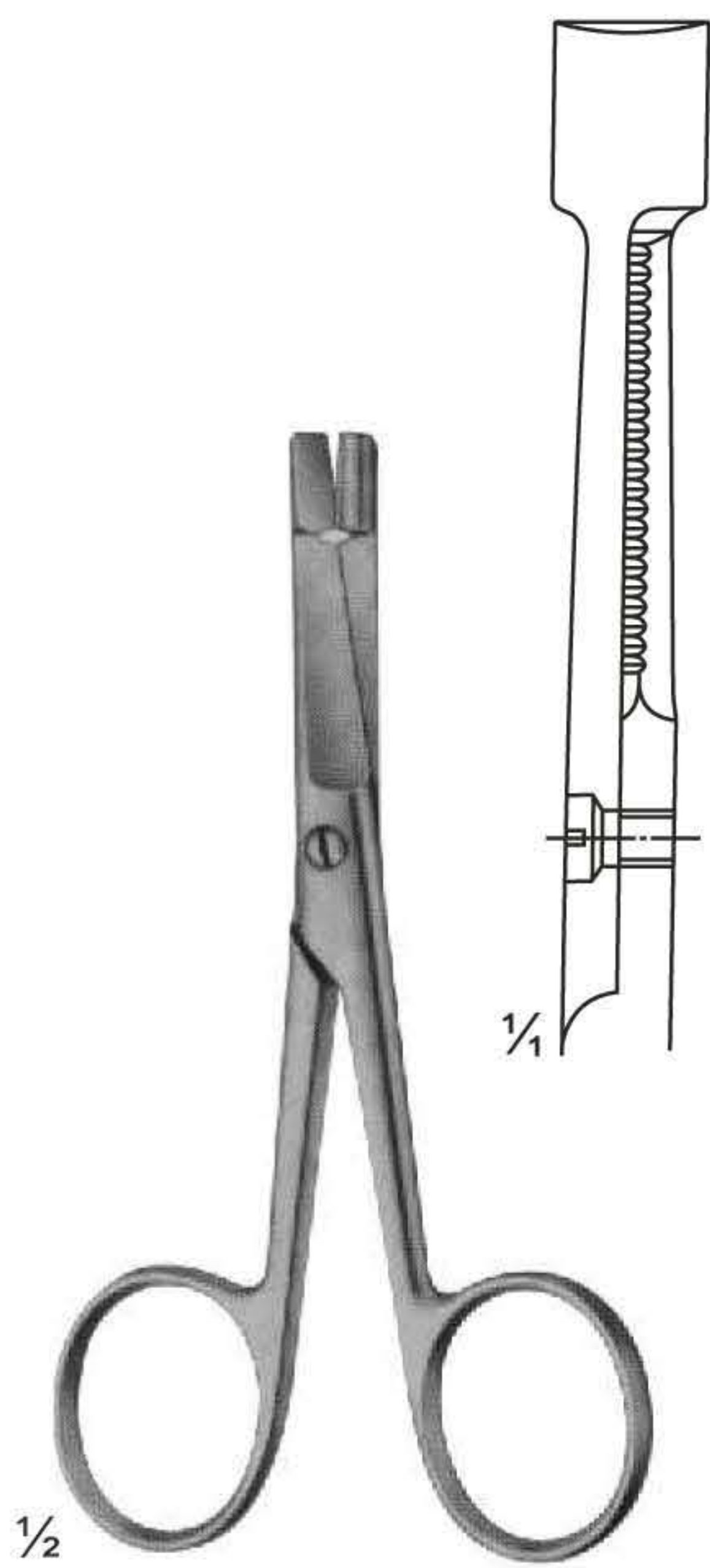

**UG-313**  
EISELSBERG  
115 mm

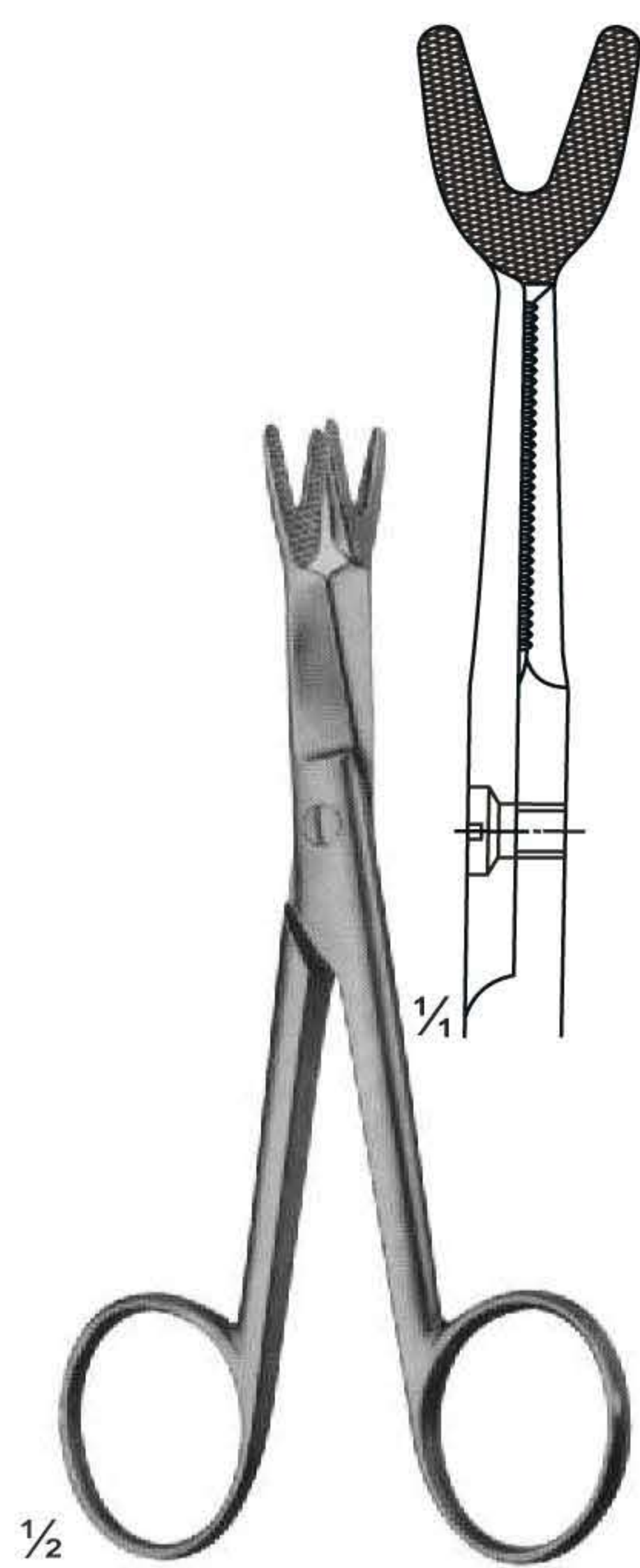

**UG-314**  
SCHOEMAKER-LOTH  
125 mm



**UG-315**  
CRILE  
150 mm



**UG-317**  
TONNIS  
Elastic pattern for  
dura-or intestinal suture  
180 mm

# Needle Holders



**UG-318**  
MATHIEU



**UG-320**  
BOYNTON  
125 mm



**UG-321**  
EISELSBERG-MATHIEU  
For palate suture  
195 mm



**UG-322**

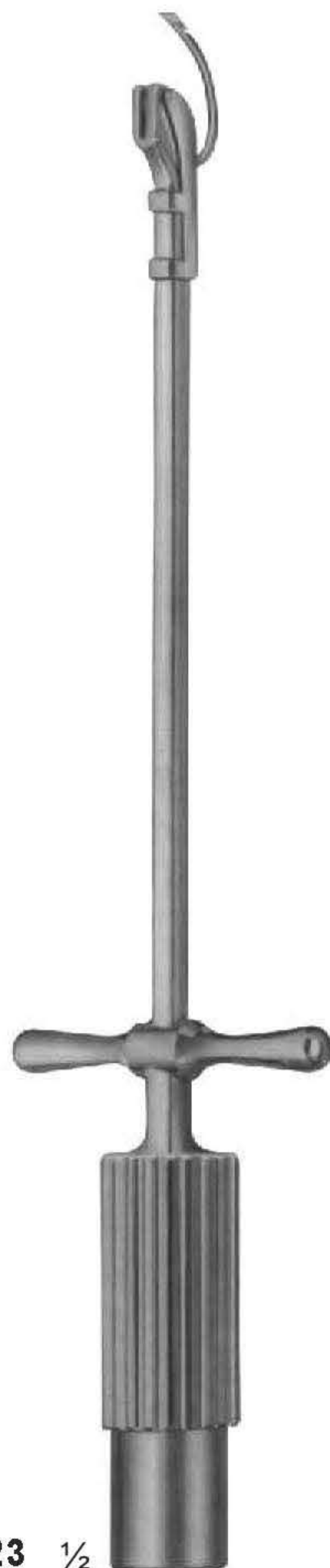

**UG-323** 1/2  
YOUNG-HRYNTSCHAK  
With 1 needle  
240 mm



**UG-325** 1/2  
YOUNG-MILLIN  
With 1 needle  
200 mm



**UG-327**  
MILLIN  
Ligature holding forceps  
245 mm



# Kidney Clamps

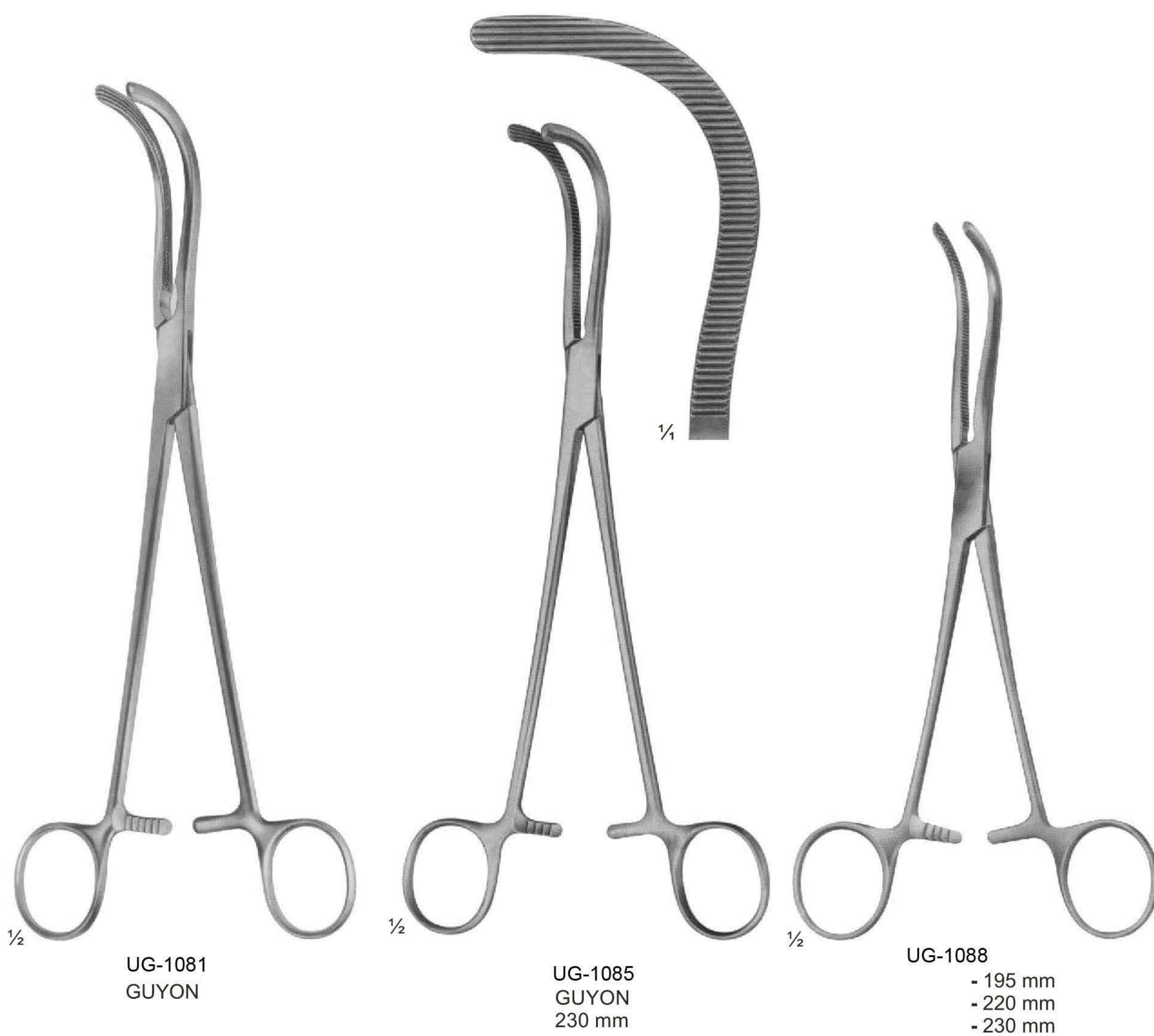

# Kidney Clamps

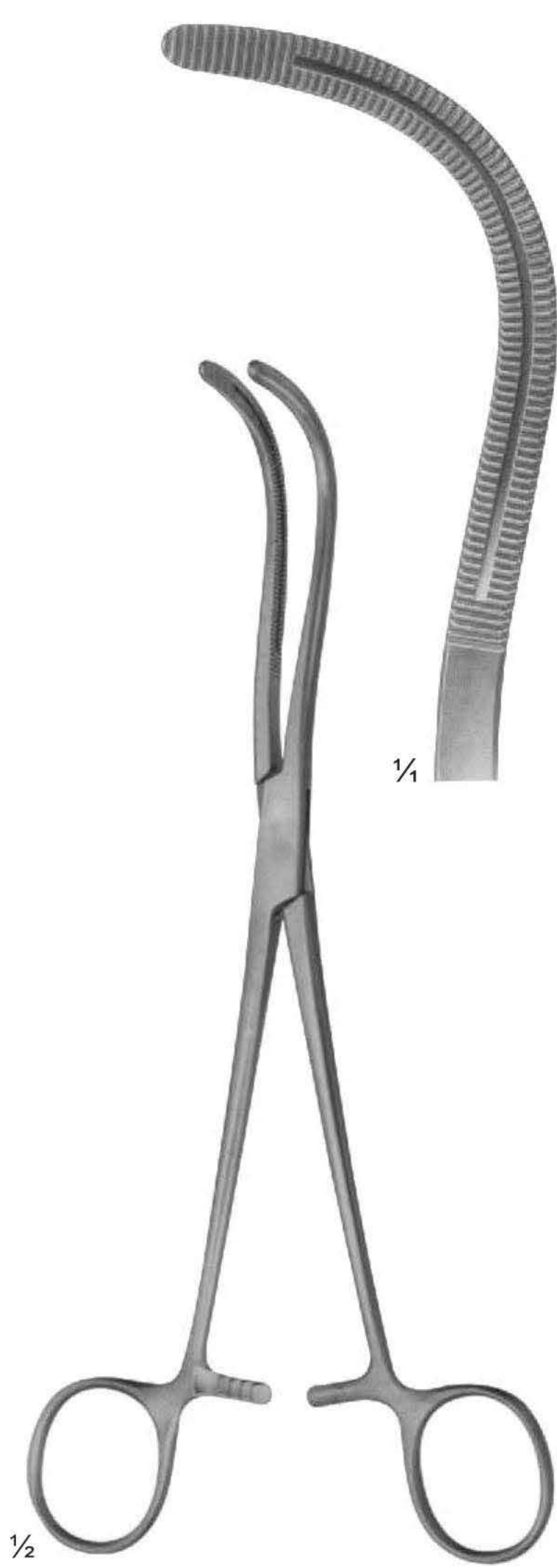

UG-1093  
STILLE  
220 mm

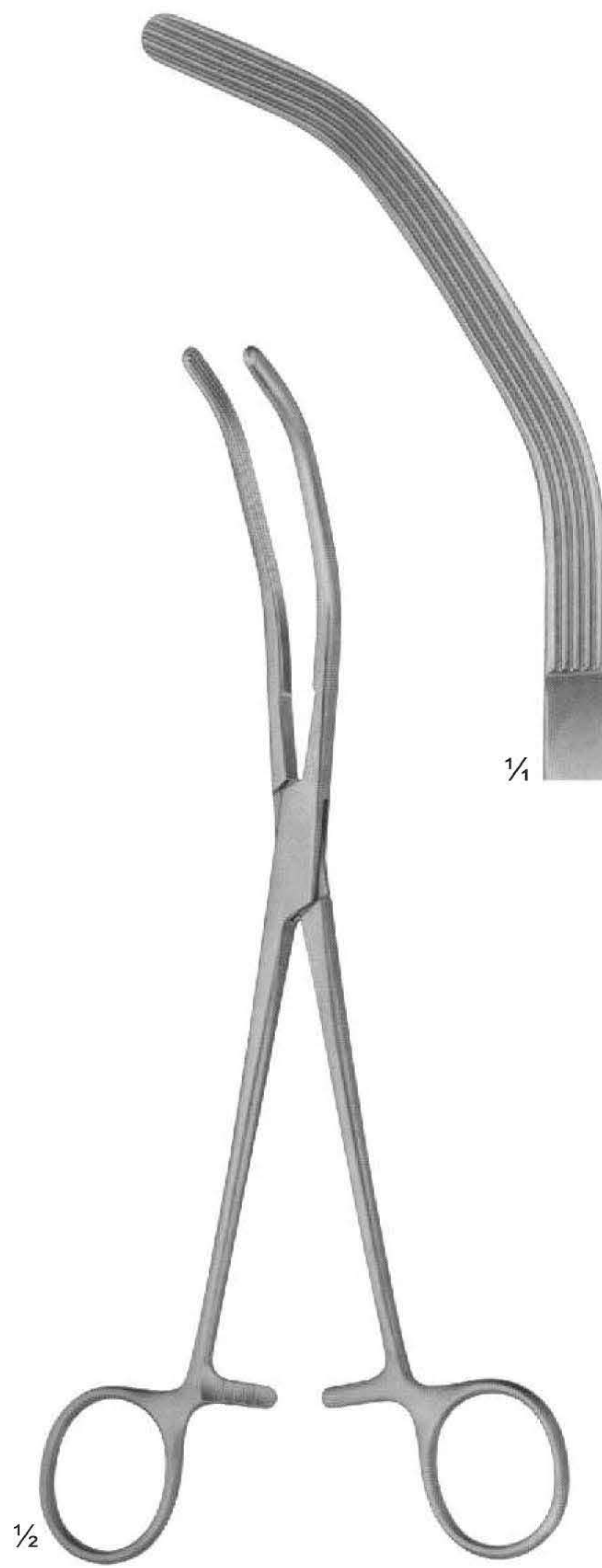

UG-1095  
HERRICK  
225 mm

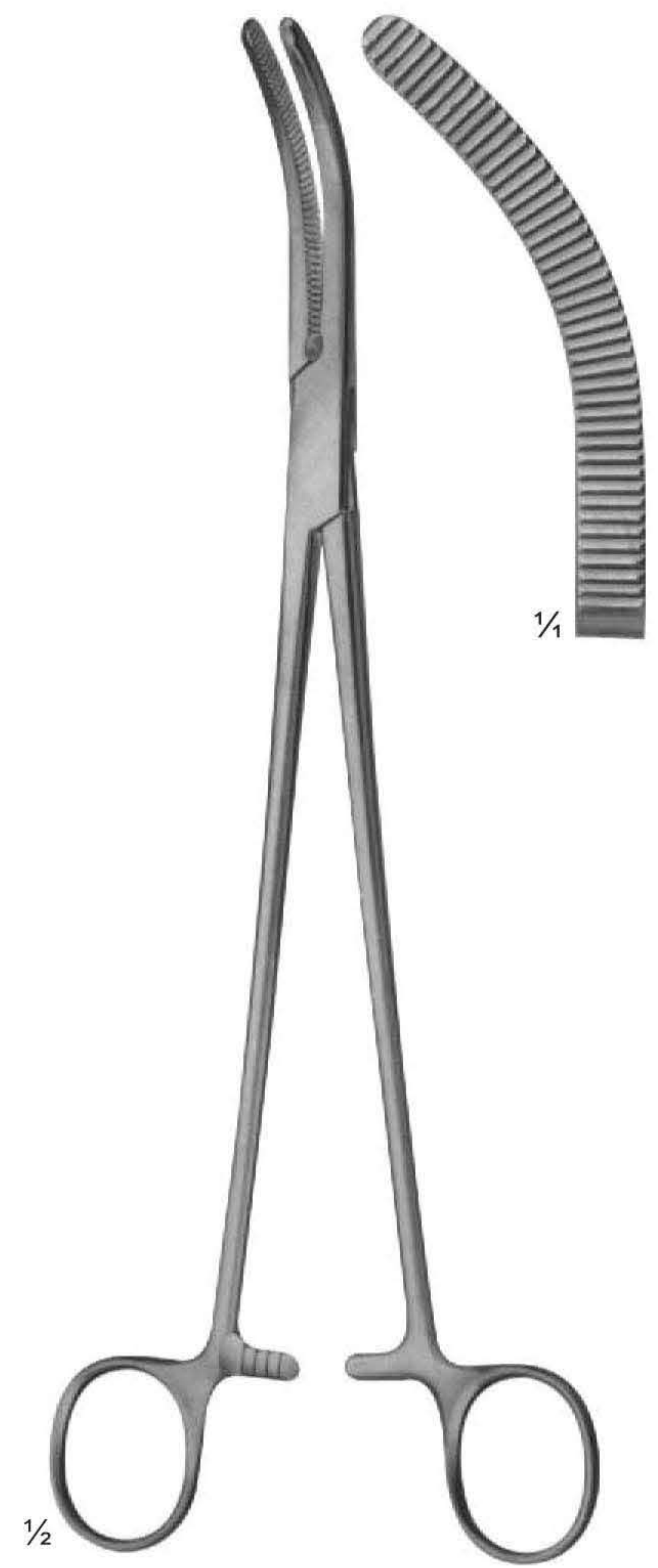

UG-1097  
WERTHEIM  
225 mm

## Kidney Elevating Forceps



1/2

UG-1101  
COLLIN  
285 mm

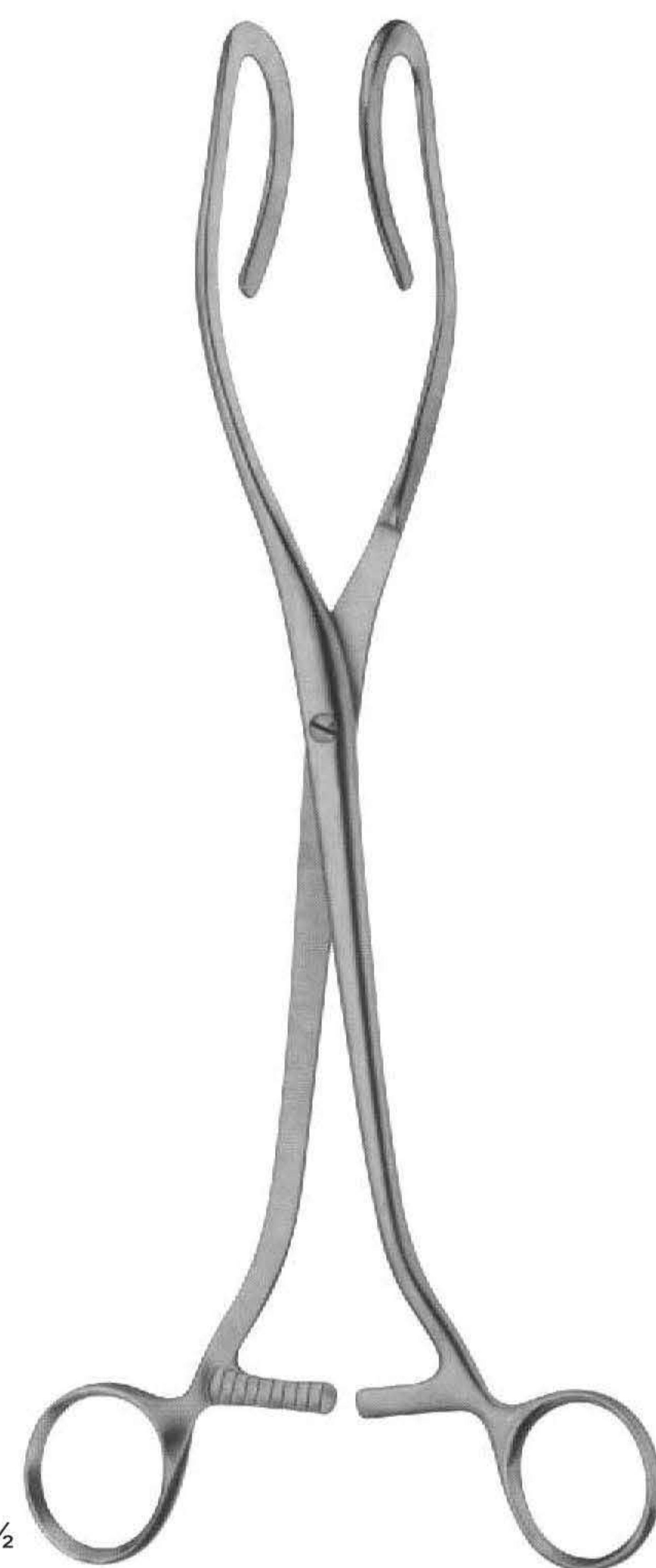

1/2

UG-1102  
DARTIGUES  
255 mm

# Kidney Stone Forceps

---



UG-1105  
RANDALL  
225 mm



UG-1106  
RANDALL  
190 mm

# Bladder Retractors

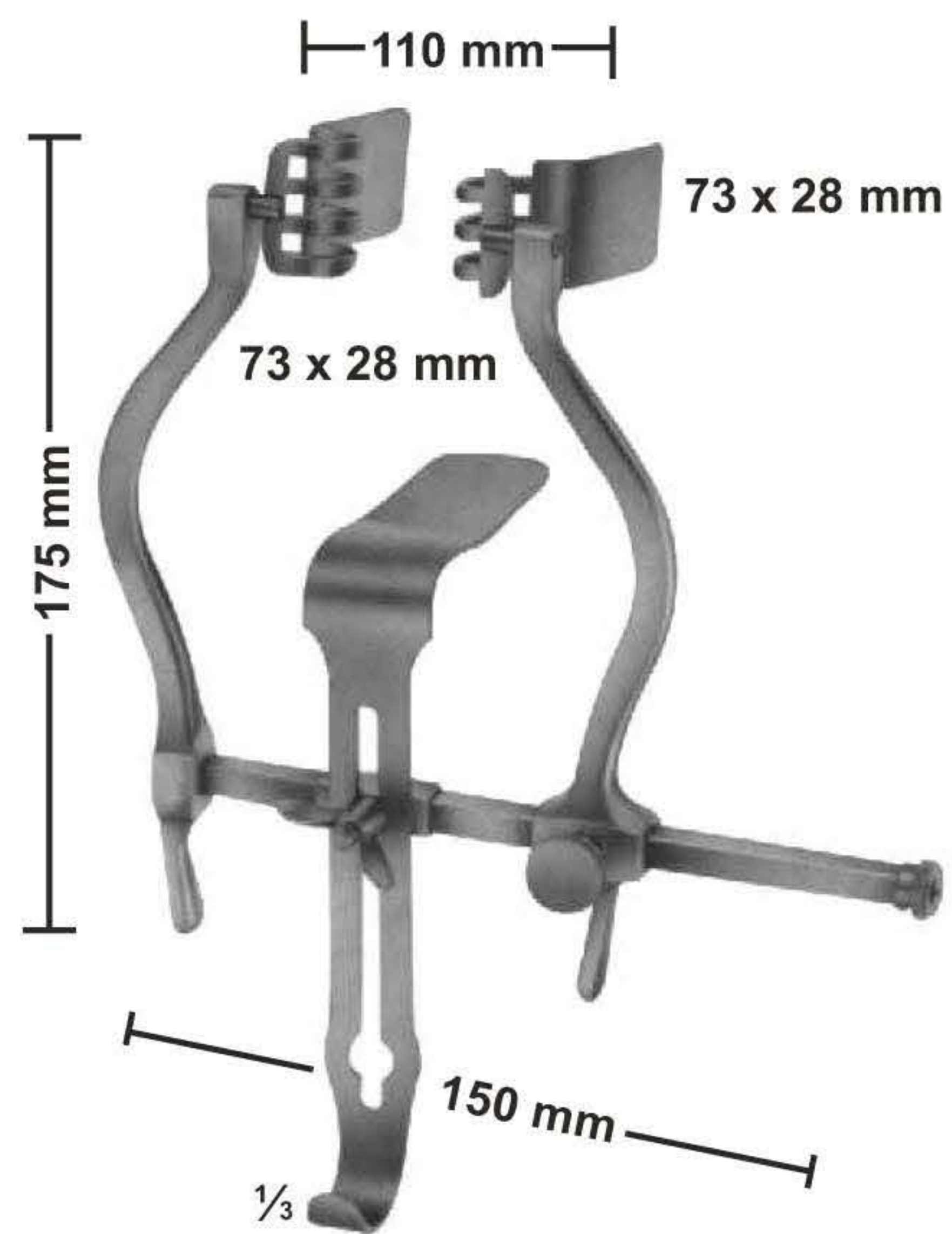

UG-1108  
JUDD-MASSON  
Bladder-and suprapubic  
retractor



UG-1109  
MILLIN  
Bladder retractor  
105X45 mm



UG-1111  
LEGUEU  
Bladder retractor  
Center blade  
80 x 31 mm

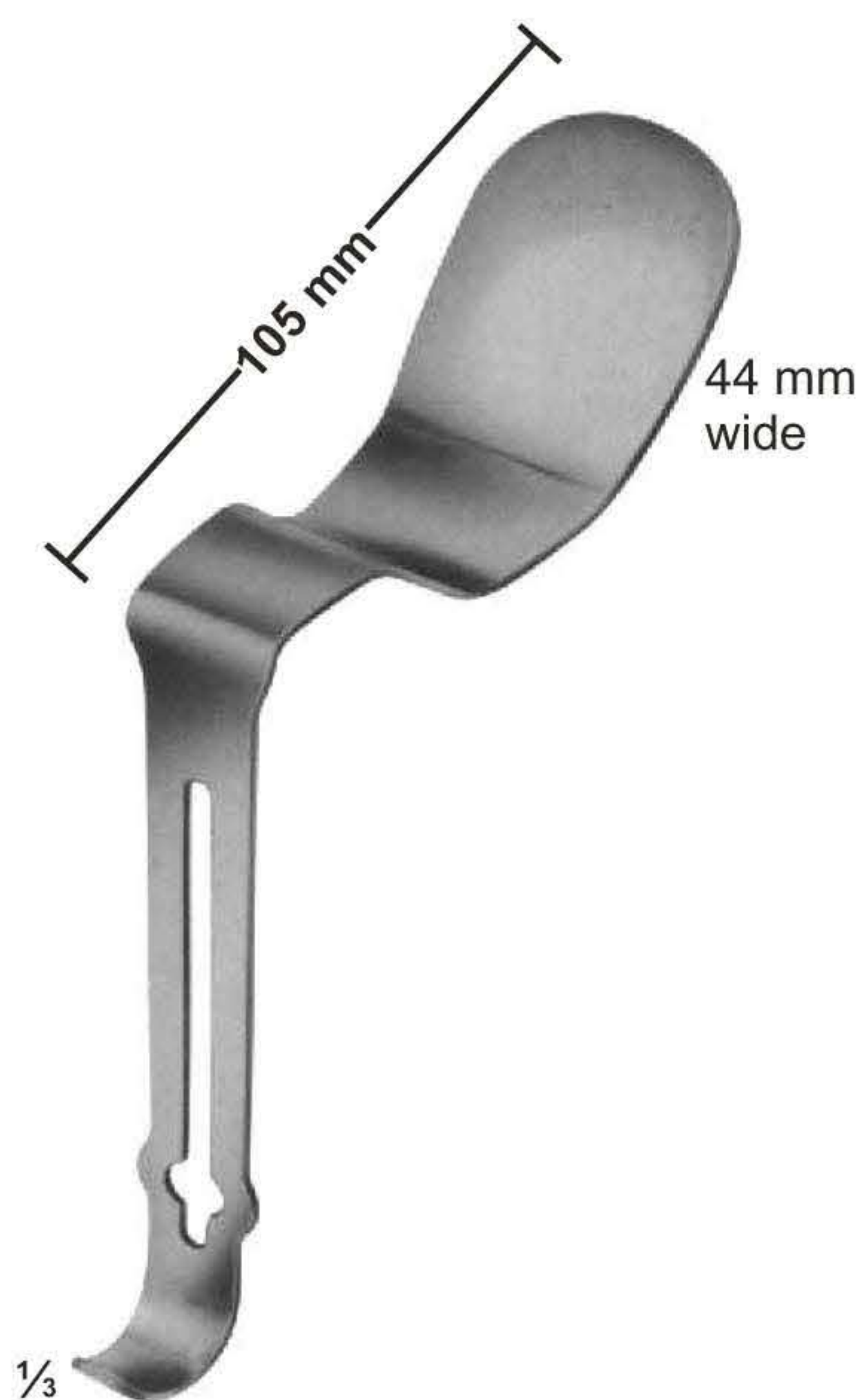

UG-1112  
MILLIN  
Center bladder for  
retro pubic prostatectomy

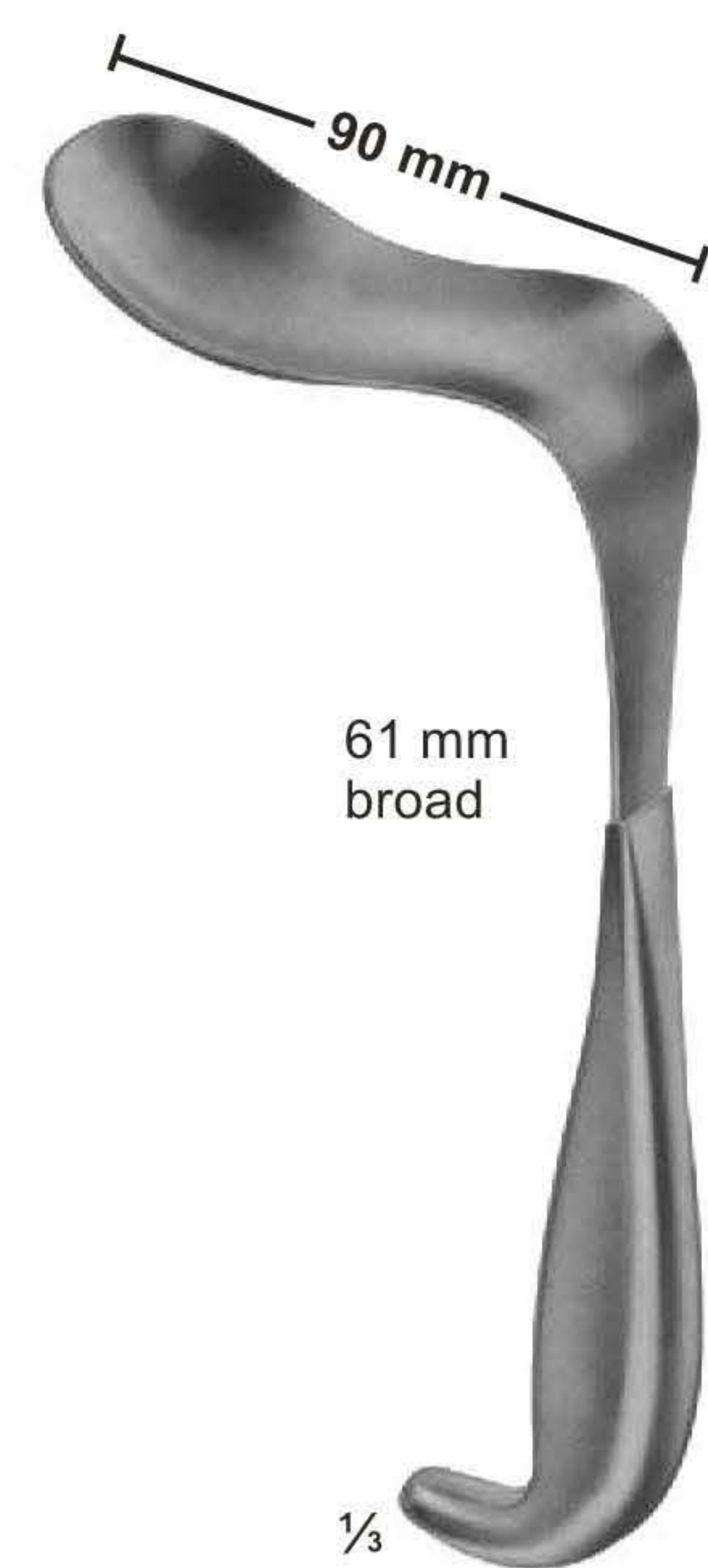

UG-1113  
KOCHER  
Bladder spatula  
235 mm

# Genito-Urinary Instruments-Prostatectomy



UG-1114  
MATHIEU  
Foreign body forceps  
Length of shaft  
190 mm

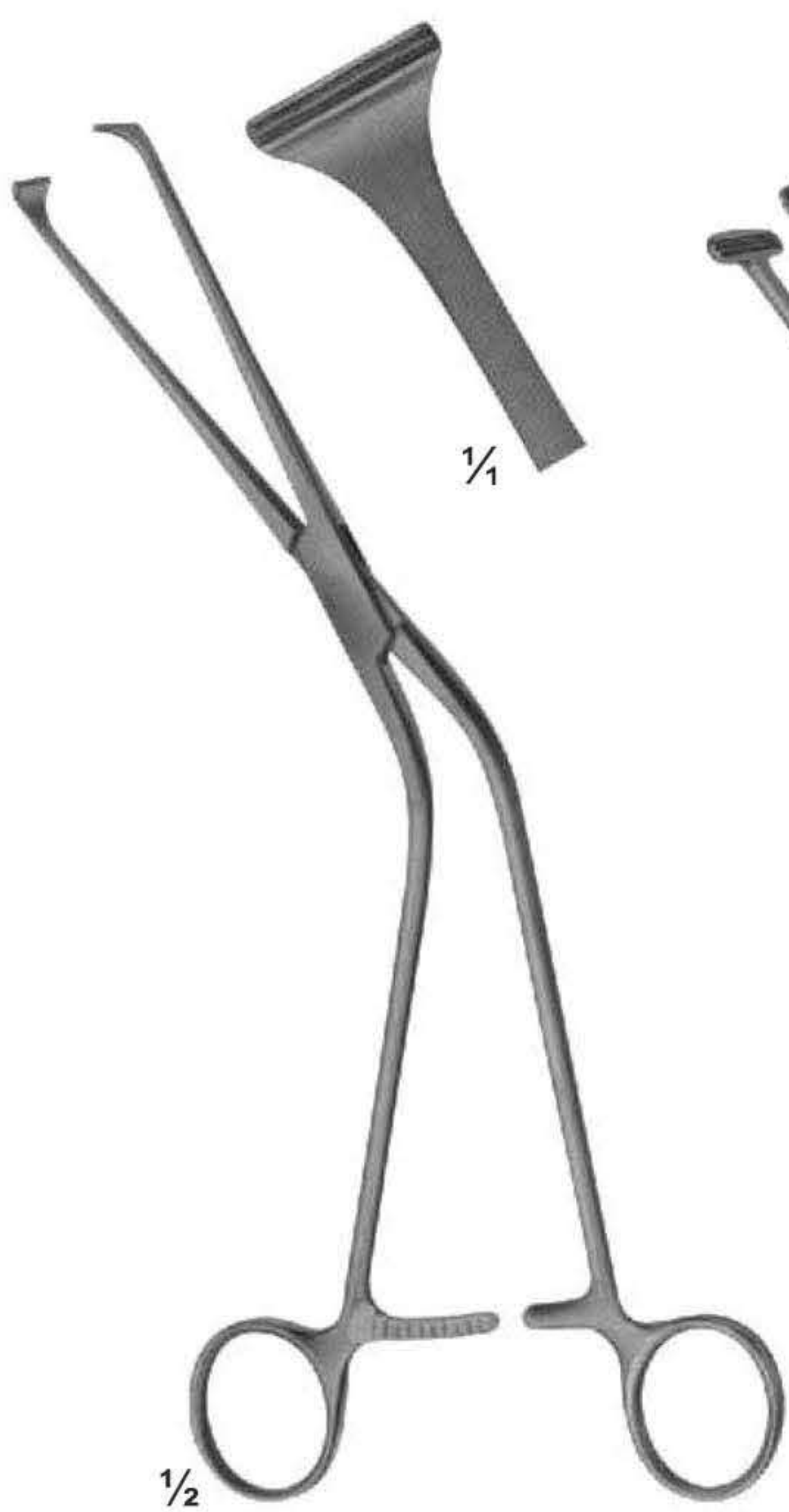

UG-1115  
MILLIN  
Lobe grasping  
forceps  
245 mm

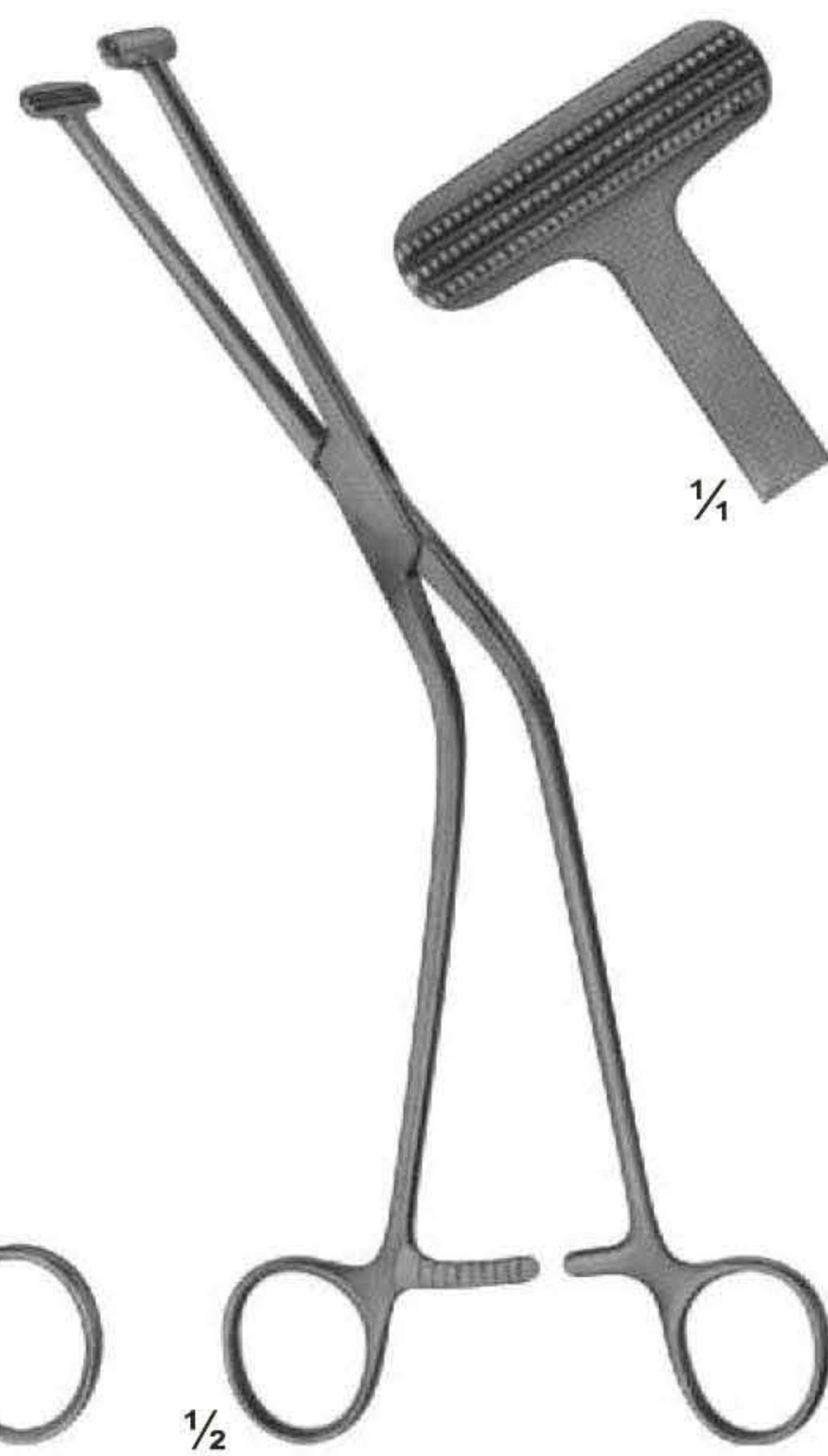

UG-1117  
MILLIN  
Lobe grasping  
forceps  
235 mm



UG-1118  
MILLIN  
Bladder neck spreader  
285 mm

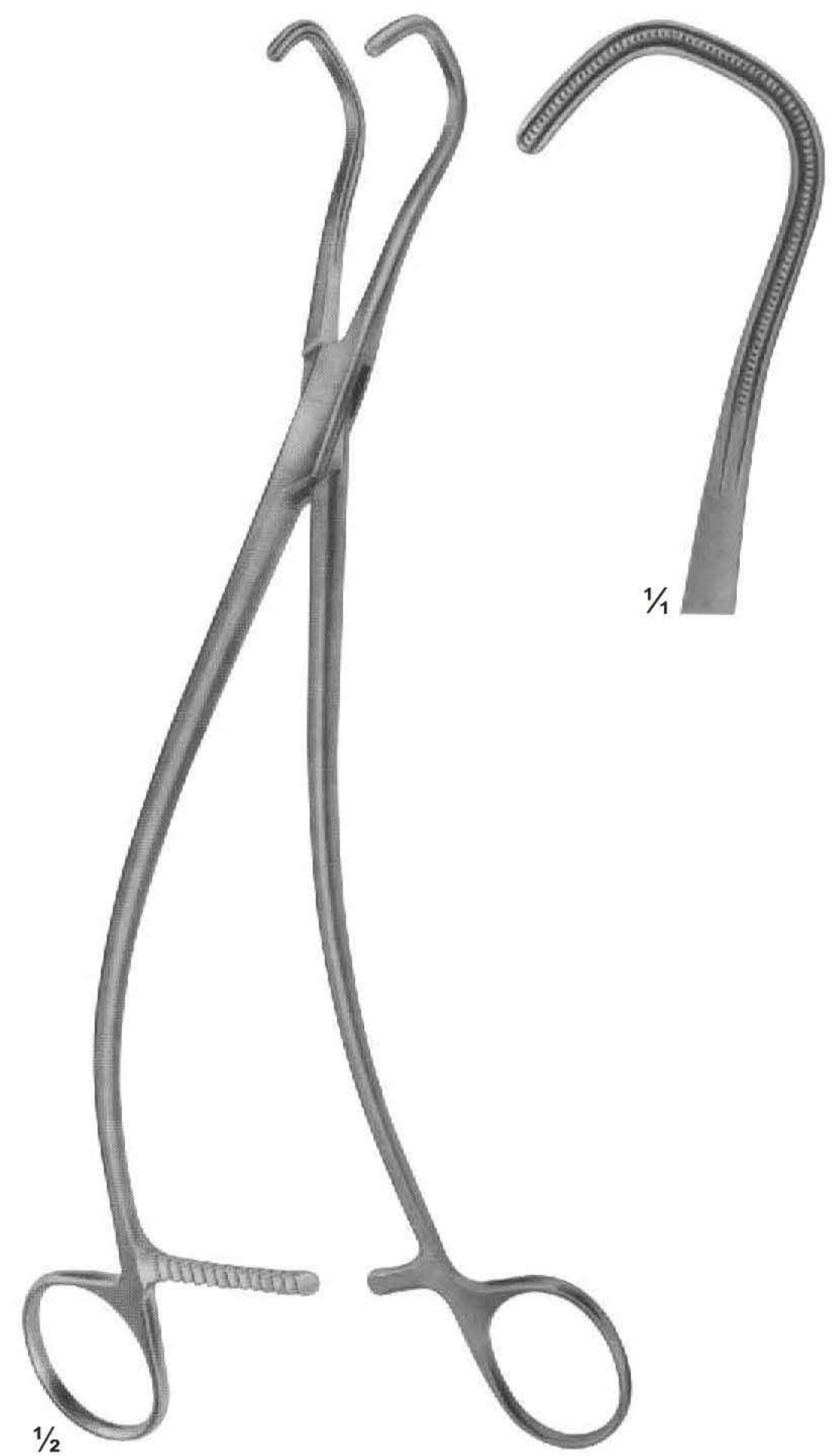

UG-1119  
Ureter forceps  
240 mm

# Trocars

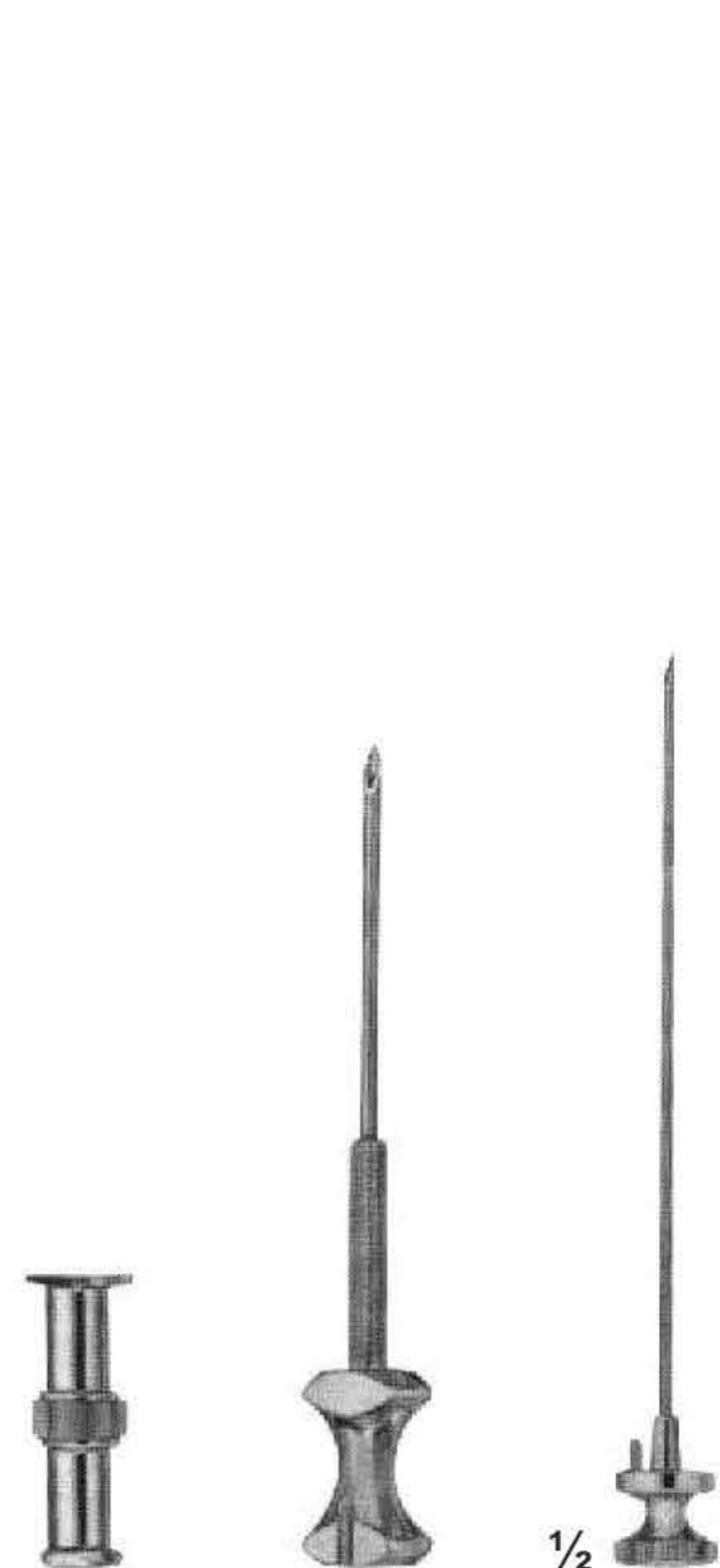

UG-116  
KLIMA ROSEGGER  
35 X 1,8 mm  
Sternal puncture needle



UG-1168  
Universal trocar  
with 4 tips



UG-1170  
Inside dime. Outside dime  
2,2 mm 3,0 mm  
3,0 mm 4,0 mm  
4,0 mm 5,0 mm  
5,0 mm 6,0 mm  
5,5 mm 6,5 mm  
for hydrocele and abdominal  
puncture



UG-1173  
Inside dime. Outside dime  
2,2 mm 3,0 mm  
3,0 mm 4,0 mm  
4,0 mm 5,0 mm  
5,0 mm 6,0 mm  
for abdominal puncture,  
with stop-cock and lateral  
drain

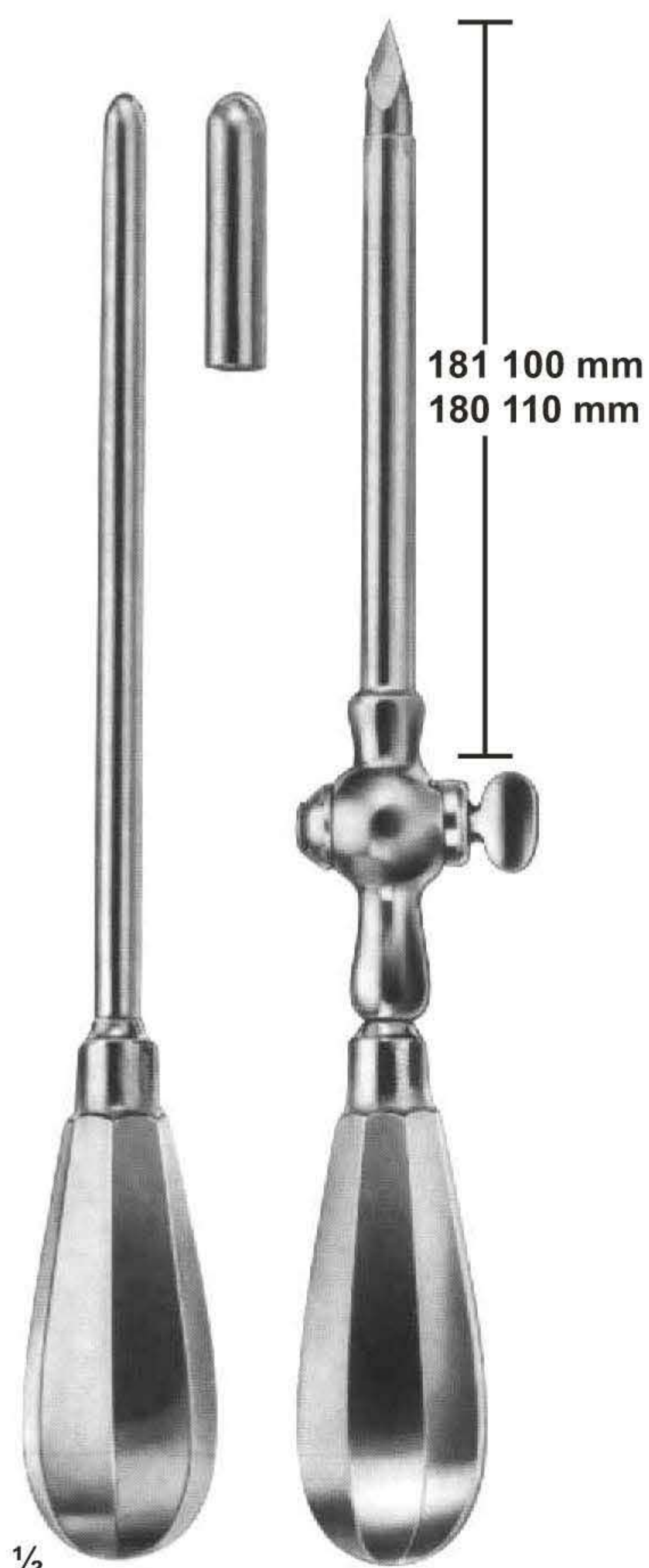

UG-1176  
Inside dime. Outside dime  
6,5 mm 8,0 mm  
9,0 mm 10,0 mm  
Empyema trocar

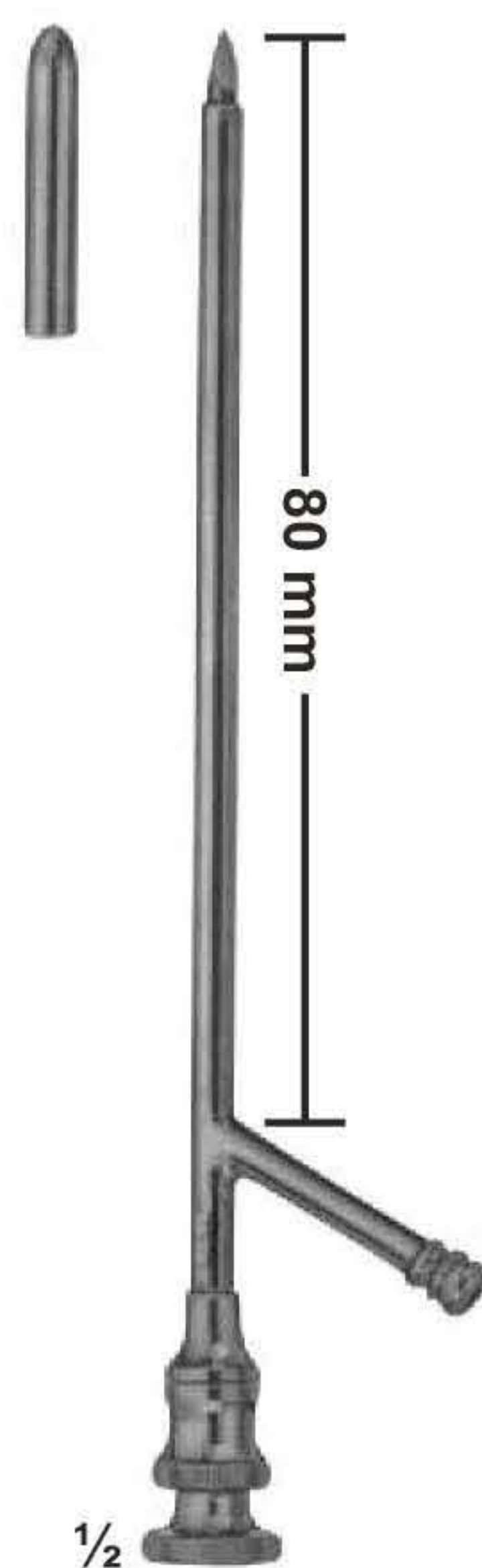

UG-1177  
Inside dime. Outside dime  
3,0 mm 4,0 mm  
3,6 mm 4,6 mm  
4,3 mm 5,3 mm  
5,0 mm 6,0 mm  
Gall bladder trocars



UG-1180  
PIERCE  
Antrum trocar  
4,0 mm



UG-1181  
COAKLEY  
Antrum trocar  
3,0 mm

## Genito-Urinary Instruments & Circumcision Clamps



UG-1163  
GUYON  
Set of urethral bougies and dilating sounds,  
in metal case, with lift out rack and bottom  
rack, containing 21 urethral and dilating sounds.

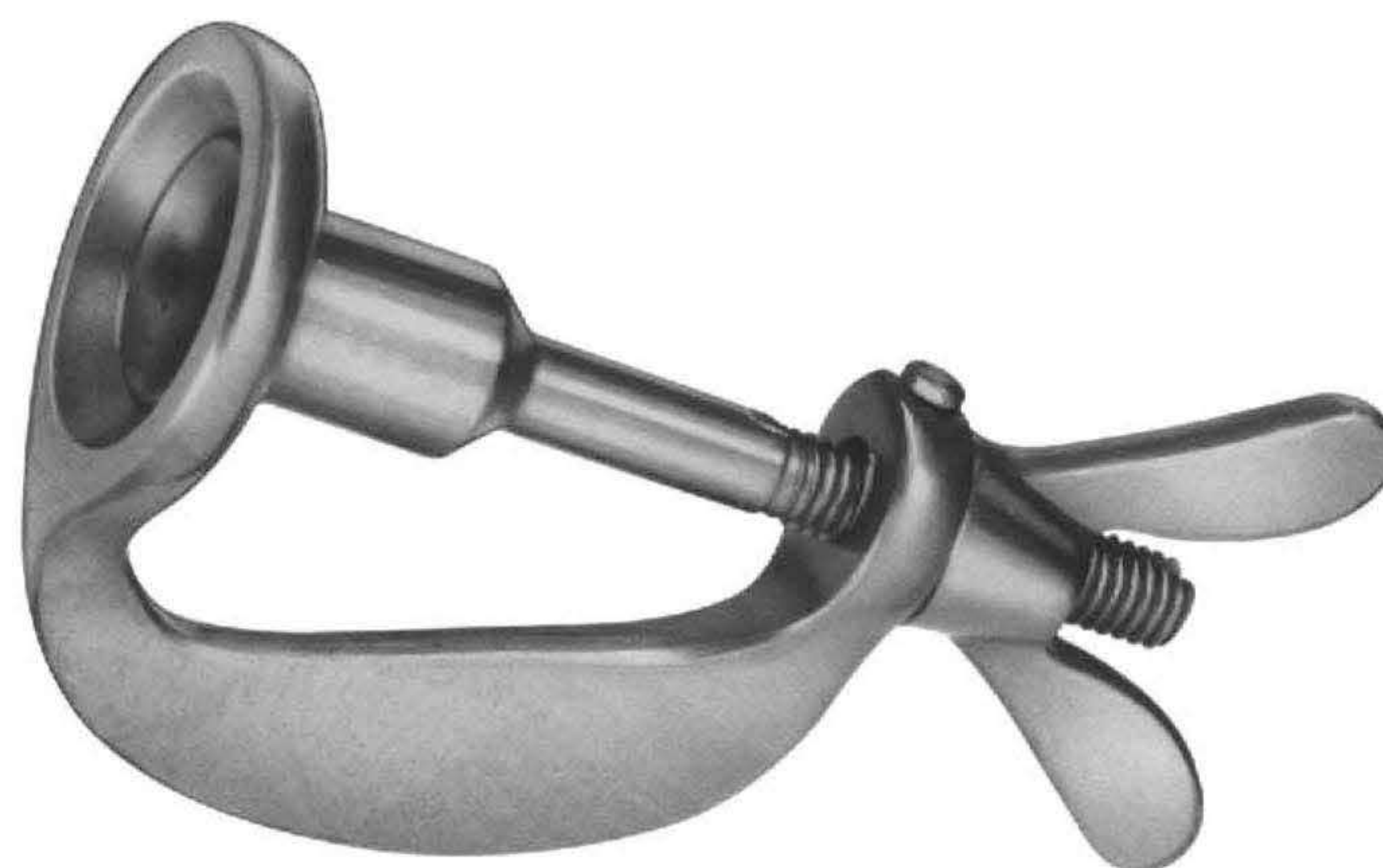

UG-1164  
WINKELMANN  
**Circumcision Clamps**  
12 mm / 16 mm / 20 mm



# Trocars

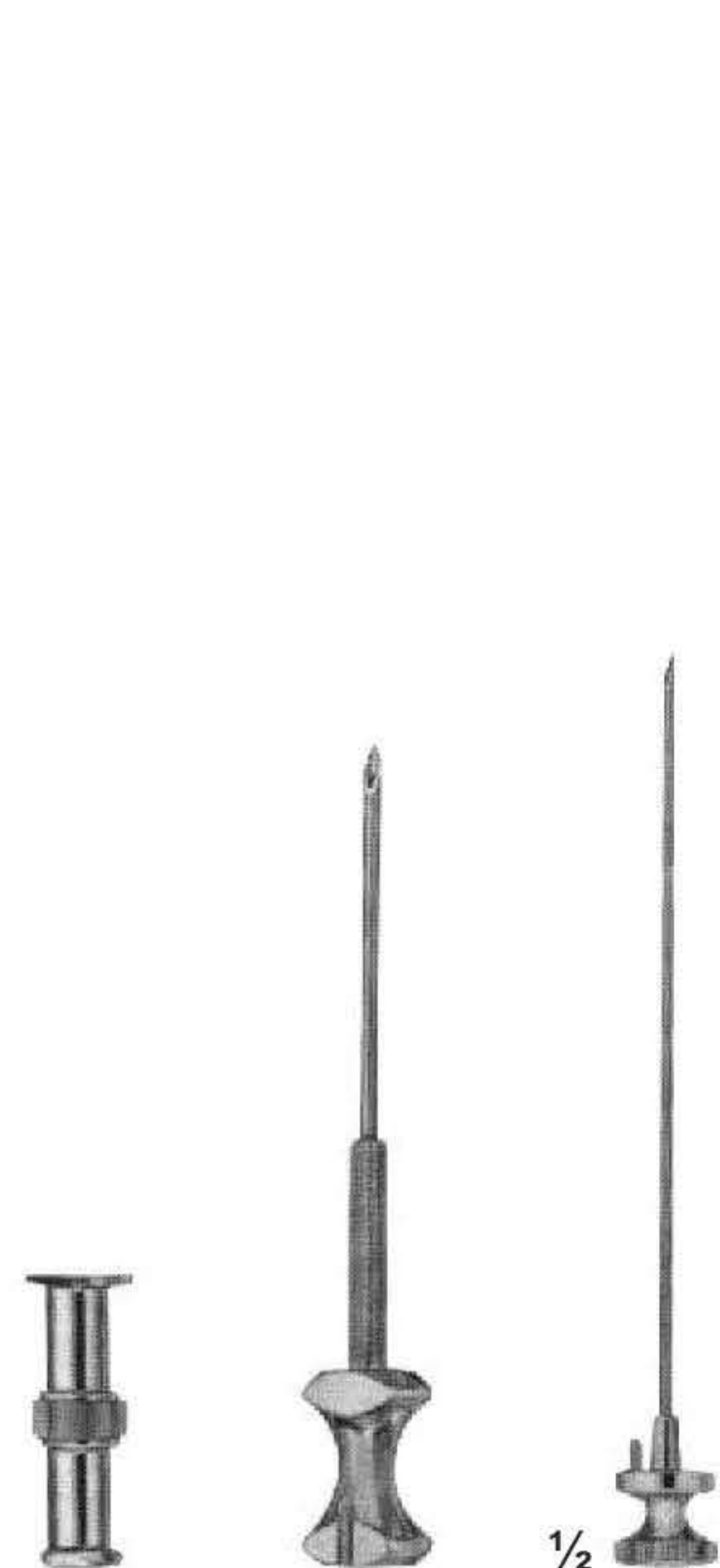

UG-116  
KLIMA ROSEGGER  
35 X 1,8 mm  
Sternal puncture needle



UG-1168  
Universal trocar  
with 4 tips

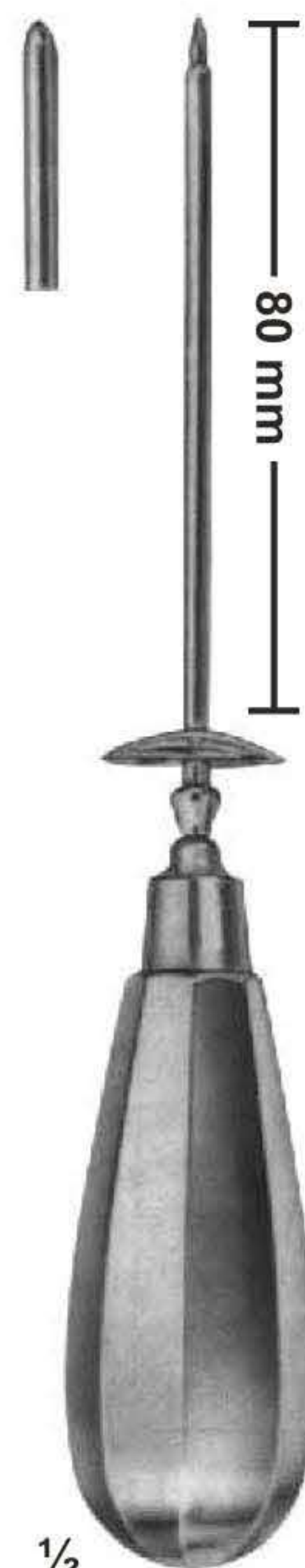

UG-1170  
Inside dime. Outside dime  
2,2 mm 3,0 mm  
3,0 mm 4,0 mm  
4,0 mm 5,0 mm  
5,0 mm 6,0 mm  
5,5 mm 6,5 mm  
for hydrocele and abdominal  
puncture



UG-1173  
Inside dime. Outside dime  
2,2 mm 3,0 mm  
3,0 mm 4,0 mm  
4,0 mm 5,0 mm  
5,0 mm 6,0 mm  
for abdominal puncture,  
with stop-cock and lateral  
drain

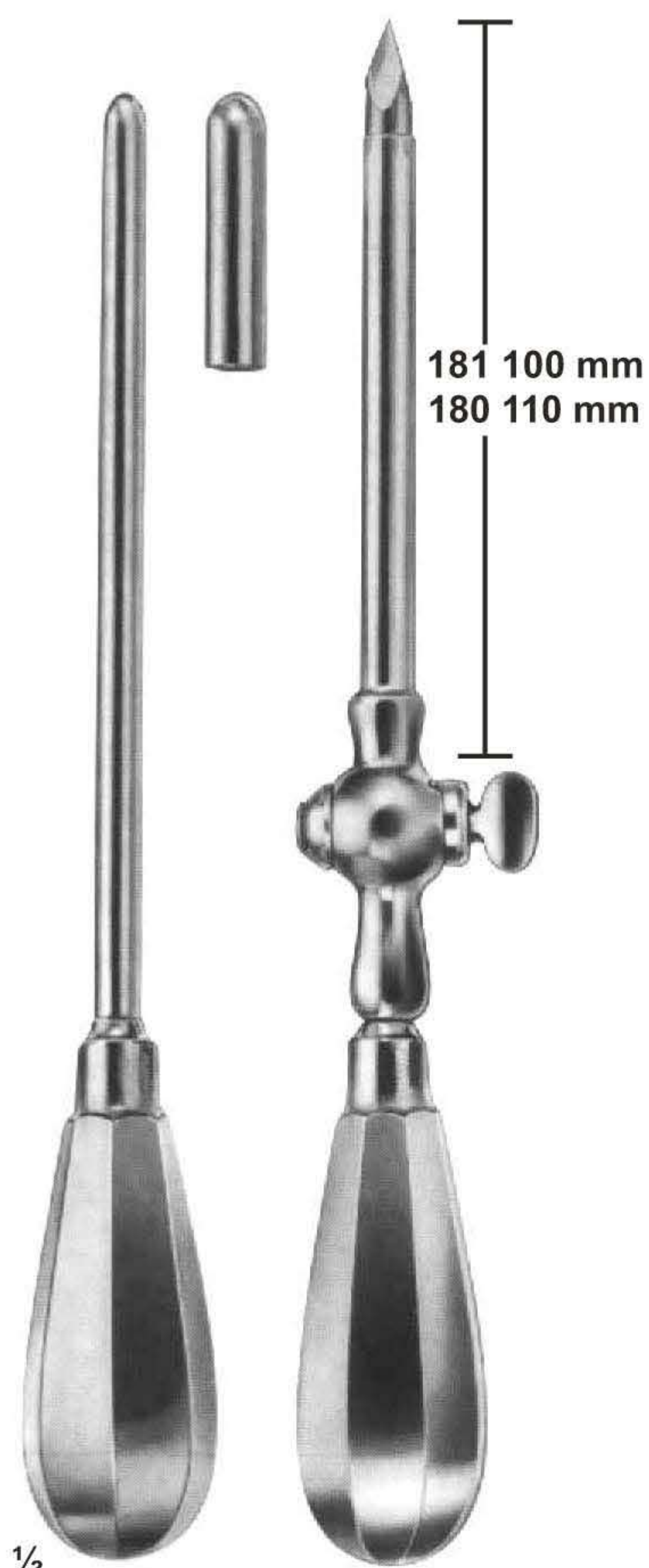

UG-1176  
Inside dime. Outside dime  
6,5 mm 8,0 mm  
9,0 mm 10,0 mm  
Empyema trocar

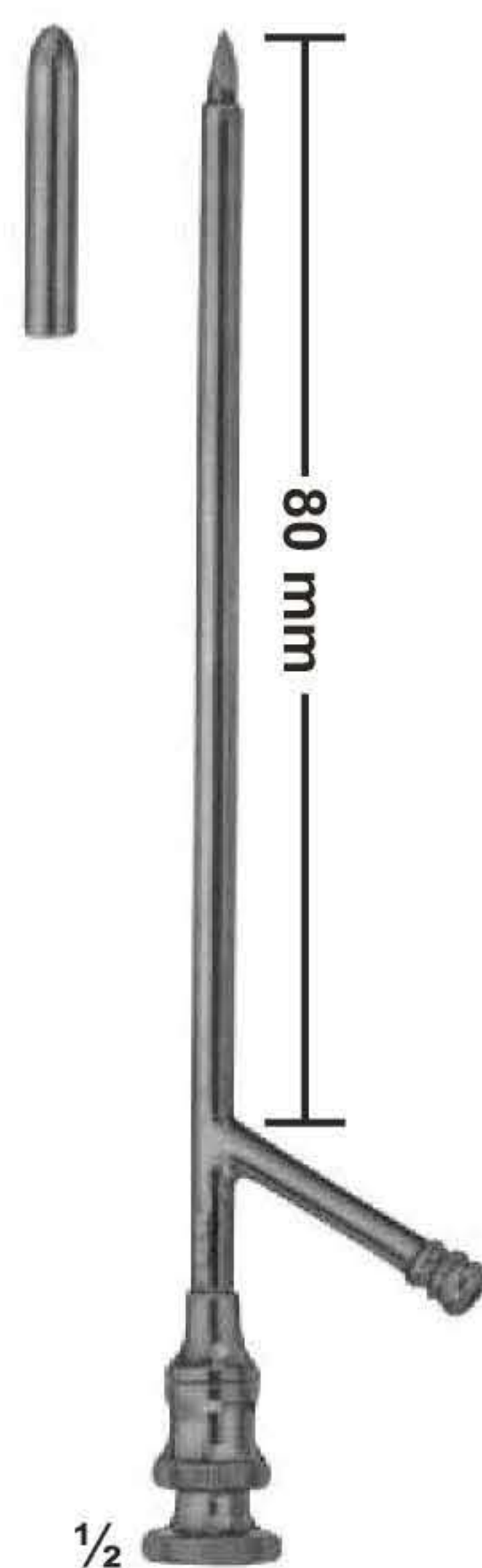

UG-1177  
Inside dime. Outside dime  
3,0 mm 4,0 mm  
3,6 mm 4,6 mm  
4,3 mm 5,3 mm  
5,0 mm 6,0 mm  
Gall bladder trocars



UG-1180  
PIERCE  
Antrum trocar  
4,0 mm



UG-1181  
COAKLEY  
Antrum trocar  
3,0 mm

# Vaginal specula

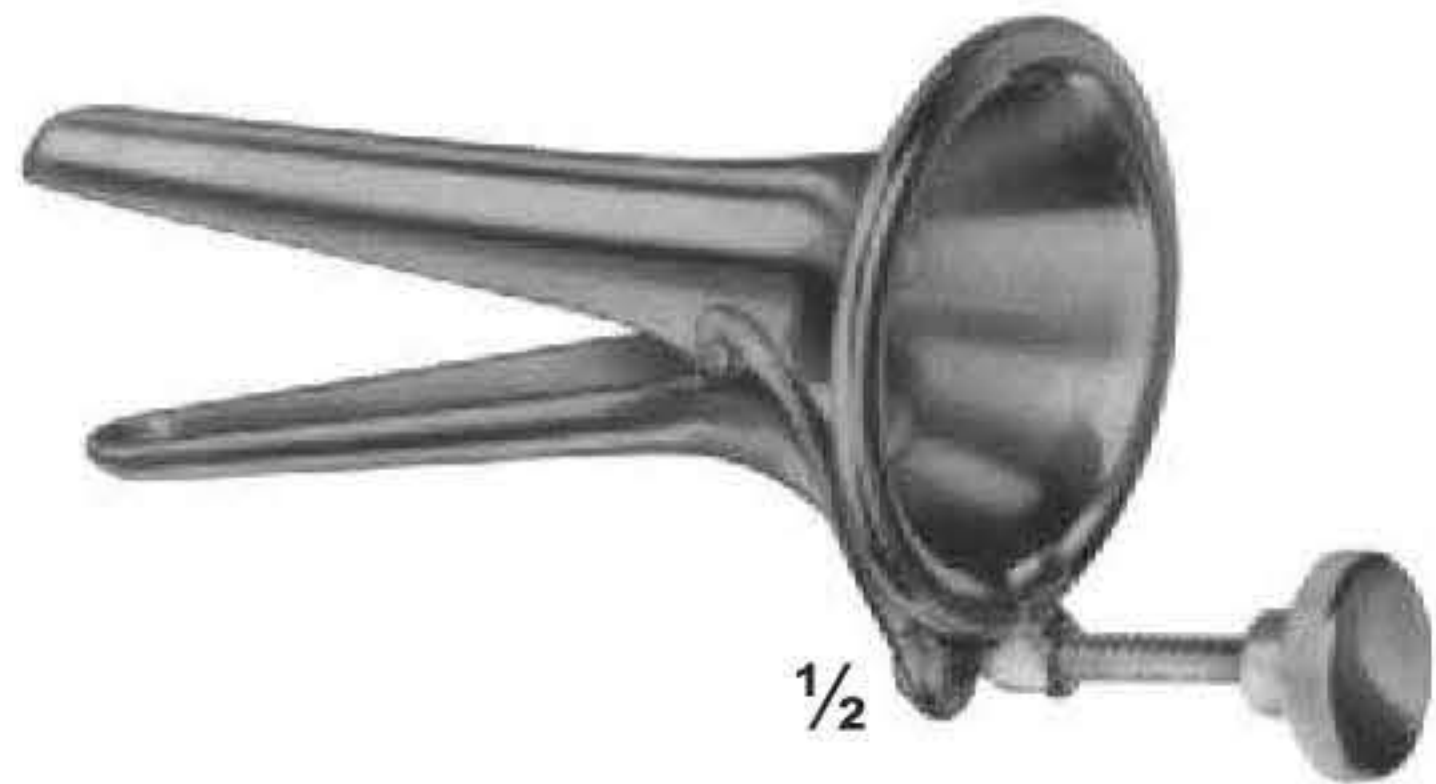

UG-835  
COLLIN  
for children  
53 x 10 mm

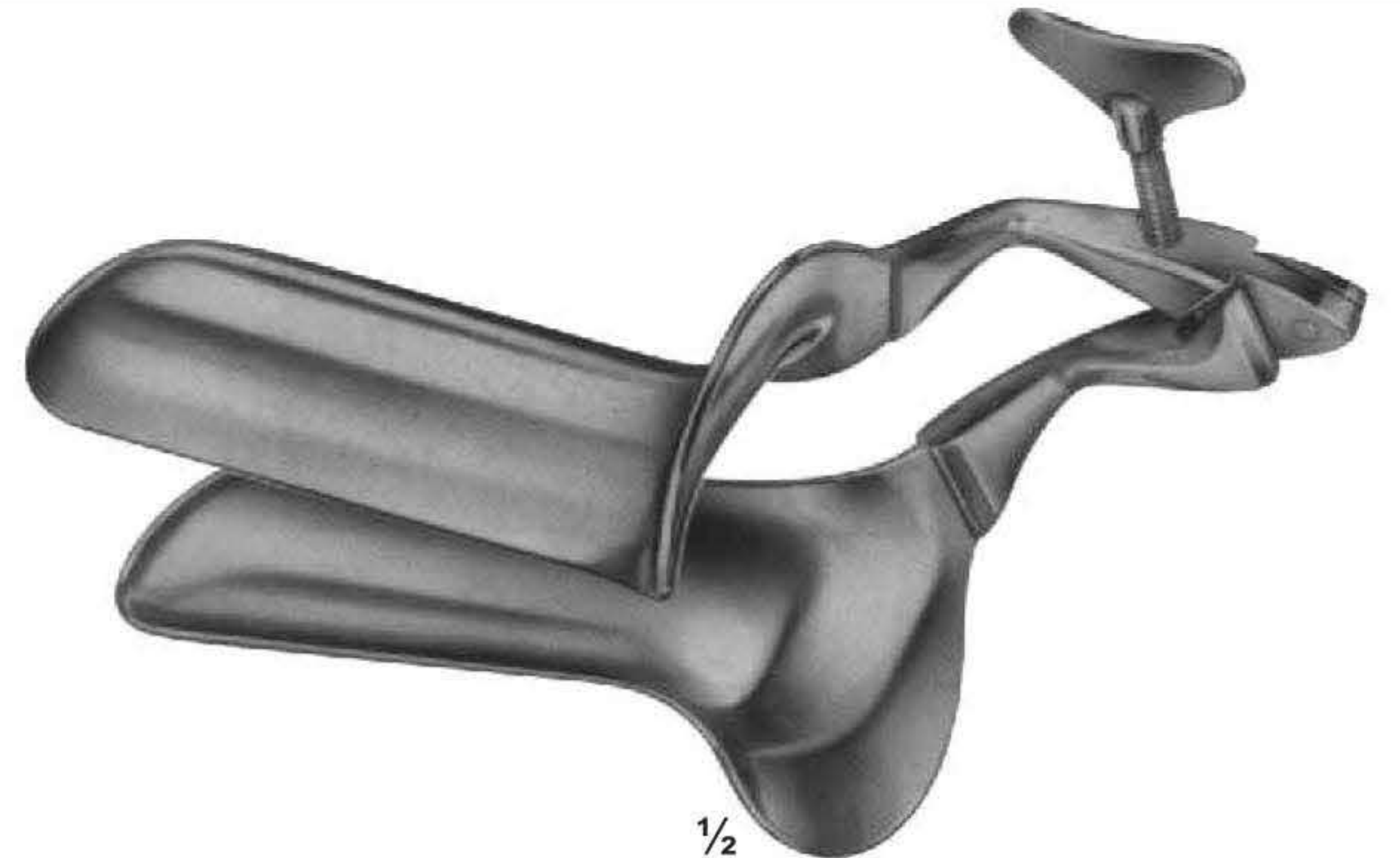

UG-837  
COLLIN

100/90mm	28 mm
100/90mm	32 mm
105/95mm	35 mm
115/105mm	40 mm

Total length/working length width

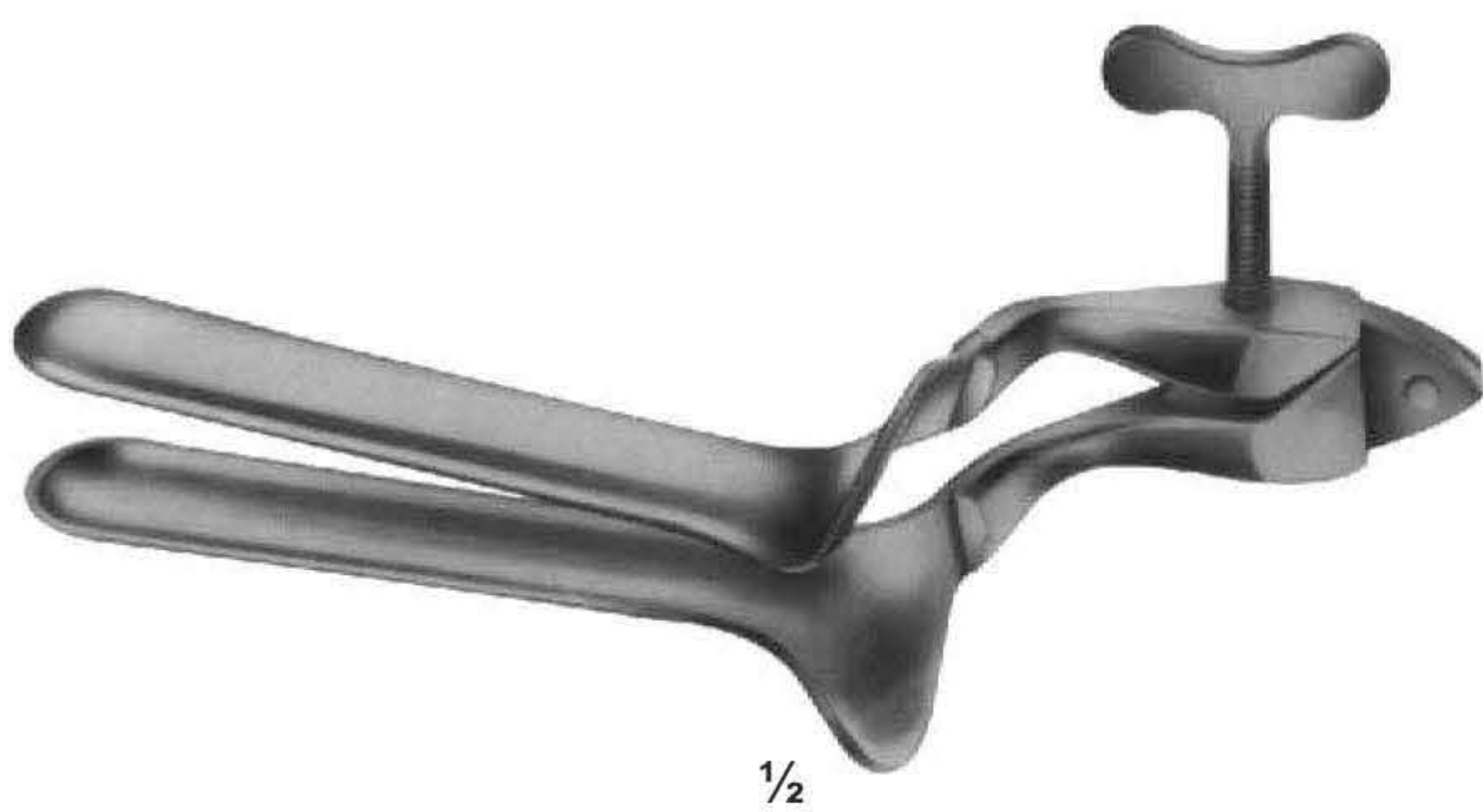

UG-843  
COLLIN  
for virgins  
95/85 x 18 mm



UG-846  
CUSCO  
for virgins  
75 x 17 mm



UG-847  
CUSCO  
for virgins  
75 x 17 mm



UG-849  
CUSCO

92X23-25 mm
100x25-27 mm
110x27-30 mm

# Vaginal Specula



1/2

UG-851  
CUSCO  
STANDARD  
80X24 mm  
80X32 mm  
90X36 mm  
110X37 mm

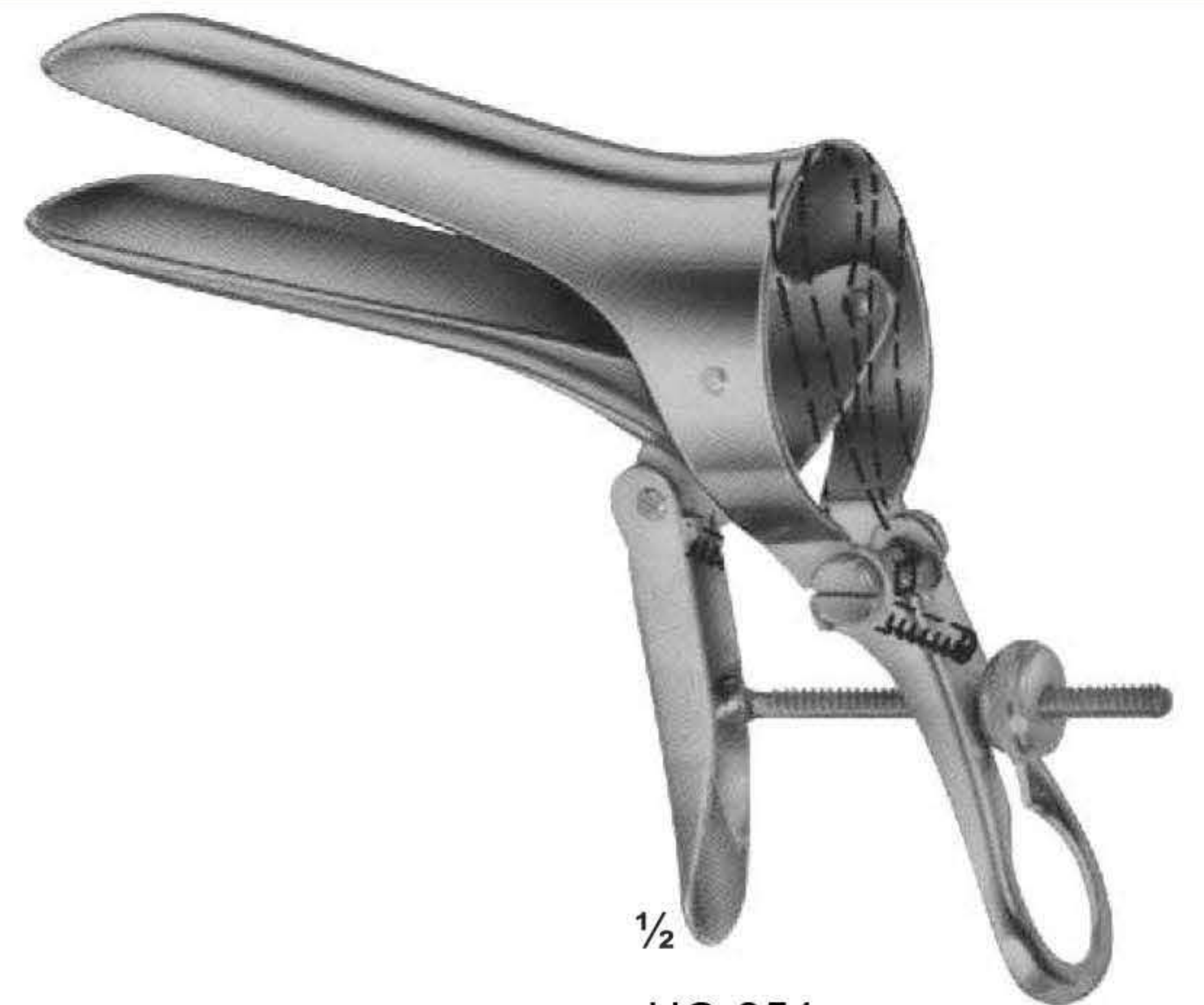

1/2

UG-854  
CUSCO  
80X24 mm  
80X32 mm  
90X36 mm  
110X37 mm



1/2

UG-858  
CUSCO  
80X24 mm  
80X32 mm  
115X36 mm



1/2

UG-863  
SEYFFERT  
100X24 mm  
110X32 mm  
230 mm



1/2

UG-864  
SEMM  
for children  
and virgins  
180 mm

# Vaginal Specula, Sets, Upper & Lower Blades



UG-866  
GRAVE  
75X20 mm  
95X30 mm  
105X33 mm  
1/2



UG-867  
PEDERSON  
100X22 mm  
120X25 mm  
1/2

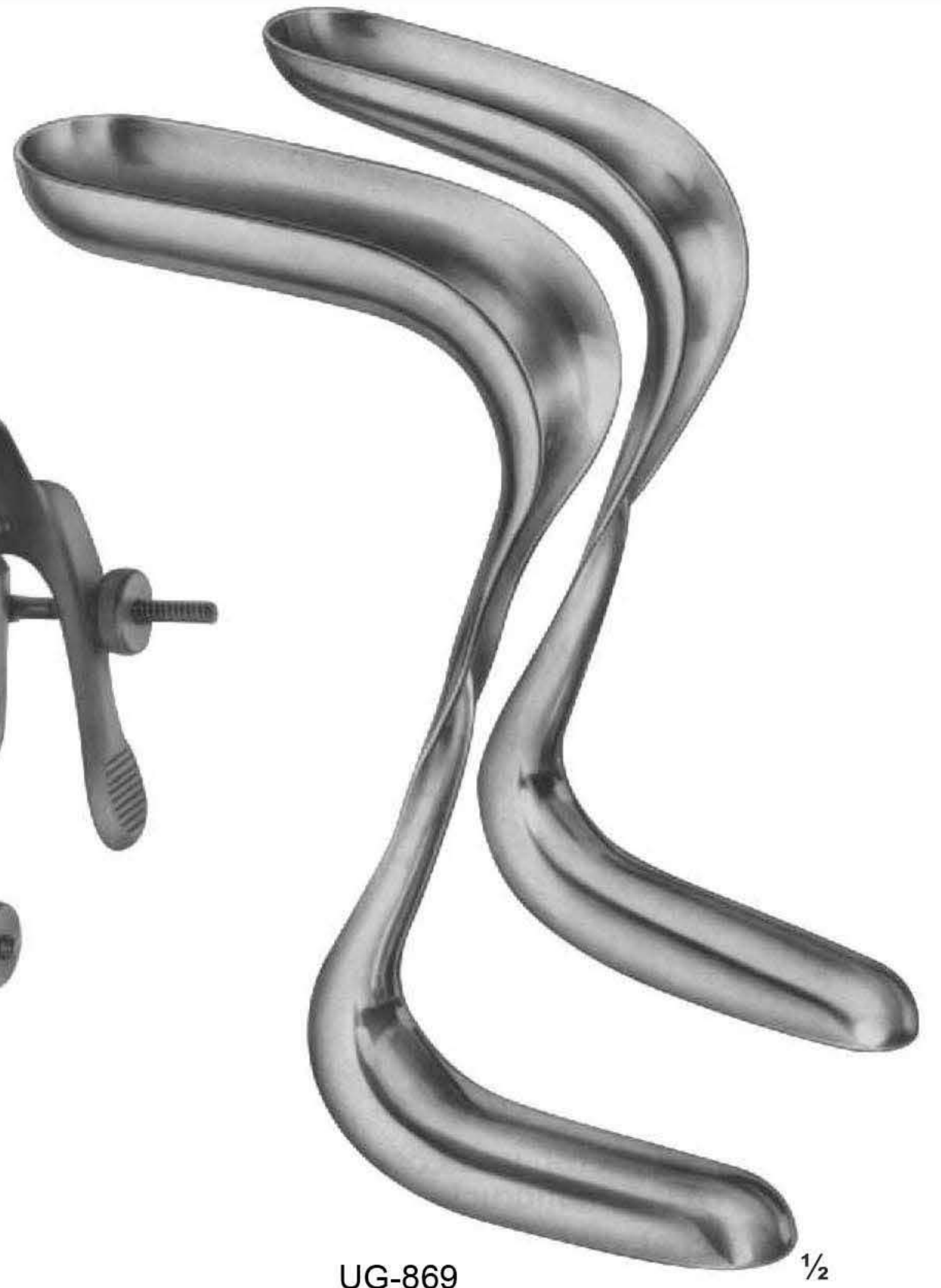

UG-869  
BRIESKY  
72X25 mm / 77X30 mm  
75X30 mm / 92X38 mm  
170 mm  
1/2



UG-887  
BREISKY  
100X22 mm  
77 X30 mm  
140 mm  
120X25 mm  
92 X38 mm  
170 mm  
1/2

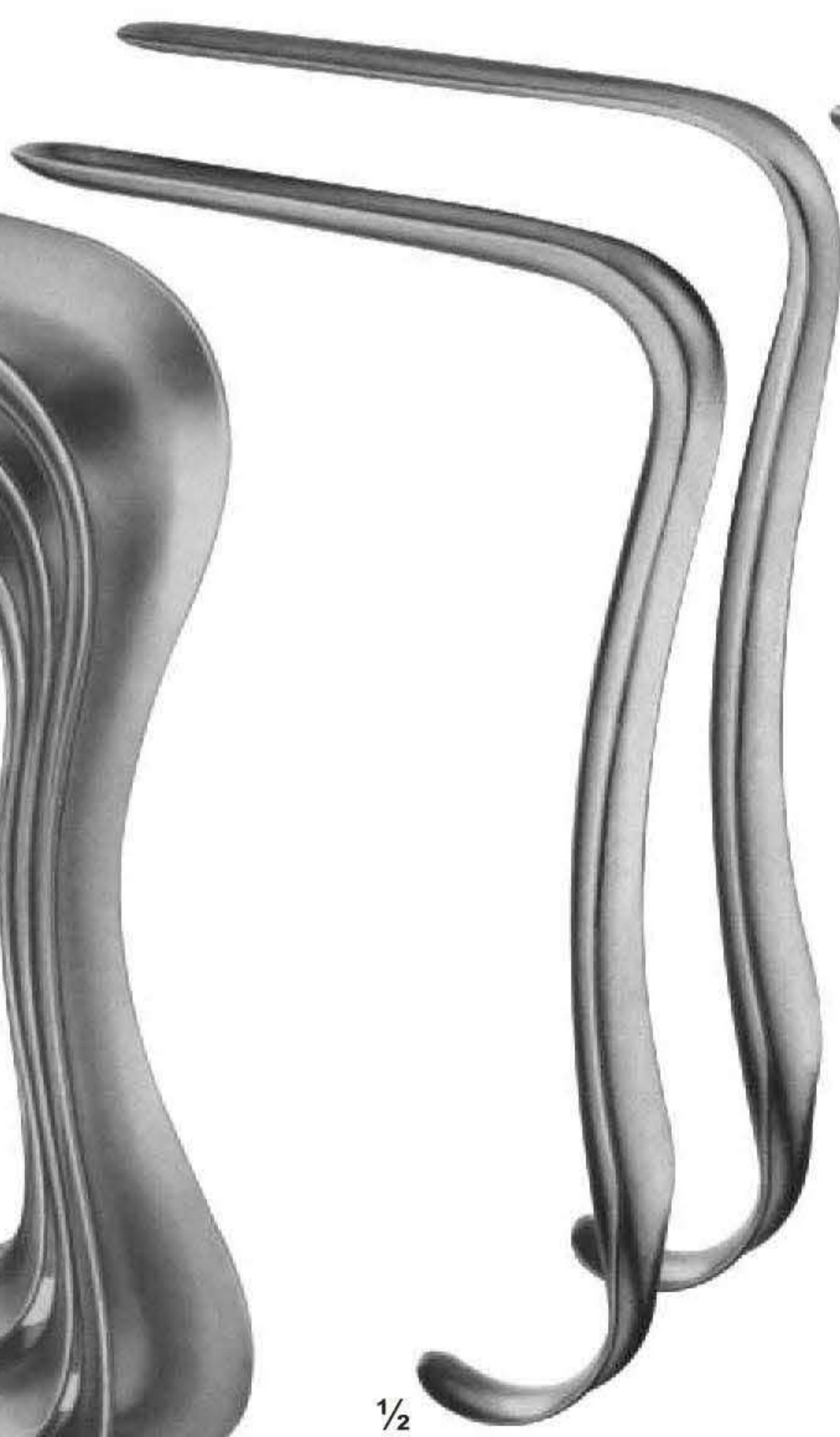

UG-888  
SEIDL  
80X8 mm  
80X10 mm  
90X14 mm  
For children and infants  
170 mm  
1/2



UG-889  
KRISTELLER  
70X15 mm, ( 170 mm )  
For children  
1/2



UG-890  
SIMS  
70X26 mm  
75 X30 mm 125 mm  
75X30 mm  
80 X85 mm 150 mm  
80X36 mm  
90 X40 mm 175 mm  
1/2

## Vaginal Specula-Sets, upper and lower blades



UG-891  
KRISTELLER  
110X18 mm  
110X20 mm  
110X27 mm  
110X30 mm  
110X36 mm  
220 mm



UG-892  
KRISTELLER  
Upper blades



UG-894  
KRISTELLER  
Lower blades

## Vaginal Specula-upper and lower blades

---



UG-899  
KRISTELLER  
Upper blades

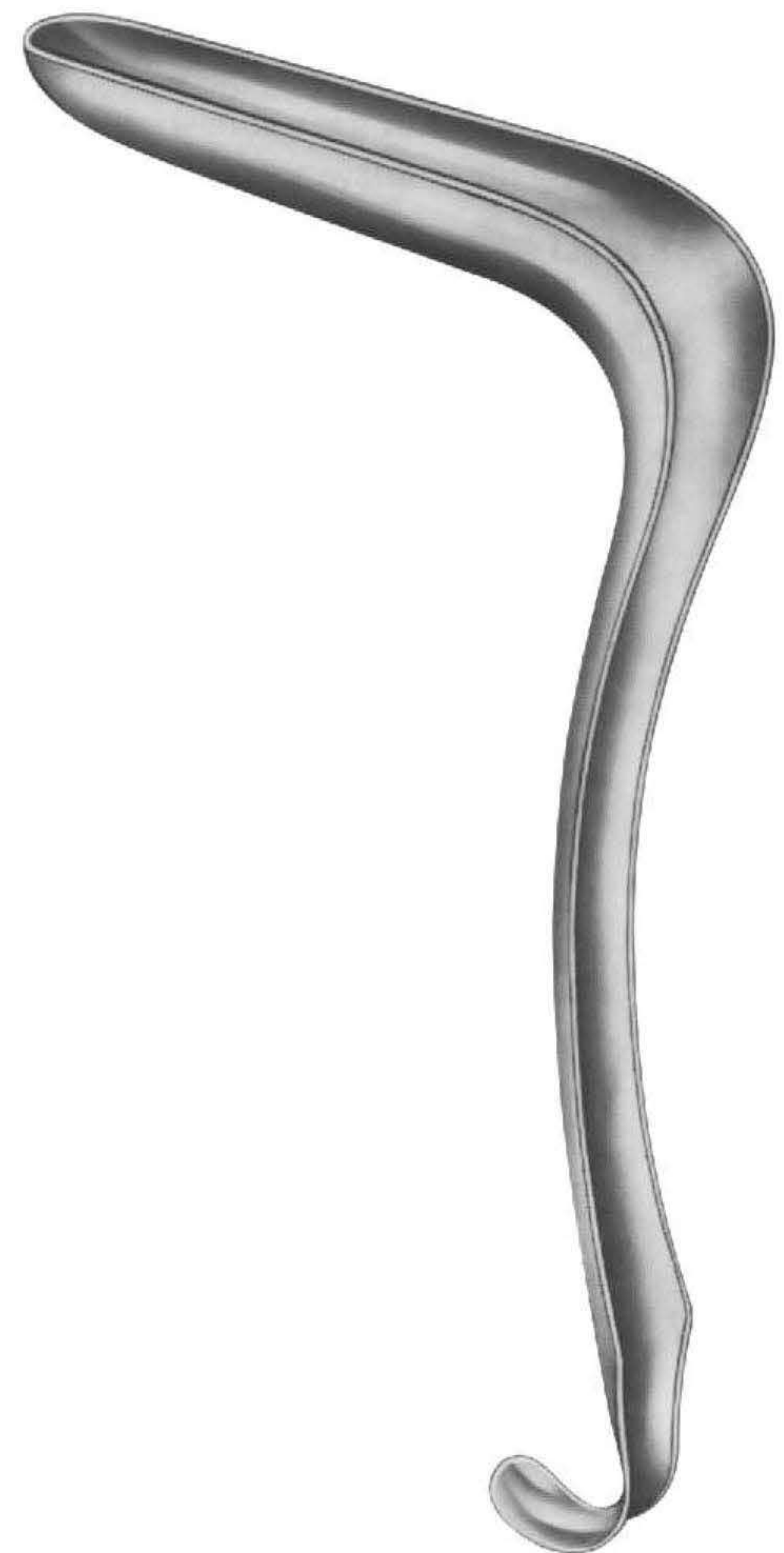

UG-901  
KRISTELLER  
Lower blades

# Vaginal Specula



$\frac{1}{2}$   
UG-903  
KRISTELLER  
205 mm



$\frac{1}{2}$   
UG-905  
JACKSON  
175 mm

# Vaginal Specula-for children & virgins / Vario Retractor



56 x 13 mm

1/2

UG-910  
BRAUN  
180 mm

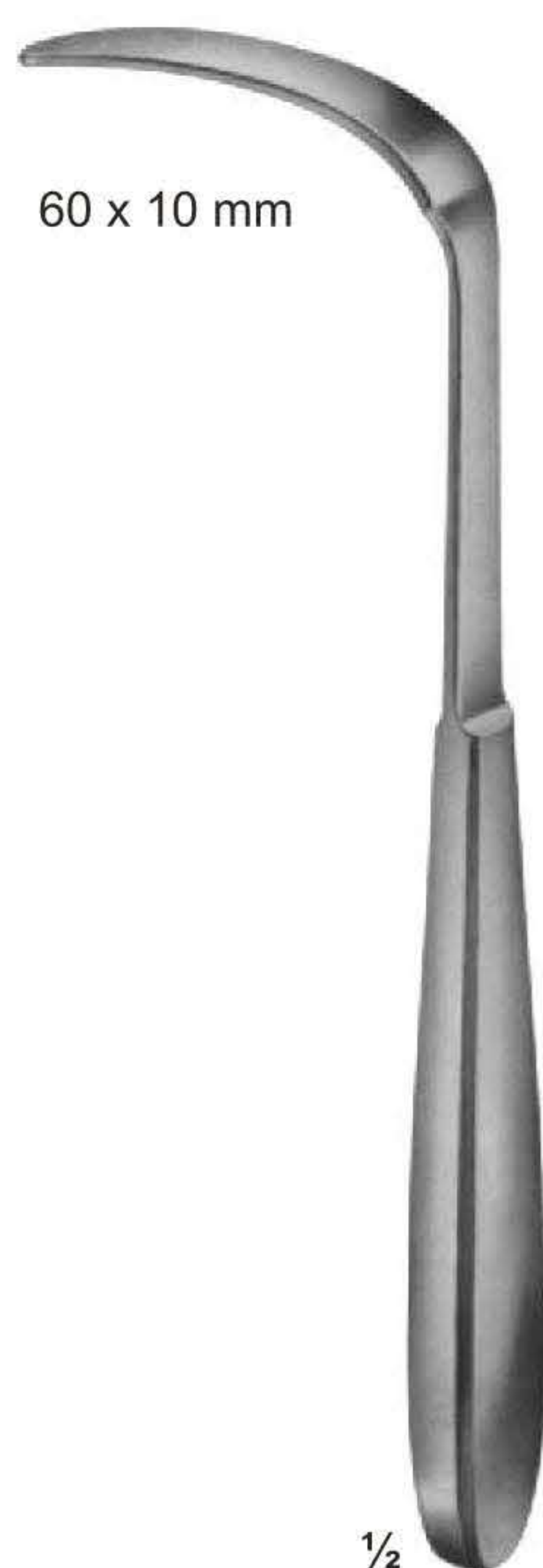

60 x 10 mm

1/2

UG-913  
BRAUN  
180 mm



95 x 17 - 30 mm

1/2

UG-915  
MATHIEU  
For children  
and virgins  
210 mm



95 x 17-26 mm

1/2

UG-919  
MATHIEU  
for children and  
virgins fitting  
210 mm



UG-920  
Handle with cold light  
carrier for upper blades  
280 mm

1/2



# Vaginal Specula-for children and virgins



1/2

UG-925  
DOYEN  
235 mm



1/2

1/2

UG-933

Length of blades  
60 mm  
90 mm  
120 mm  
160 mm

Width of blades  
35 mm    45 mm    60 mm

Width of blades  
35 mm    45 mm    60 mm

# Vaginal Specula / Retractors



1/2

UG-941  
BREISKY  
WIENER MODELL/  
VIENNA PATTERN  
100 X 20 mm  
100 X 25 mm  
100 X 30 mm  
100 X 35 mm  
100 X 40 mm

300 mm



1/2

UG-943  
BREISKY  
WIENER MODELL/  
VIENNA PATTERN  
130 X 20 mm  
130 X 25 mm  
130 X 30 mm  
130 X 35 mm  
130 X 40 mm

320 mm



1/2

UG-948  
WEISSBARTH  
80 X 28 mm  
85 X 42 mm  
210 mm



1/2

UG-951  
DOYEN  
lateral speculum  
80 x 30 mm  
250 mm

# Vaginal & Wound Retractor / Vaginal Specula



UG-953  
SIMON  
115 X 22 mm  
275 mm



UG-955  
AUVARD  
65 X 38 mm - 28 mm  
1,530 kg  
with fixed weight  
230 mm



UG-957  
AUVARD  
75 X 42 mm  
( 40 mm )  
105 X 43 mm  
( 40 mm )  
with detachable wight  
230 mm



UG-959  
MARTIN  
with hook shaped  
handle for hanging  
in weights  
270 mm

# Vaginal Retractors



**UG-975**  
JOLL (FRIEDMAN)  
155 mm



**UG-976**  
RICHTER  
170 mm



**UG-979**  
GELPI  
135 mm



**UG-982**  
GELPI  
175 mm

# Uterine Dilators



1/2

UG-707  
HEGAR  
with very conical point  
185 mm



1/2

UG-711  
HEGAR  
205 mm

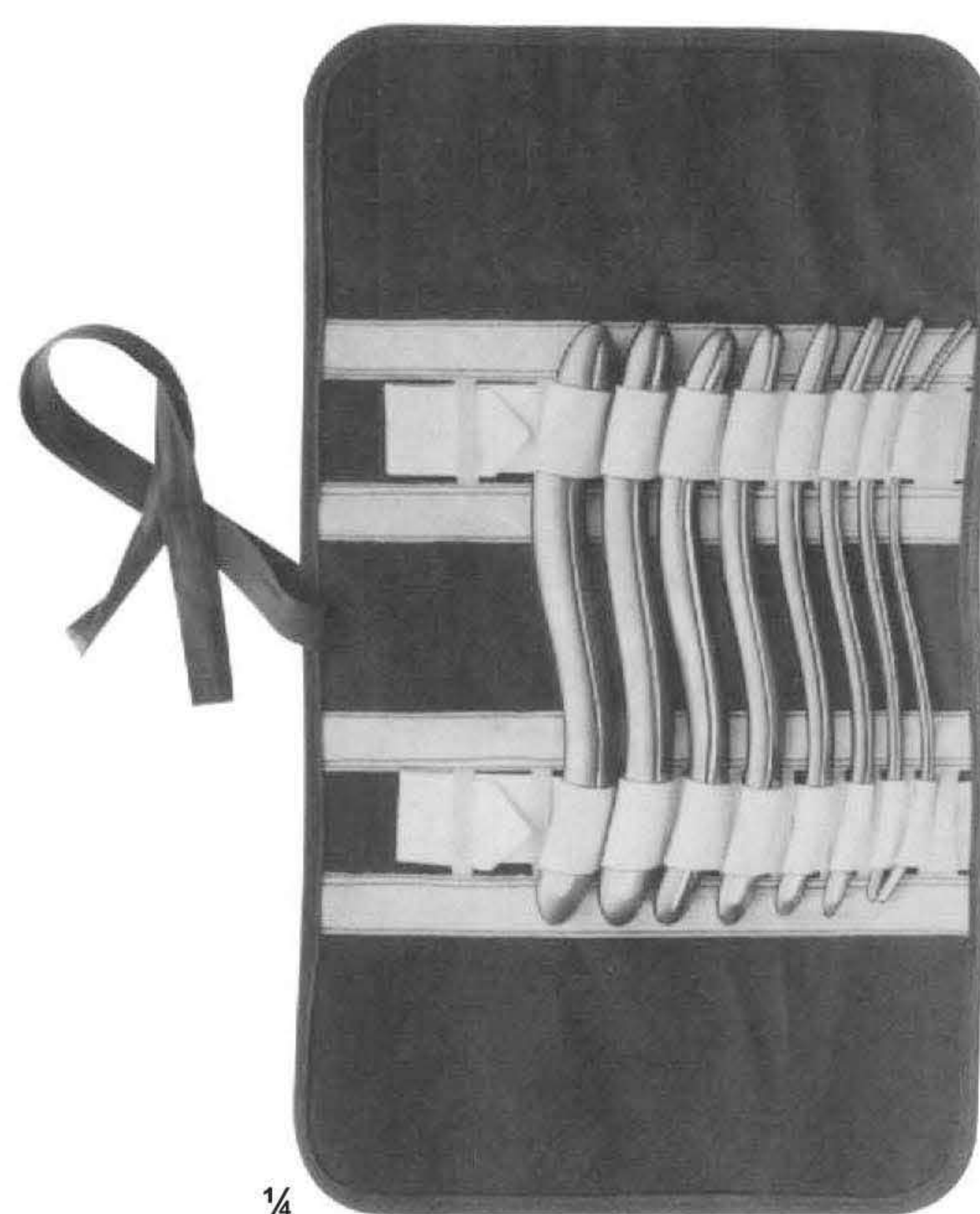

1/4

UG-714  
HEGAR  
Uterine dilator set, in canvas  
roll with 8 dilators.

## Uterine Dilators - Complete Sets



### UG-723

HEGAR

Dilator set consisting of:

- 14 Dilators,
- 1 Rack for dilators ( 4 - 12 mm )
- 1 Rack for Dilators ( 13 - 17 mm )
- 1 Metal case only,
- with hinged lid, stainless 200 X 100 X 35 mm

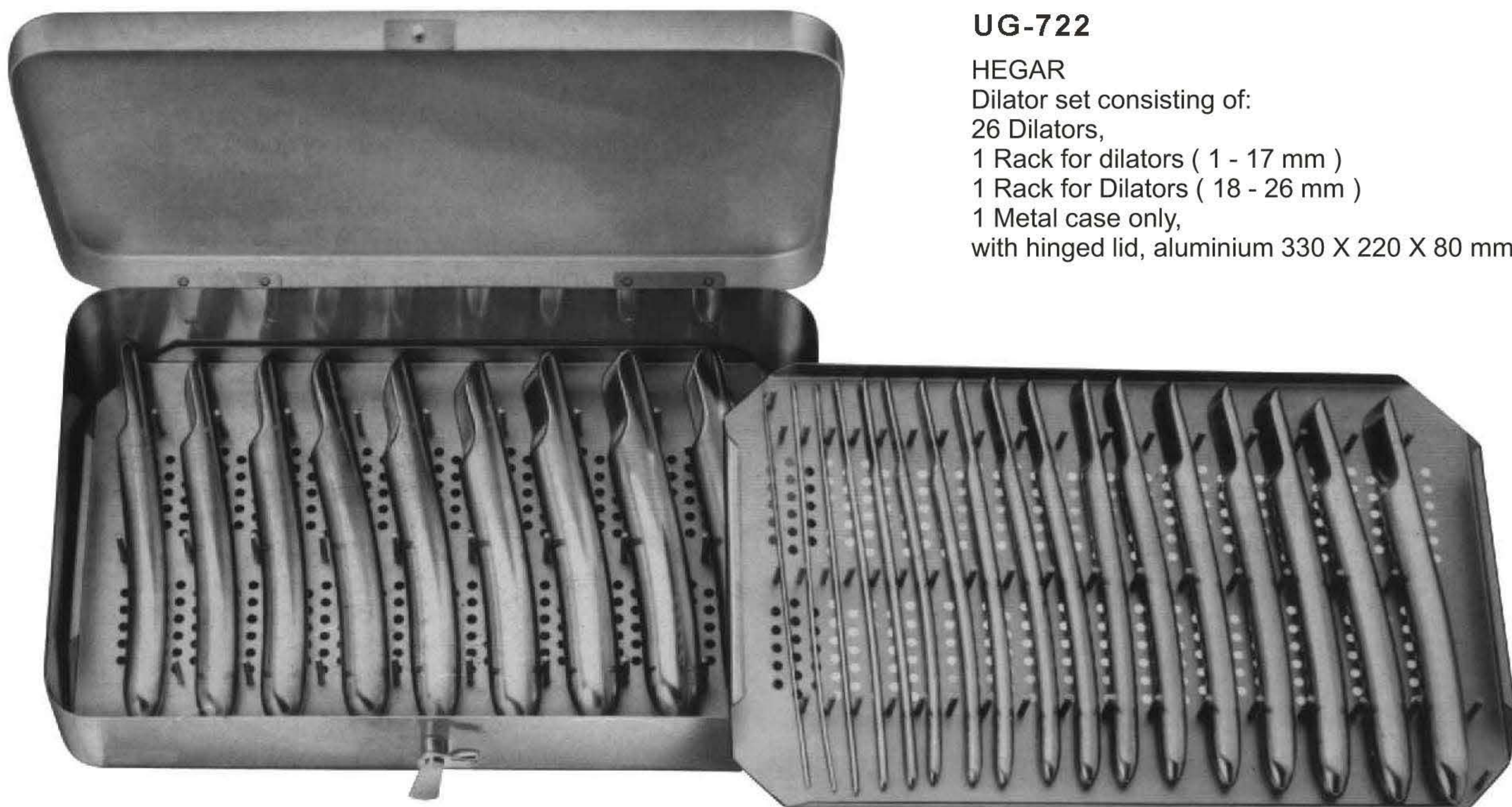

### UG-722

HEGAR

Dilator set consisting of:

- 26 Dilators,
- 1 Rack for dilators ( 1 - 17 mm )
- 1 Rack for Dilators ( 18 - 26 mm )
- 1 Metal case only,
- with hinged lid, aluminium 330 X 220 X 80 mm

# Endospecula For Cervix

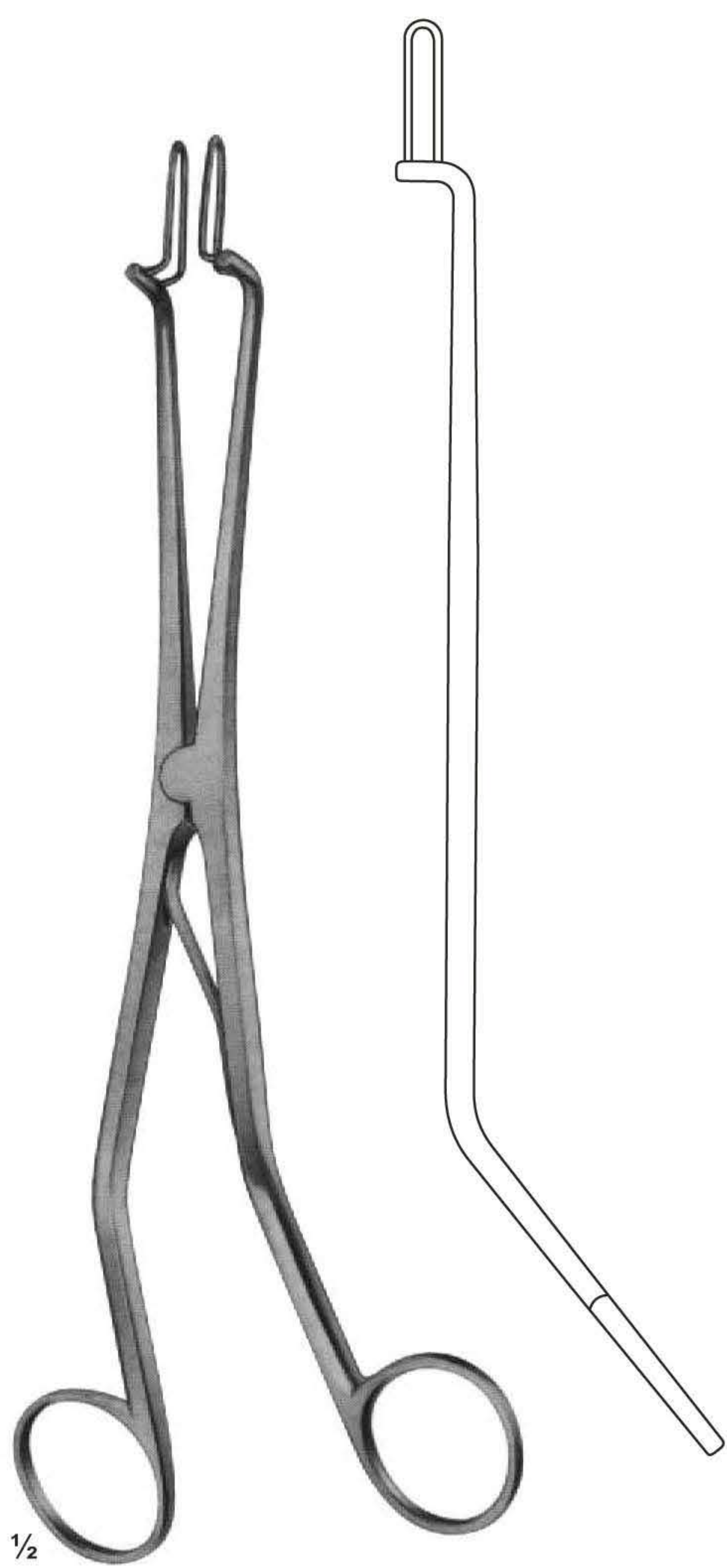

UG-725  
KOGAN  
Endospecula for cervix  
and urethra, without ratchet  
SIZE:185mm

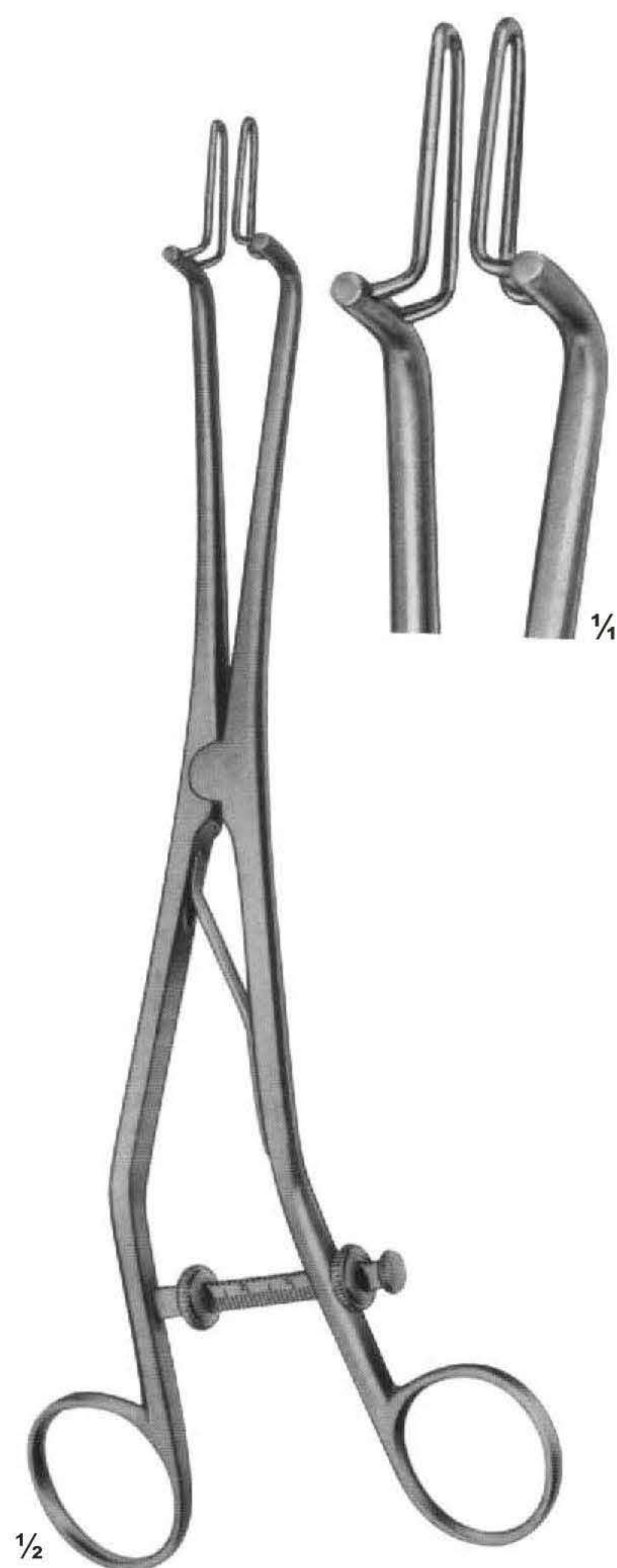

UG-726  
KOGAN  
Endospecula for cervix  
and urethra, with  
scale-ratchet and fixing screws  
SIZE:205mm

# Uterine Probes



UG-729  
MAYO  
biegsam malleable  
330 mm



UG-730  
SIMS  
biegsam malleable  
330 mm

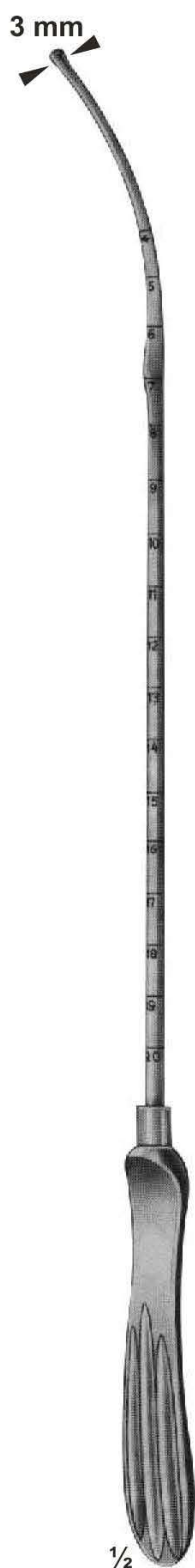

UG-731  
MARTIN  
330 mm



UG-733  
SIMPSON  
malleable  
silver-plated  
290 mm



UG-736  
BRAUN  
Uterine  
depressor  
270 mm



UG-739  
Cotton  
applicator  
270 mm



# Uterine Dressing Forceps

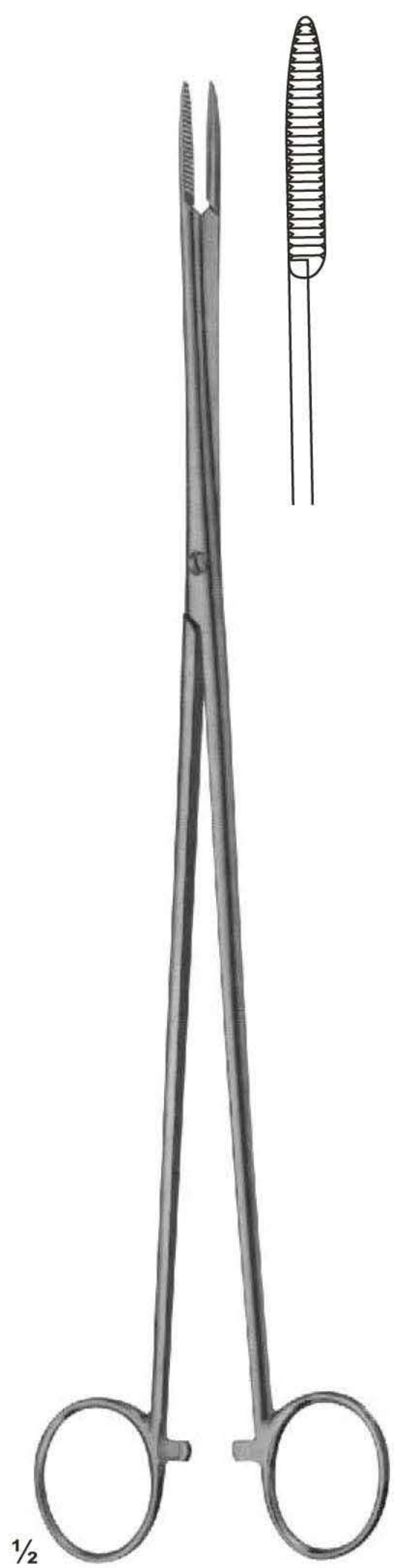

UG-744  
PELKMAN  
260 mm

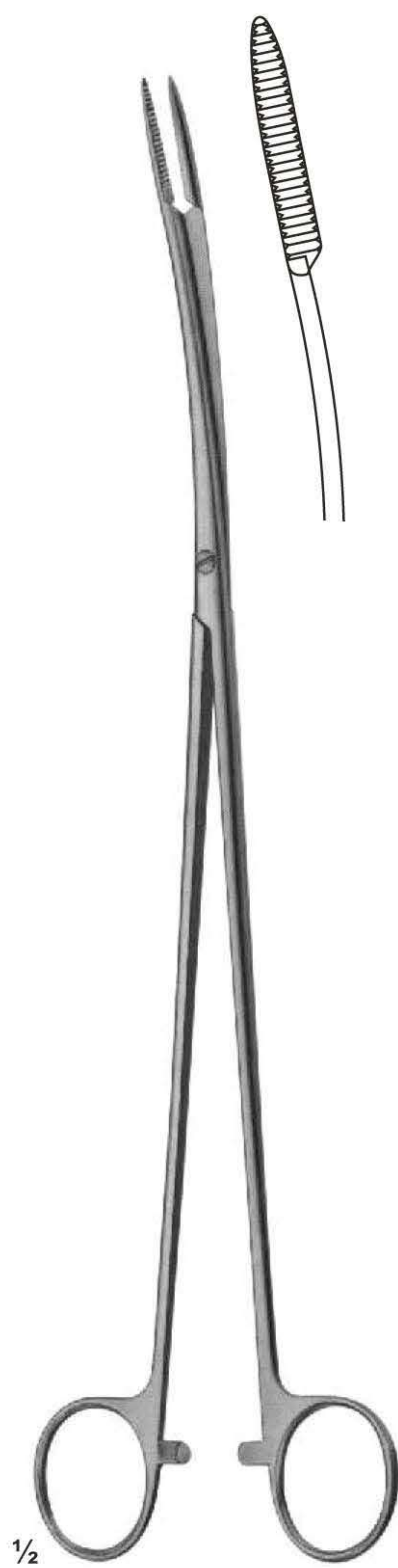

UG-745  
PELKMAN  
260 mm

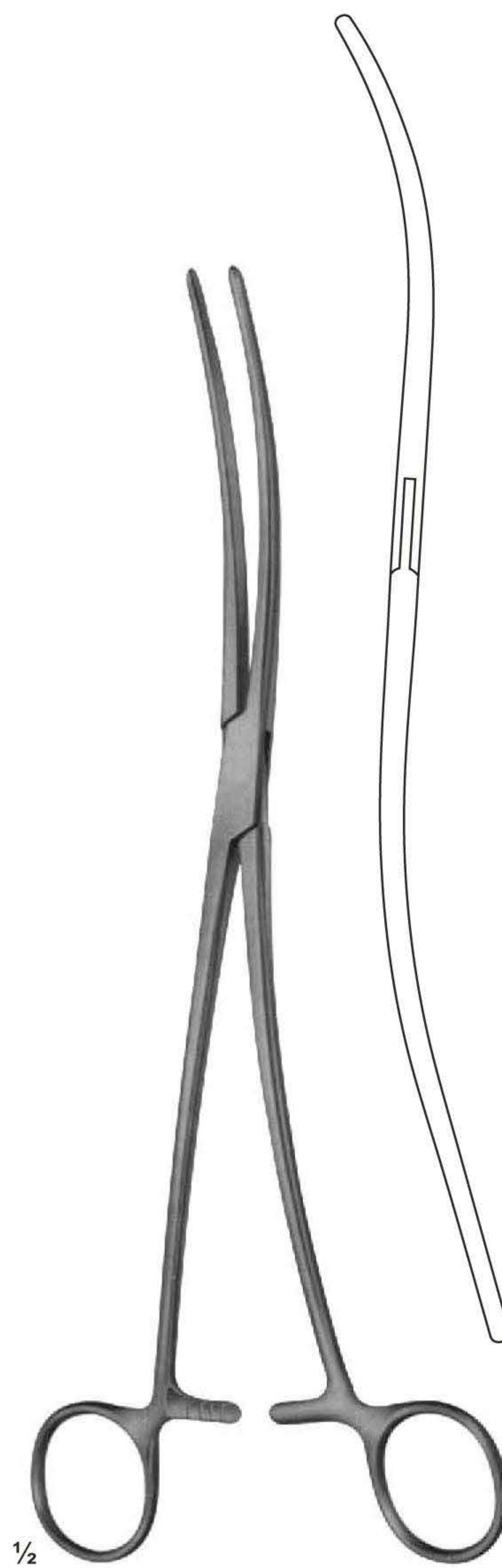

UG-747  
BOZEMANN  
250 mm

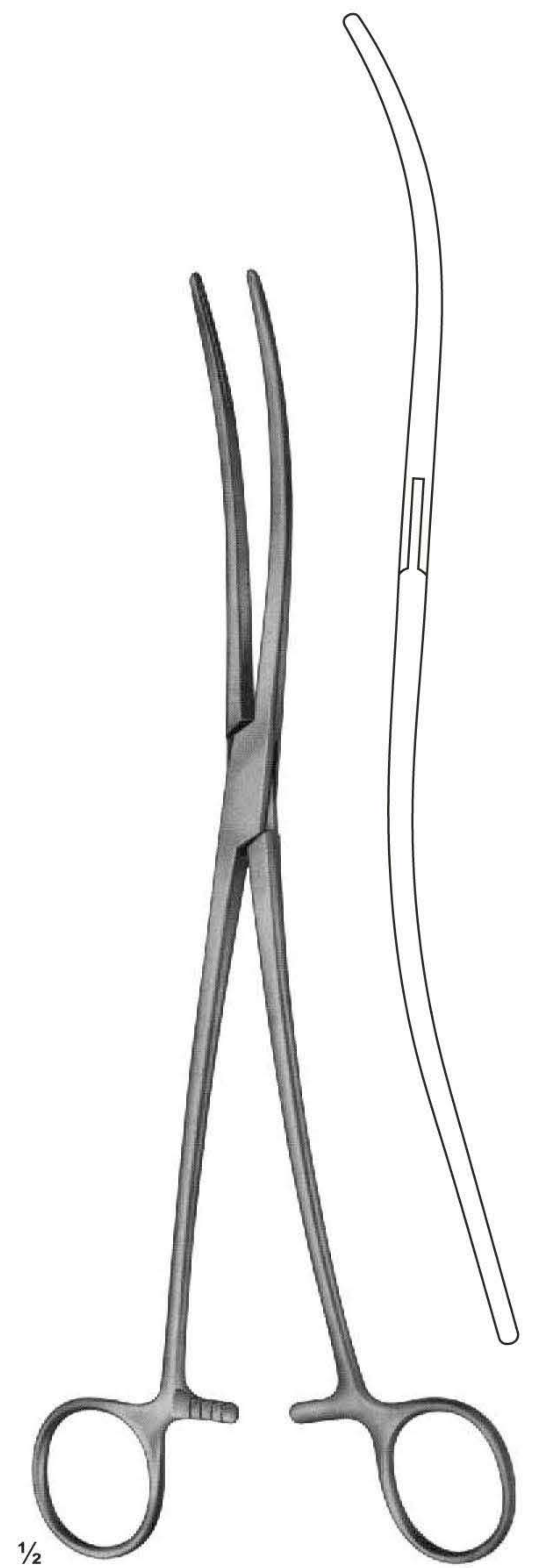

UG-748  
BOZEMANN  
255 mm

Jaws with longitudinal groove

# Uterine Dressing Forceps



UG-750  
BOZEMANN

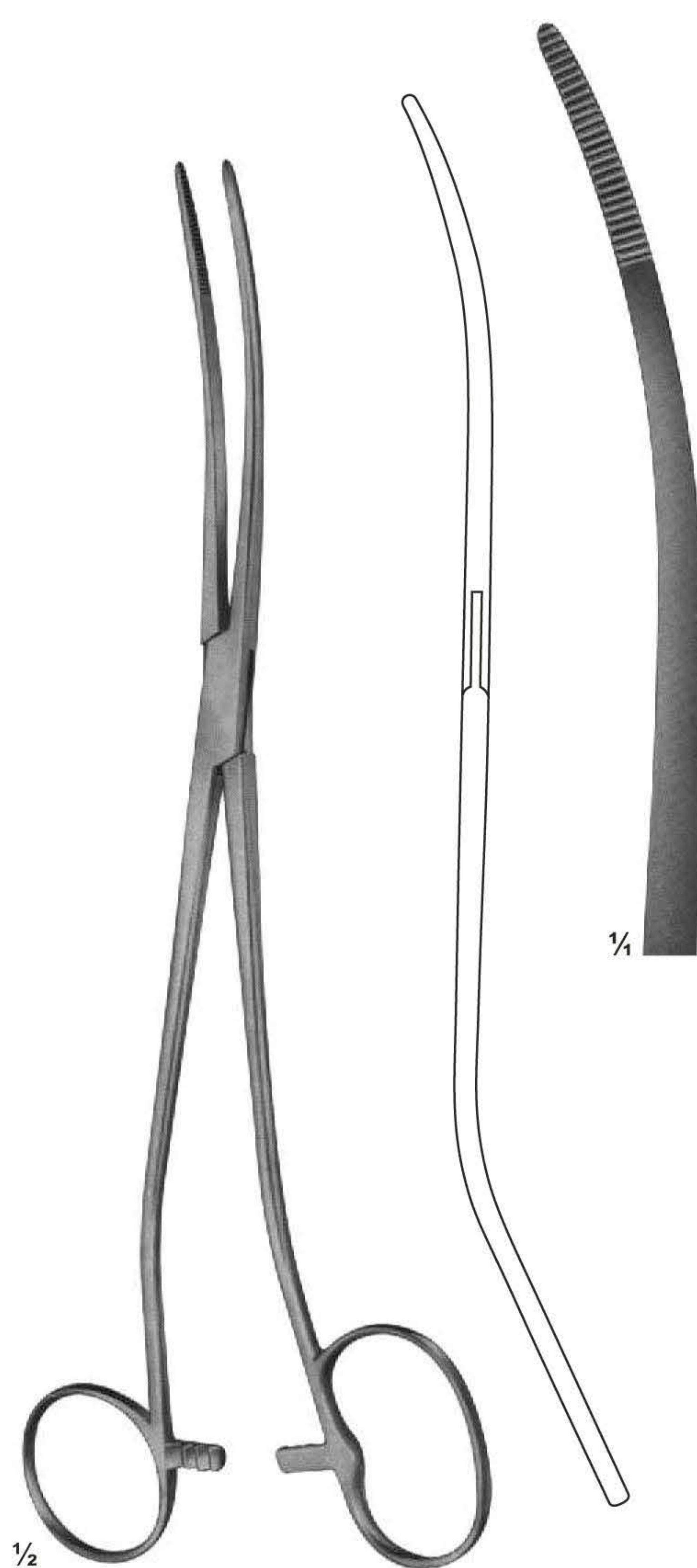

UG-752  
BOZEMANN-DOUGLAS  
260 mm

# Uterine Tenaculum Forceps

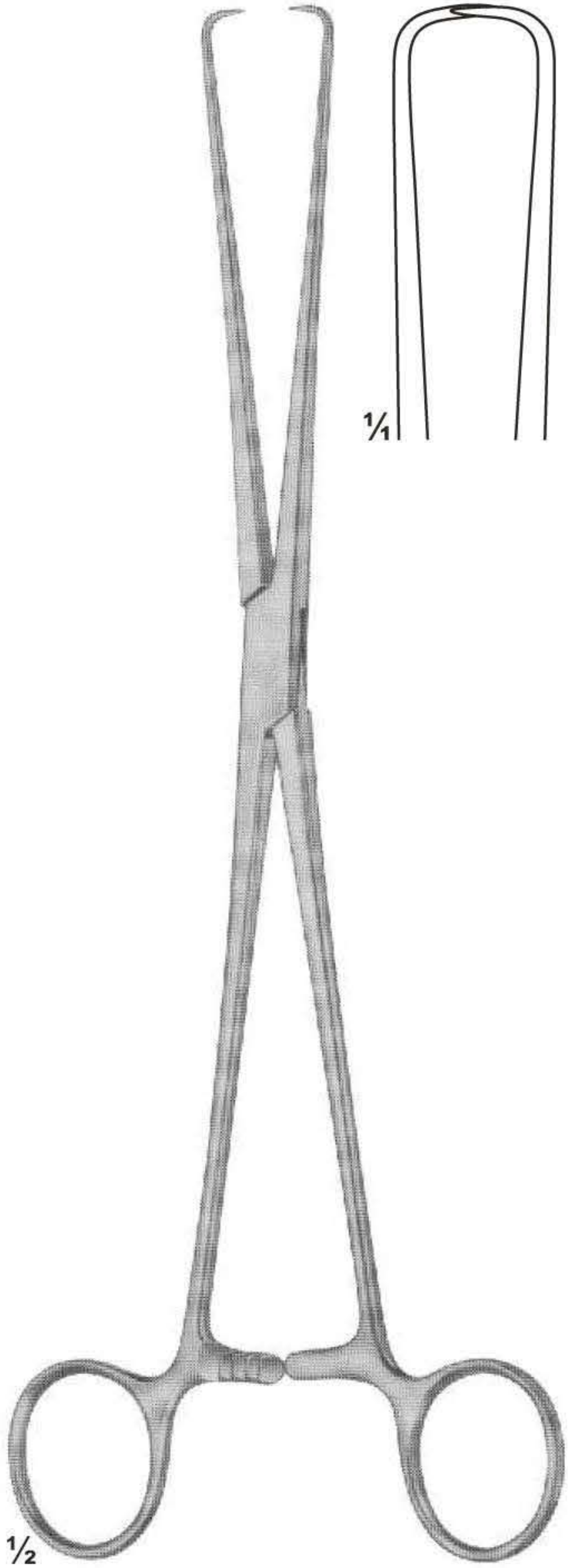

UG-754  
BRAUN  
slender type  
250 mm



UG-755  
SCHRODER  
250 mm

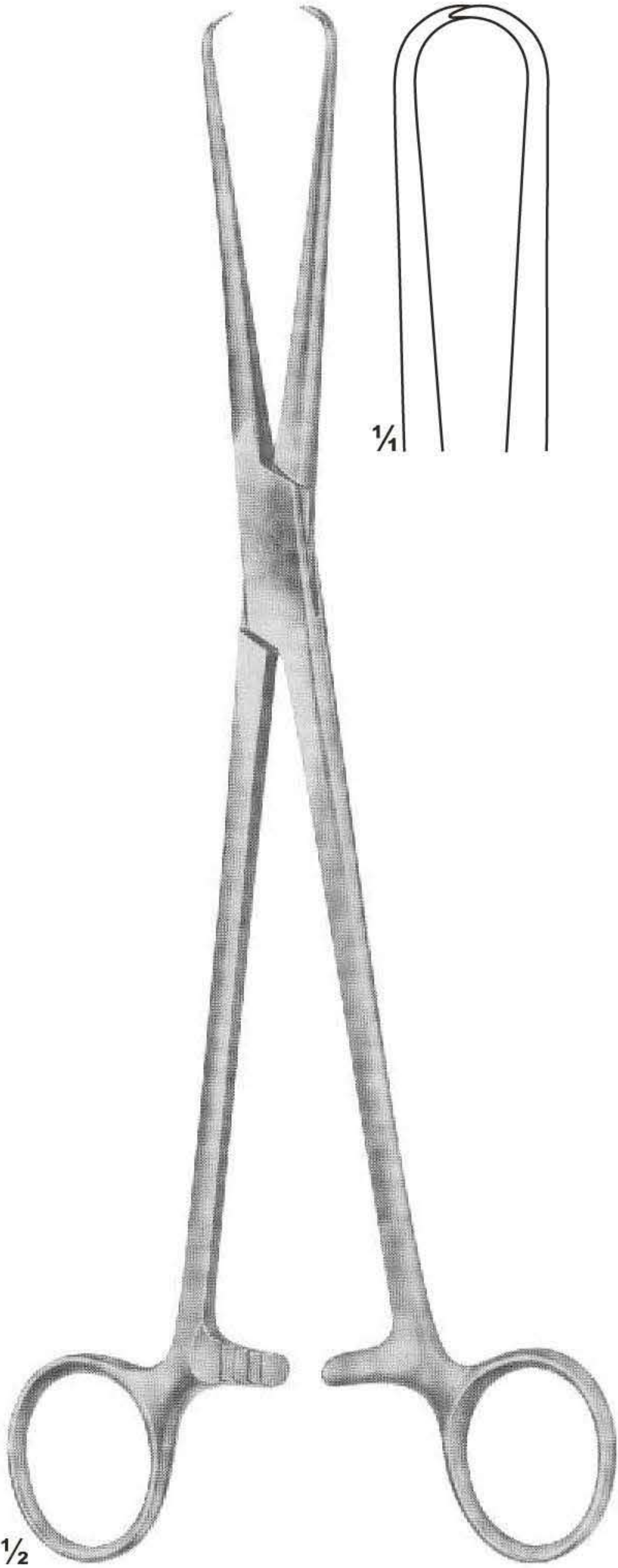

UG-756  
POZZI  
heavy type  
255 mm

# Uterine Tenaculum Forceps

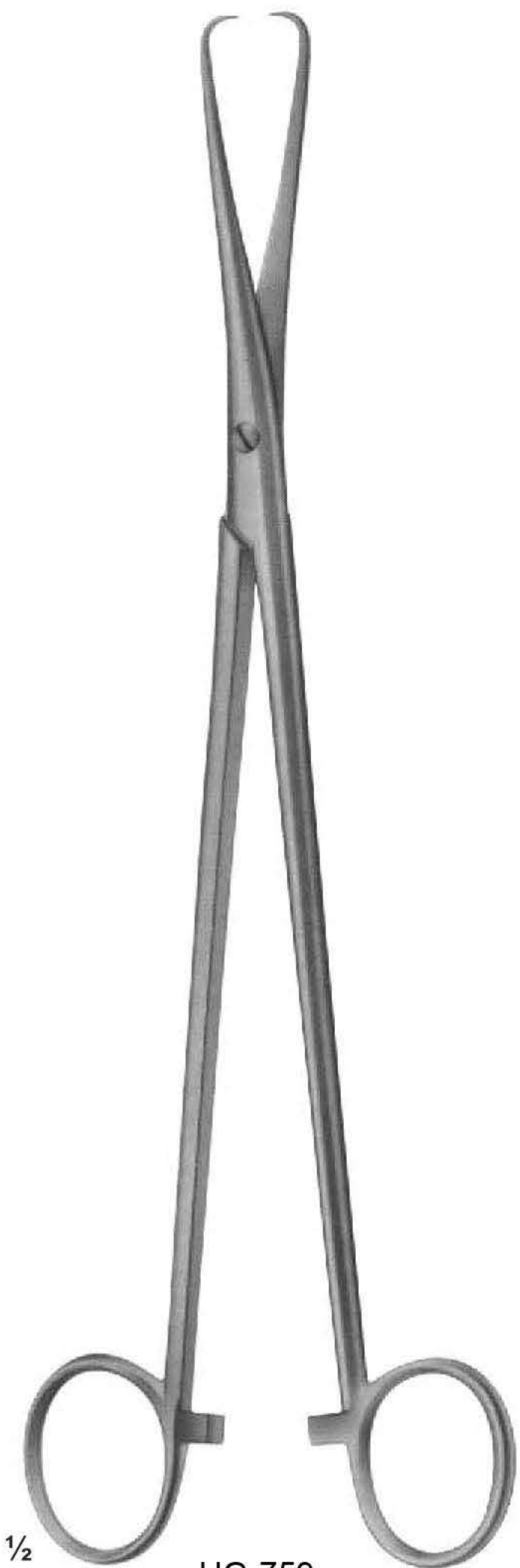

UG-759  
265 mm

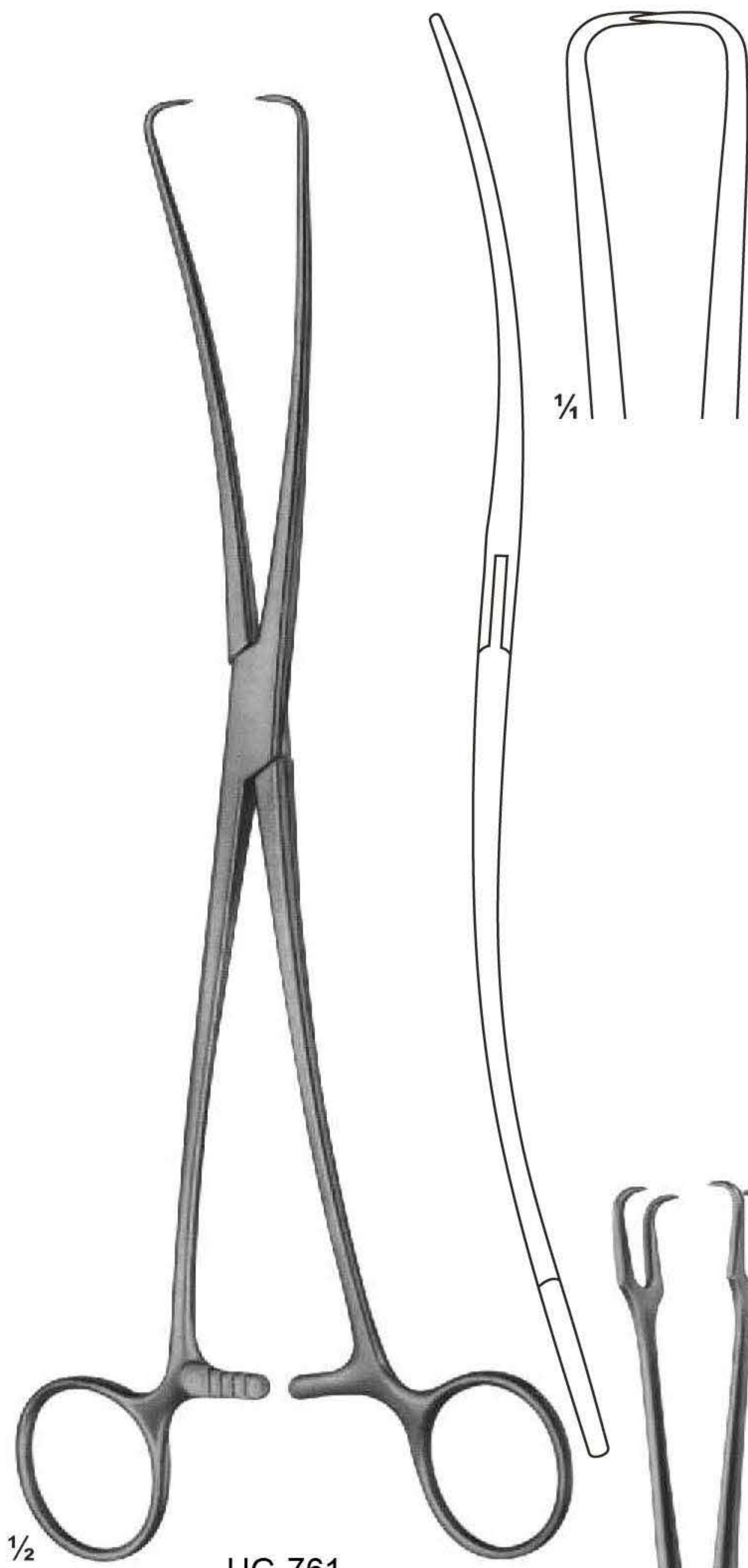

UG-761  
DUPLAY  
250 mm

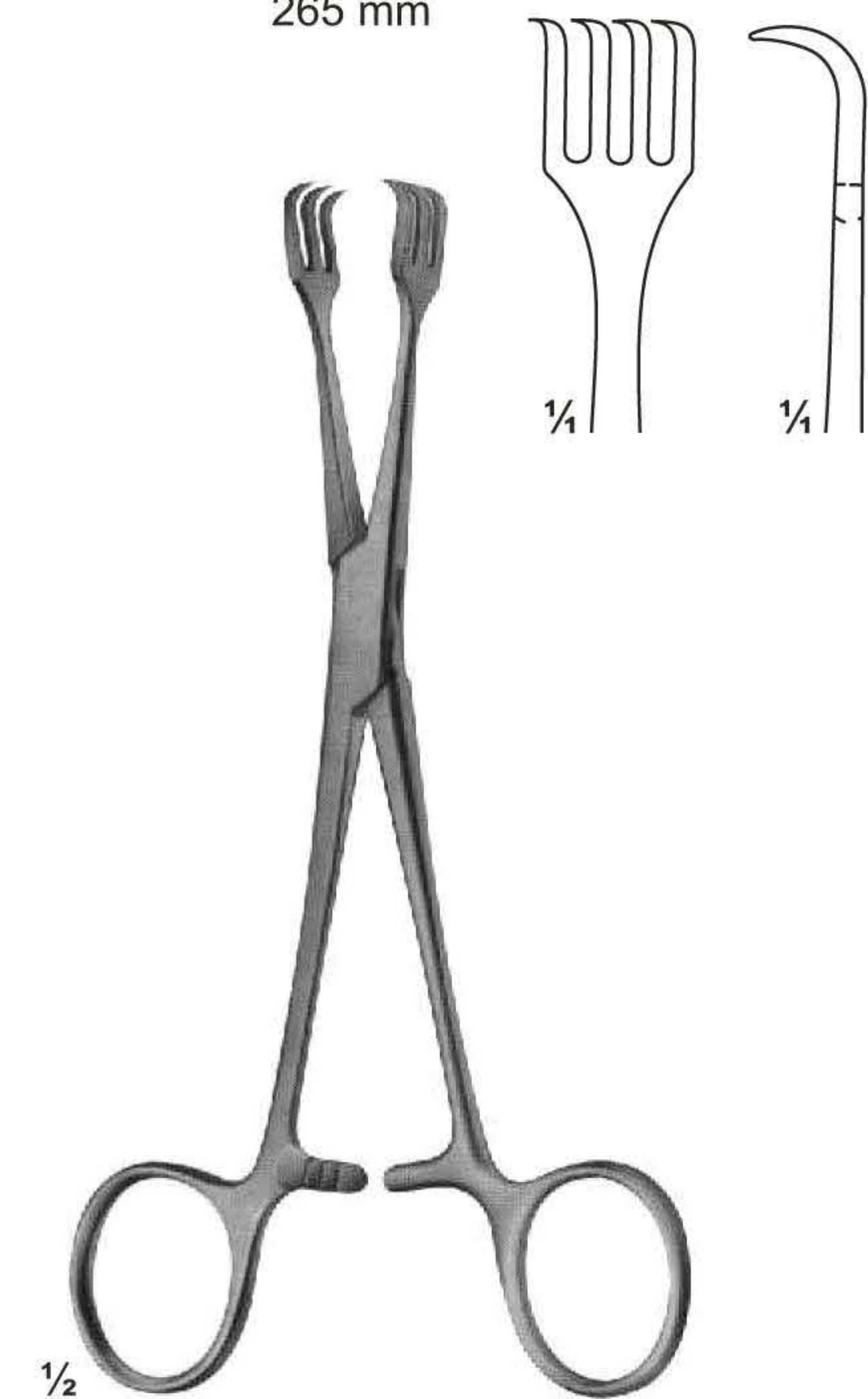

UG-762  
LAHEY  
155 mm



UG-764  
SCHRODER  
250 mm

# Uterine Tenaculum Forceps

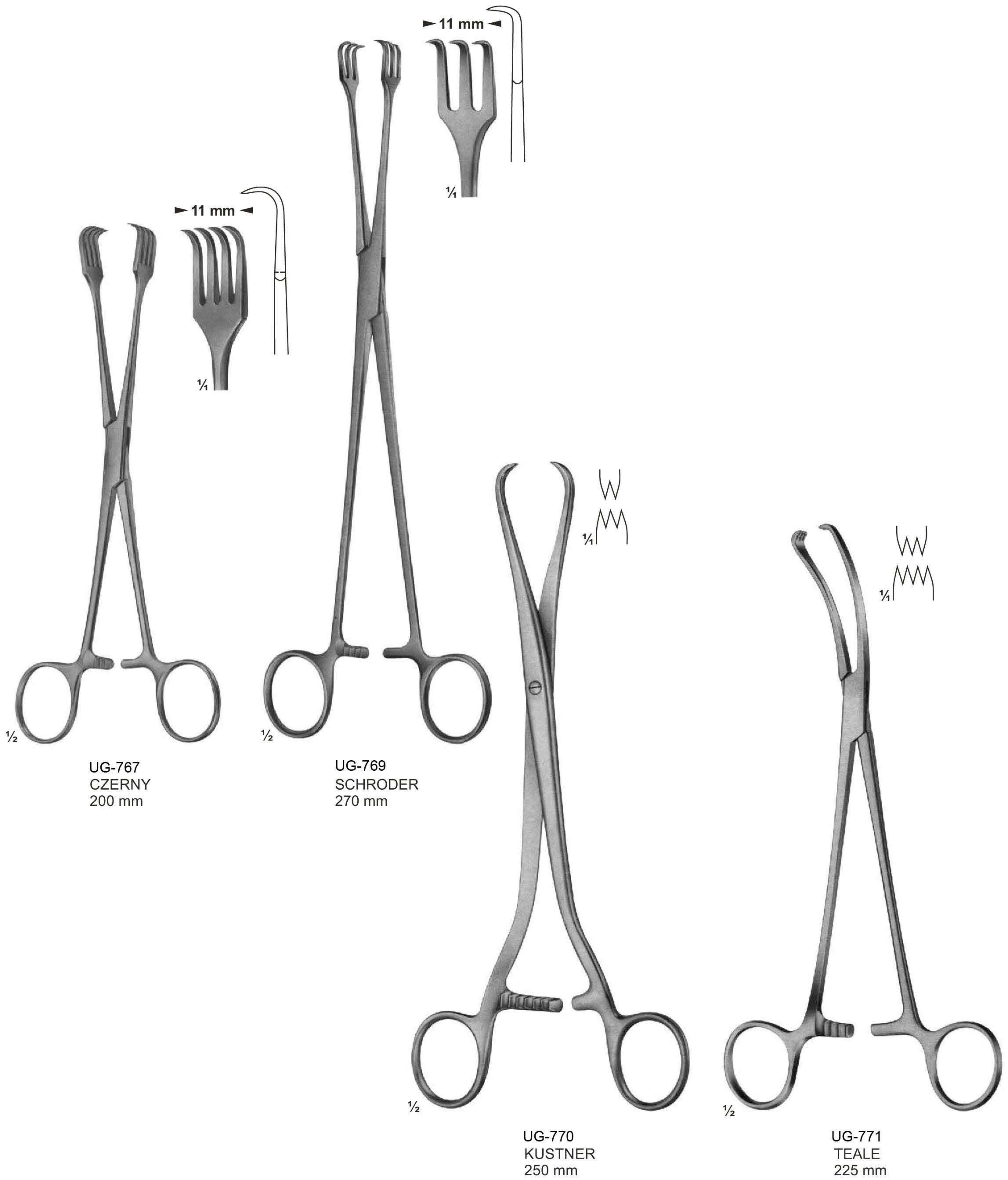

# Uterine Tenaculum Forceps

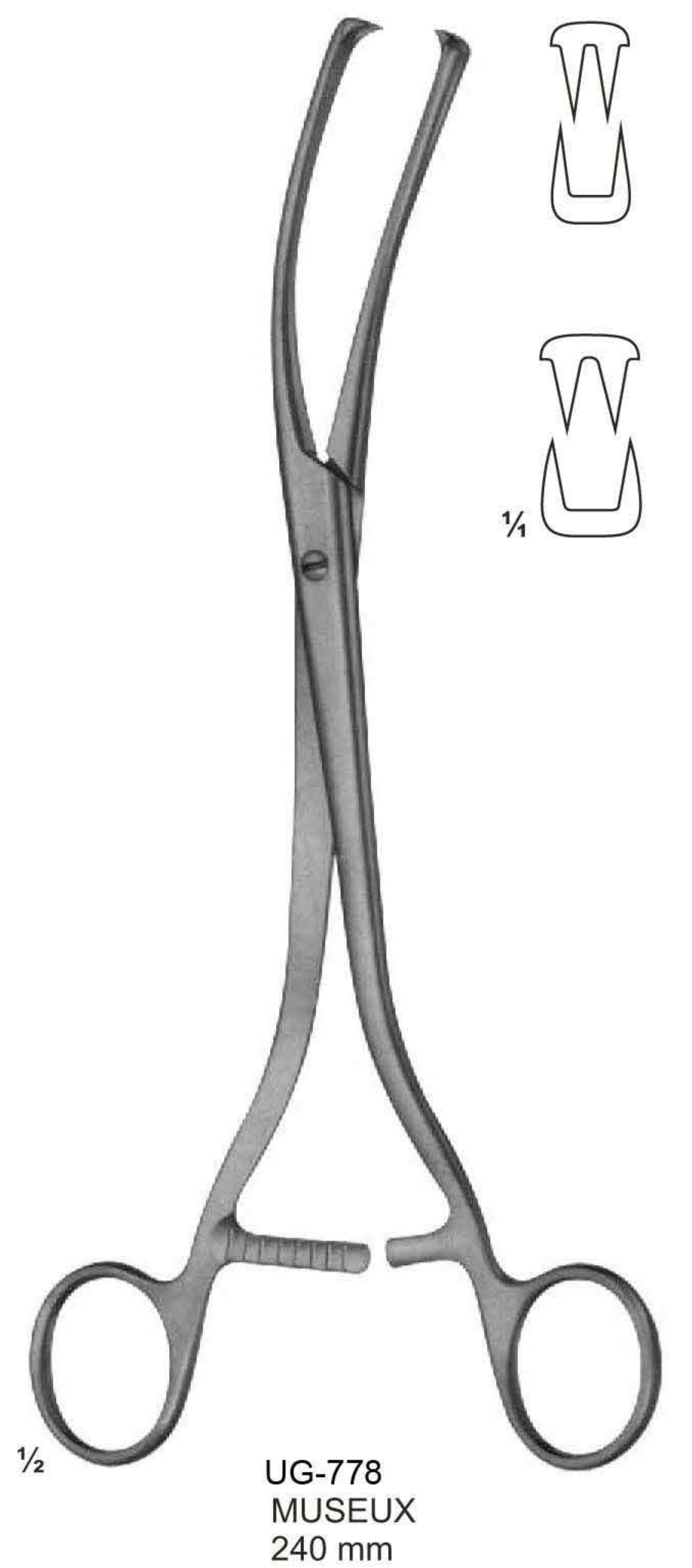
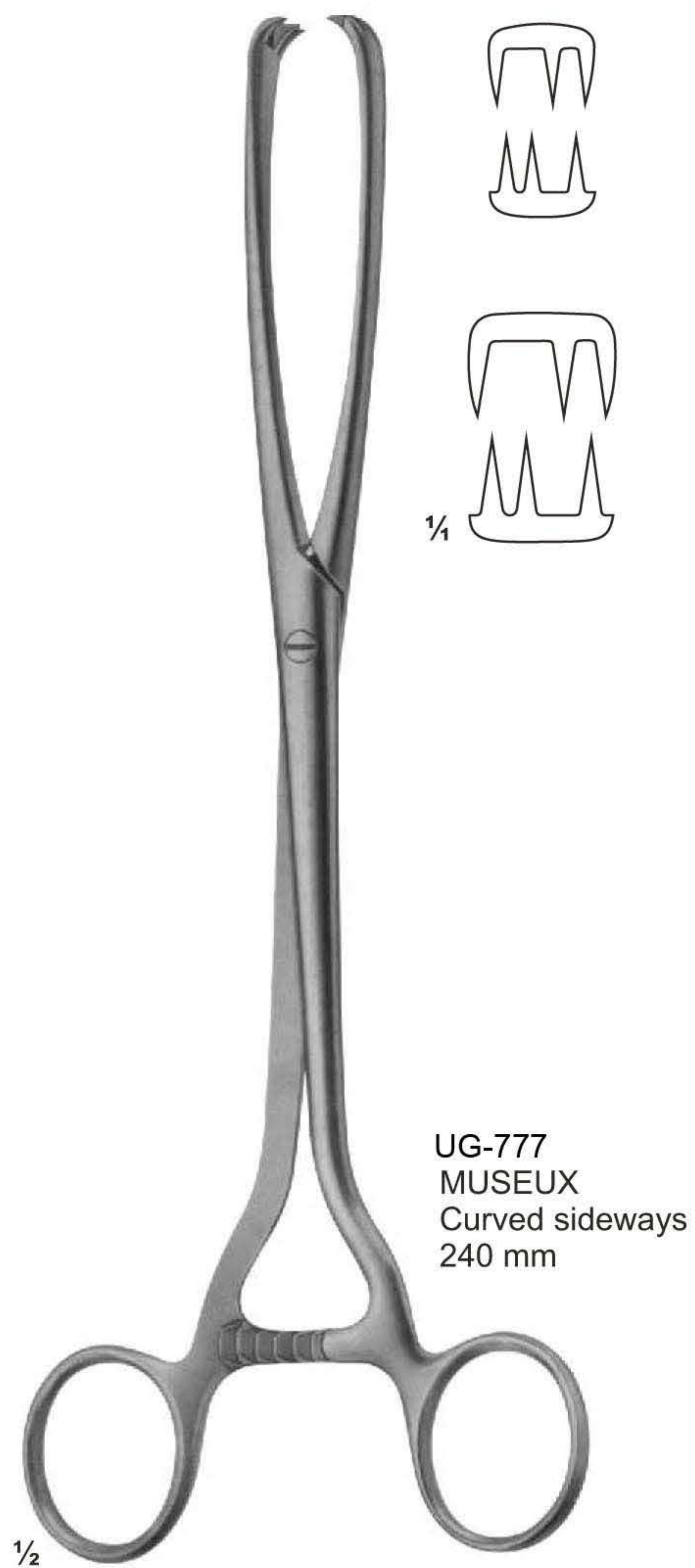
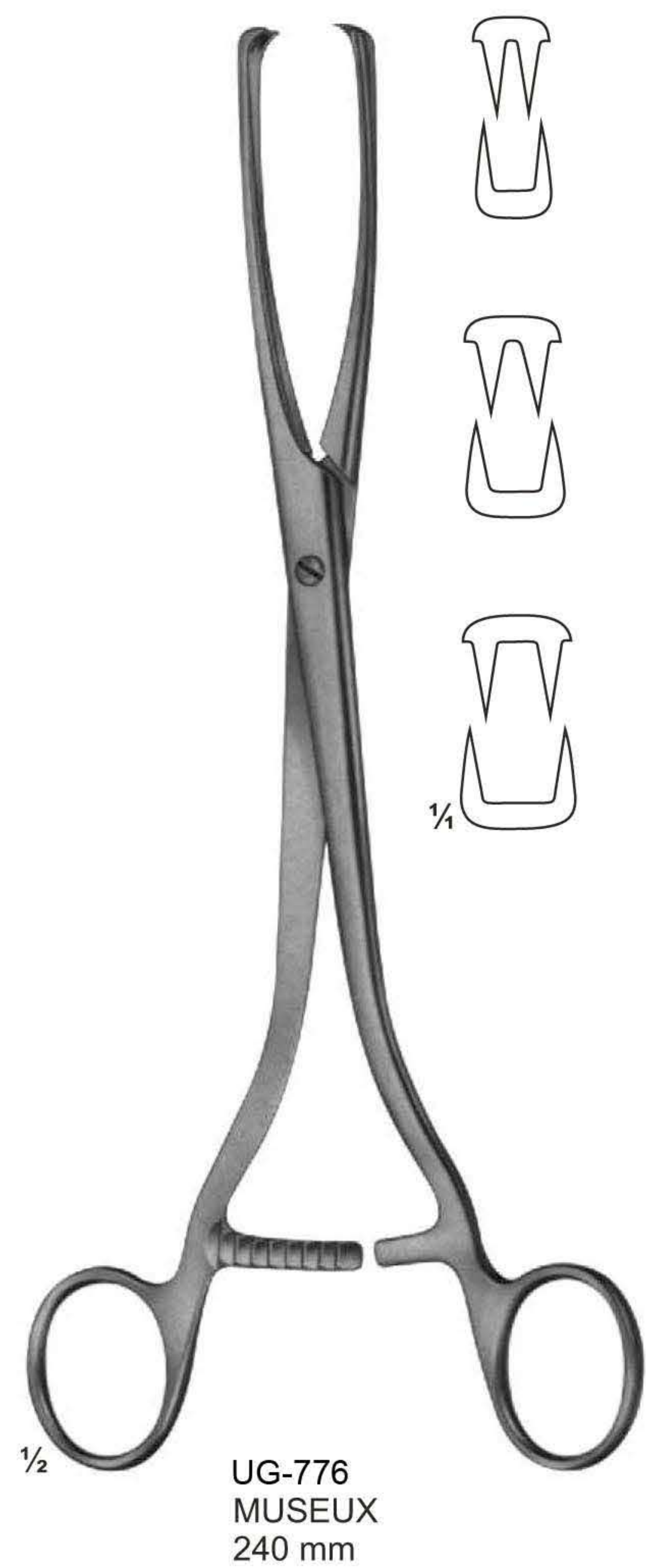

# Polypus-and Ovum Forceps

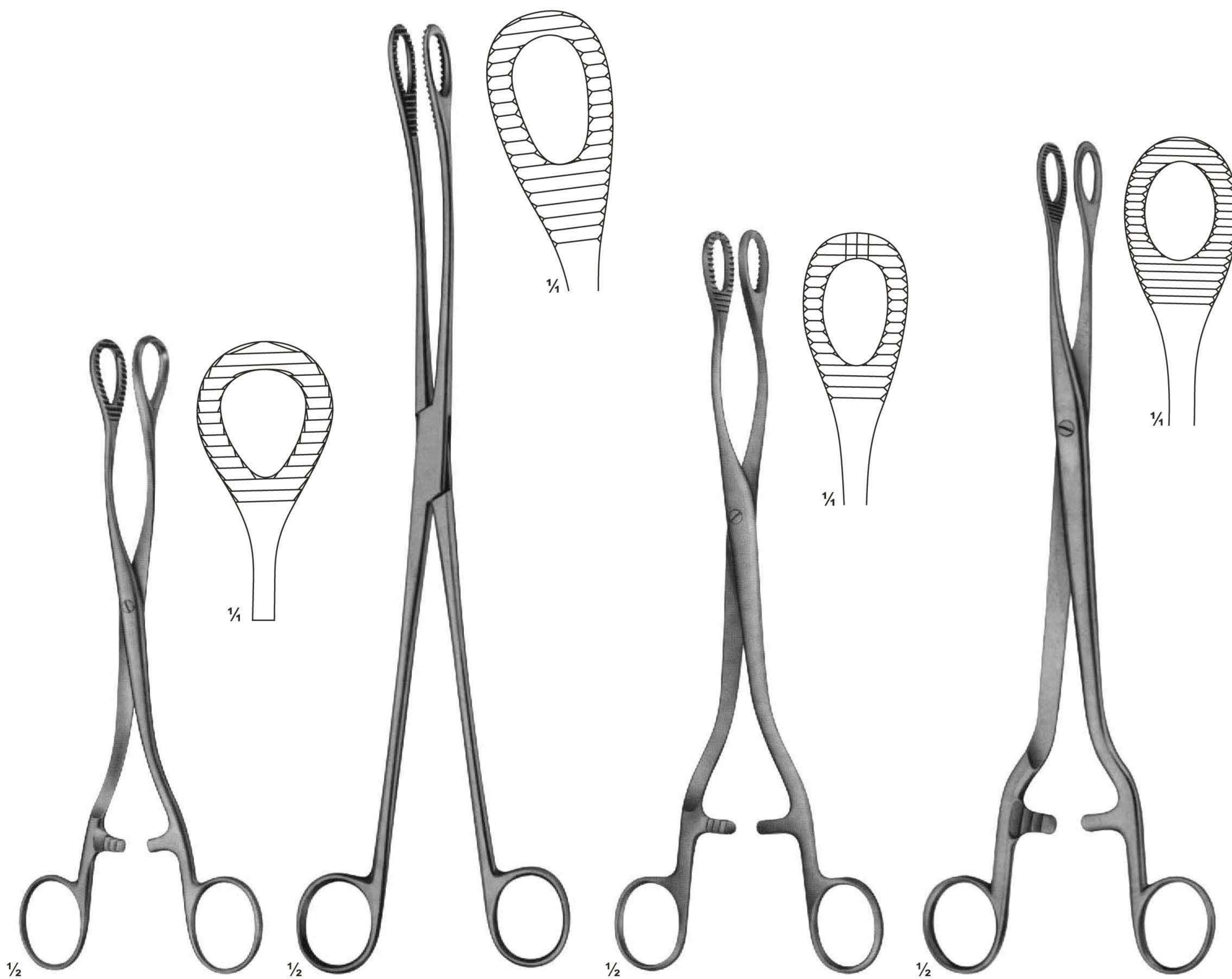

UG-779  
HEYWOOD-SMITH  
200 mm

UG-780  
KELLY  
320 mm

UG-781  
HEYWOOD-SMITH  
250 mm

UG-782  
NOTO  
280 mm

# Polypus and Ovum Forceps



UG-786  
DOYEN  
185 mm



UG-788  
250 mm 270 mm



UG-790  
BUMM  
280 mm



# Uterine Elevating Forceps

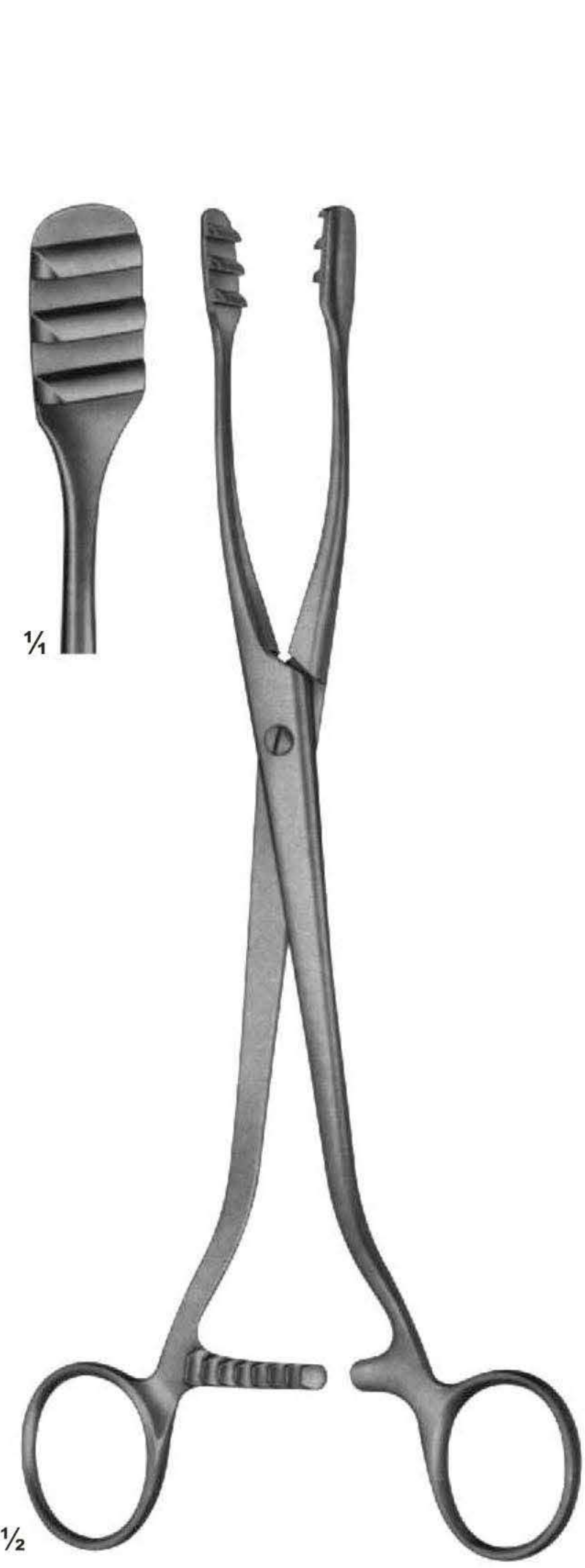

UG-791  
COLLIN  
250 mm



UG-792  
COLLIN  
285 mm



UG-793  
DARTIGUES  
255 mm

## Uterine Elevating Forceps



UG-795  
SOMER  
235 mm



UG-796  
STRASSMANN  
260 mm

# Uterine Elevating Forceps

With movable jaws

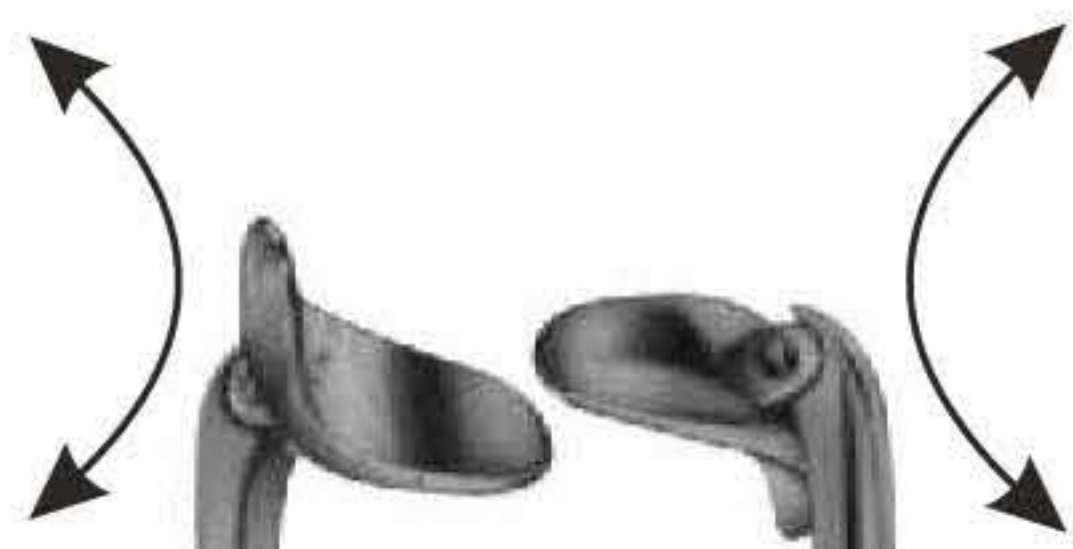

1/2

UG-797  
COLLIN  
265 mm

With movable jaws

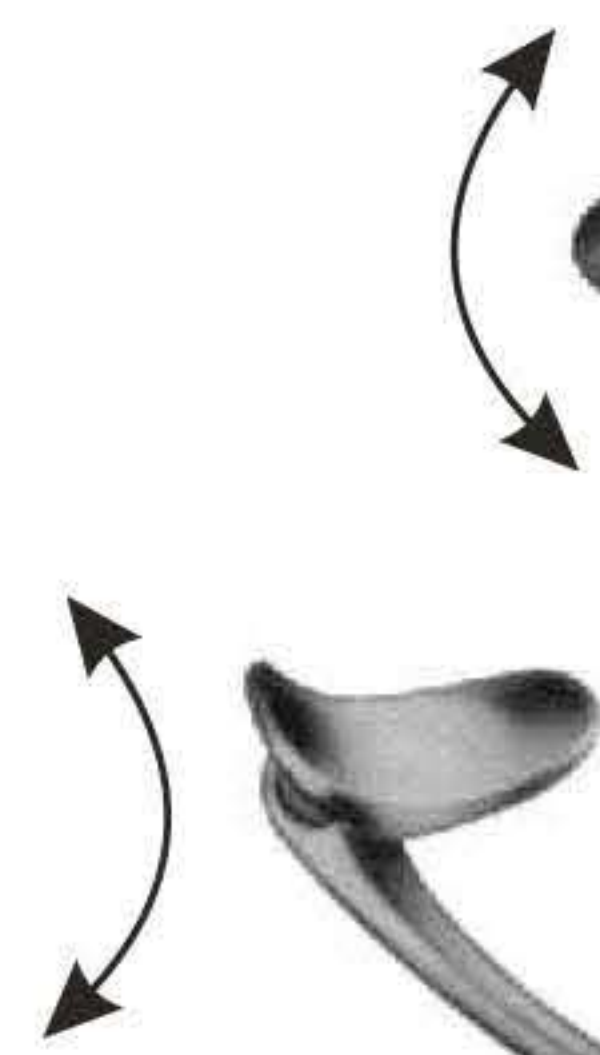

1/2

UG-799  
260 mm

# Myoma Instruments



UG-801  
SEGOND  
Myomatome  
270 mm



UG-802  
DOYEN  
Myoma screw  
150 mm



UG-804  
DOYEN  
Myoma screw  
190 mm



UG-806  
NEUBUSER  
Tubal seizing forceps  
200 mm

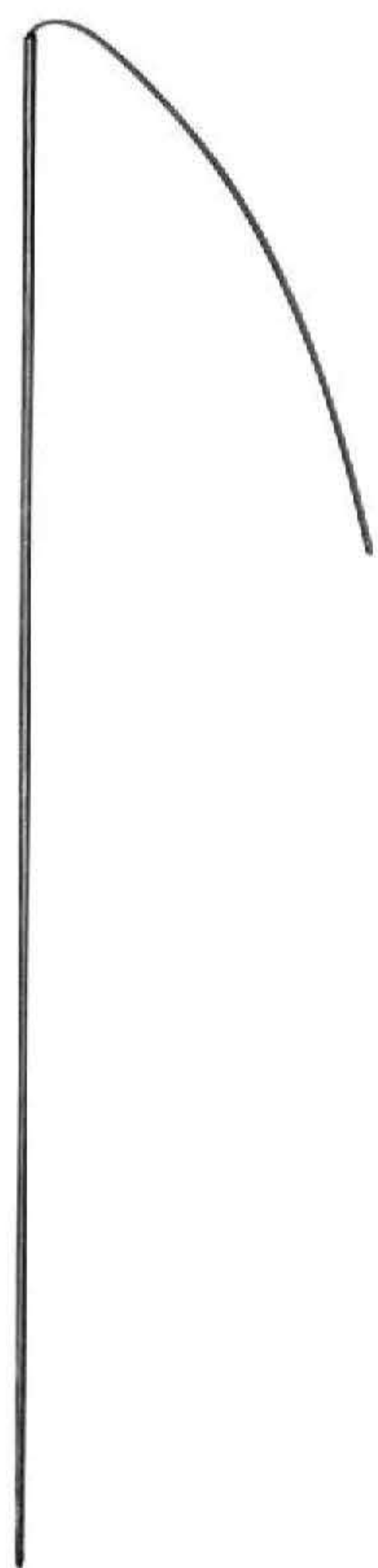

UG-808  
Splint guide  
with thread



UG-810  
Splint guide with  
round handle  
180 mm



UG-812  
Angled glass rods  
Set . 3 pieces

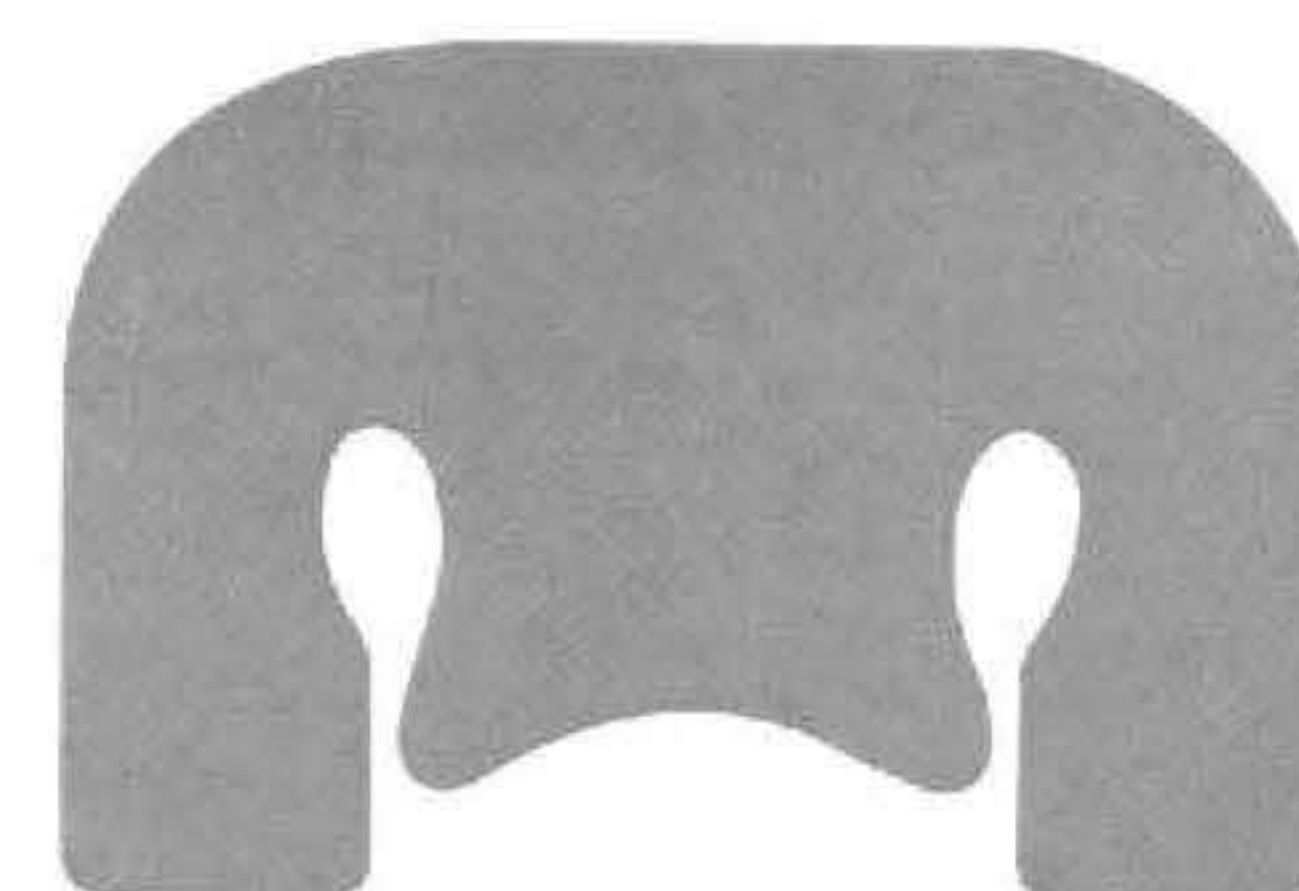

UG-813  
Silicon operating pad  
pre-cut



UG-814  
Polyethylene splint material  
soft-sterile  
0.45 mm

# Biopsy Currettes

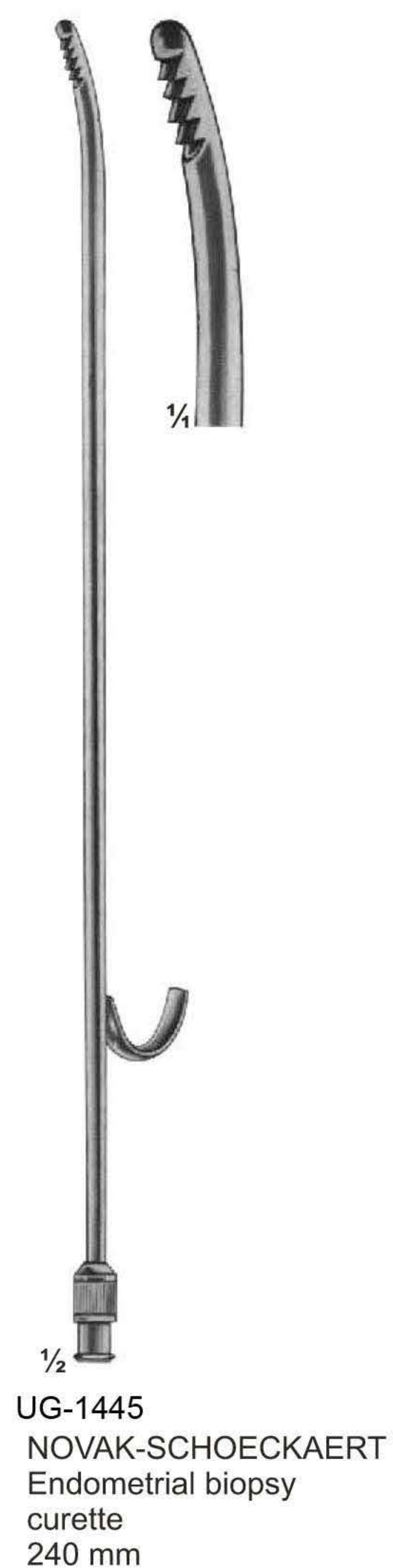
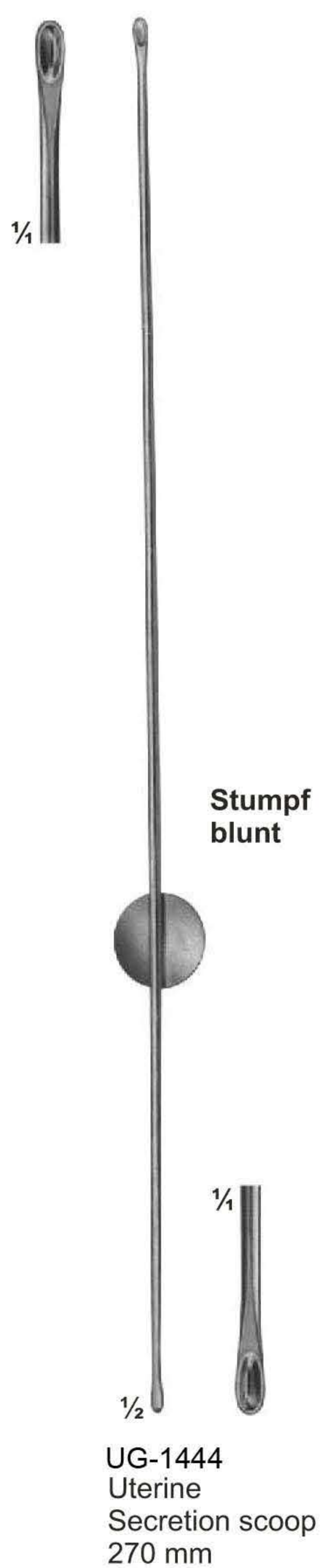

# Biopsy Forceps

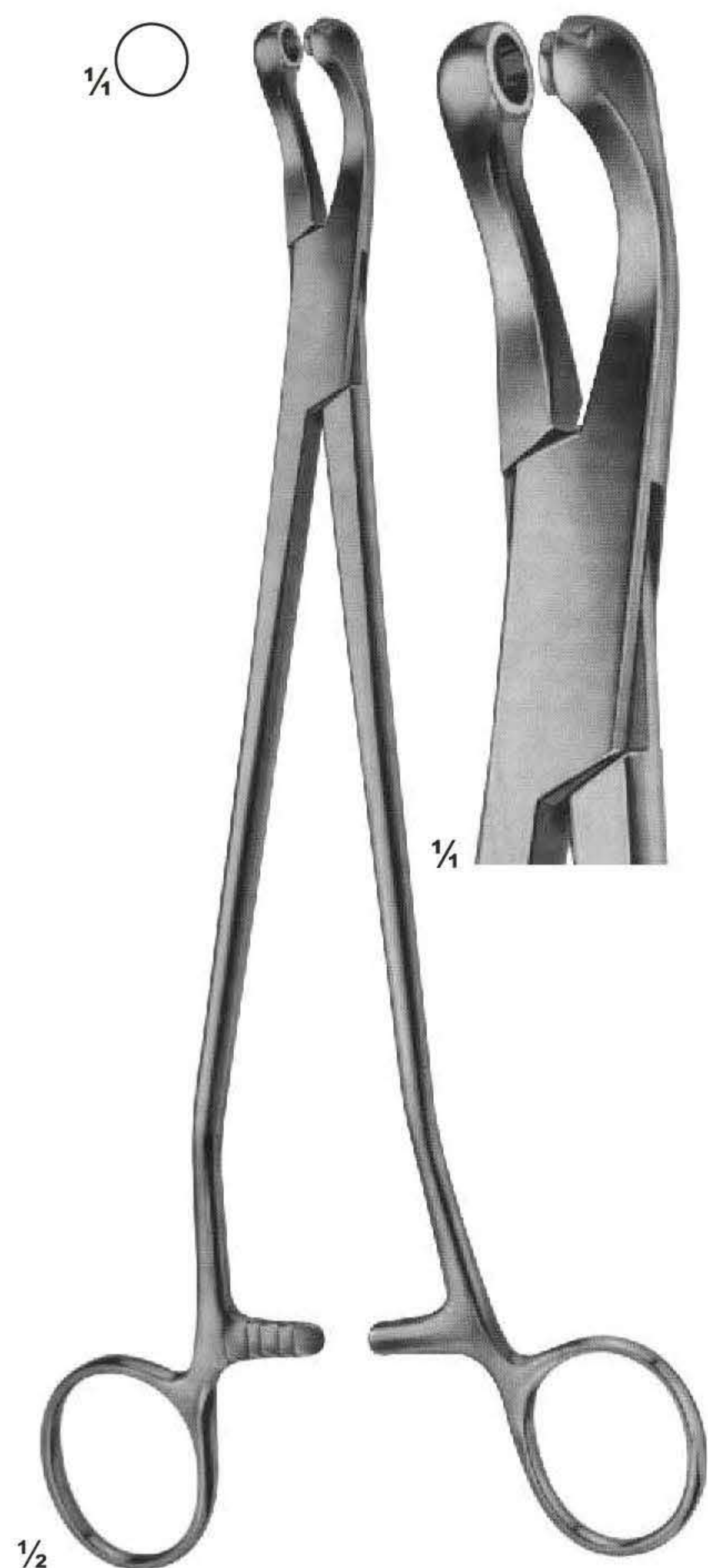

UG-1447  
THOMS-GAYLOR  
240 mm



UG-1448  
SCHUBERT  
260 mm

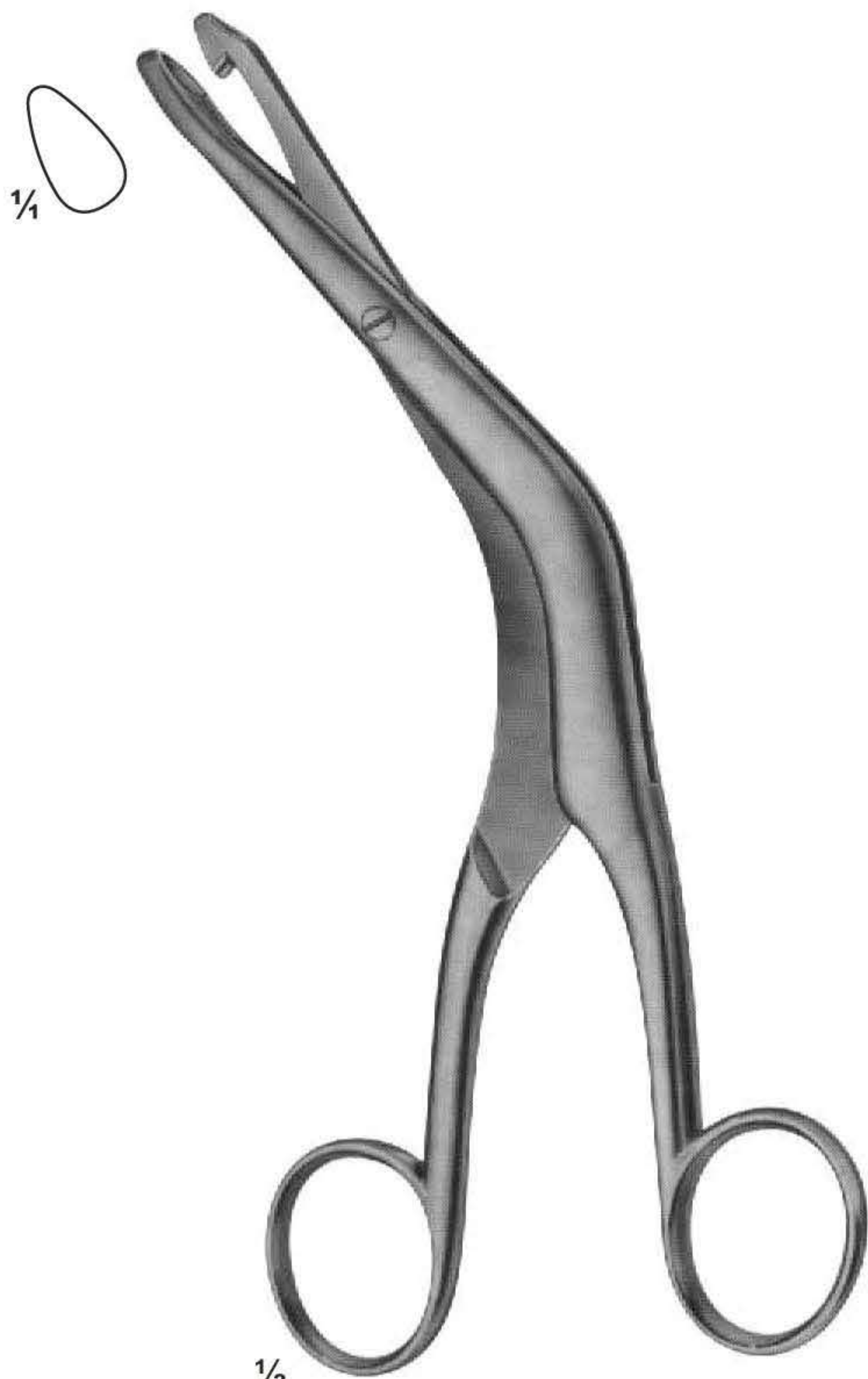

UG-1449  
FAURE  
210 mm

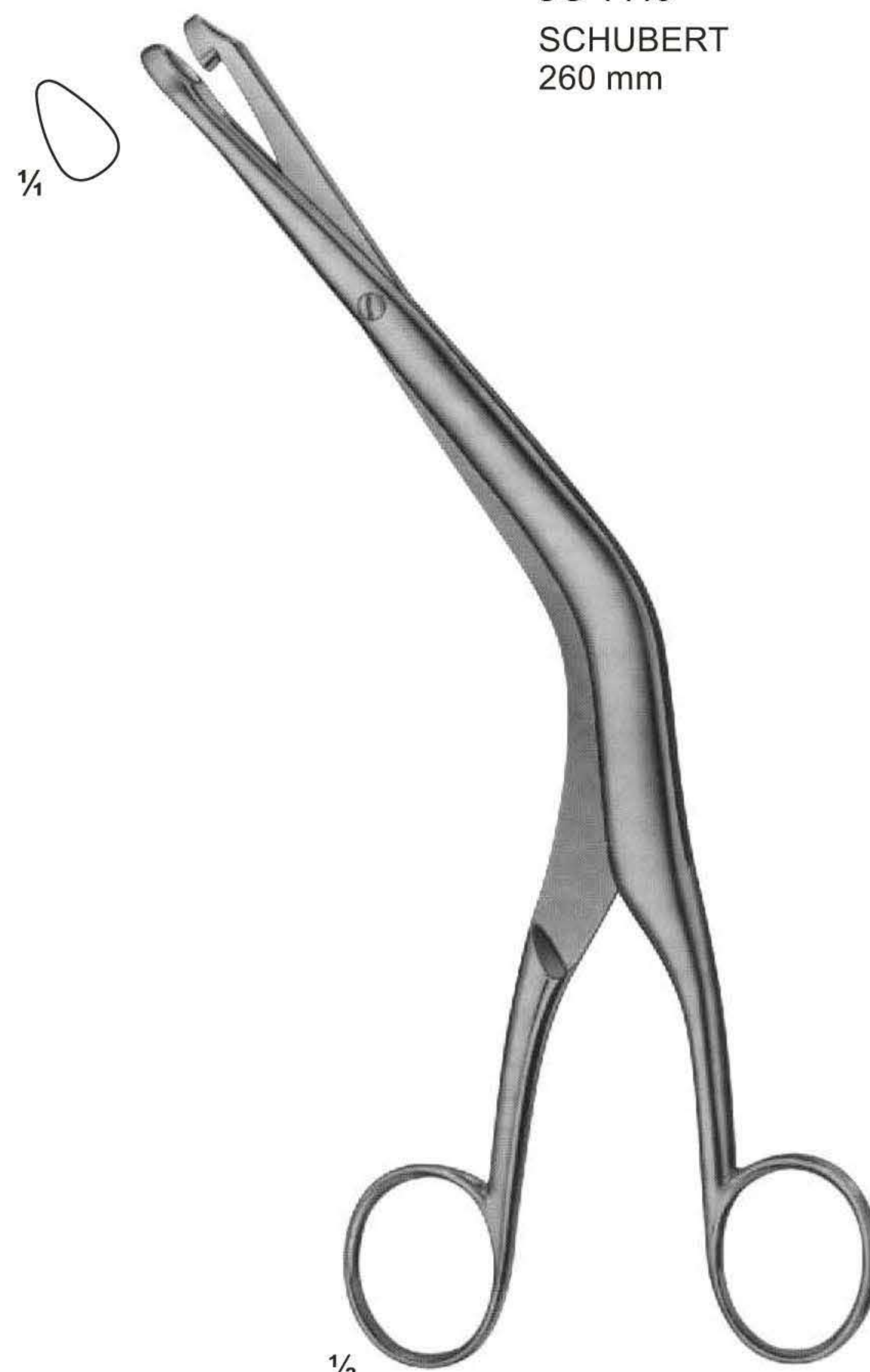

UG-1450  
FAURE  
240 mm

# Biopsy Forceps

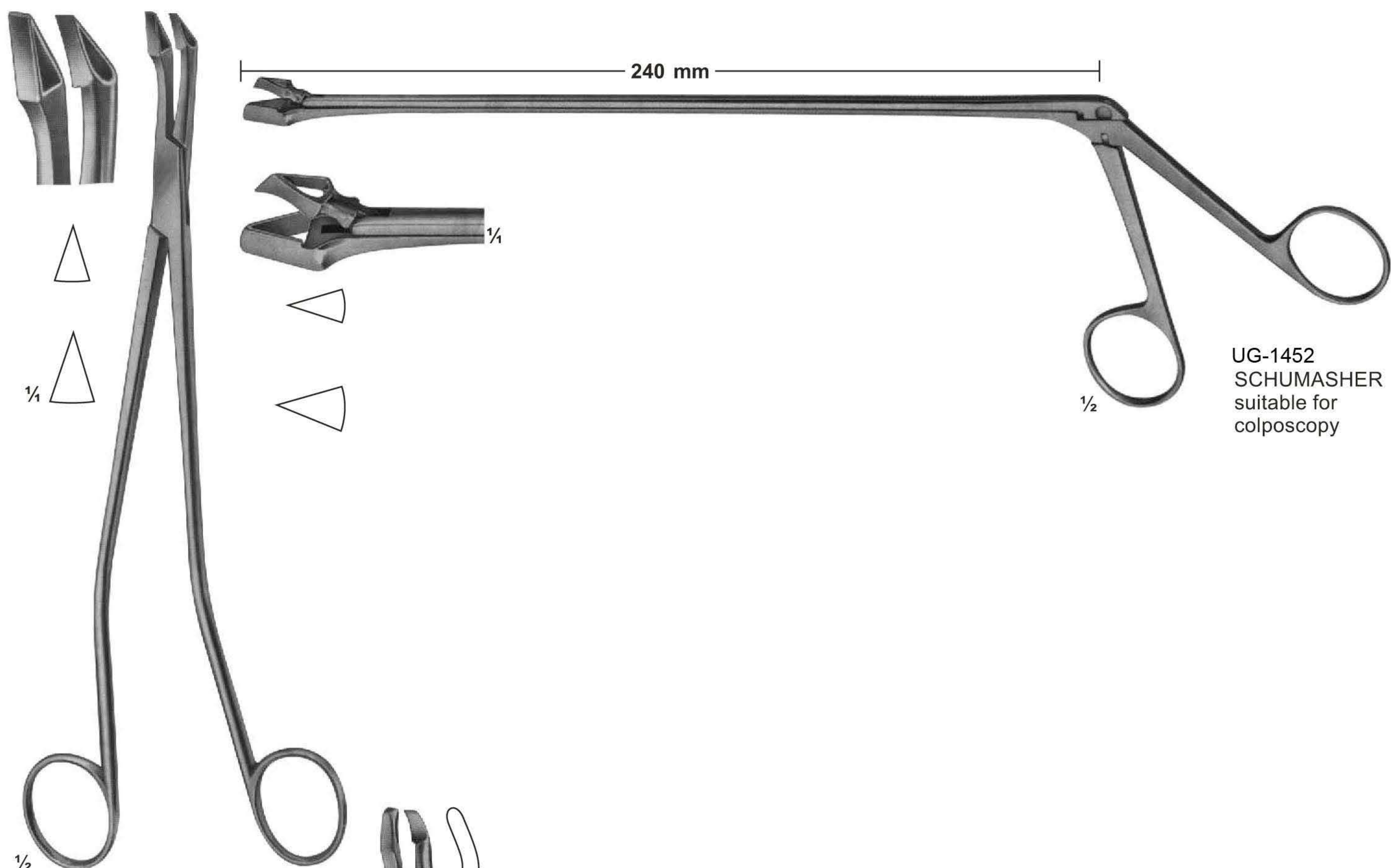

UG-1452  
SCHUMASHER  
suitable for  
colposcopy

UG-1451  
SCHUMASHER  
240mm

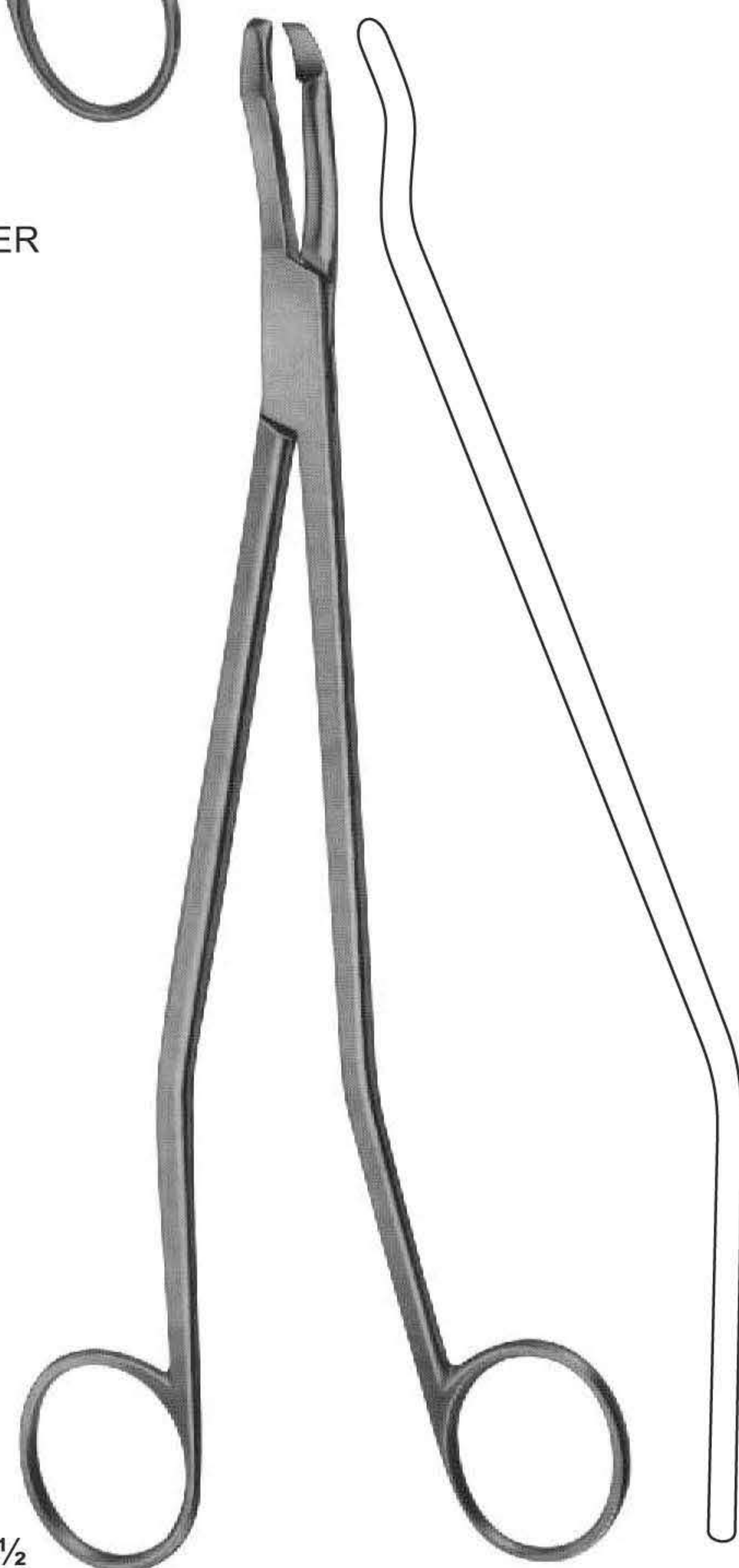

UG-1453  
SEIDL DBP  
Biopsy forceps, bayonet shaped  
for portio, vagina and vulva  
240mm

# Biopsy Forceps

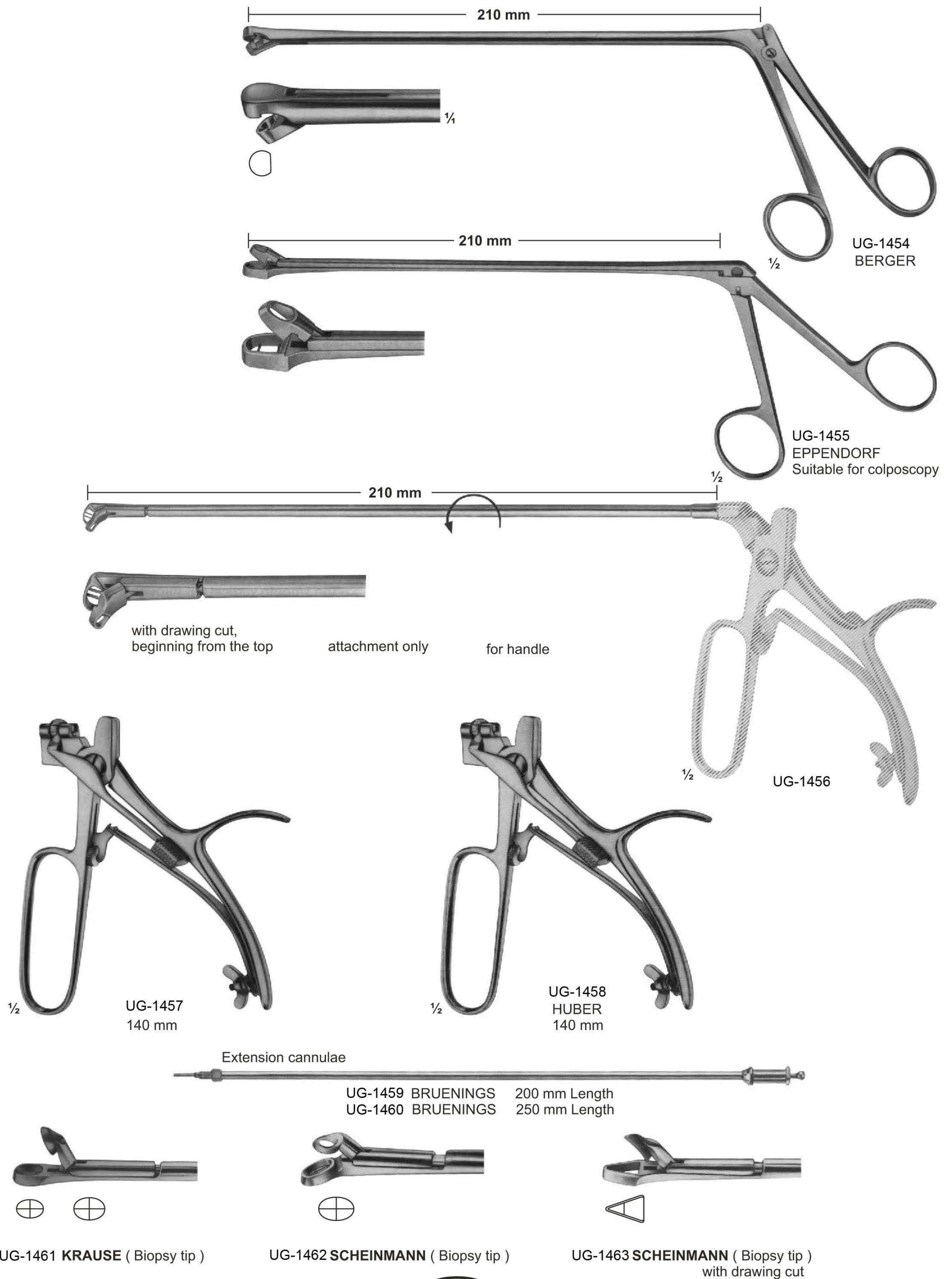



# Uterine Scoops

---



$\frac{1}{2}$   
UG-1464  
SIMON  
240 mm



$\frac{1}{2}$   
UG-1465  
SCHRODER  
310 mm



$\frac{1}{2}$   
UG-1466  
RECAMIER  
300 mm

# Uterine Curettes



UG-1467  
SIMS  
255 mm



UG-1468  
BUMM  
blunt-malleable  
290 mm



UG-1469  
BLAKE  
275 mm

# Placenta-and Ovum Curettes



1/2  
UG-1470  
COLLIN  
300 mm



1/2  
UG-1471  
RECAMIER  
blunt-rigid  
360 mm

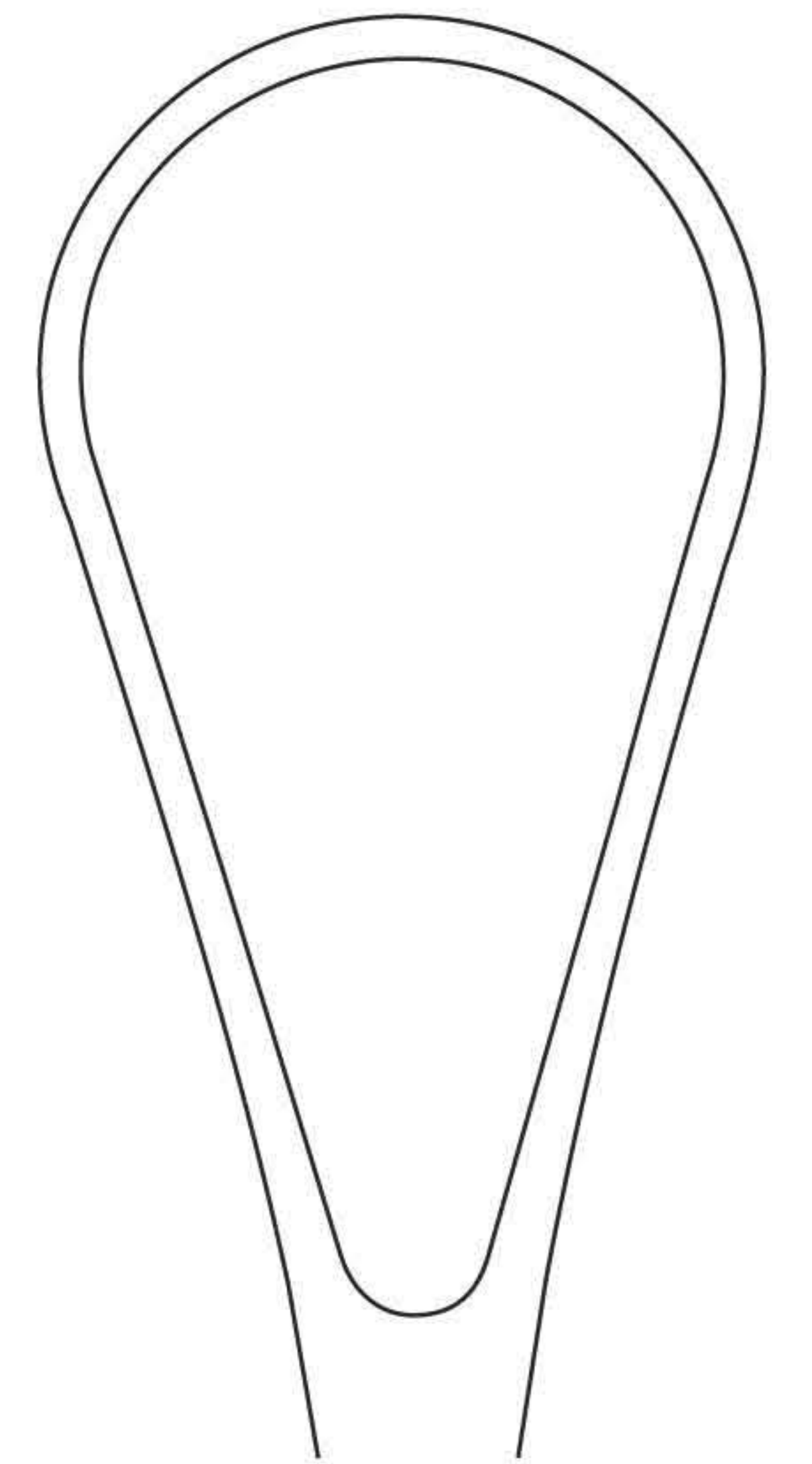
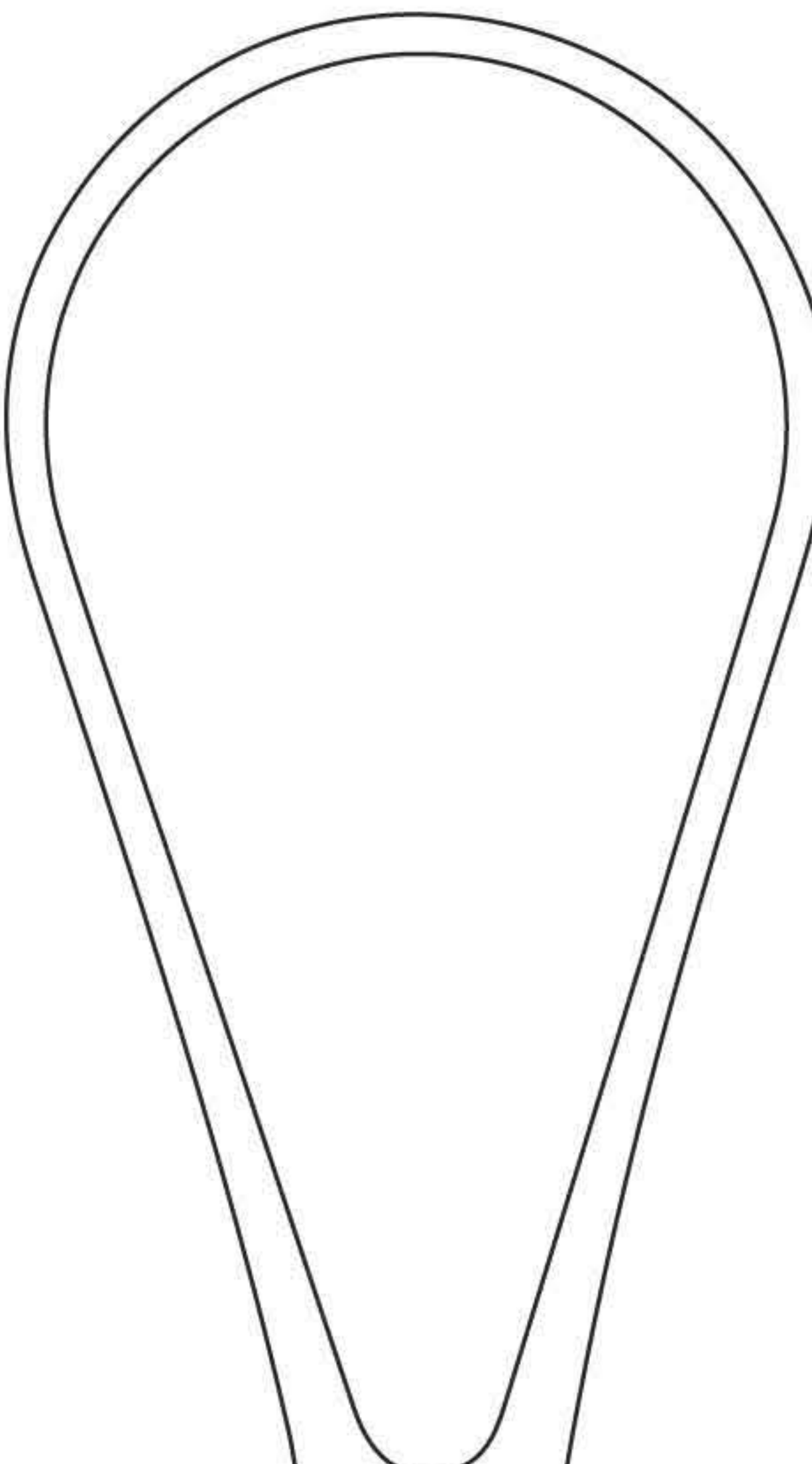

Fig:1



1/4

Fig:2



1/2  
UG-1472  
BUMM  
310 mm

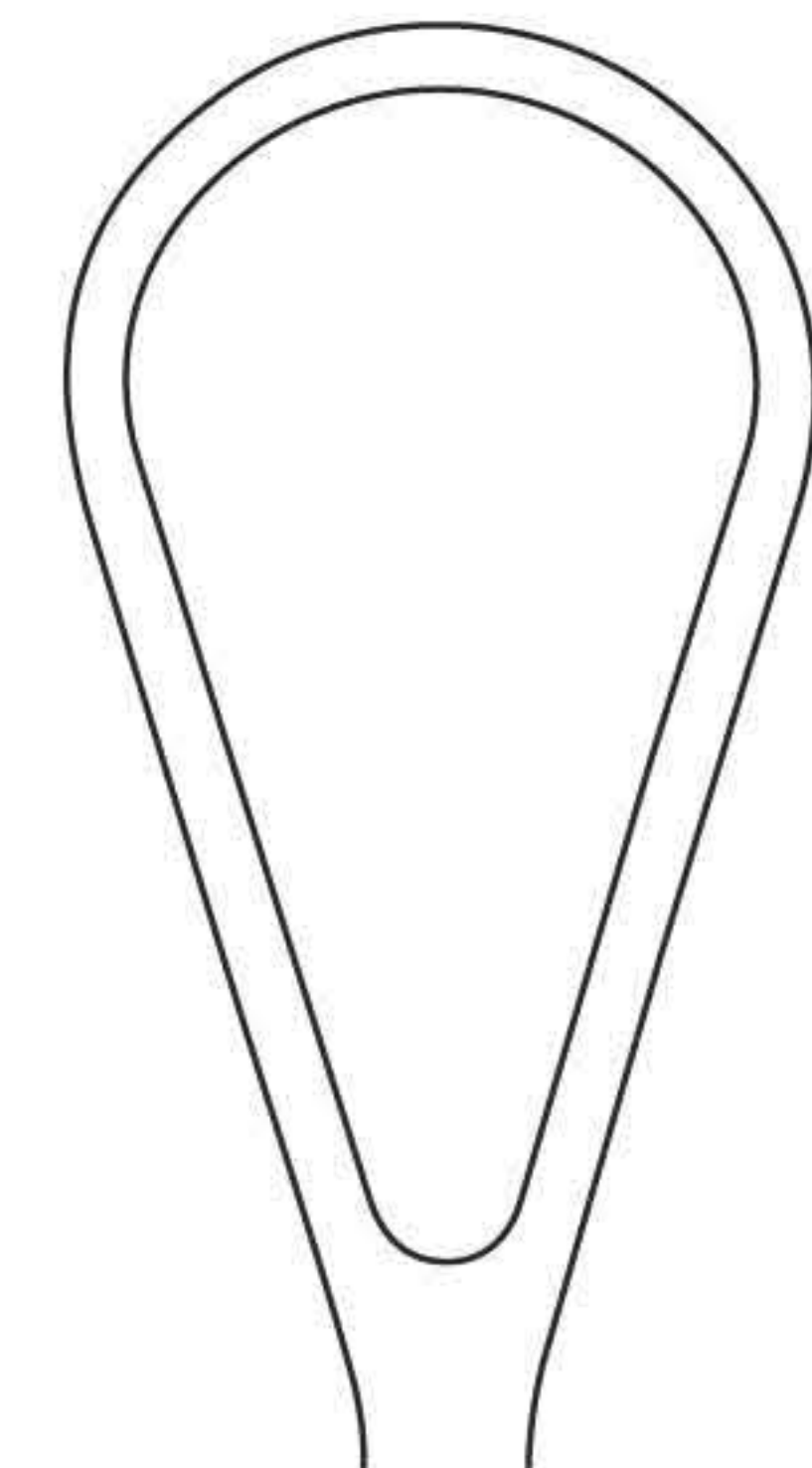

Fig:1

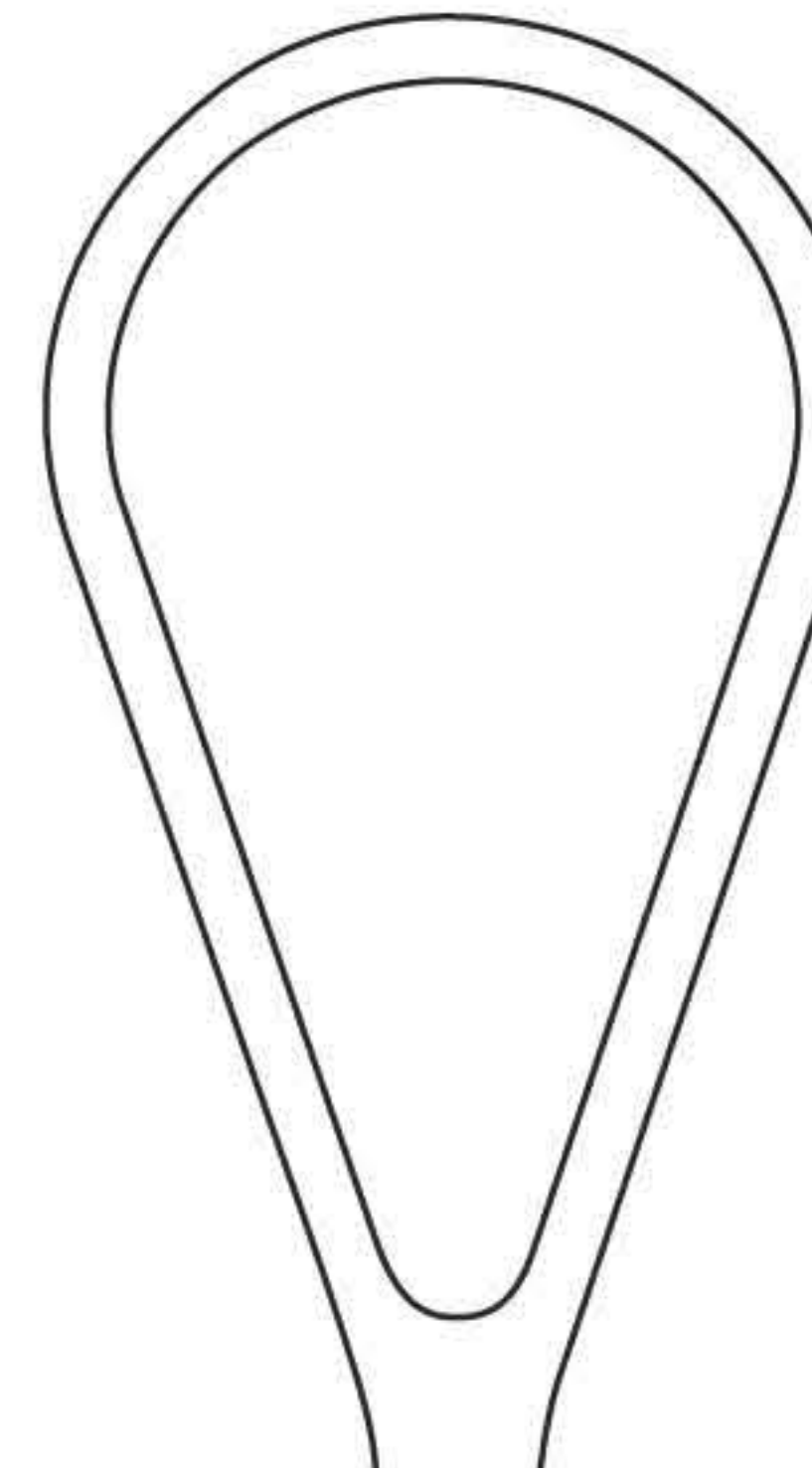
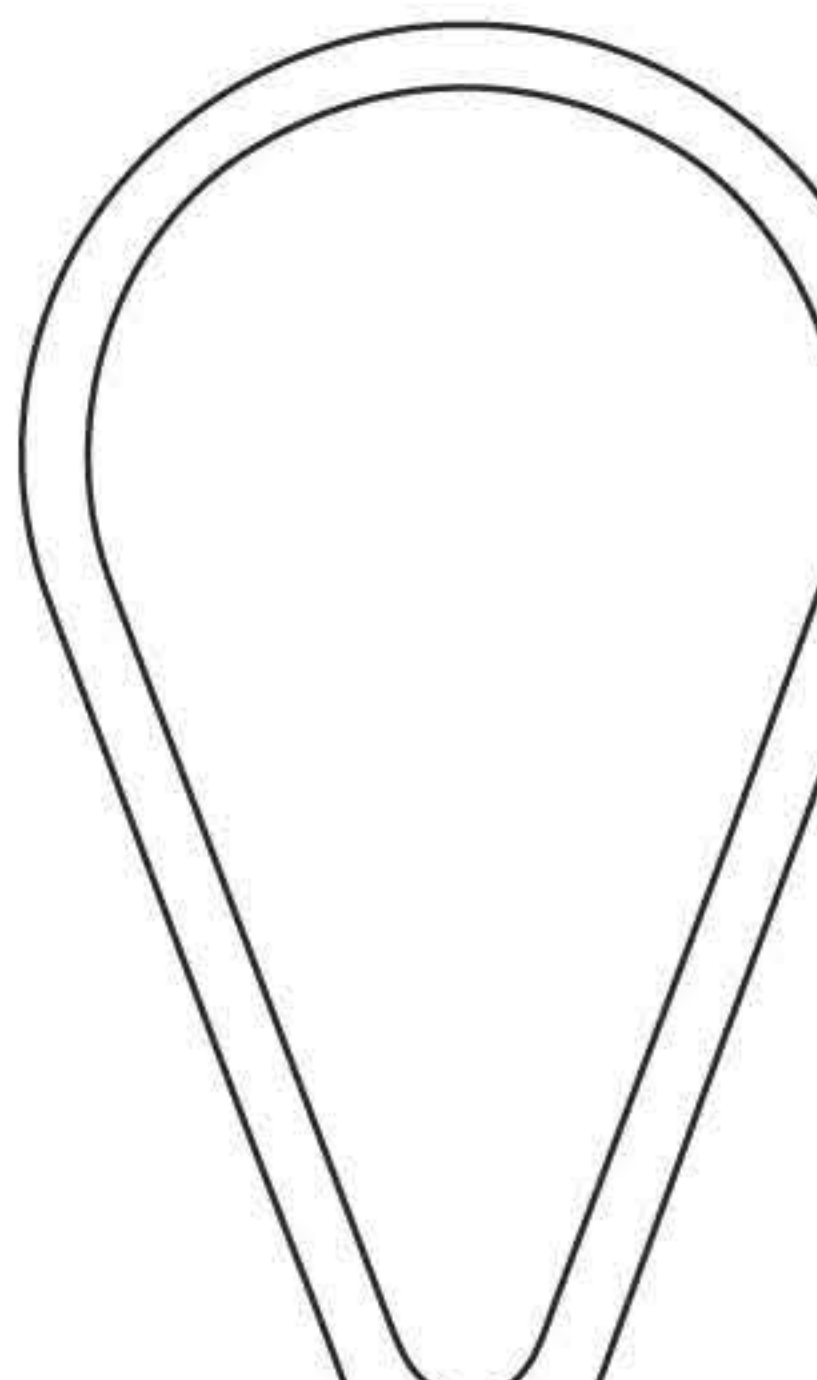

Fig:2



1/4

Fig:3

# Vacuum Currettes

UG-1473

Suction currettes, stainless steel, fitting hose connection.

Working tips are smoothly rounded of, therefore no danger of perforation.



UG-1474

Hose connection inside diam. 11 mm curved stainless steel.

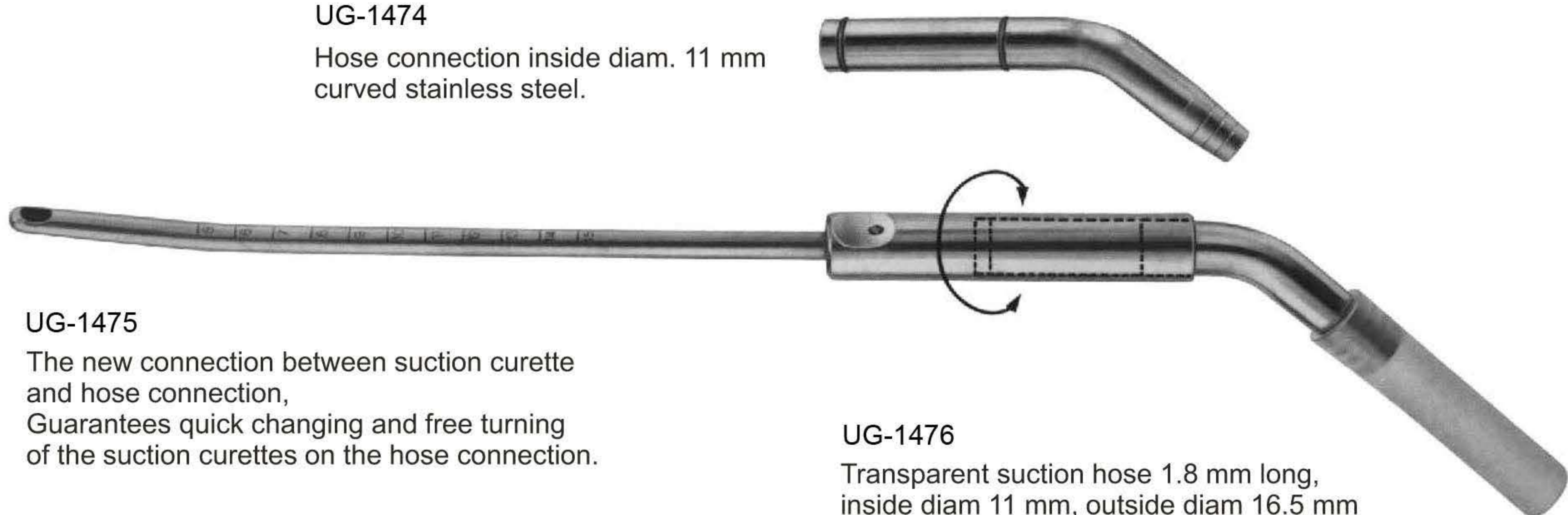

UG-1475

The new connection between suction curette and hose connection, Guarantees quick changing and free turning of the suction currettes on the hose connection.

UG-1476

Transparent suction hose 1.8 m long, inside diam 11 mm, outside diam 16.5 mm can be sterilized in an autoclave at 1 bar overpressure ( 120 C )

UG-1477

Strainer for tissues, plastic, for single use only, to be used for histopathological examination.



# Gynaecological Instruments

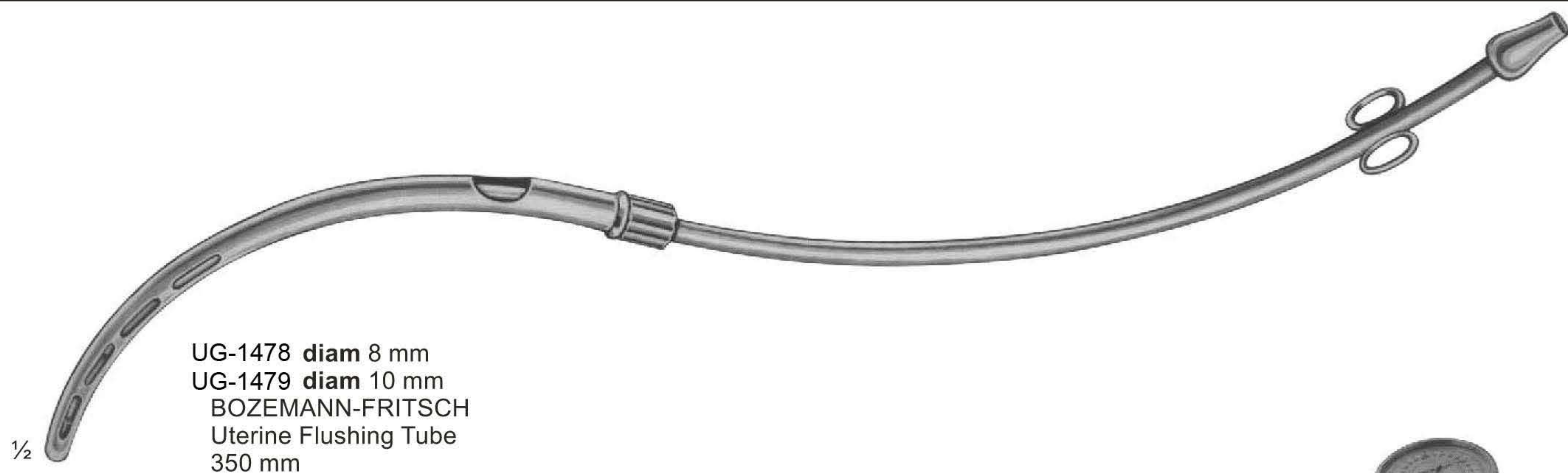

UG-1478 diam 8 mm  
 UG-1479 diam 10 mm  
 BOZEMANN-FRITSCH  
 Uterine Flushing Tube  
 350 mm

1/2



UG-1480  
 SCHULZE  
 Salpingograph, for utero-salpingography  
 in wooden case, consisting of:  
 Manometer, Connection, Uterine canulla  
 with tap, Cone S.M.L.,  
 Record Syringe 10 cc, Luer lock mount.

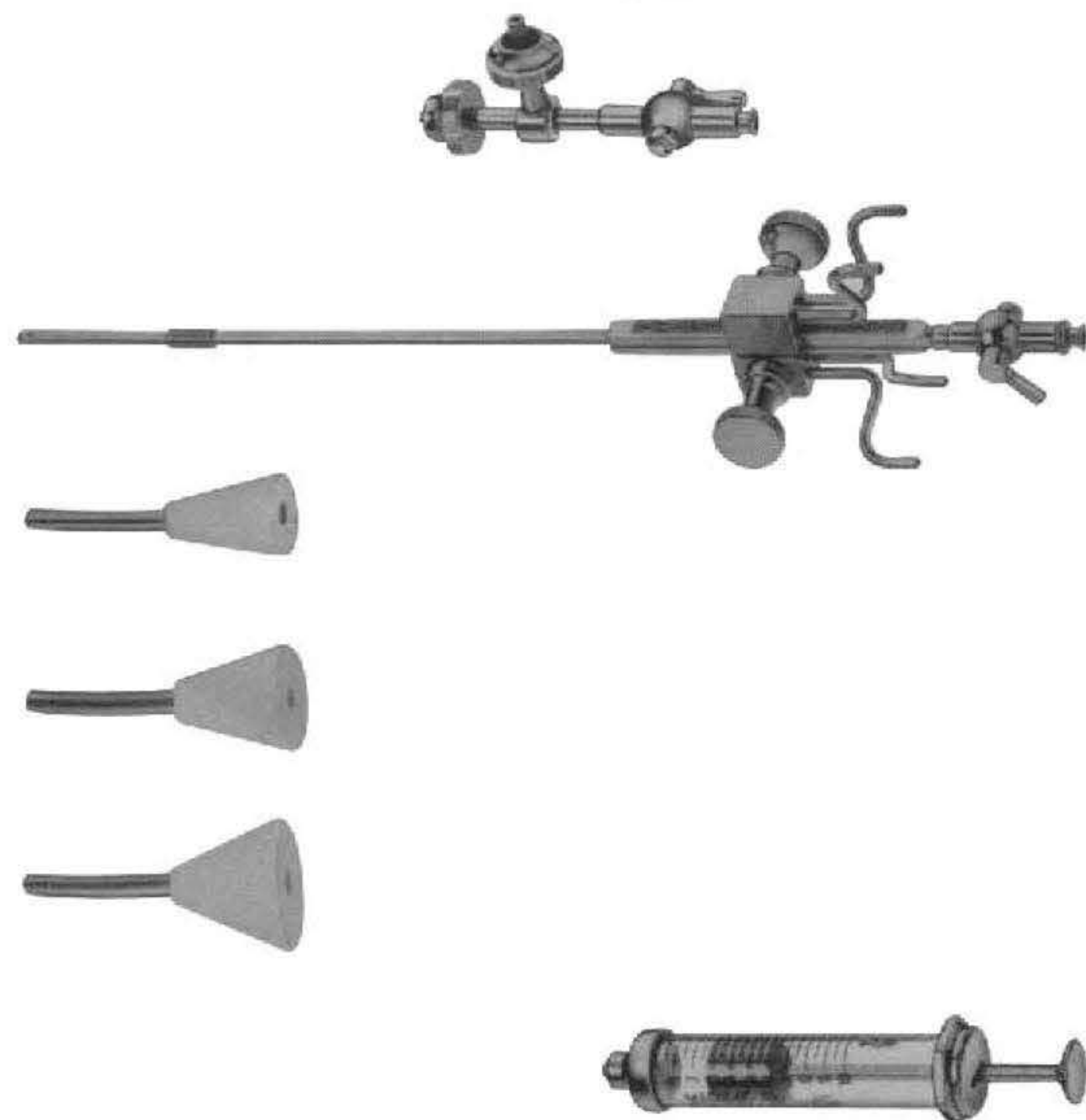

UG-1481  
 SCHULZE  
 Salpingograph, equipment  
 without manometer.

# Obstetrics-Pelvimeters

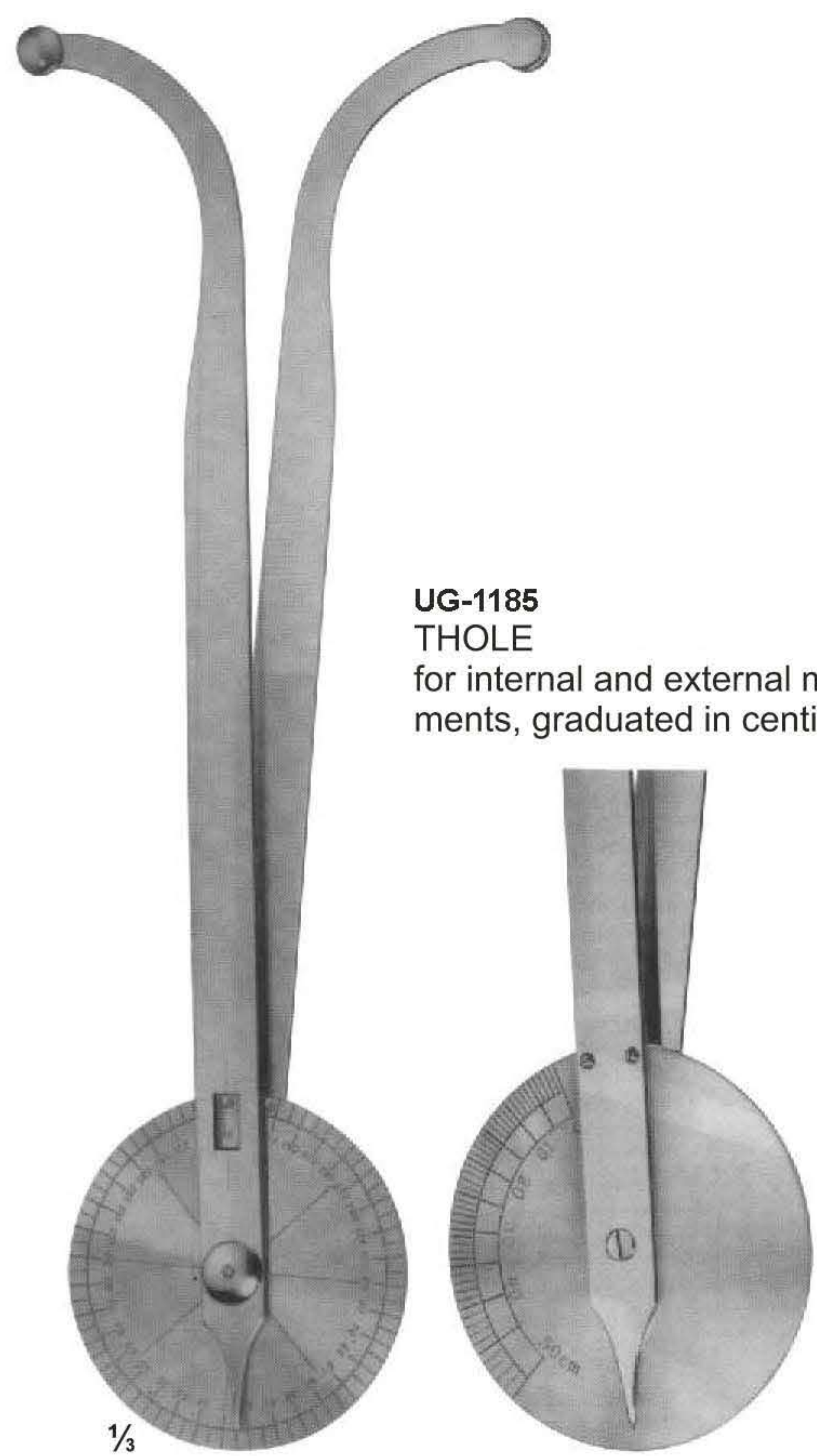

**UG-1185  
THOLE**  
for internal and external measurements, graduated in centimeters

1/3



**UG-1186  
DE LEE**  
graduated in centimeters and inches

1/2



**UG-1187  
COLLIN**  
graduated in centimeters

1/3



**UG-1188  
MARTIN**  
graduated in centimeters

1/3



for internal measurements between symphysis and promontory

1/3



**UG-1190  
COLLIN**  
graduated in centimeters

The additional straight arm can be replaced. The pelvimeter with straight arm is used for localisation of the portio vaginalis uteri and of vaginal metastasis.



**UG-1191  
BREISKY**  
graduated in centimeters

1/3

# Obstetrics-Pelvimeters

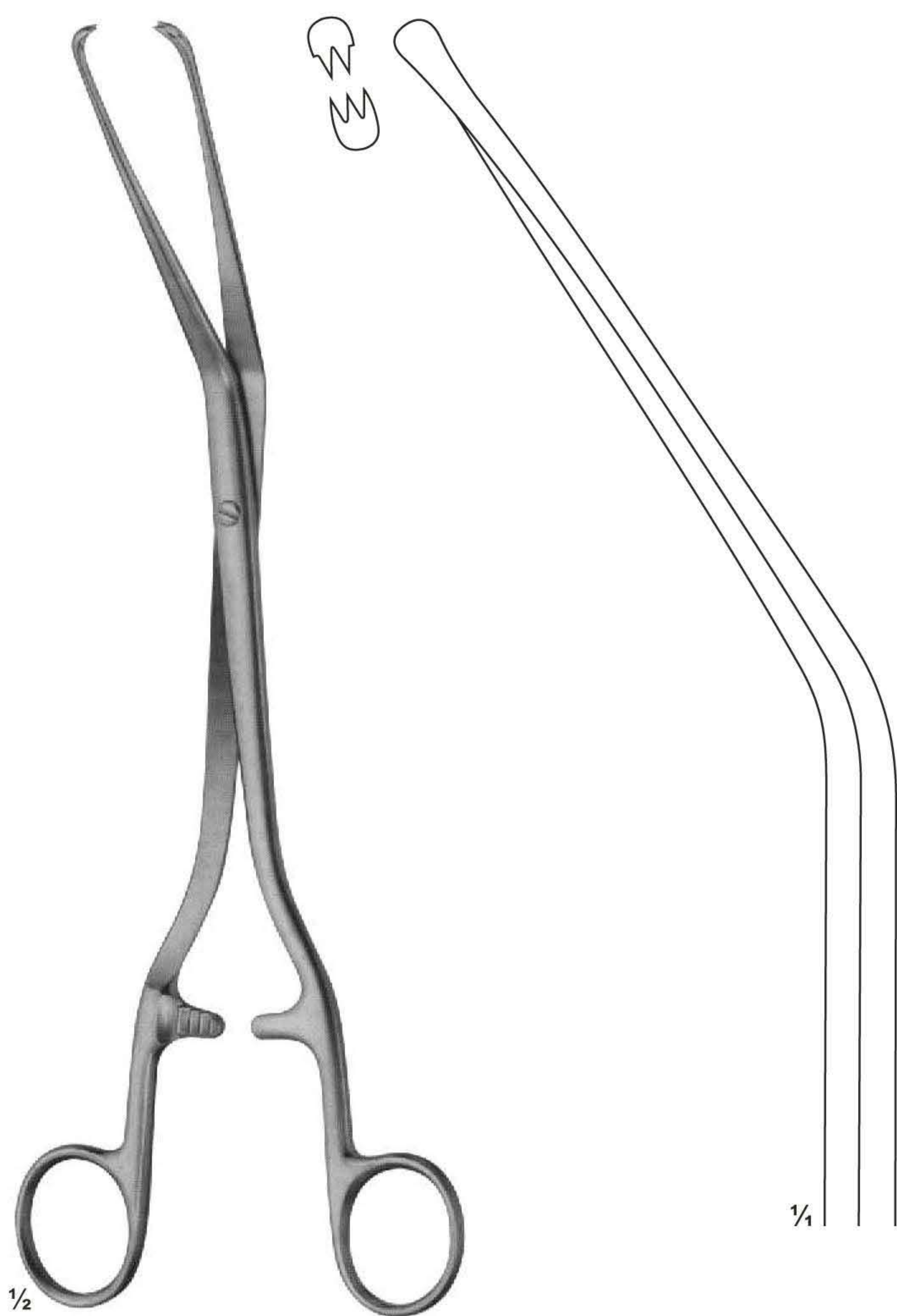

**UG-1193**  
HERFF  
puncturing forceps  
225 mm



**UG-1194**  
IOWA  
puncturing forceps  
260 mm

# Scissors of Obstetrics, Umbilical cord clamp



1/2  
**UG-1197**  
**SCHUMACHER**  
 Umbilical cord  
 scissors  
 155 mm



1/2  
**UG-1198**  
 Umbilical cord  
 scissors  
 105 mm



1/2  
**UG-1200**  
**BRAUN-STADLER**  
 Episiotomy Scissors

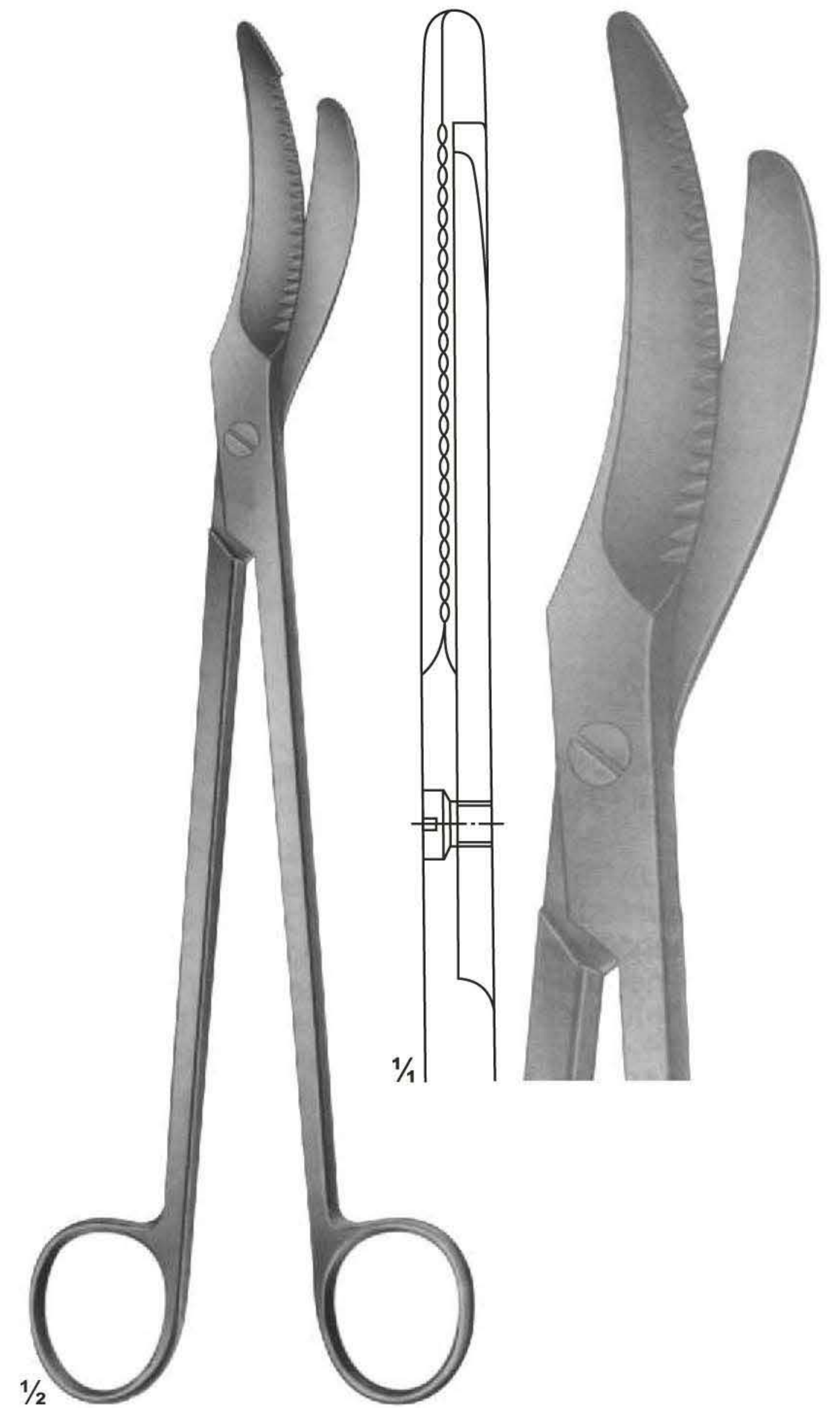

1/2  
**UG-1202**  
 Episiotomy Scissors  
 240 mm



# Obstetrics Forceps

---

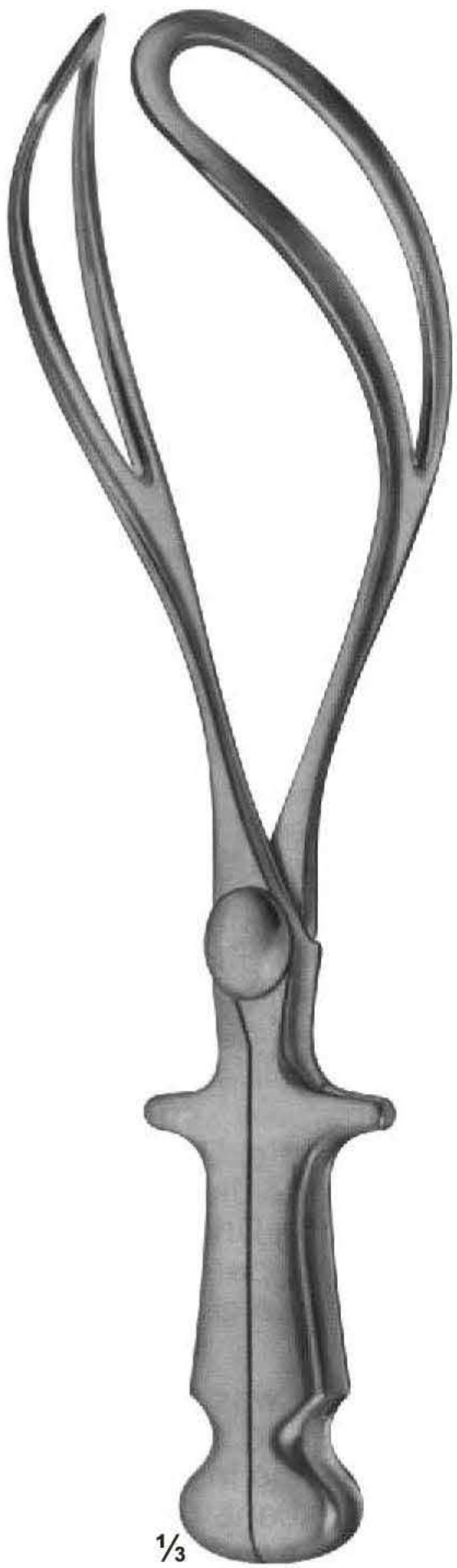

UG-1203  
Obstetrics Forceps

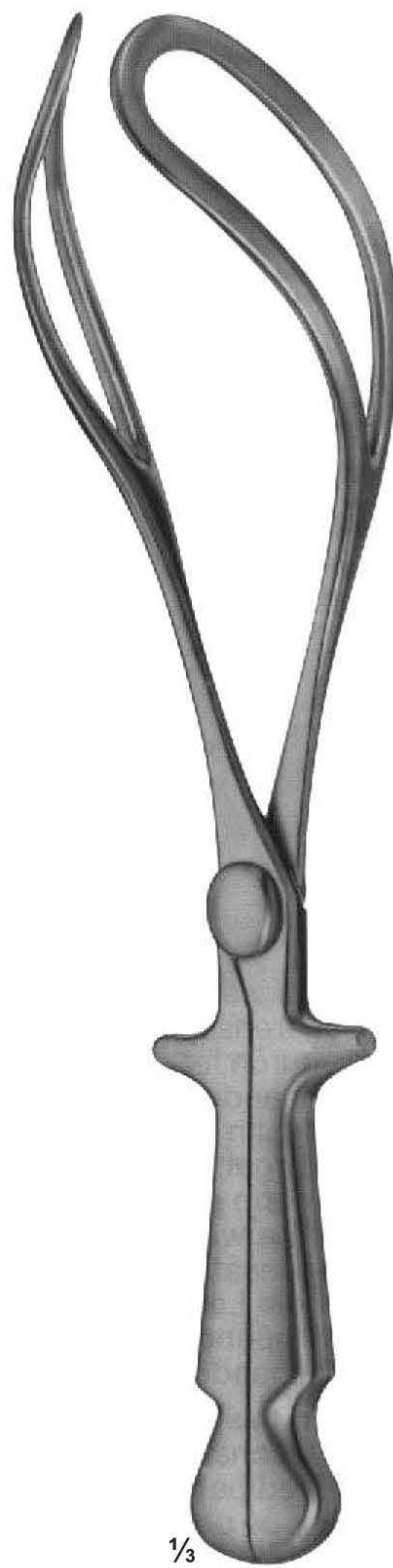

UG-1204  
Obstetrics Forceps



UG-1206  
SIMPSON-BRAUN

# Obstetrics Forceps

---



**UG-1208**  
SIMPSON-BRAUN

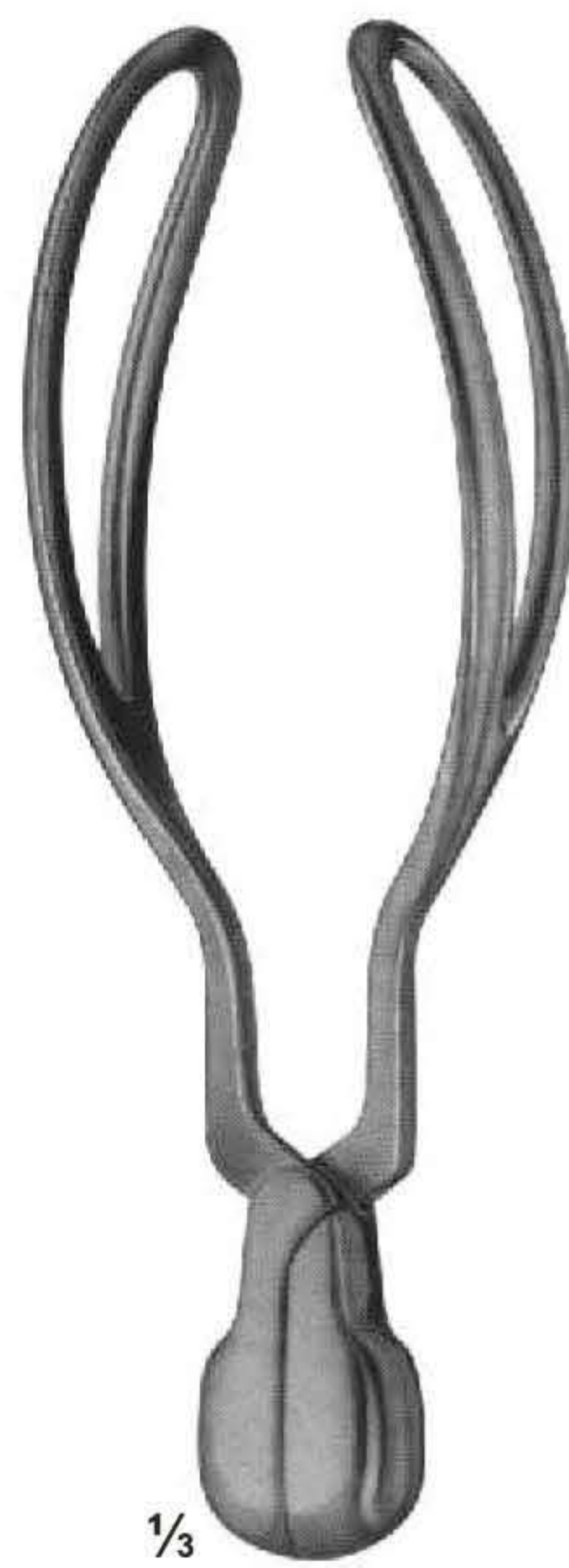

**UG-1210**  
SIMPSON

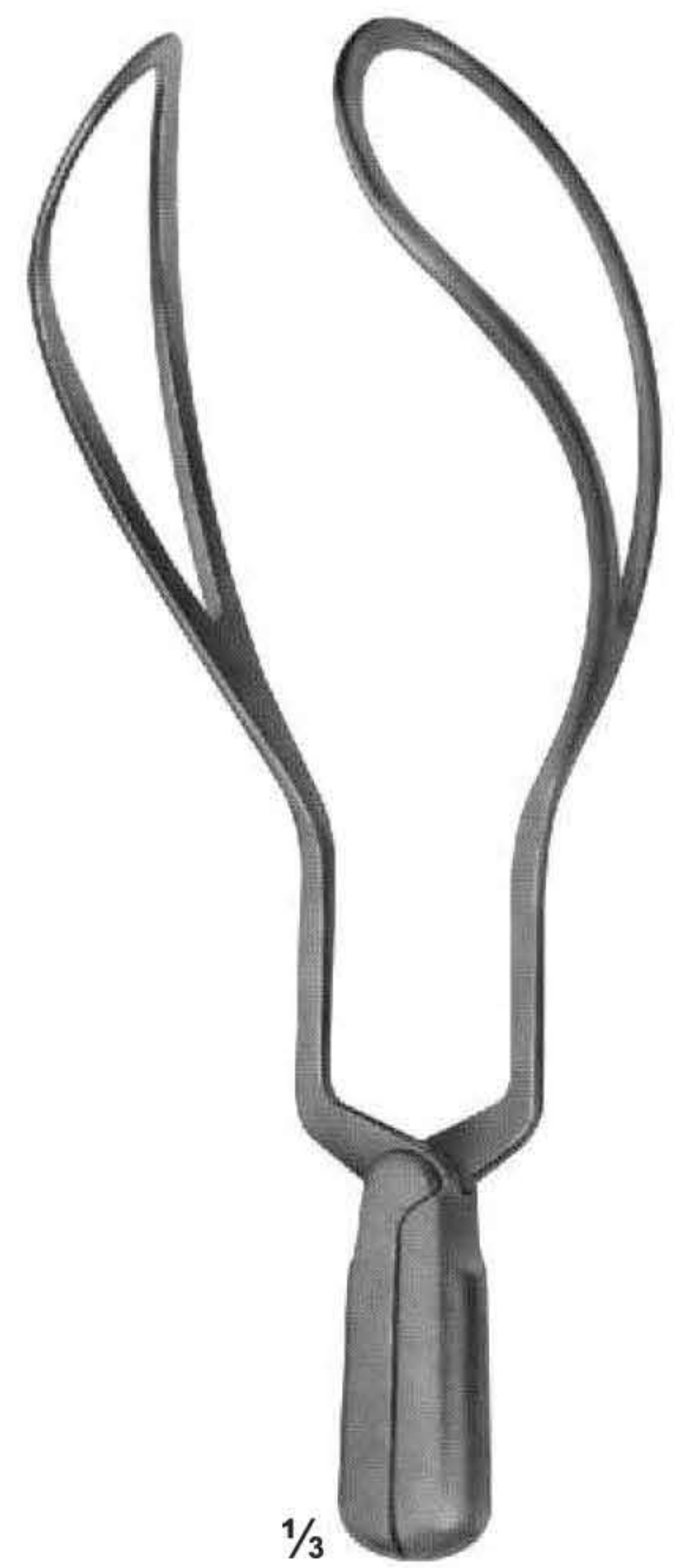

**UG-1211**  
WRIGLEY

# Obstetrics Forceps

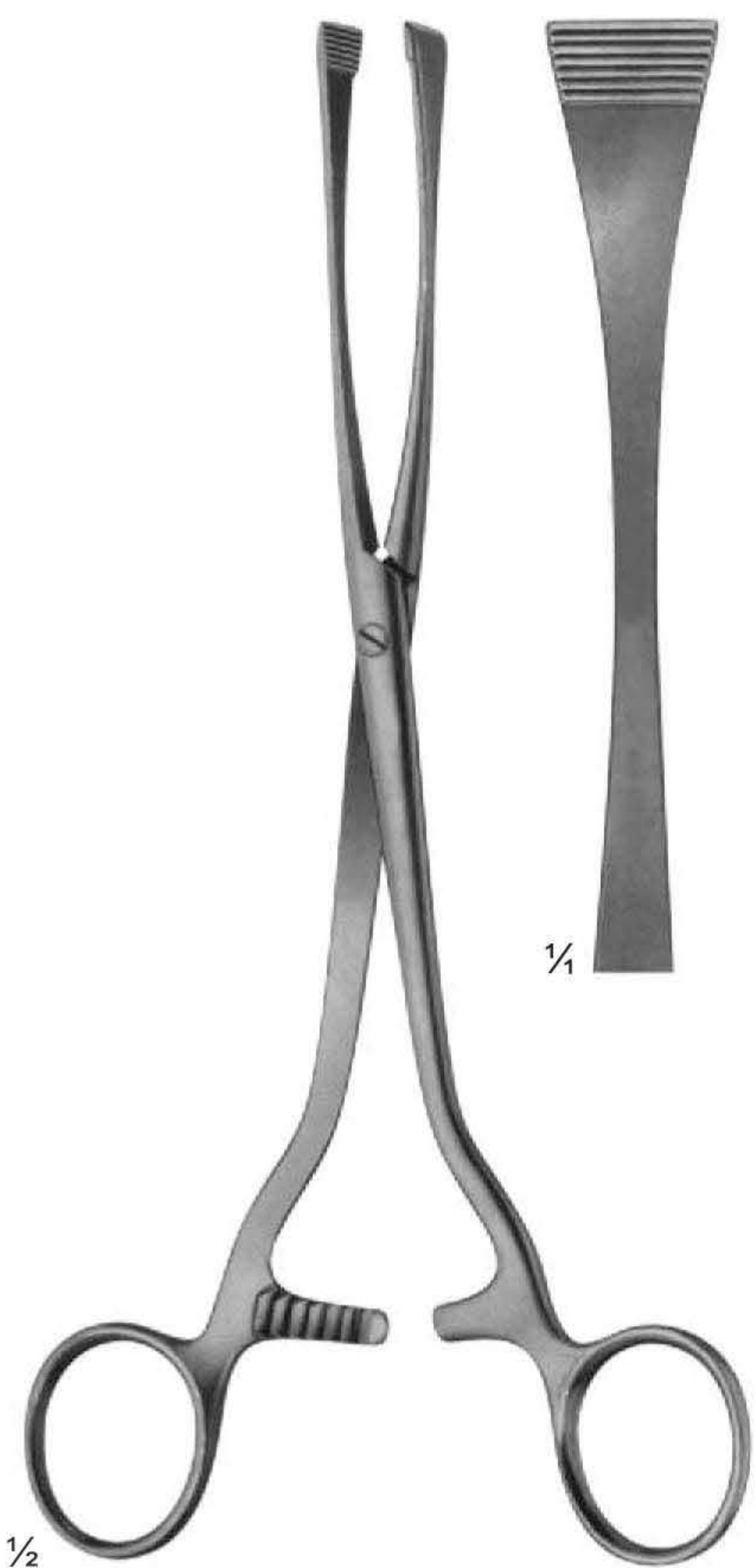

**UG-1214**  
**GREEN-ARMYTAGE**  
 Caesarean section haemostatic  
 forceps, for edges of the transverse  
 incision in the lower segment



**UG-1216**  
**WILLETT**  
 Scalpel Flap forceps

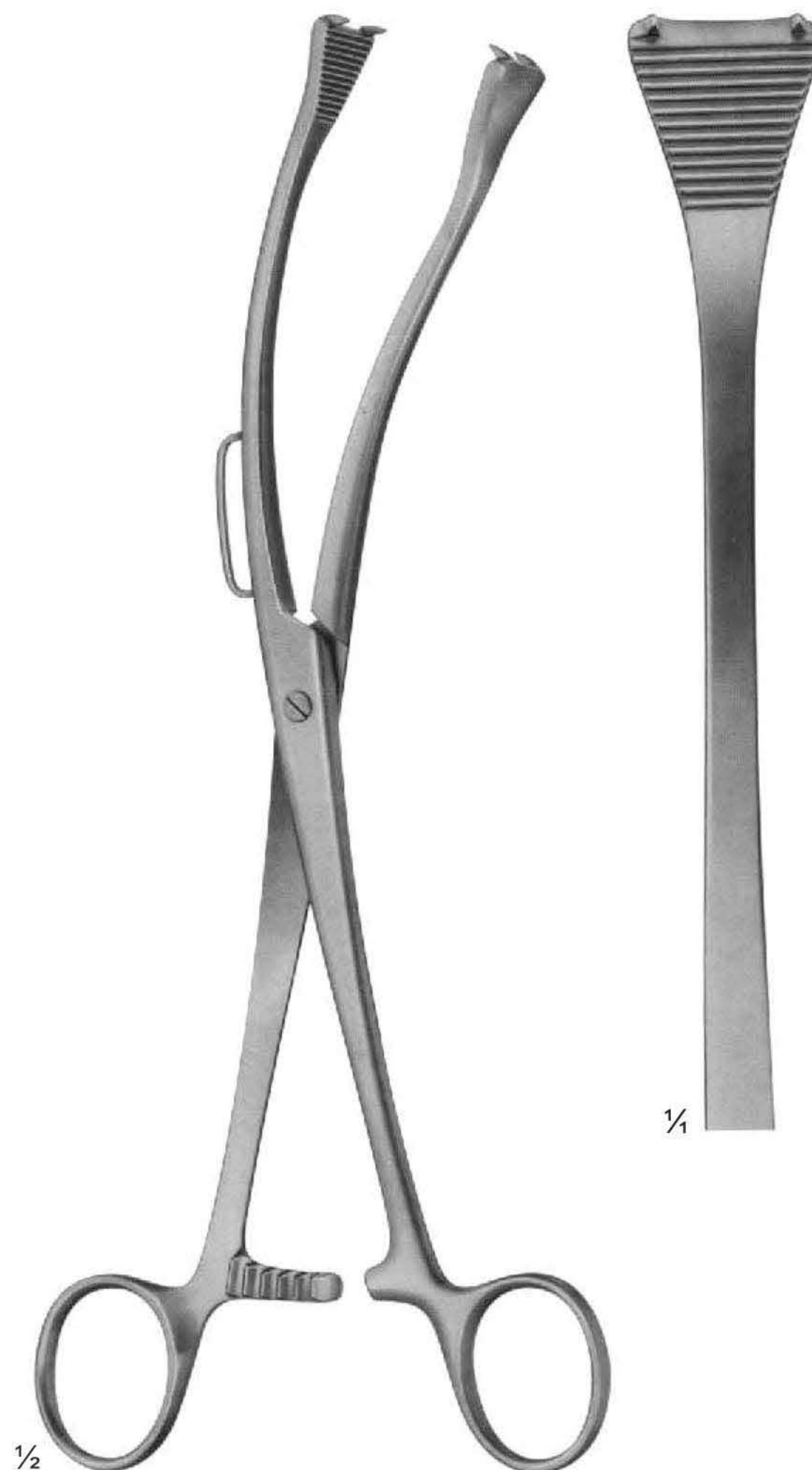

**UG-1217**  
**GAUSS**  
 Scalpel Flap forceps

# Obstetrics-Placenta and Ovum Forceps

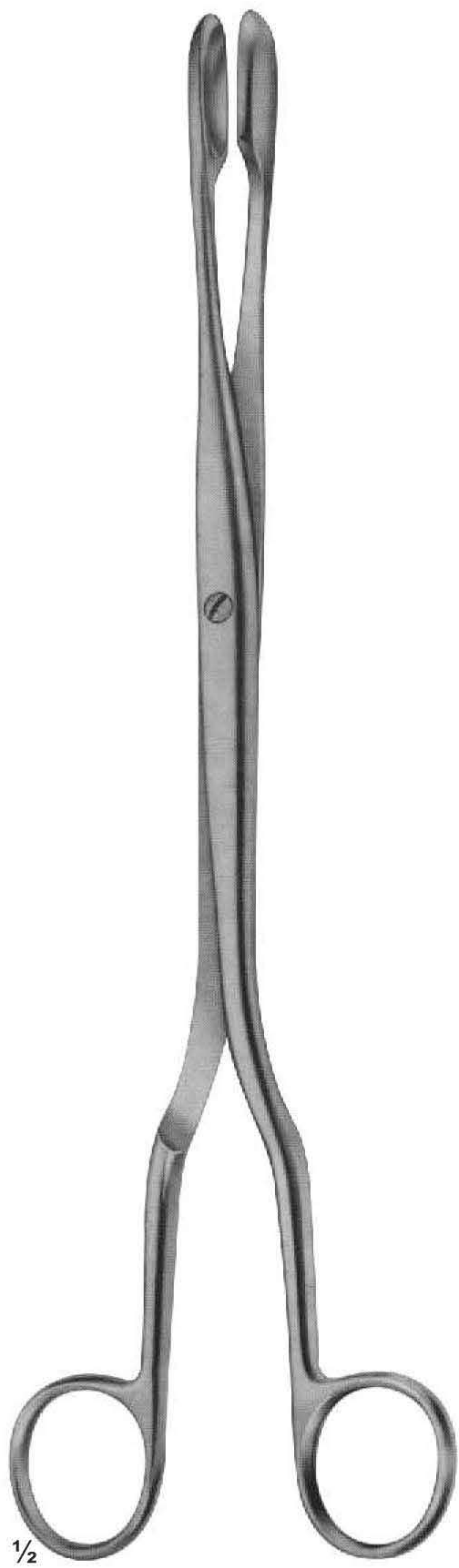

UG-1220  
WINTER



UG-1222  
WINTER

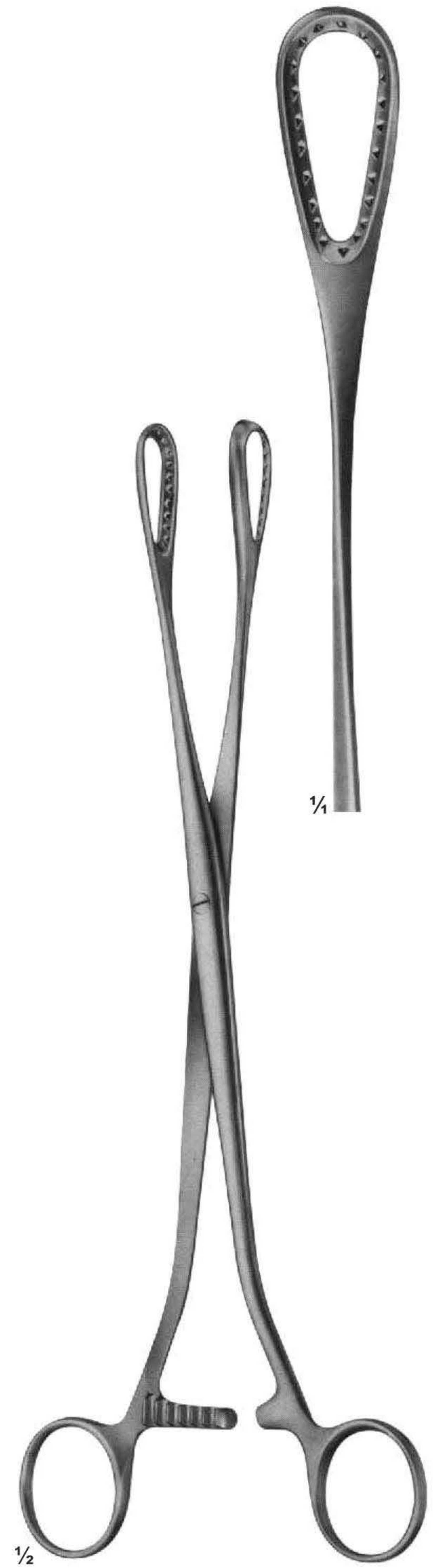

UG-1227  
SAENGER

# Obstetrics-Placenta and Ovum Forceps

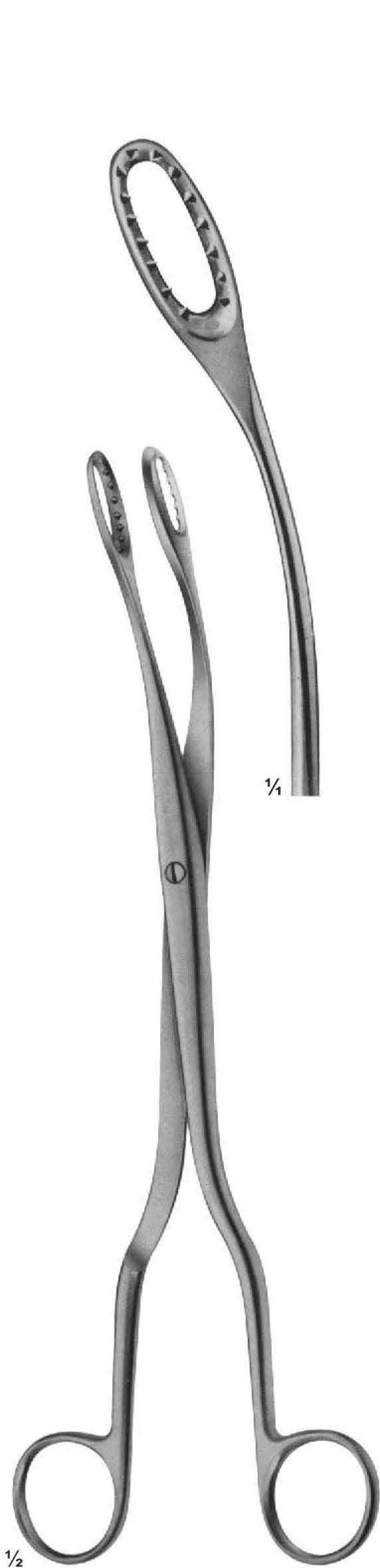

**UG-1228**  
SAENGER  
285 mm

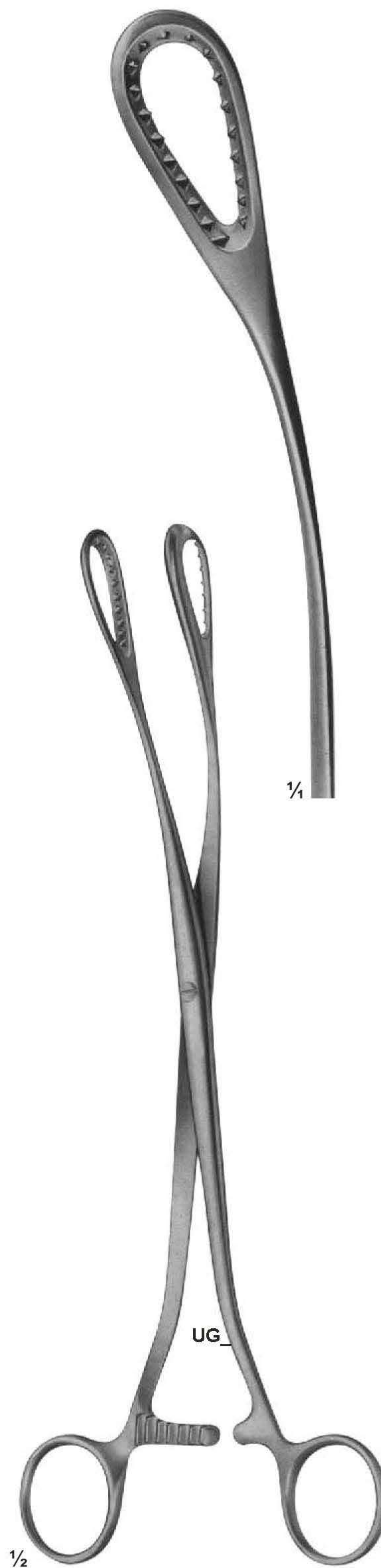

**UG-1229**  
SAENGER  
285 mm

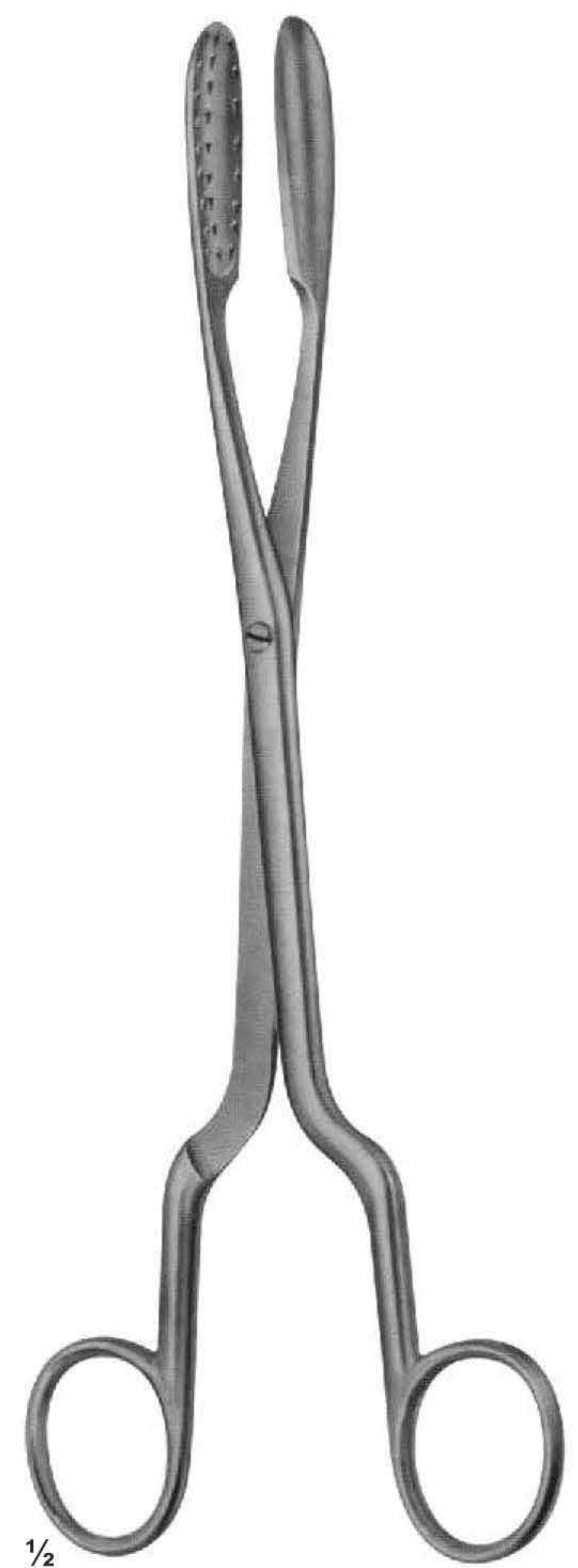

**UG-1230**  
LEWKOWIZ  
245 mm

# Obstetrics-Placenta, Ovum and Cranioclast, Basiotribe Forceps

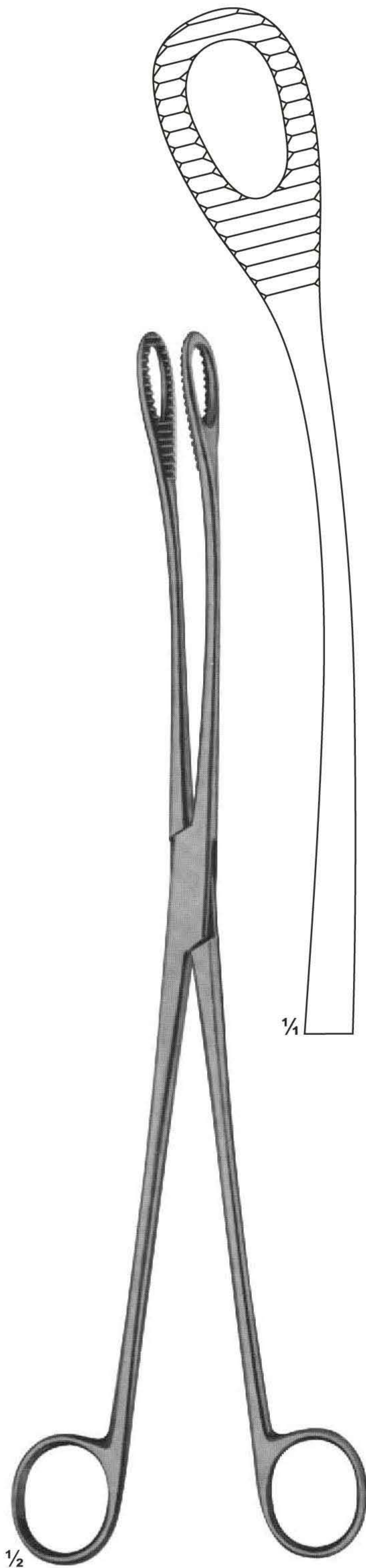

UG-1233  
KELLY  
320mm



UG-1234  
SMELLIE  
Perforator  
270mm



UG-1235  
BRAUN  
Cranioclast  
420mm

# Tracheal Tubes with inner tubes



1/2

**UG-1236**  
UECKERMANN-DENKER  
Cryothyrotomy trocar  
with silver cannula  
130mm

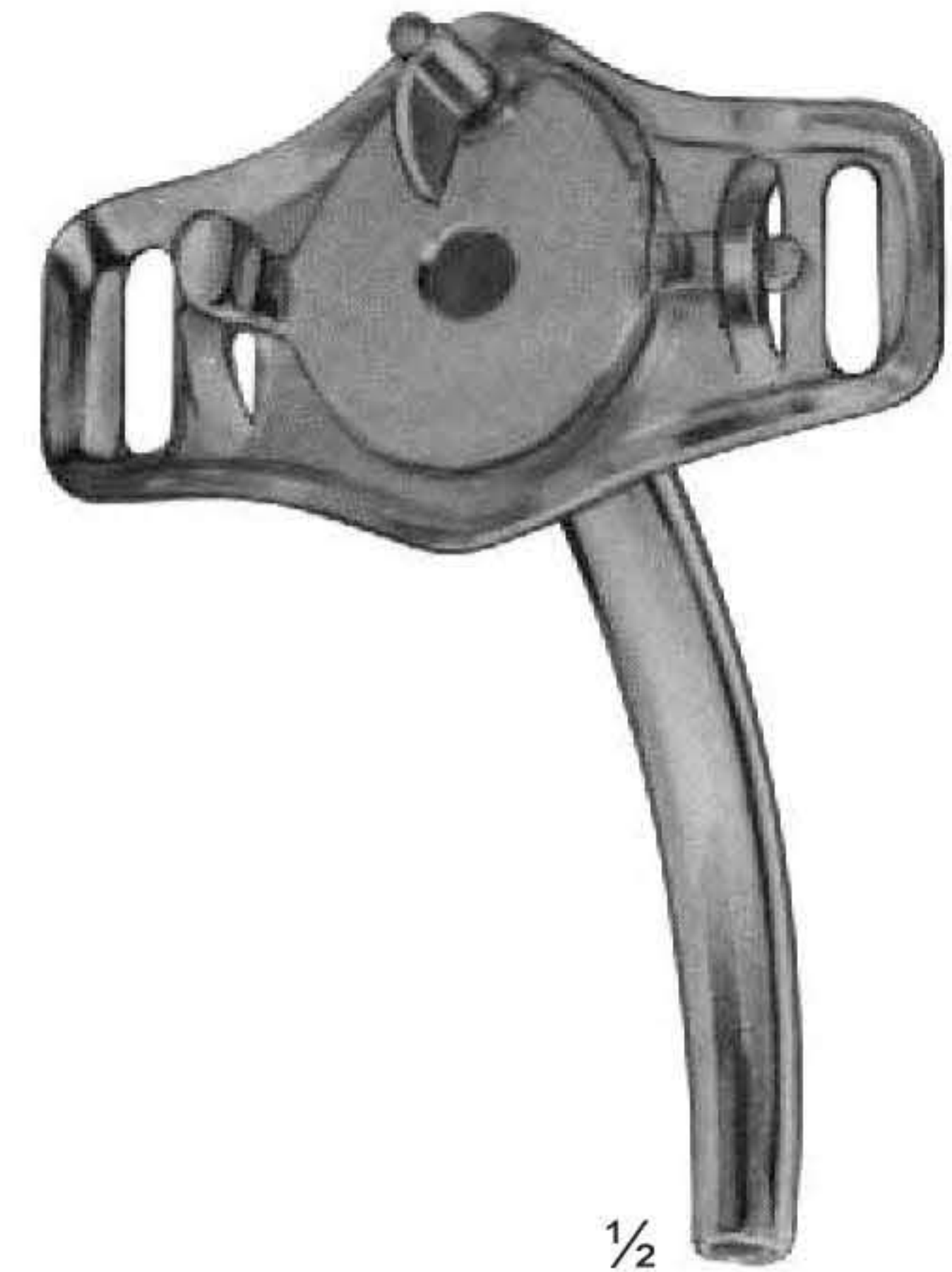

1/2

**UG-1237**  
LUER  
German silver



1/2

**UG-1238**  
JACKSON  
German Silver



1/2

**UG-1244**  
JACKSON  
German Silver

# Tound-and Tracheal Hooks and Dilators



**UG-1259**  
BOSE  
165 mm



**UG-1260**  
BOSE  
165 mm



**UG-1261**  
180 mm

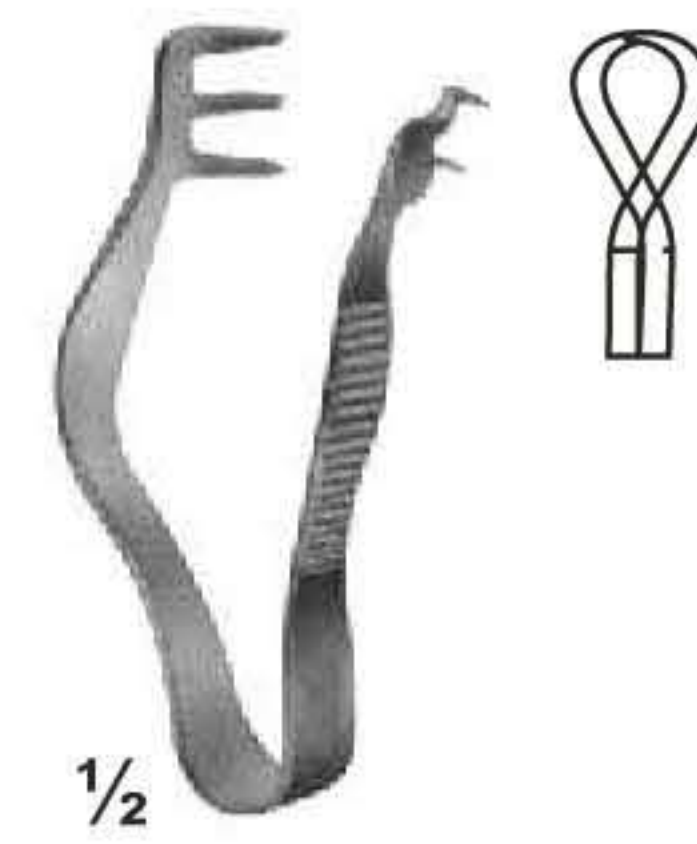

**UG-1270**  
FINSEN  
50 mm

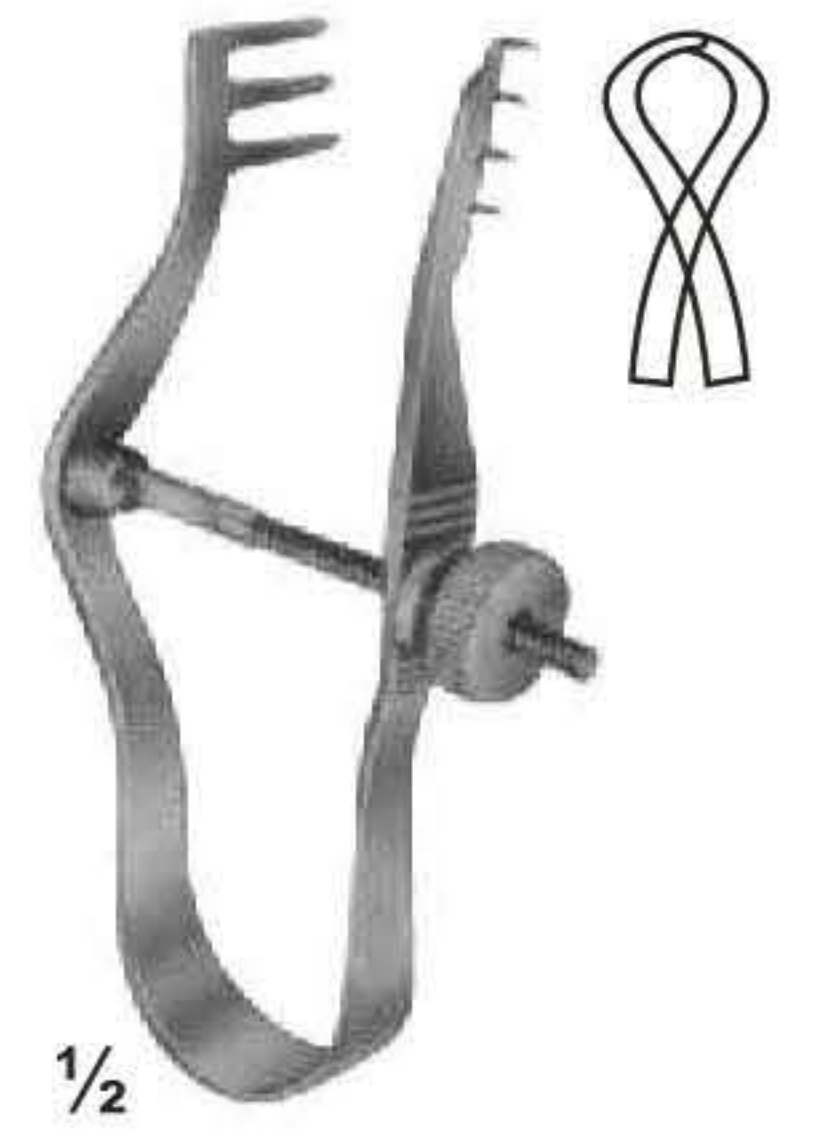

**UG-1271**  
FINSEN  
70 mm



**UG-1273**  
TROUSSEAU  
120 mm



**UG-1274**  
LABORDE  
125 mm

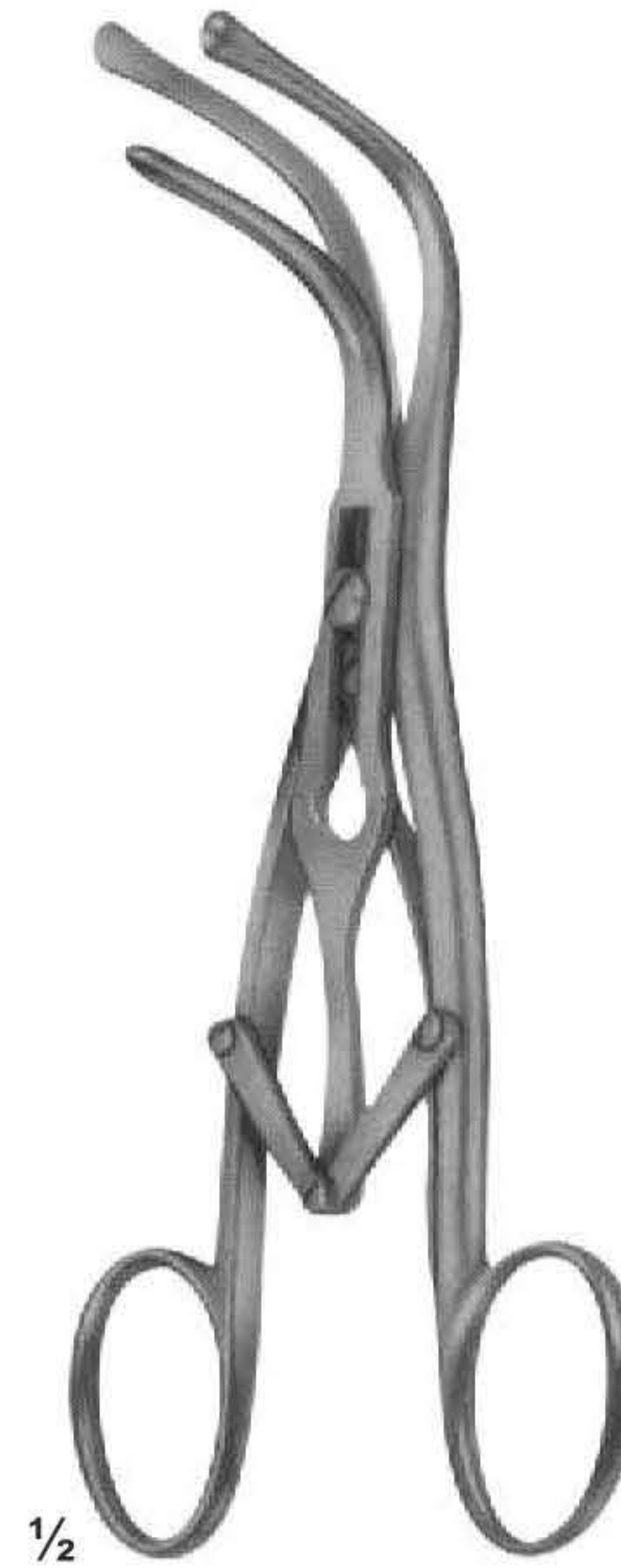

**UG-1275**  
LABORDE  
strong pattern  
135 mm



**UG-1276**  
Cleaning Brush  
for tracheal tubes  
285 mm



## Irrigating Cannulae, Embolus Grasping Forceps, Dilators



**UG-1279**  
SCHMID  
Vessel irrigating cannulae,  
malleable, silver plated  
150 mm

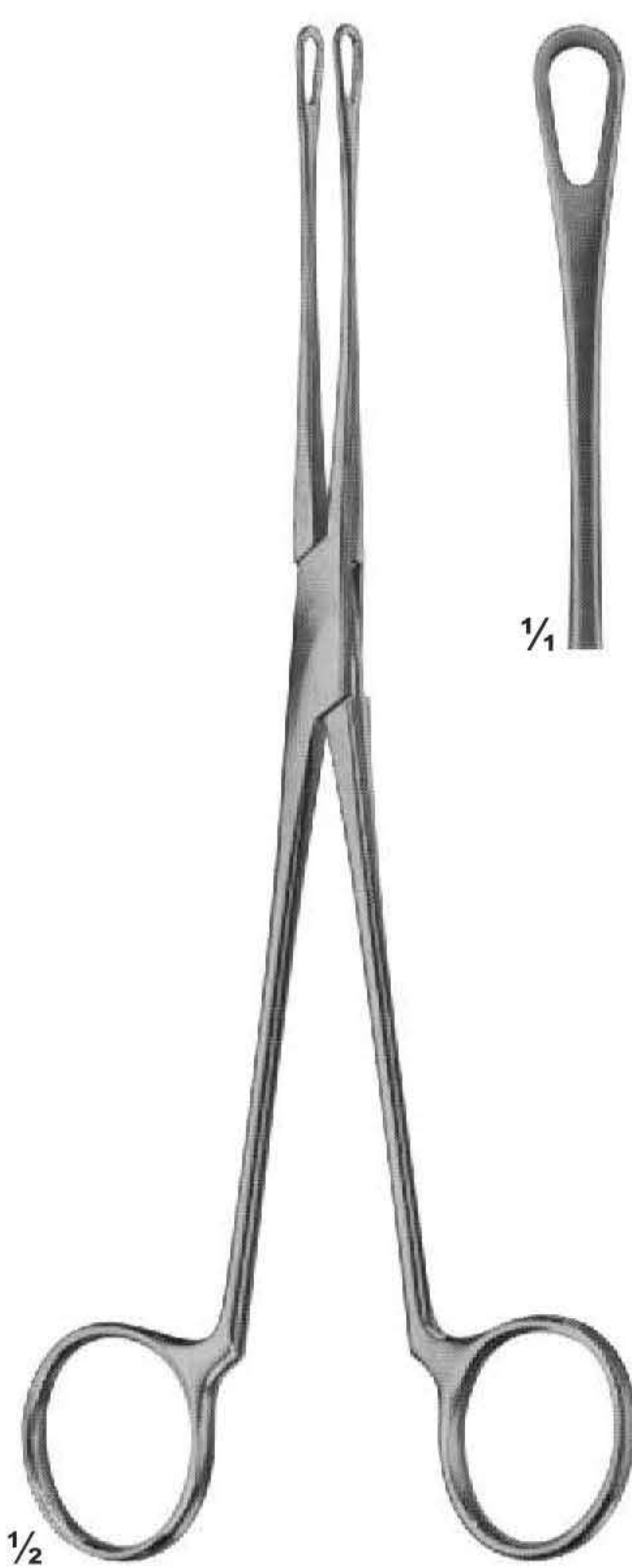

**UG-1281**  
BLAKE  
Embolus grasping  
forceps  
205 mm



**UG-1283**  
DE BAKEY  
Vascular dilators,  
malleable  
190 mm

# Irrigating Cannulae, Embolus Grasping Forceps, Dilators

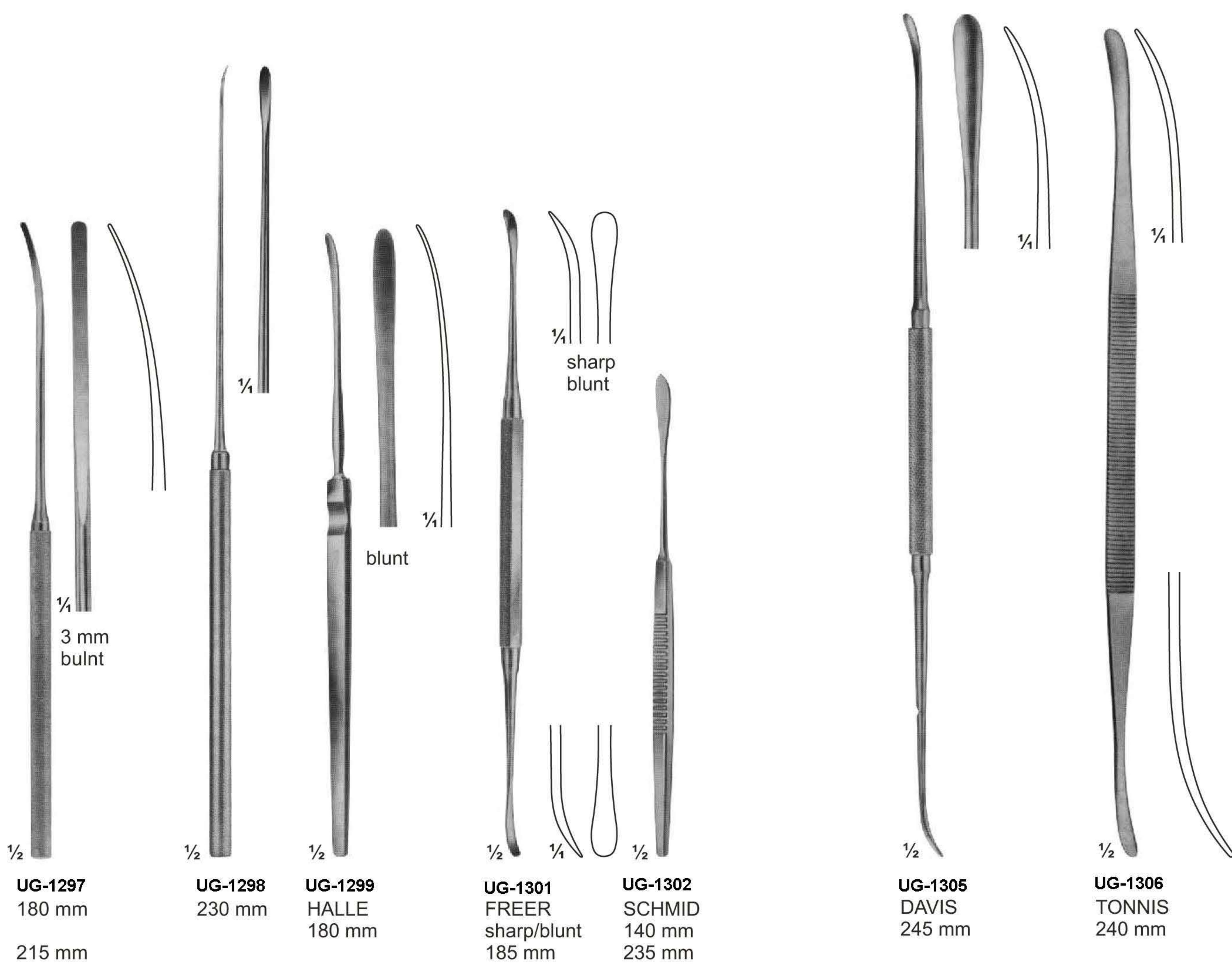

# Irrigating Cannulae, Embolus Grasping Forceps, Dilators



1/2

**UG-1307**  
Endarterectomy strippers  
550 mm



1/2

**UG-1308**  
Handle for  
110 mm



1/2

**UG-1309**  
RUMEL-BELBONT  
325 mm

**UG-1310**  
Guide only

# Biopotome and Aortic Dilators

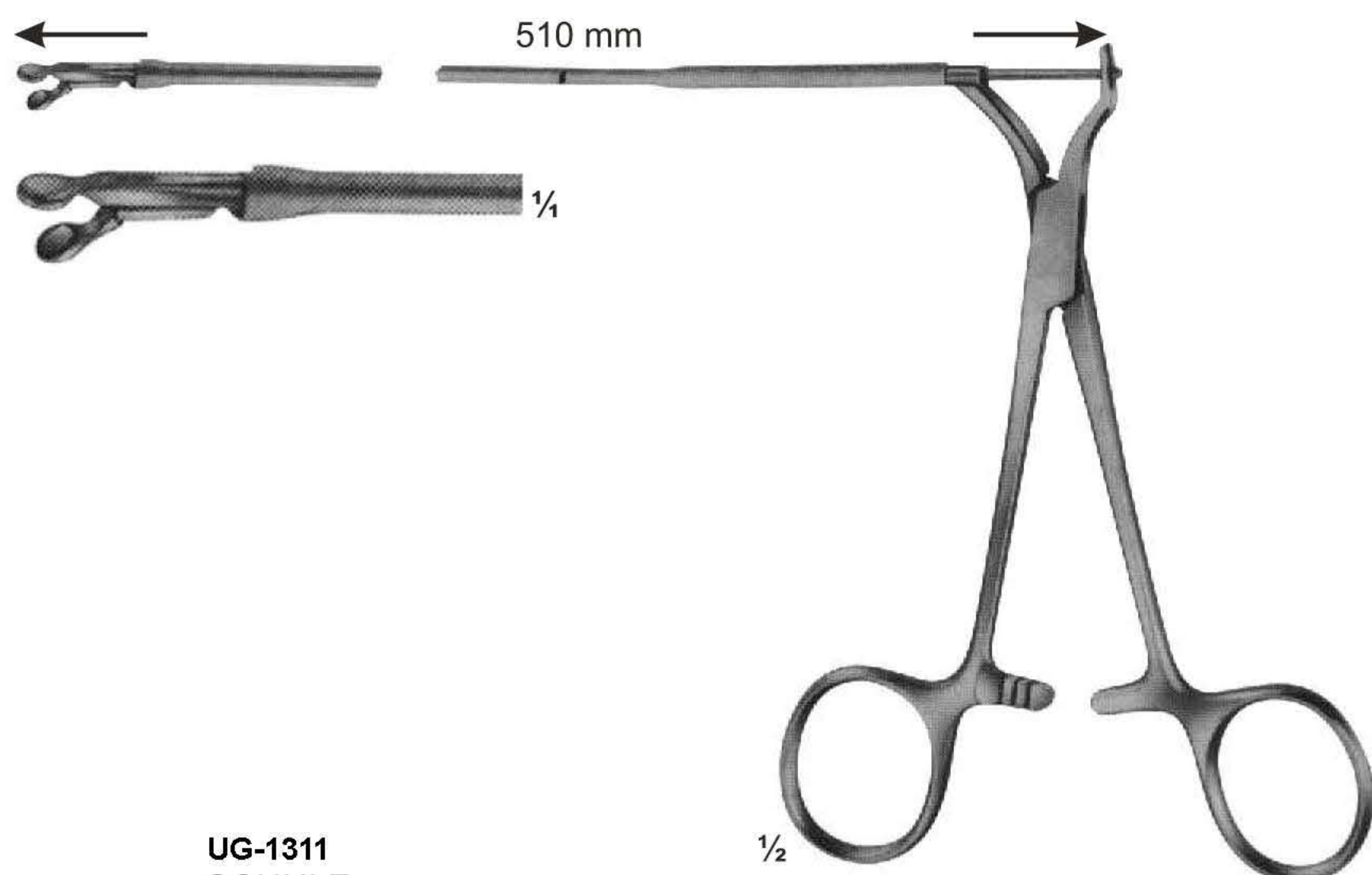

**UG-1311**  
**SCHULZ**  
 Biopotome, mit flexiblem Schaft, 510 mm lang,  
 with round jaws 3 mm diam.

Biopsy forceps, for biopsy from the right atrium  
 through cava juglaris, prior to heart implantations.

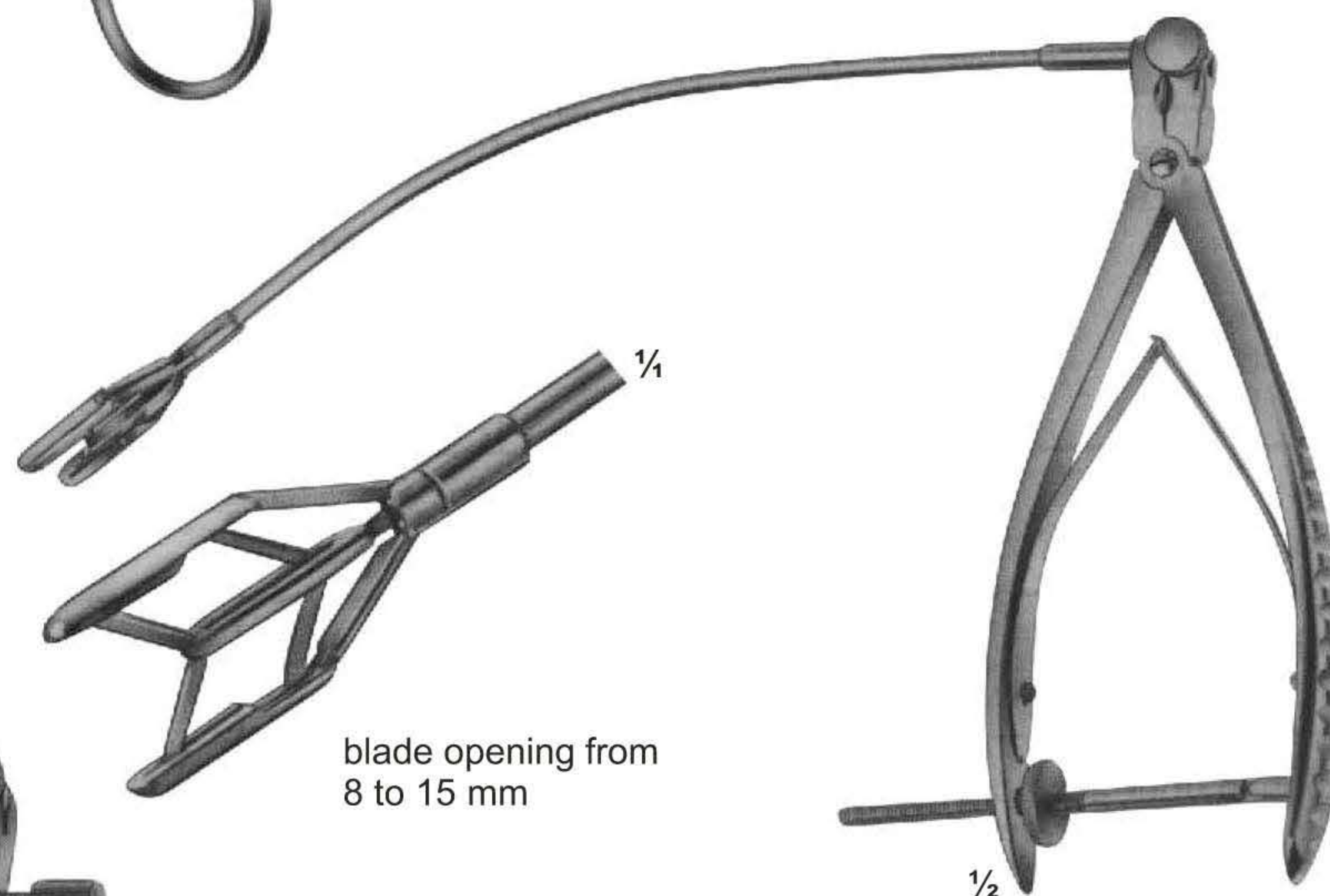

**UG-1313**  
**COOLEY**  
 Dilator for  
 mitral valve  
 for children

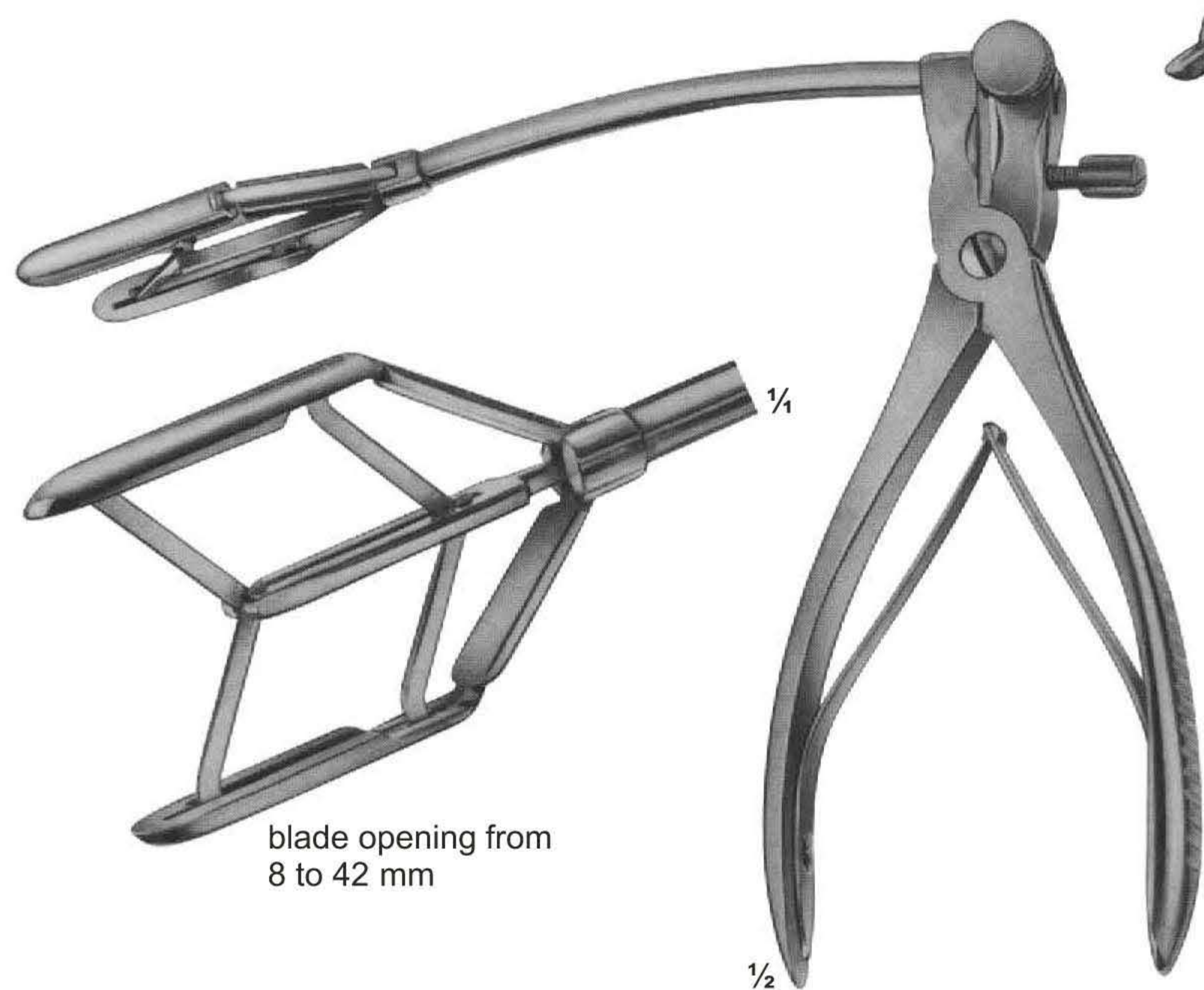

**UG-1312**  
**TUBBS**  
 Dilator for  
 mitral valve

blade opening from  
 8 to 42 mm

blade opening from  
 8 to 15 mm

# Biopotome and Aortic Dilators

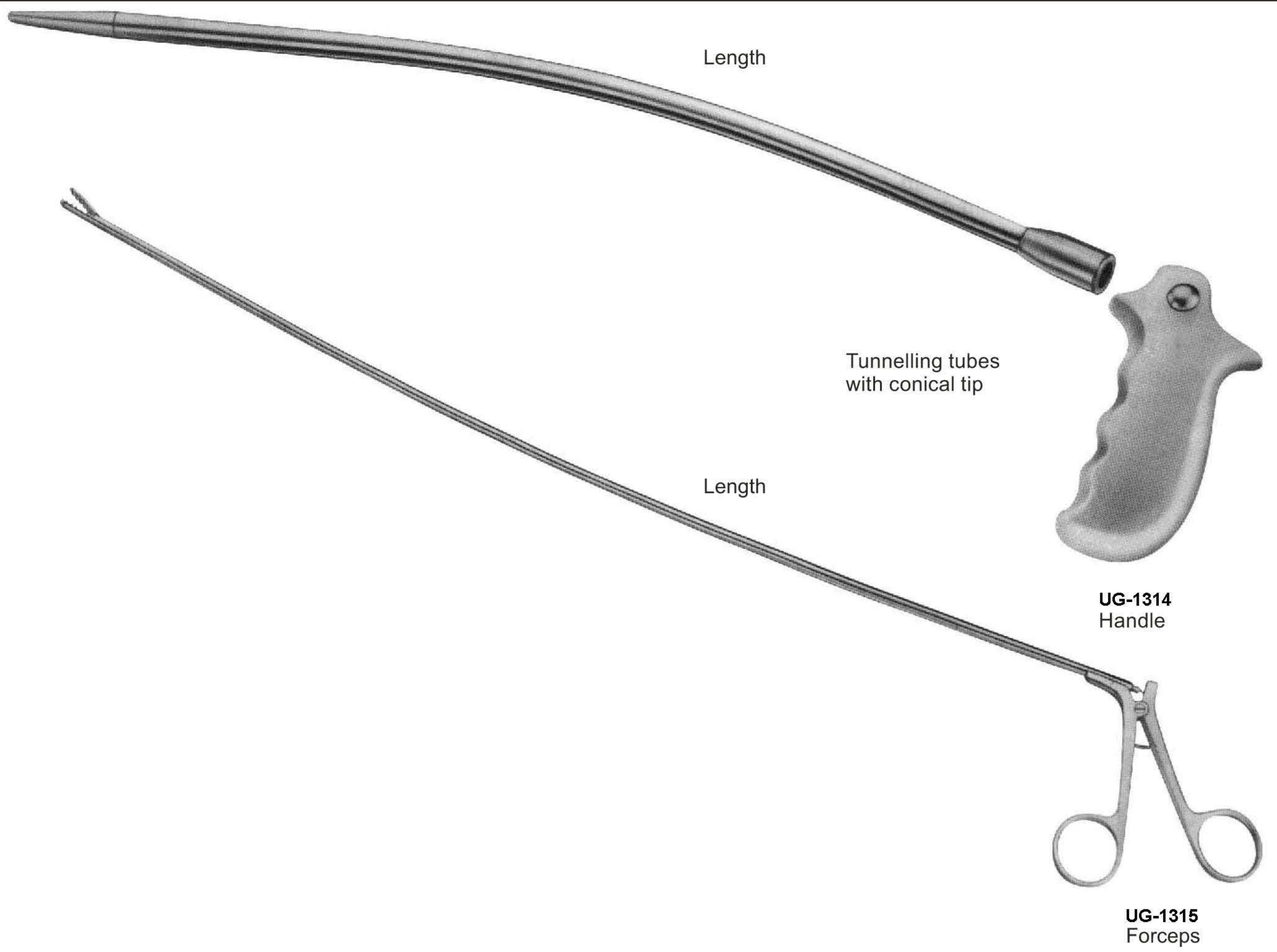

# Ultra-Light-Forceps

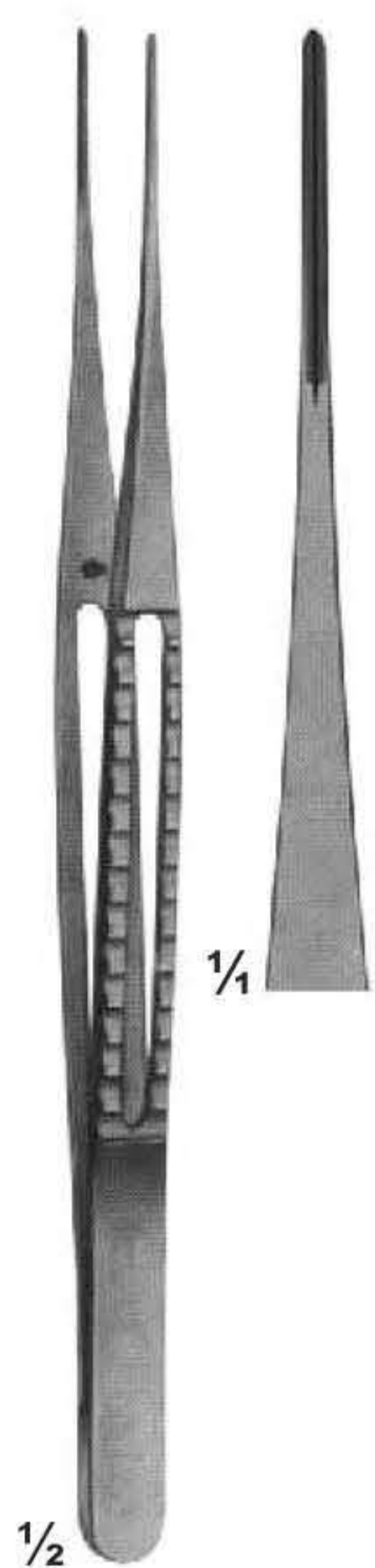

**UG-1318**  
Width of jaws  
1,5 mm  
Length  
150mm

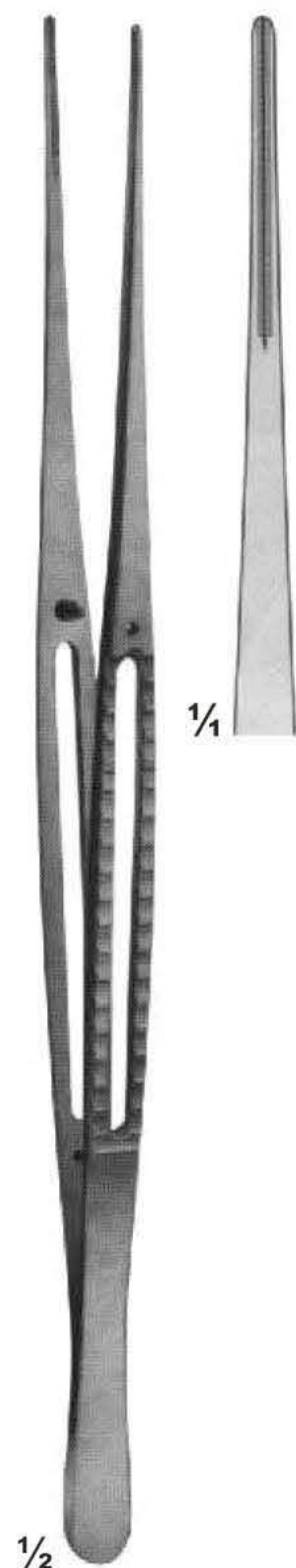

**UG-1319**  
1,5 mm  
200 mm



**UG-1320**  
1,5 mm  
240 mm



**17-154**  
1,5 mm  
300 mm

# Ultra-Light-Forceps



1/2  
**UG-1322**  
 DE BAKEY  
 150 mm  
 300 mm



1/2  
**UG-1323**  
 DE BAKEY  
 150 mm 200 mm  
 300 mm 240 mm



1/2  
**UG-1325**  
 DE BAKEY  
 150 mm 200 mm  
 300 mm 240 mm

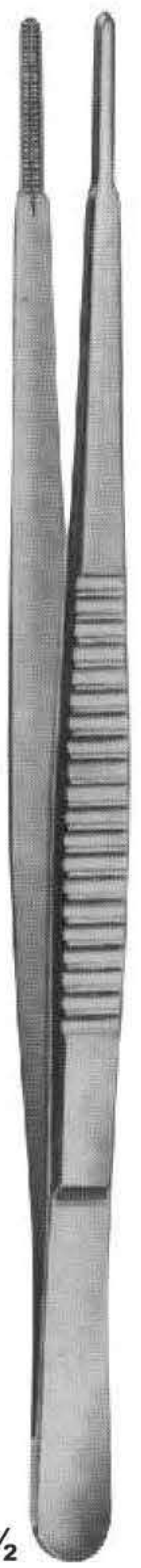

1/2  
**UG-1330**  
 DE BAKEY  
 200 mm  
 300 mm 240 mm

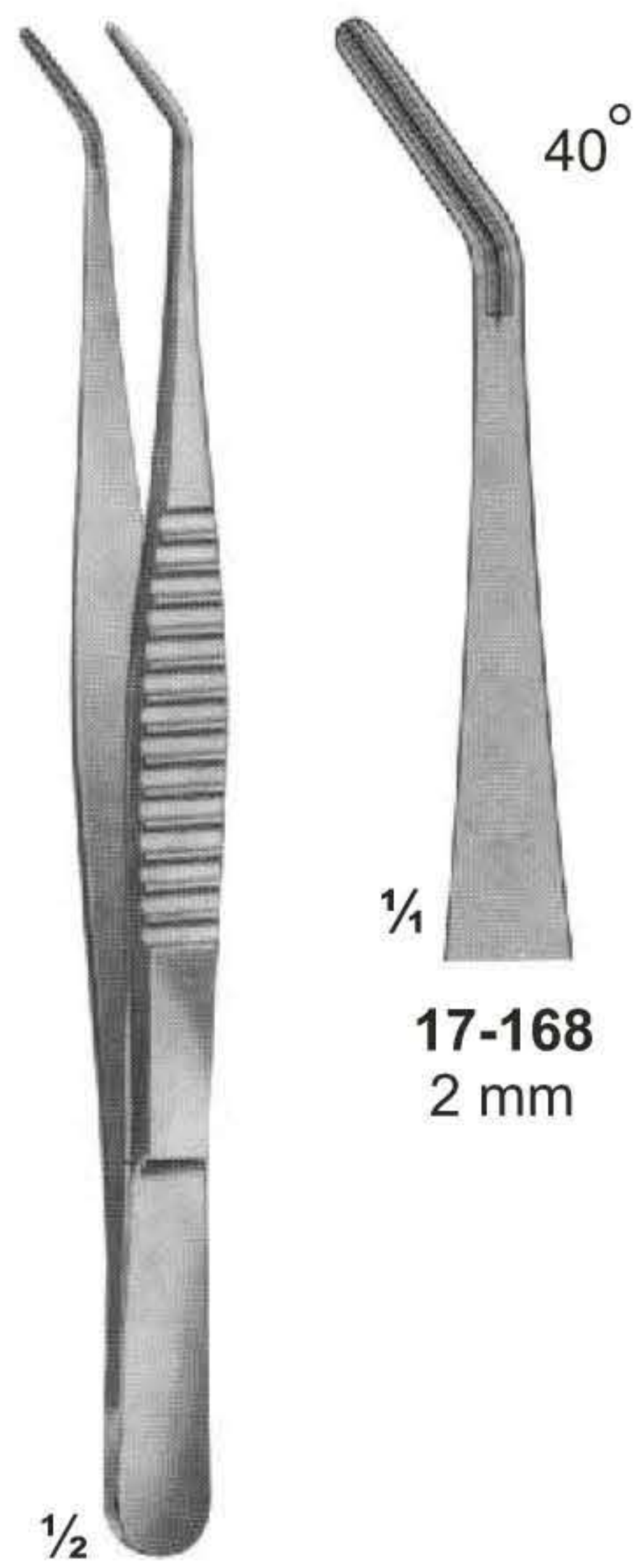

1/2  
**UG-1333**  
 DE BAKEY  
 150 mm

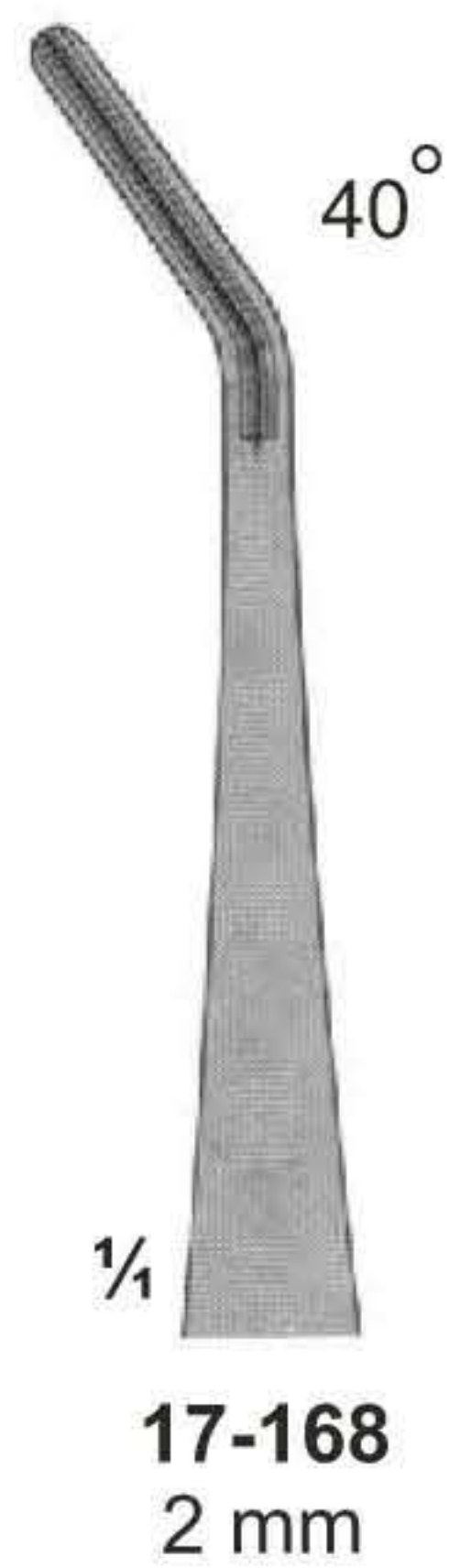

40°  
 1/4  
**17-168**  
 2 mm

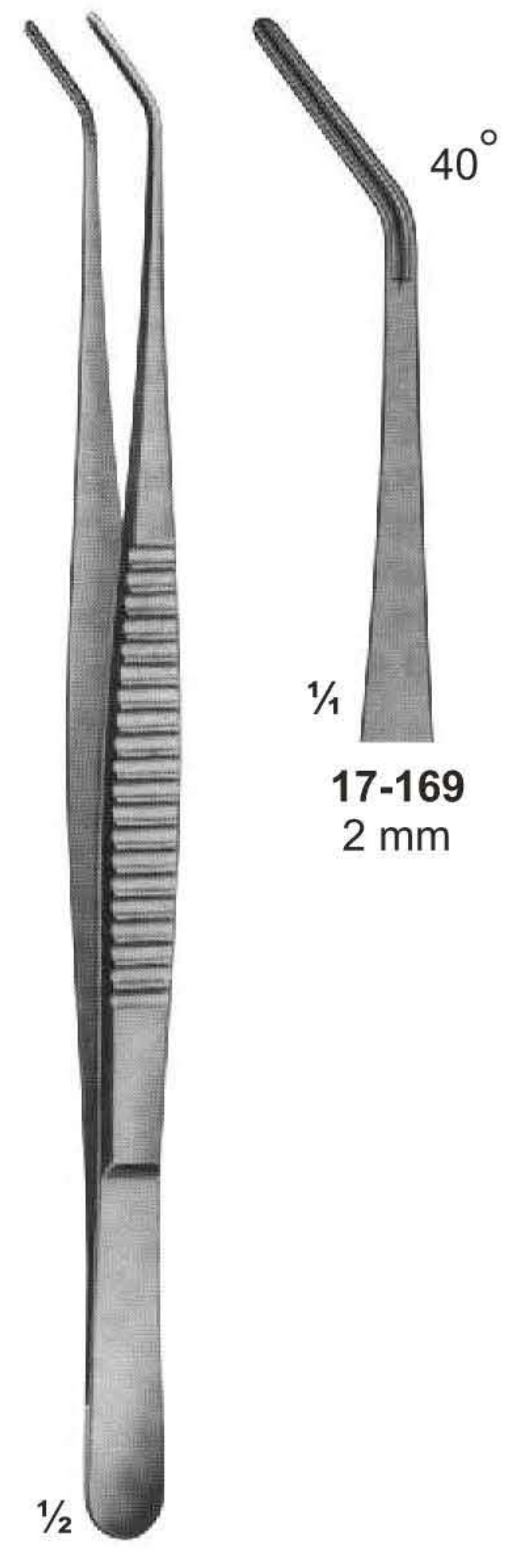

1/2  
**UG-1334**  
 DE BAKEY  
 200 mm

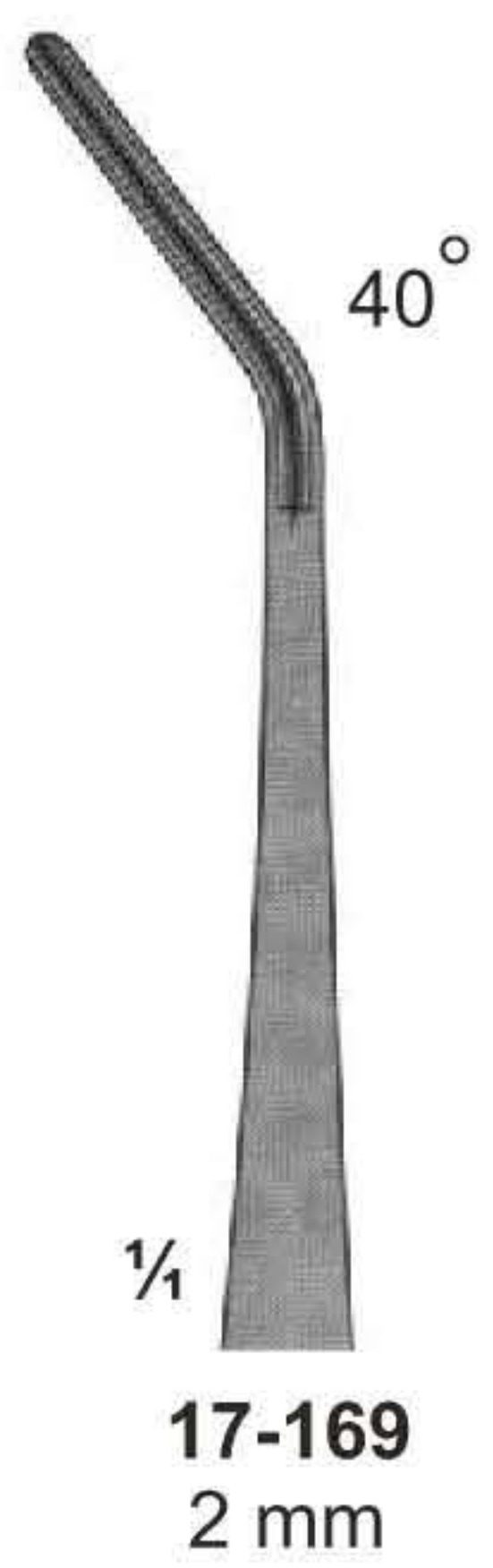

40°  
 1/4  
**17-169**  
 2 mm

# Ring Handle Bulldog Clamps

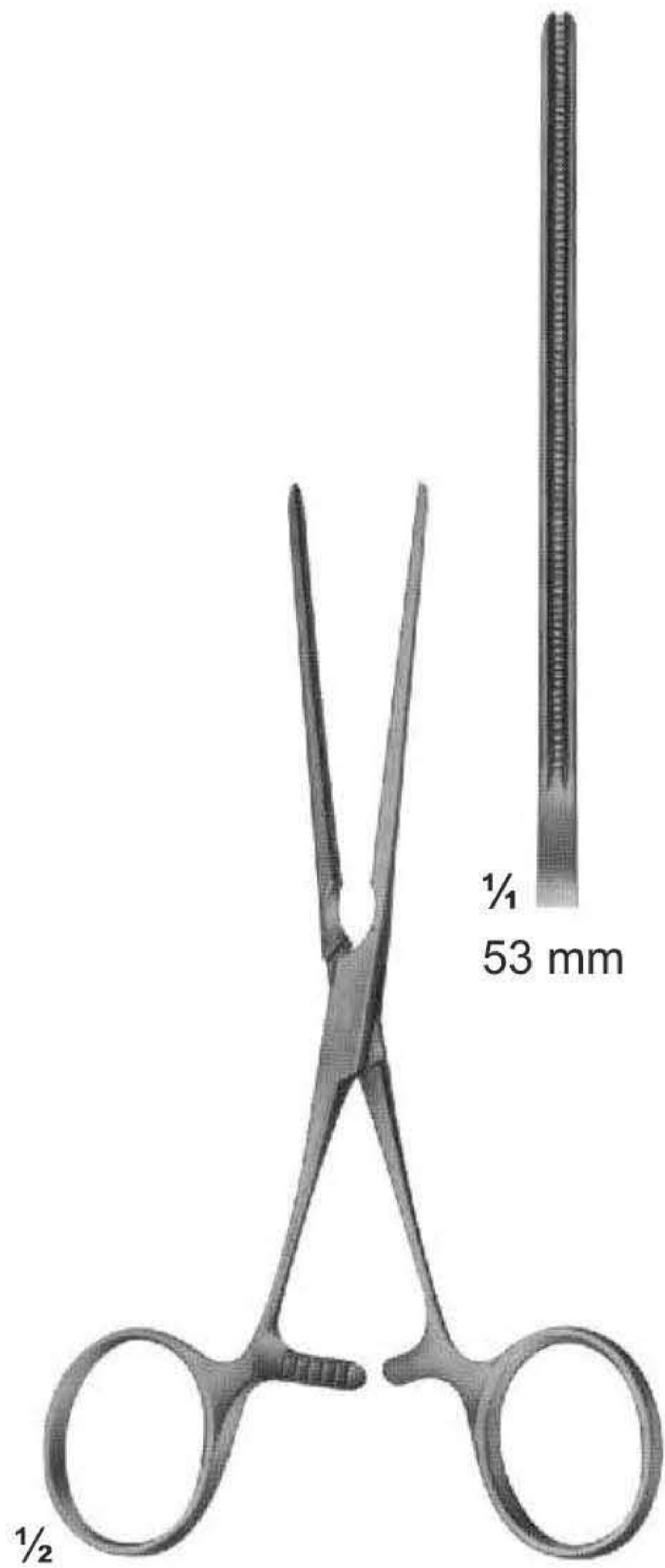

**UG-1337**  
DE-BAKEY  
gerade straight  
130 mm

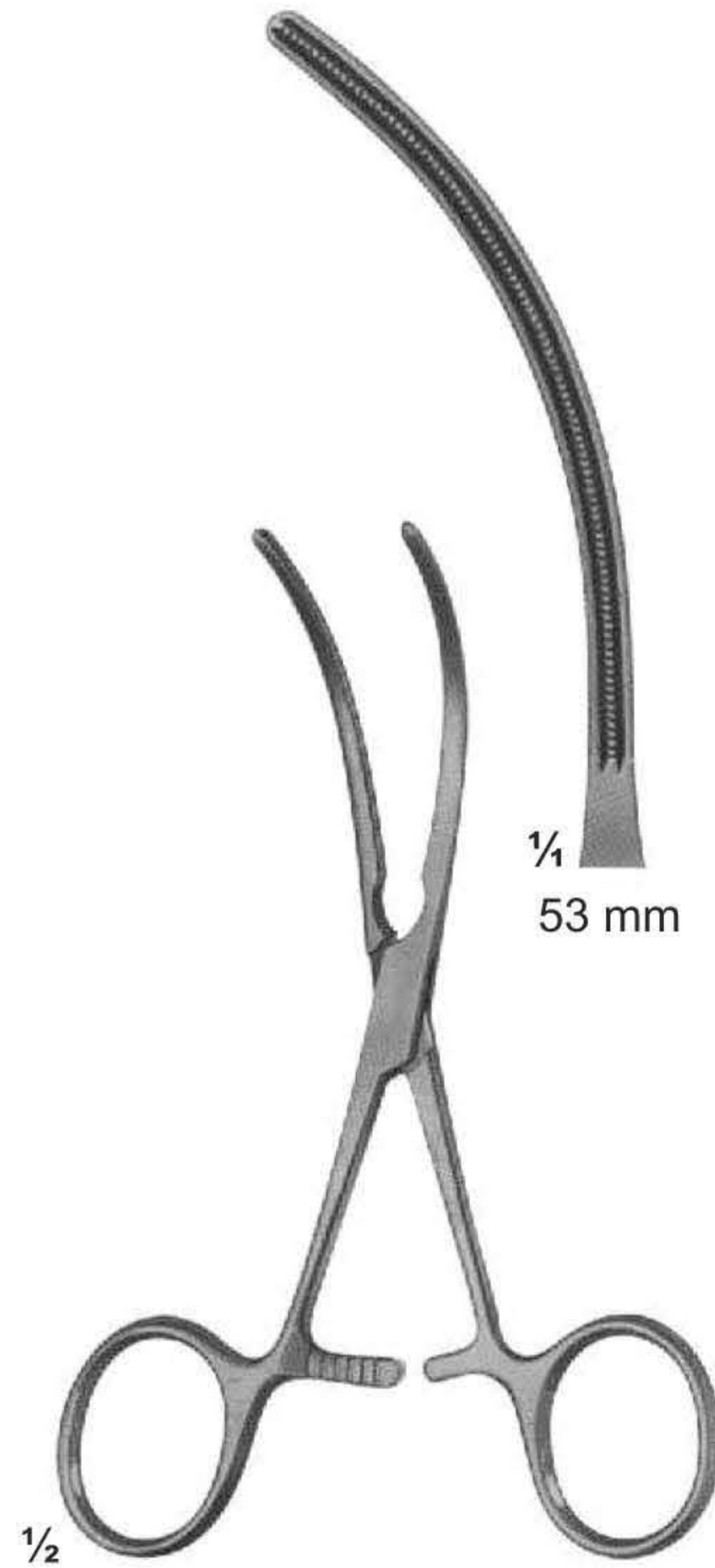

**UG-1338**  
DE-BAKEY  
Maul gebogen  
curved jaws  
125 mm

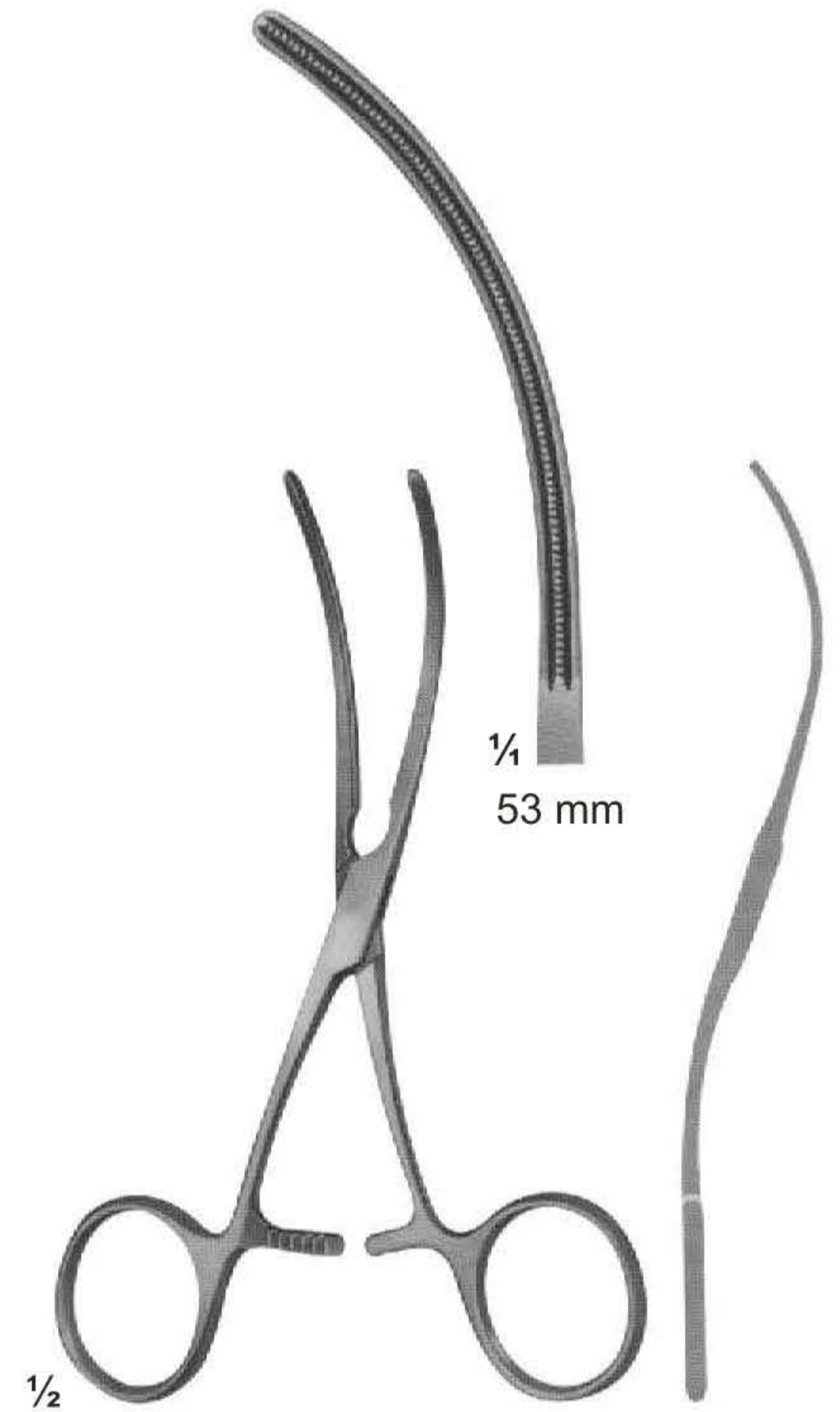

**UG-1340**  
DE-BAKEY  
S-shaped curved  
125 mm

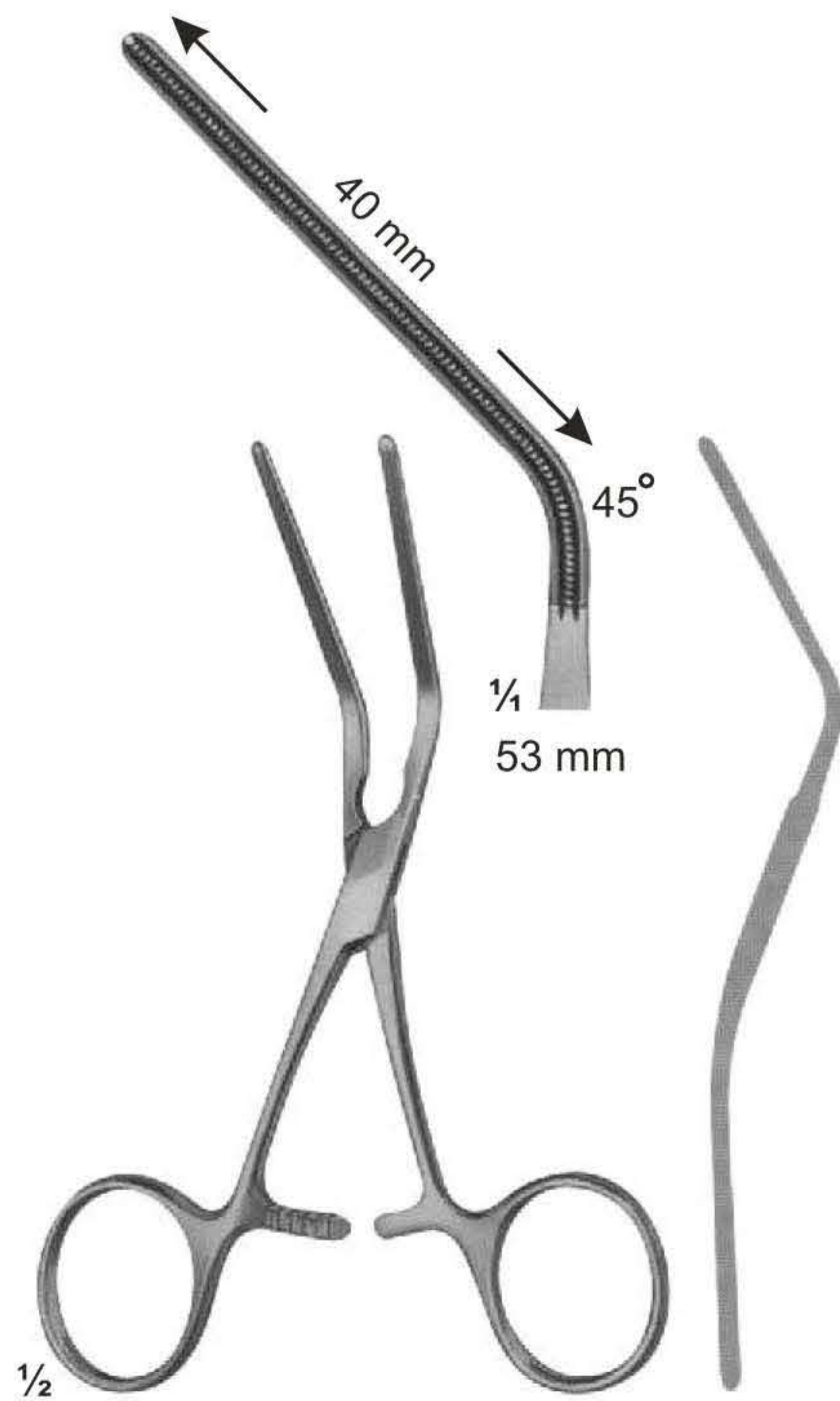

**UG-1341**  
DE-BAKEY  
45° winklig gebogen  
angled 45°  
125 mm

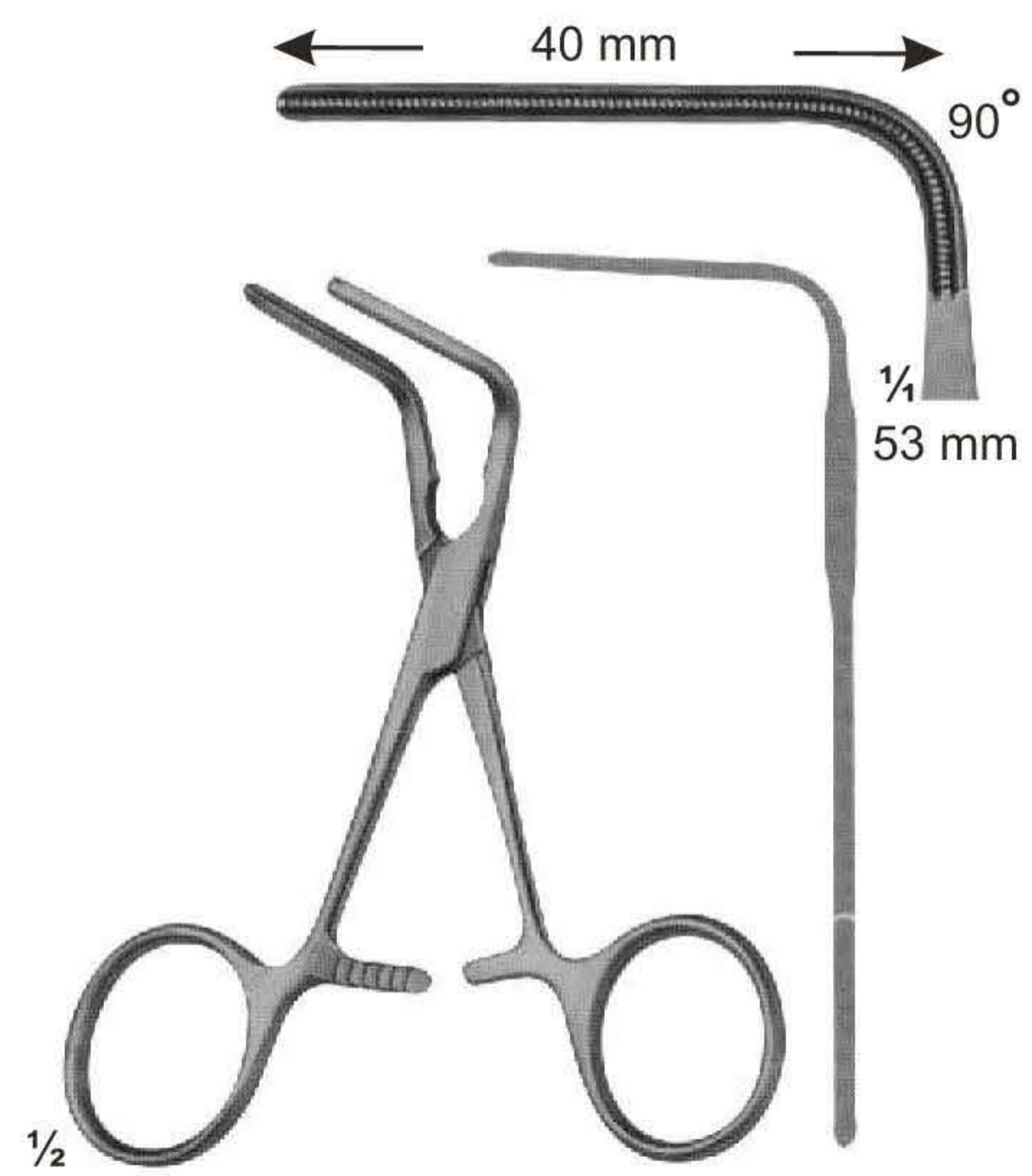

**UG-1342**  
DE-BAKEY  
90° winklig gebogen  
angled 90°  
105 mm



# Anastomosis-and Multi-Purpose-Clamps for Neonatales



# Anastomosis-and Multi-Purpose-Clamps-Pediatric types



**UG-1350**  
DE BAKEY



**UG-1352**  
COOLEY

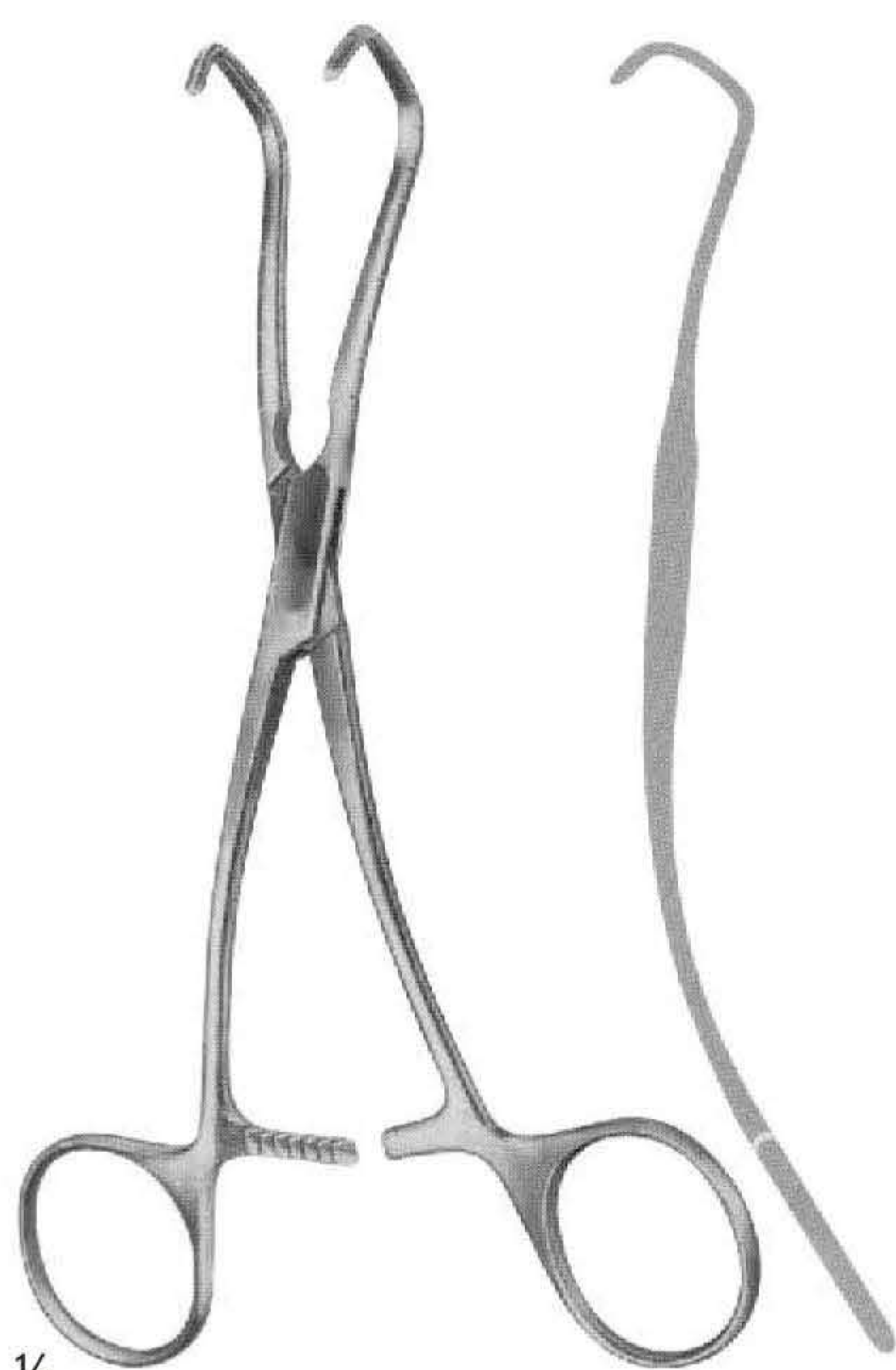

**UG-1353**  
DERRA

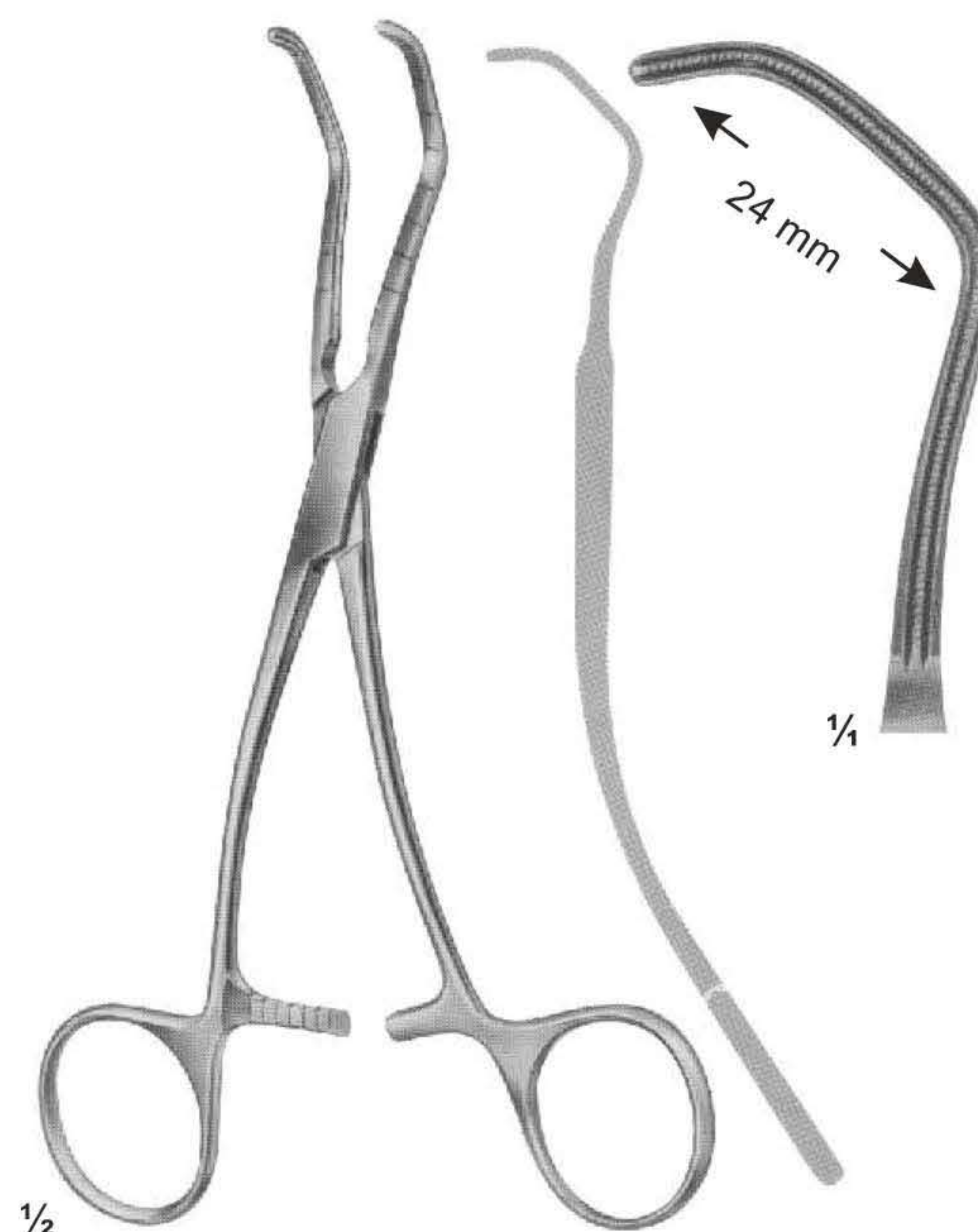

**UG-1354**  
COOLEY

## Non-traumatic Haemostatic Forceps



**UG-1355**  
125 mm



**UG-1356**  
165 mm



**UG-1357**  
DE BAKEY-BAINRIDGE  
155 mm



**UG-1358**  
DE BAKEY-BAINRIDGE  
180 mm

# Non-traumatic Haemostatic Forceps



**UG-1360**  
DE-BAKEY-KELLY  
140 mm



**UG-1361**  
PEAN  
155 mm



**UG-1364**  
DE-BAKEY-PEAN

# Anastomosis Clamps

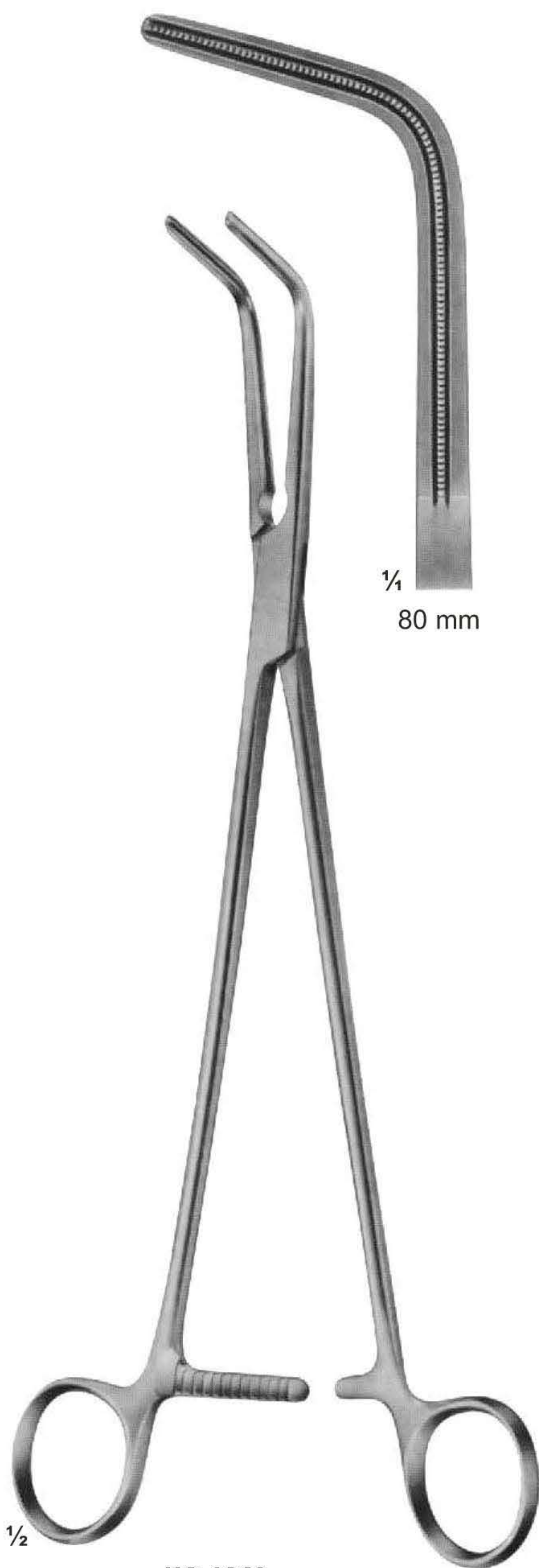

**UG-1369**  
DE-BAKEY-MIXTER  
285 mm



**UG-1371**  
GLOVER  
245 mm



**UG-1373**  
GLOVER  
220 mm

# Vena-Cava Clamps

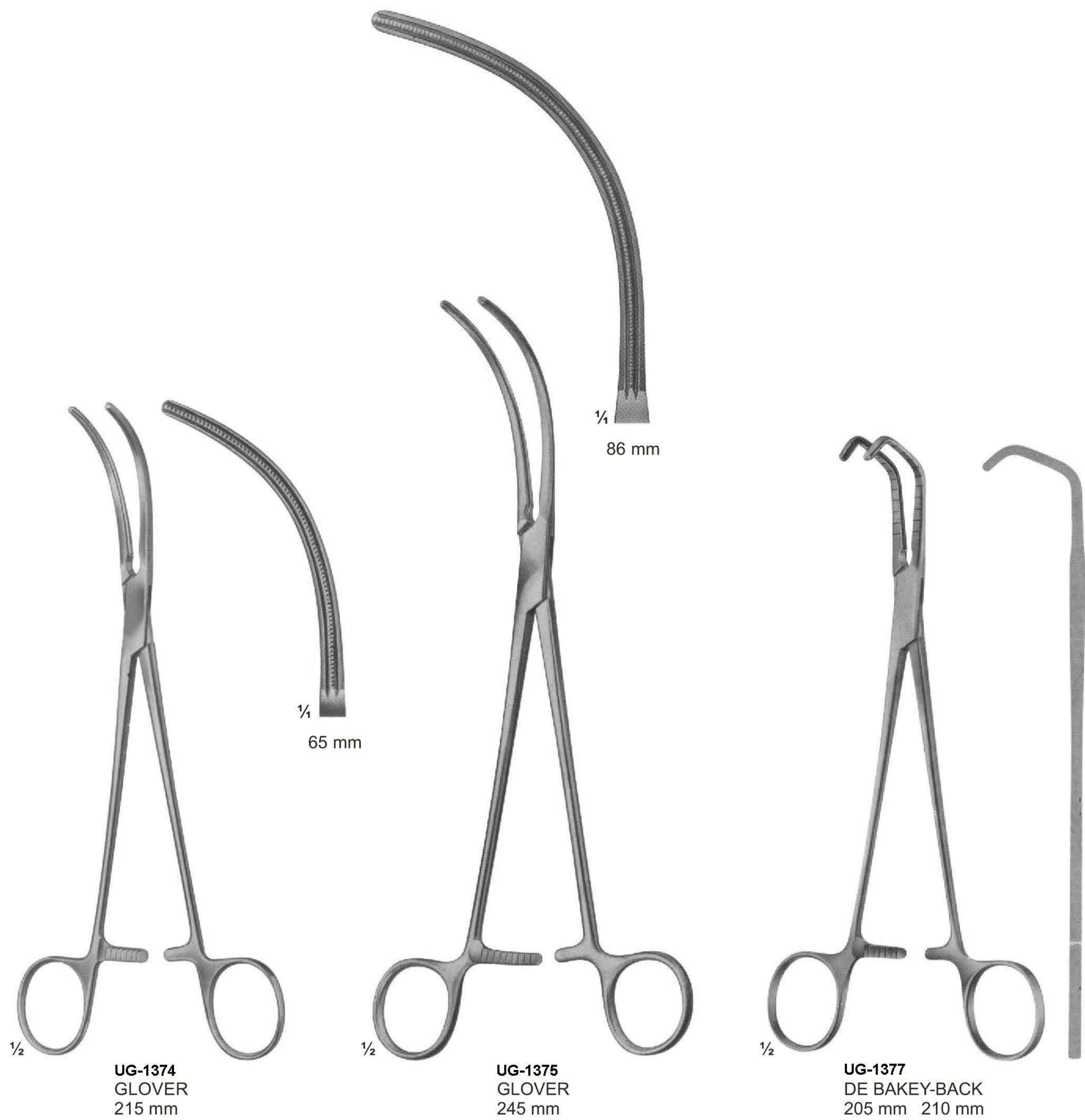

# Vena-Cava Clamps



**UG-1379**  
DE BAKEY-HARKEN



**UG-1381**  
DE BAKEY

# Vena-Cava Clamps



**UG-1384**  
DE BAKEY-SATINSKY  
235 mm, 240 mm, 245 mm



**UG-1386**  
DE BAKEY  
170 mm, 165 mm



**UG-1388**  
DE BAKEY  
165 mm



# Vena-Cava Clamps



**UG-1392**  
DE BAKEY  
205 mm, 225 mm, 240 mm



**UG-1405**  
DE BAKEY  
200 mm, 225 mm, 240 mm

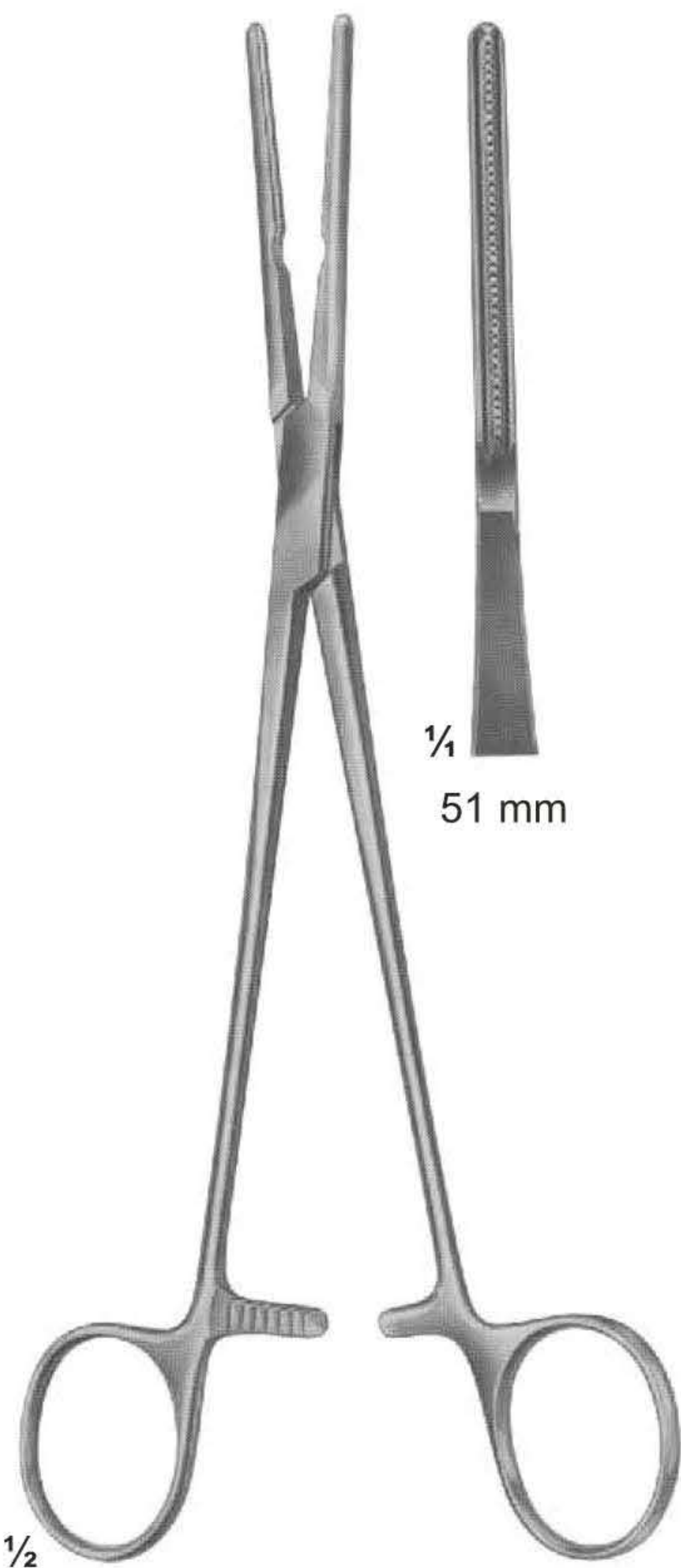

**UG-1407**  
DE BAKEY  
210 mm

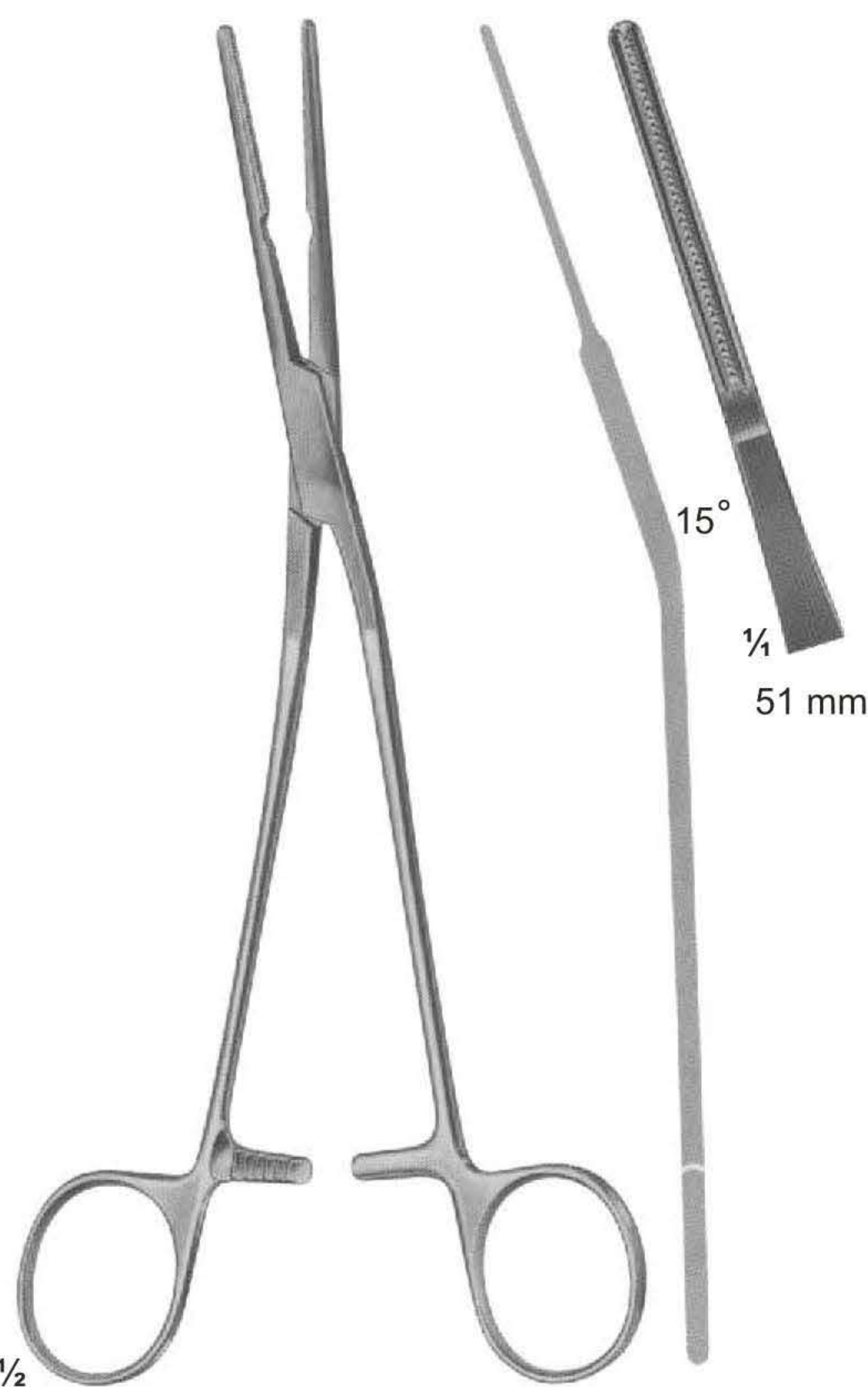

**UG-1408**  
DE BAKEY  
210 mm

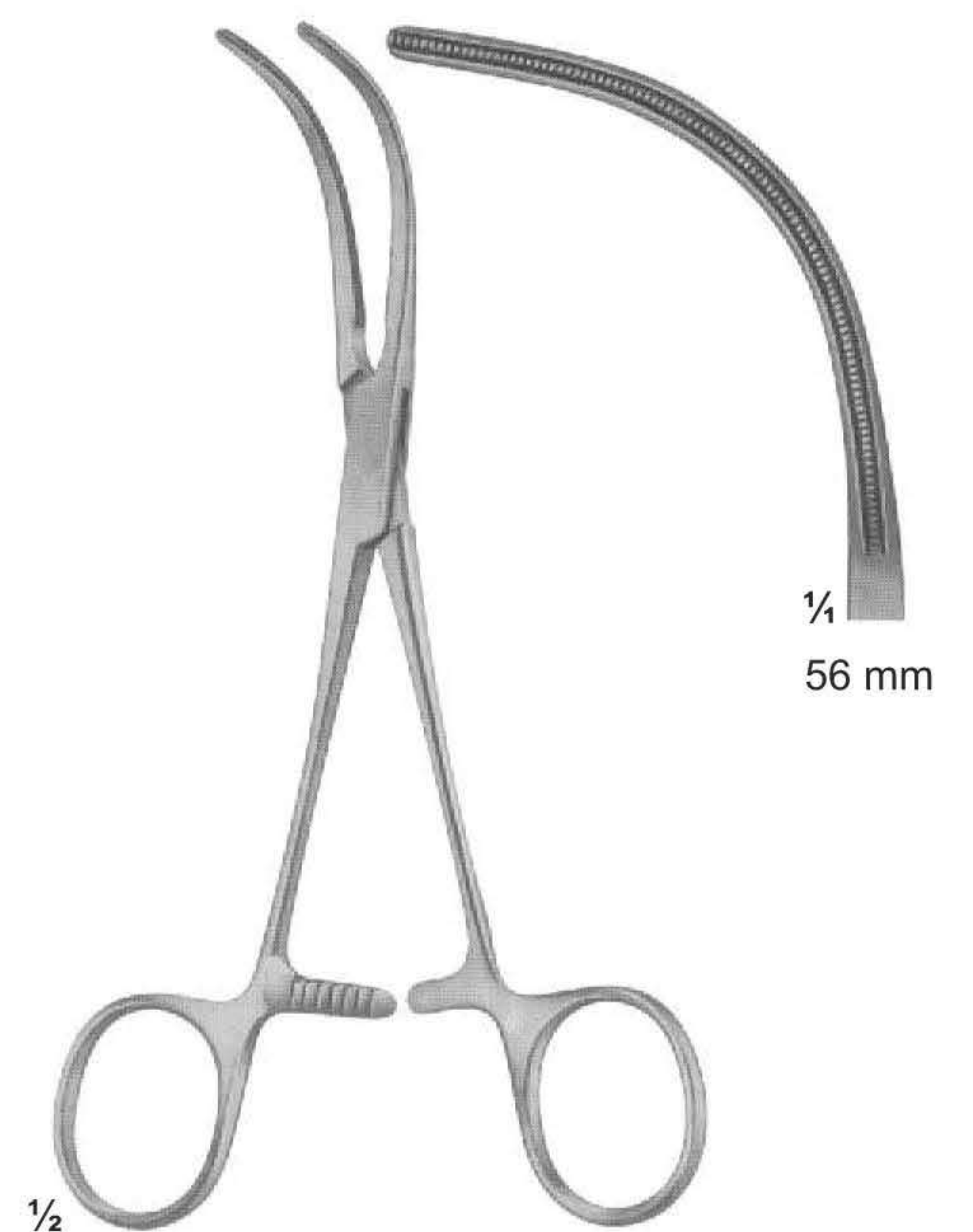

**UG-1409**  
DE BAKEY  
160 mm

# Vena-Cava Clamps

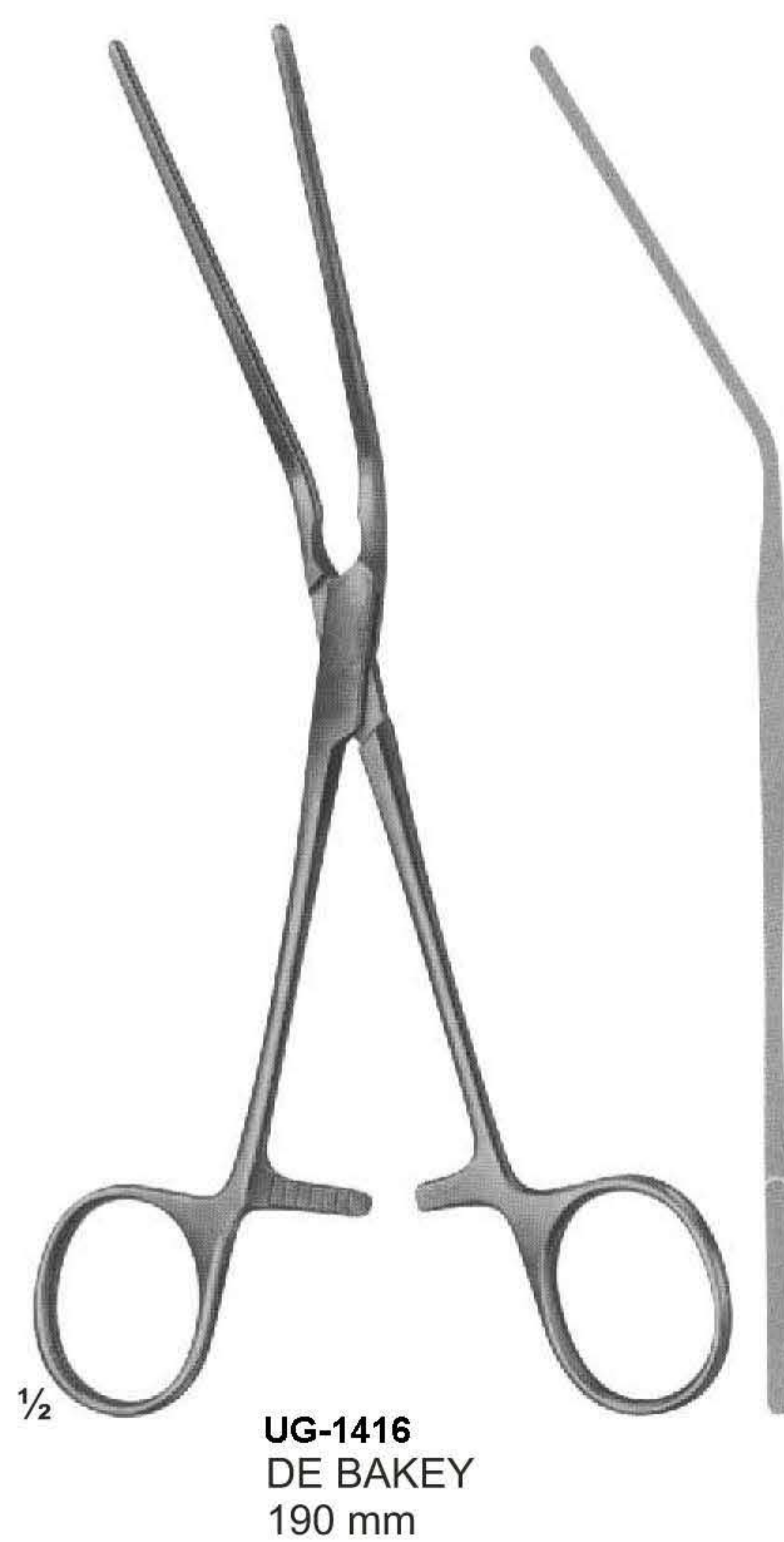
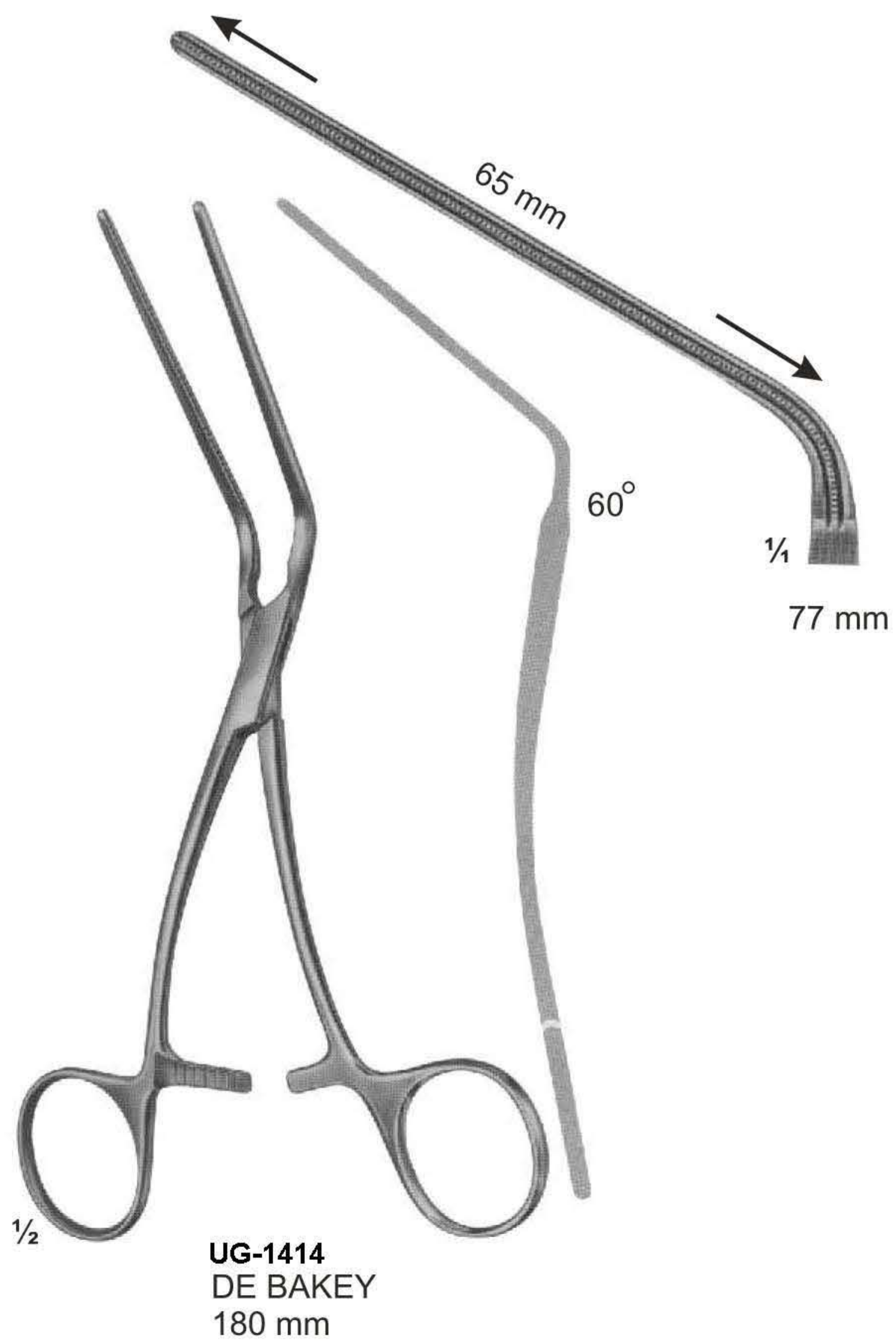
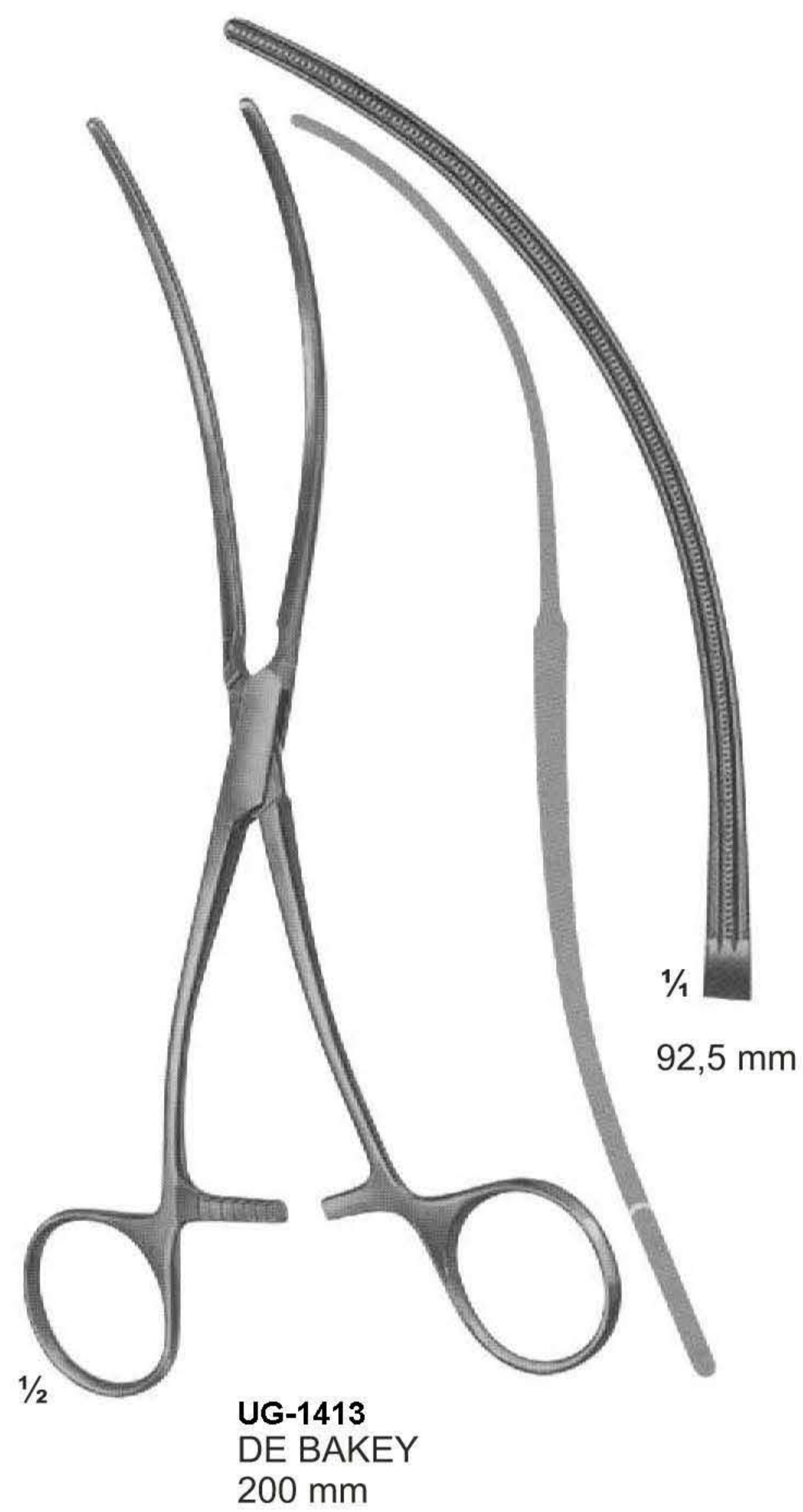
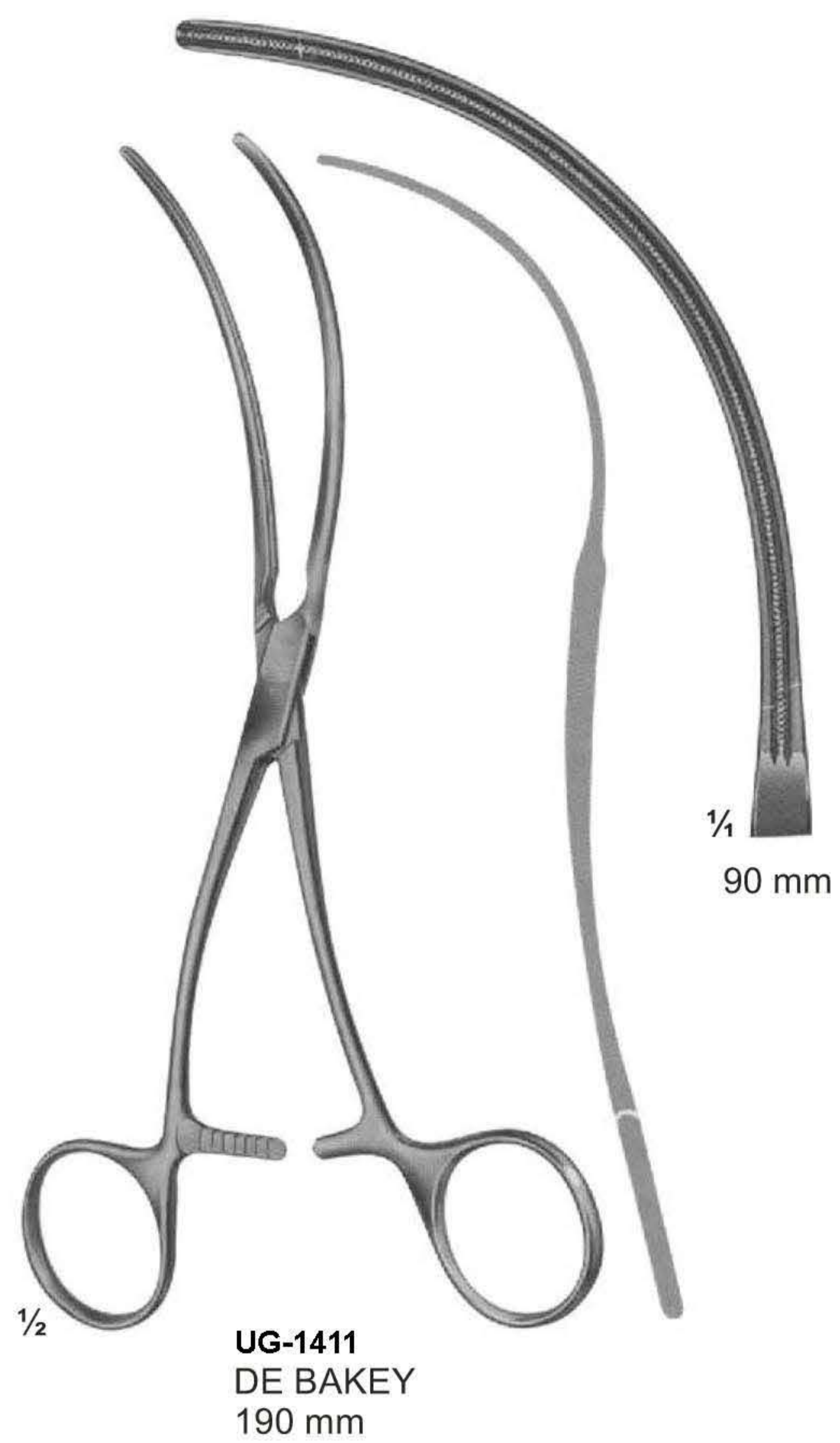

# Vena-Cava Clamps



**UG-1419**  
LELAND-JONES  
195 mm



**UG-1420**  
DE BAKEY  
200 mm

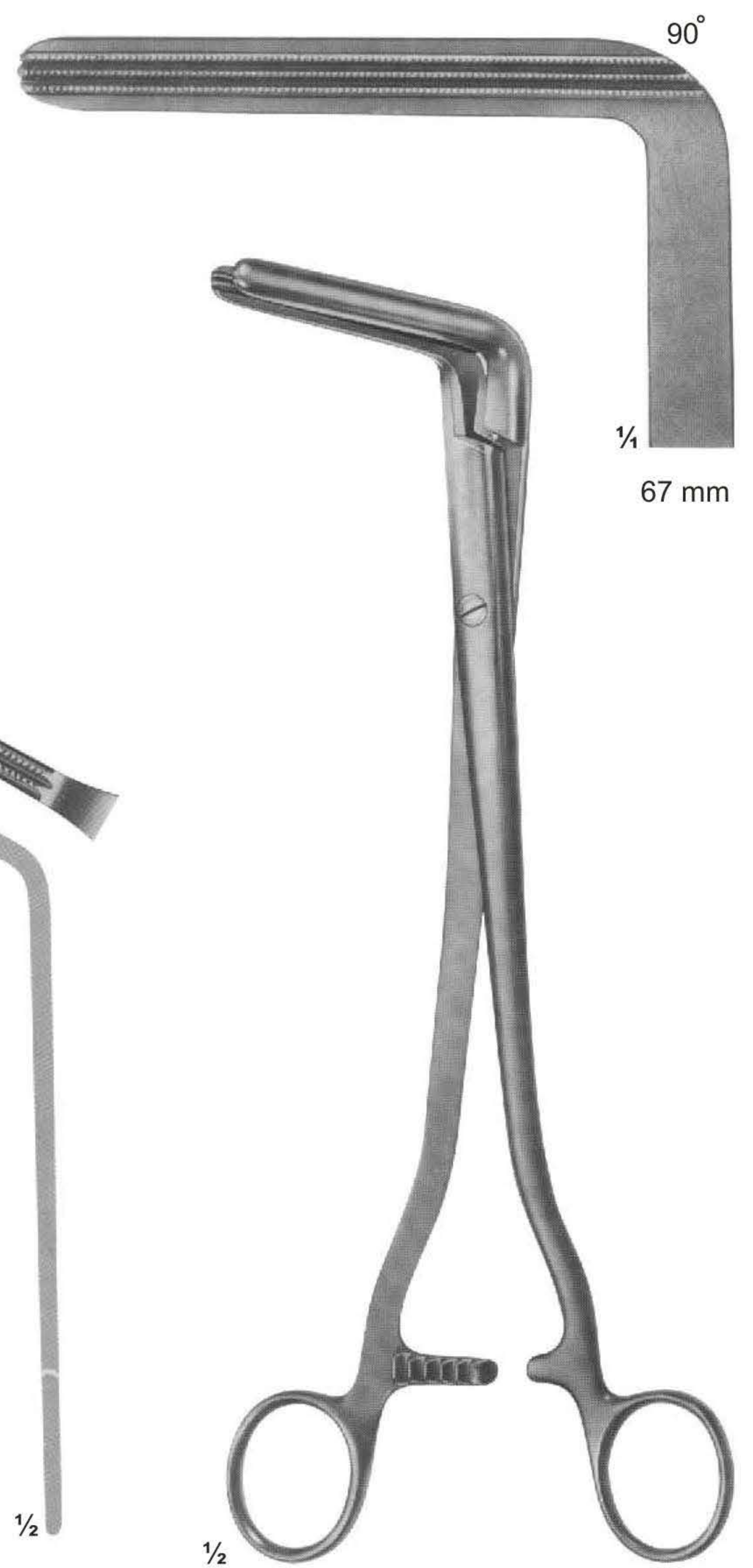

**UG-1421**  
WERTHEIM  
250 mm

# Aorta-Anastomosis Clamps

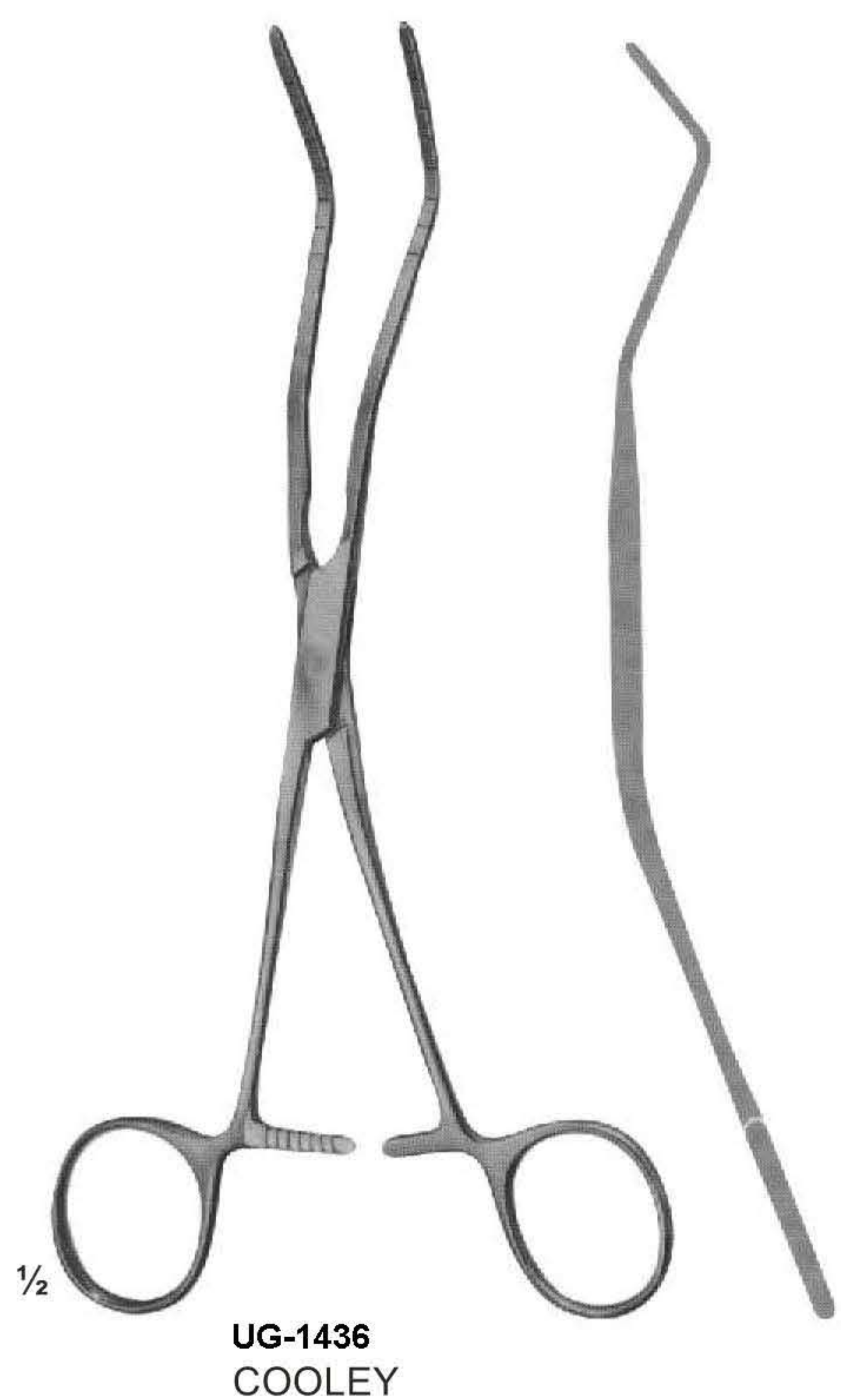

# Aorta-Anastomosis Clamps

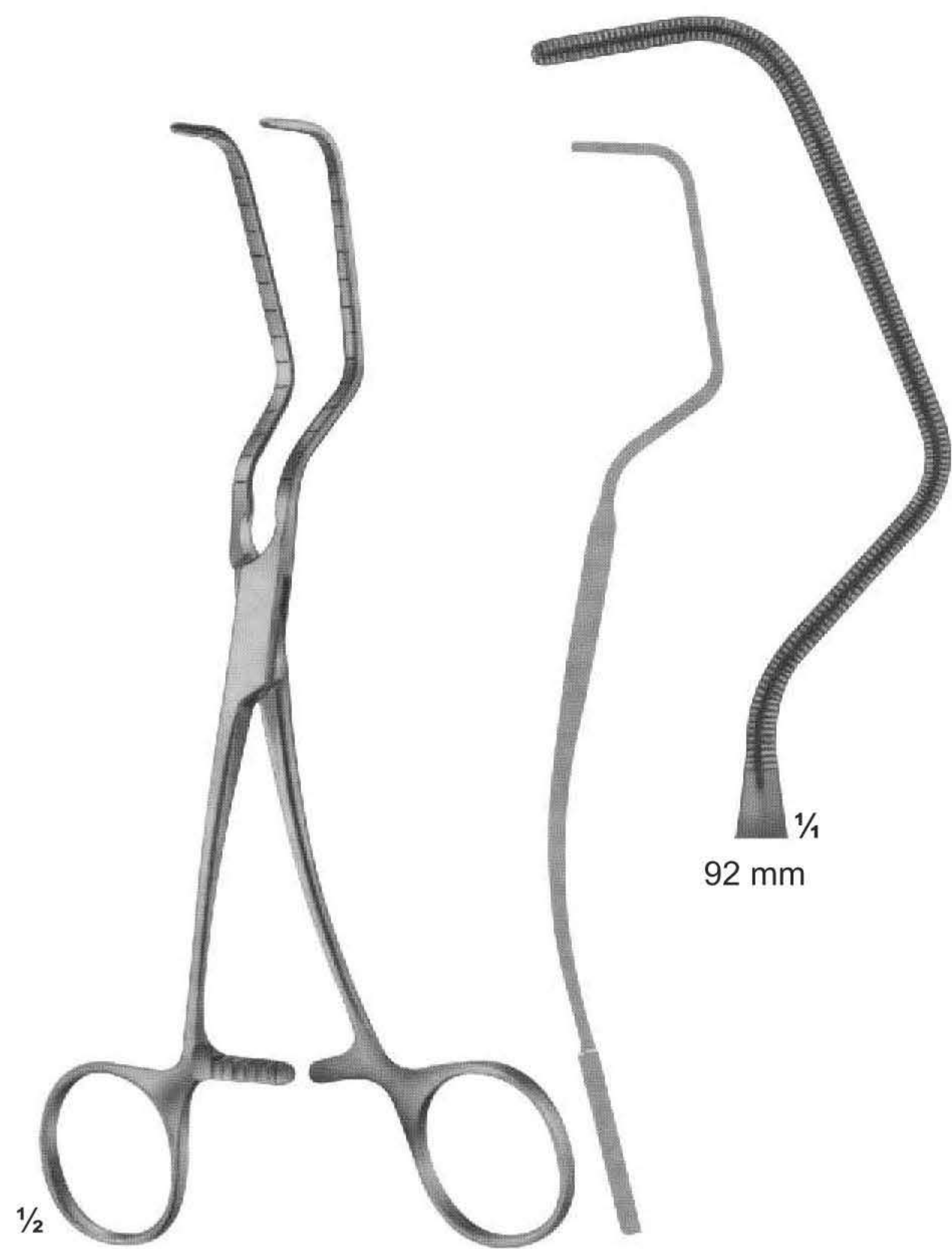

$\frac{1}{2}$   
**UG-1440**  
PARRY-COOLEY  
185 mm

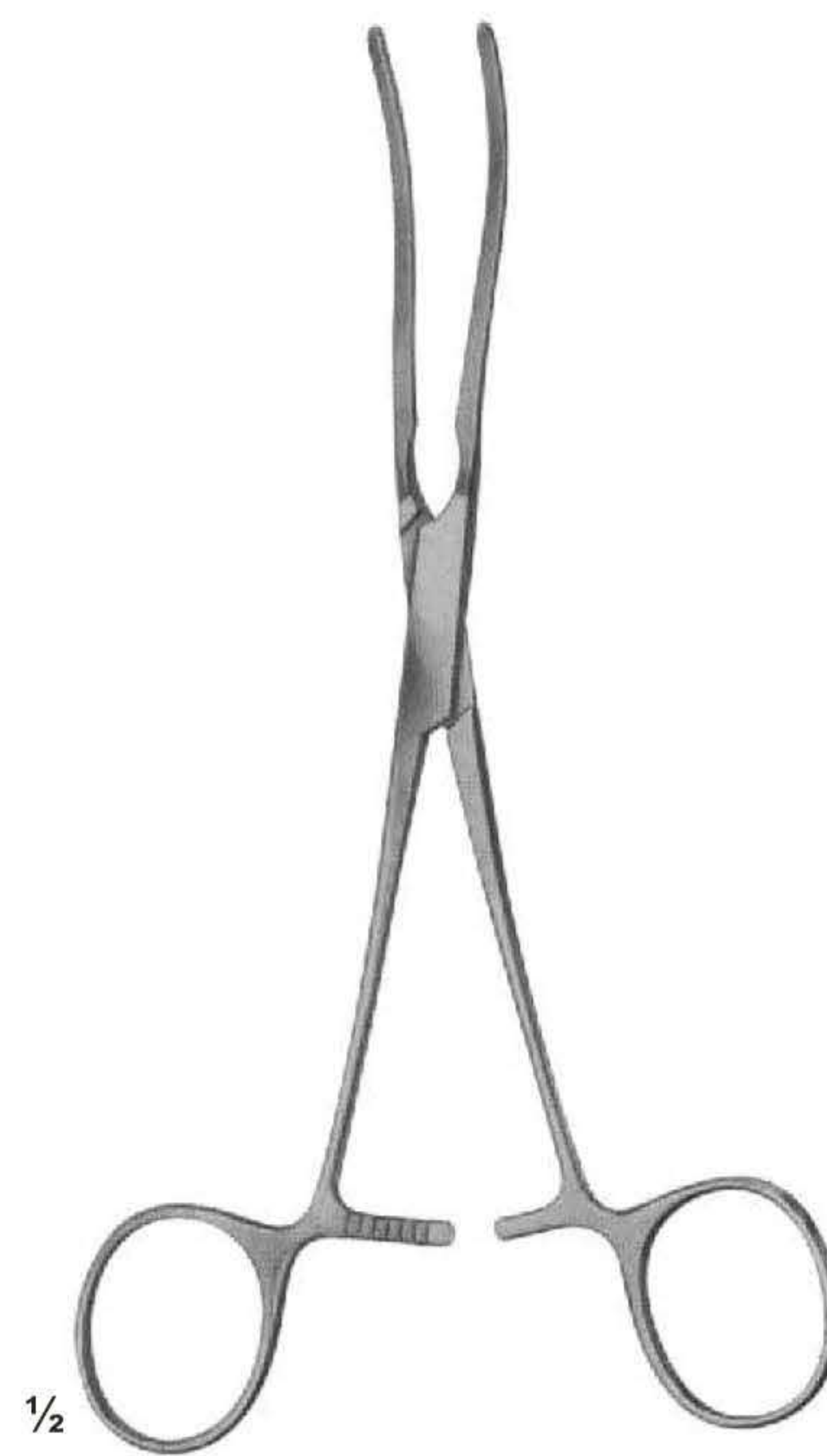

$\frac{1}{2}$   
**UG-1441**  
COOLEY  
160 mm, 170 mm, 180 mm

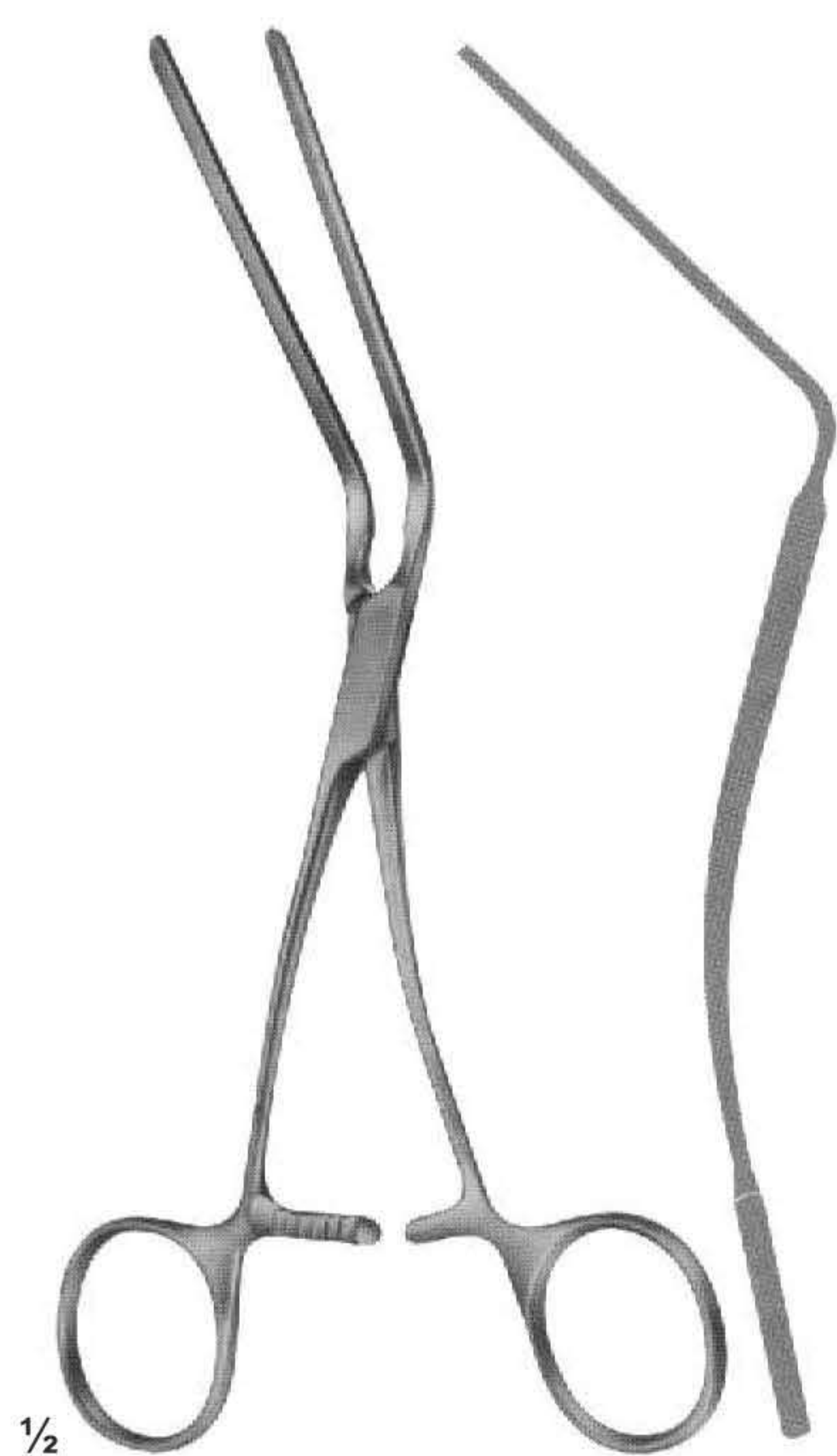

$\frac{1}{2}$   
**UG-1442**

# Multi-Purpose Clamps

---



$\frac{1}{2}$   
UG-1435  
DARDIK

# Multi-Purpose Clamps

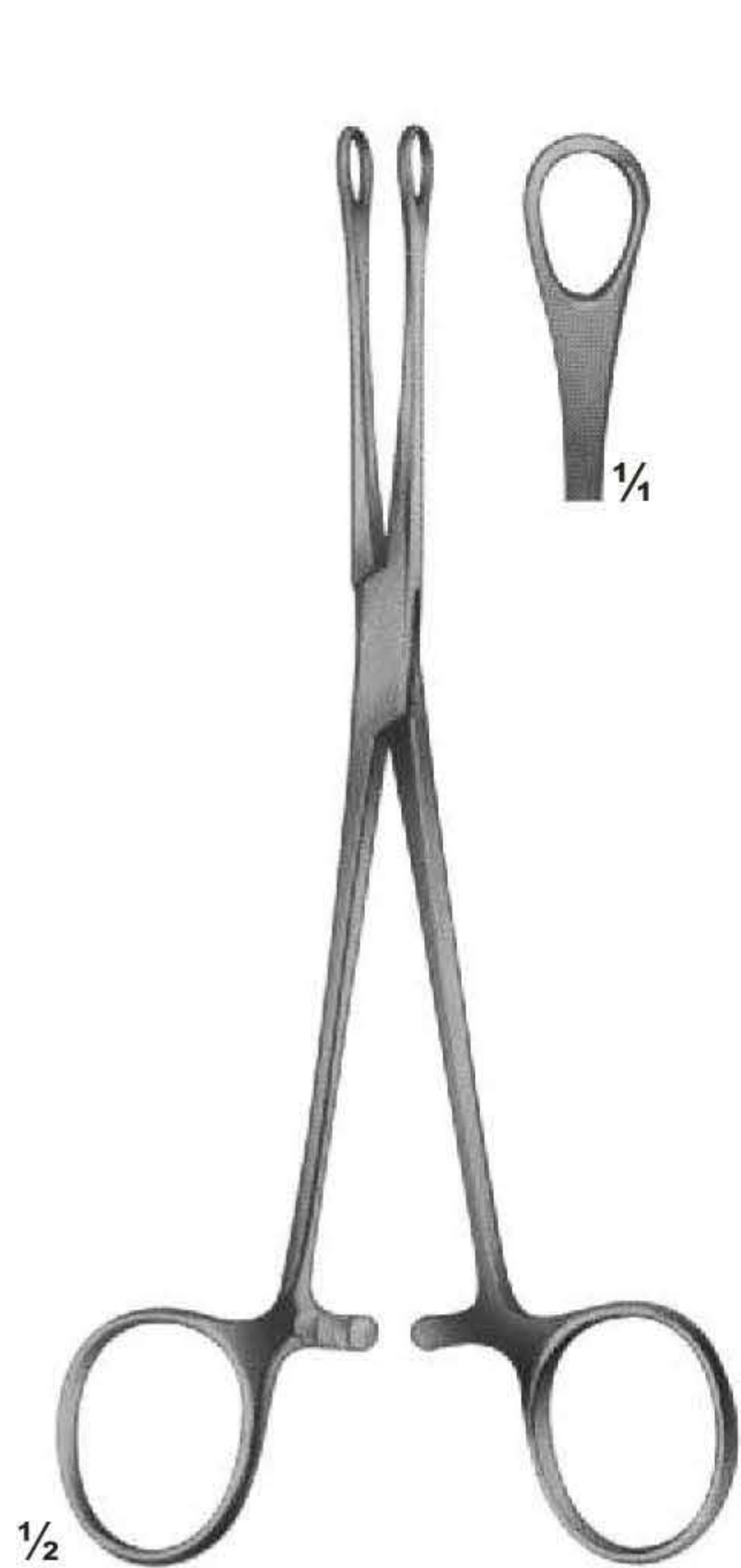

**UG-1434**  
WILLIAMS  
160 mm



**UG-1433**  
TUTTLE  
230 mm



**UG-1432**  
NELSON  
230 mm

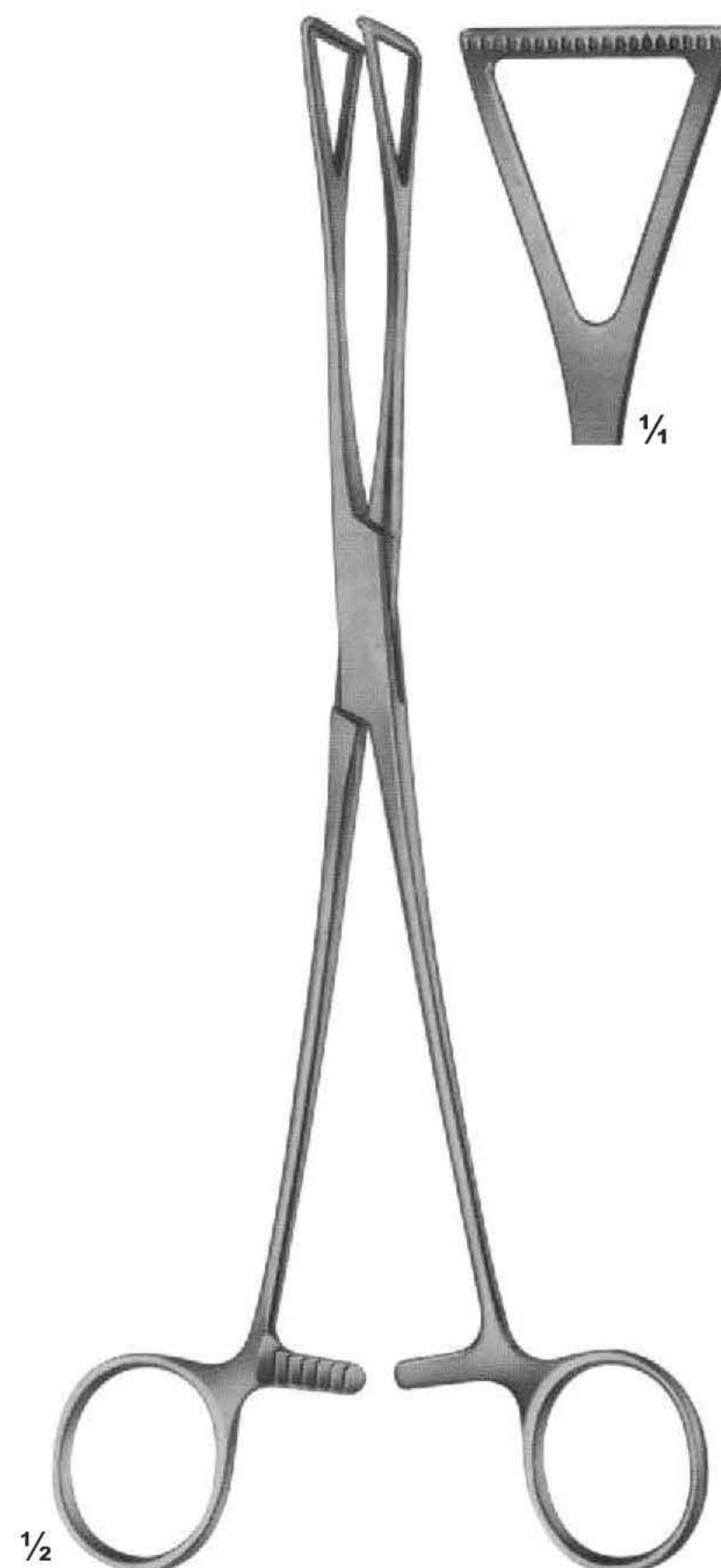

**UG-1431**  
DUVAL  
230 mm

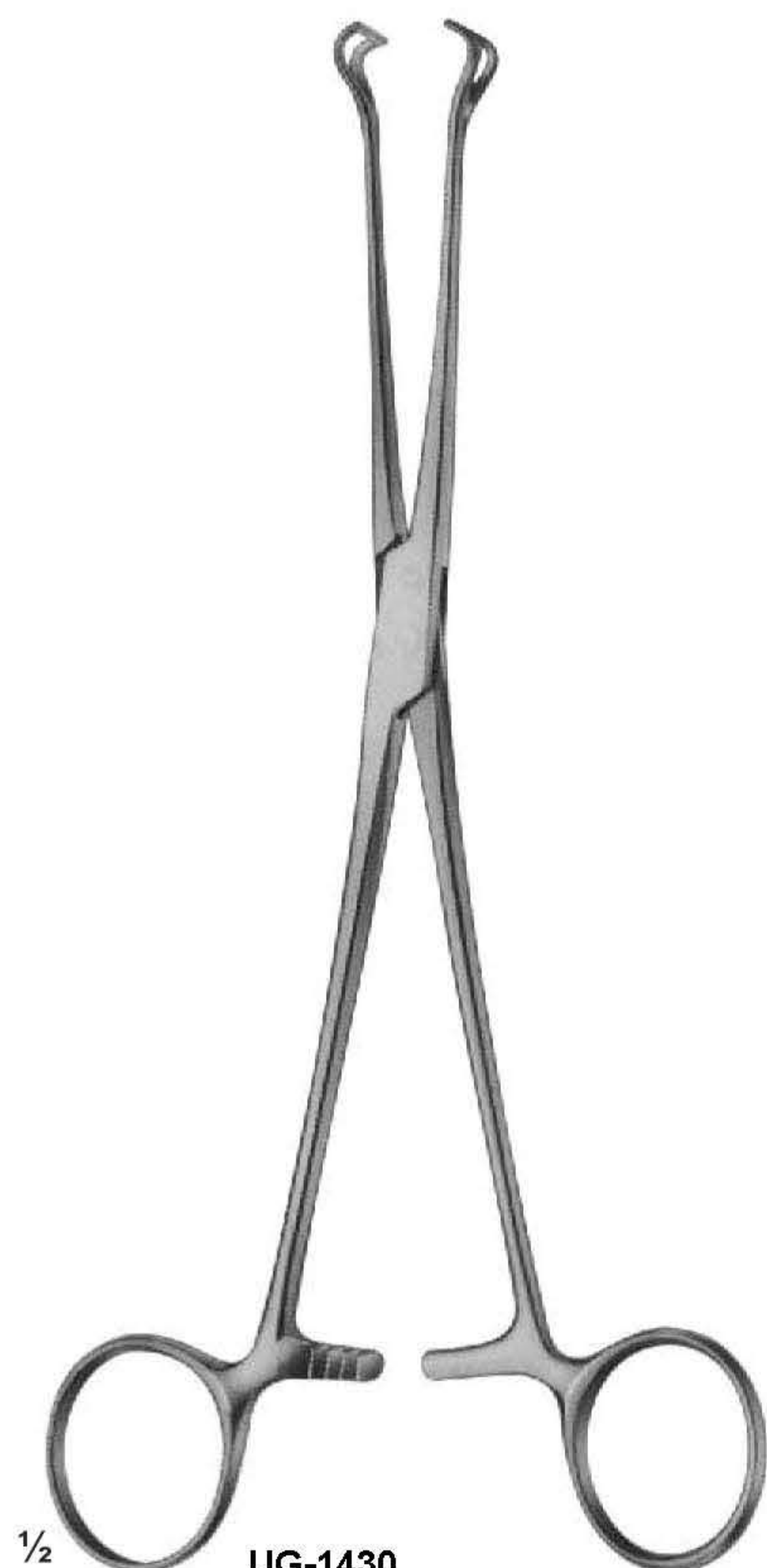

**UG-1430**  
BABCOCK



**UG-1429**  
ALLIS  
220 mm

# Multi-Purpose Clamps

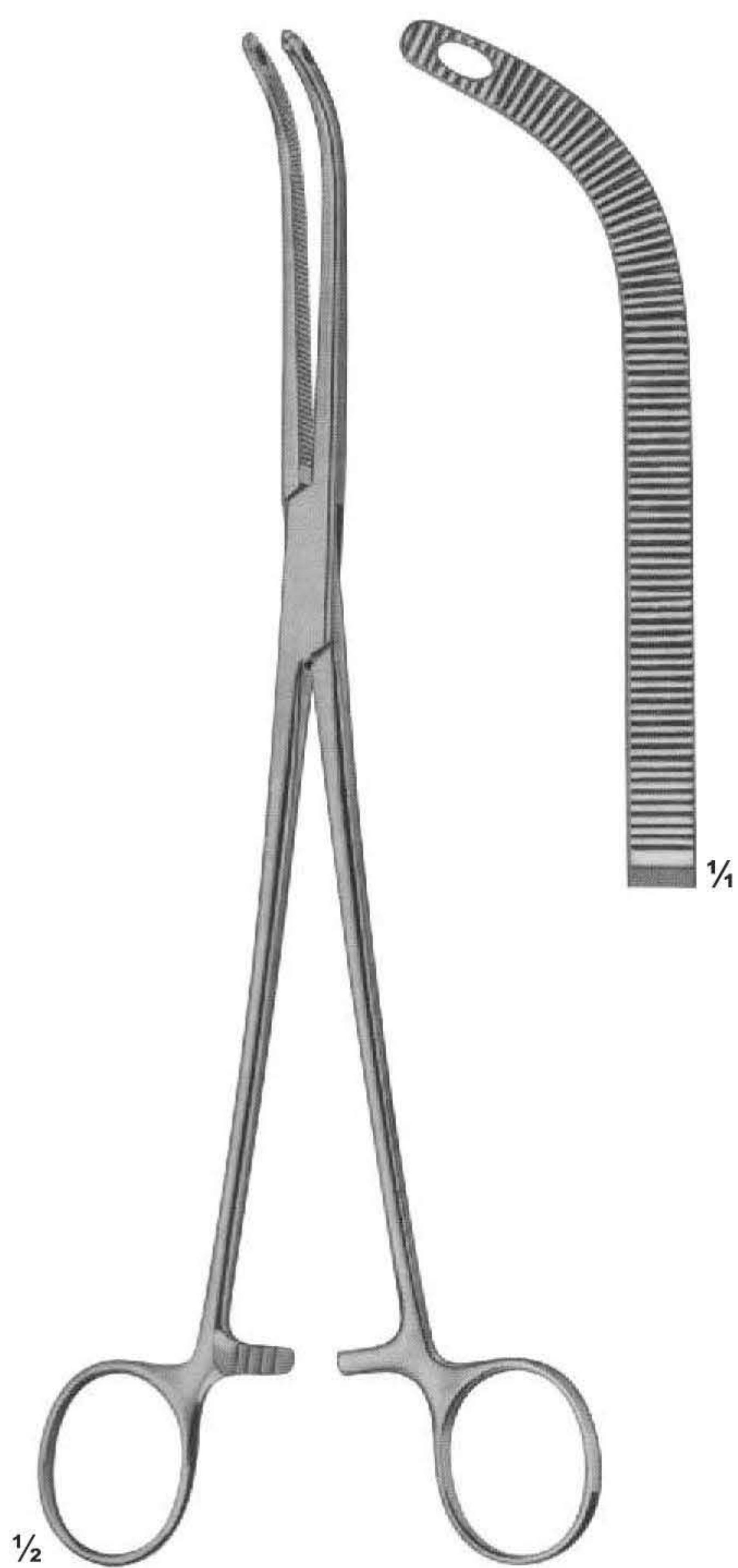

**UG-1425**  
FINOCHIETTO  
245 mm



**UG-1426**  
SEMB  
244 mm

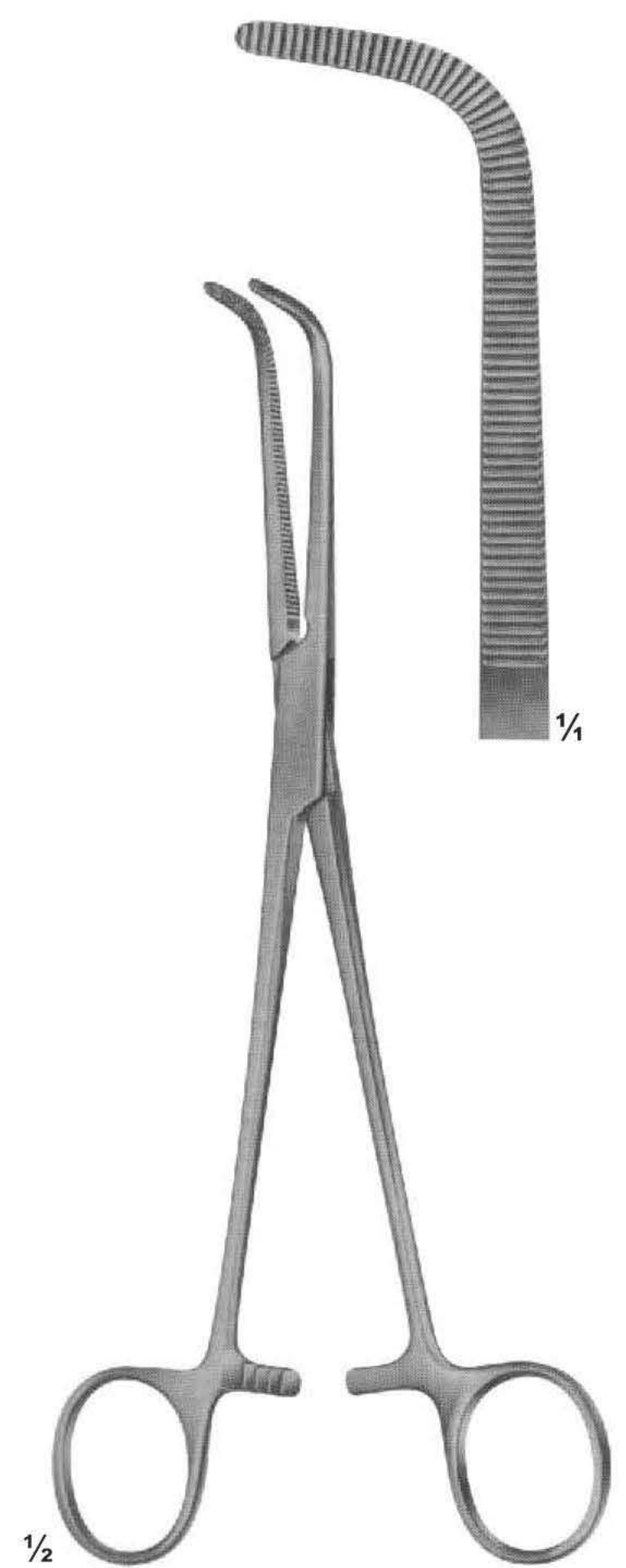

**UG-1425**  
WIKSTROEM  
205 mm



# Multi-Purpose Clamps

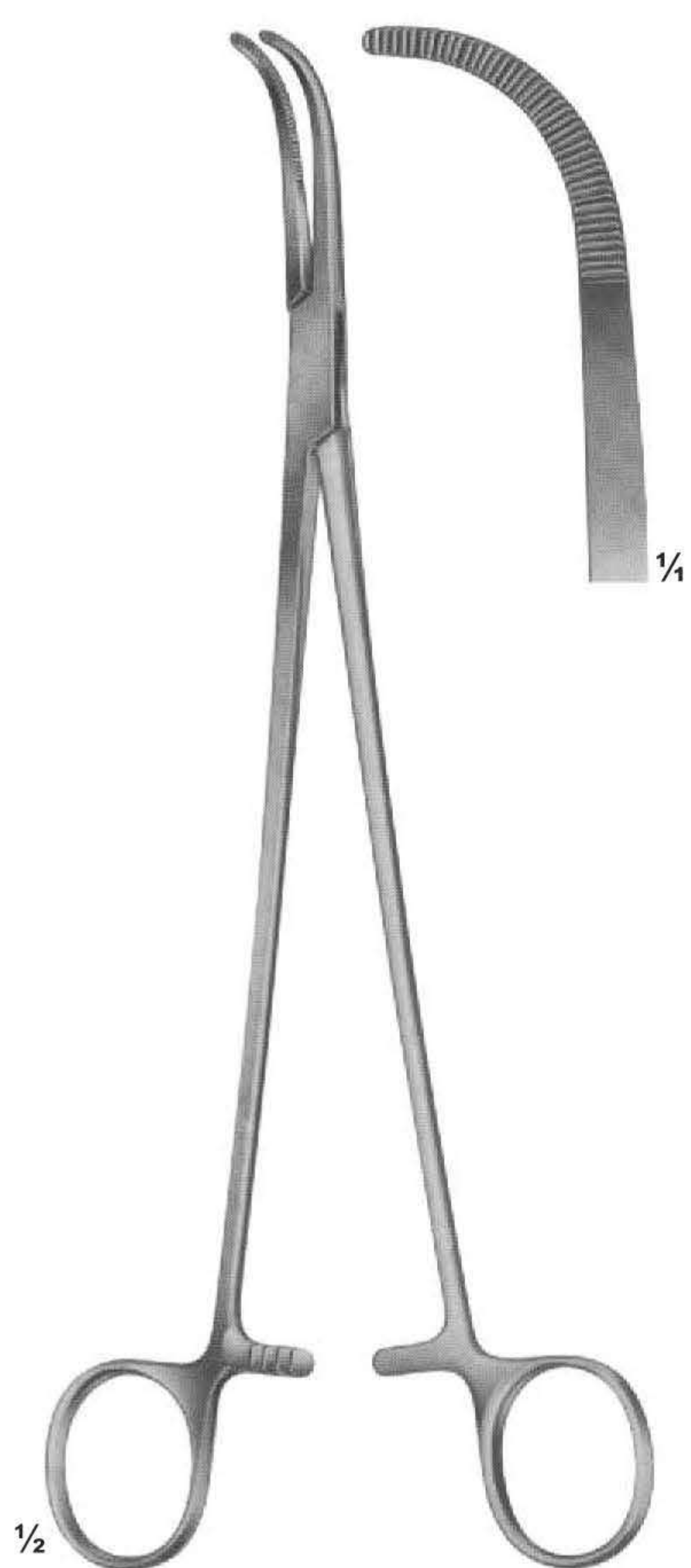

**UG-1424**  
MIXTER  
230 mm



**UG-1423**  
MIXTER

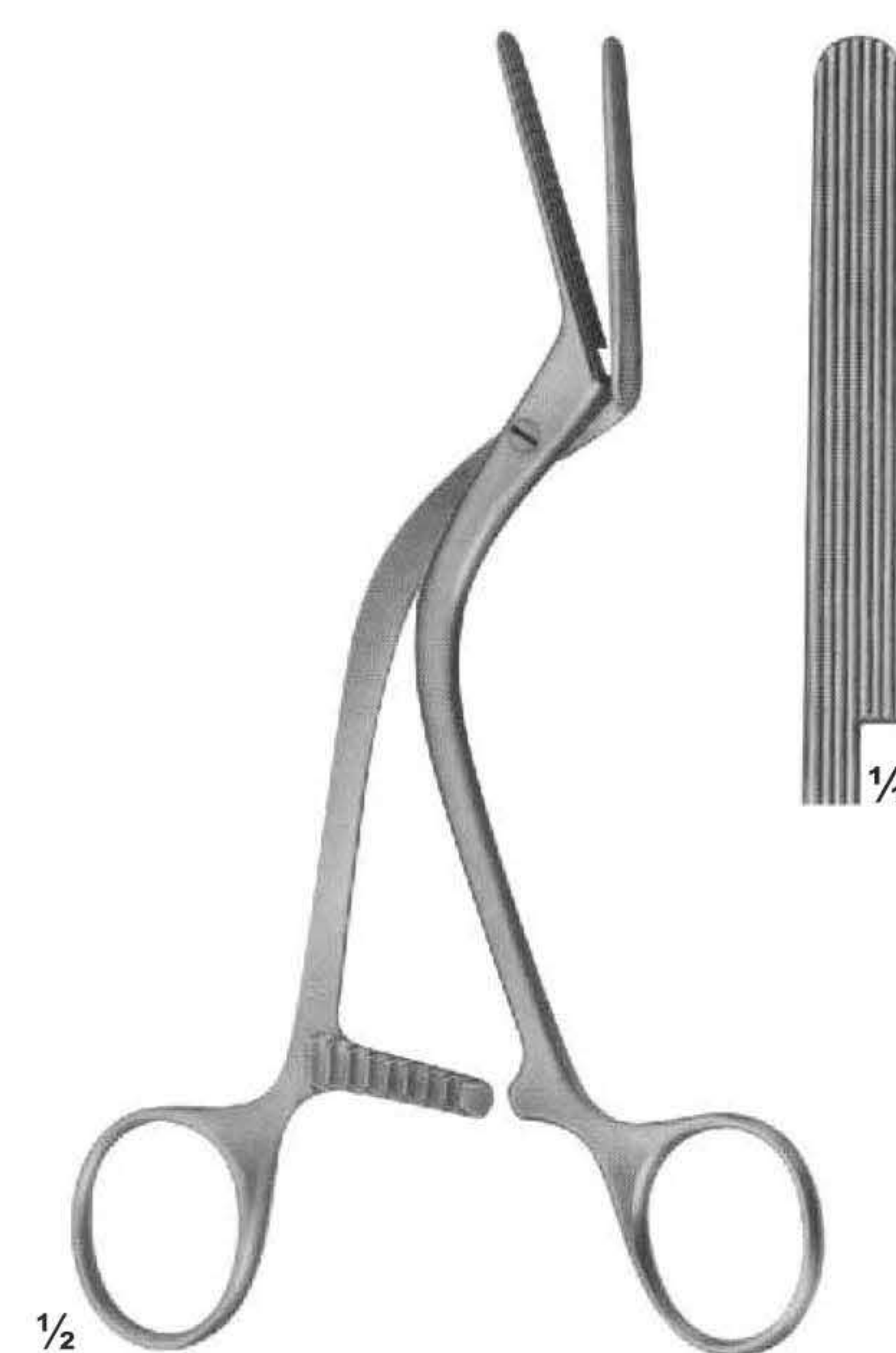

**UG-1422**  
HOPFNER  
160 mm

# Multi-Purpose Clamps

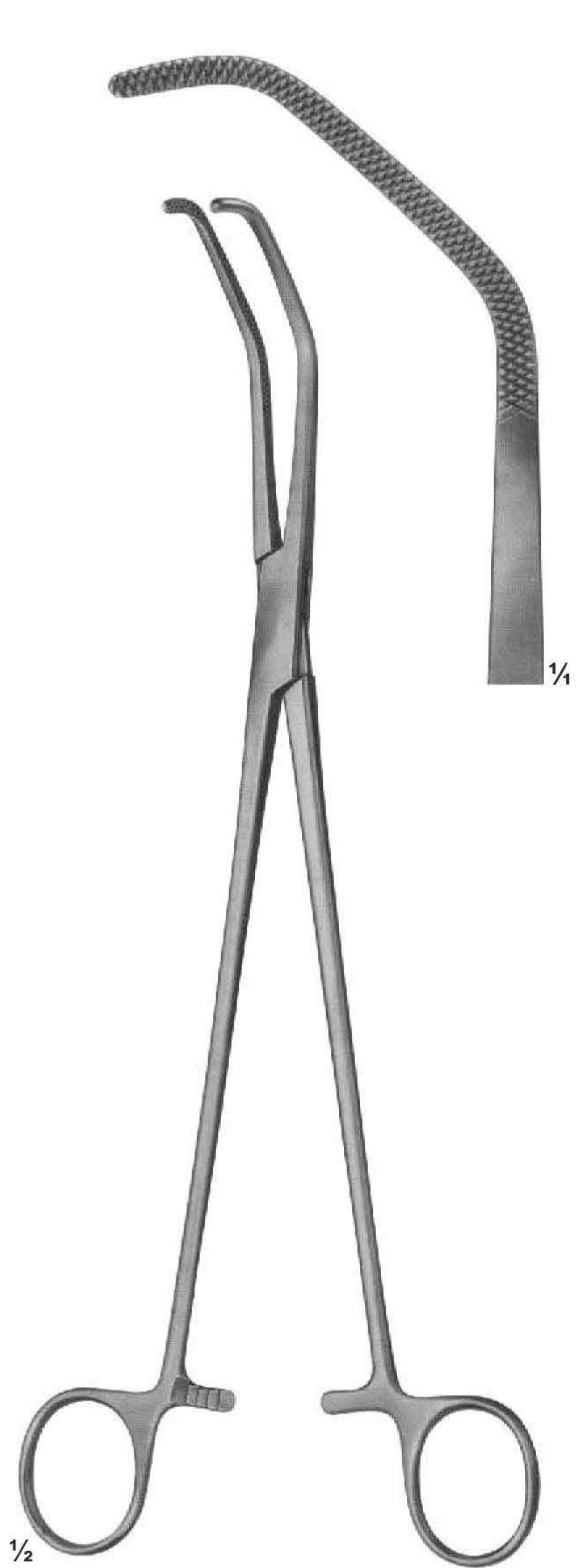

**UG-1418**  
SATINSKY  
265 mm



**UG-1417**  
SATINSKY  
265 mm

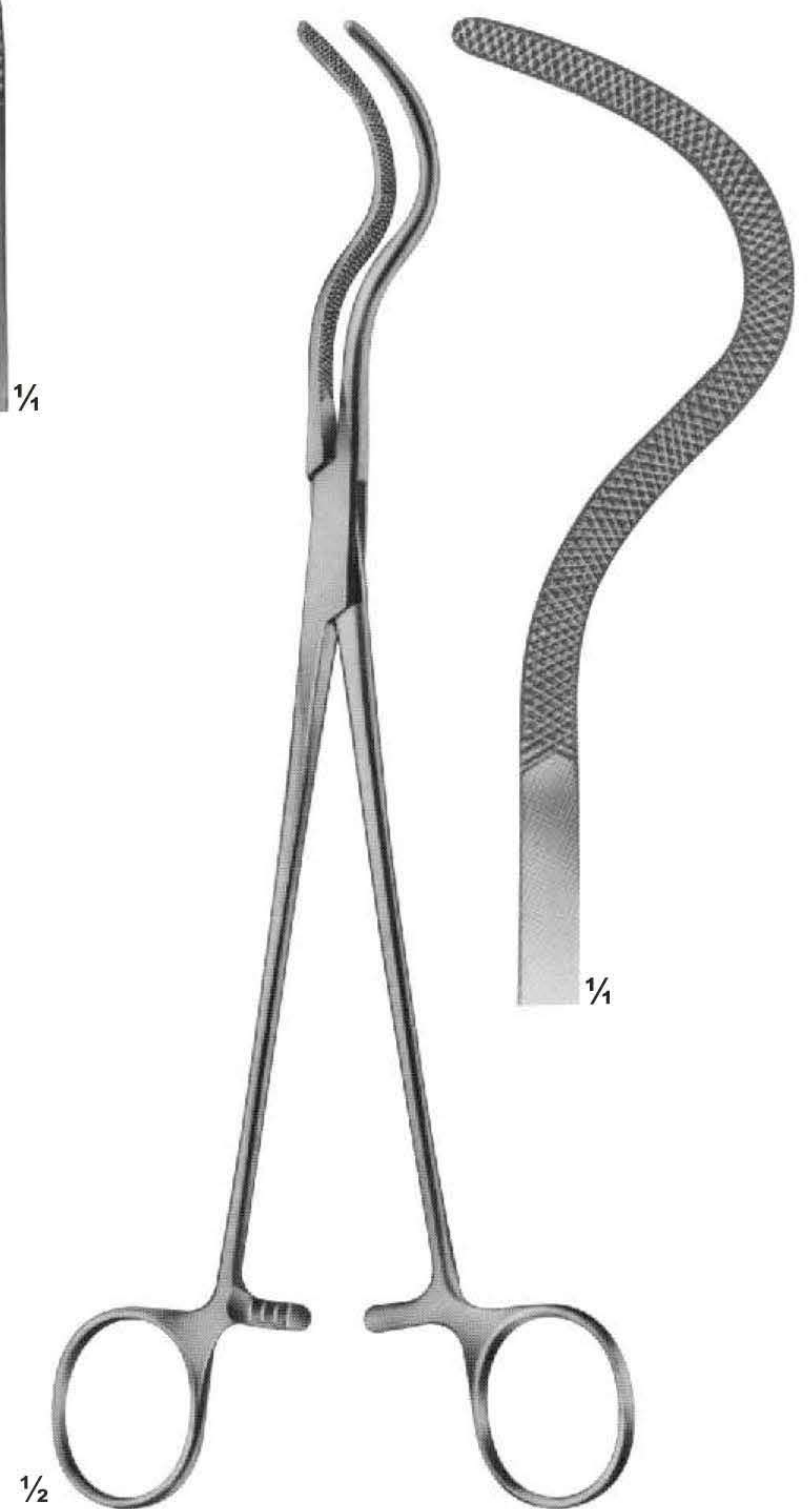

**UG-1415**  
HARKEN  
240 mm

# Multi-Purpose Clamps



**UG-1412**  
PERTUISET  
Carotid Clamp  
90 mm

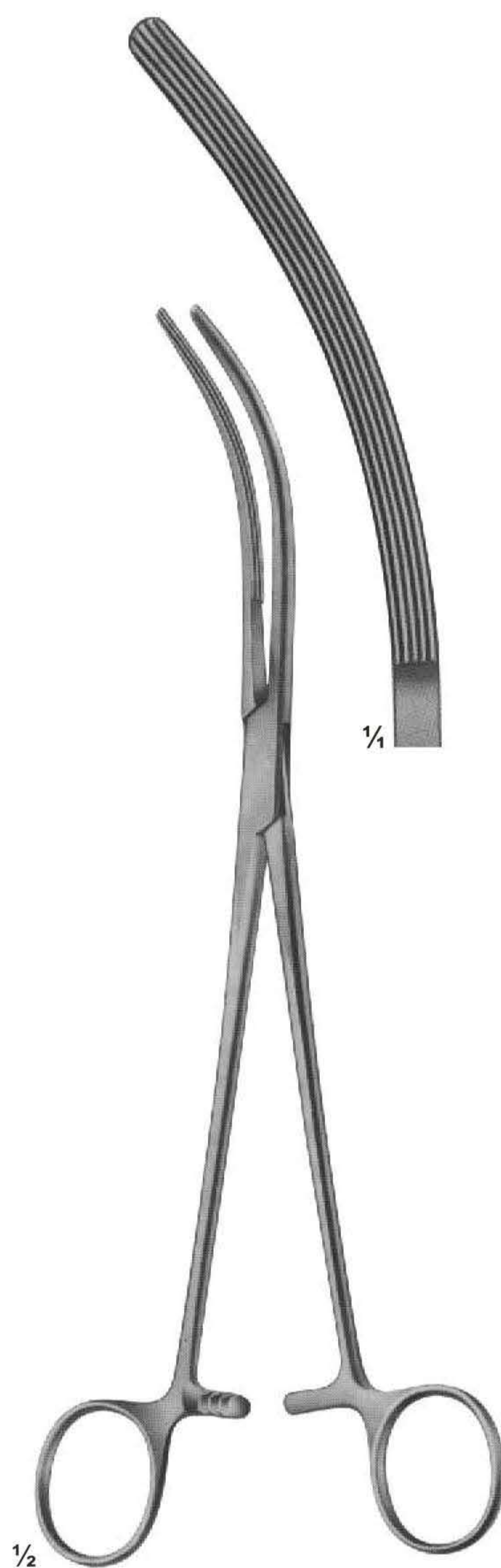

**UG-1410**  
CRAFOORD-SELLORS  
240 mm



**UG-1406**  
CRAFOORD  
240 mm

## Multi-Purpose Clamps

---



**UG-1403**  
PRICE THOMAS  
225 mm

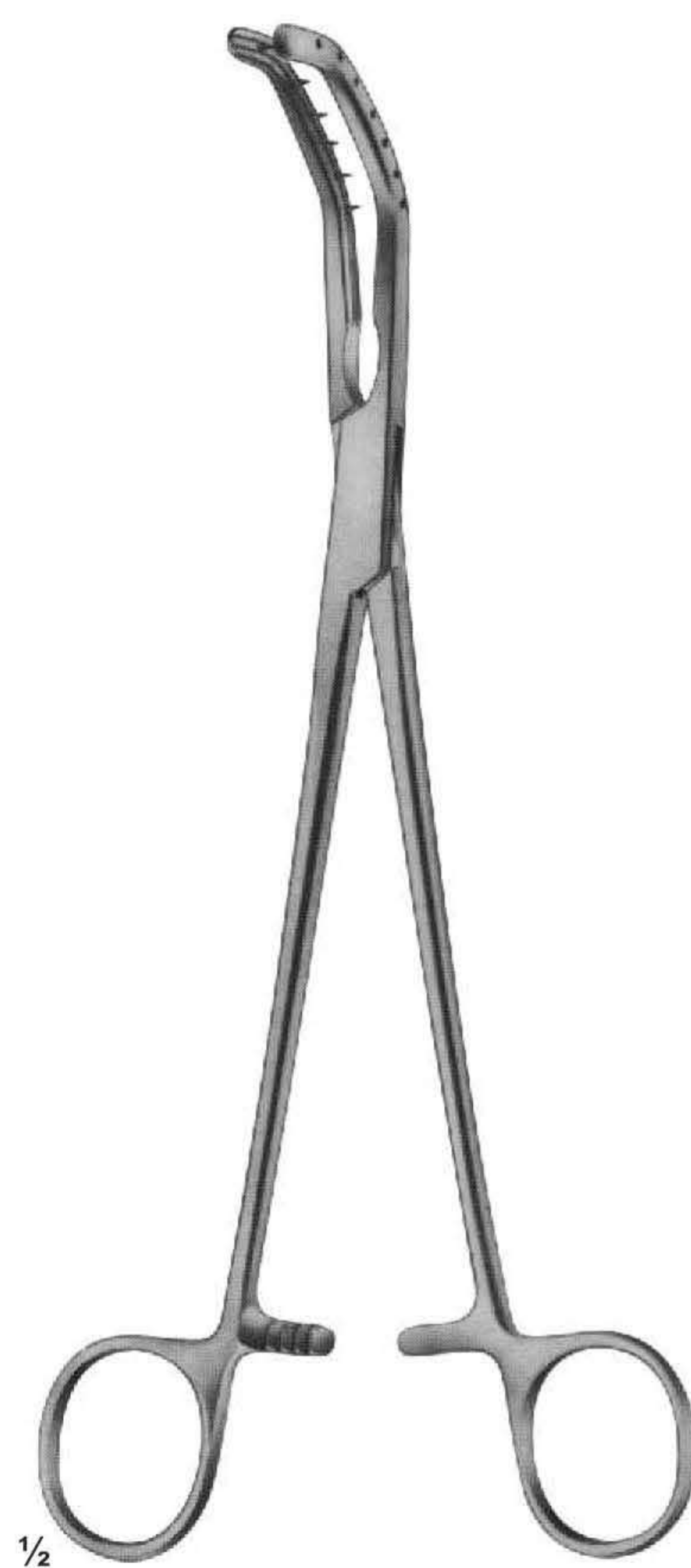

**UG-1404**  
PRICE THOMAS  
225 mm

# Rib Shears



**UG-1402**  
SCHUMACHER  
Sternum shears  
210 mm



**UG-1401**  
LEBSCHKE  
Sternum chisel  
200 mm



**UG-1399**  
COLLIN  
195 mm

**UG-1400**  
230 mm



**UG-1397**  
GLUCK  
190 mm



**UG-1396**  
BRUNNER  
Universal Pattern  
340 mm



**UG-1395**  
GIERTZ-STILLE  
250 mm

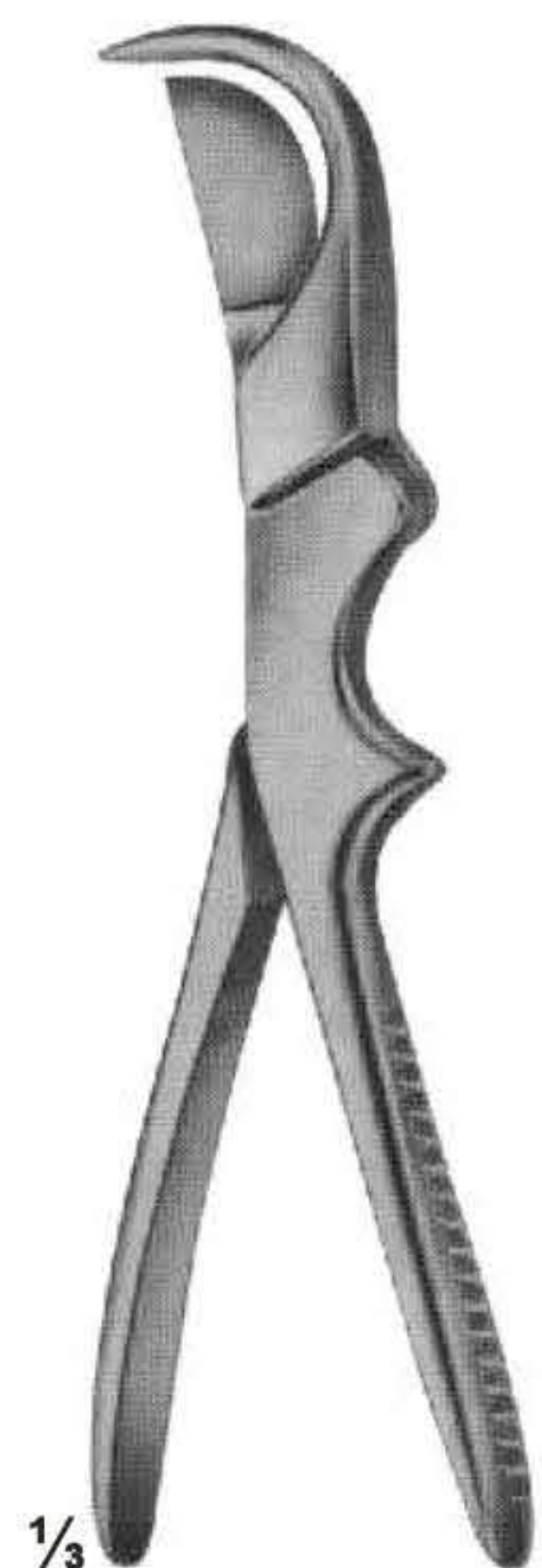

**UG-1398**  
GLUCK  
190 mm

# Rib Holding Forceps, Bone Cutting Forceps



**UG-1394**  
SEMB  
Rib-and Bone  
Holding forceps  
190 mm



**UG-1393**  
SEMB  
Rib-and Bone  
Holding forceps  
190 mm

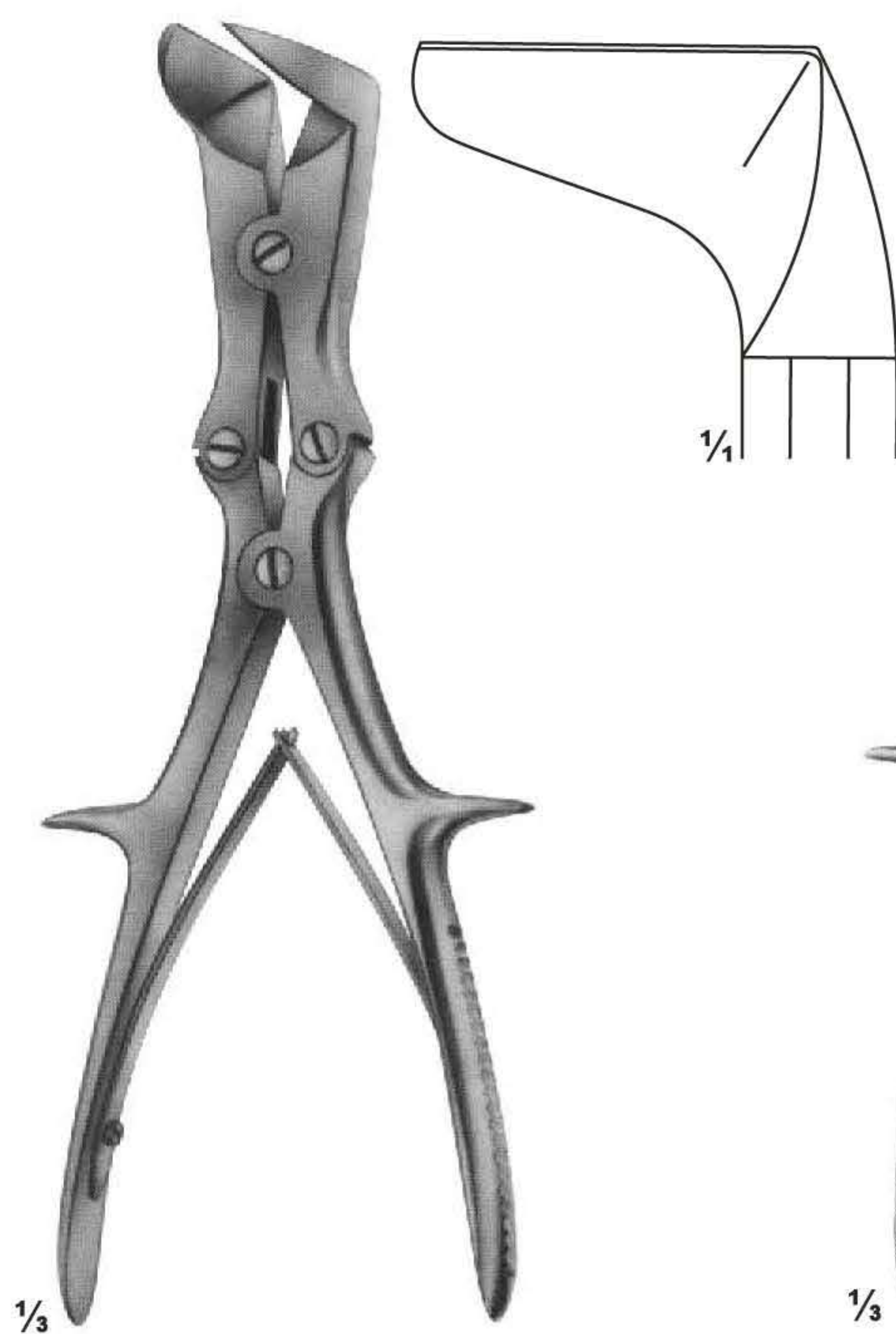

**UG-1391**  
LISTON-STILLE  
265 mm

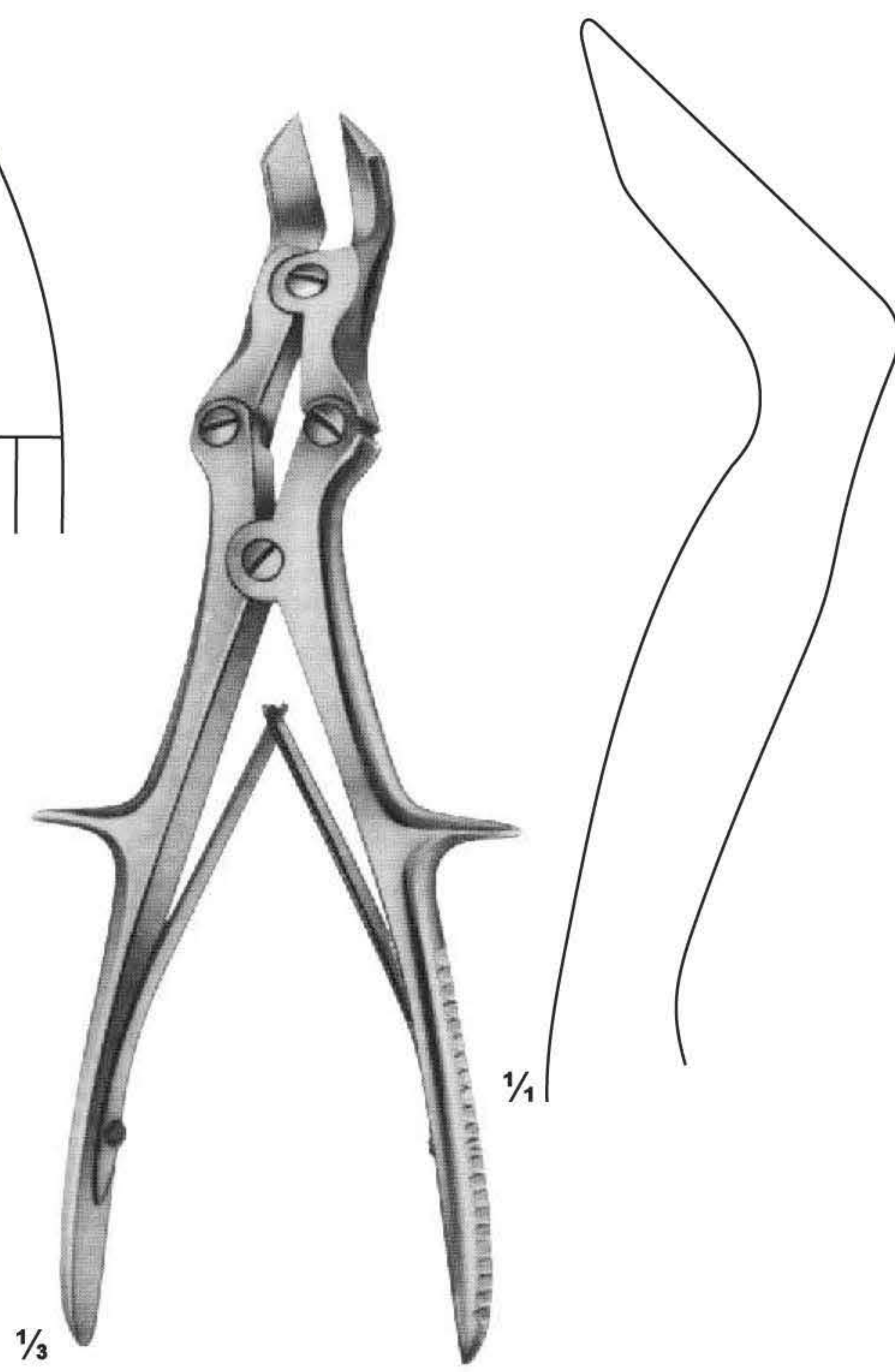

**UG-1390**  
LISTON-KEY-HORSLEY  
255 mm

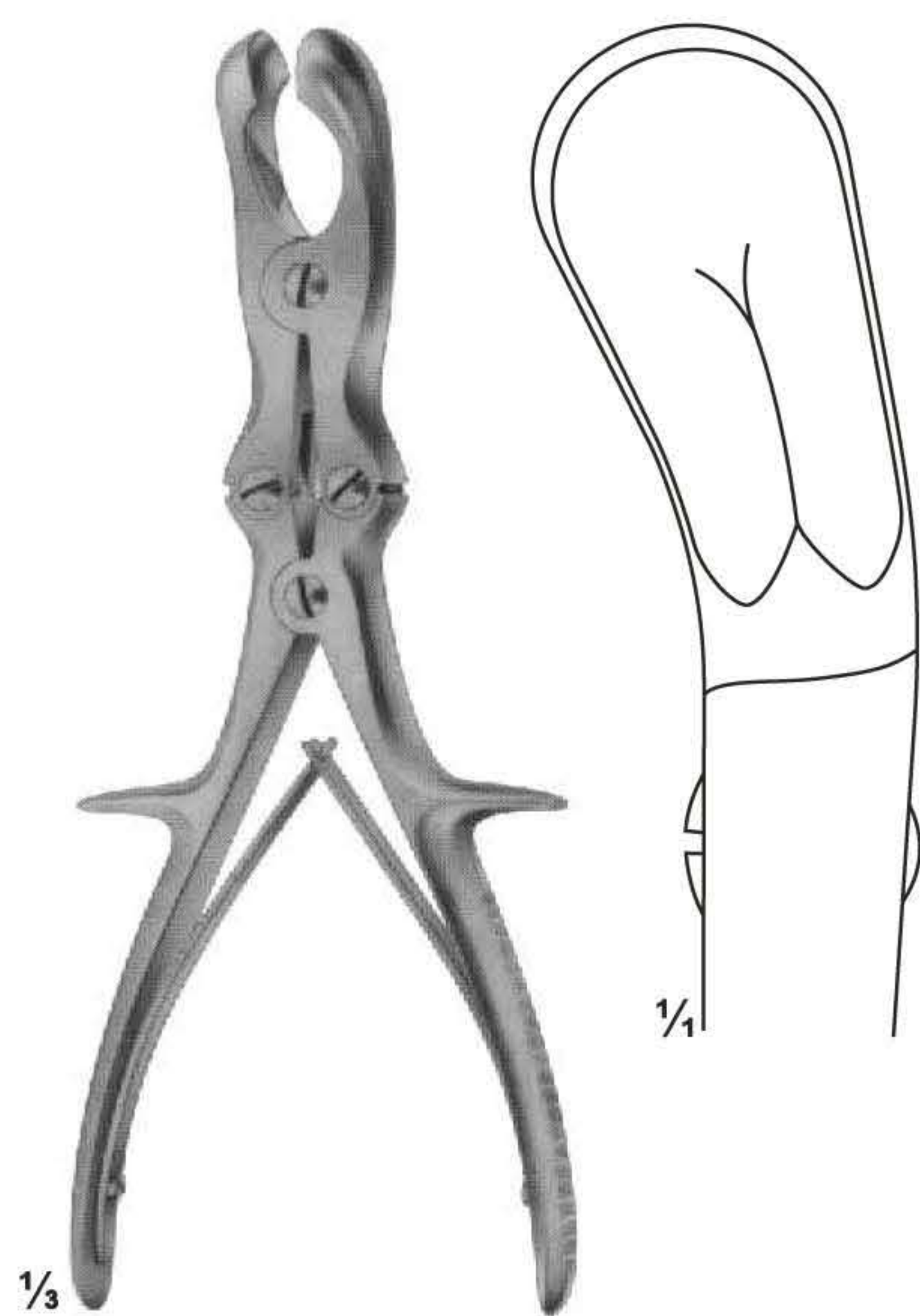

**UG-1389**  
SEME  
Rib Rongeur to shorten  
the rib stumps  
240 mm



**UG-1387**  
SAUERDRUCH-CORYLLOS  
Rib rongeurs to shortn  
the rib stumbes  
310 mm

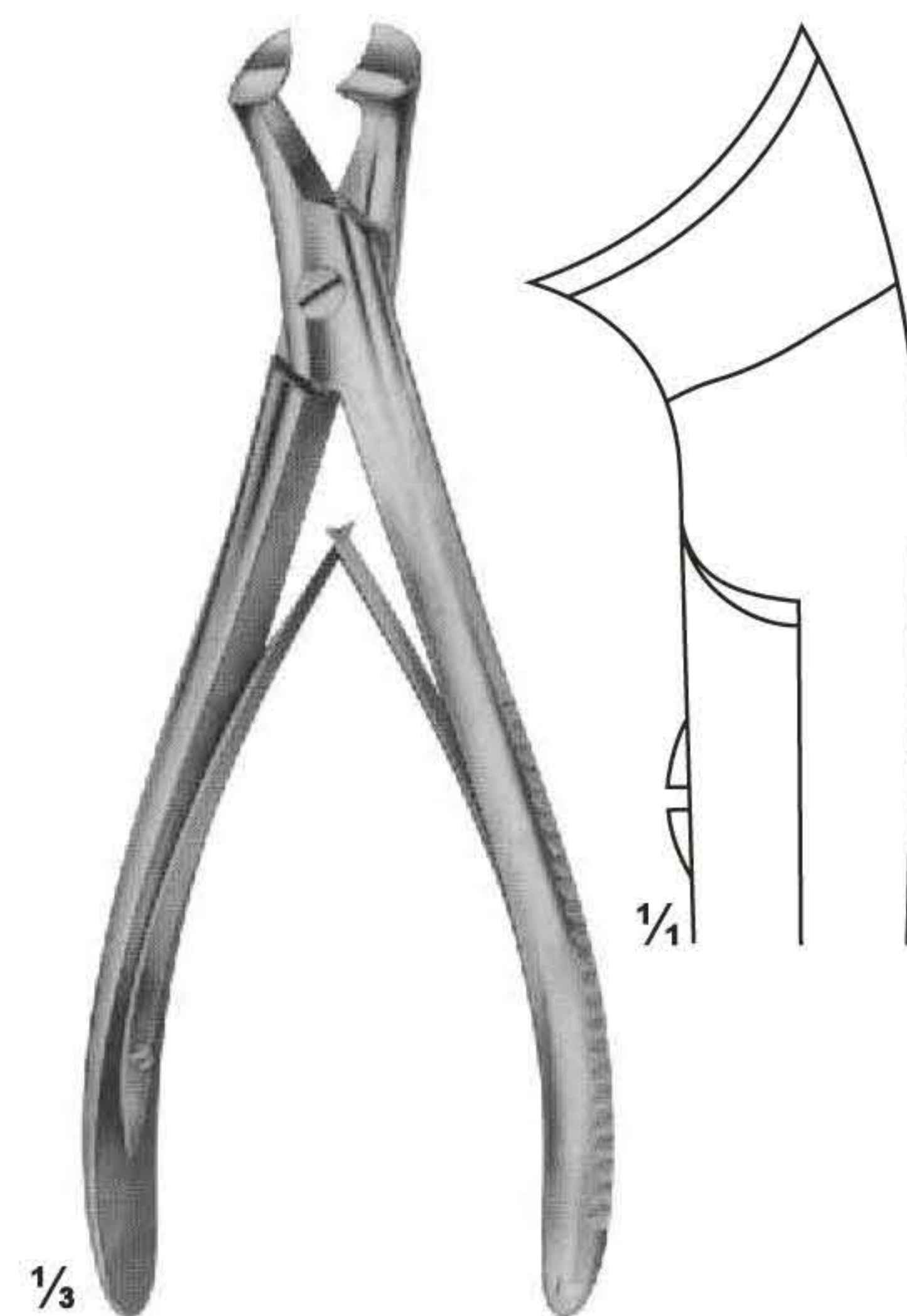

**UG-1385**  
MARKWALDER  
Rib Rongeur to Round  
the rib stumps  
190 mm

# Rib Raspatories



**UG-1383**  
DOYEN  
for children  
175 mm



**UG-1382**  
DOYEN  
for adults  
175 mm

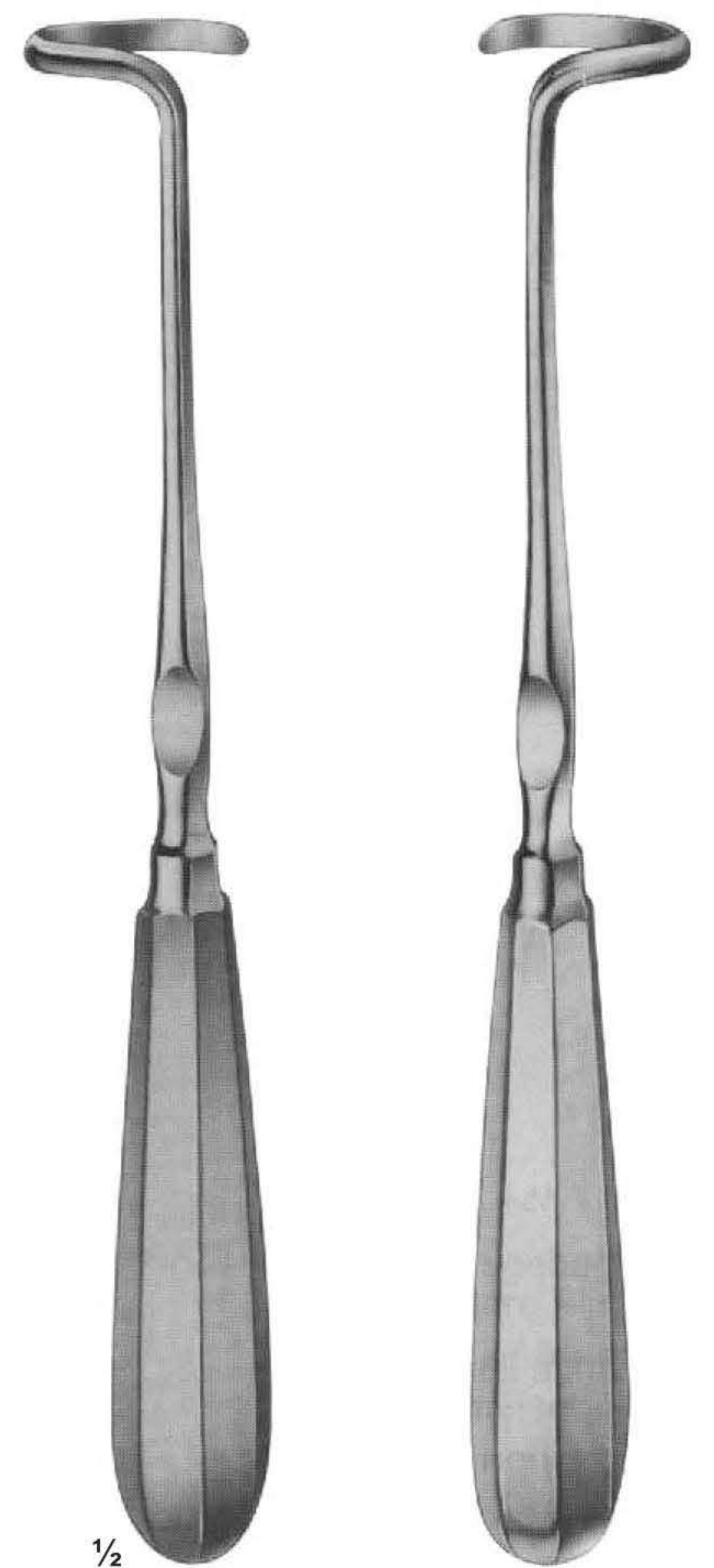

**UG-1380**  
DOYEN  
240 mm

# Rib Raspatories



1/2  
**UG-1378**  
 SEMB  
 230 mm

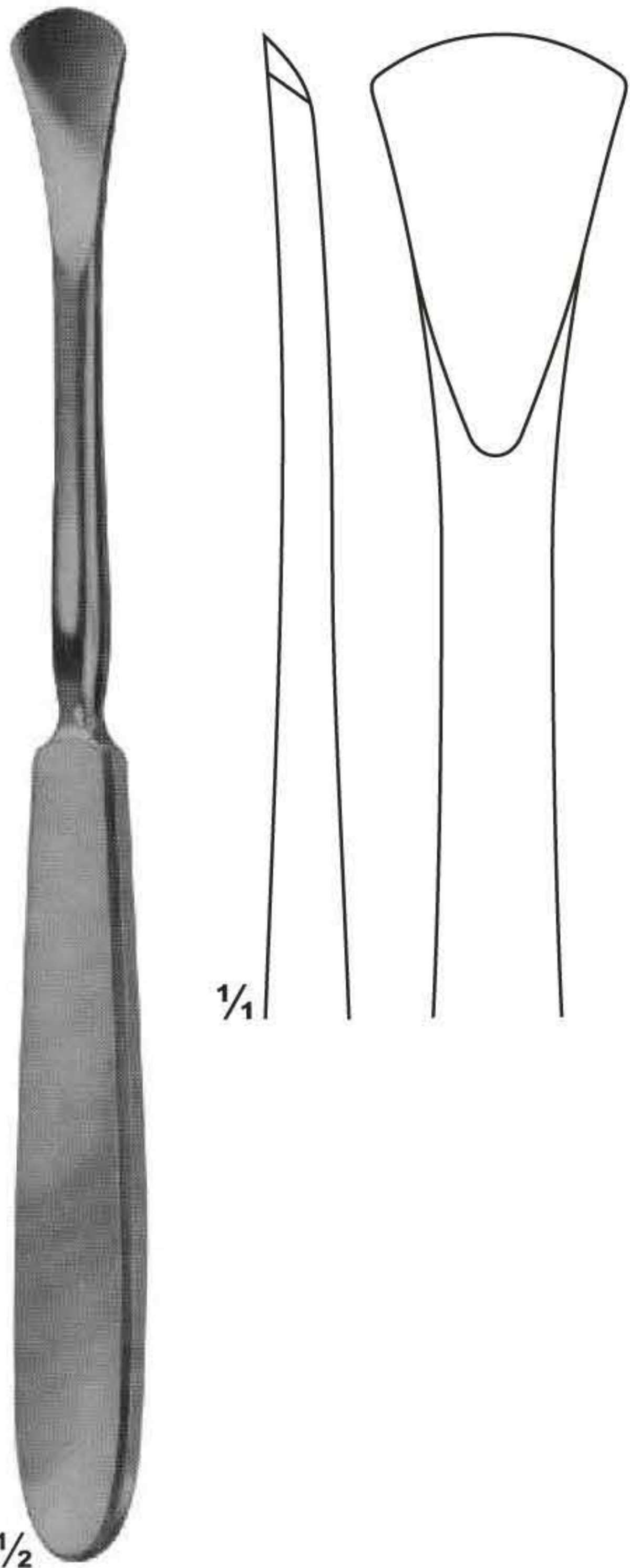

1/2  
**UG-1376**  
 LANGENBECK  
 190 mm

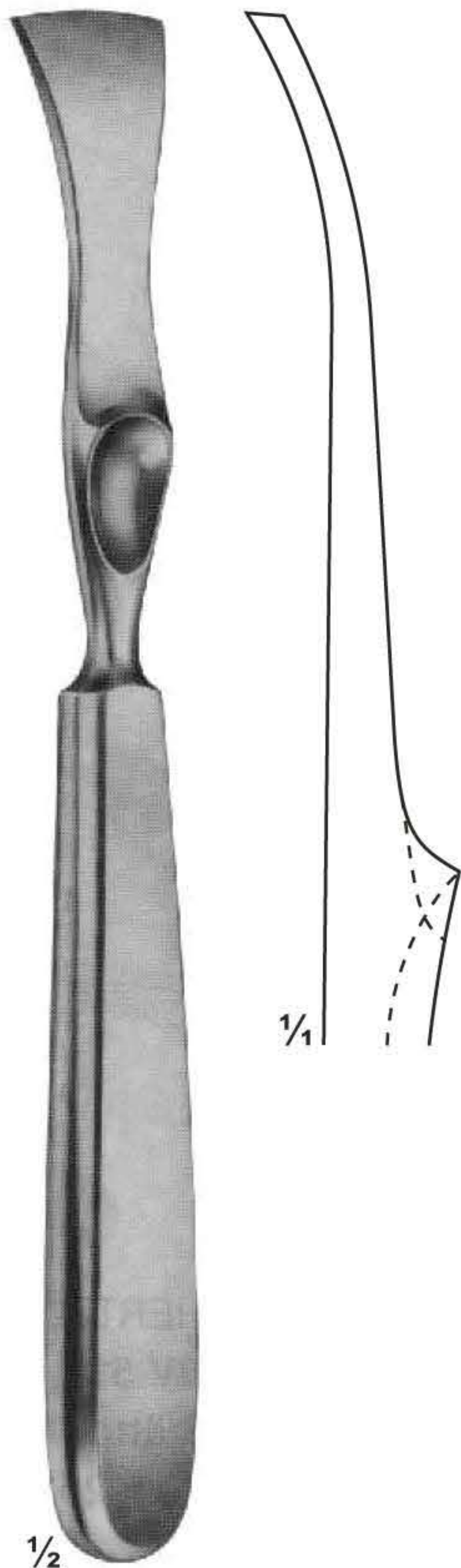

1/2  
**UG-1372**  
 LAMBOTTE  
 215 mm

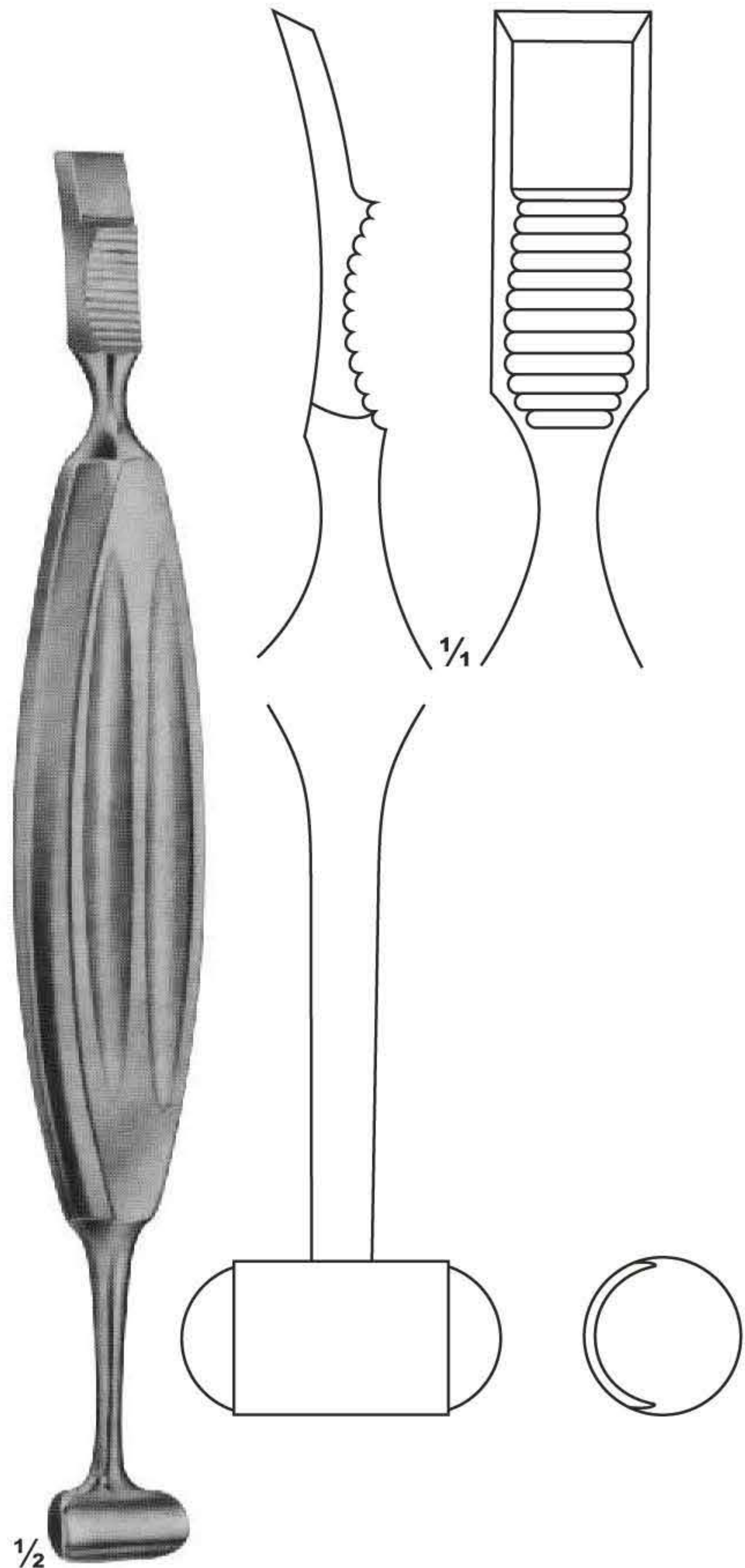

1/2  
**UG-1370**  
 ALEXANDER  
 210 mm



# Rib Spreaders

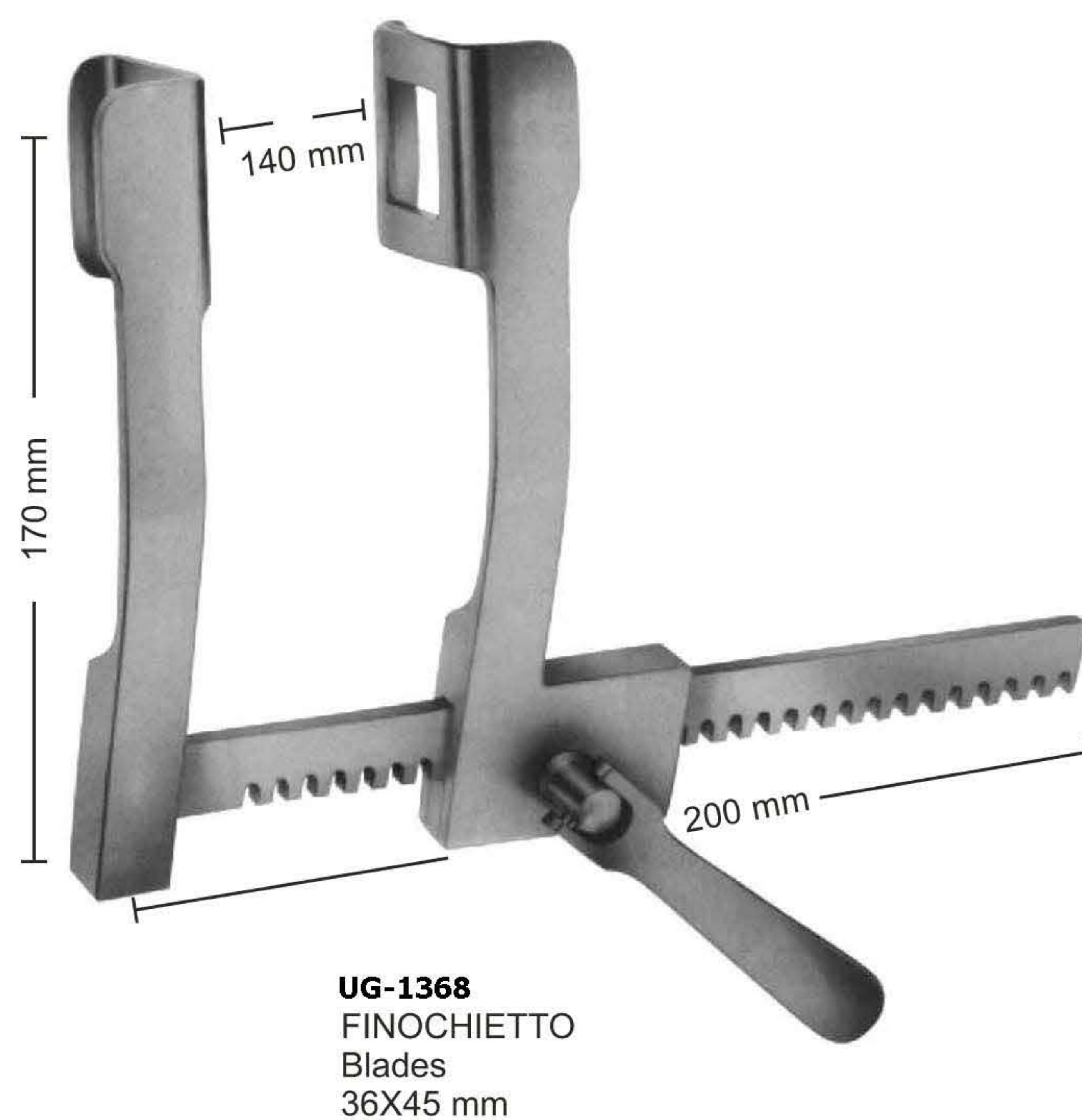
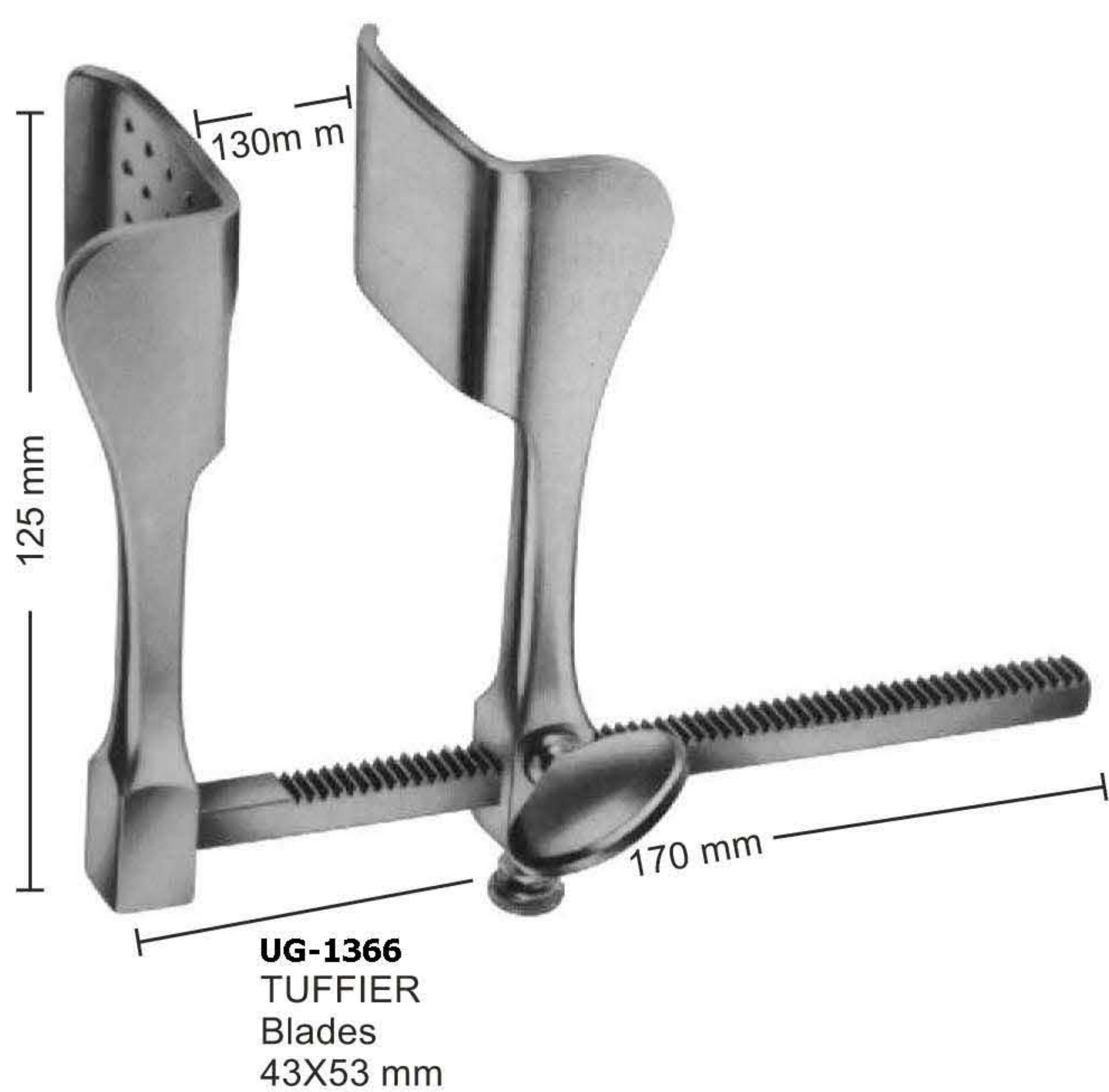
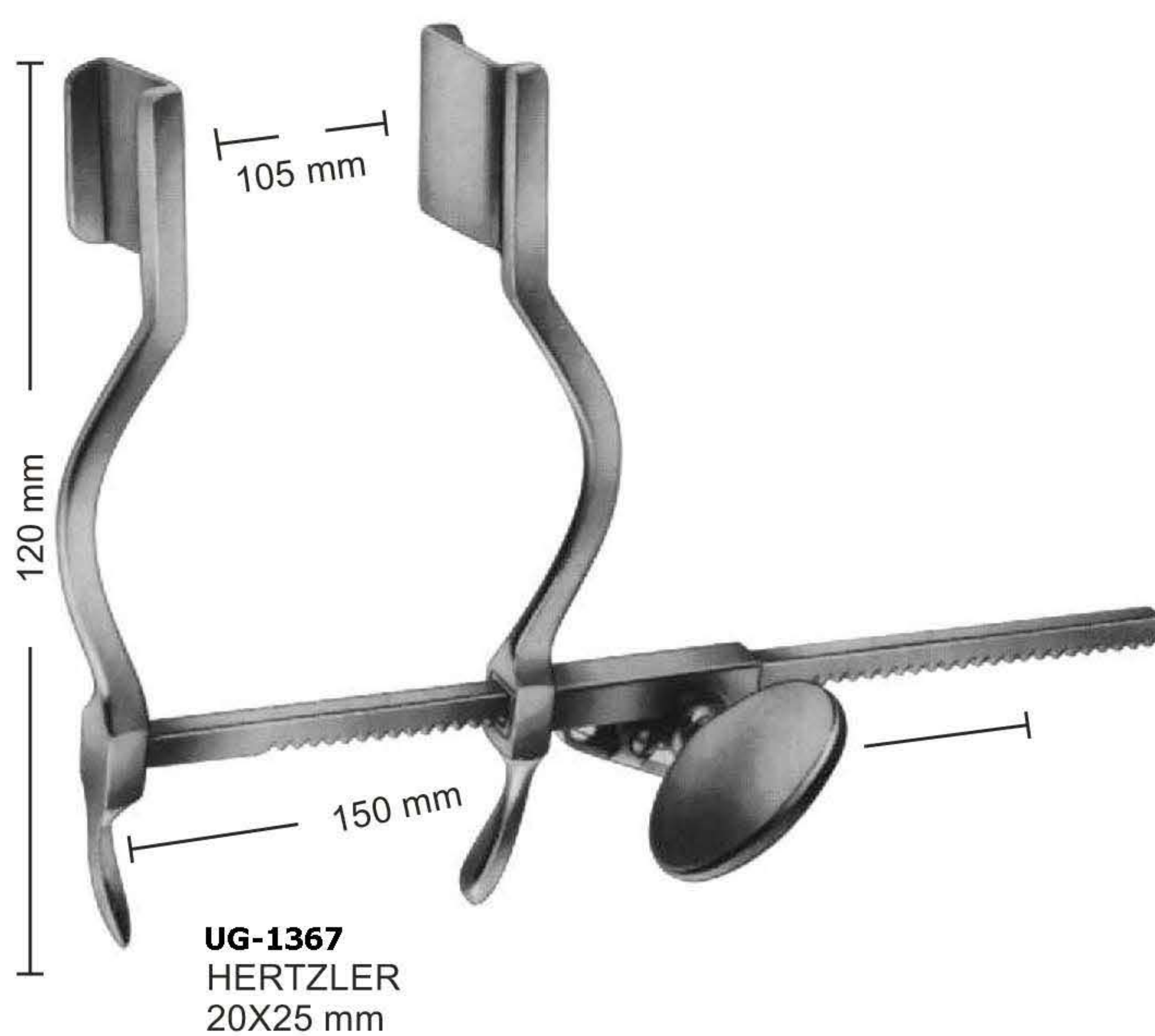
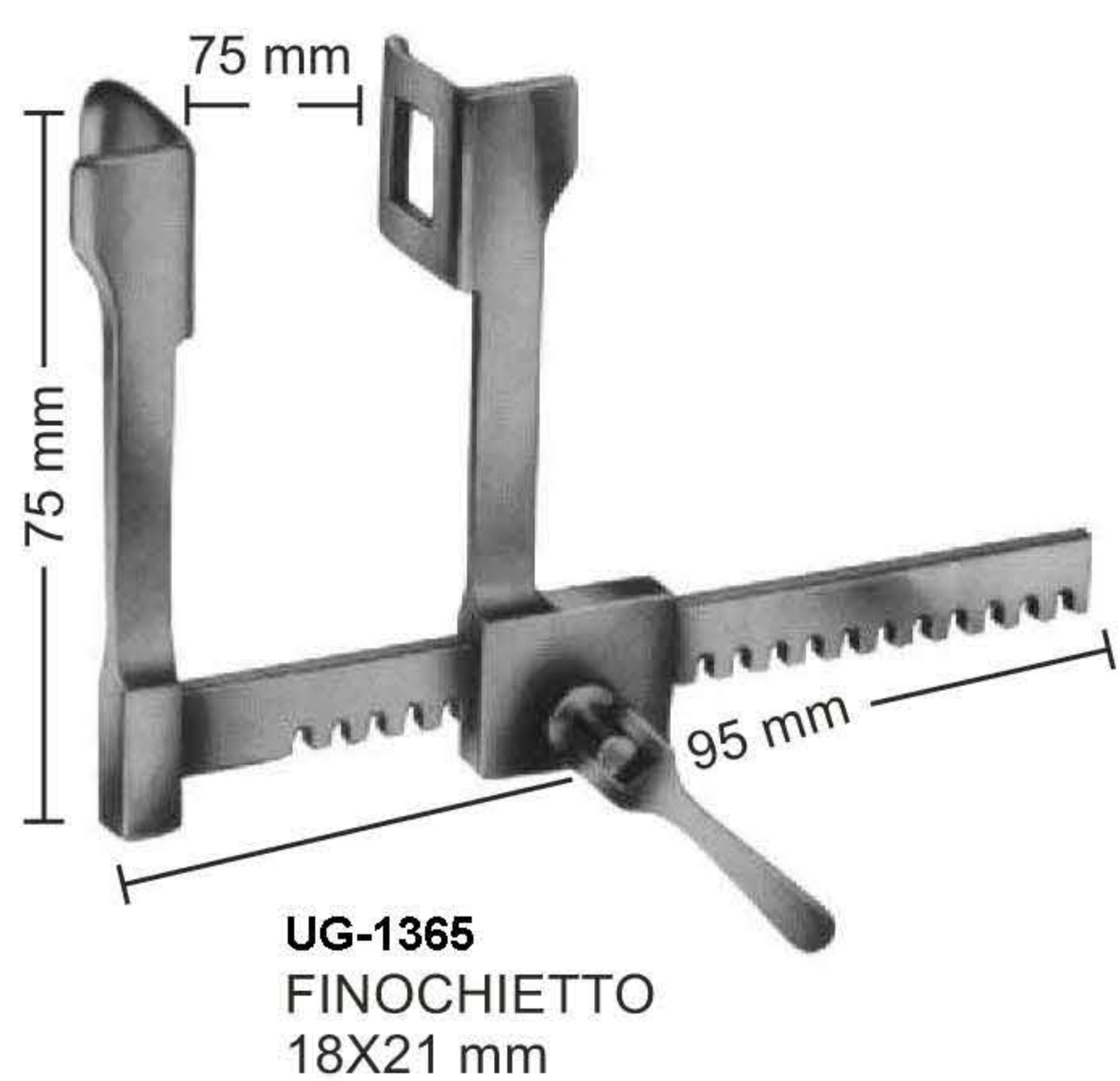

# Rib Spreaders

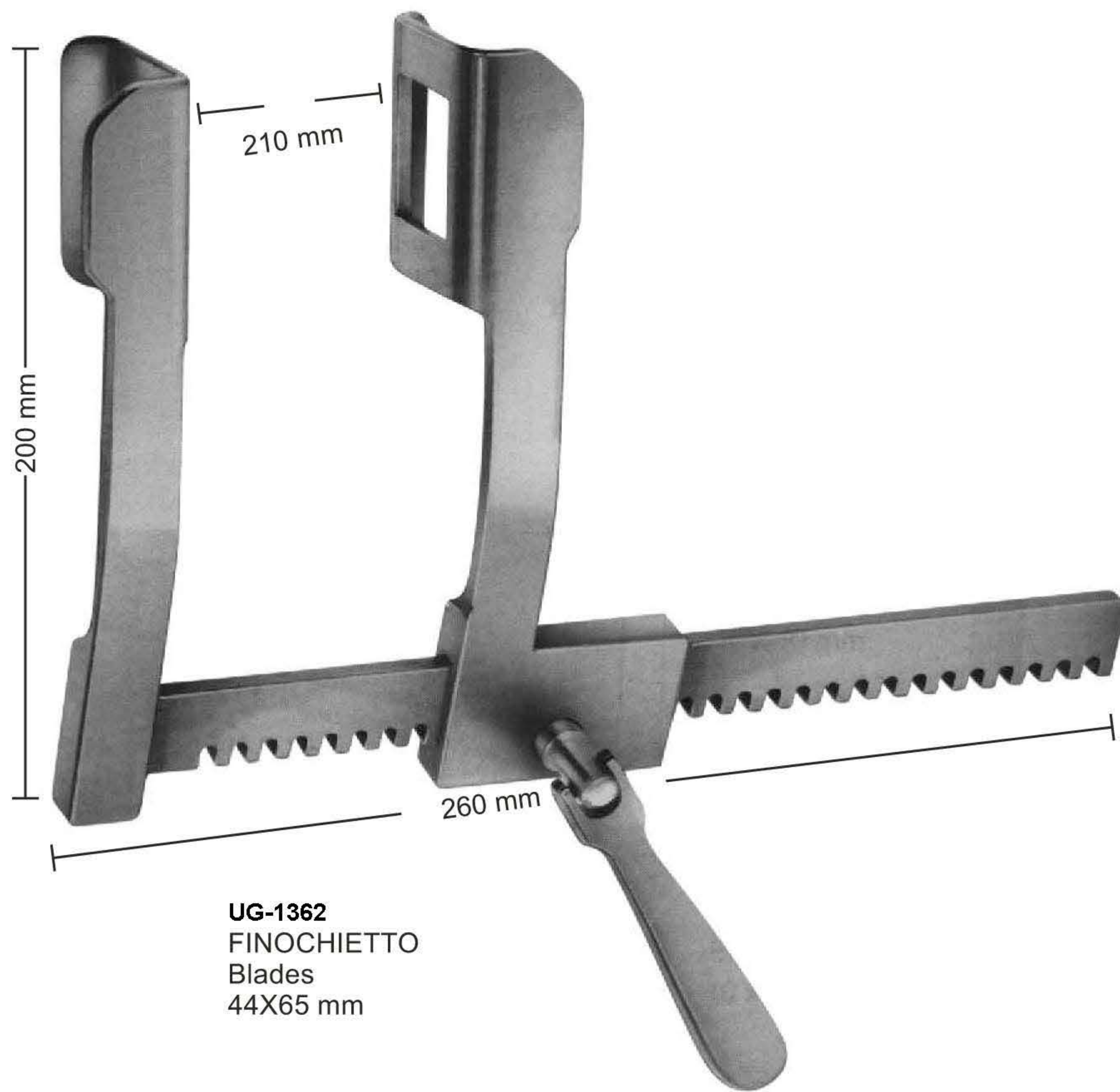

**UG-1362**  
FINOCHIETTO  
Blades  
44X65 mm

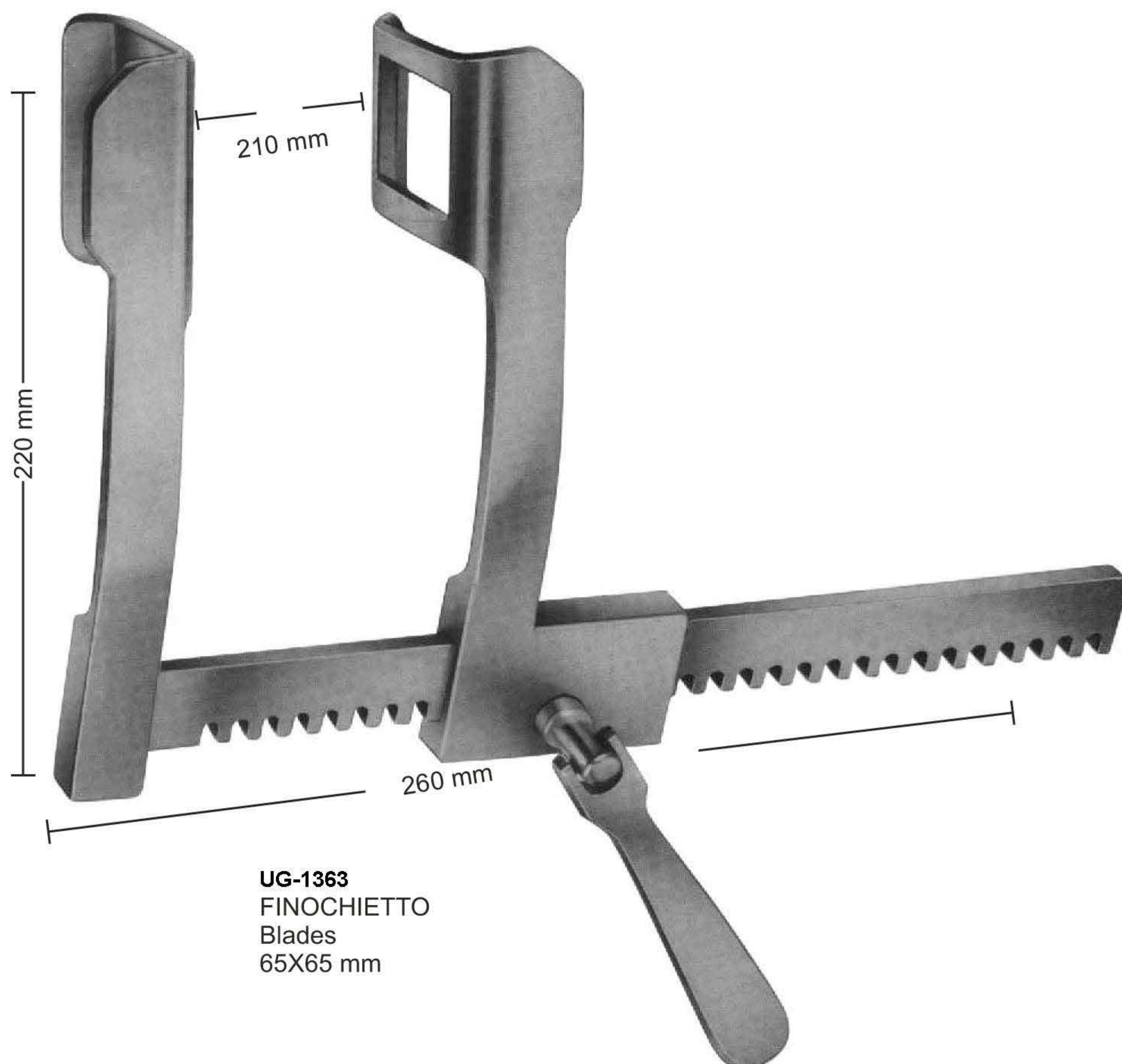

**UG-1363**  
FINOCHIETTO  
Blades  
65X65 mm

# Rib Spreaders

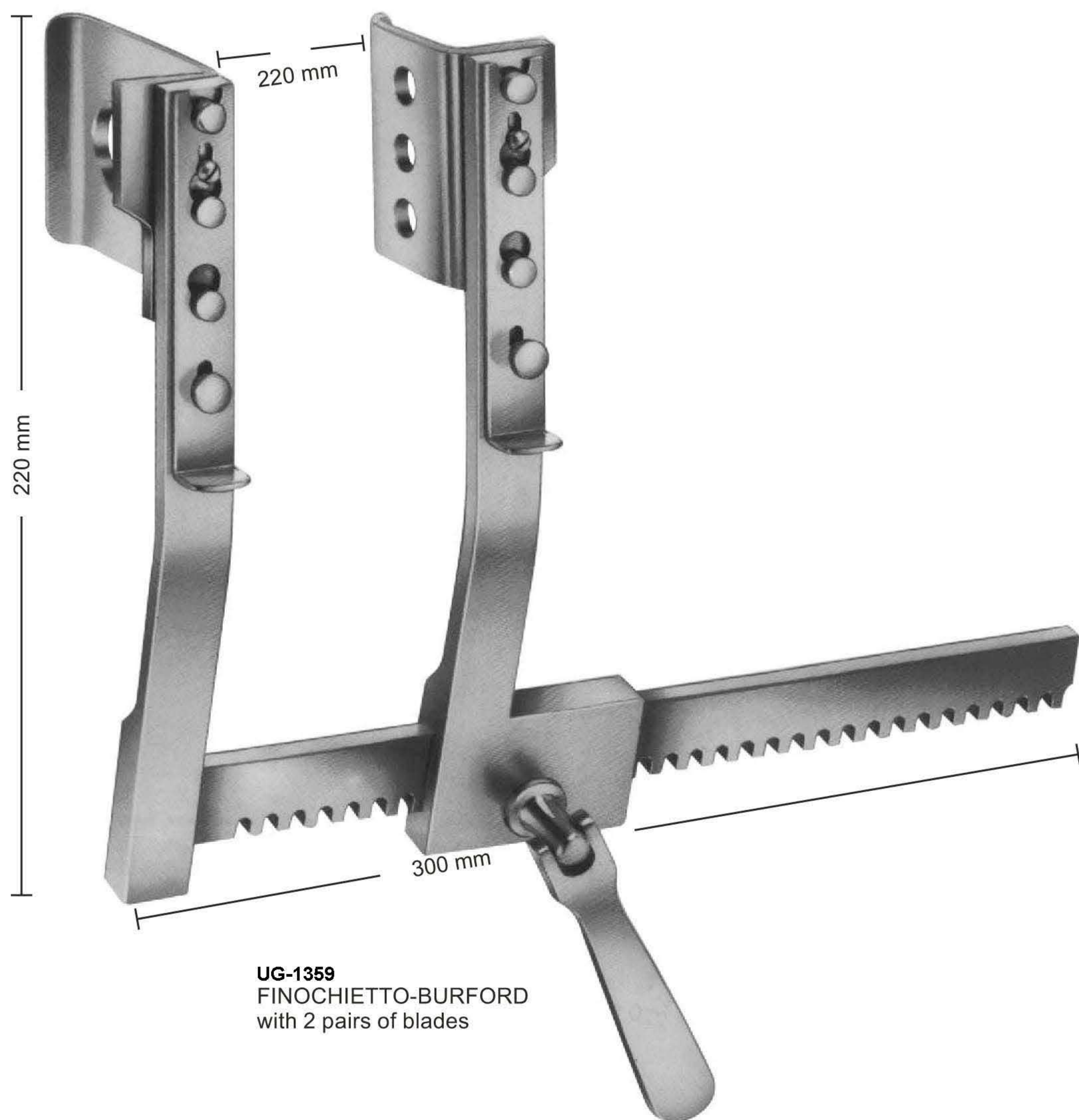

# Rib Spreaders

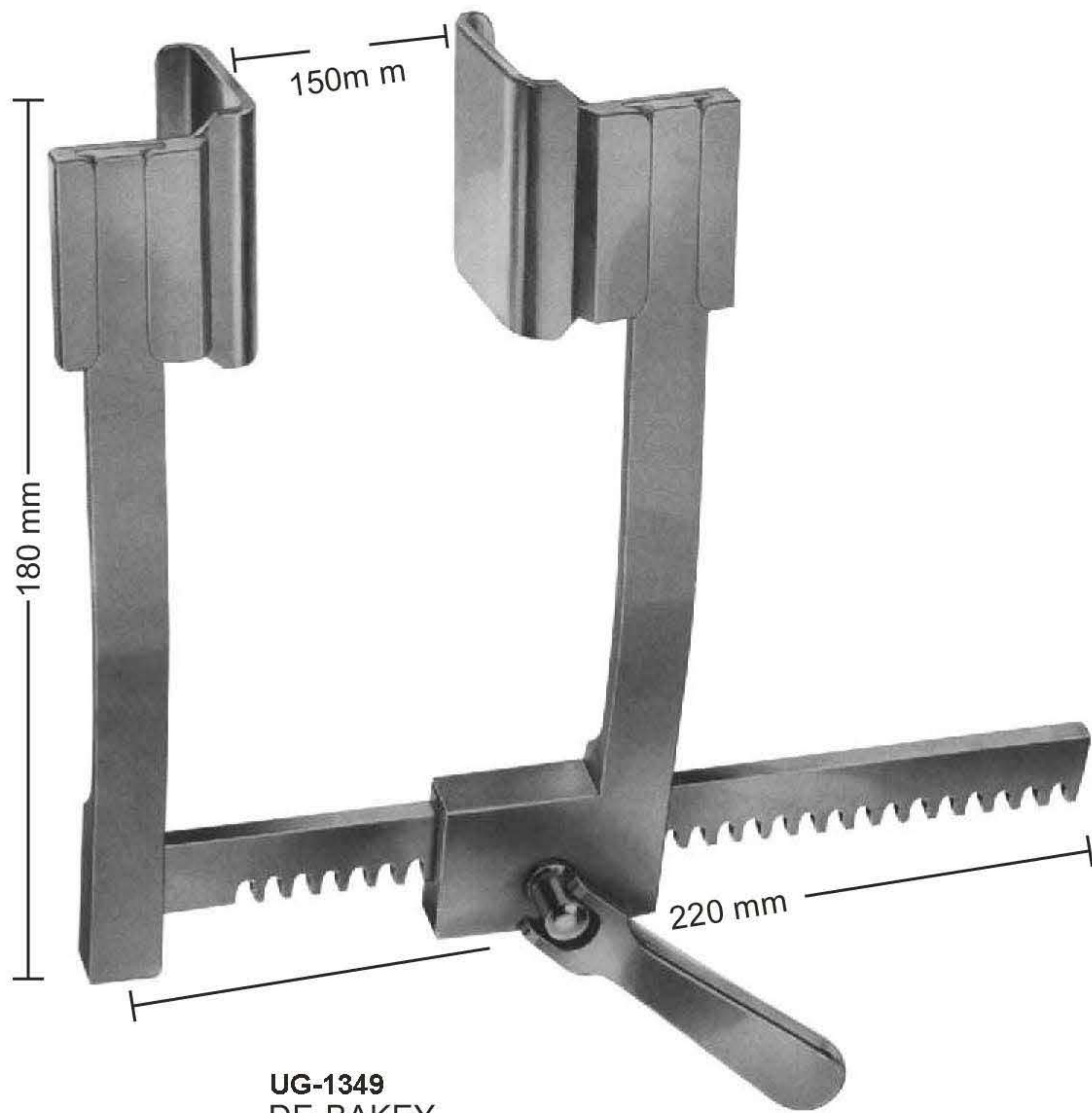

**UG-1349**  
DE-BAKEY  
with 3 pairs of blades

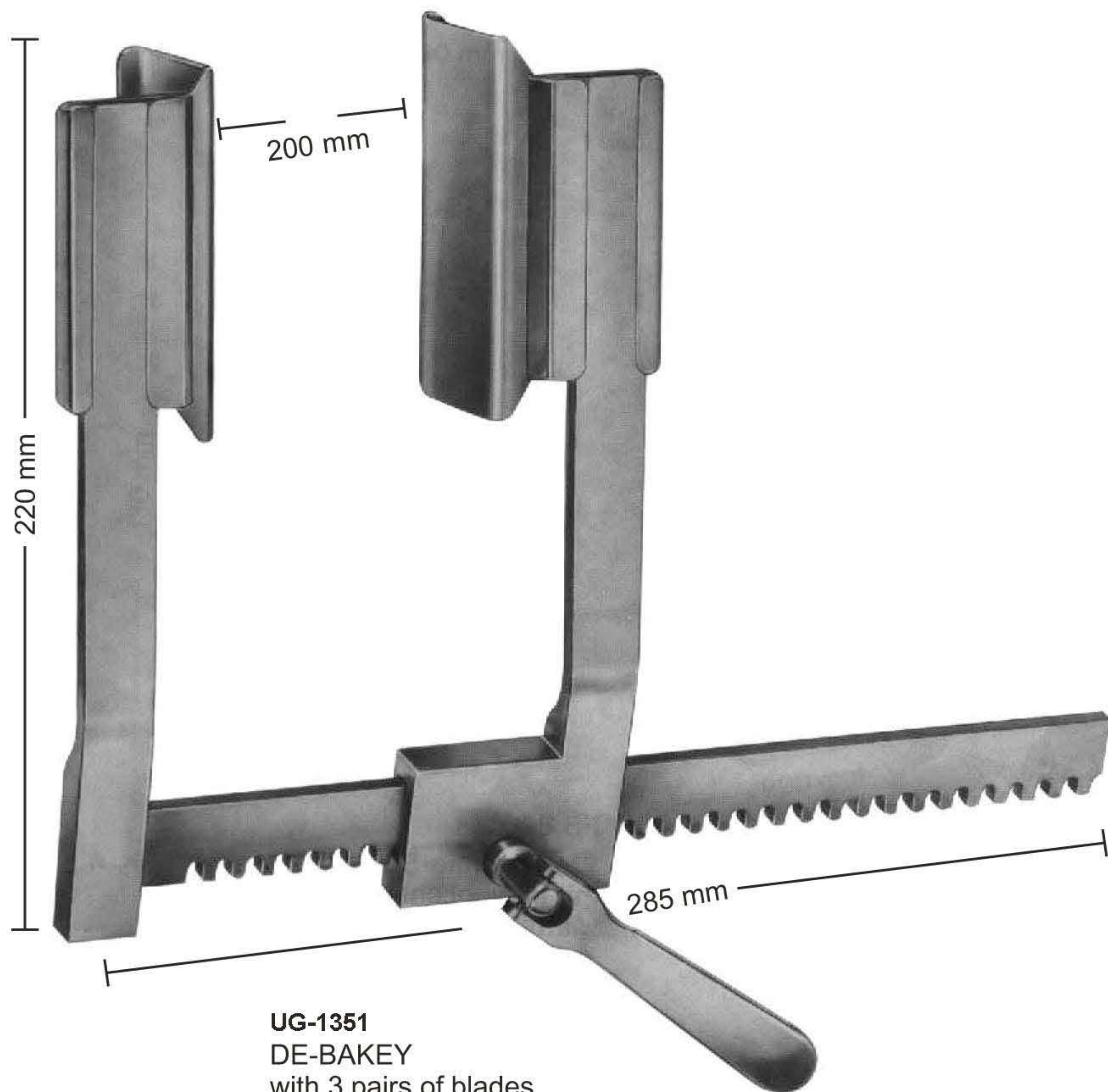

**UG-1351**  
DE-BAKEY  
with 3 pairs of blades

# Sternotomy Spreaders

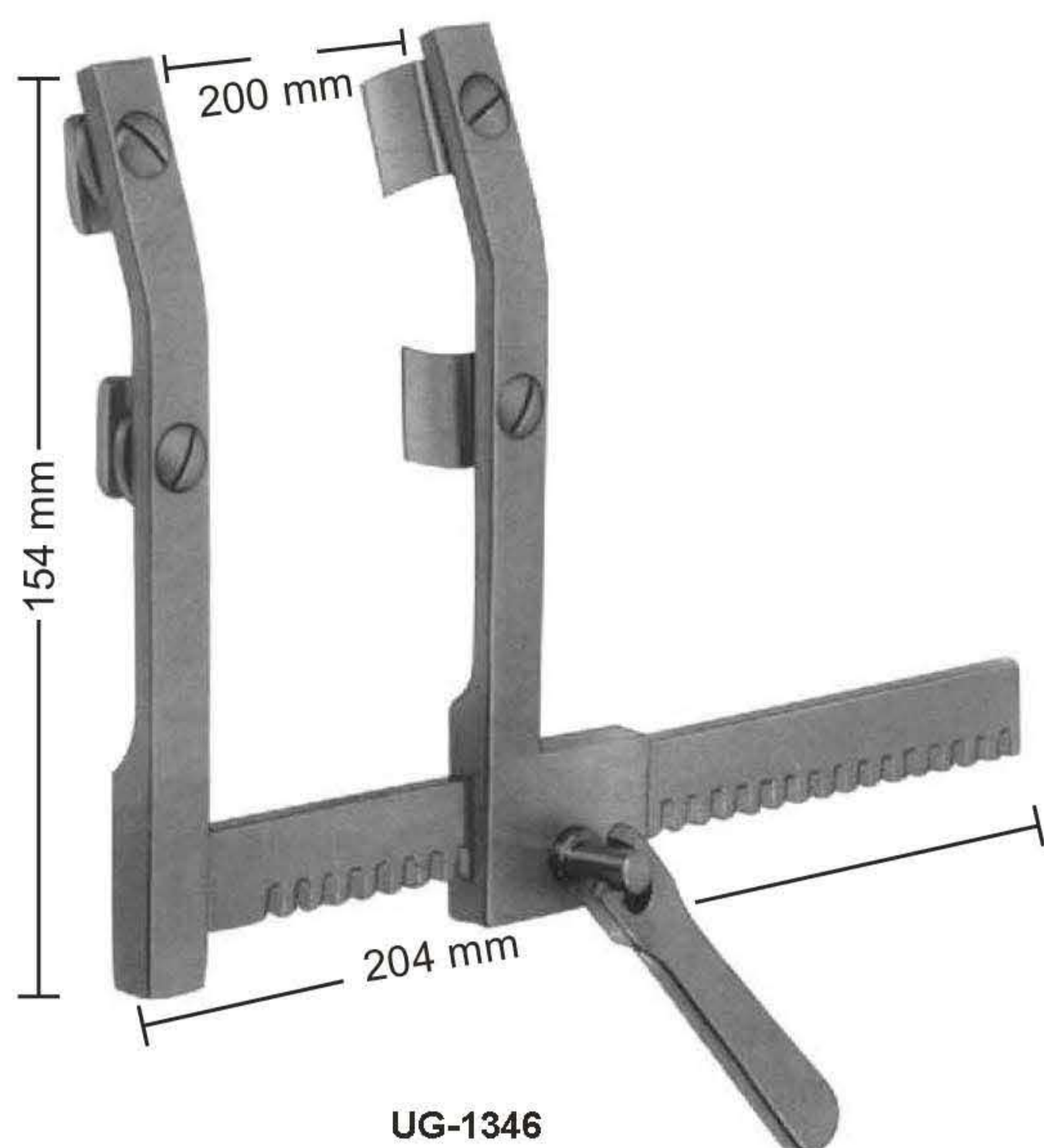

**UG-1346**  
MORSE  
Sternotomy spreader  
for children, with moveable  
double, each blade  
12x20 mm

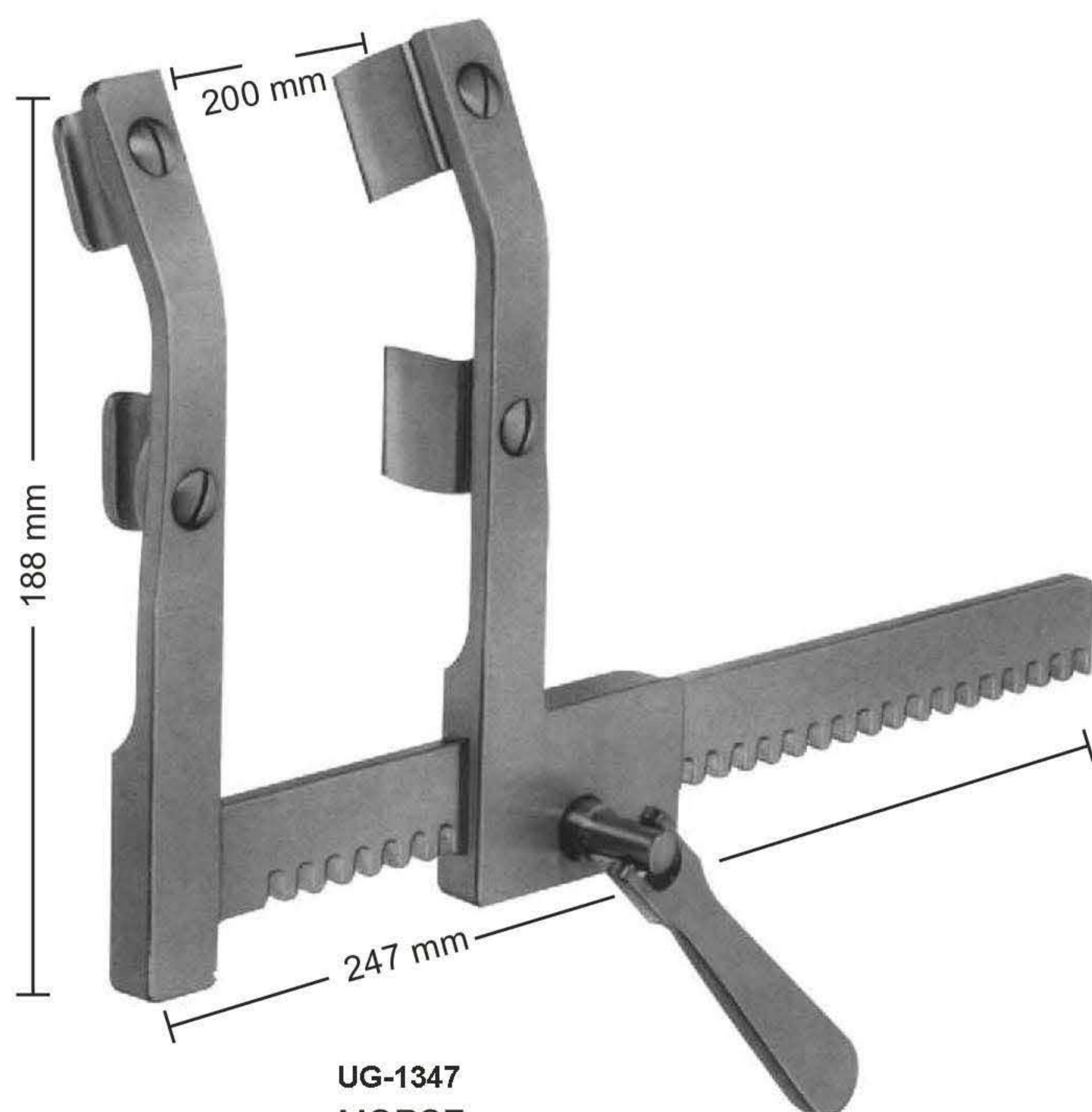

**UG-1347**  
MORSE  
Sternotomy spreader  
for adults, with moveable  
double, each blade  
19x19 mm

# Sternotomy- Spreaders

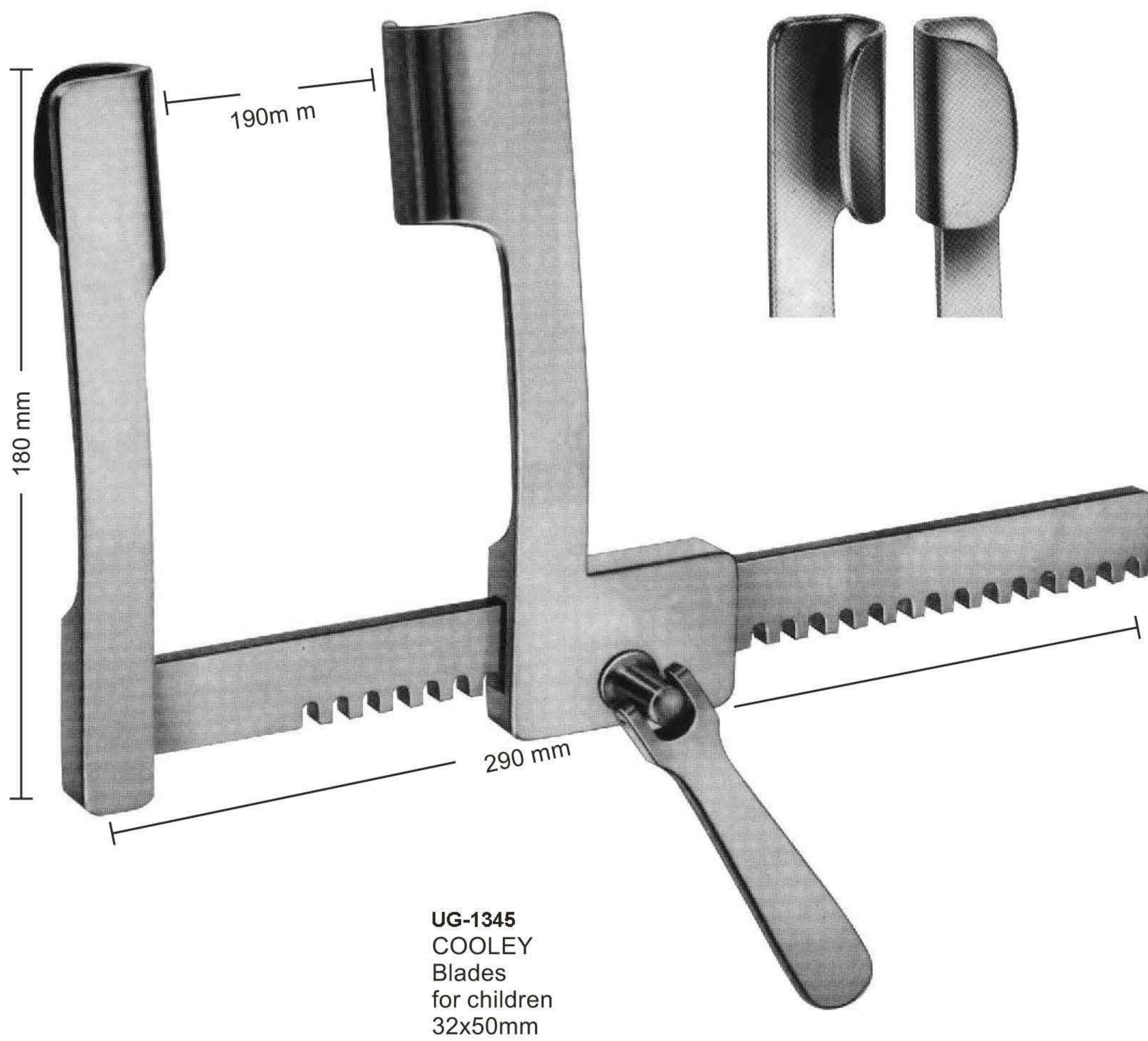
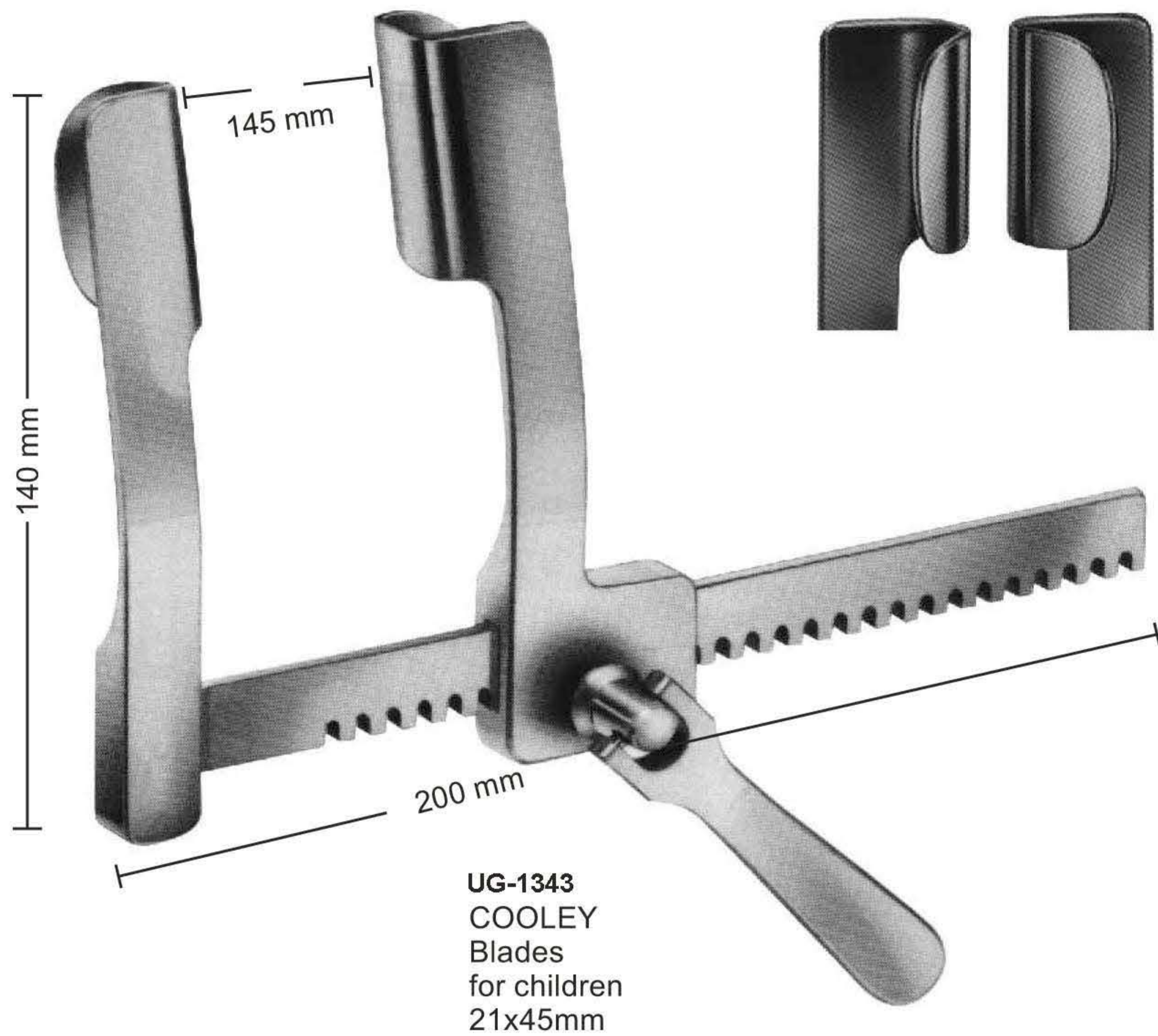

# Thoracic Retractors



**UG-1339**  
Thoraxsperrer (Mercedes-Sperrer)  
complete consisting of:  
**17-413** Retractor only  
**17-414** 1 Pair of blades 42x65 mm  
**17-415** 1 Pair of blades 75x75 mm

# Rib Spreaders-and Contractors



**UG-1332**  
**SELLORS**  
Rib spreader and contractor  
with swivel blades  
200 mm



**UG-1335**  
**BAILEY**  
150 mm



17-418  
for children

**UG-1336**  
**BAILEY**  
200 mm



# Rib Spreaders-and Contractors

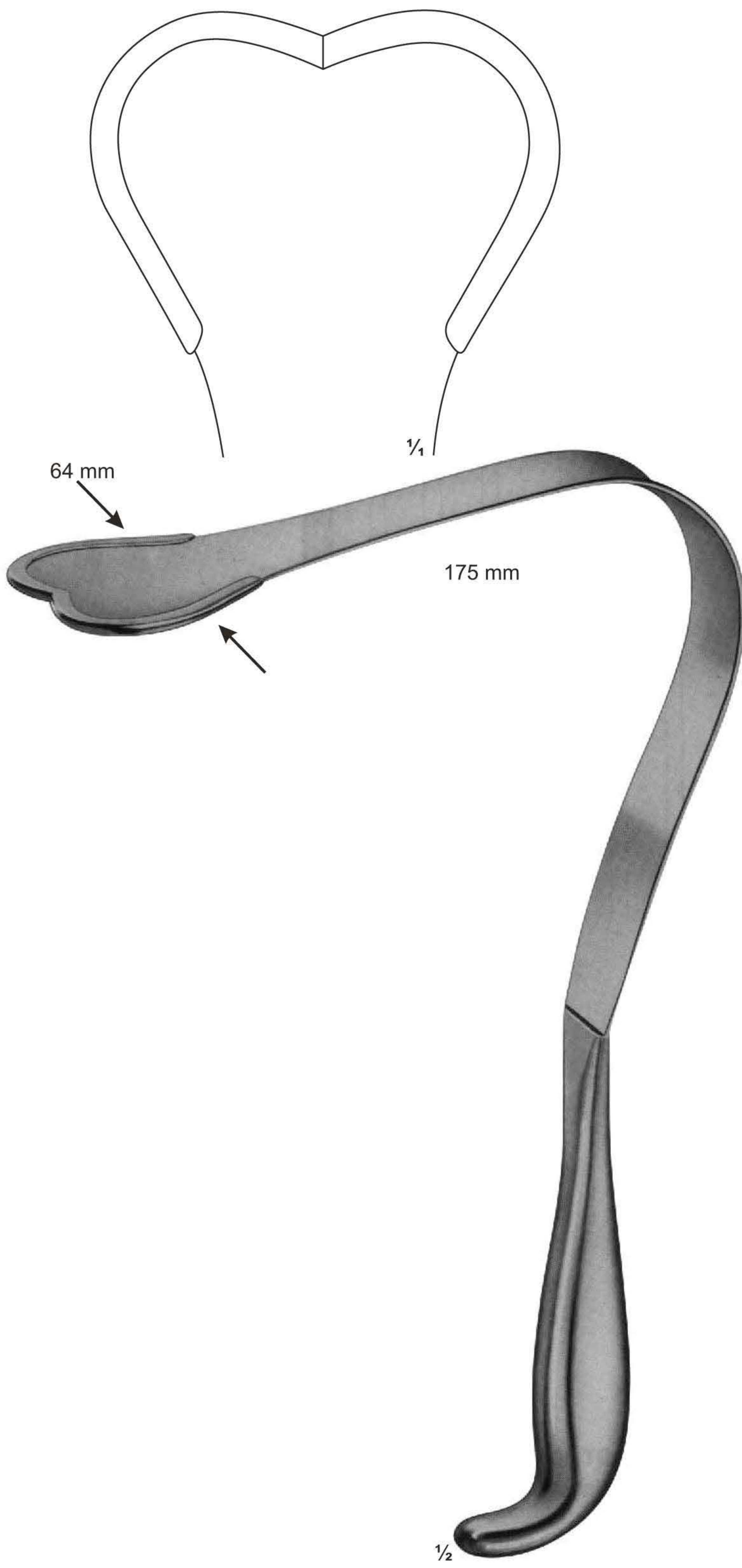

**UG-1329**  
HARRINGTON-PEMBERTON  
federnd/flexible  
295 mm

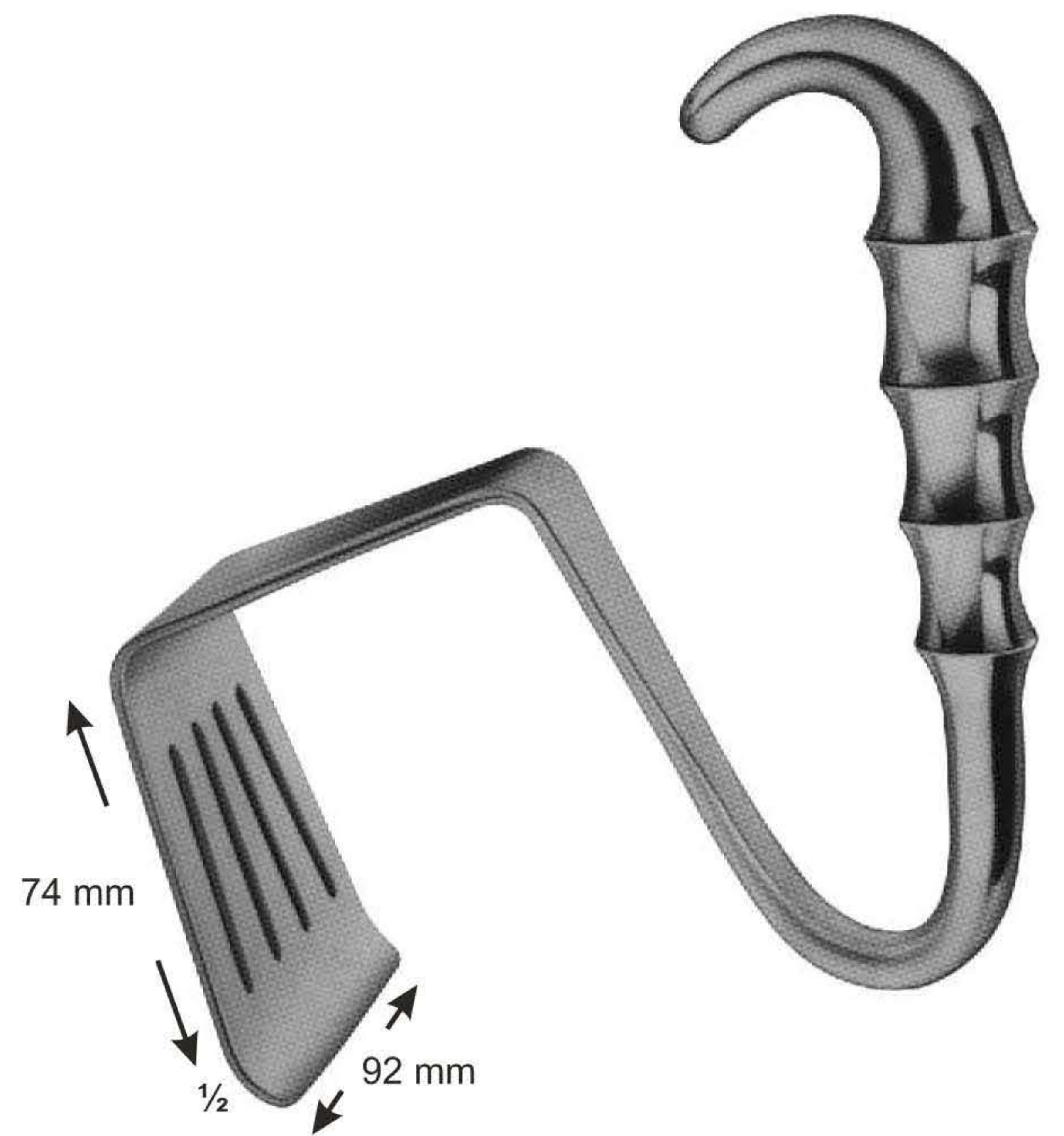

**UG-1331**  
DAVIDSON  
Scalpel haken

# Rib Spreaders-and Contractors



**UG-1324**  
ALLISON  
255 mm



**UG-1326**  
ALLISON  
320 mm



**UG-1327**  
DE BAKEY  
With central bore,  
3.0mm diam.  
with lateral slots  
275 mm



**UG-1328**  
YANKAUER  
With central bore,  
2.0mm diam.  
285 mm

# Punches

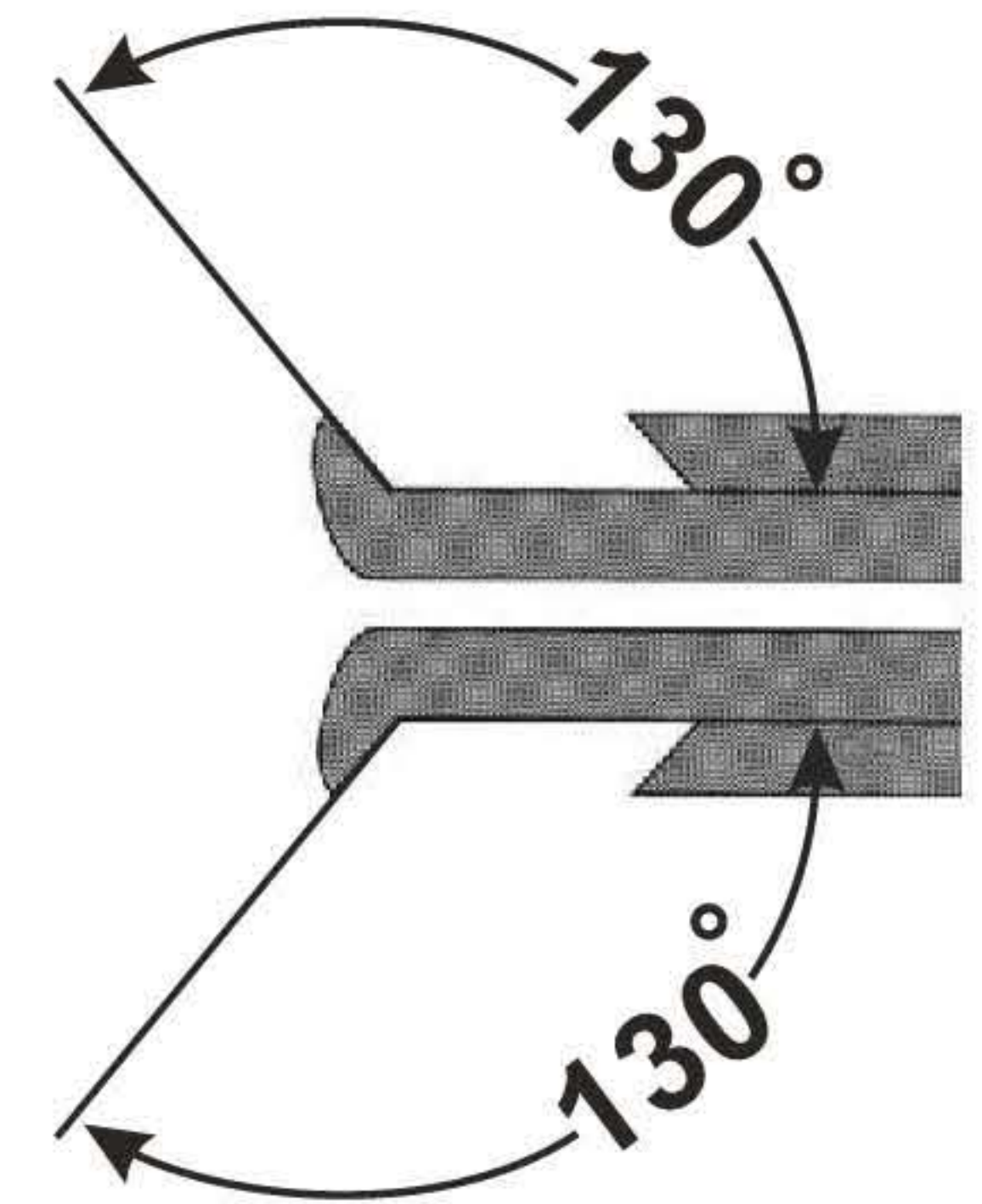
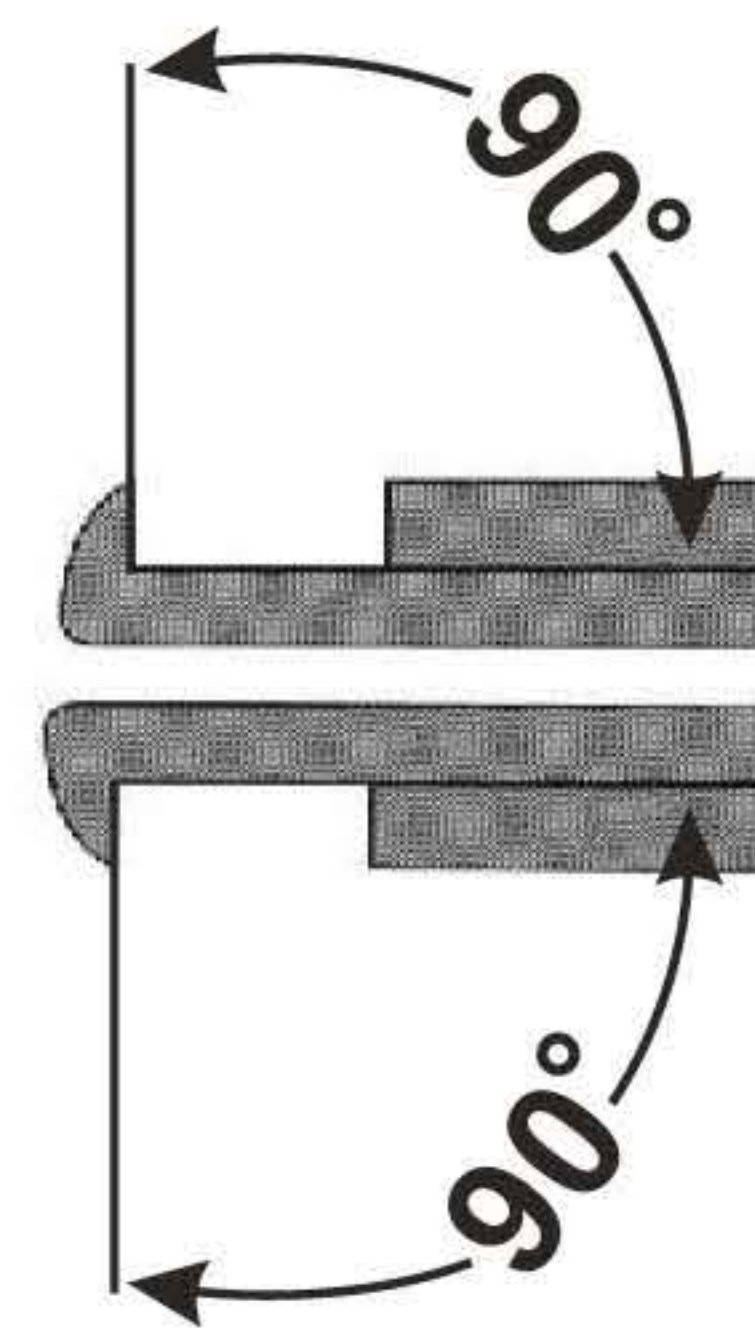
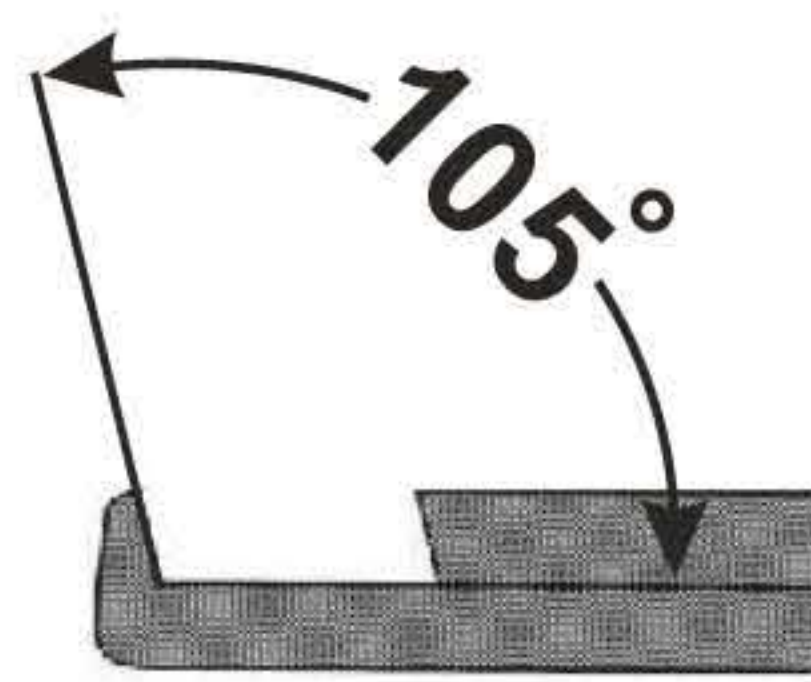

90° upwards cutting



**UG-1482**  
CITELLI  
2 mm, 3,5 mm

90° upwards cutting

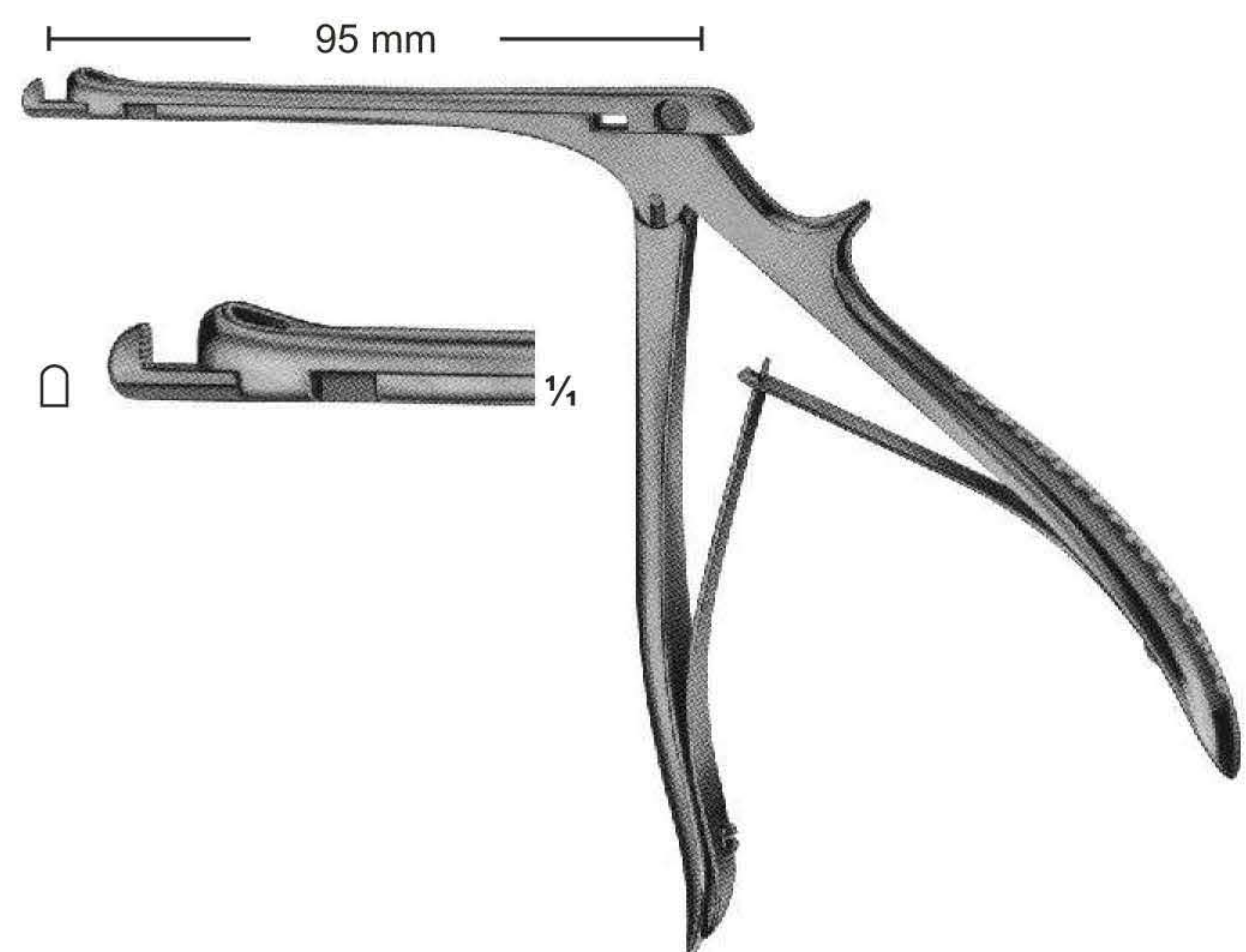

**UG-1483**  
CITELLI- BEYER  
1,8 mm

# Punches

**90°** upwards cutting



**UG-1484**  
KERRISON

**90°** upwards cutting

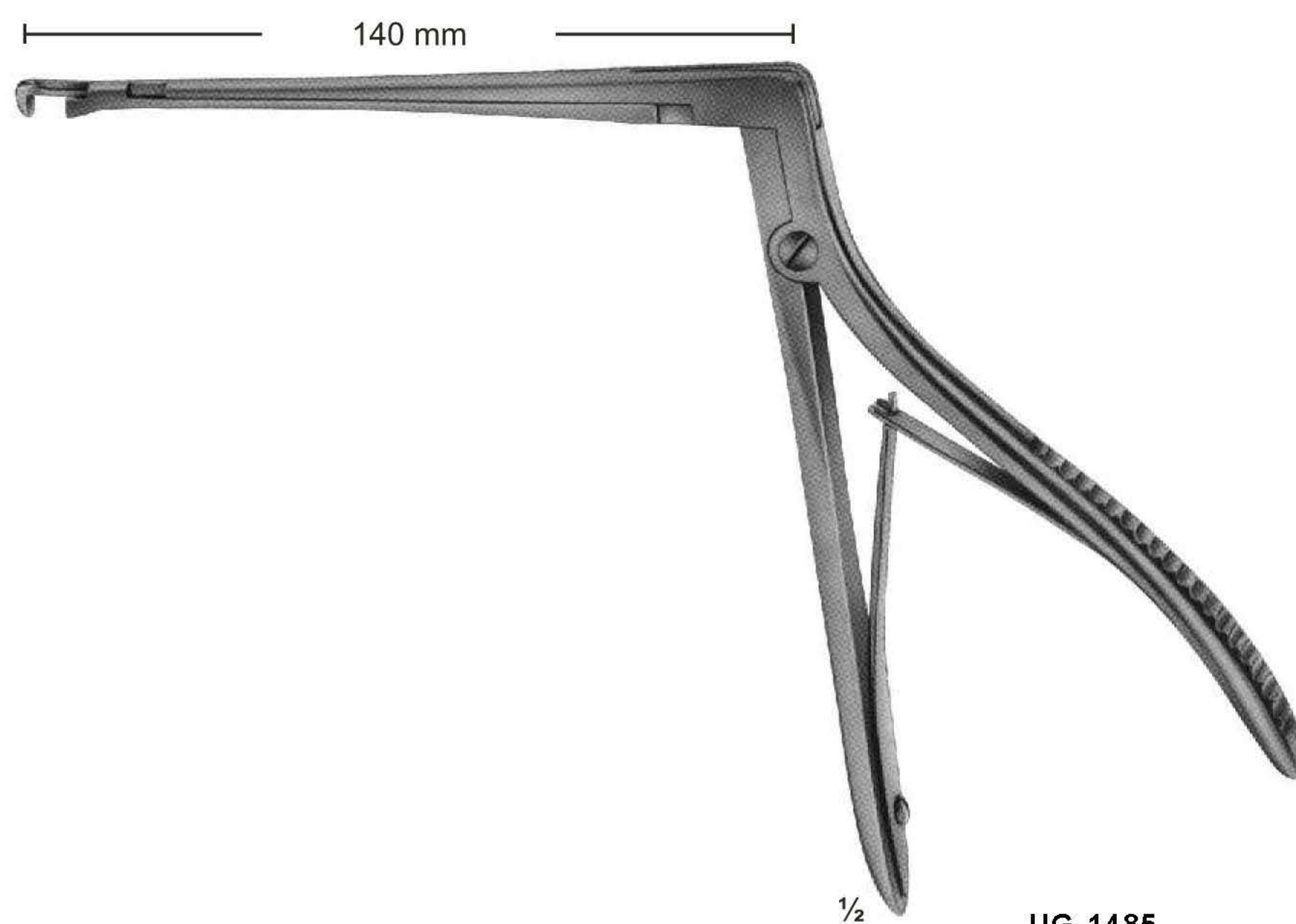

**UG-1485**  
HAJEK-KOFLER

# Punches

**130°** upwards cutting

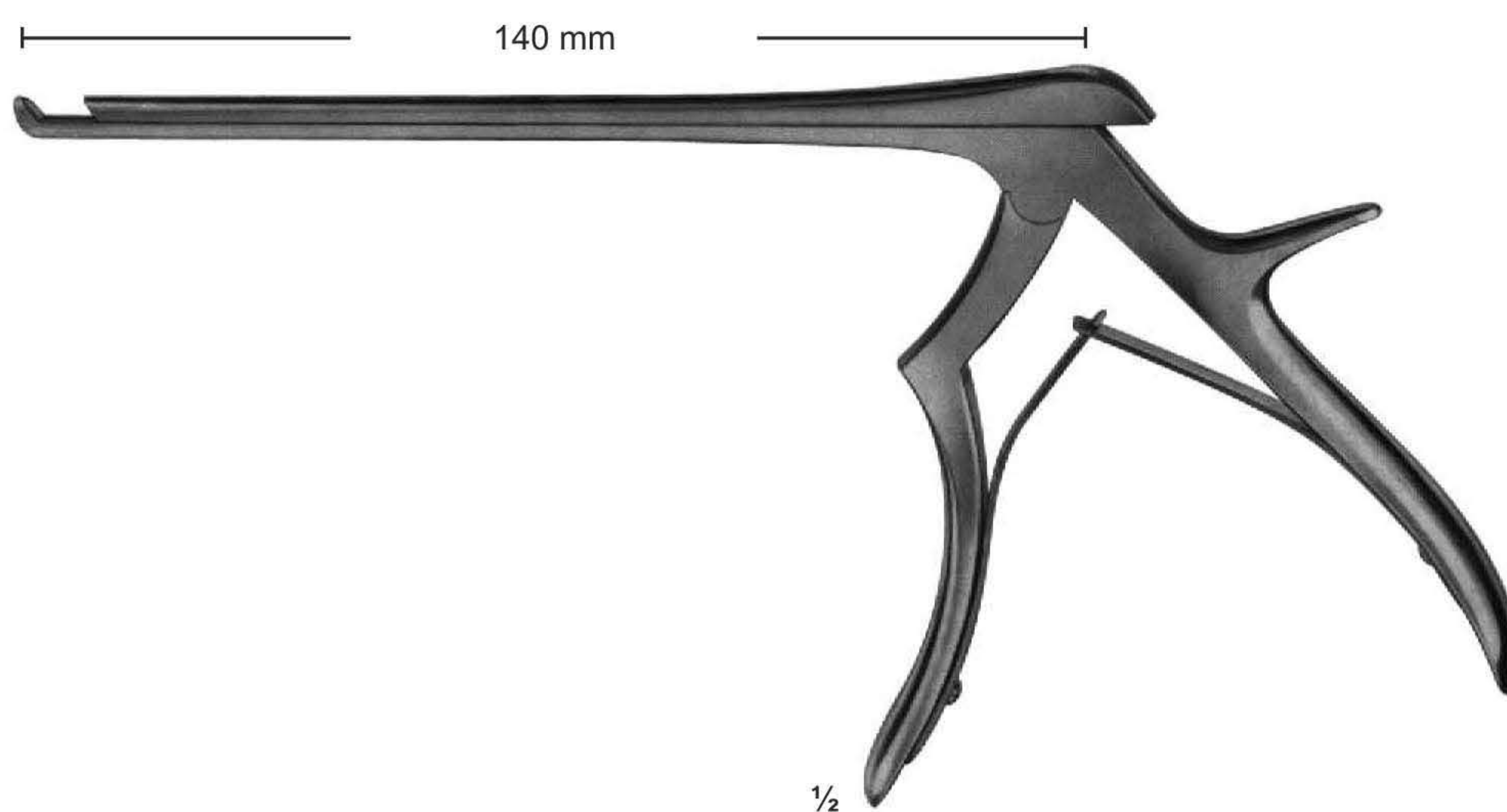

**UG-1486**  
KERRISON-JACOBY

**90°** upwards cutting

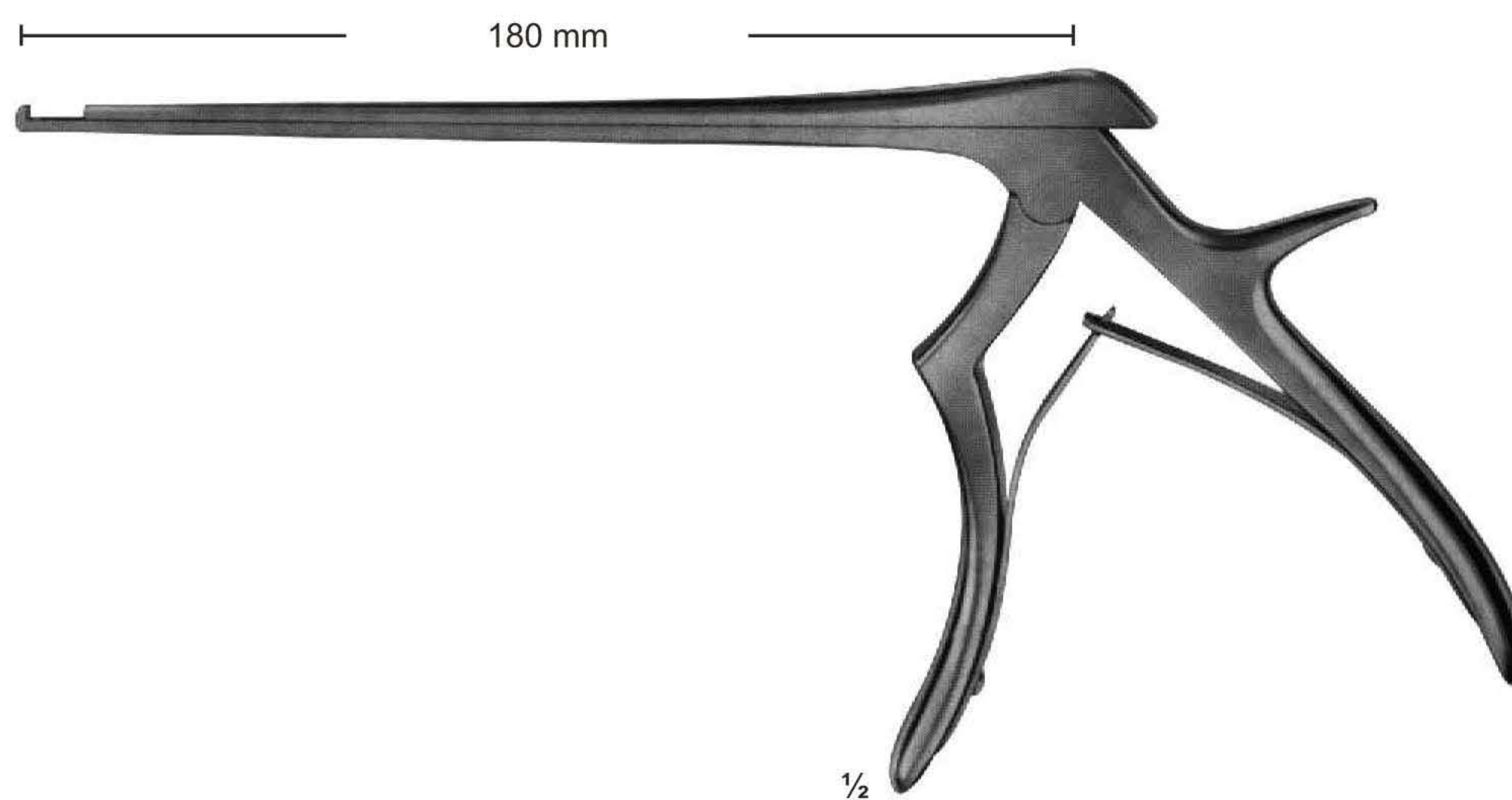

**UG-1487**  
KERRISON-JACOBY

# Rongeurs

Angled positions for rongeurs

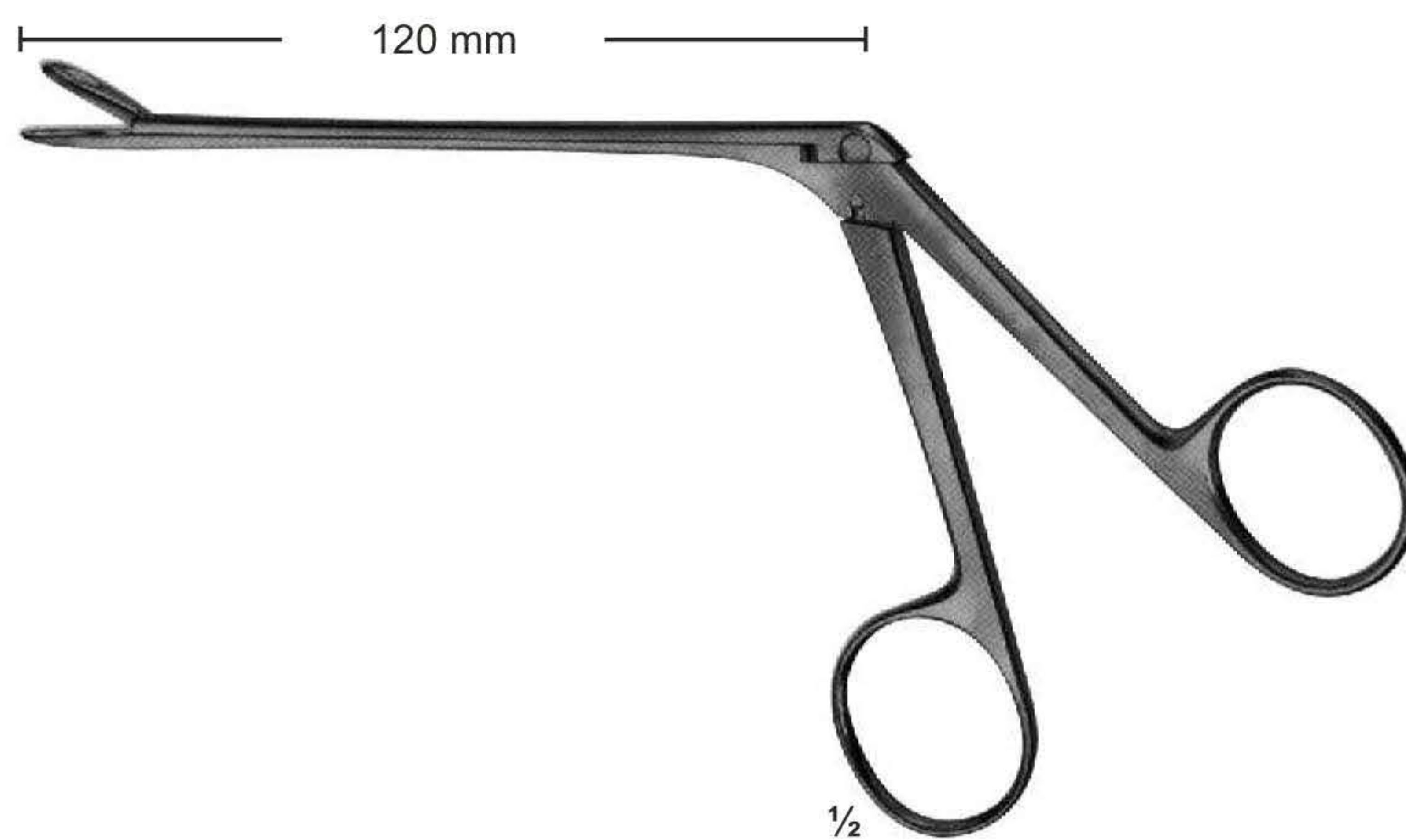

**UG01488**  
WEIL-BLAKESLEY

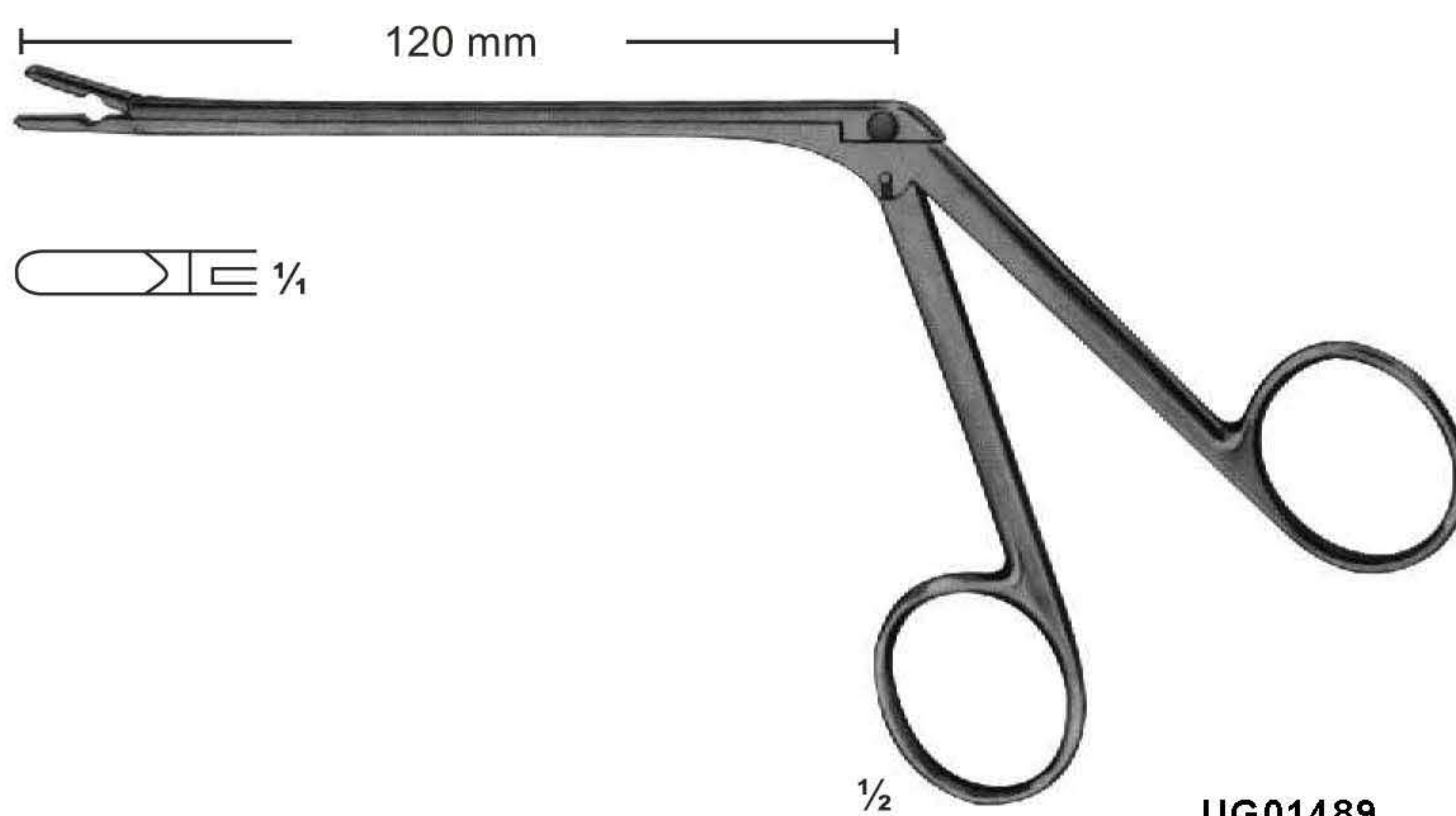

**UG01489**  
TAKAHASHI  
3 mm

130°

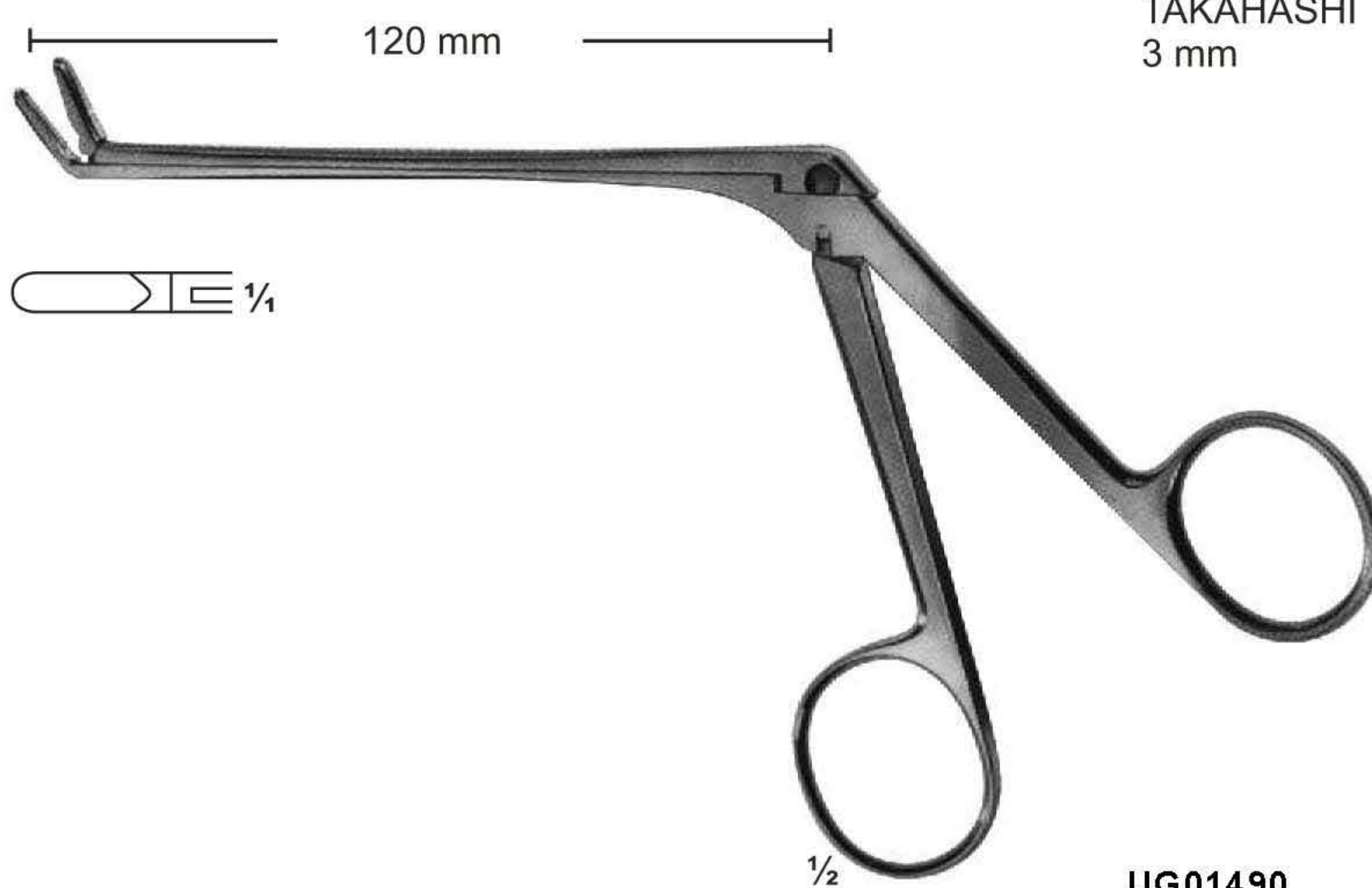

**UG01490**  
TAKAHASHI  
3 mm

# Rongeurs

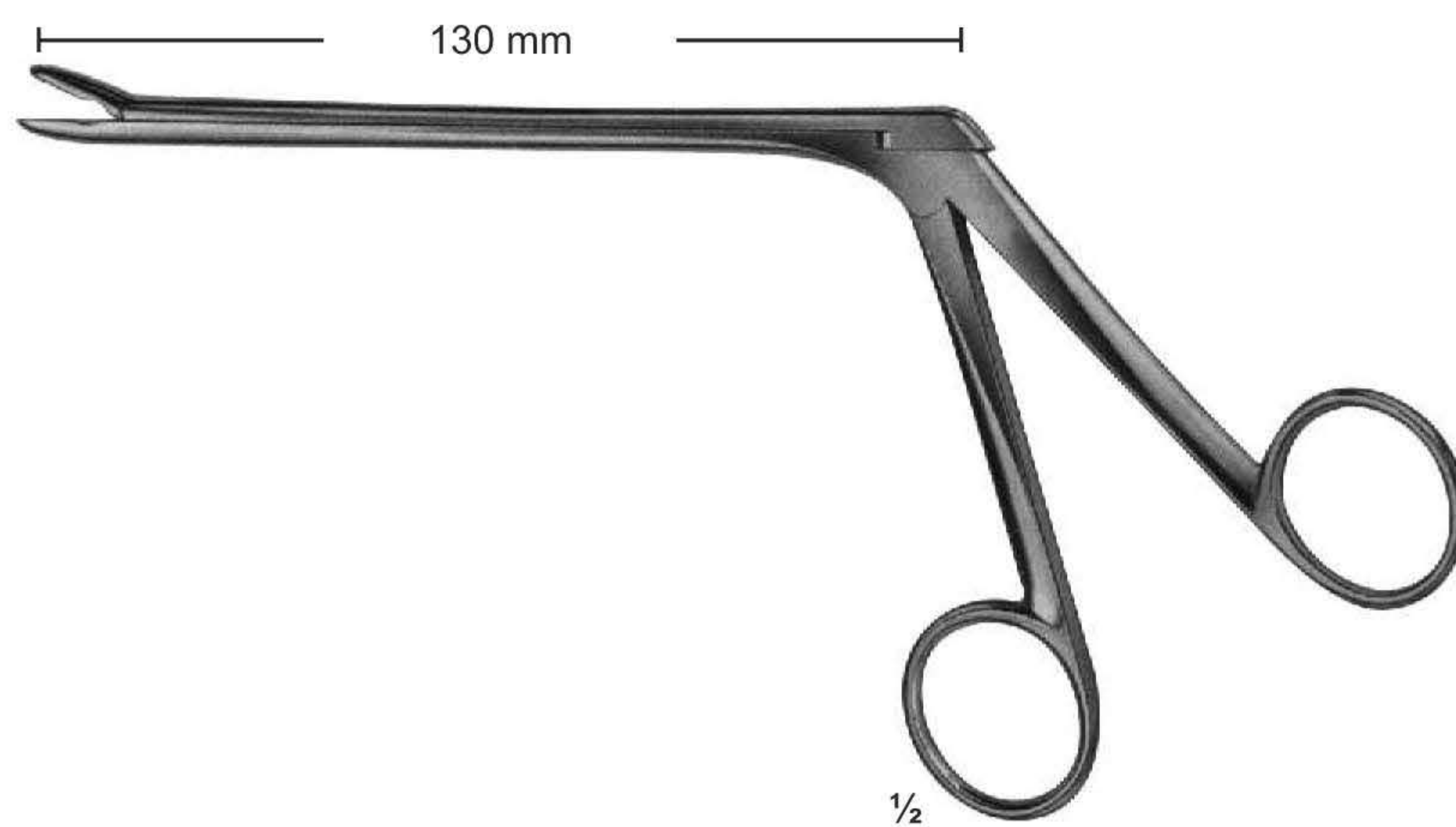

**UG-1491**  
LOVE-GRUENWALD

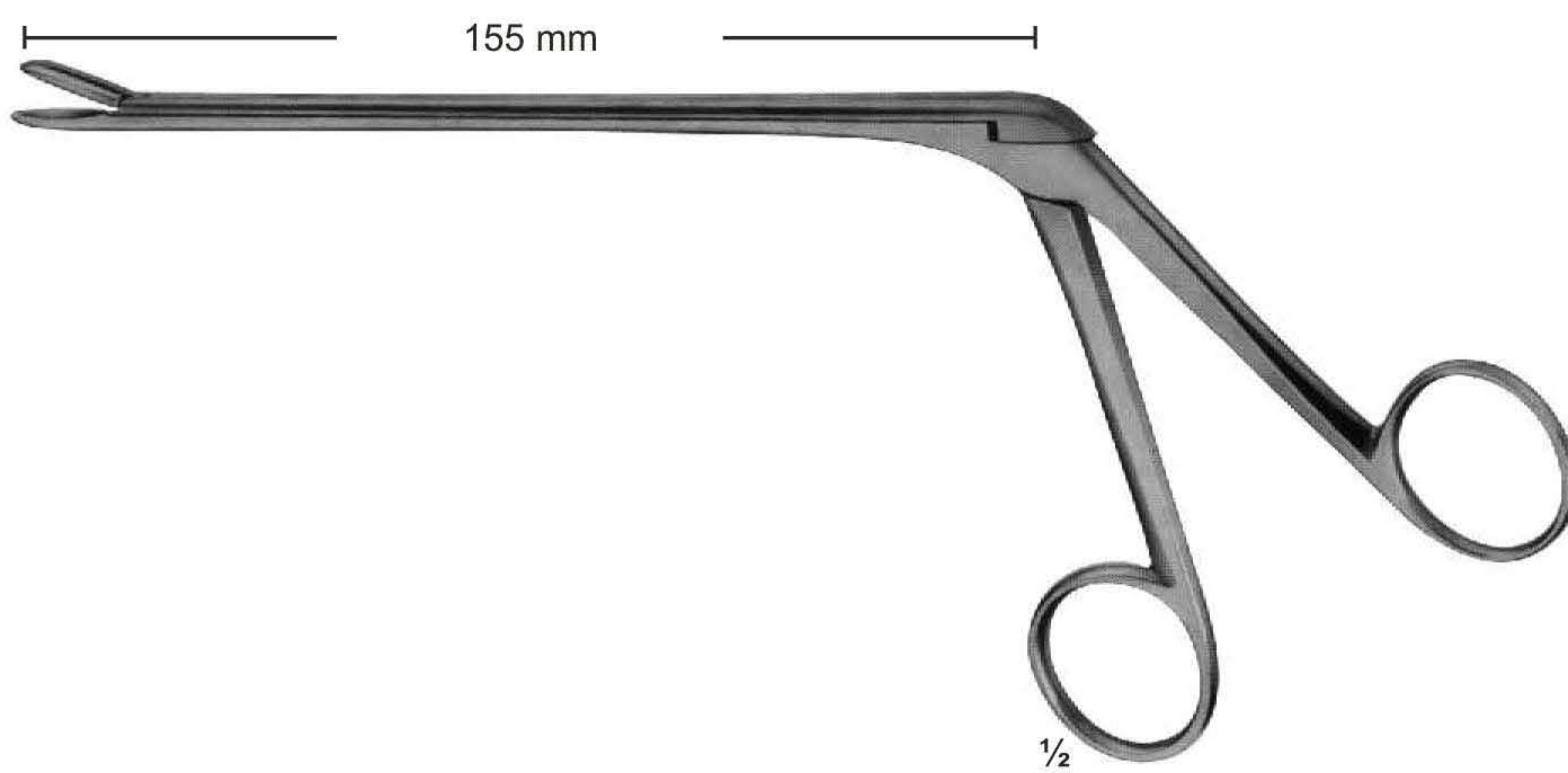

**UG-1492**  
CASPAR

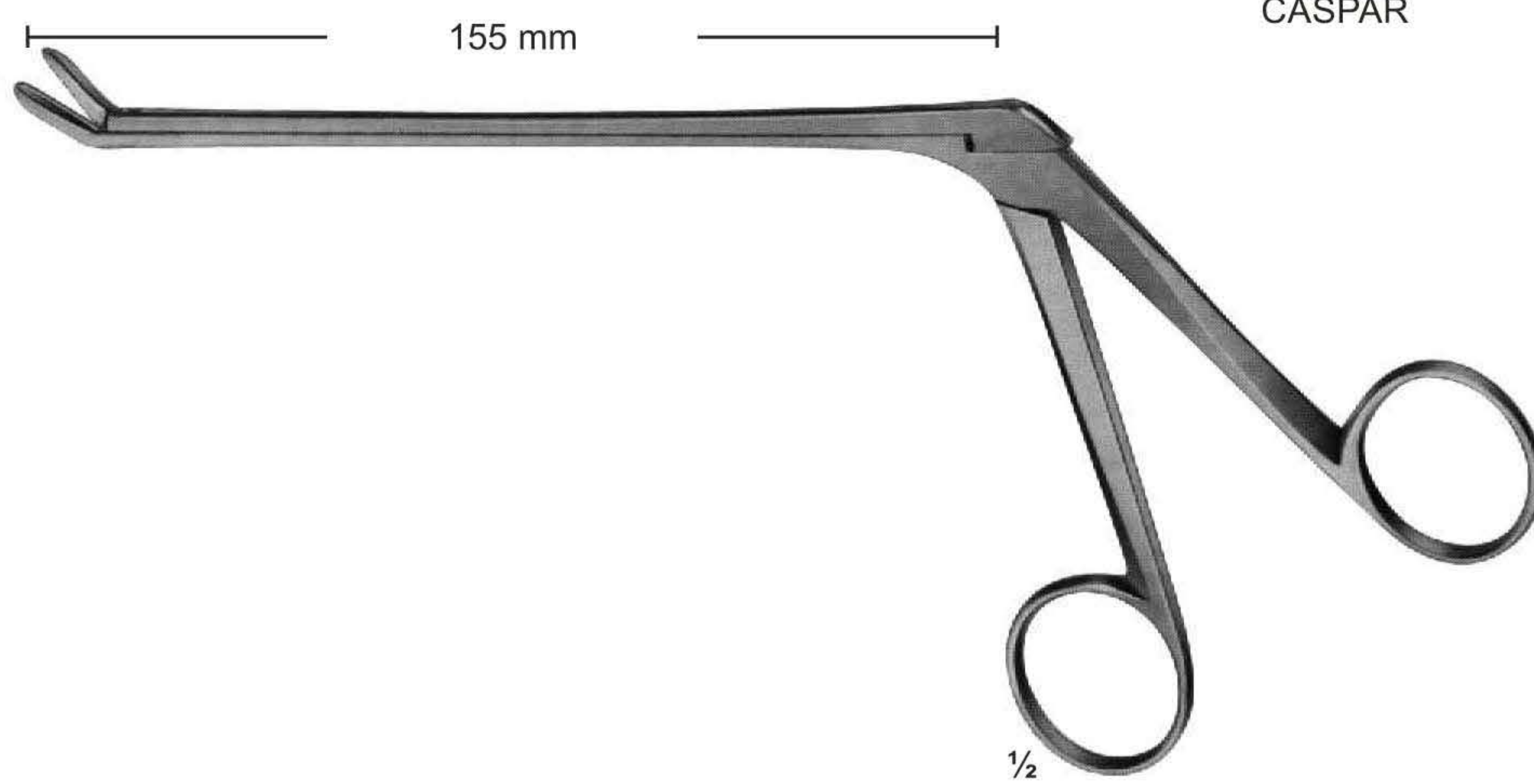

**UG-1493**  
CASPAR

# Rongeurs

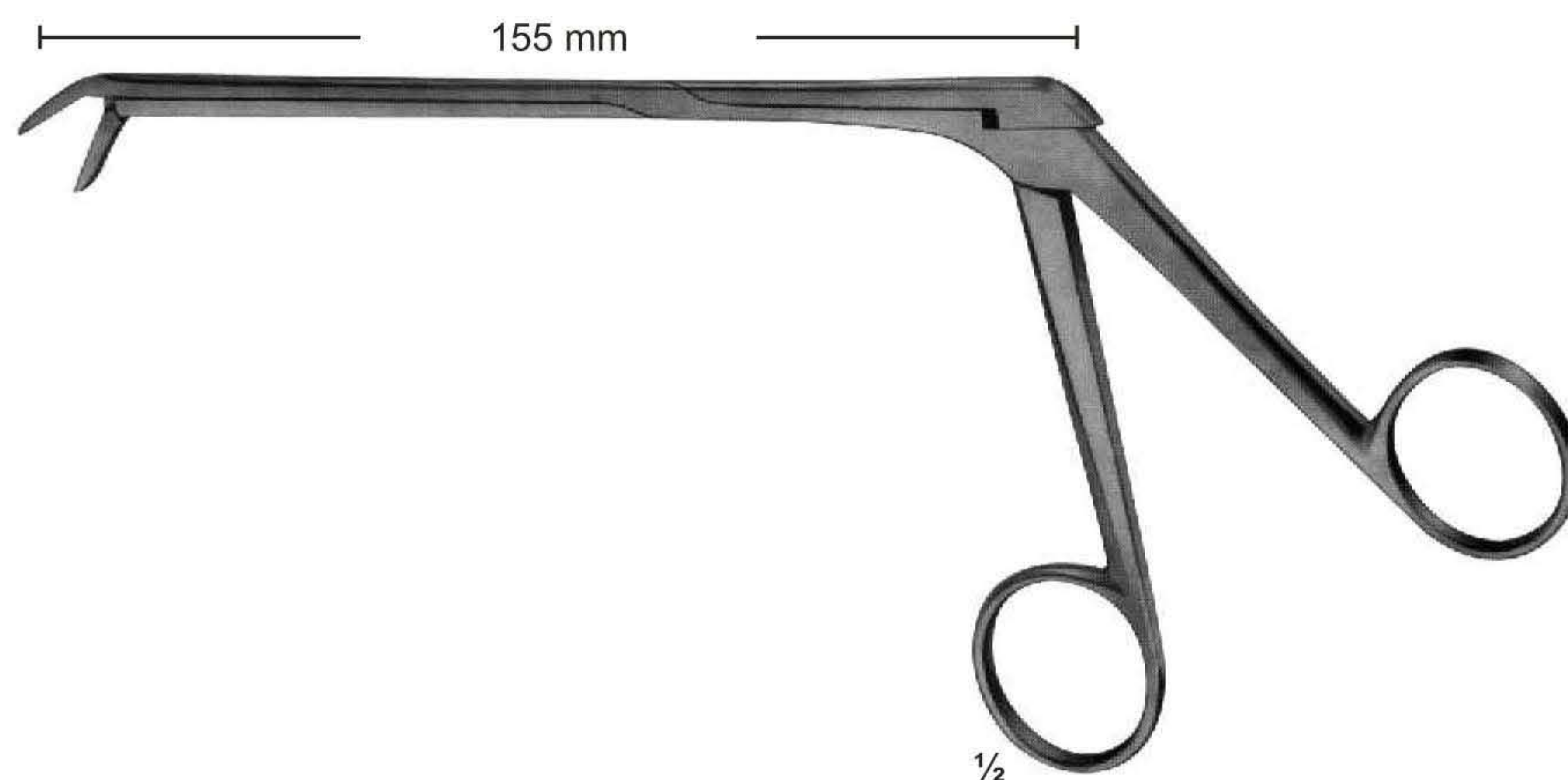

**UG-1494**  
CASPAR

Length of shaft	Length of shaft	Length of shaft	size of jaws
140 mm	160 mm	185 mm	

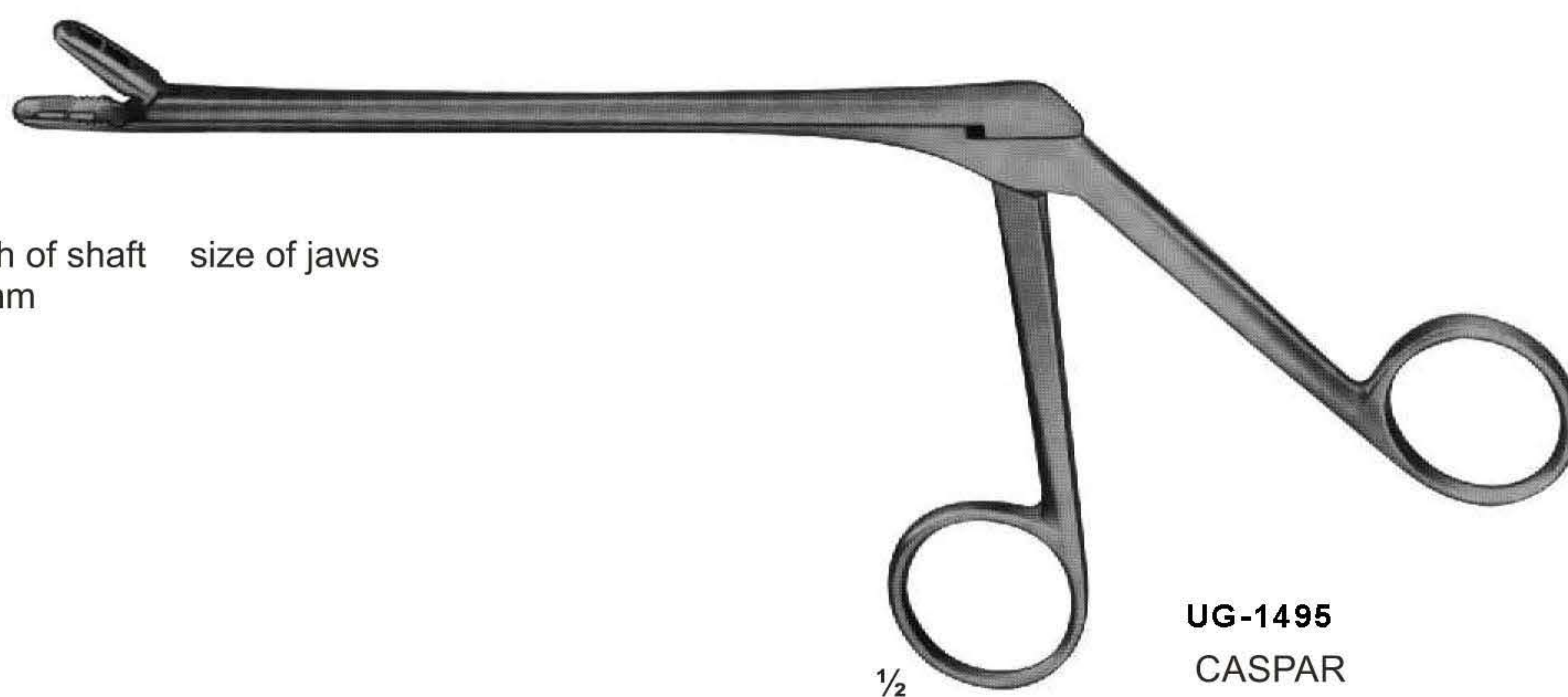

**UG-1495**  
CASPAR

Length of shaft	Length of shaft	Length of shaft	size of jaws
140 mm	160 mm	185 mm	

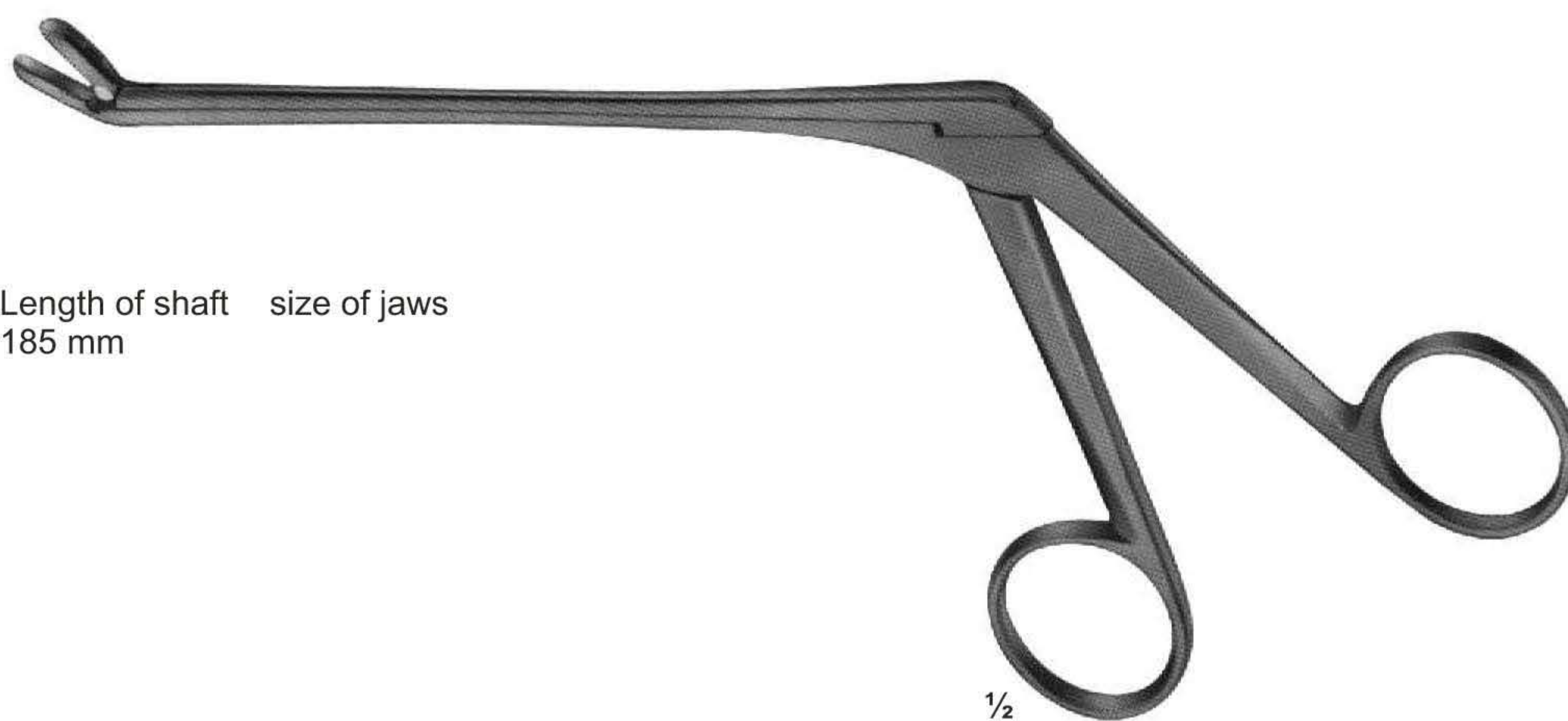

**UG-1496**  
CASPAR



# Rongeurs



**UG-1497**  
GUSHING

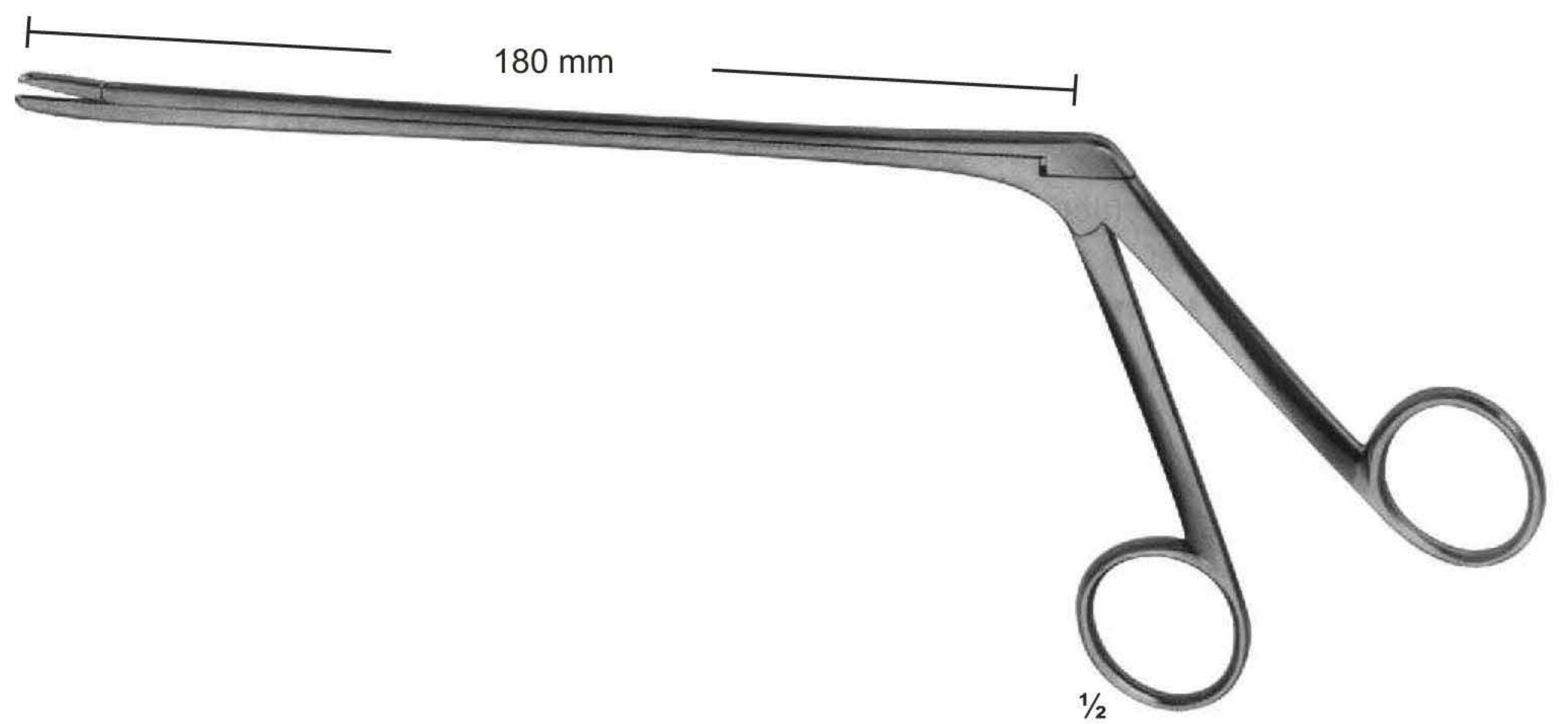

**UG-1498**  
LOVE-GRUENWALD

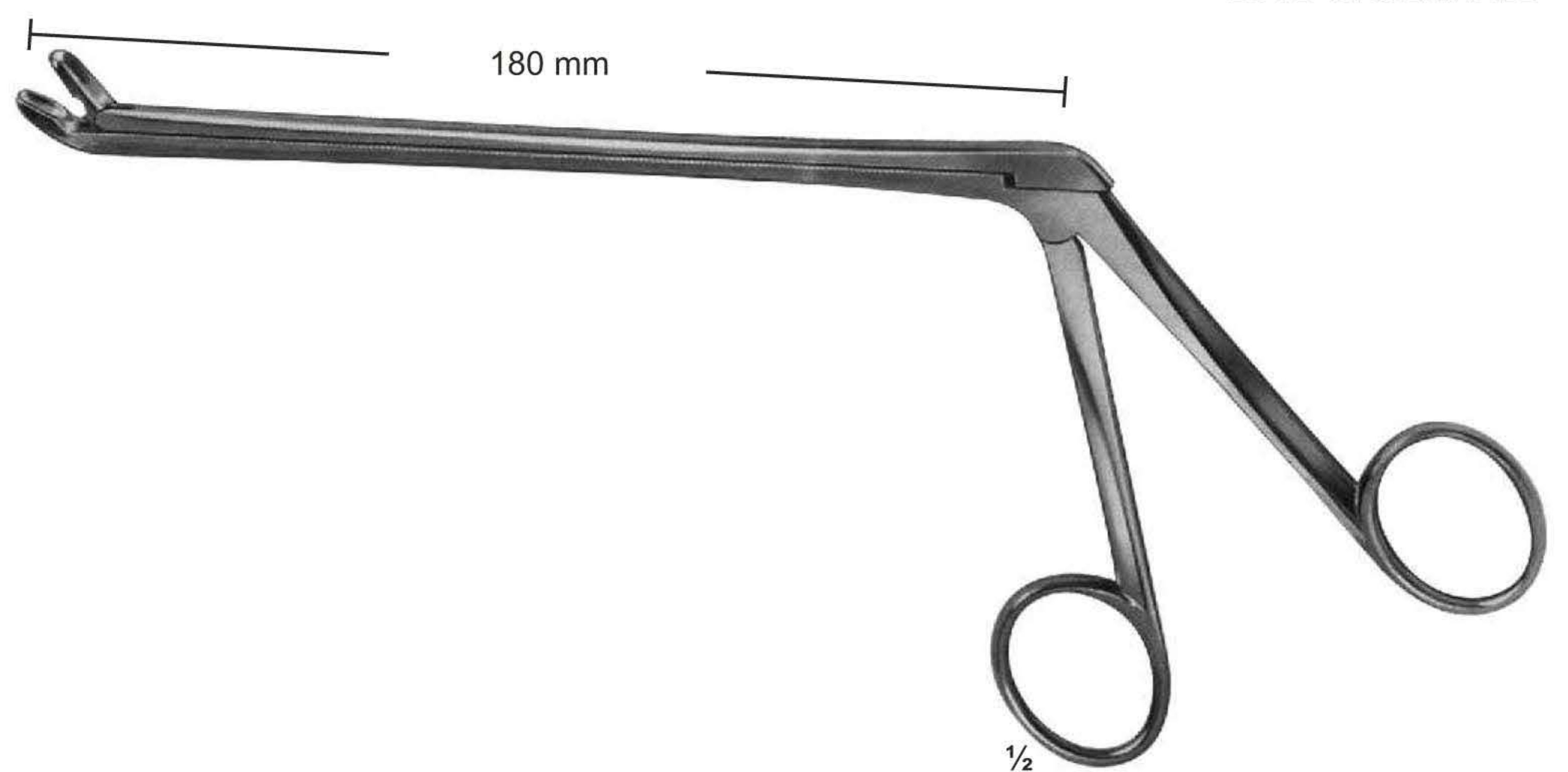

**UG-1499**  
LOVE-GRUENWALD

# Rongeurs

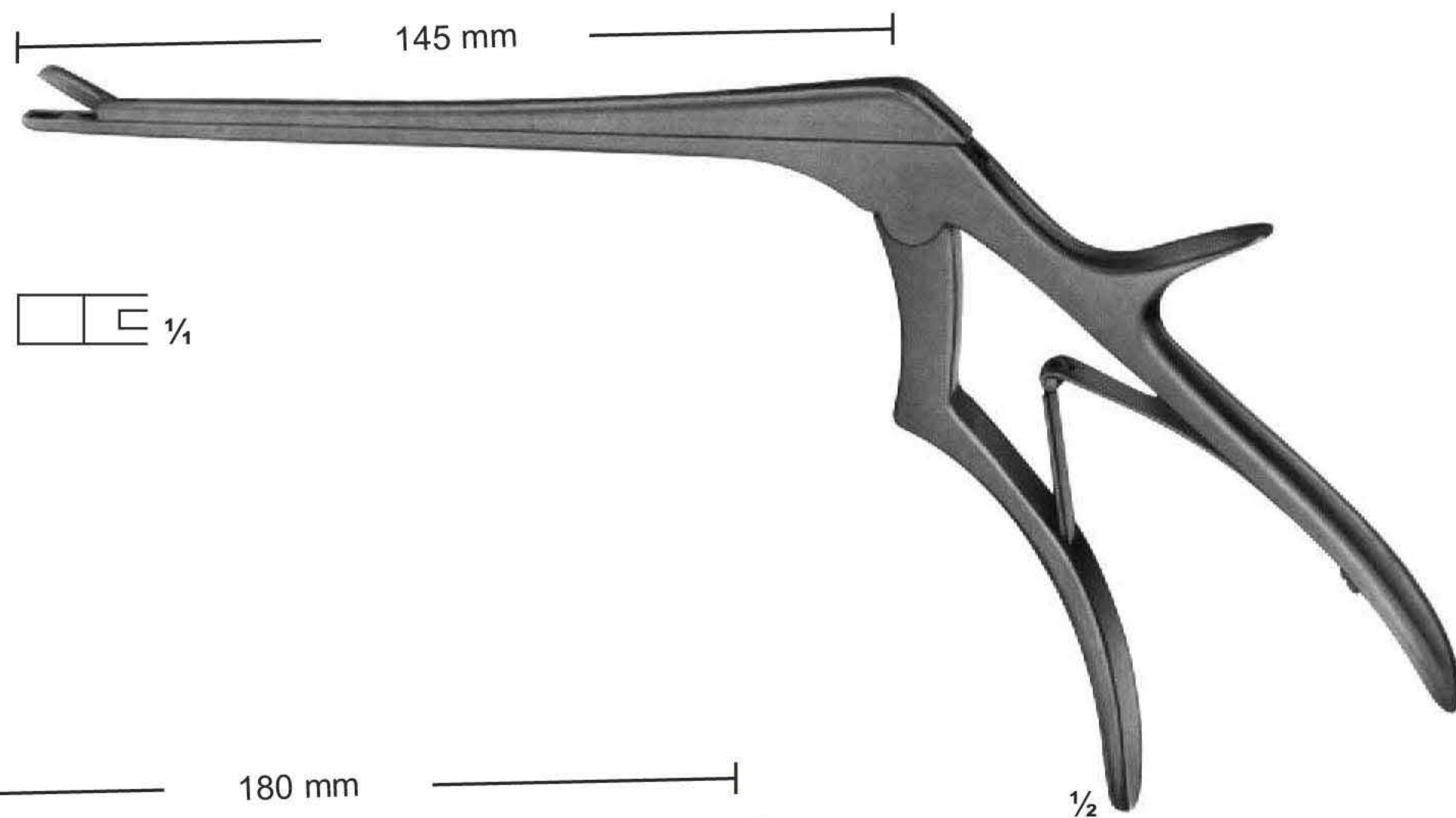

**UG-1503**  
CASPAR

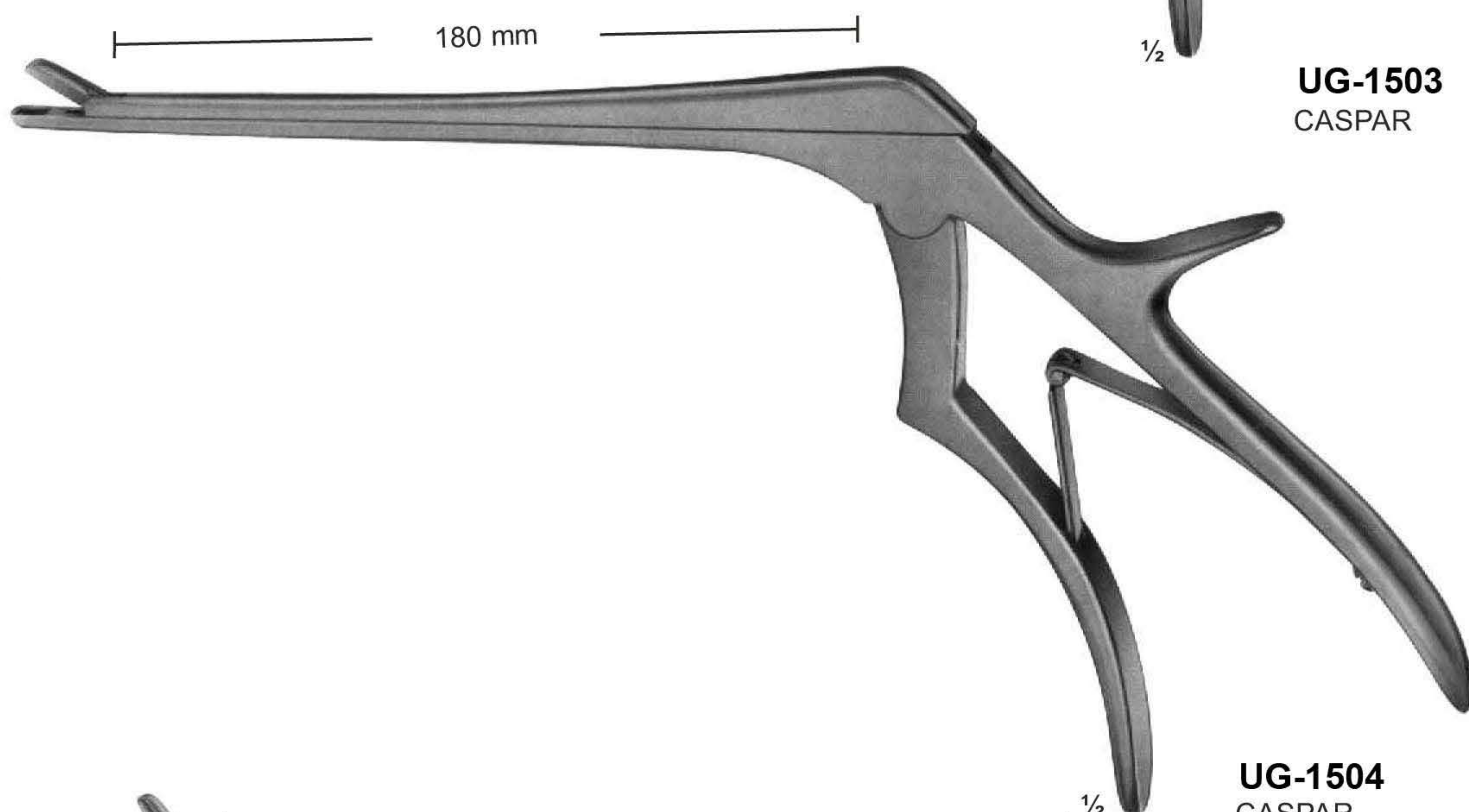

**UG-1504**  
CASPAR

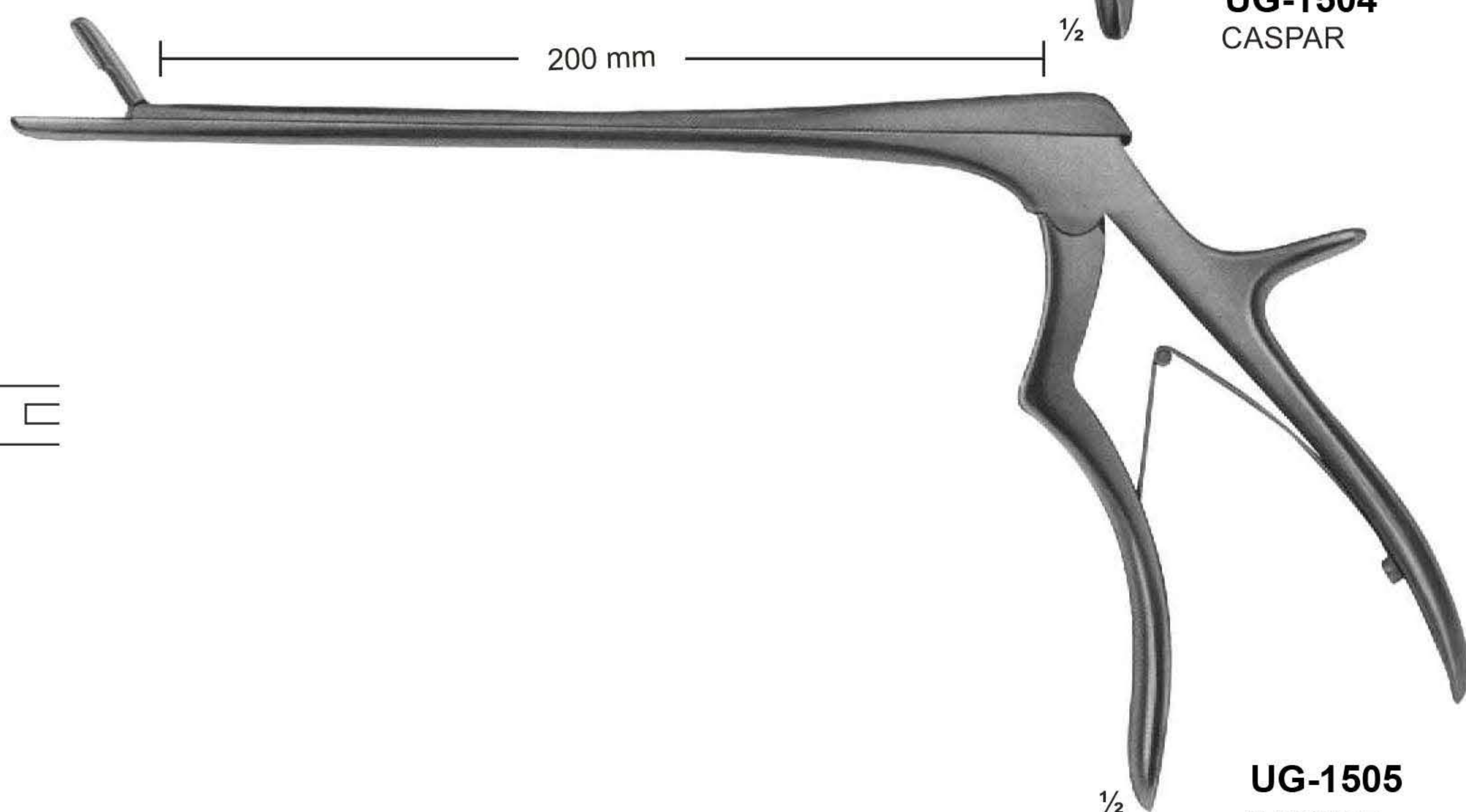

**UG-1505**  
WAGNER

18-180  
5,5 mm

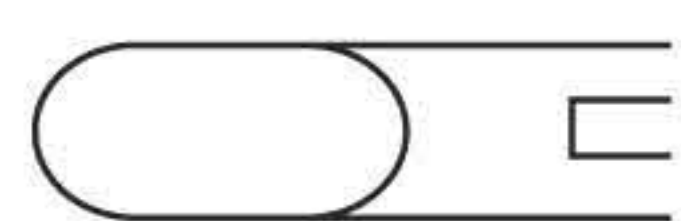

# Amputation

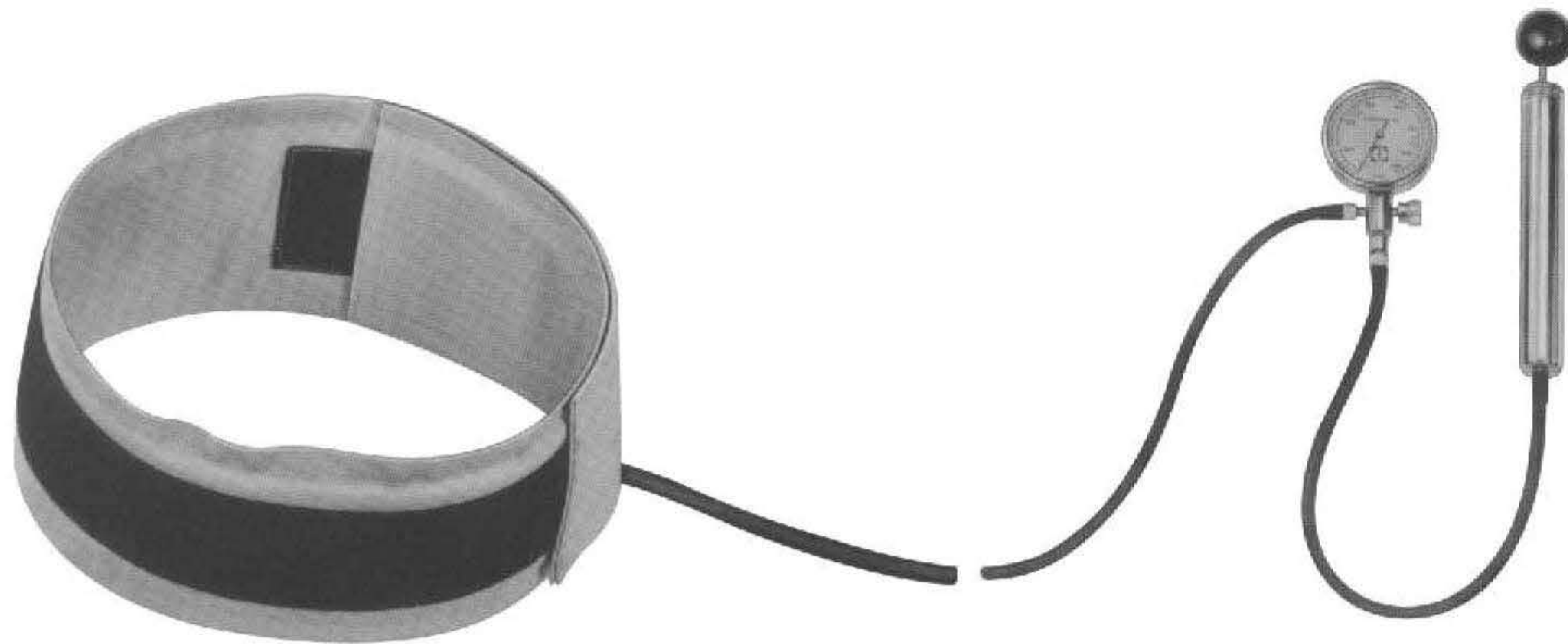

Comprimeter. Compression apparatus for producing exsanguination in the extremities. Manometer registers up to 600 mm Hg. Complete, consisting of:  
**UG-1506** 2 Pump with manometer  
**UG-1507** 3 Cuff for the leg  
**UG-1508** 14 Cuff for the upper arm

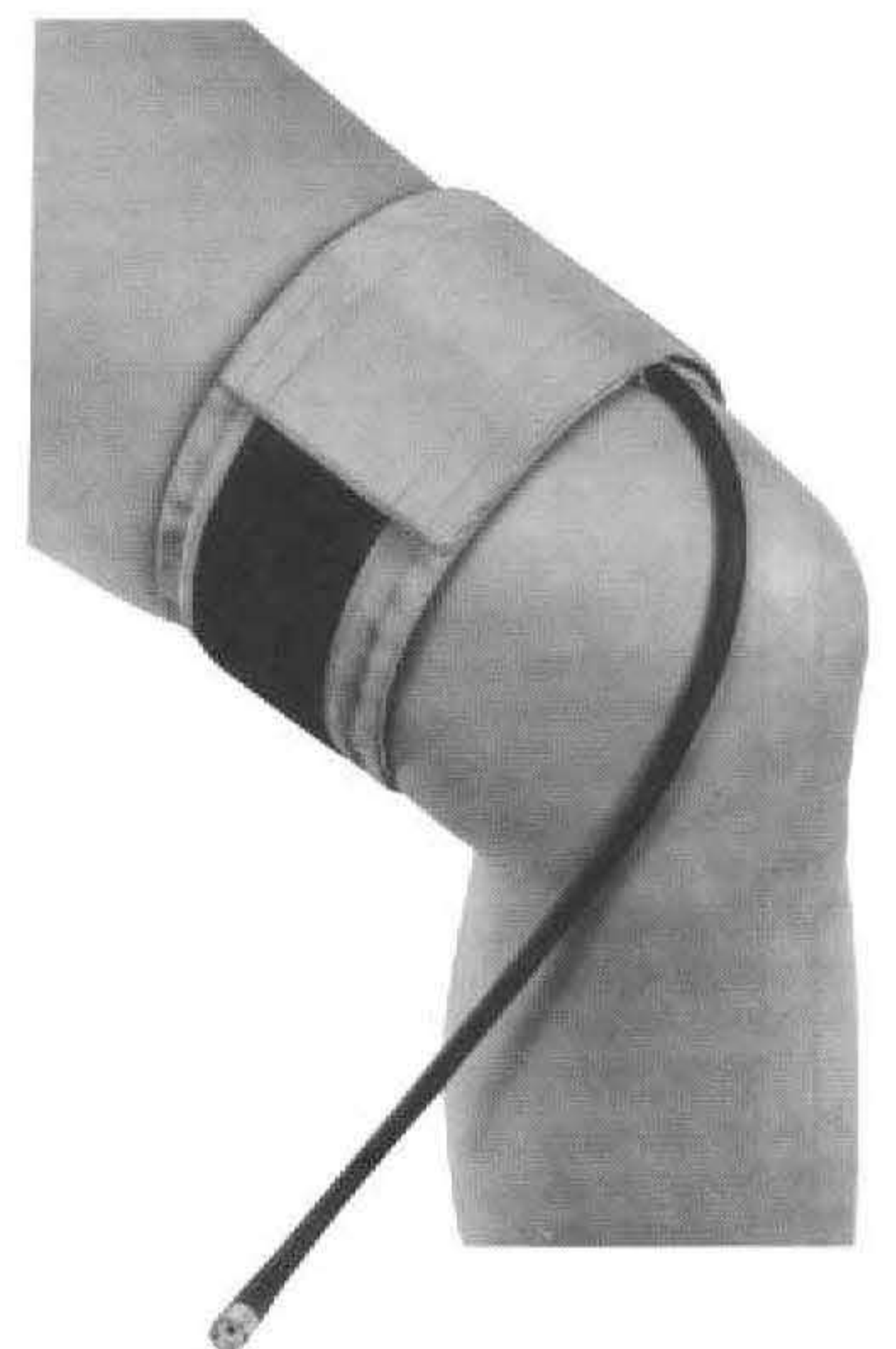
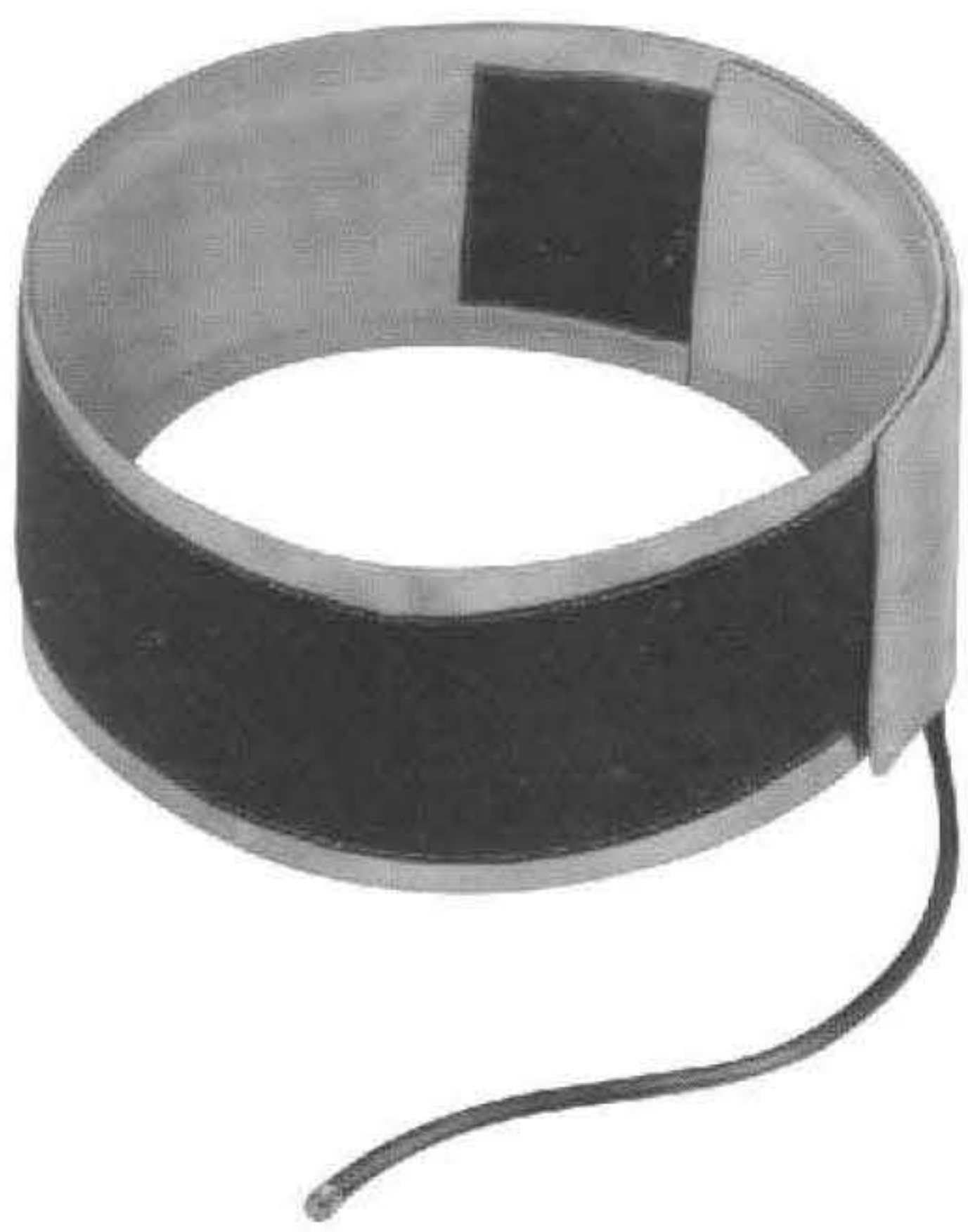

**UG-1509** 3 Cuff for the leg  
**UG-1510** 4 Cuff for the lower arm  
**UG-1511** 5 Cuff for children  
**UG-1512** 14 Cuff for the upper arm



**UG-1513**  
ESMARCH  
Staubinde  
Compression bandage  
5 m lang/long  
6 cm breit/wide



**UG-1514**  
ESMARCH  
Stauschlauch  
Compression tube  
1 m lang/long

# Amputation and Resection Knives



1/2

**UG-1515**  
Length of blades  
Phalangeal knife  
105 mm



1/2

**UG-1516**  
Length of blades  
Interosseous knife  
110 mm



1/2

**UG-1517**  
Length of blades  
Periosteum knife  
with raspatory  
65 mm



1/2

**UG-1518**  
LANGENBECK  
Length of blades  
Resection knives  
55 mm

# Amputation Retractors

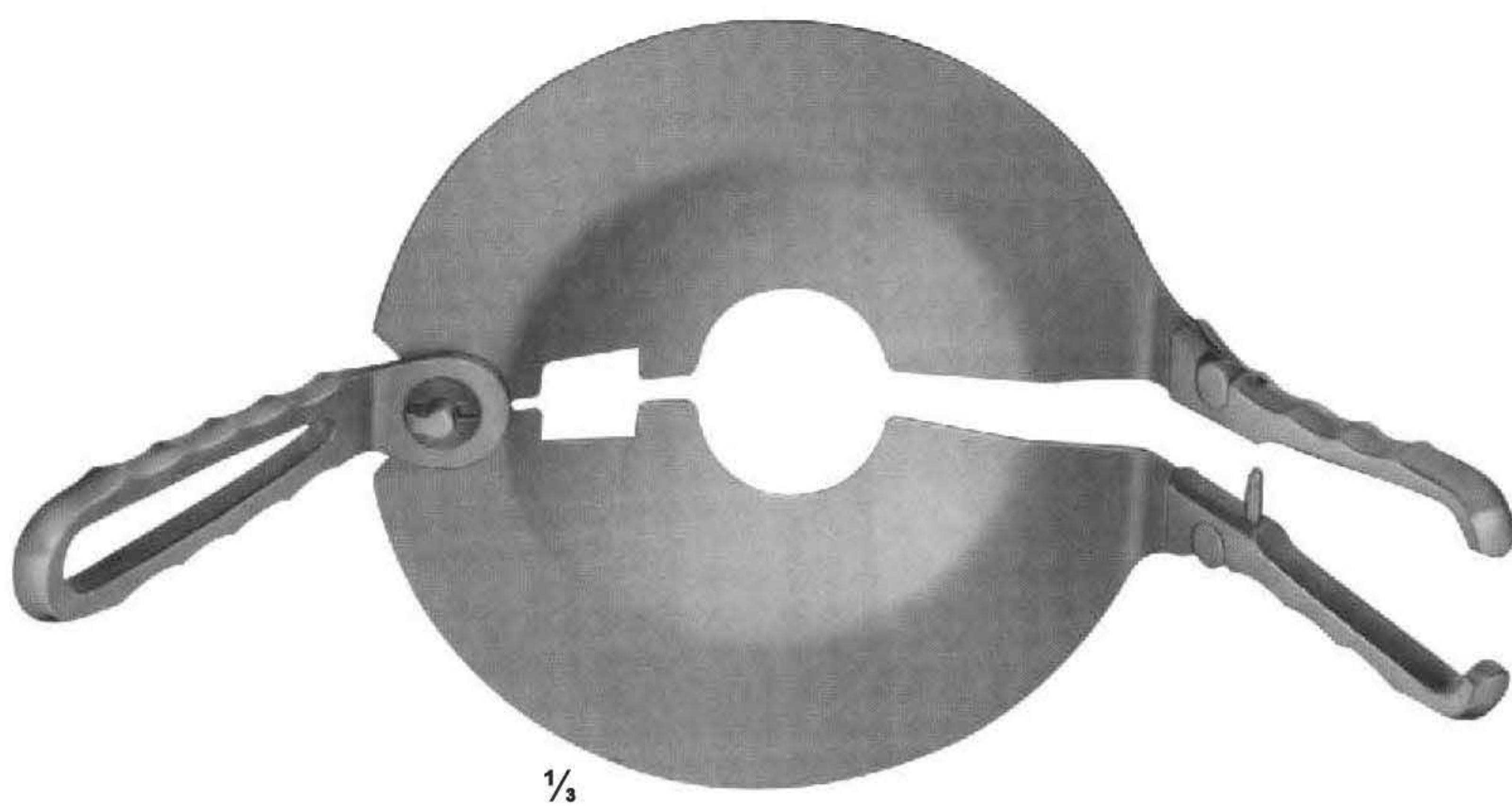

**UG-1519**  
PERCY  
removeable handles

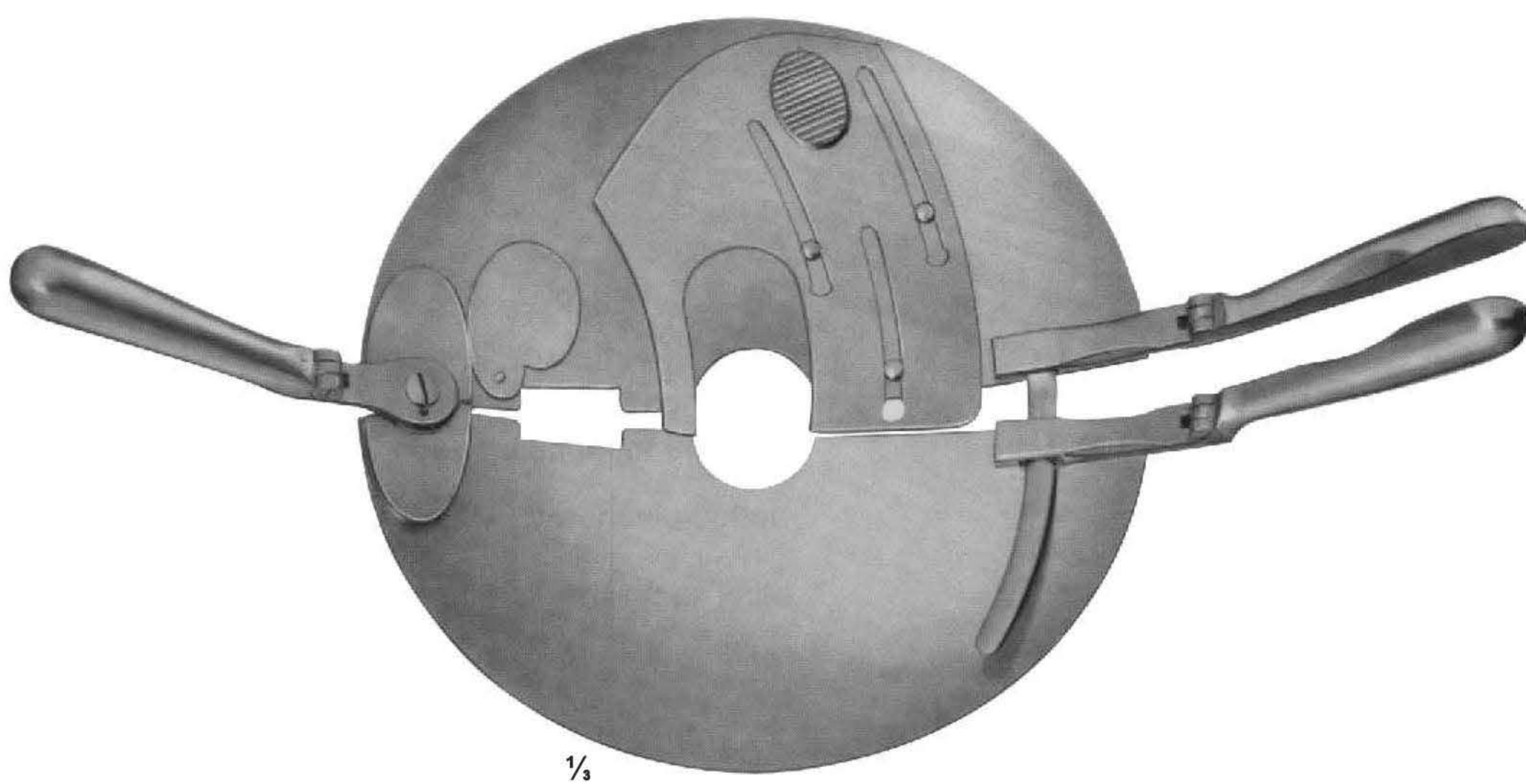

**UG-1520**  
PERCY  
reversible handles

# Amputation Saws



1/3

**UG-1521**  
**CHARRIEER**  
 Length of blade  
 215 mm  
 complete with one saw  
 blade each  
 350 mm  
 Spare saw blades, carbon steel  
**UG-1522** 12 mm  
**UG-1523** 20 mm

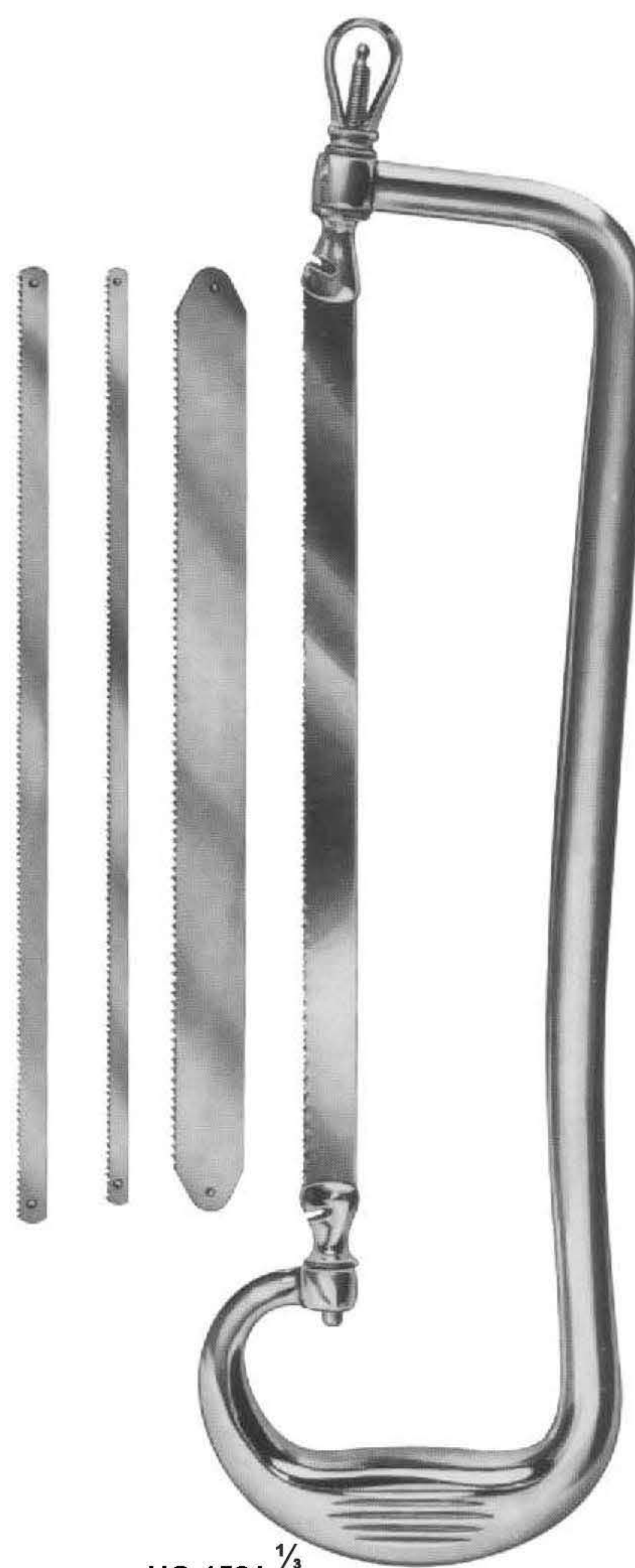

1/3

**UG-1524**  
**RUST**  
 Length of blade  
 235 mm  
 complete with one saw  
 blade each  
 390 mm  
**UG-1525** Bow only  
 Spare saw blades, carbon steel  
**UG-1526** 6 mm  
**UG-1527** 8 mm  
**UG-1528** 12 mm  
**UG-1529** 20 mm

# Amputation Saws

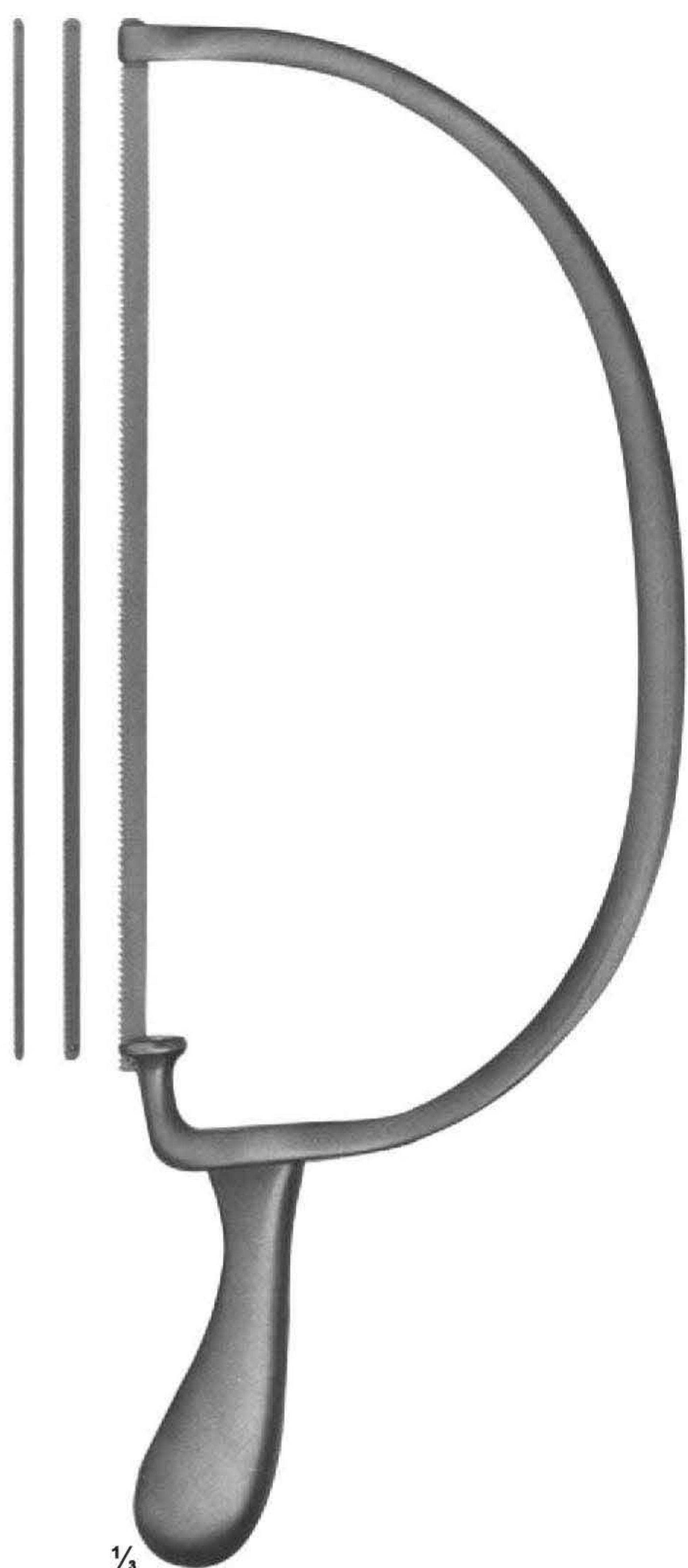

1/3

**UG-1530**  
**BIER**  
 Length of blade  
 270 mm  
 complete with one saw  
 blade each  
 420 mm  
 Spare saw blades, carbon steel  
**UG-1531** 4 mm  
**UG-1532** 6 mm  
**UG-1533** 8 mm



1/3

**UG-1534**  
**CHARRIERE**  
 Length of blade  
 180 mm  
 Spare saw blades,  
 carbon steel  
 270 mm

**UG-1535**  
**CHARRIERE**  
 Length of blade  
 240 mm  
 Spare saw blades,  
 carbon steel  
 340 mm



1/3

**UG-1536**  
**SATTERLEE**  
 Length of blade  
 200 mm  
 Spare saw blades,  
 carbon steel  
 290 mm



1/3

**UG-1537**  
**LANGENBACK**  
 Length of blade  
 115 mm  
 Metacarpal saw  
 235 mm

# Wire Saws and Conductor

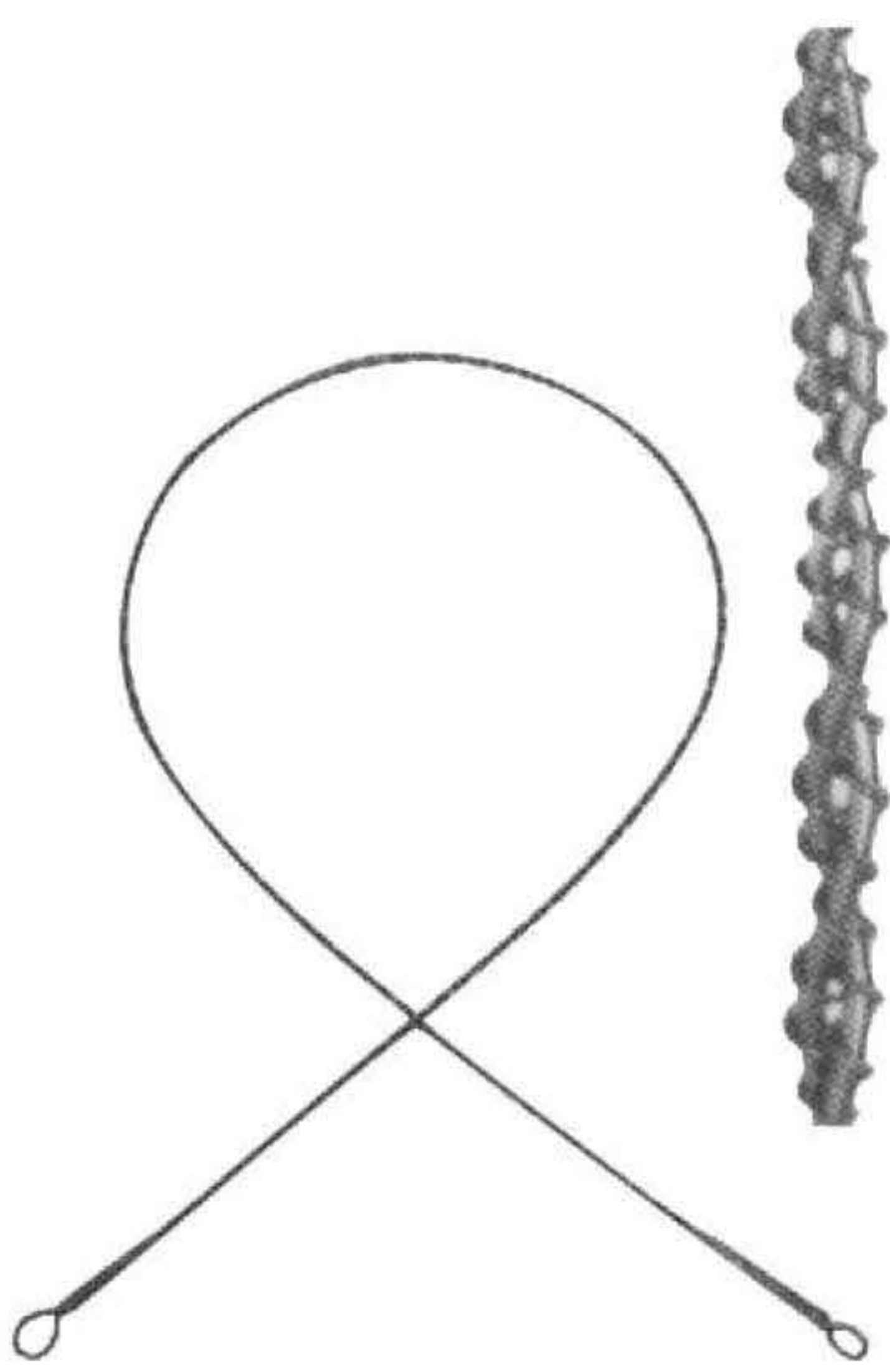

OLIVECRONA  
**UG-1538** 300 mm  
**UG-1539** 400 mm  
**UG-1540** 500 mm  
**UG-1541** 700 mm

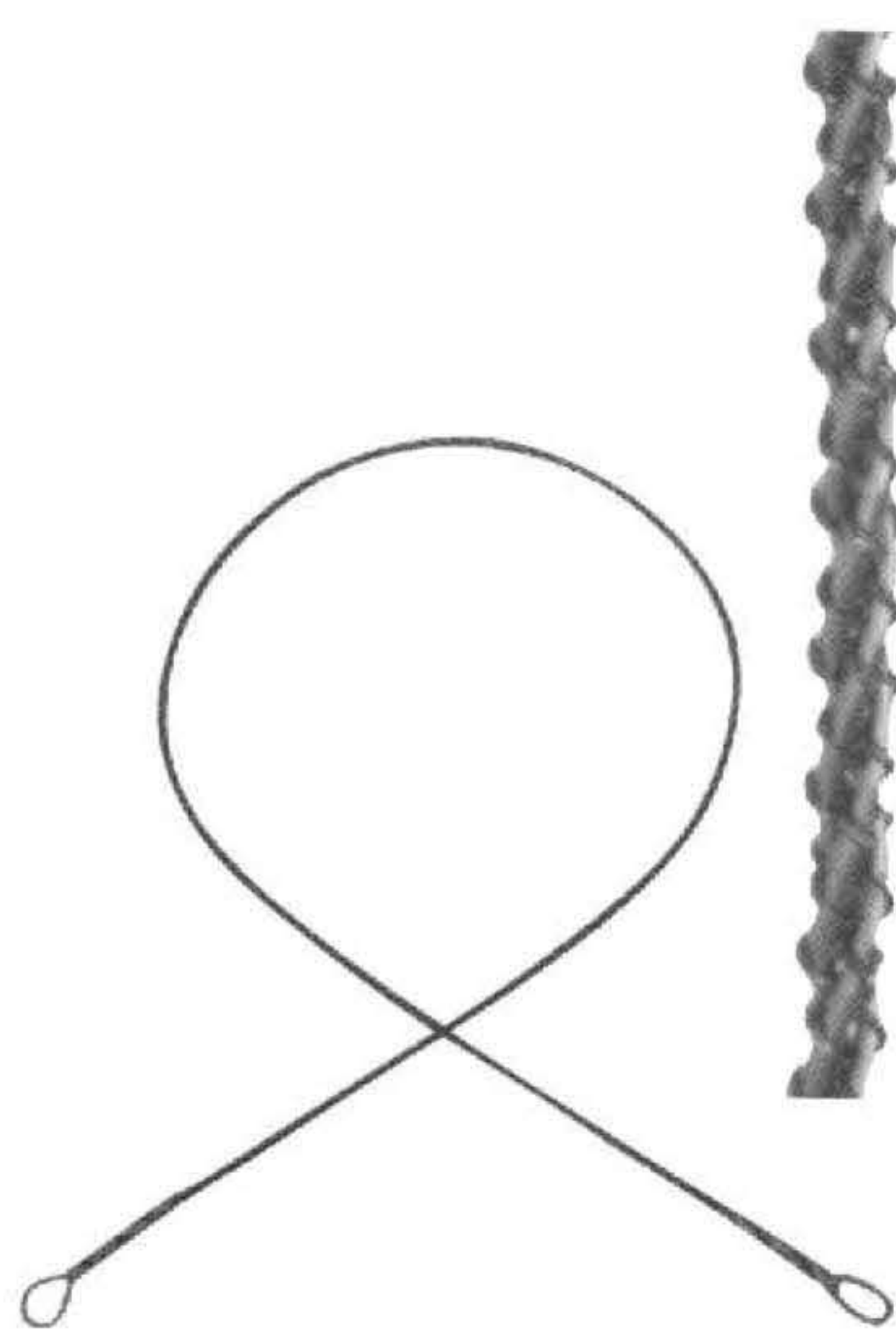

GIGLI  
**UG-1542** 300 mm  
**UG-1543** 400 mm  
**UG-1544** 500 mm  
 fine, 6 wires twisted  
**UG-1545**  
 coares, 4 wires twisted



**UG-1546**  
 GIGLI  
 Handle



**UG-1547**  
 LEBSCHE  
 Conductor for  
 wire saws, malleable  
 250 mm



# Elevators and Bone Levers



**UG-1548**  
KONIG  
155 mm



**UG-1549**  
WILLIGER  
165 mm



**UG-1550**  
WILLIGER  
170 mm

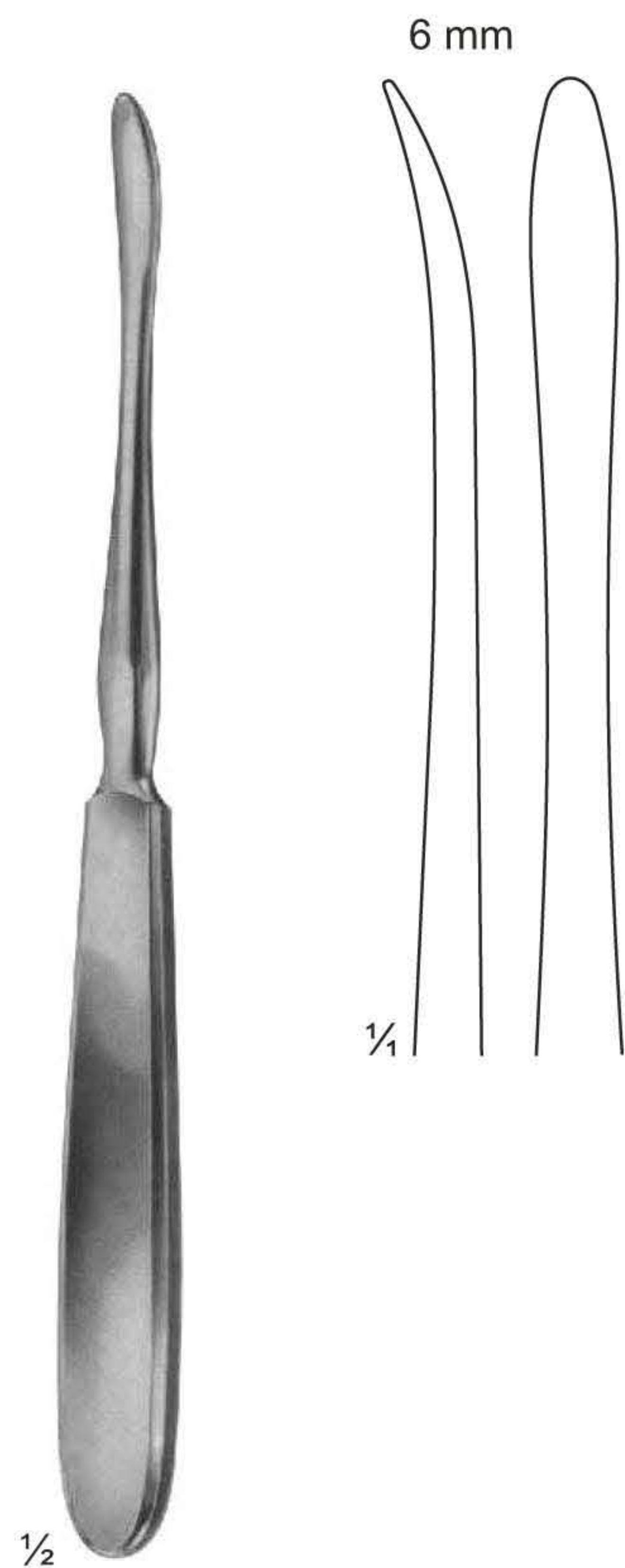

**UG-1551**  
QUERVAIN  
195 mm



**UG-1552**  
LANGENBACK  
195 mm

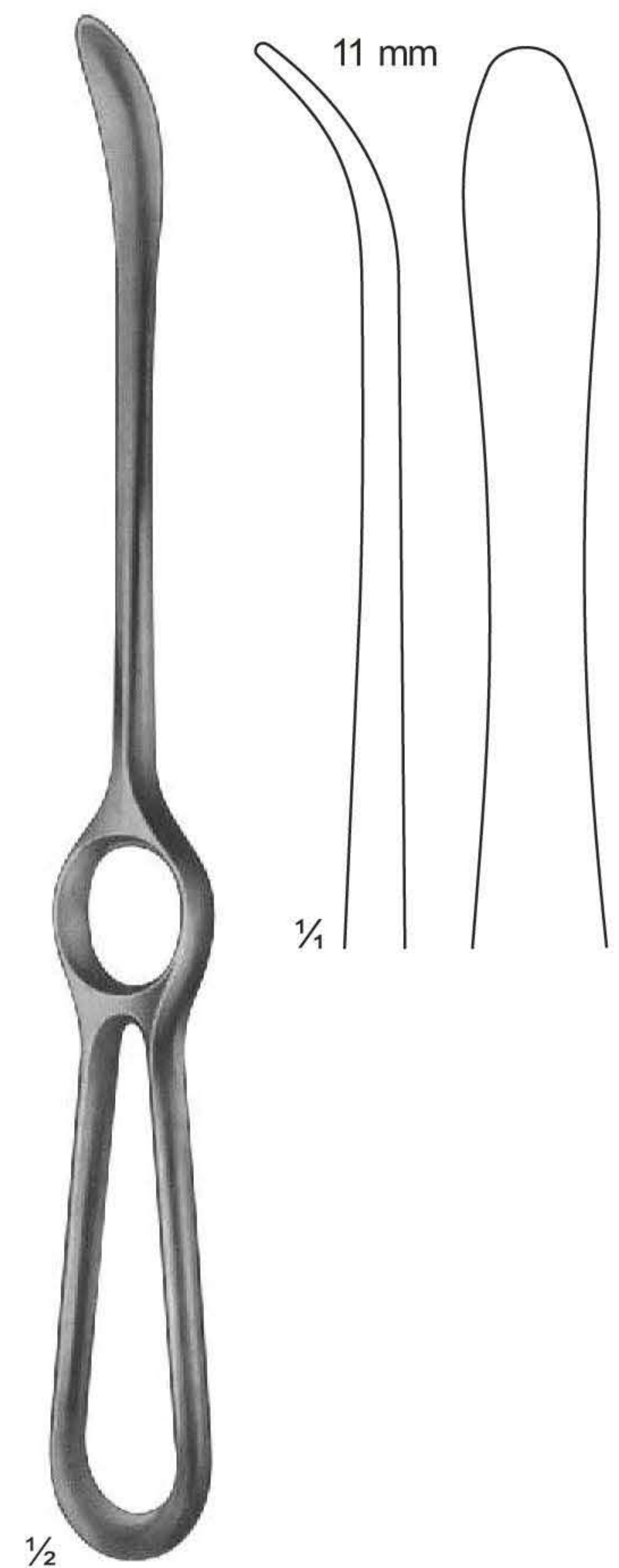

**UG-1553**  
LANGENBACK  
230mm

# Bone Levers

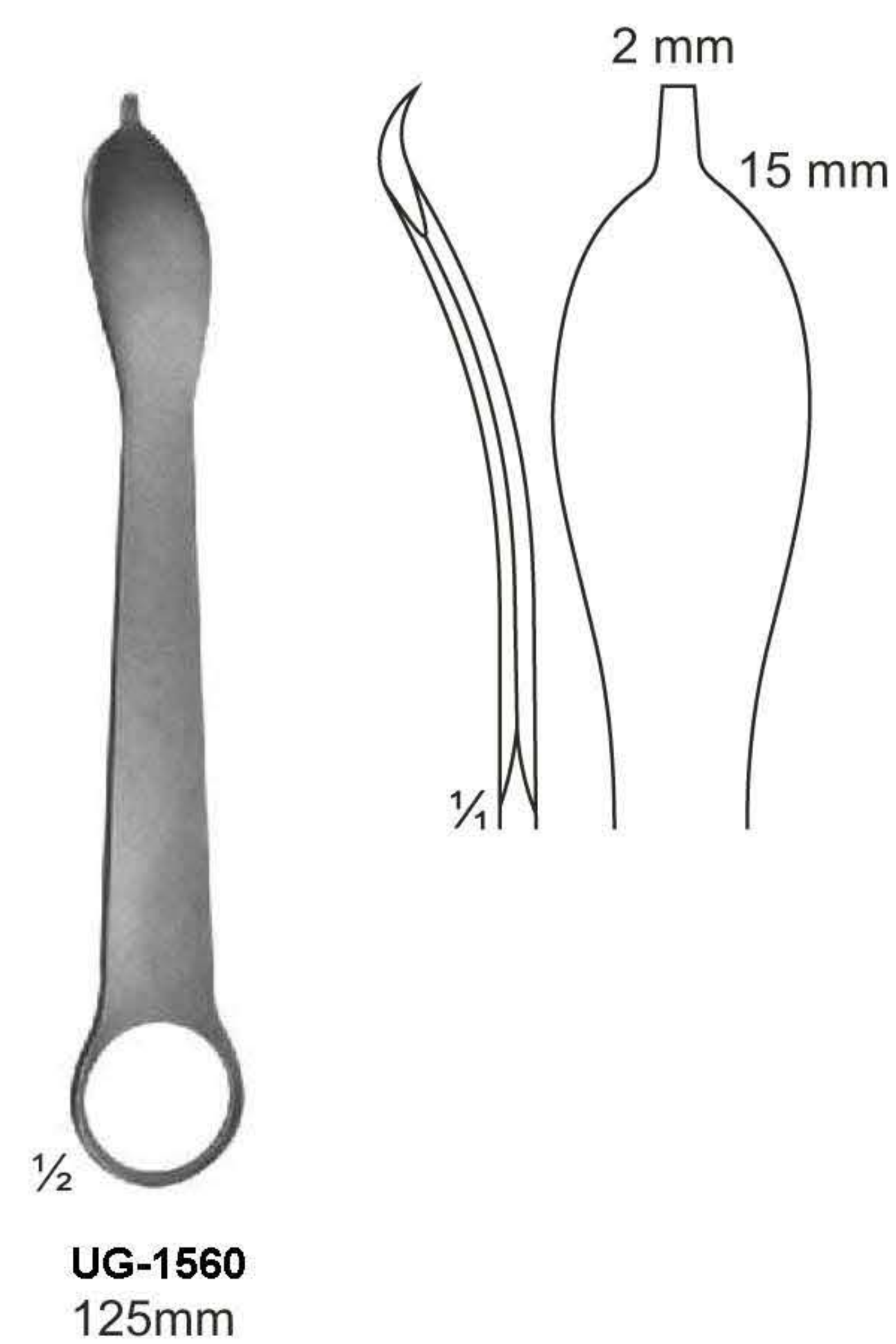
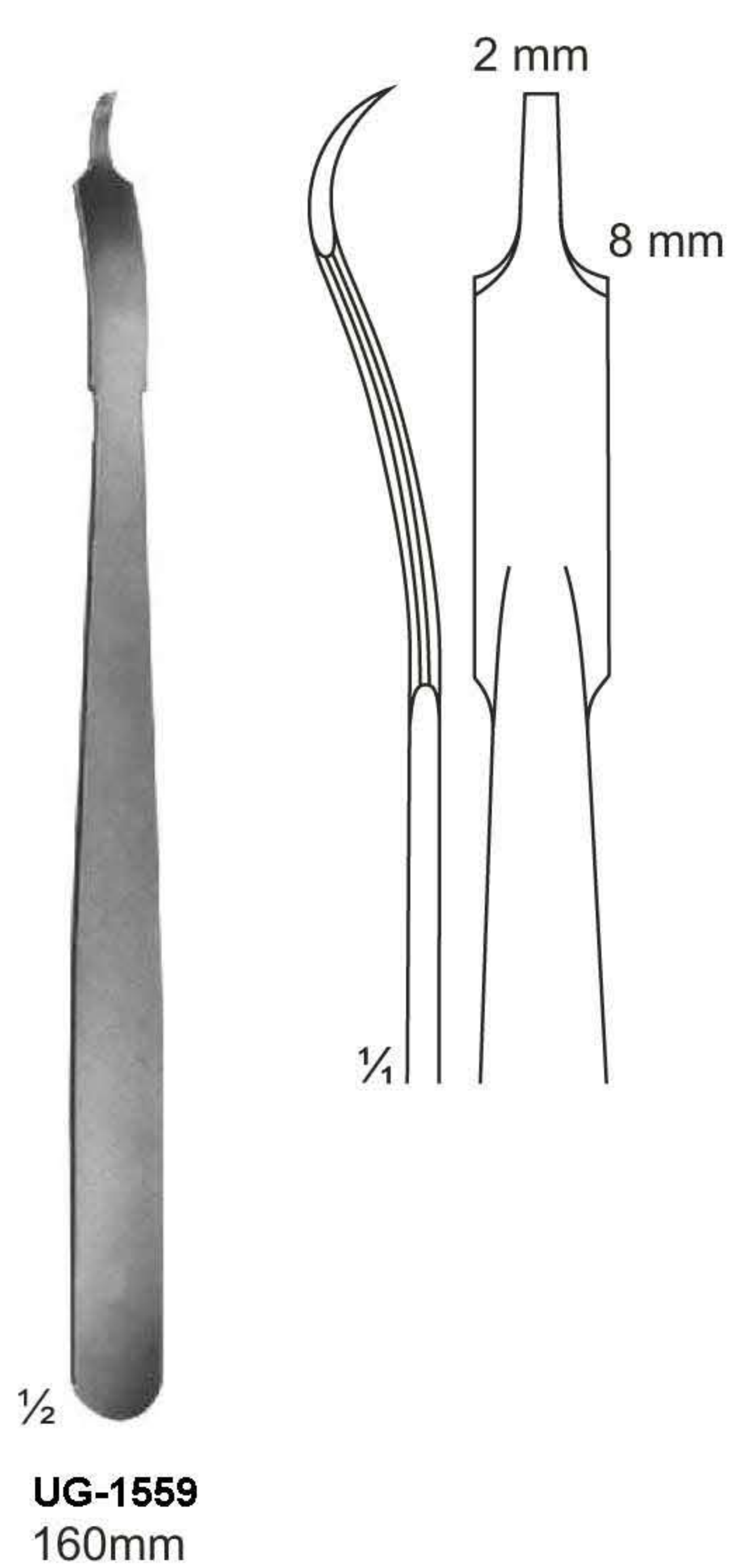
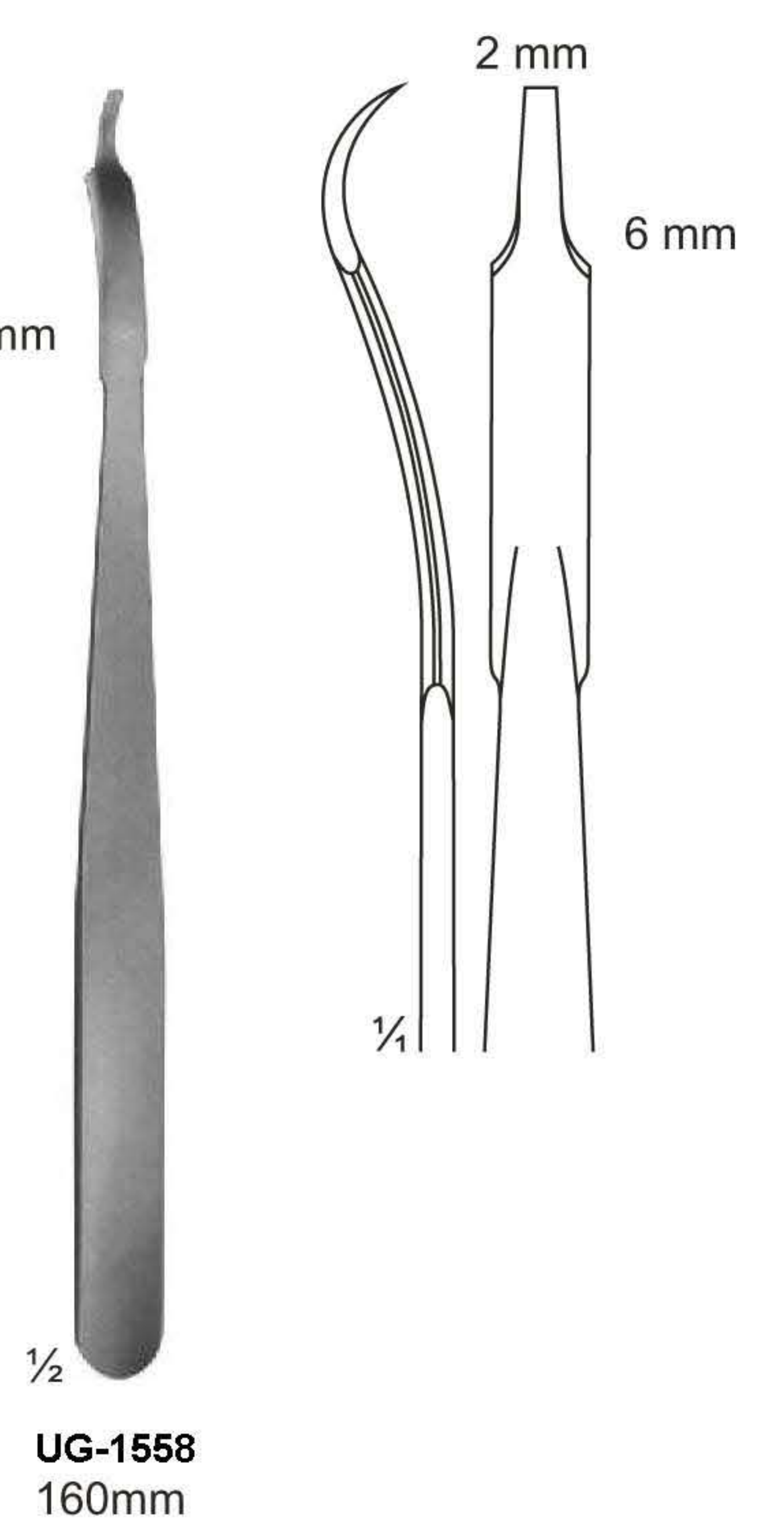
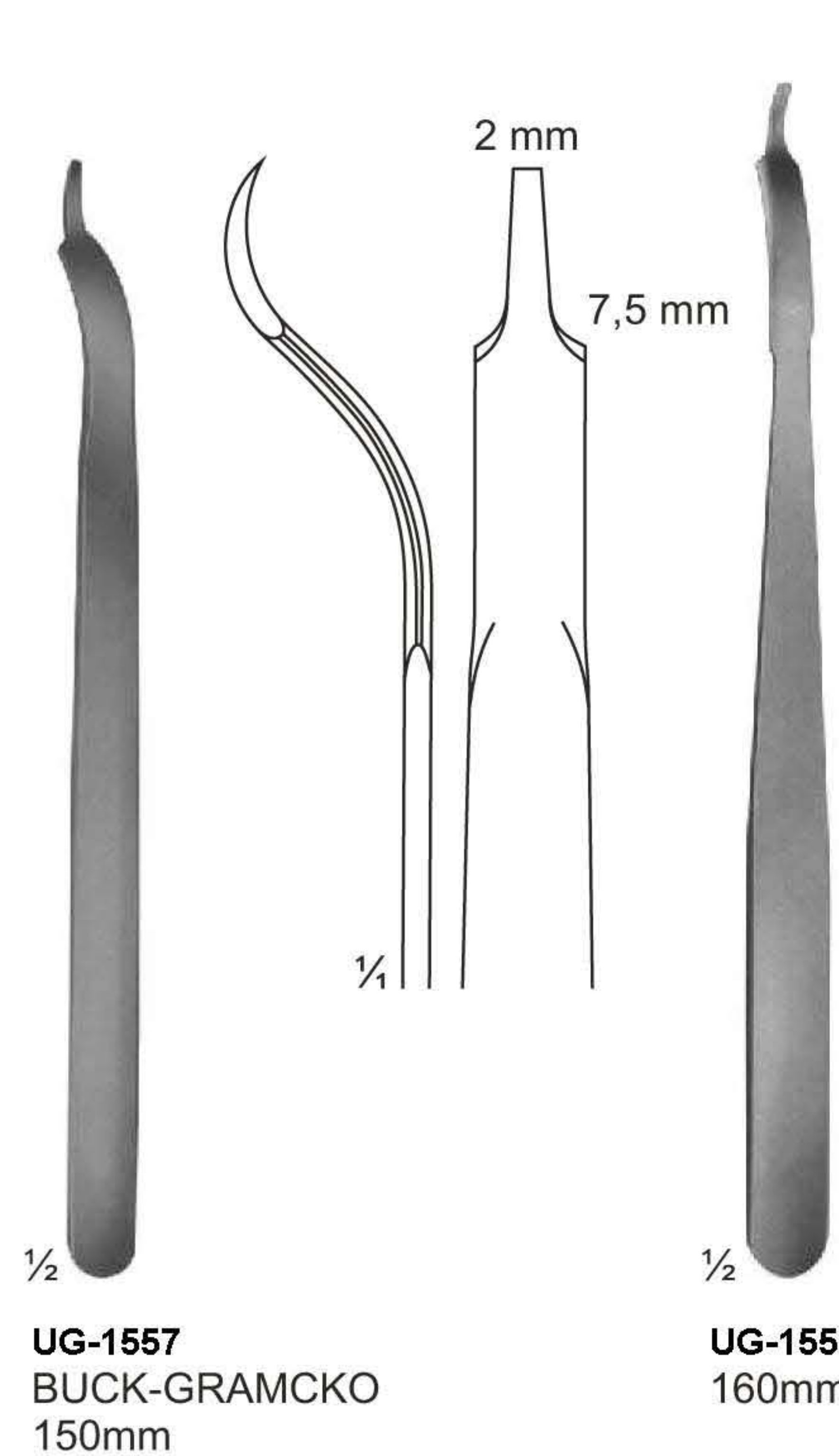
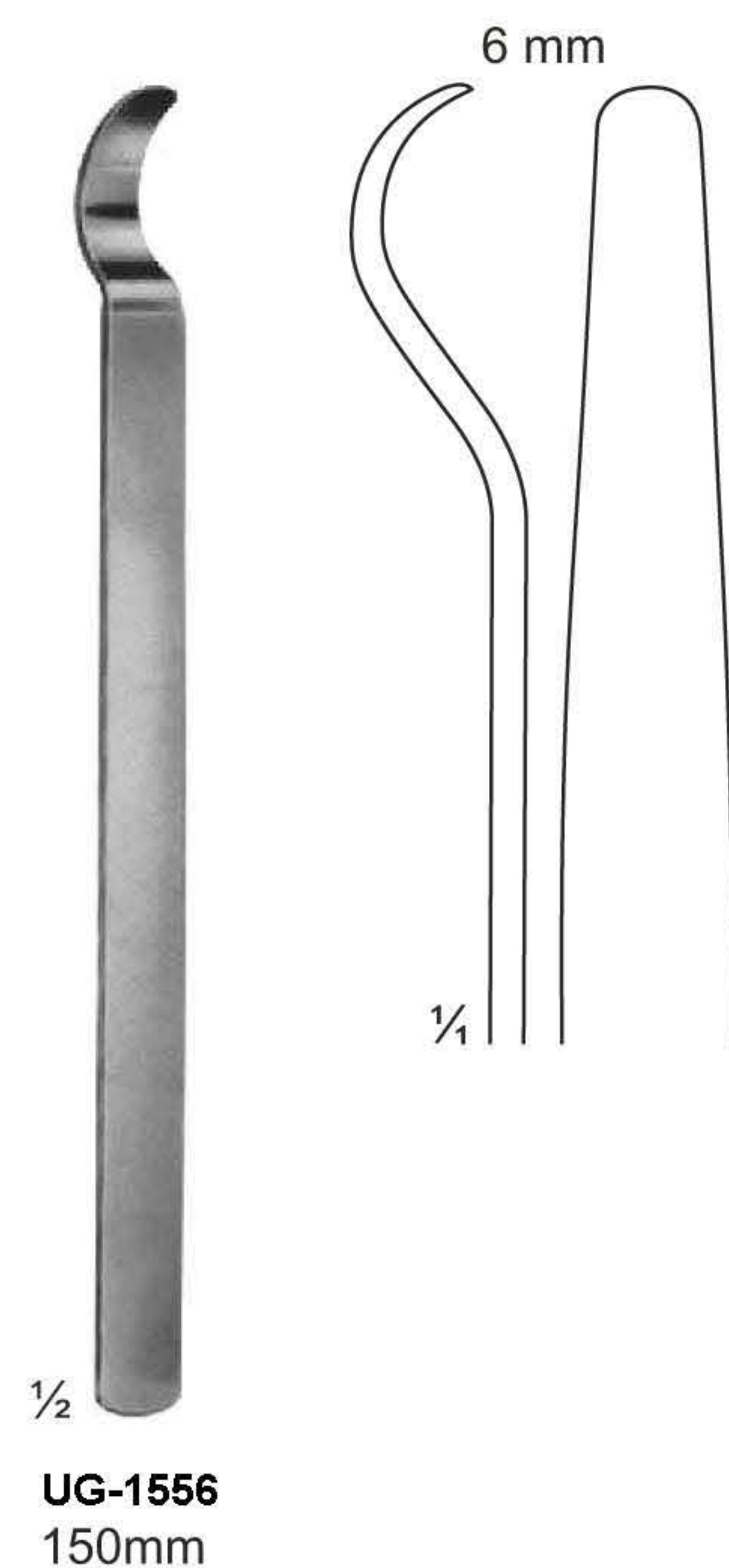
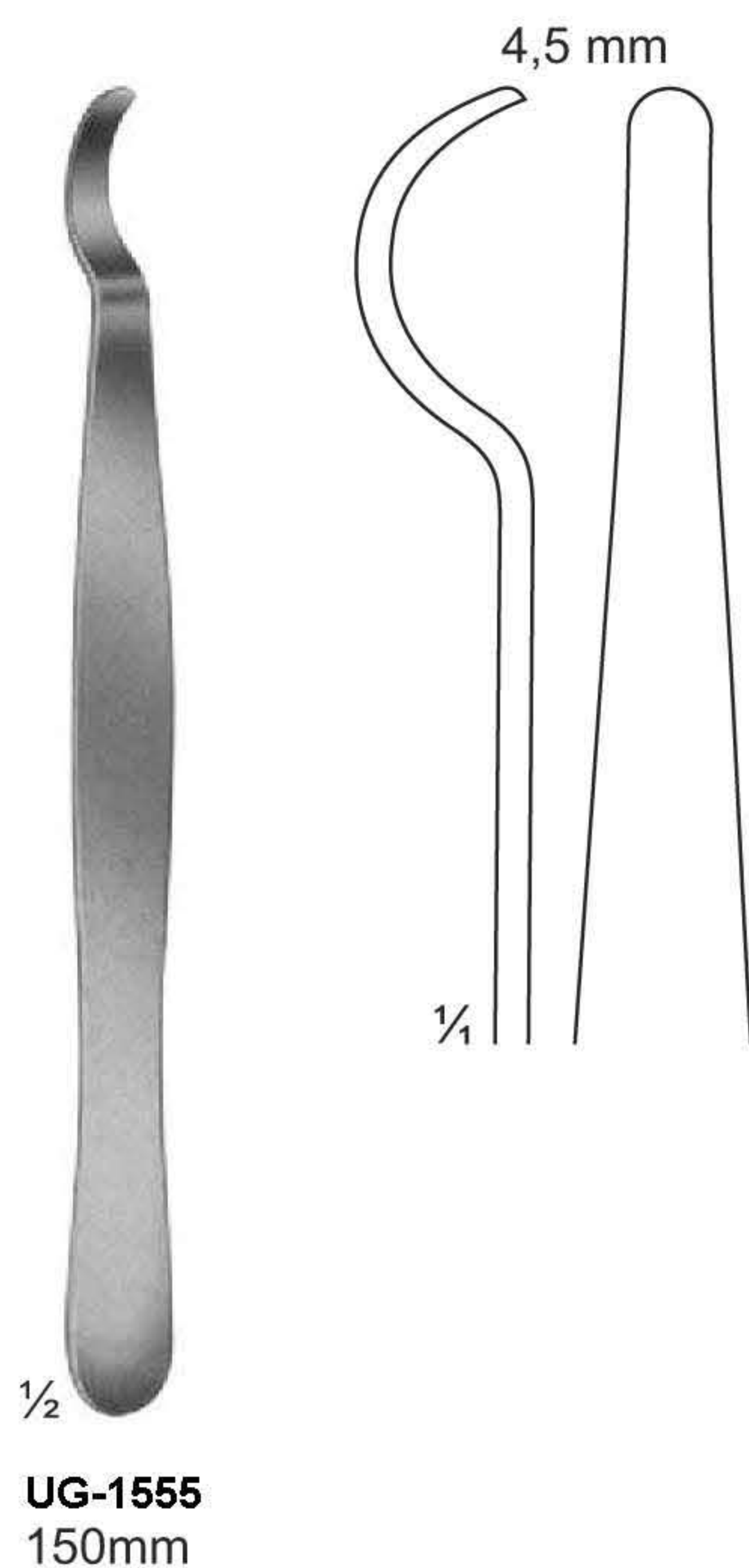
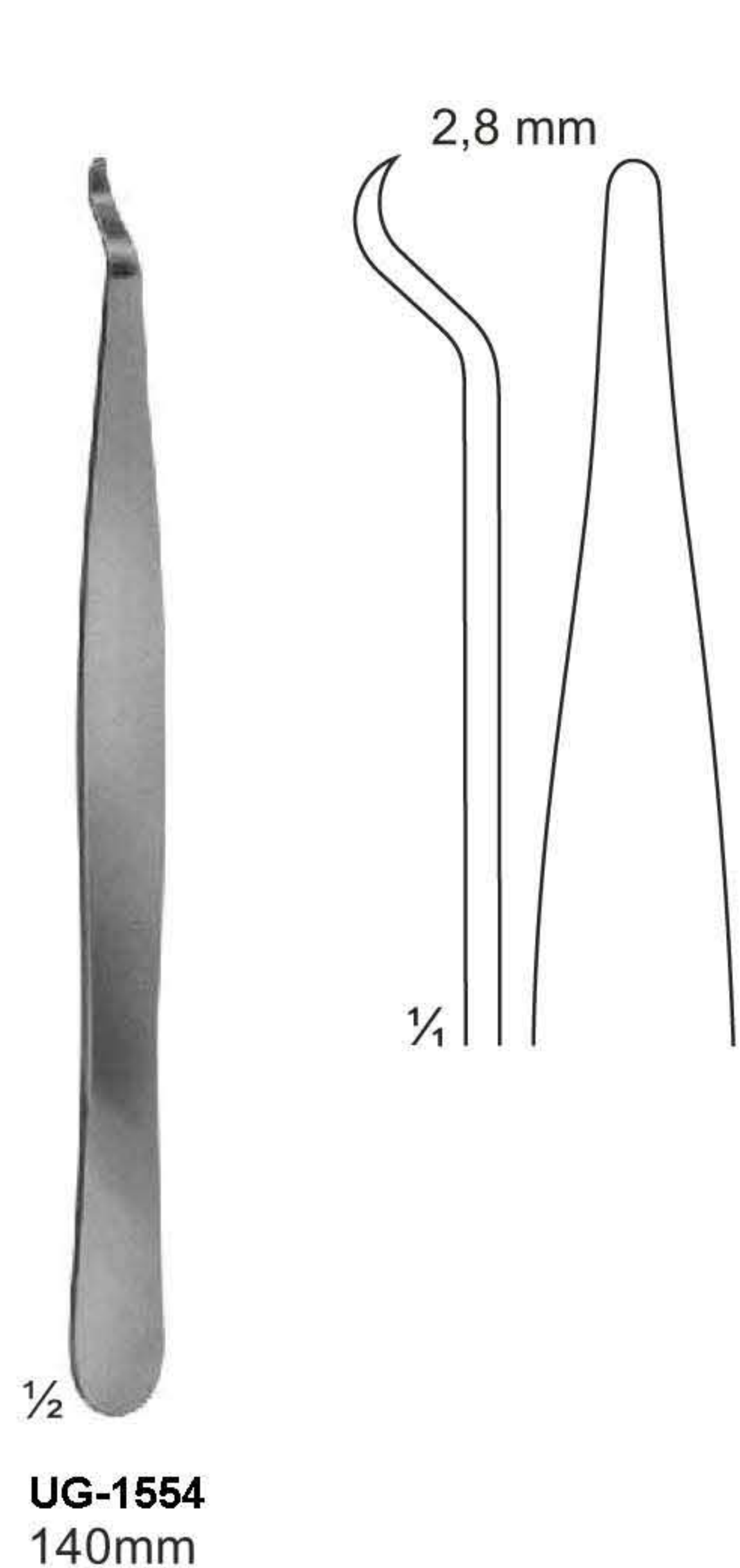

# Bone Levers



**UG-1561**  
LANE TRETOWAN  
215mm

**UG-1562**  
LANE  
255mm

**UG-1563**  
LANGE-HOHMANN  
250mm

**UG-1564**  
LANGE-HOHMANN  
**UG-1565** 265mm  
280mm

# Bone Levers

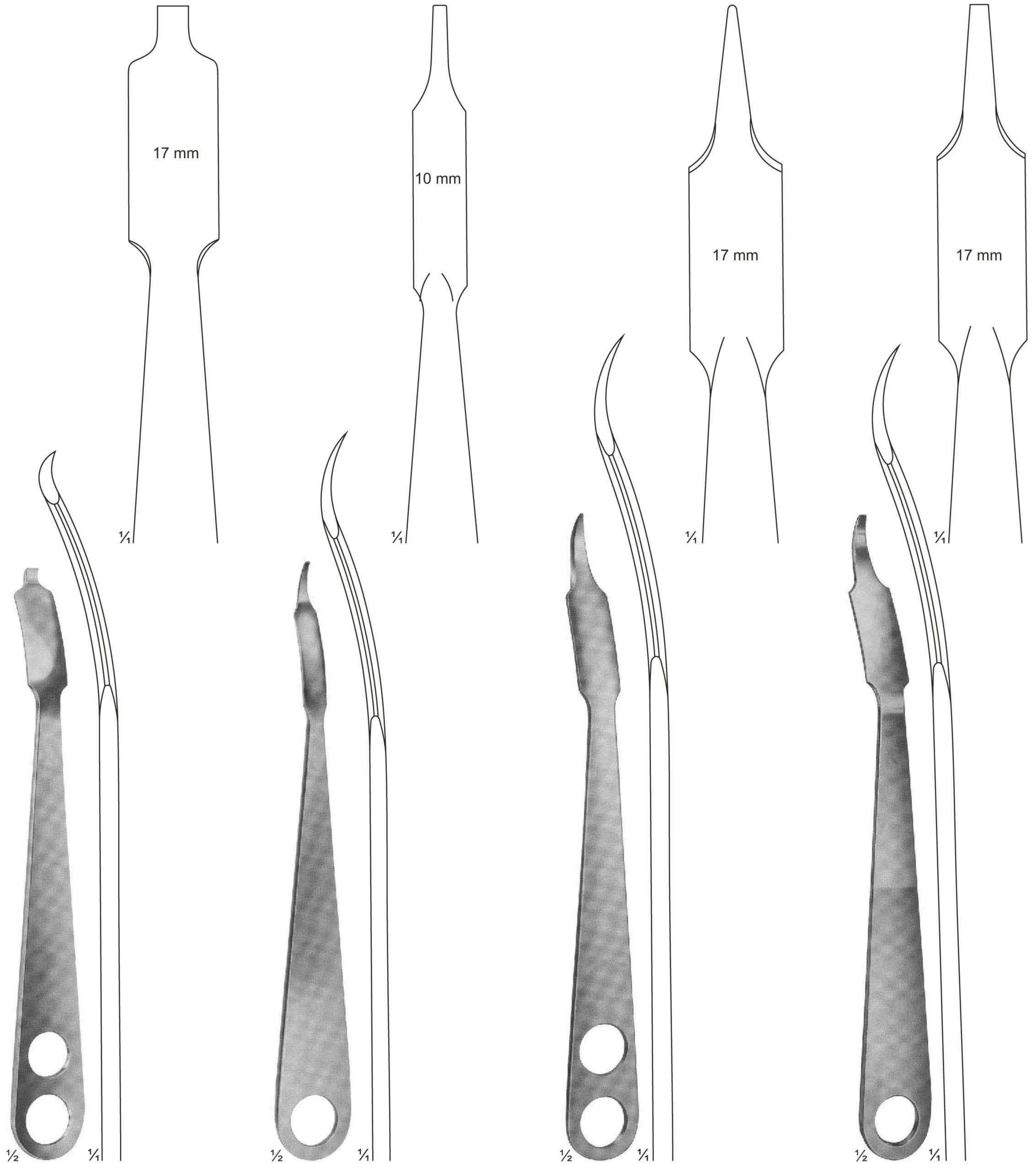

**UG-1566**  
WAGNER  
220 mm

**UG-1567**  
220 mm

**UG-1568**  
240 mm

**UG-1569**  
240 mm

# Bone Levers

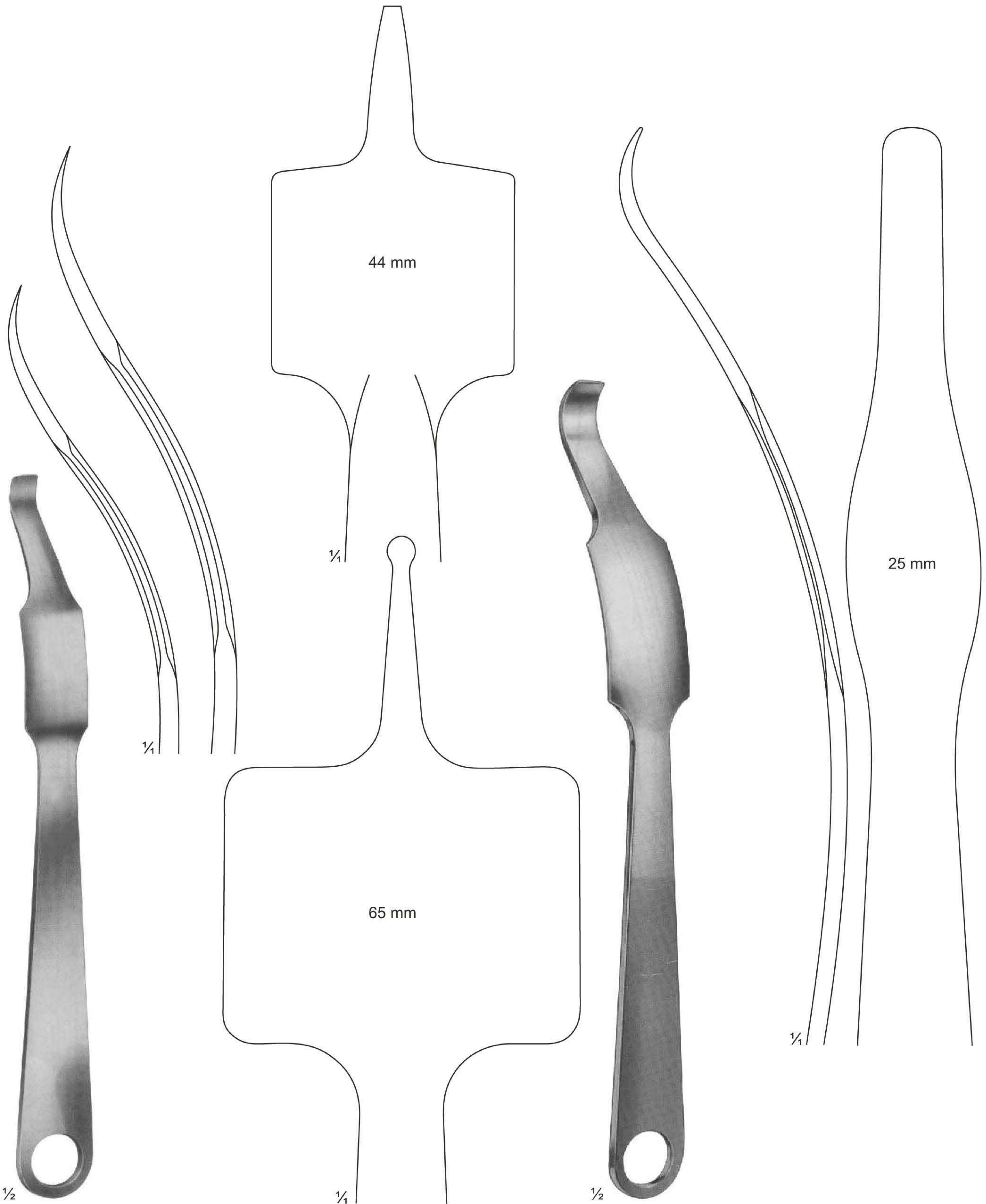

**UG-1570**  
 VERBRUGGE-MULLER  
**UG-1571** 240 mm  
 255 mm

**UG-1572**  
 260 mm

# Bone Levers

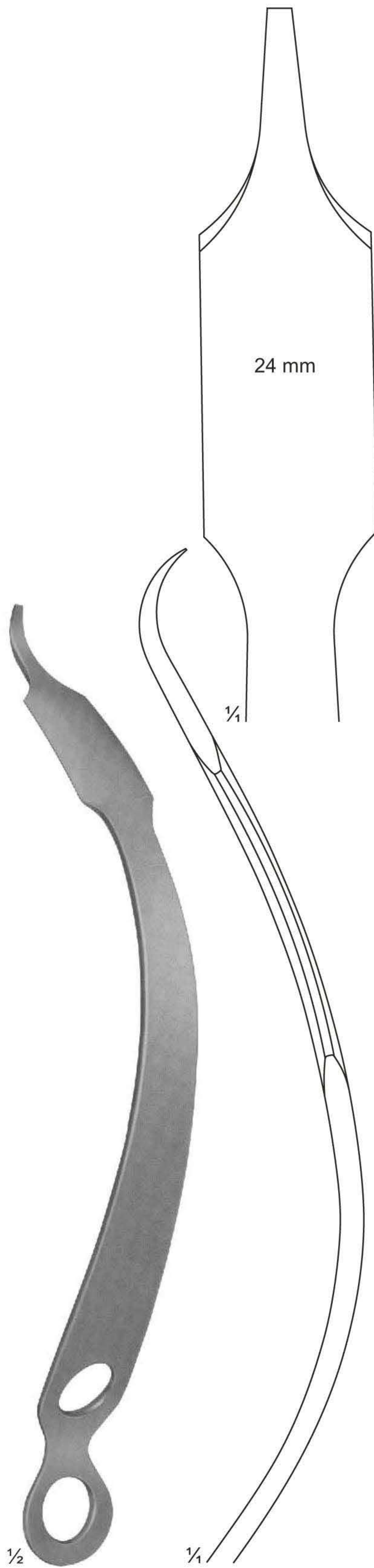

**UG-1573**  
HOHMANN-ALDINGER  
270 mm

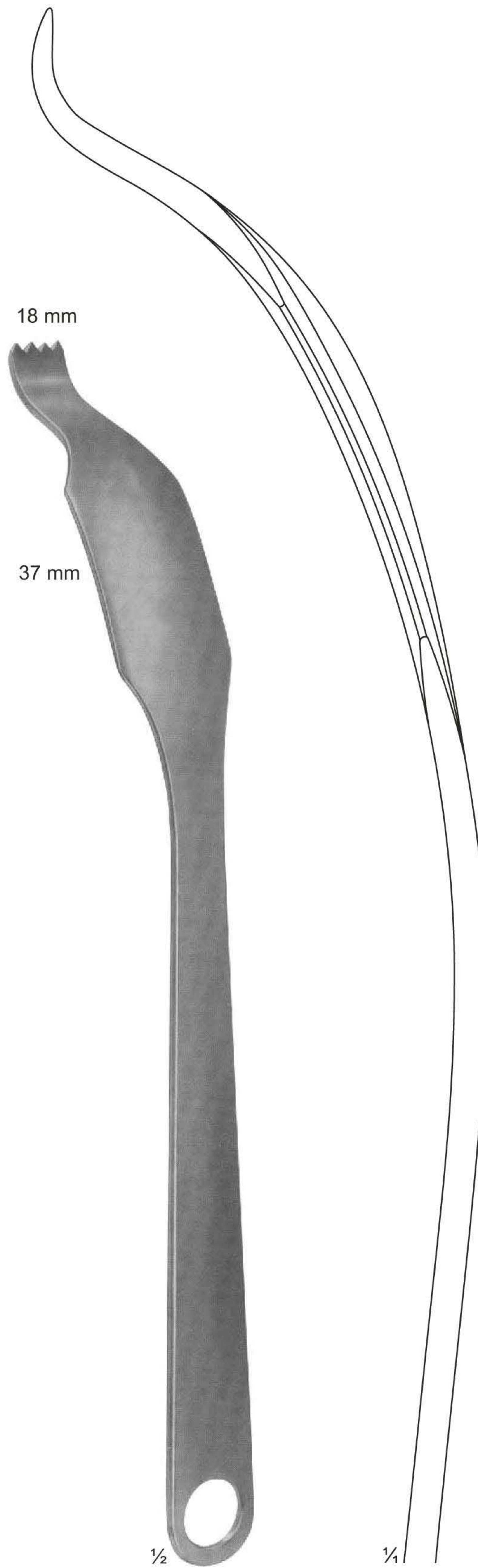

**UG-1574**  
SCHUMACHER mod. WAGNER  
345 mm

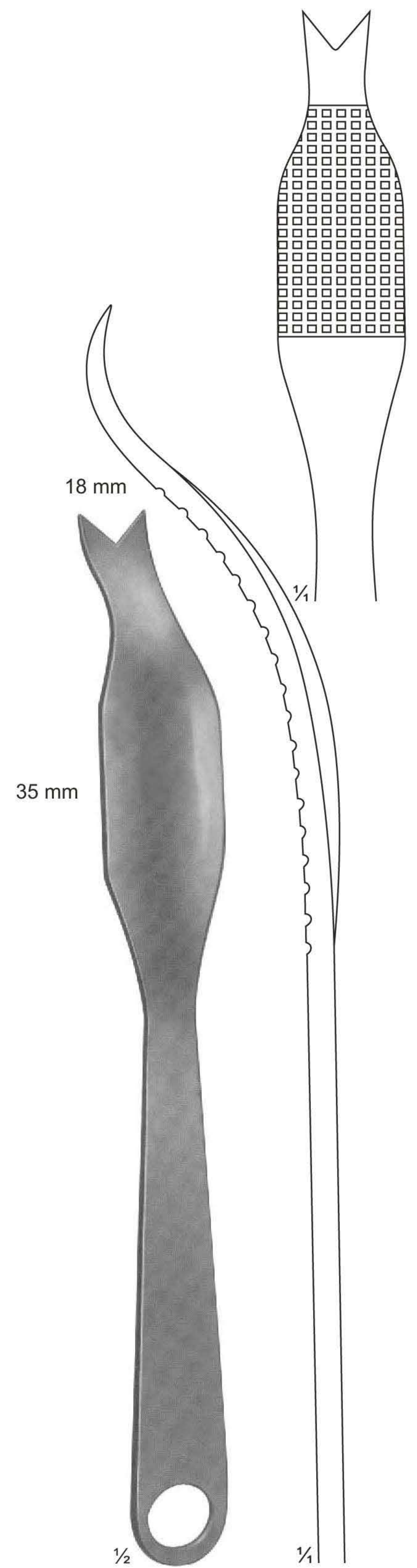

**UG-1575**  
SCHUMACHER  
290 mm

# Special Bone Levers

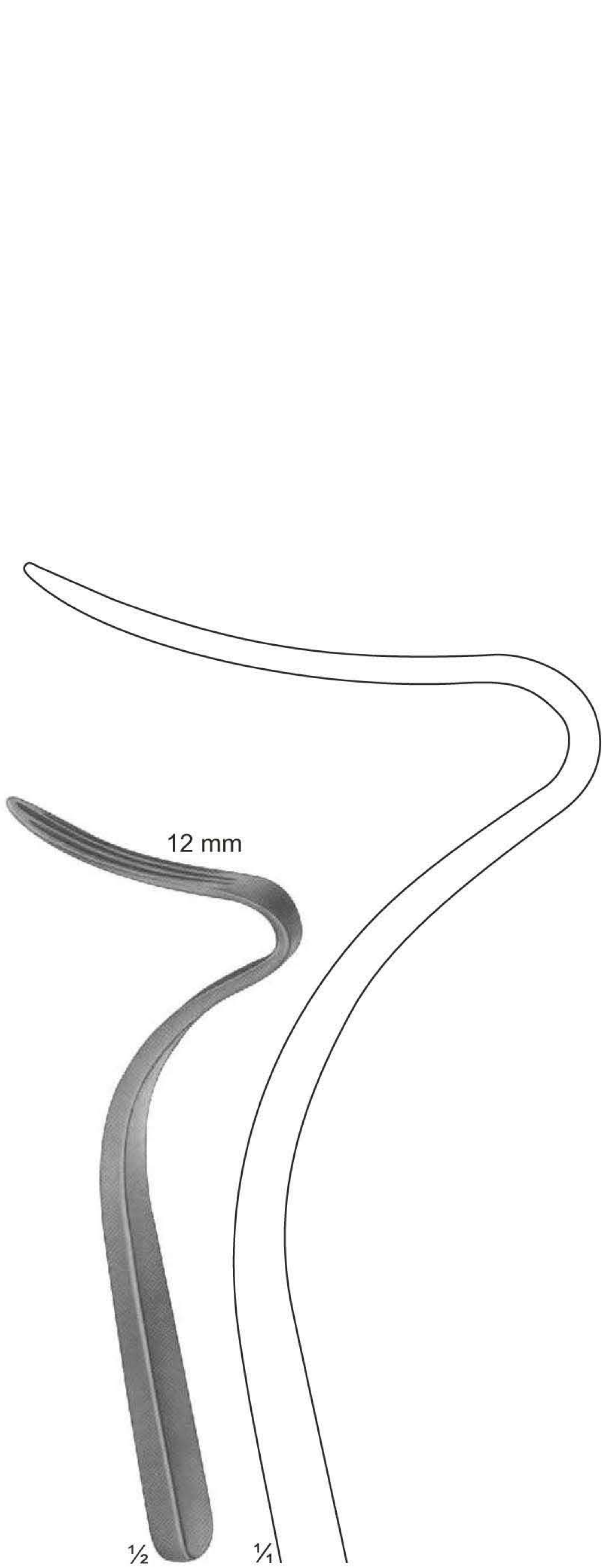

**UG-1576**  
**TAGER**  
 Bone lever for  
 angle joint operations  
 175 mm

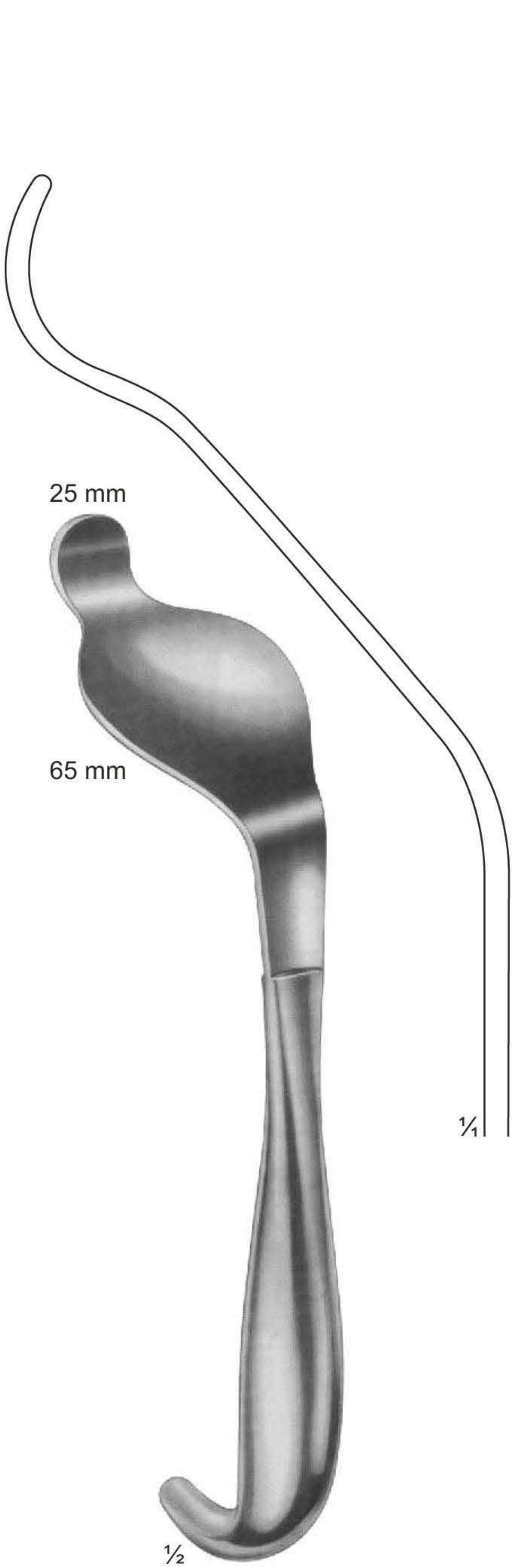

**UG-1577**  
**BENNETT**  
 235 mm

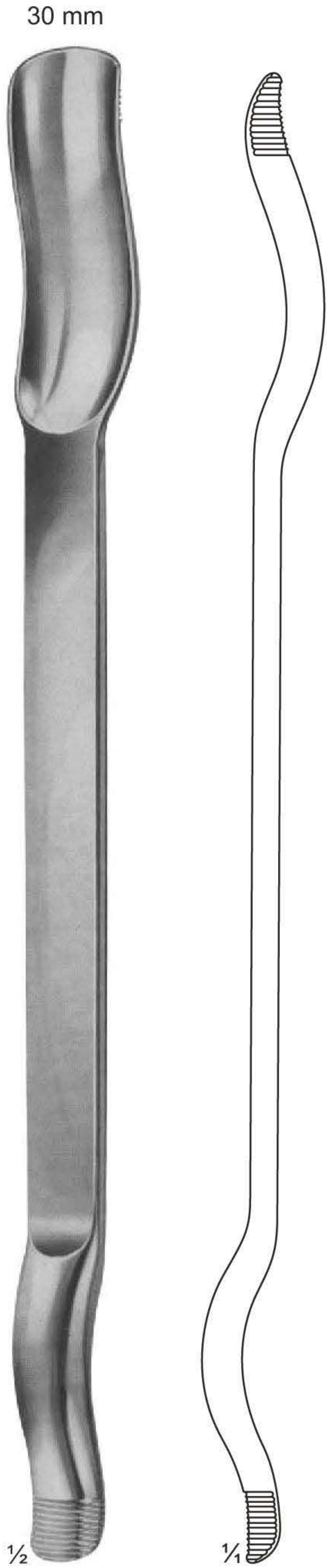

**UG-1578**  
**MURPHY-LANE**  
 Luxation lever  
 340 mm

# Raspatories



**UG-1579**  
PARTSCH  
150 mm

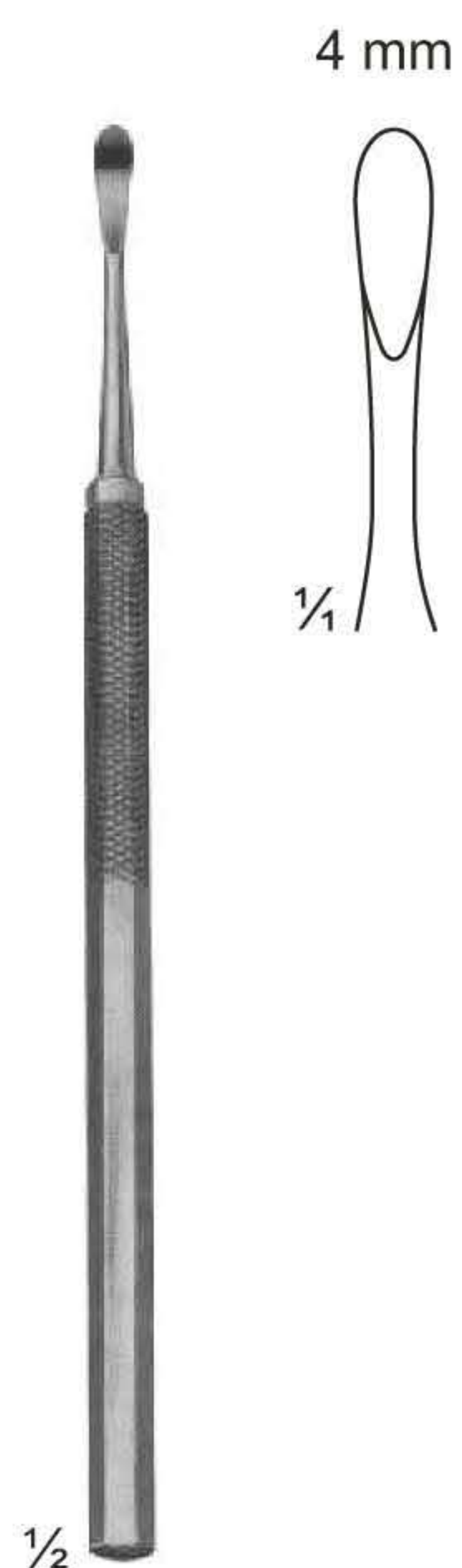

**UG-1580**  
PARTSCH mod. LANGE  
145 mm

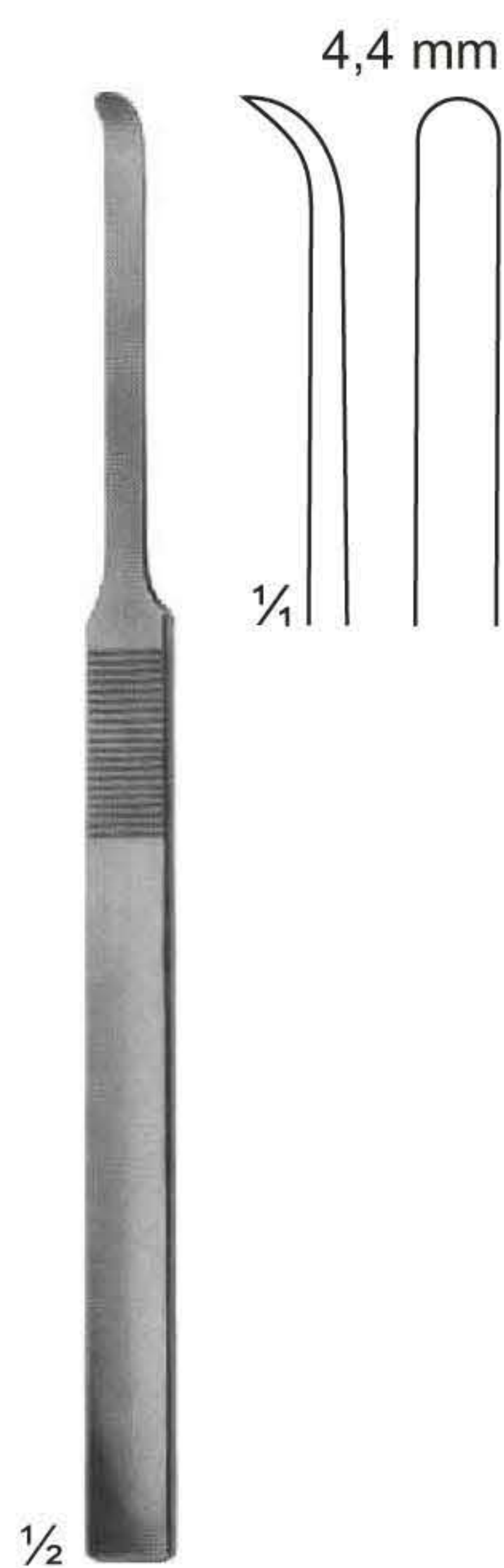

**UG-1581**  
MC KENTY  
155 mm

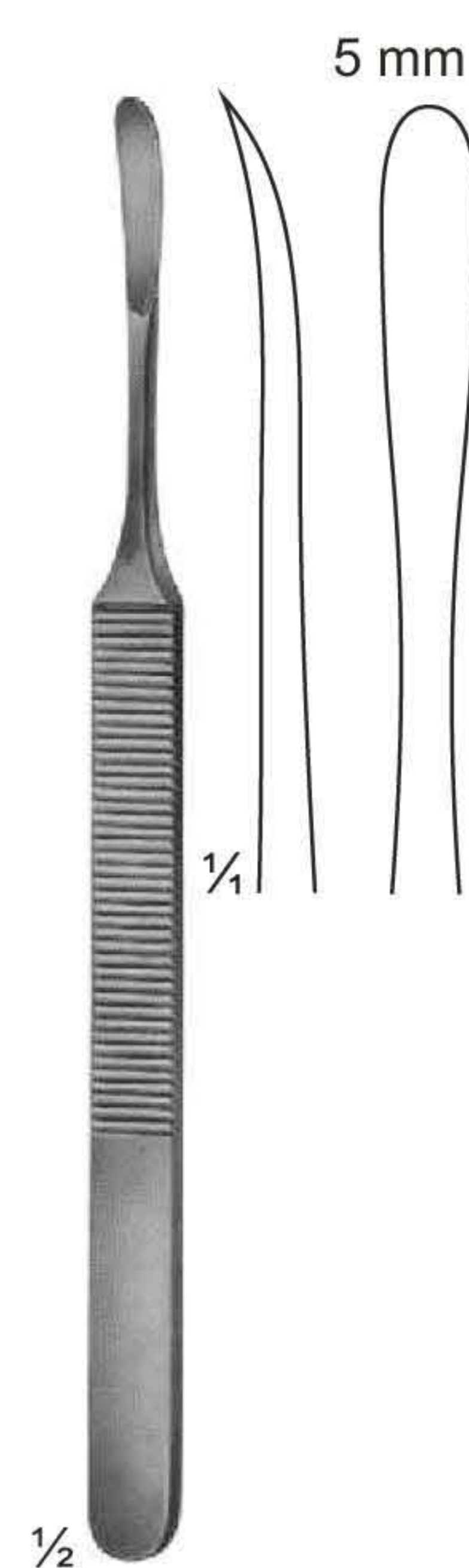

**UG-1582**  
KONIG  
155 mm

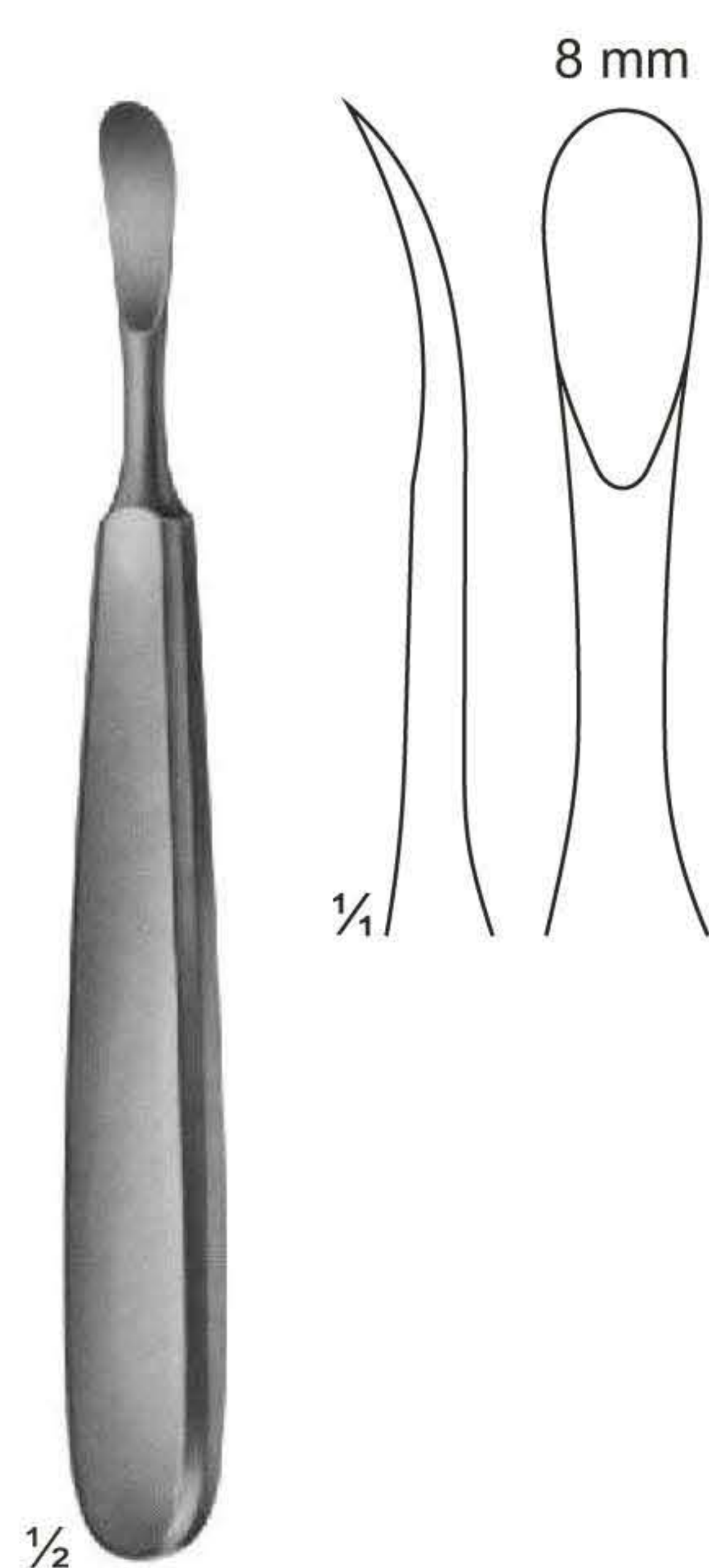

**UG-1583**  
TRELAT  
150 mm

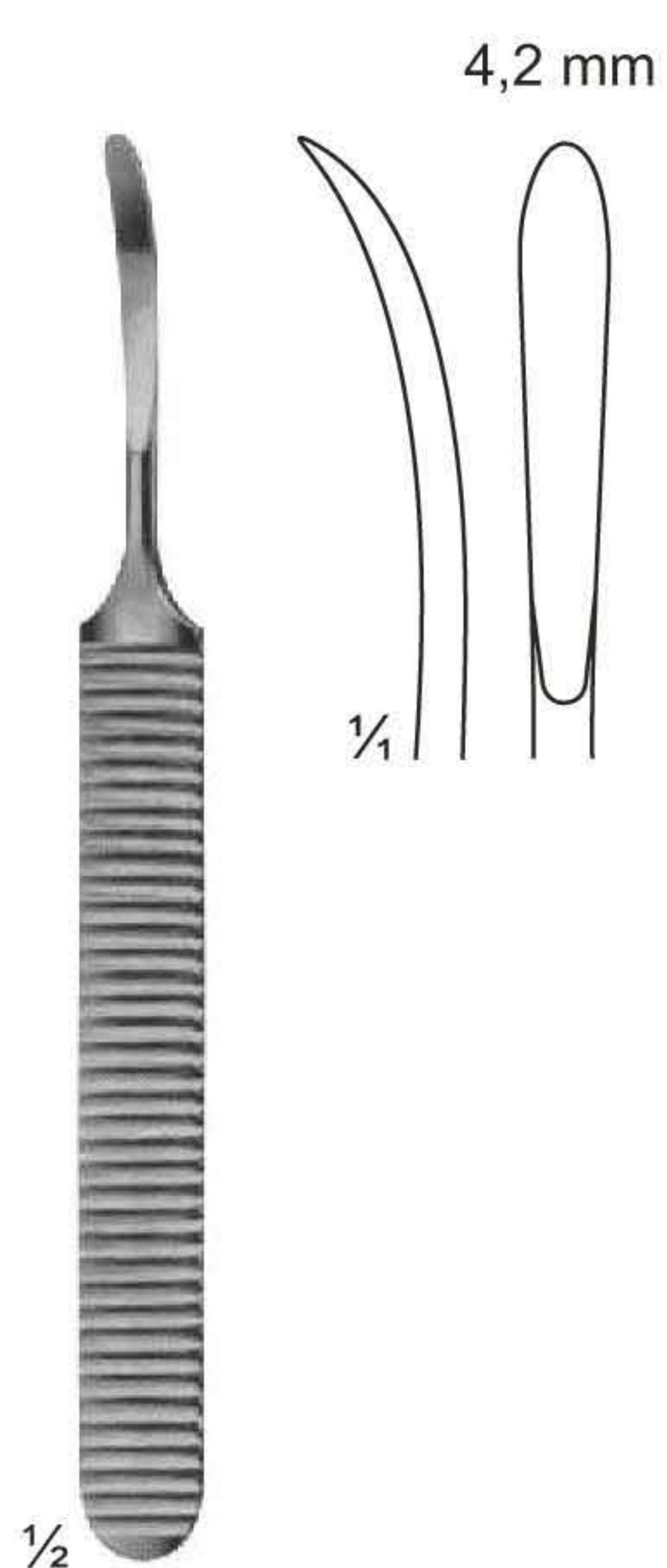

**UG-1584**  
WILLIGER  
140 mm

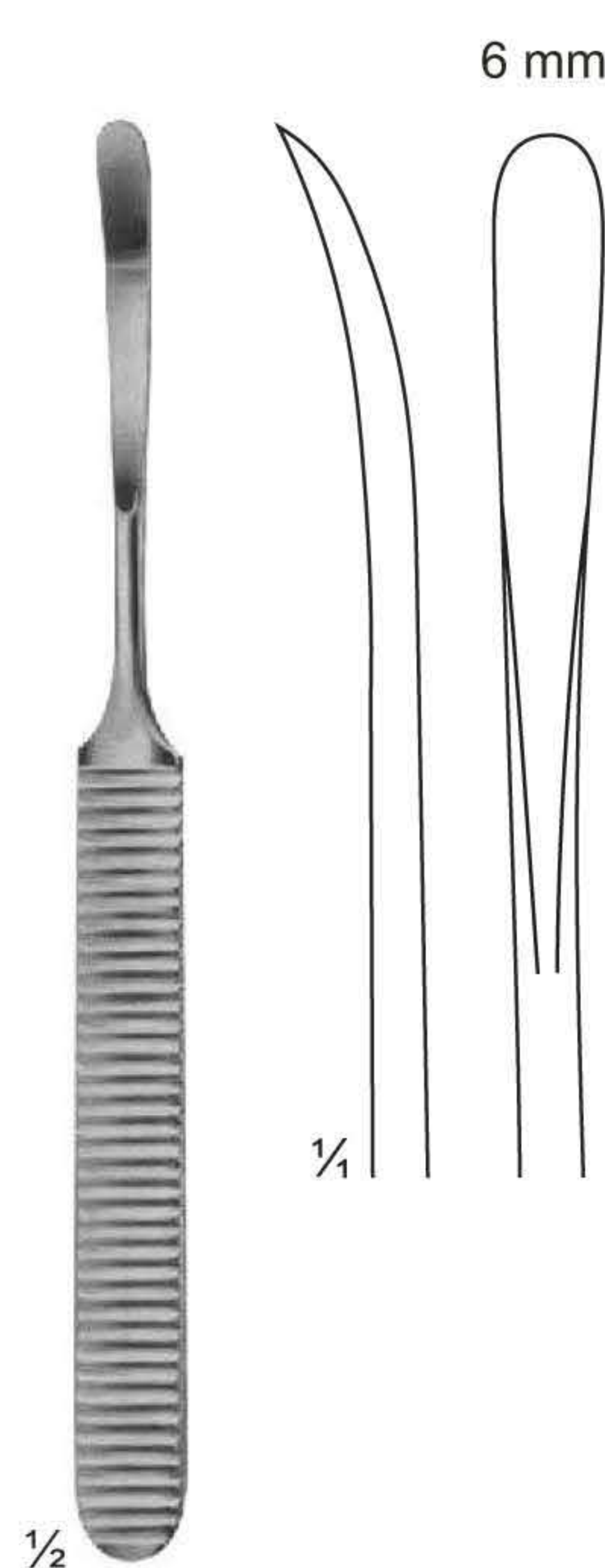

**UG-1585**  
WILLIGER  
160 mm

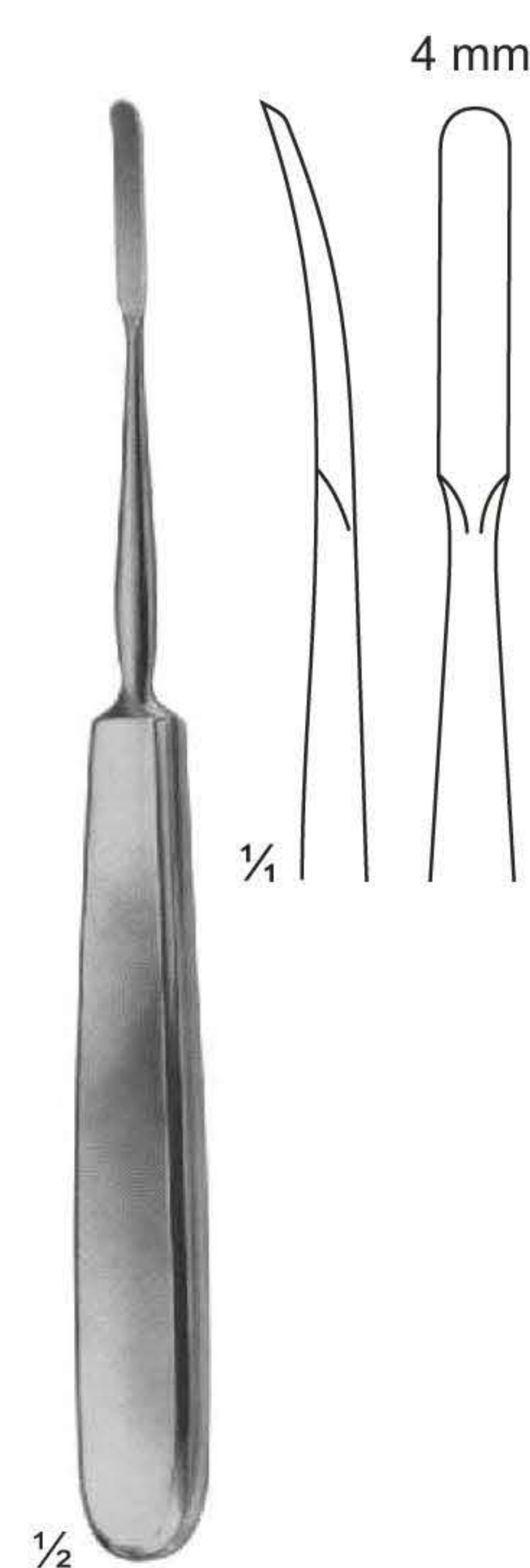

**UG-1586**  
JOSEPH  
170 mm



# Raspatories

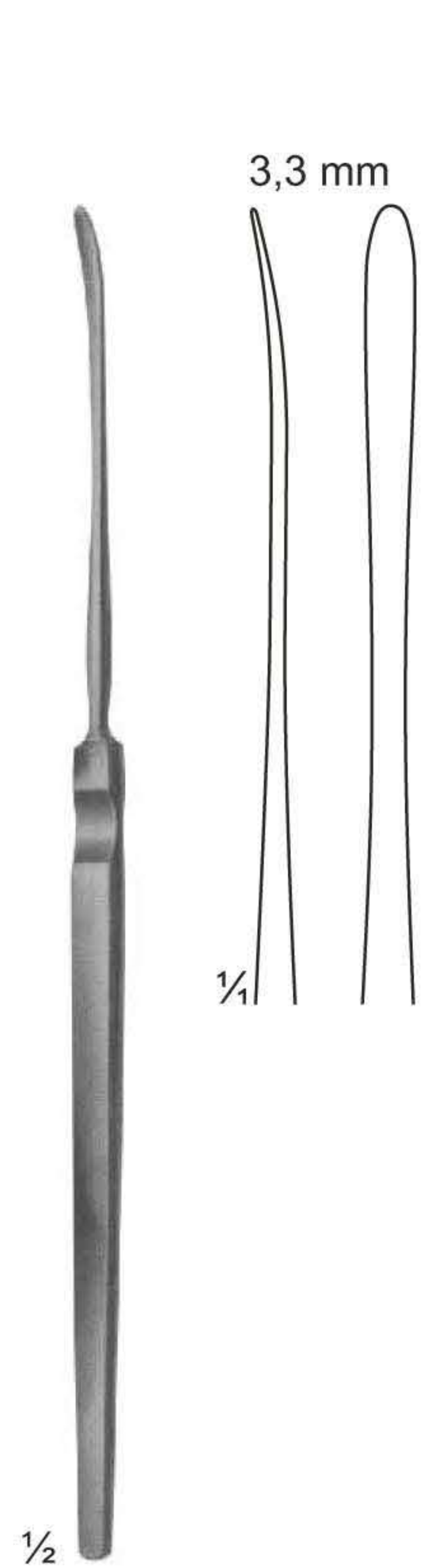

**UG-1587**  
HALLE  
stumfp/blunt  
180 mm



**UG-1588**  
FREER  
stumfp/blunt  
190 mm

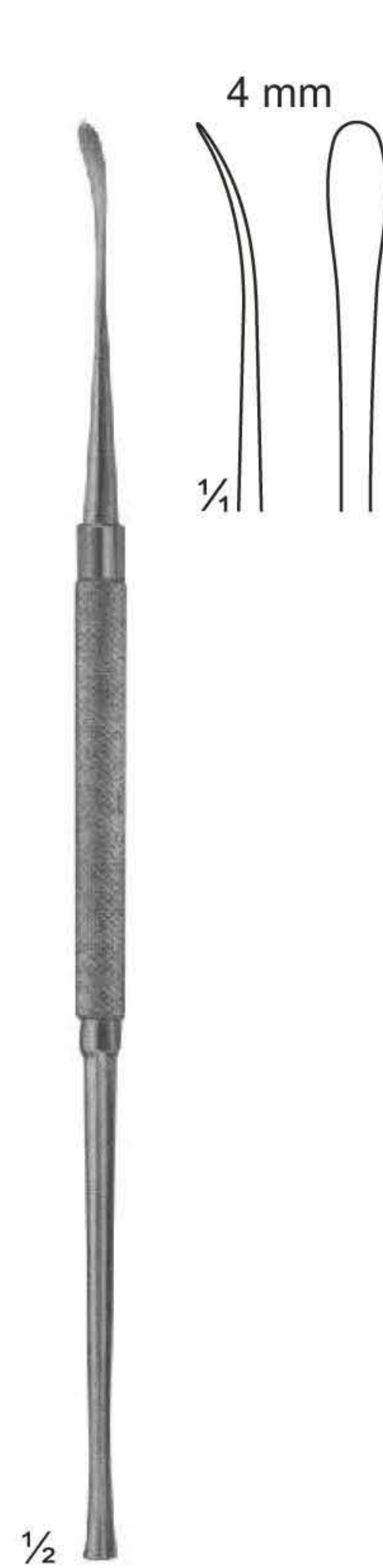

**UG-1589**  
FREER  
stumfp/sharp  
190 mm



**UG-1590**  
SEWALL  
stumfp/blunt  
190 mm



**UG-1591**  
PAULSEN  
205 mm



**UG-1592**  
PAULSEN  
205 mm

# Raspatories

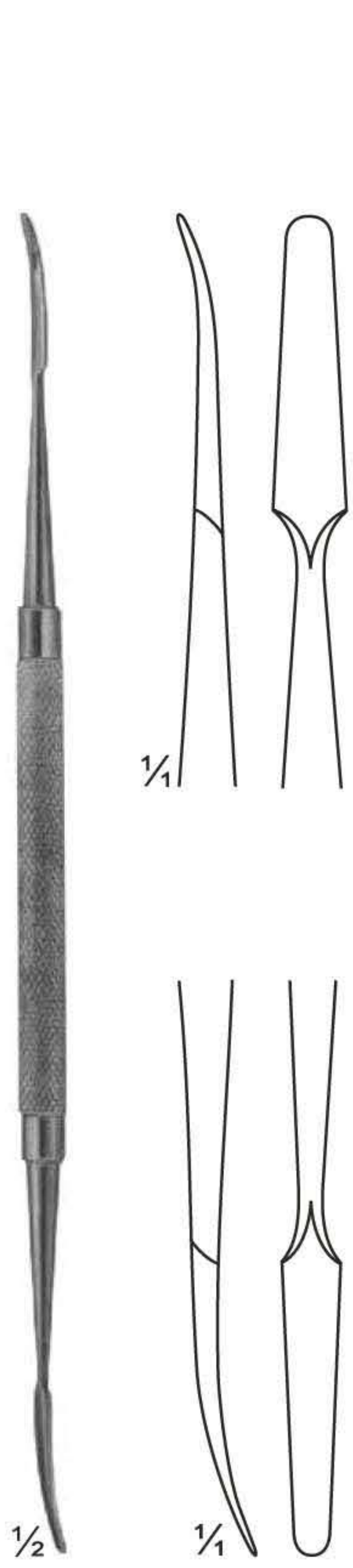

UG-1593  
KILLIAN  
sharp/blunt  
185 mm

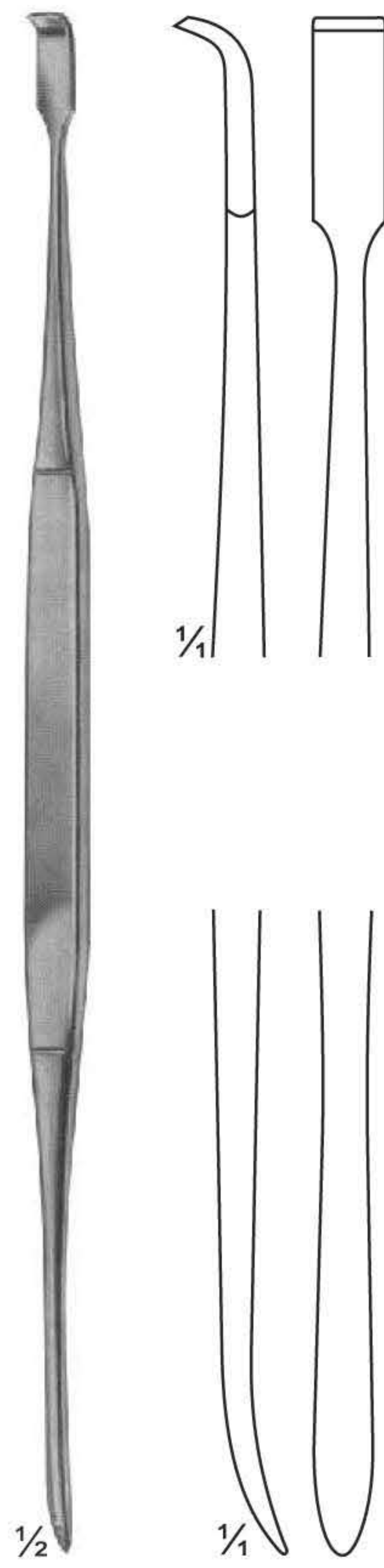

UG-1594  
HOWARTH  
sharp/blunt  
215 mm

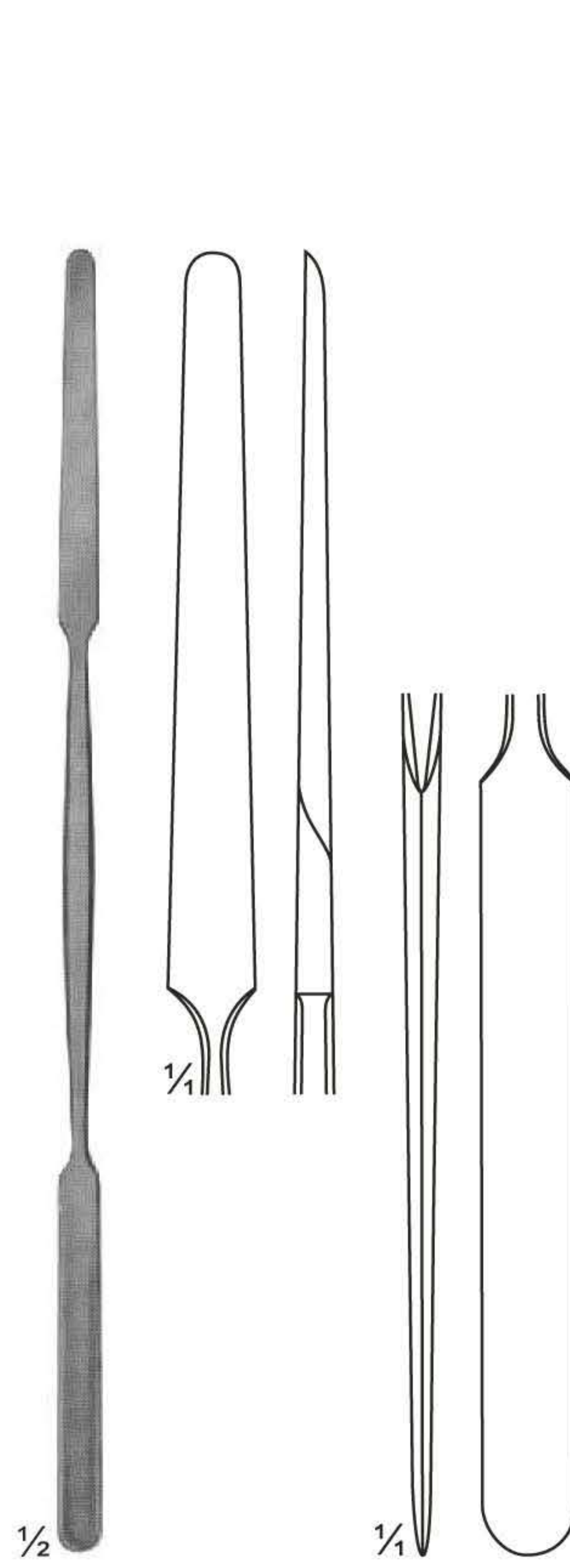

UG-1595  
KILLIAN  
sharp/blunt  
185 mm

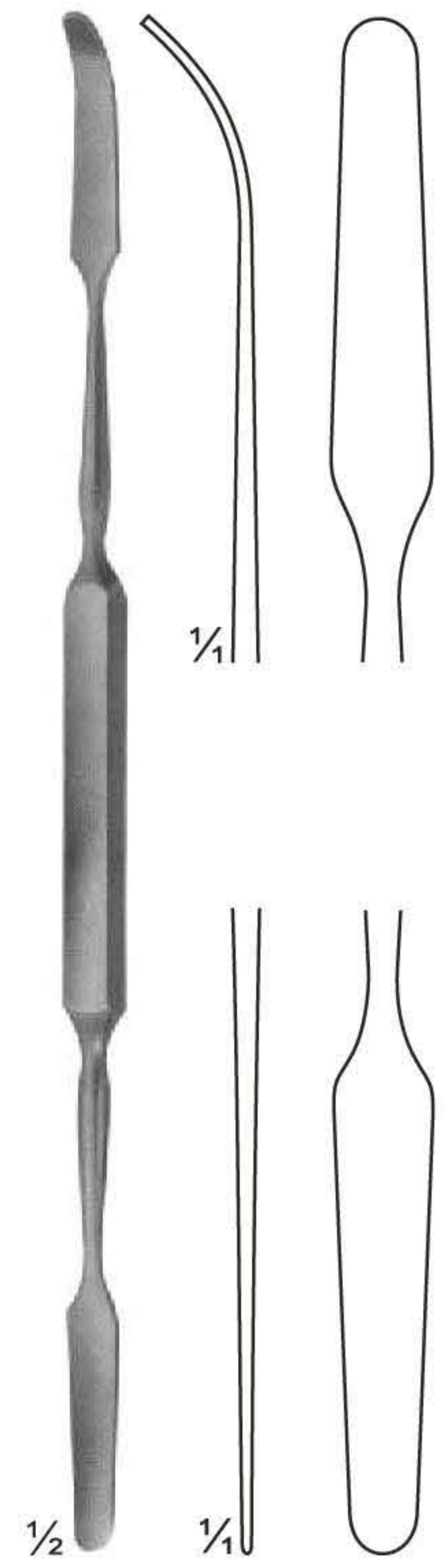

UG-1596  
MAC DONALD  
blunt/blunt  
185 mm

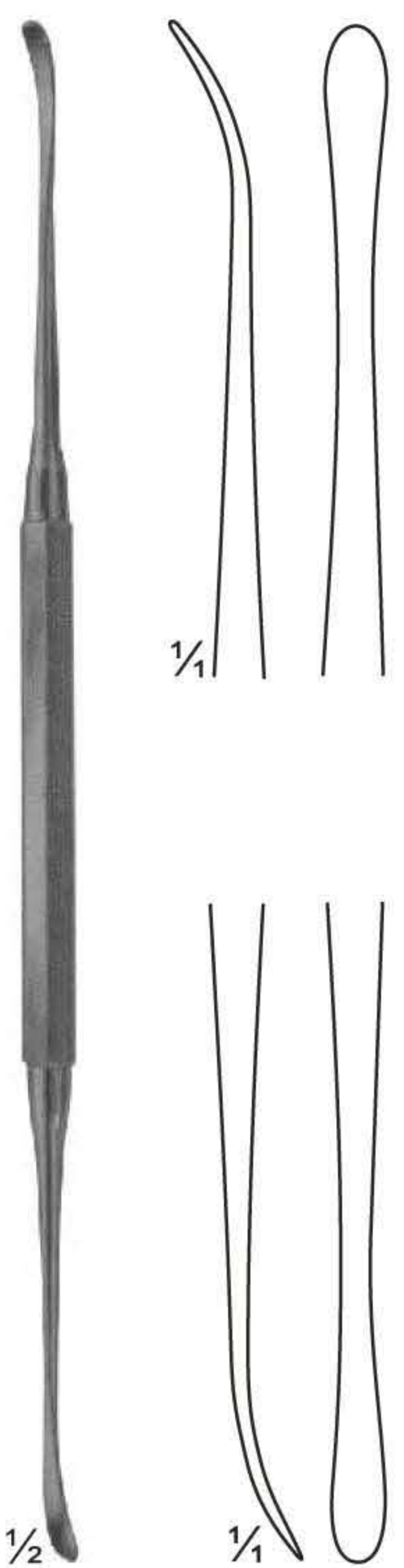

UG-1597  
FREER  
sharp/blunt  
185 mm

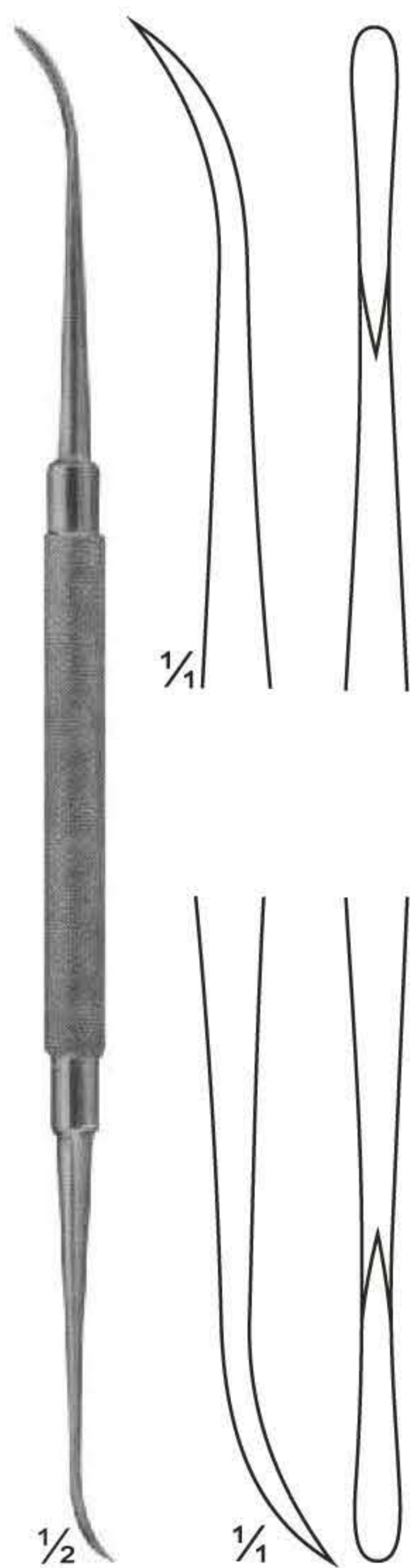

UG-1598  
FREER-YASARGIL  
sharp/sharp  
185 mm

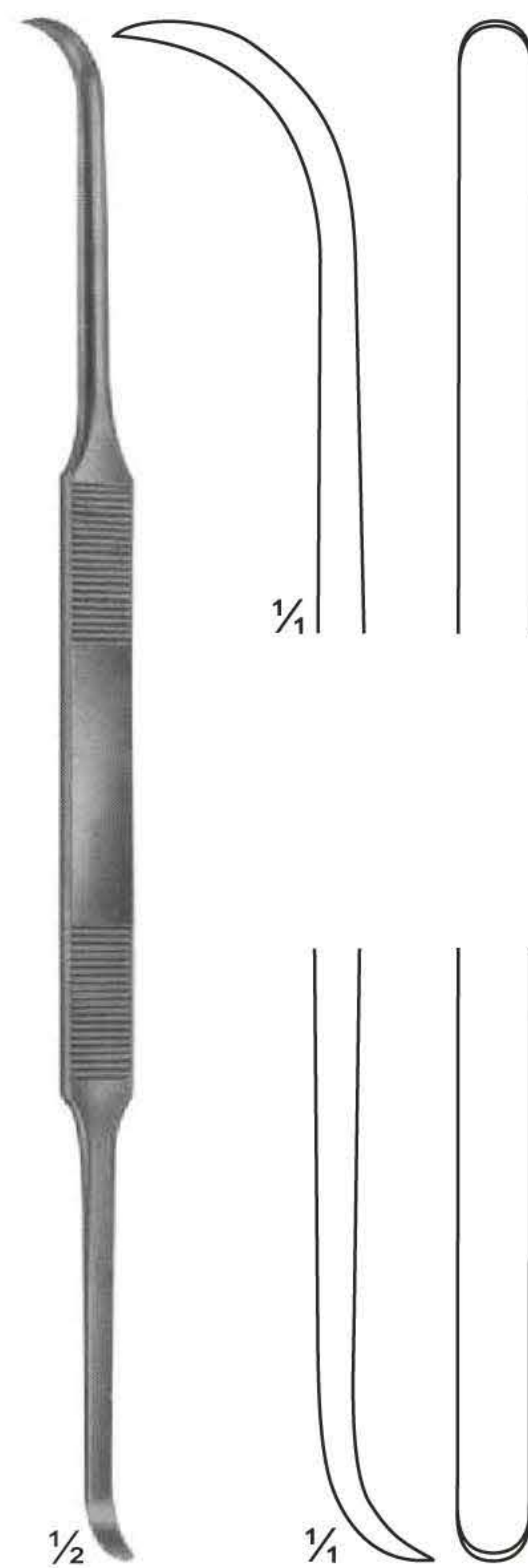

UG-1599  
COTTLE  
sharp/sharp  
200 mm

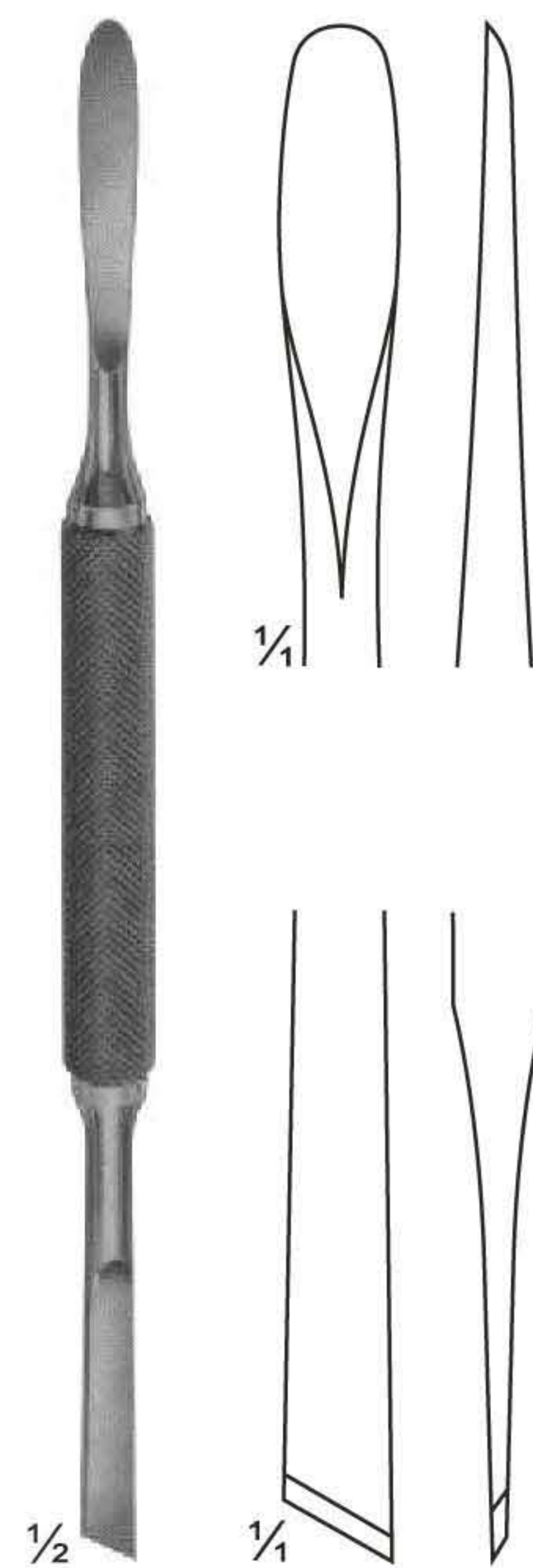

UG-1600  
MEAD  
sharp/sharp  
165 mm

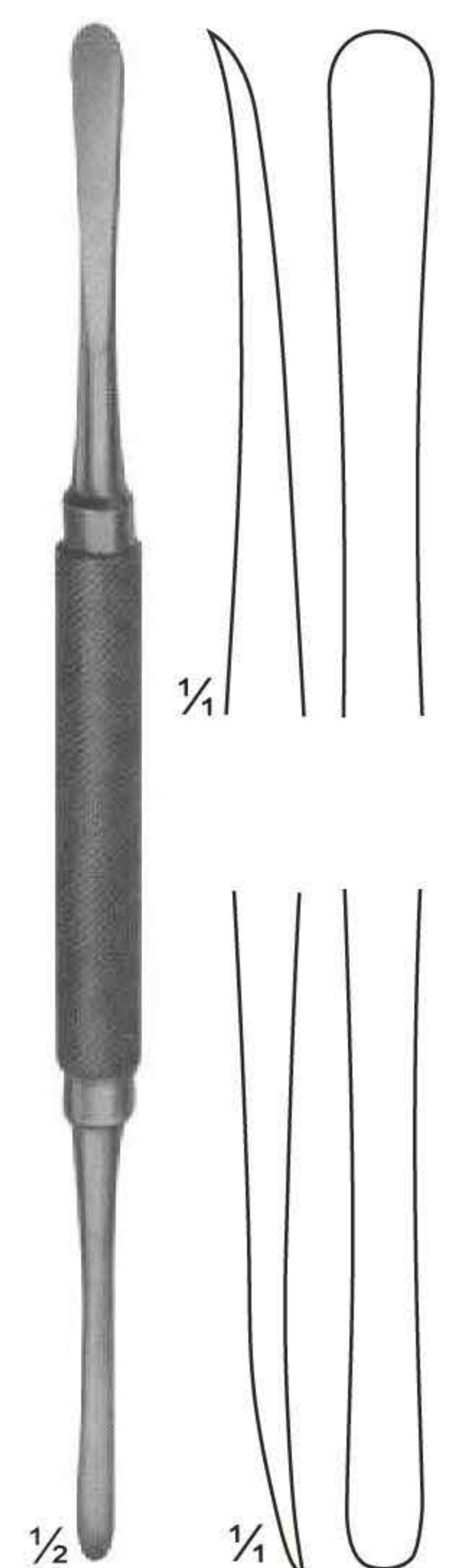

UG-1601  
MOLT  
sharp/sharp  
180 mm

# Raspatories

---



$\frac{1}{2}$   
**UG-1602**  
MANNERFET  
155 mm



$\frac{1}{2}$   
**UG-1609**  
165 mm



$\frac{1}{2}$   
**UG-1610**  
ADSON  
170 mm

# Raspatories



1/2  
**UG-1611**  
 MUHLING  
 170 mm



1/2  
**UG-1612**  
 COTTLE  
 175 mm

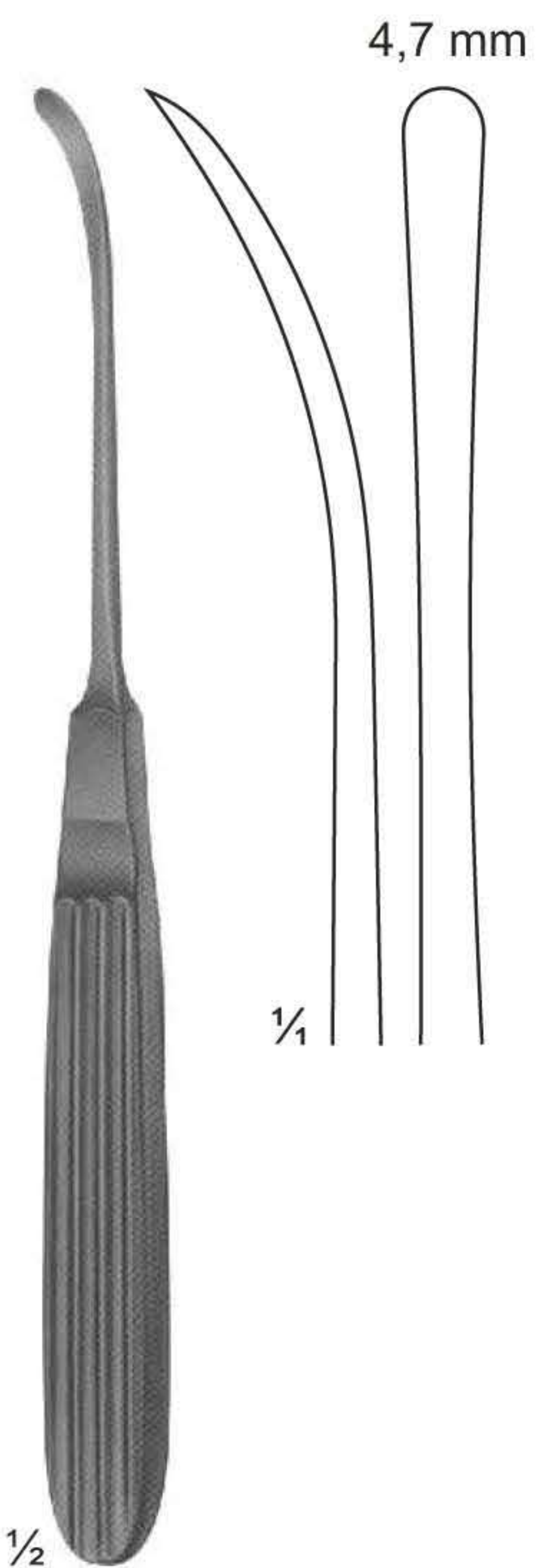
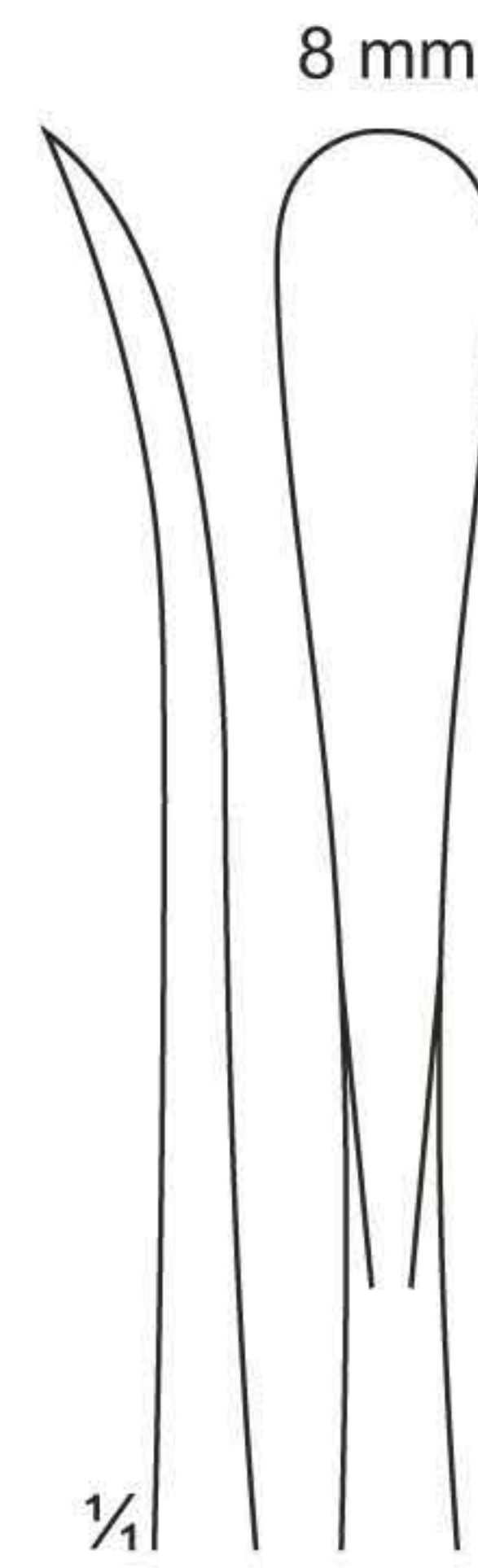

1/2  
**UG-1613**  
 LANDOT  
 175 mm

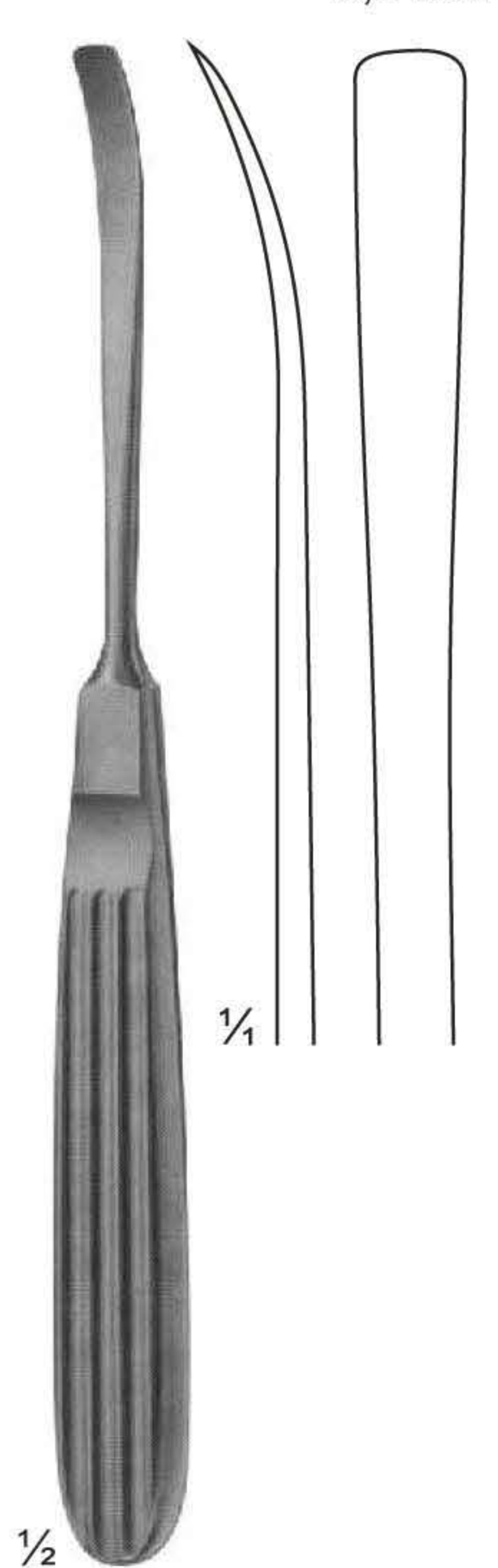
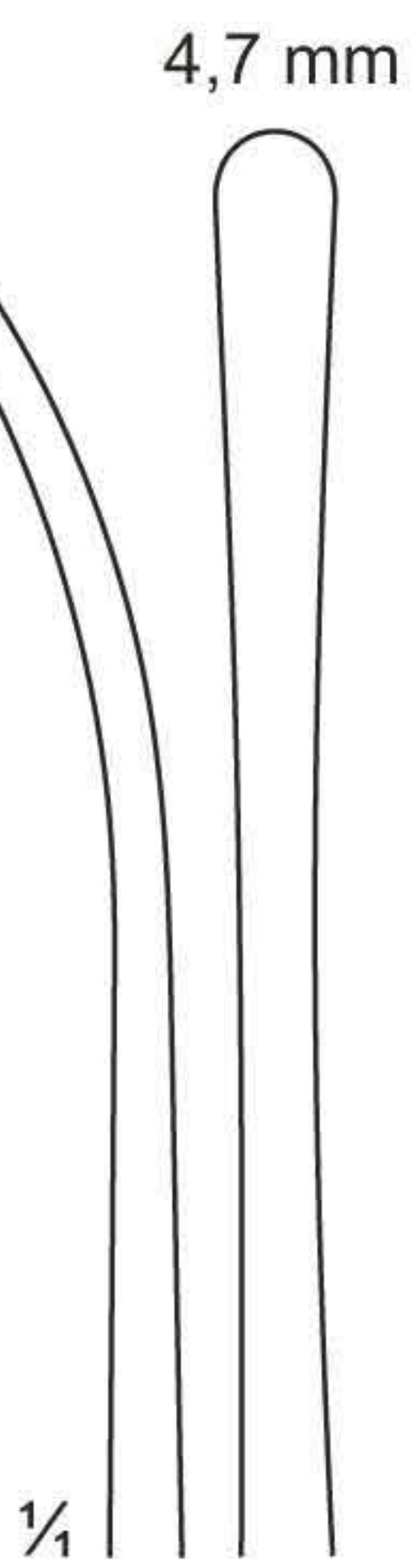

1/2  
**UG-1614**  
 CASPER  
 180 mm

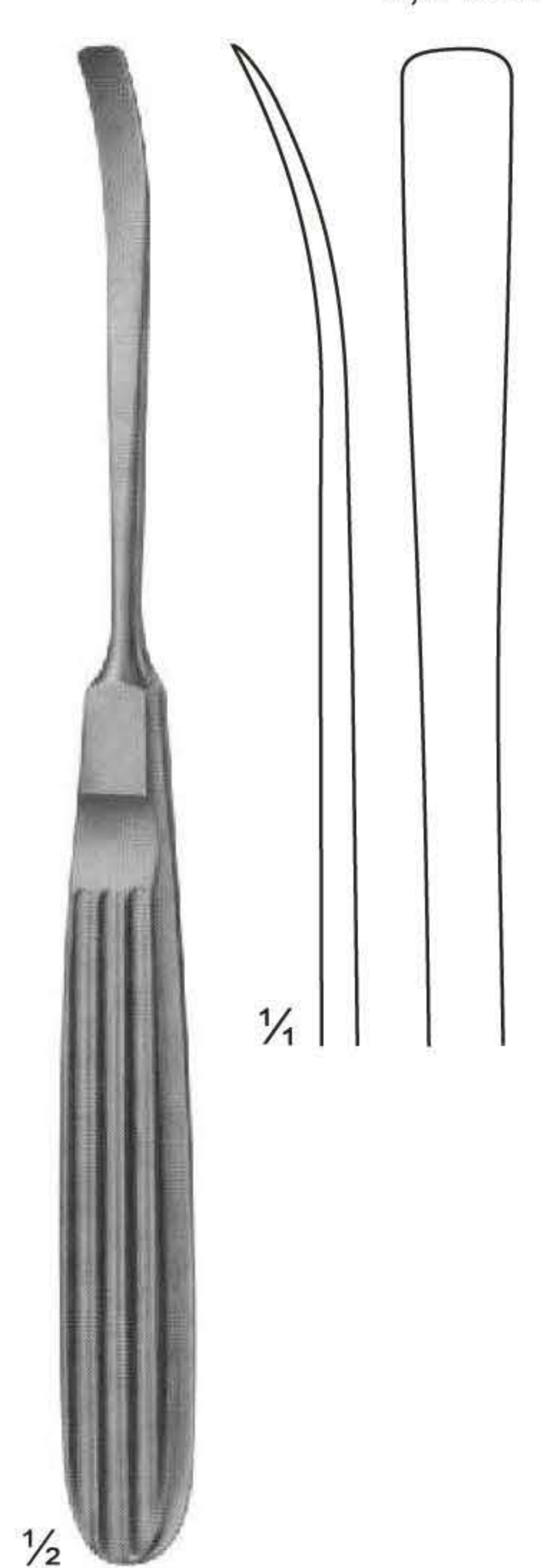
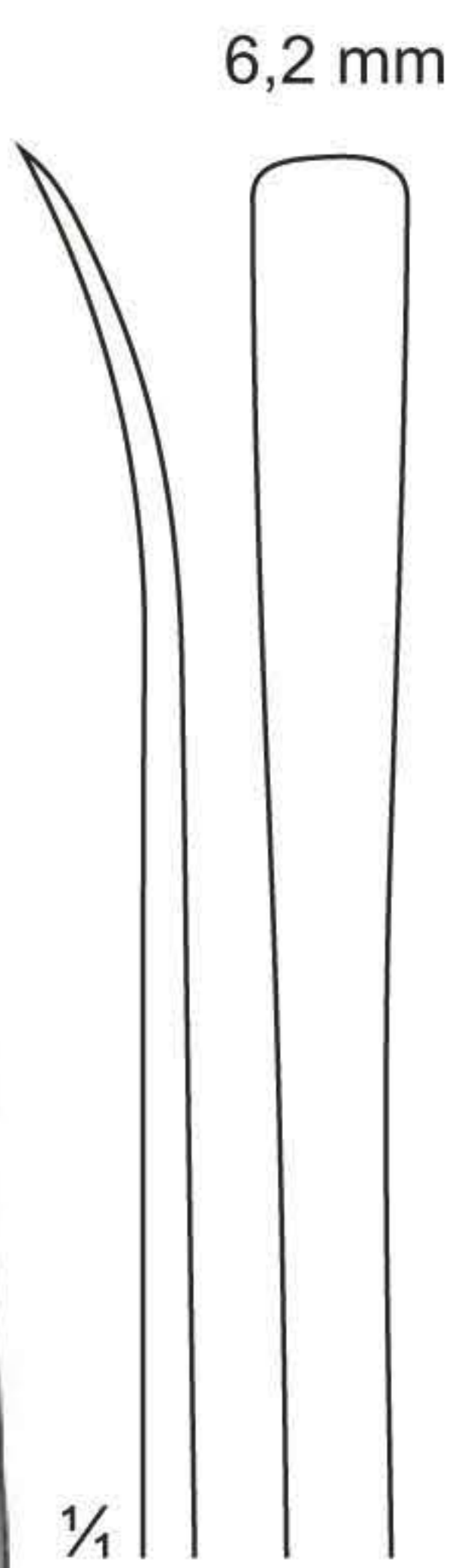

1/2  
**UG-1615**  
 CASPER  
 180 mm

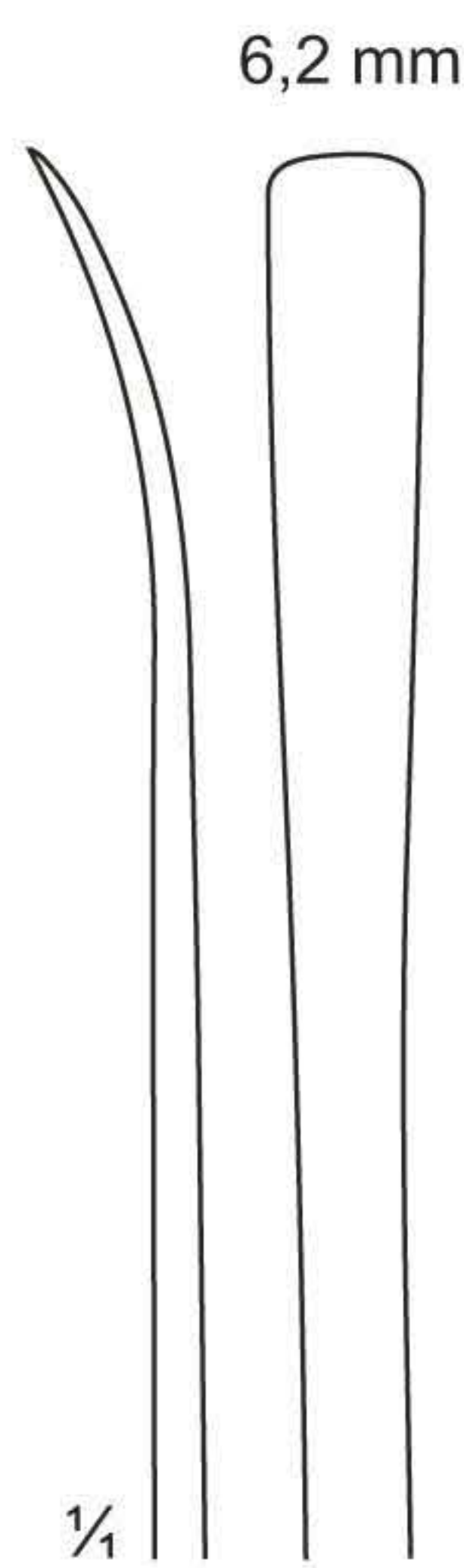

1/2  
**UG-1616**  
 170 mm

# Raspatories

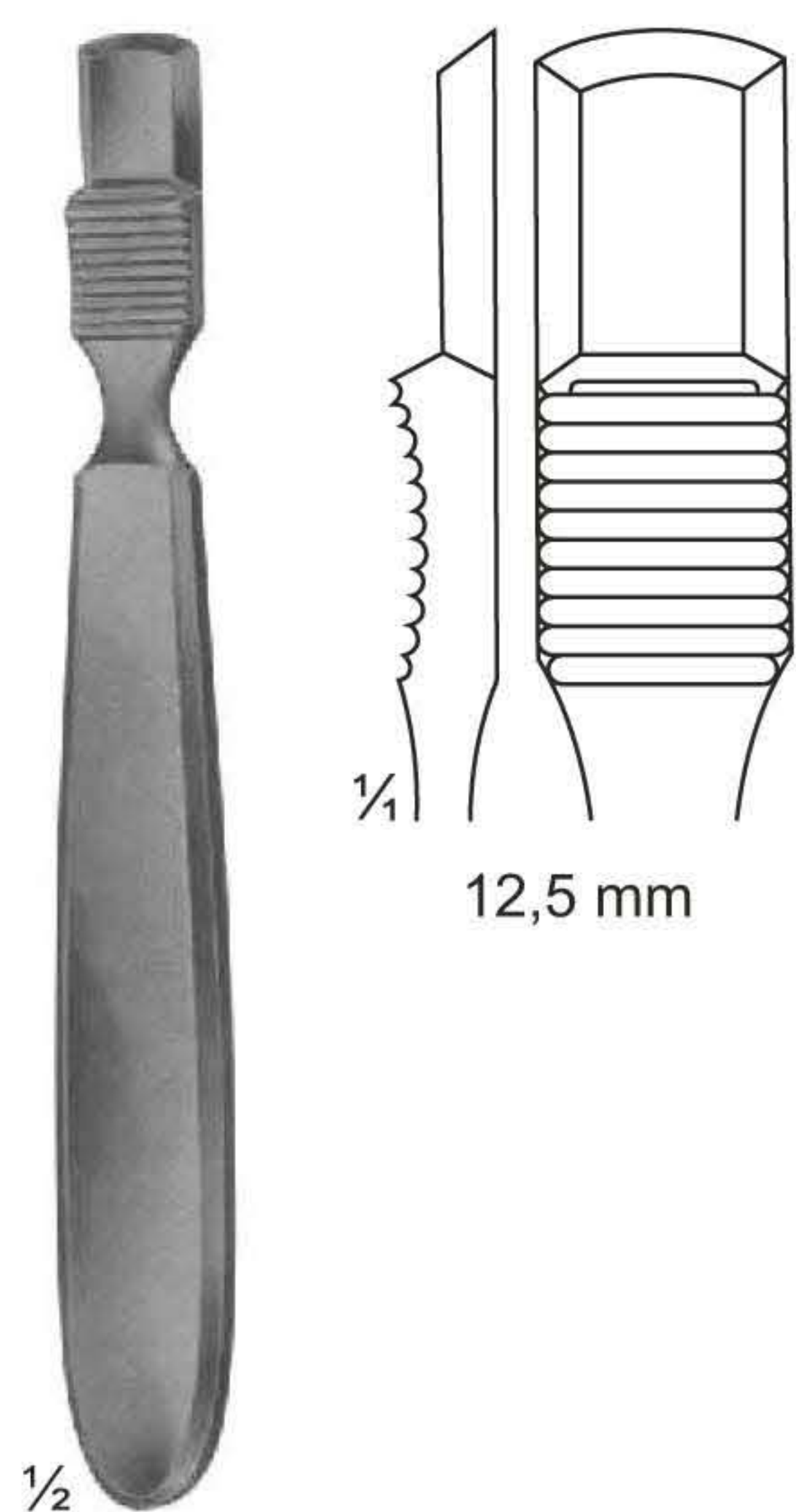

**UG-1617**  
FARABEUF  
140 mm

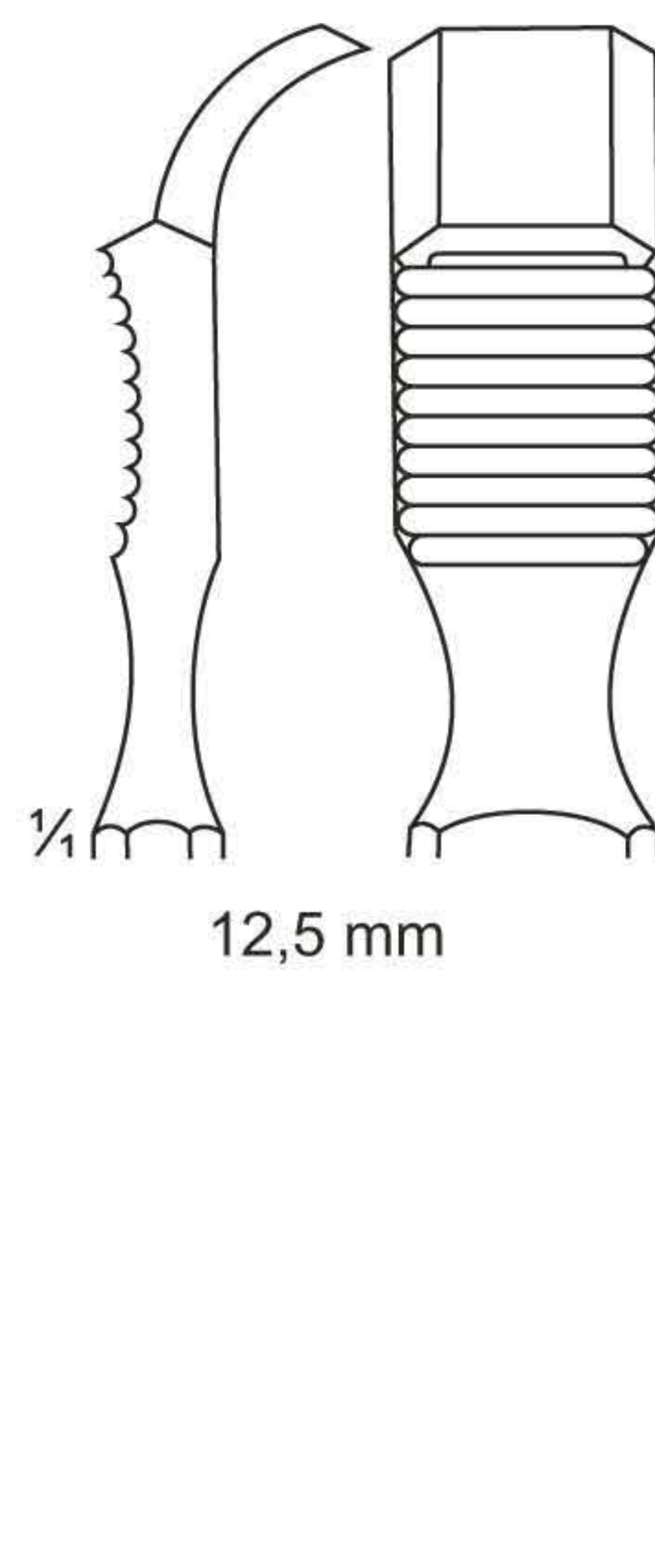

**UG-1618**  
FARABEUF  
140 mm

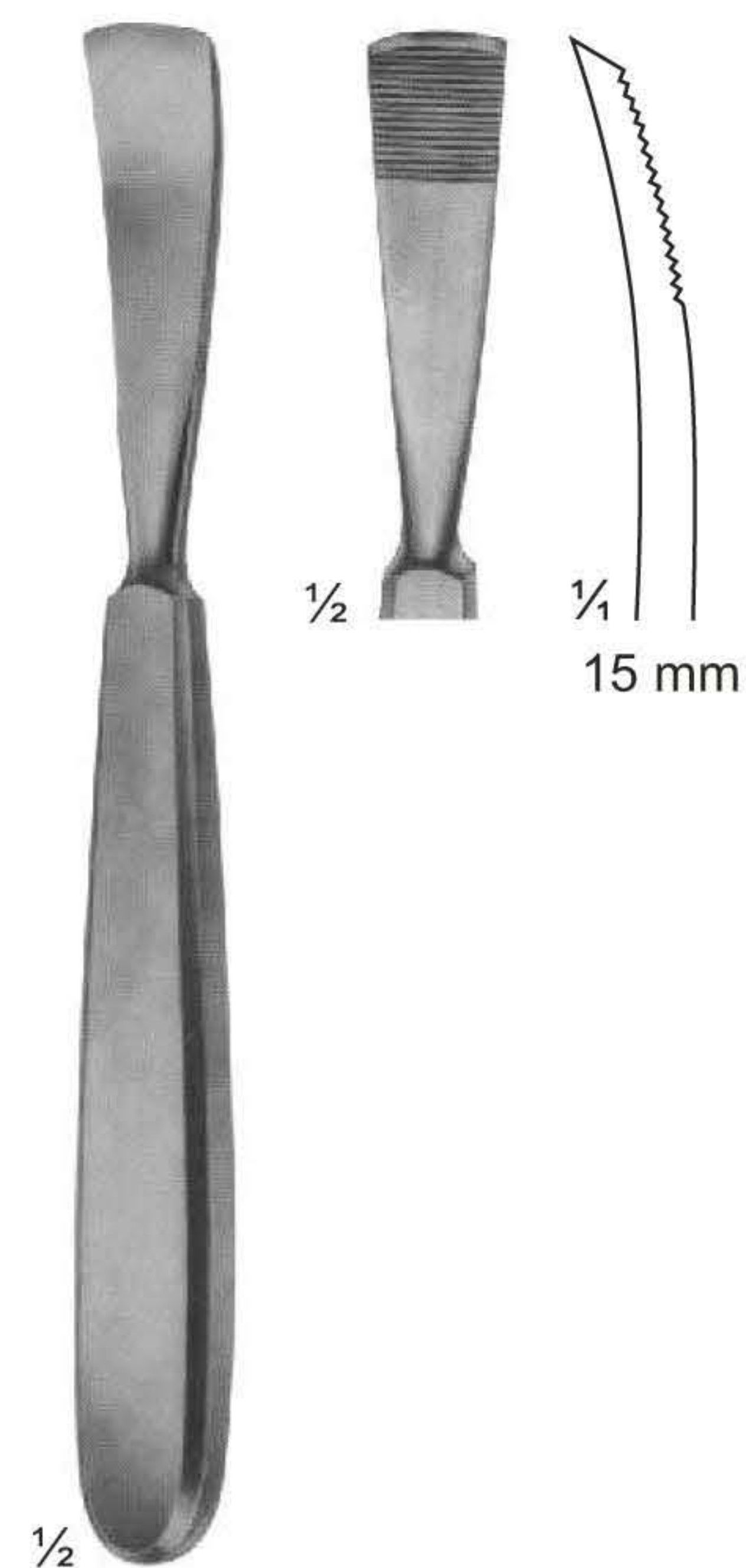

**UG-1619**  
JANSEN  
165 mm

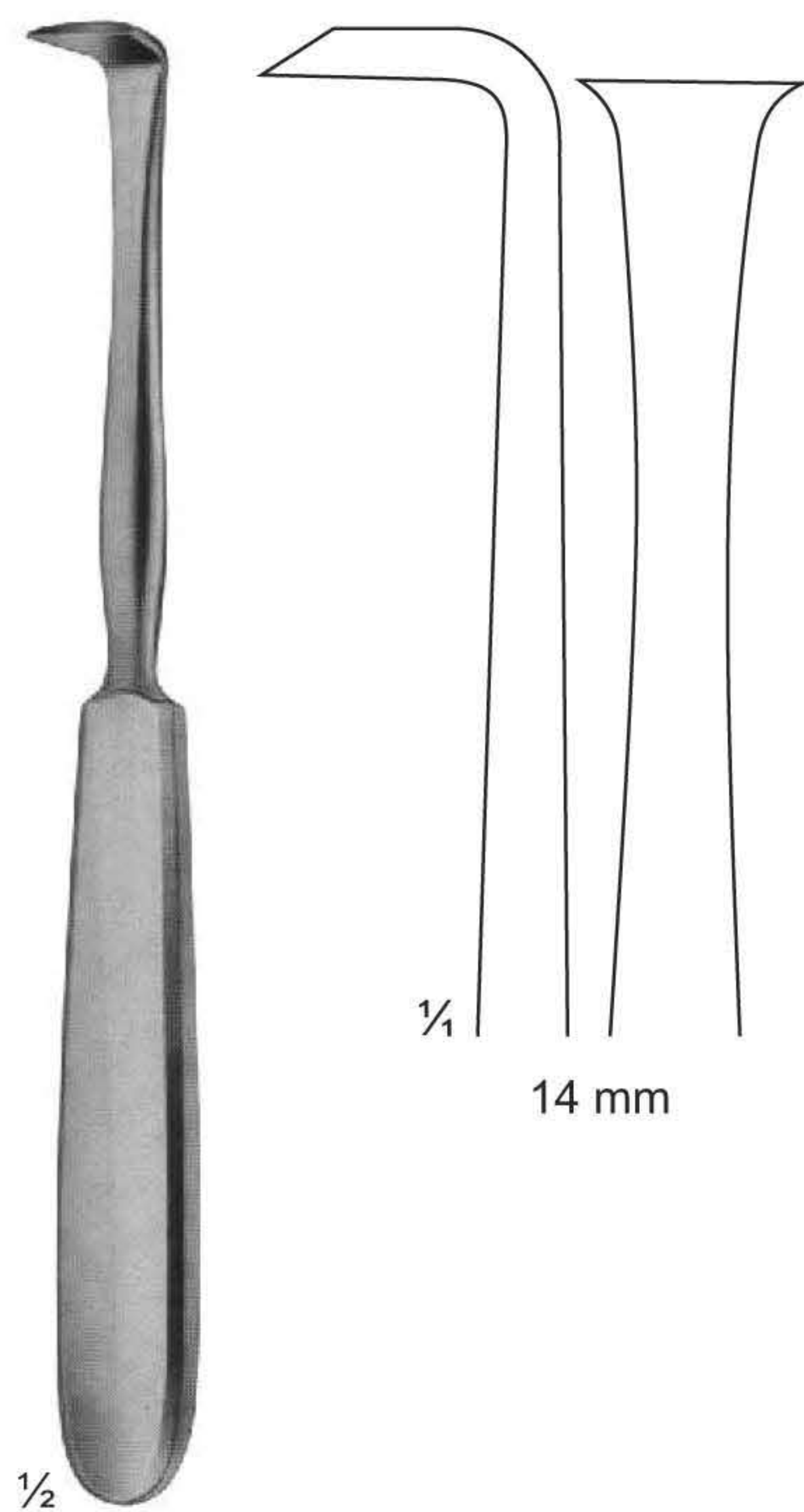

**UG-1620**  
LANGENBACK  
180 mm

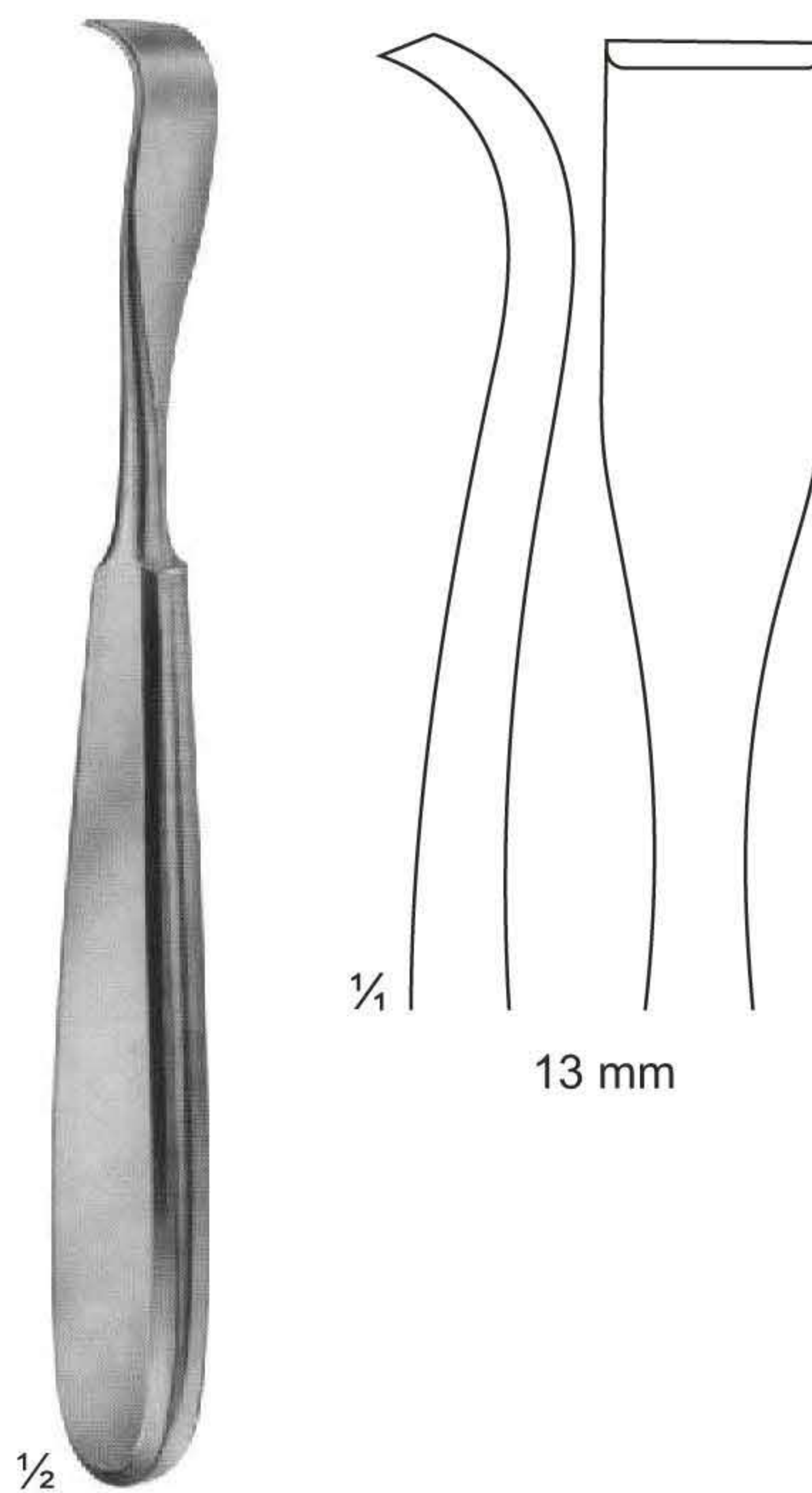

**UG-1621**  
SCHNEIDER  
175 mm

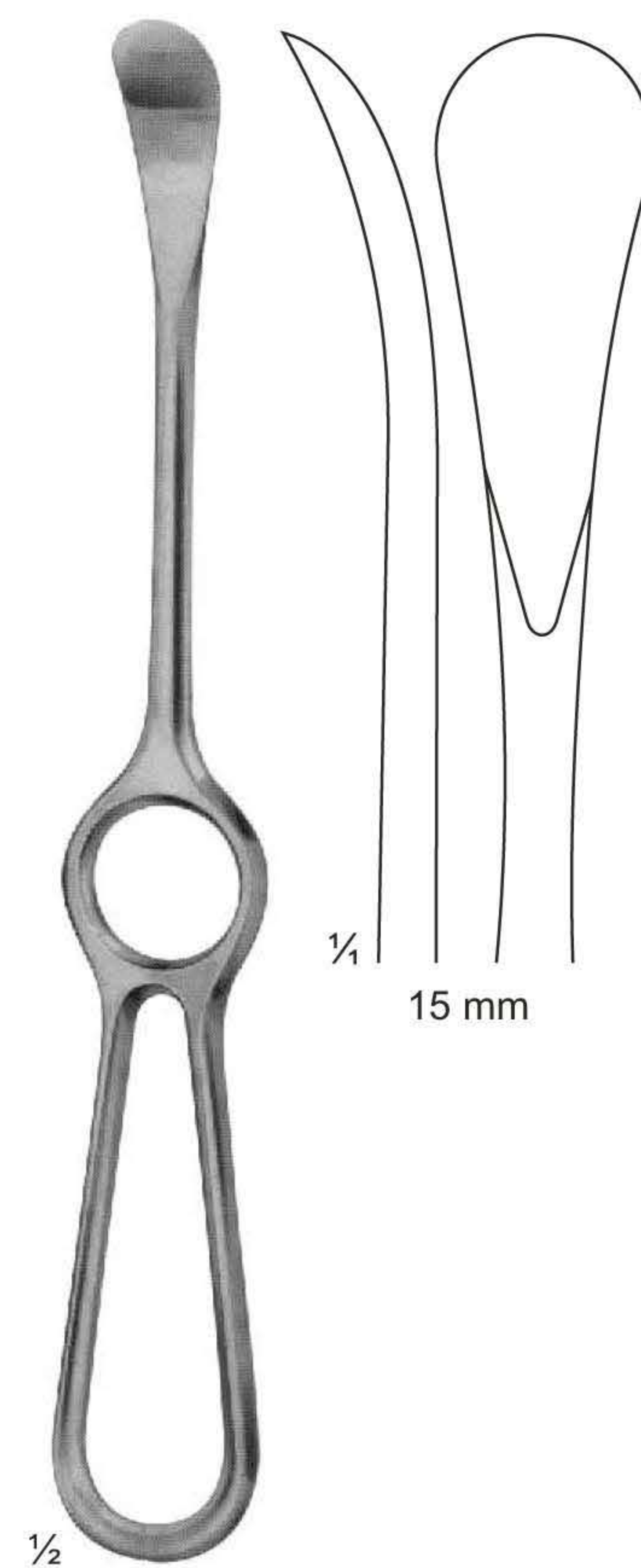

**UG-1622**  
SEDILLOT  
215 mm

# Raspatories



1/2

UG-1623  
SEMB  
230 mm



1/2

20-202 - 203  
DOYEN  
for children  
20-204 - 205  
for adults  
175 mm

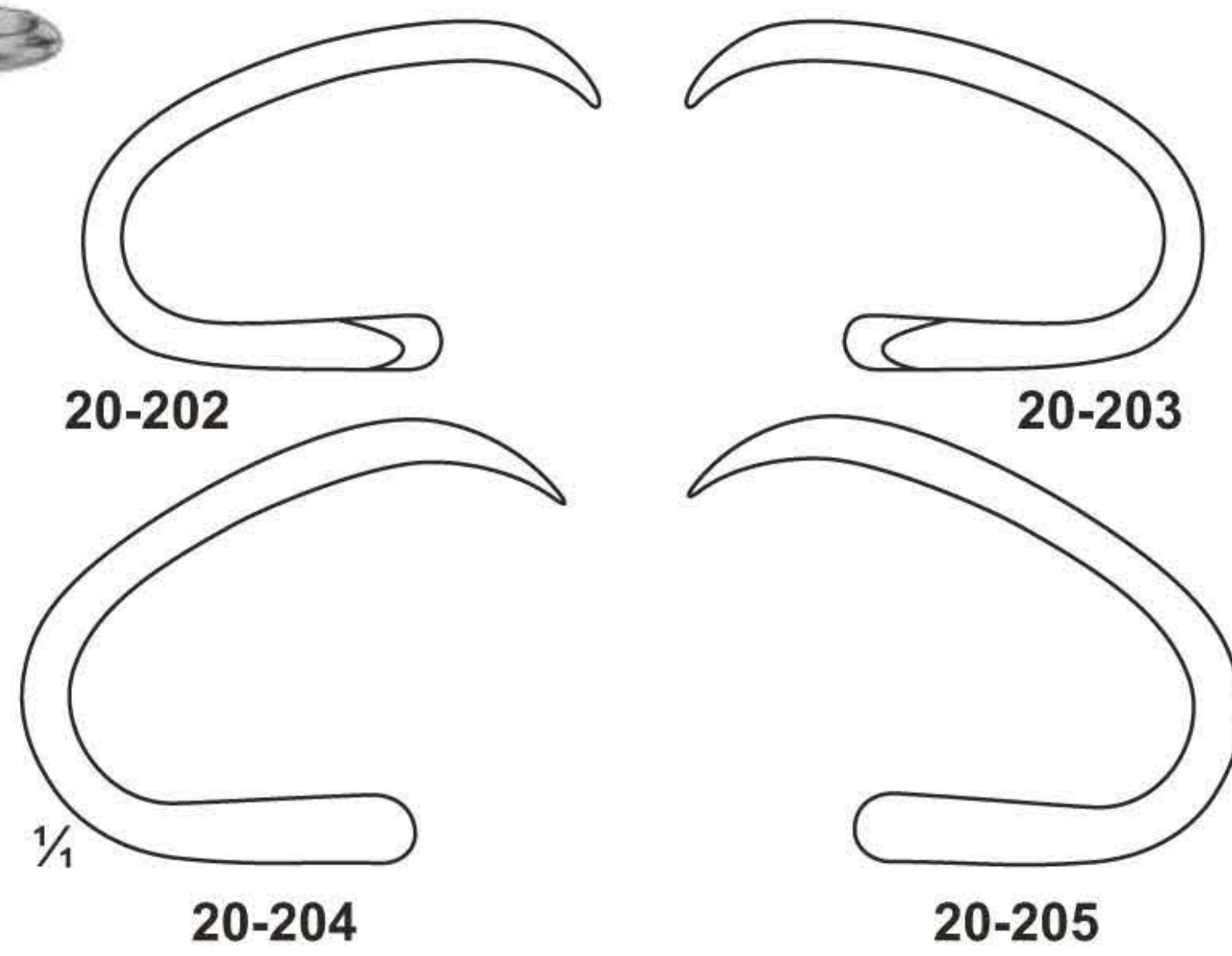

20-202

20-203

1/4

20-204

20-205

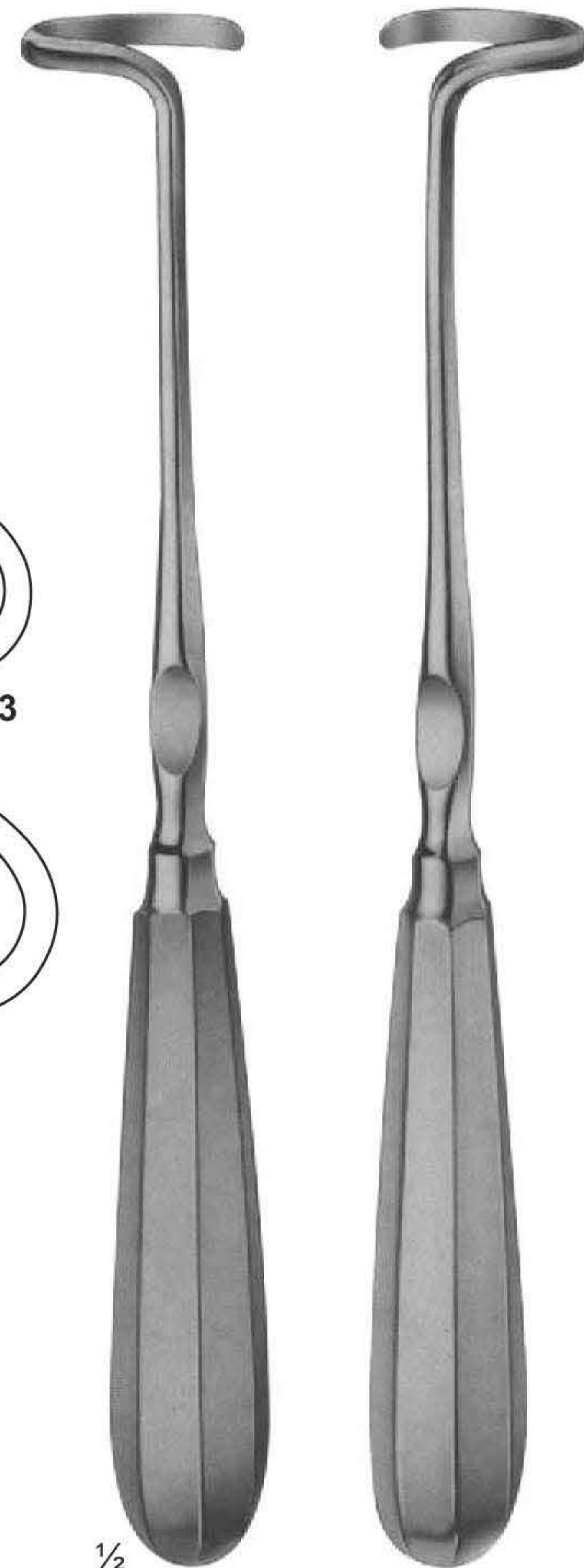

1/2

UG-1626  
DOYEN  
240 mm

## Raspatories with HARTPRESS-handle

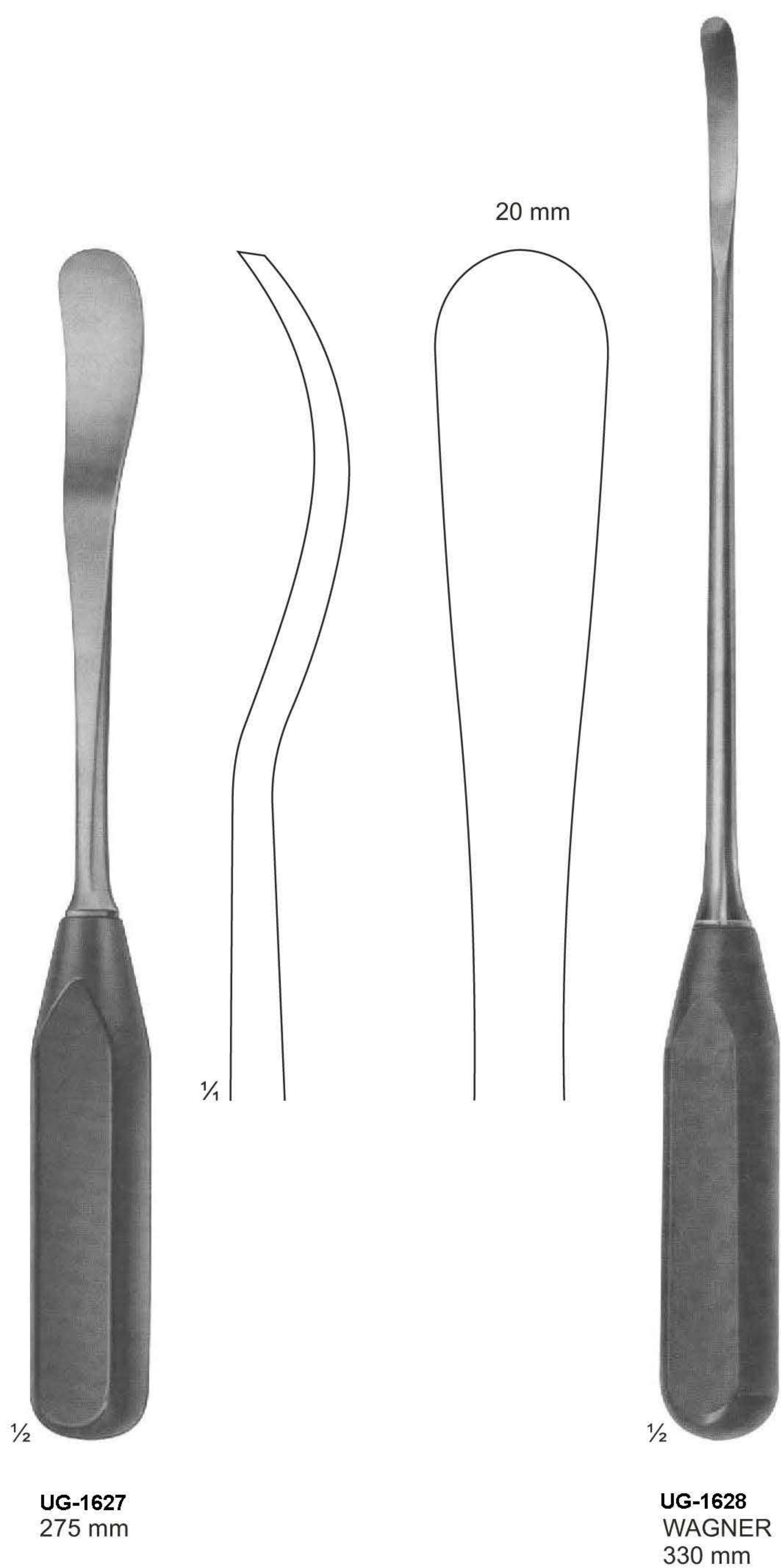

# Bone File and Rasps



**UG-1629**  
JOSEPH  
fine, chequered

coarse, chequered  
165 mm



**UG-1631**  
LEWIS  
fine, teeth



**UG-1632**  
MALTZ  
down stroke  
180 mm



**UG-1633**  
AUFRICHT  
up stroke

down stroke  
220 mm



**UG-1634**  
GALLAHER  
190 mm



# Bone File and Rasps

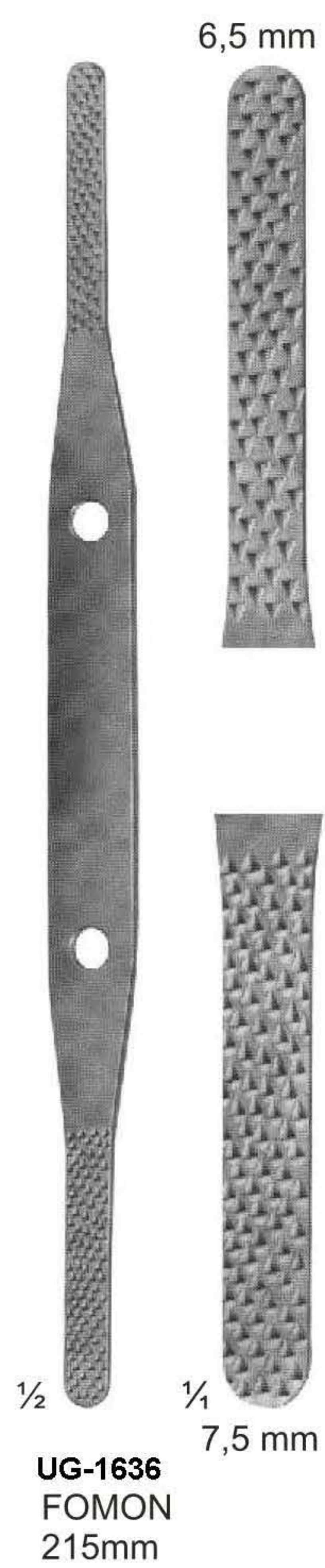
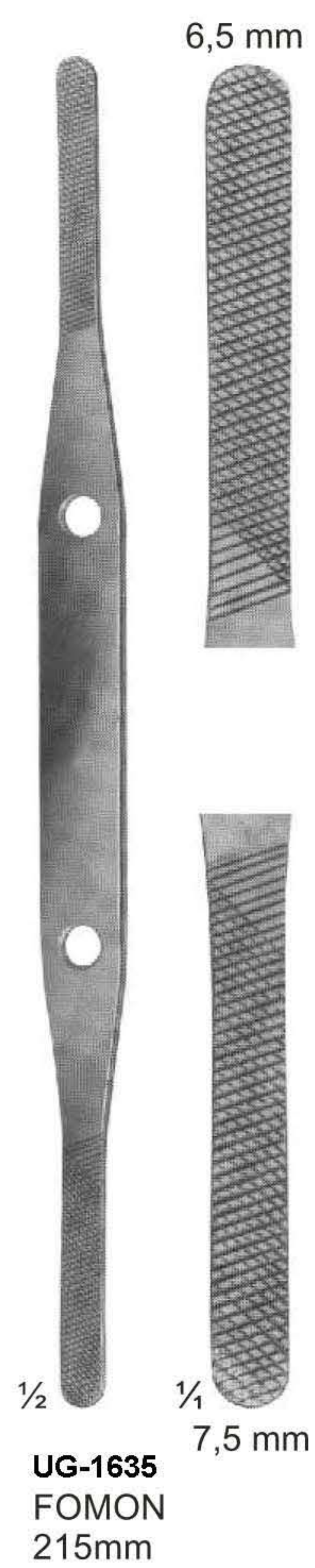

# Bone File and Rasps

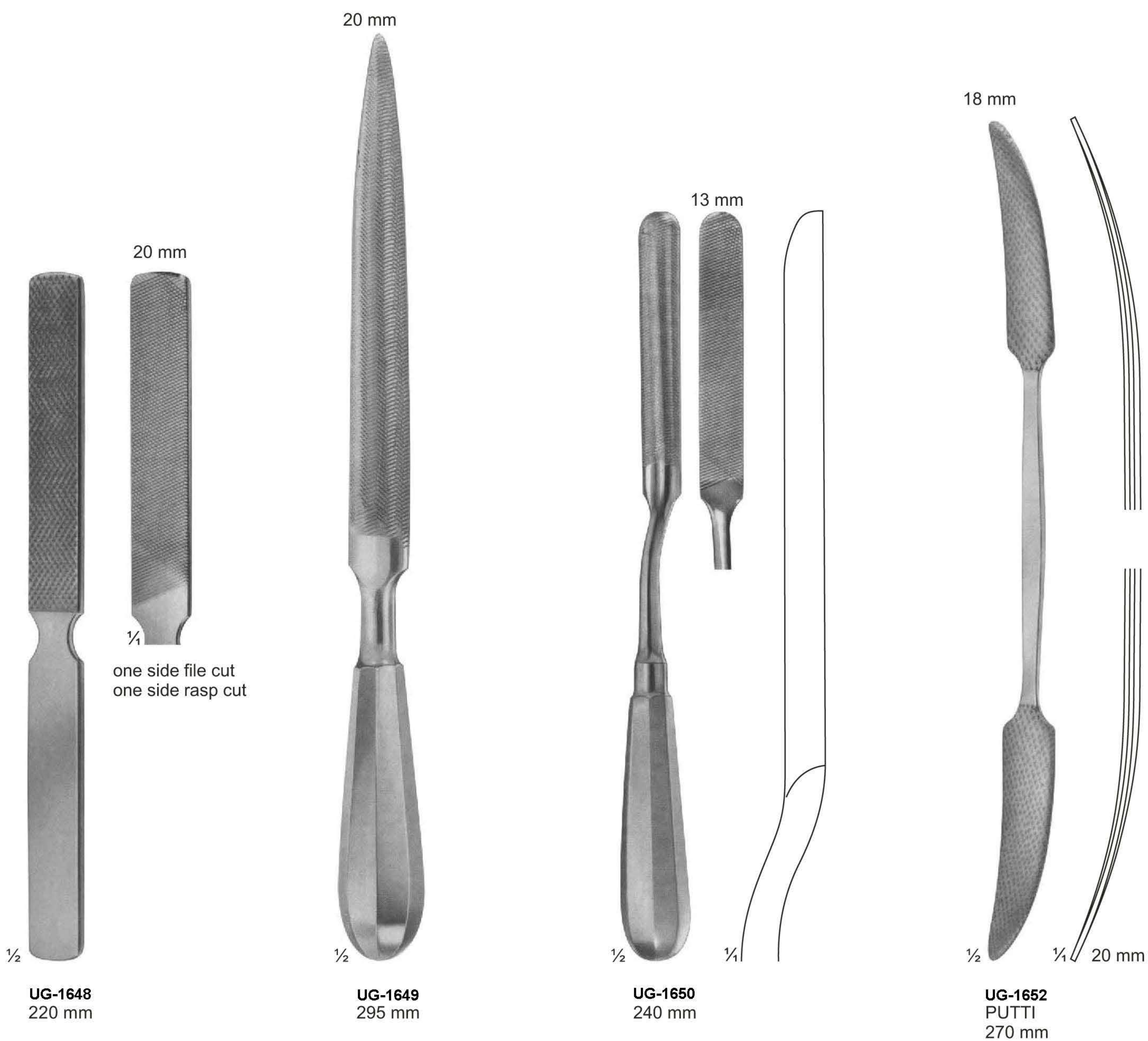

# Bone Curettes

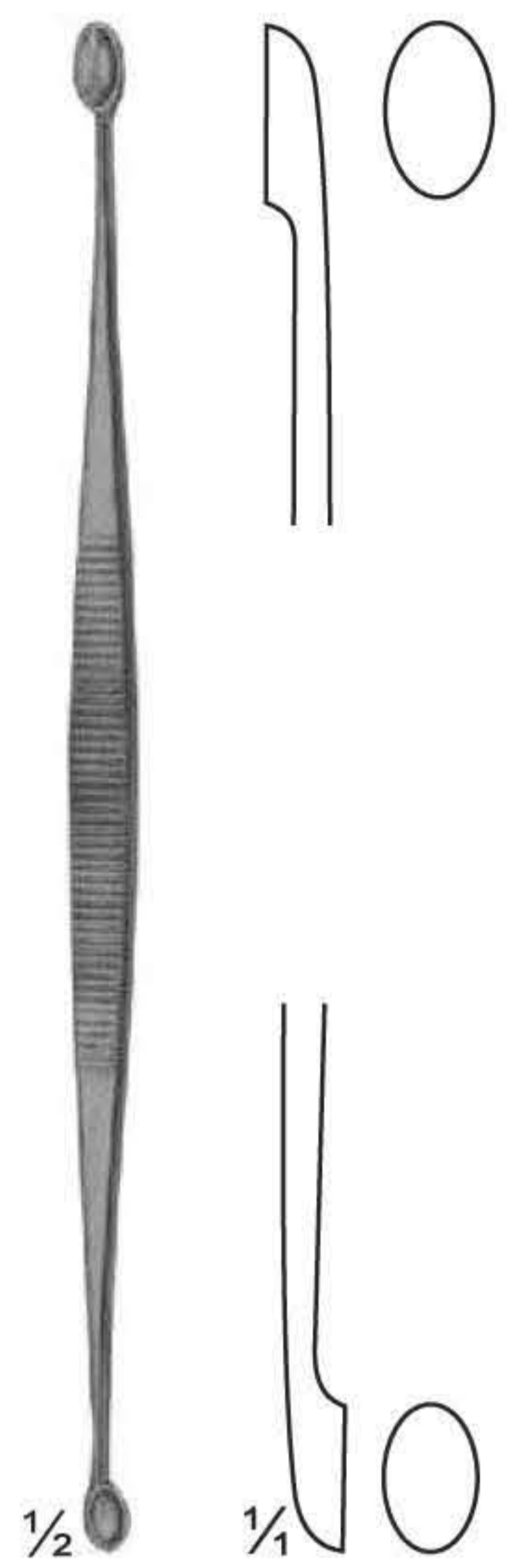

**UG-1653**  
JACOBSON  
140 mm

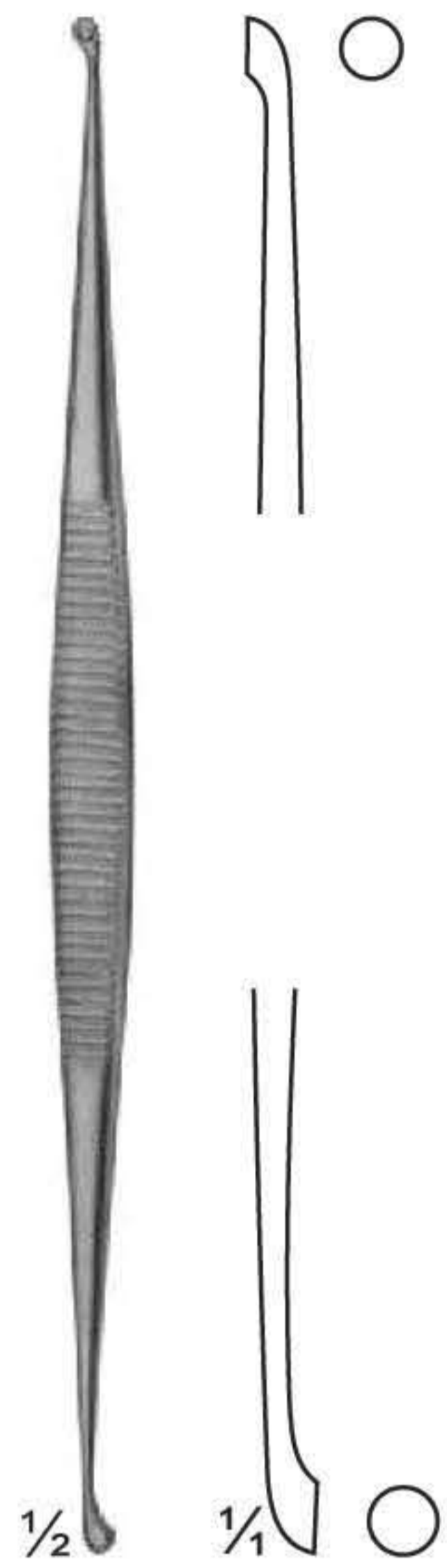

**UG-1654**  
MARTINI  
140 mm

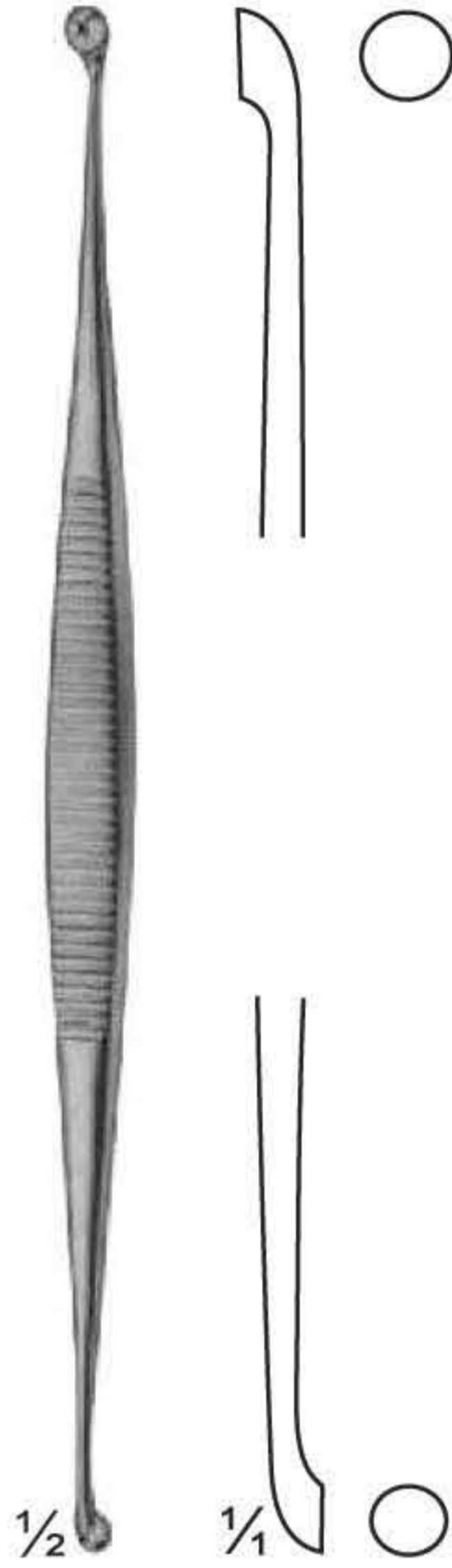

**UG-1655**  
MARTINI  
140 mm



**UG-1657**  
WILLIGER  
145 mm

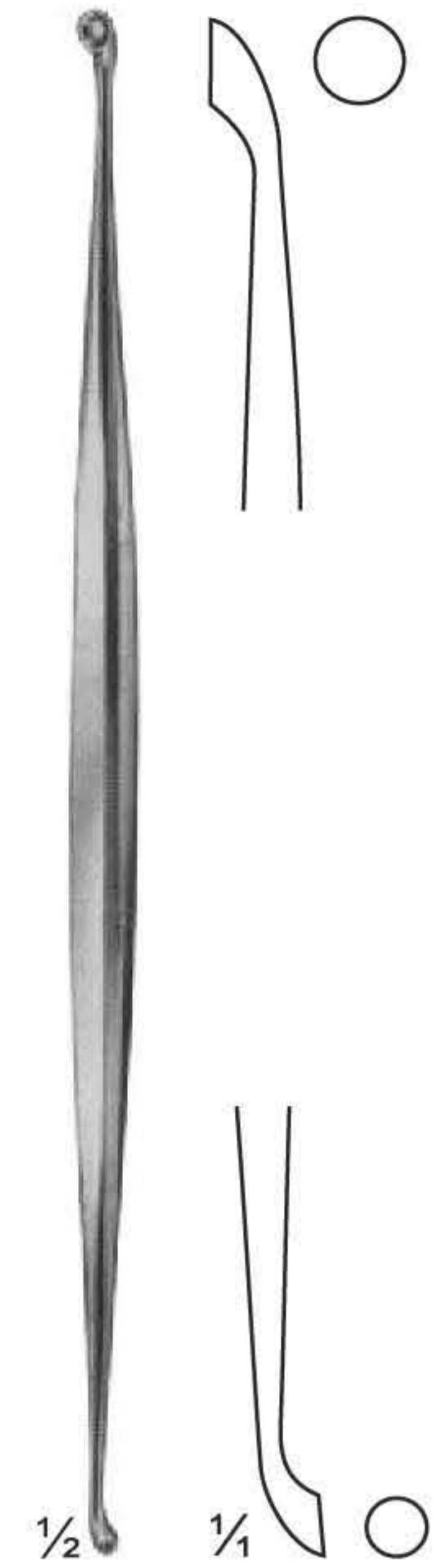

**UG-1658**  
JANSEN  
160 mm



**UG-1659**  
BARTH  
180 mm

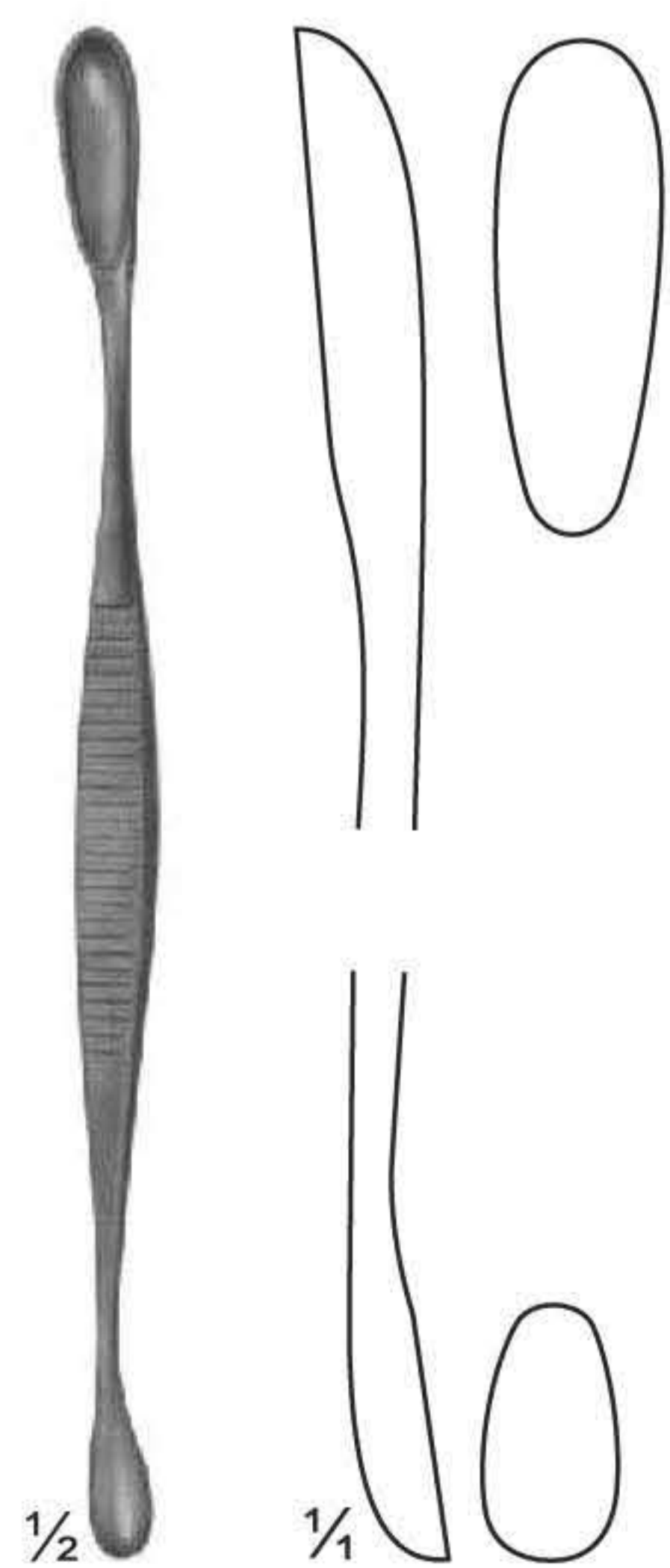

**UG-1660**  
VOLKMANN  
130 mm

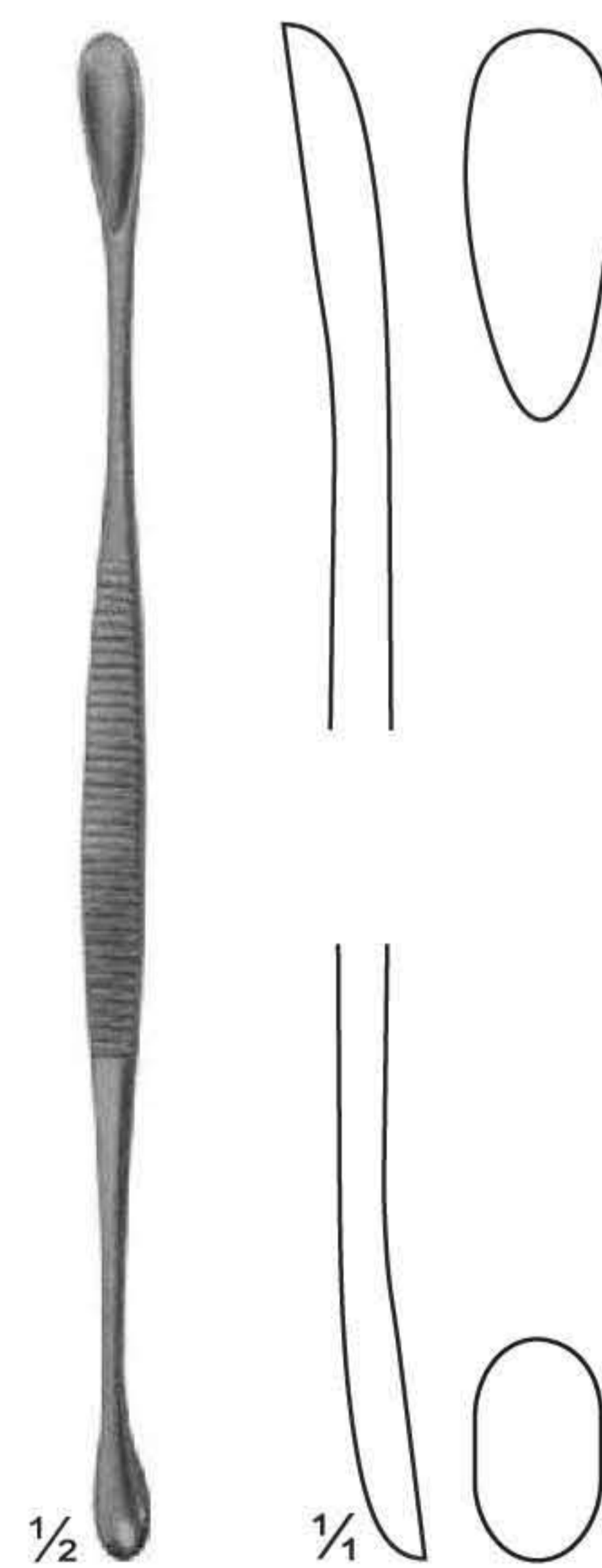

**UG-1662**  
VOLKMANN  
145 mm

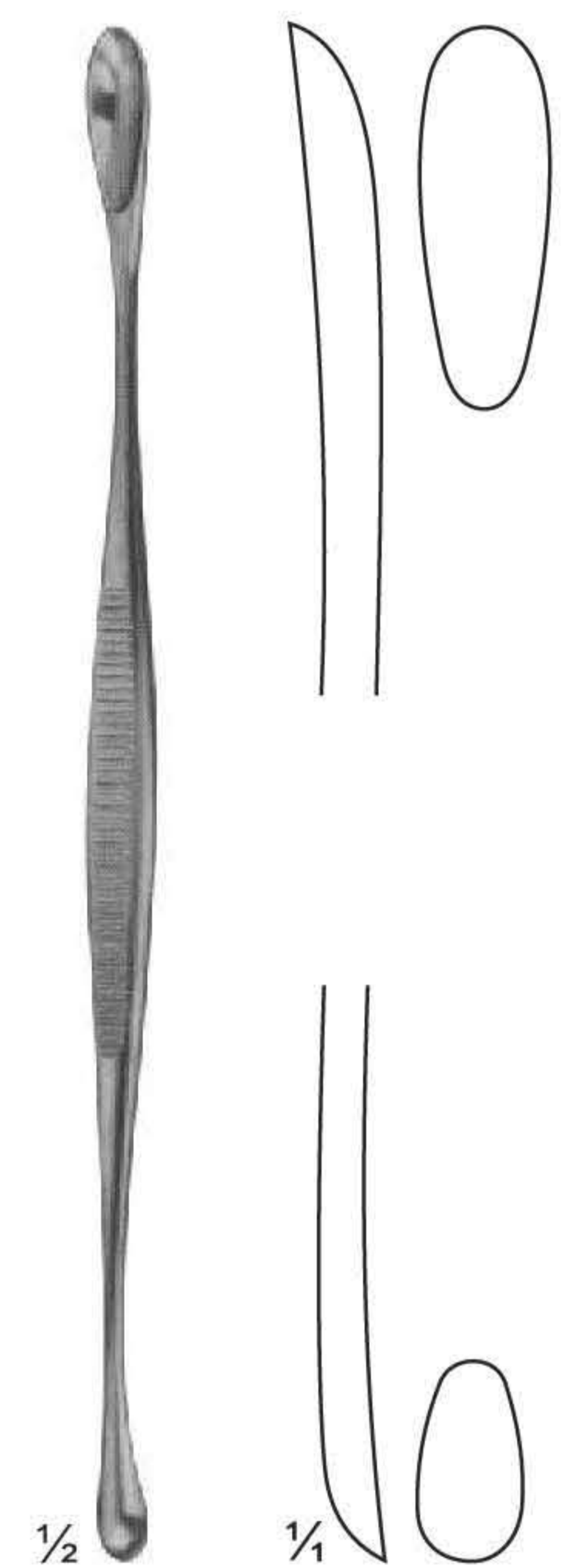

**VOLKMANN**  
170 mm

# Bone Curettes



**UG-1665**  
JANSEN  
160 mm

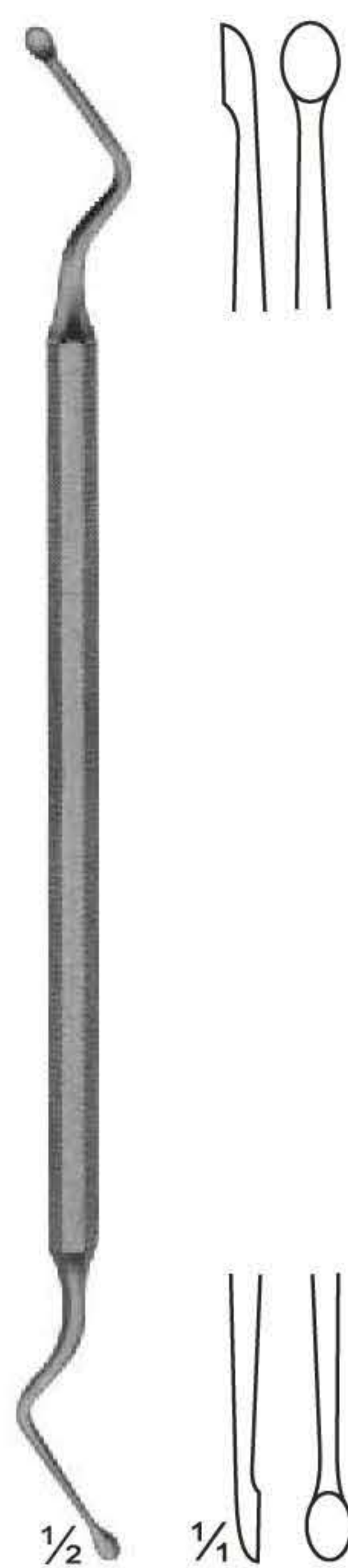

**UG-1666**  
HEMINGWAY  
170 mm

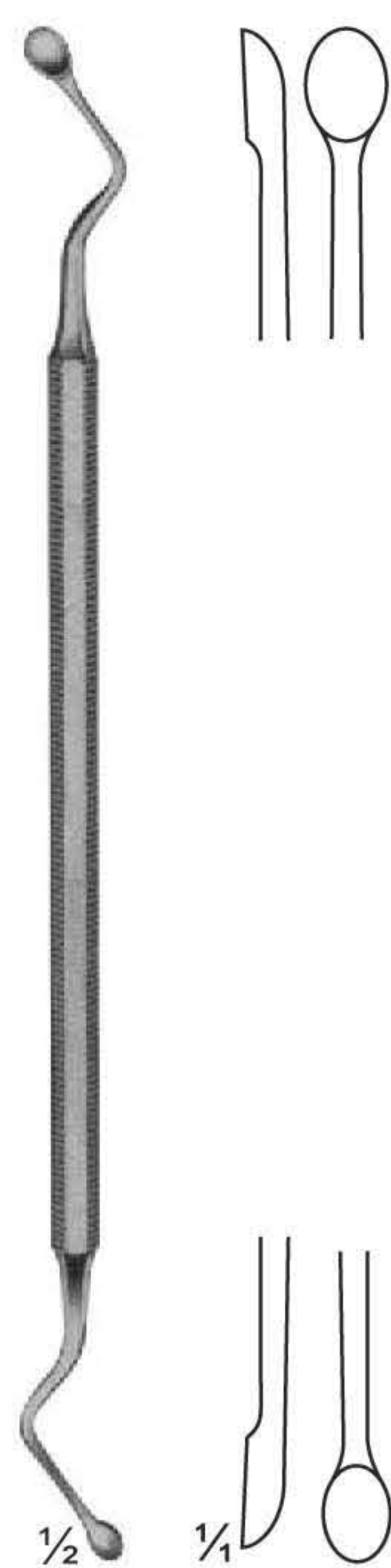

**UG-1668**  
HEMINGWAY  
175 mm

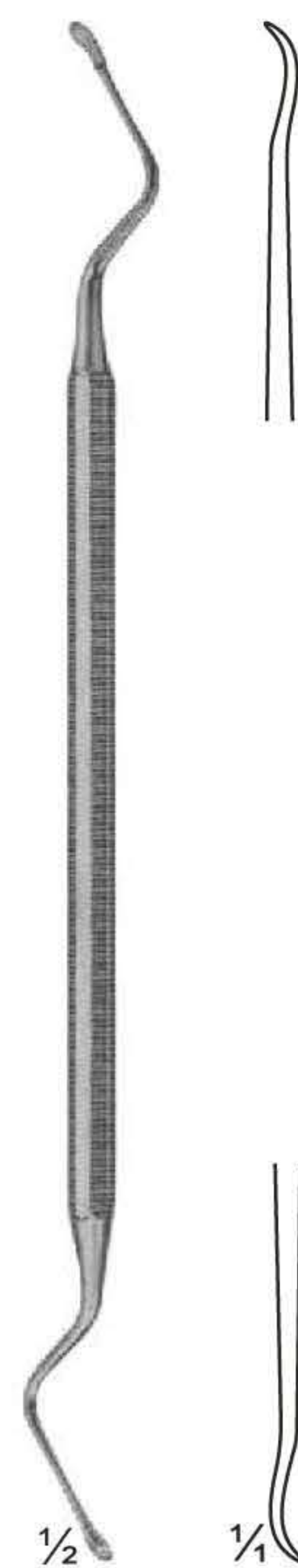

**UG-1672**  
LUCAS  
180 mm

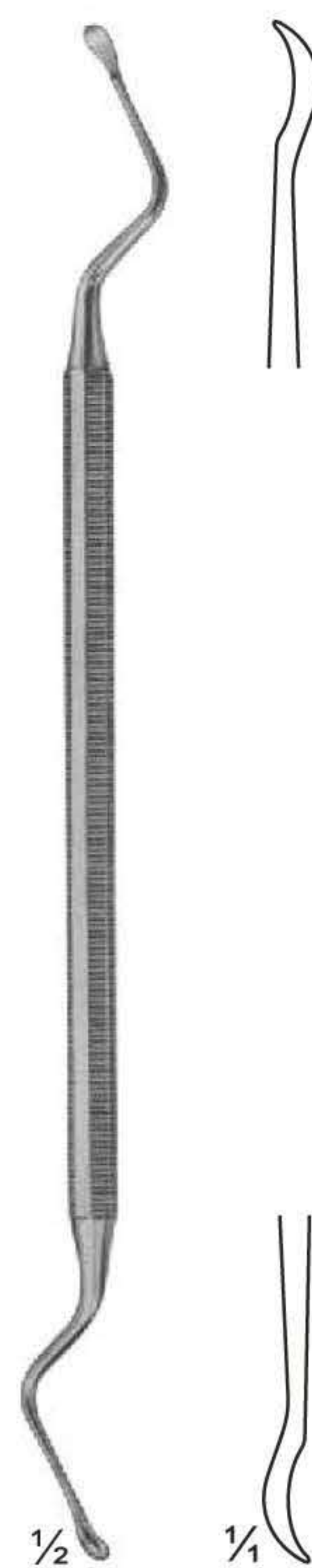

**UG-1673**  
LUCAS  
185 mm



**UG-1674**  
KERPEL  
145 mm



**UG-1677**  
KERPEL  
145 mm

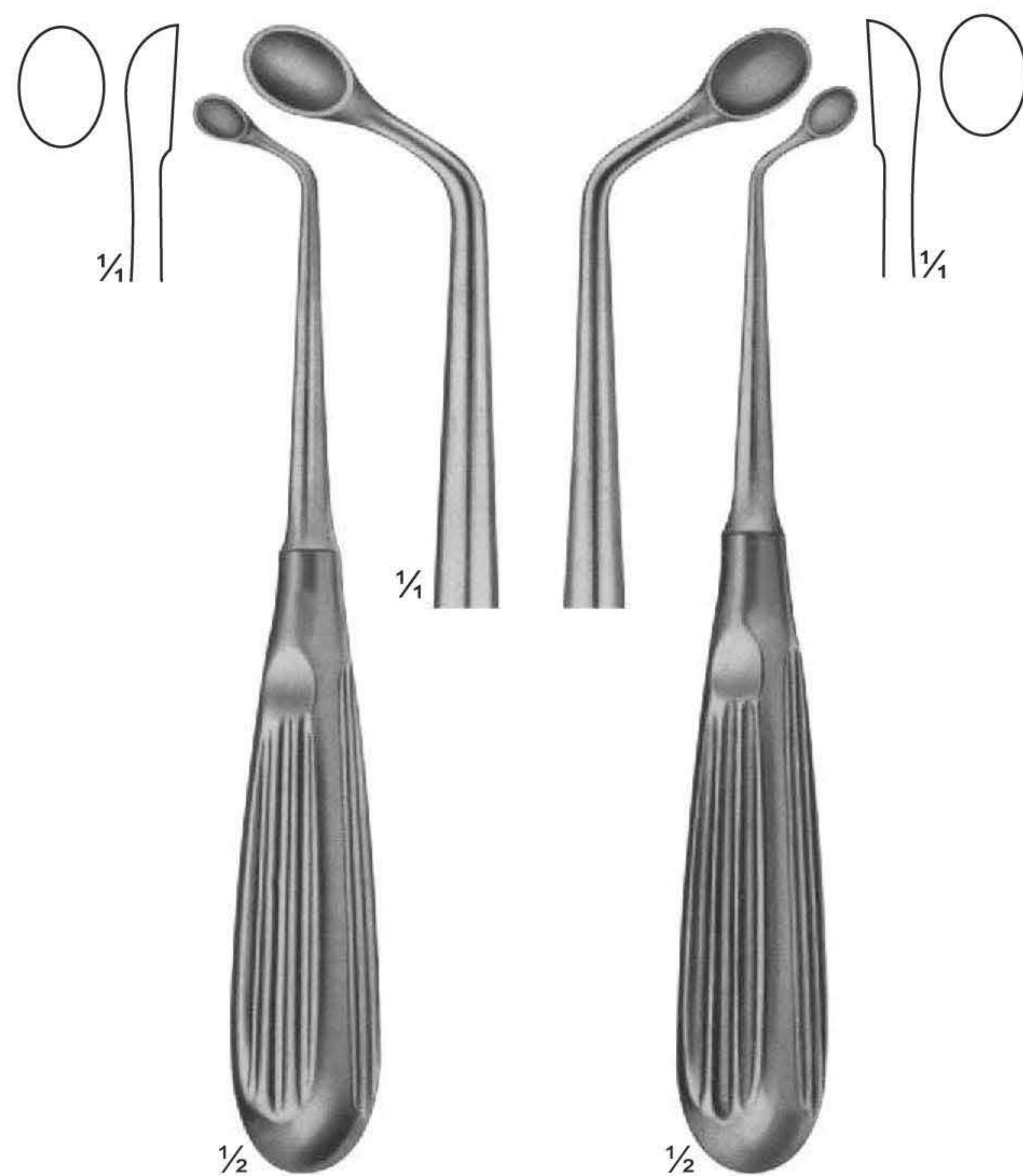

**UG-1678**  
UFFENORDE  
170 mm

**UG-1679**  
UFFENORDE  
170 mm

# Bone Curettes

---



**UG-1681**  
BRUNS  
165 mm



**UG-1683**  
SCHEDE  
170 mm



**UG-1685**  
VOLKMANN  
170 mm



**UG-1690**  
WILLIGER  
170 mm

# Bone Curettes



½  
**UG-1692**  
LEMPERT  
215 mm



½  
**UG-1695**  
HALLE  
215 mm



½  
**UG-1697**  
DAUBENSPECK  
200 mm



½  
**UG-1700**  
250 mm



½  
**UG-1705**  
250 mm



½  
**UG-1710**  
BUSHE  
250 mm

# Bone Curettes

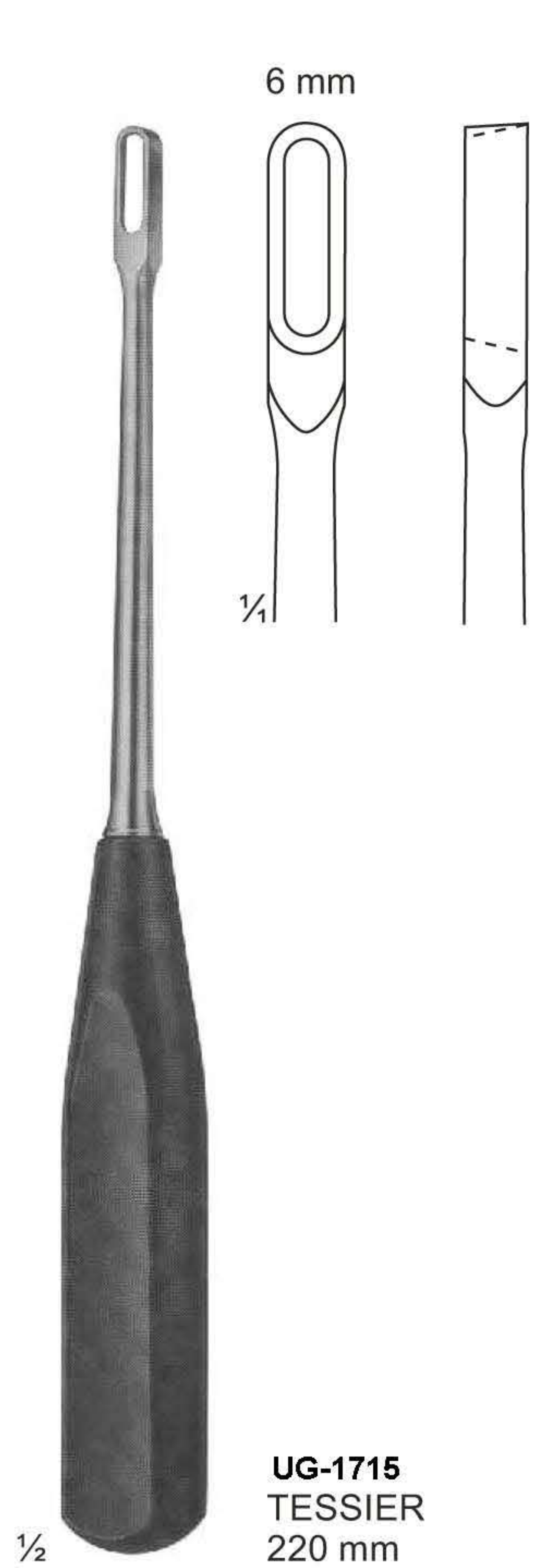

**UG-1715**  
TESSIER  
220 mm



**UG-1716**  
SIMON  
235 mm



**UG-1720**  
SIMON  
240 mm



**UG-1726**  
CASPAR  
220 mm



**UG-1728**  
CASPAR  
220 mm



**UG-1729**  
CASPAR  
toothed  
220 mm

# Bone Currettes



**UG-1731**  
270 mm



**UG-1733**  
SYPERT  
380 mm



# Mallets



UG-1603  
MEAD  
185 g  
with interchangeable  
plastic disks  
190 mm  
  
pair of spare disks



UG-1604  
140 g  
with interchangeable  
plastic disks  
185 mm  
  
pair of spare disks



UG-1605  
COTTLE  
140 g  
1 Seite convex  
1 Side convex  
185 mm



UG-1606  
165 g  
lead filled head  
190 mm

# Mallets



Ø 27 mm

1/2

UG-1637  
HAJEK  
140 g  
215 mm



Ø 30 mm

1/2

UG-1639  
215 g  
with interchangeable  
plastic disks  
245 mm

pair of spare disks



1/2

UG-1640  
WAGNER  
complete with:  
1 pair of metal disks and  
1 pair of plastic disks and  
1 wrench 566  
235 mm

# Mallets



UG-1642  
BERGMANN  
245 mm



UG-1643  
BERGMANN  
235 mm



UG-1644  
OMBREDANNE  
240 mm

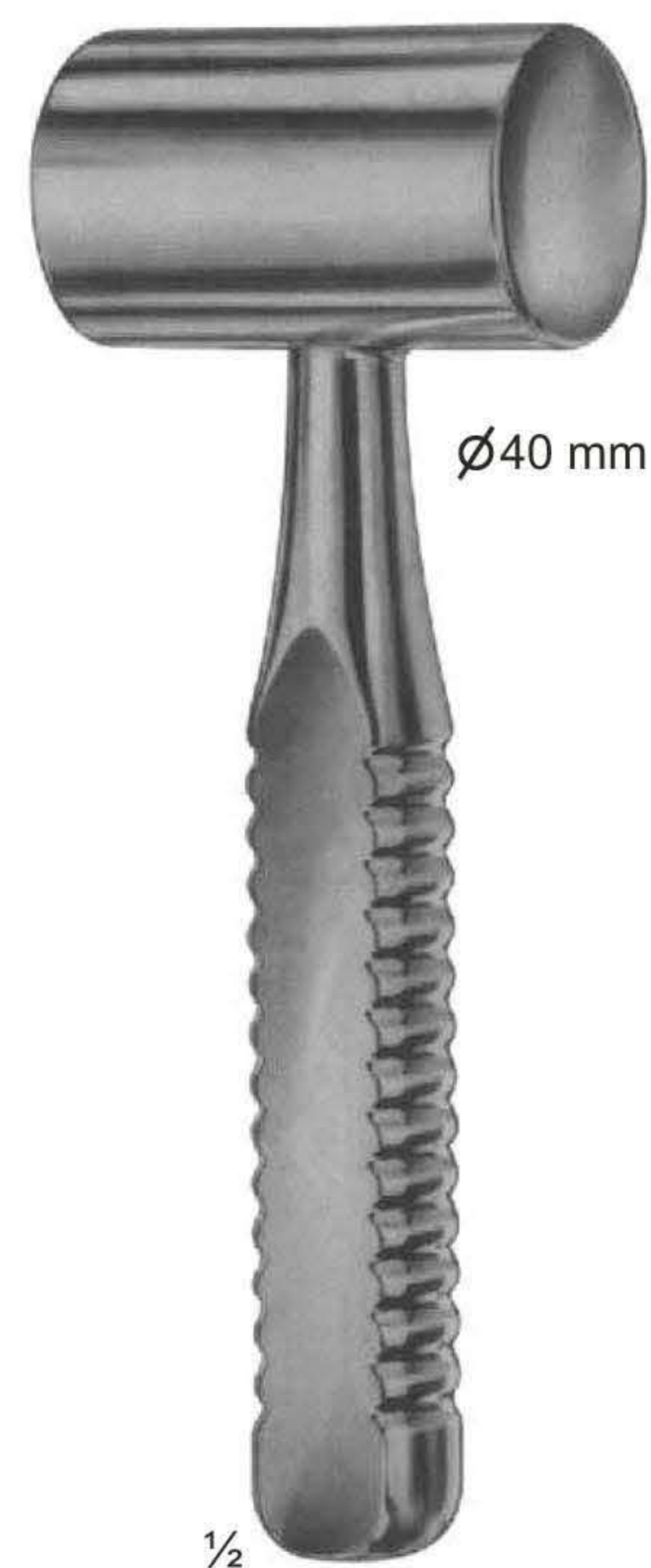

UG-1645  
HEATH  
copper filled head  
700 g  
185 mm

# Tampers - Osteotomes, Chisels and Gouges

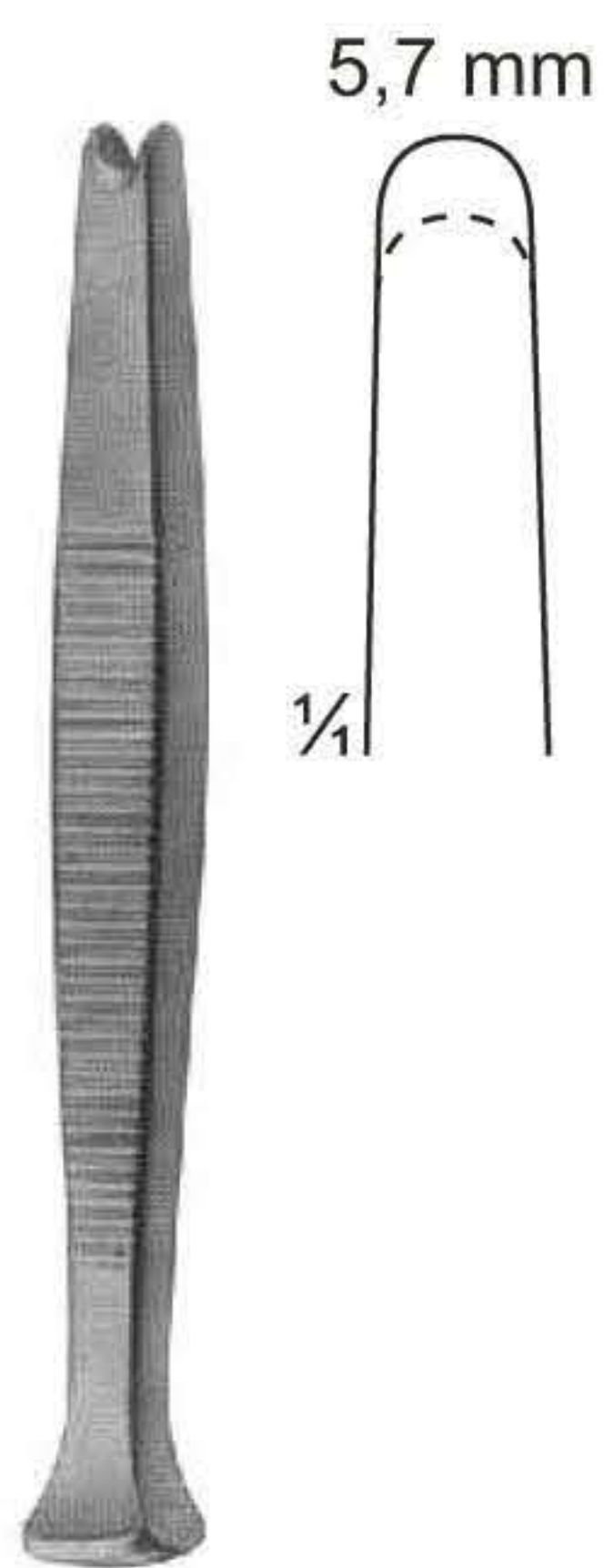

UG-1646  
Haase  
100 mm

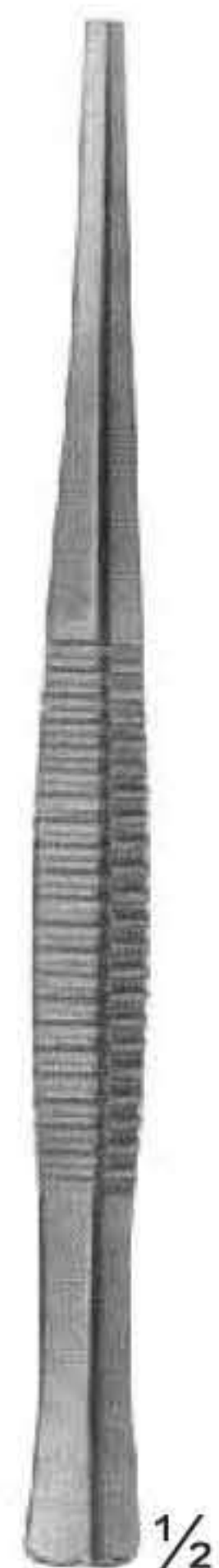

UG-1647  
PASSOW  
120 mm



UG-1651  
CASPER  
200 mm



UG-1656  
200 mm

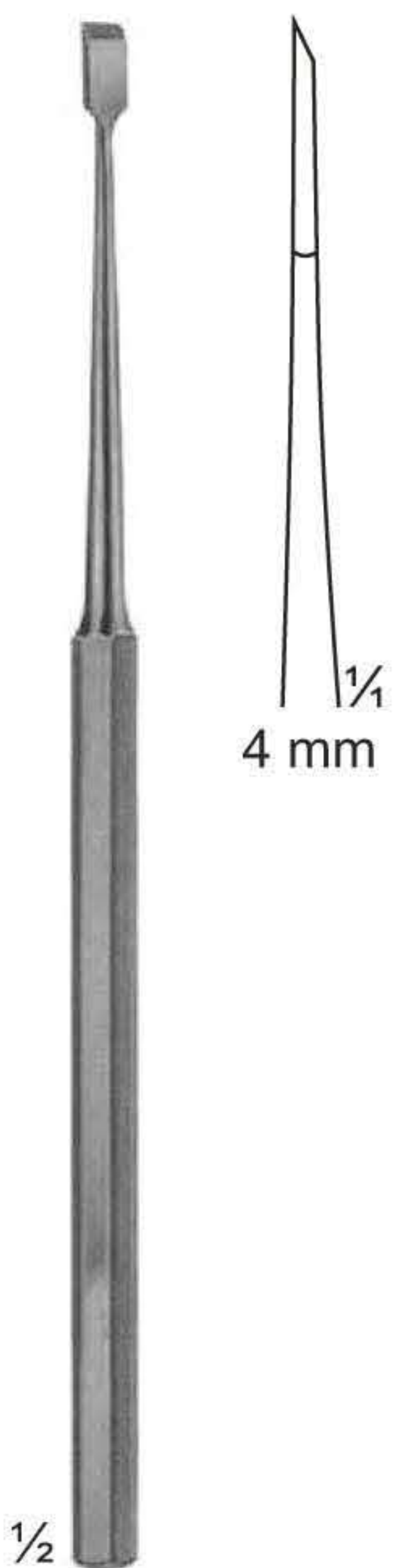

UG-1661  
FREER  
Chisel  
160 mm

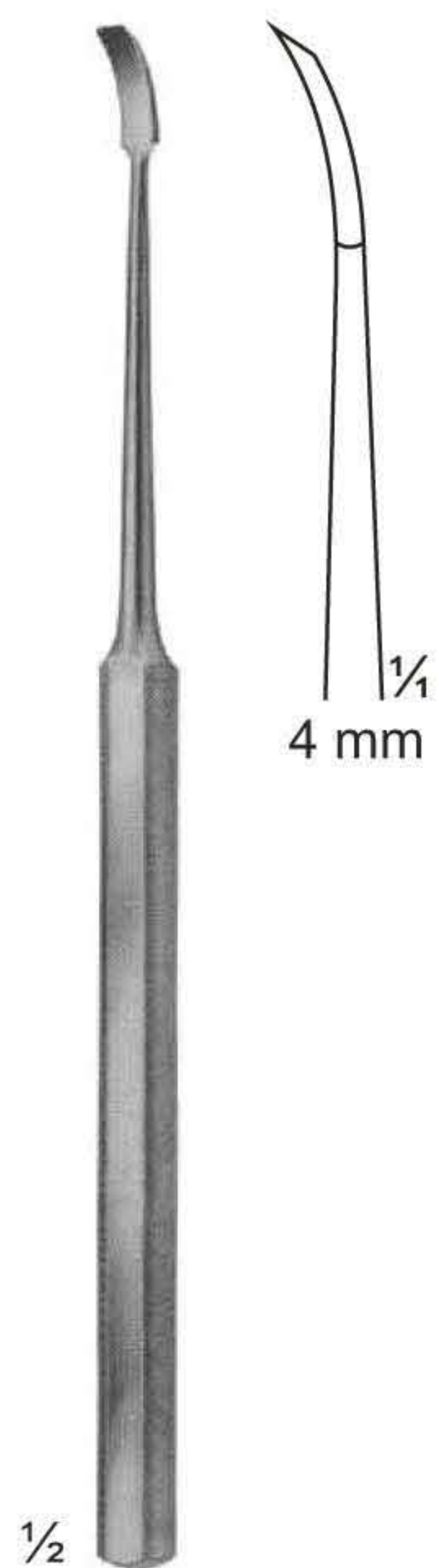

UG-1664  
FREER  
Chisel, curved  
160 mm

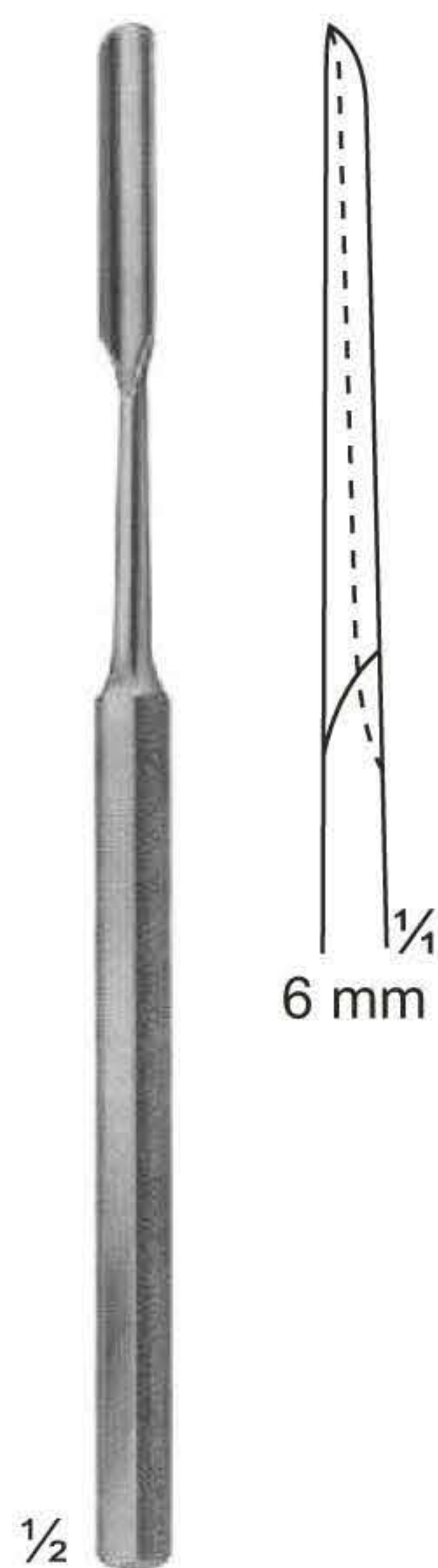

UG-1667  
FREER  
Gouge  
150 mm

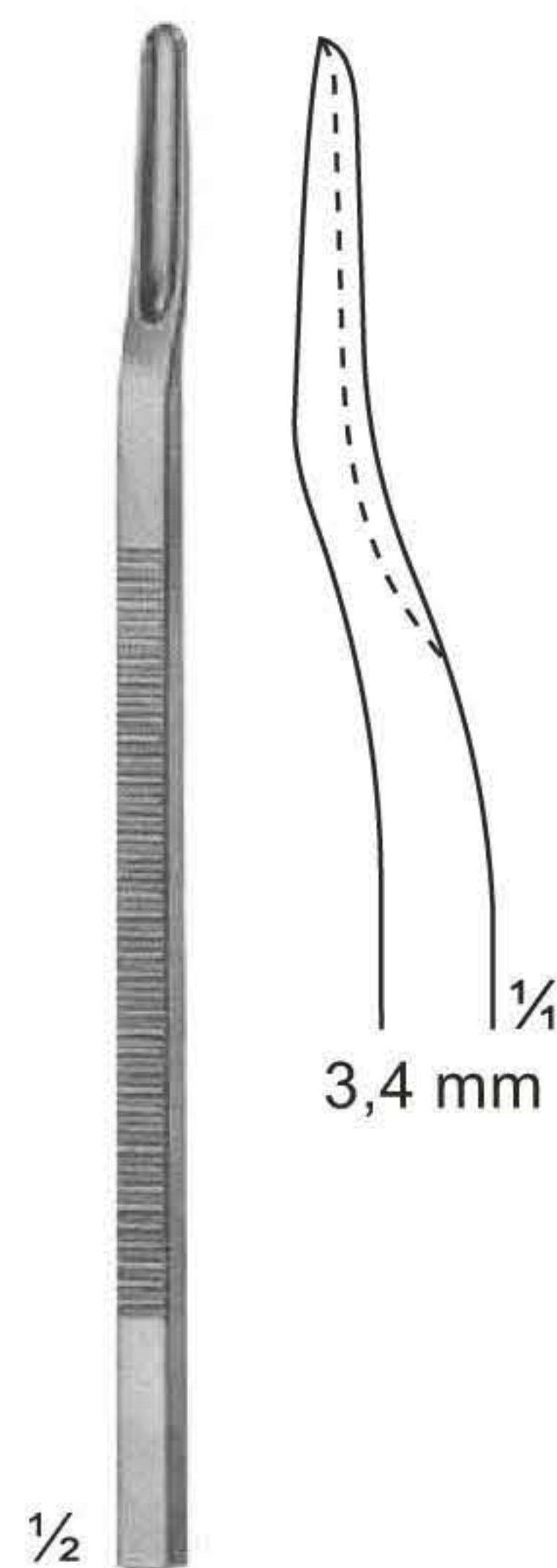

UG-1669  
Scaphoid gouge,  
downwards curved  
135 mm

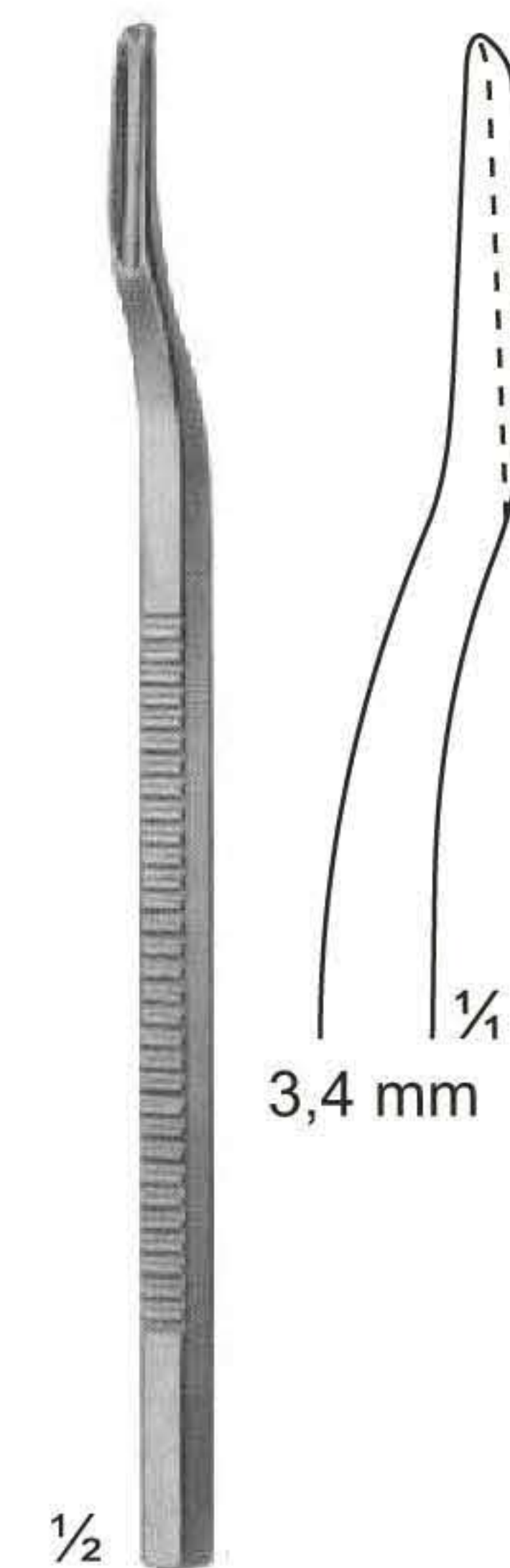

UG-1670  
Scaphoid gouge,  
upwards curved  
135 mm

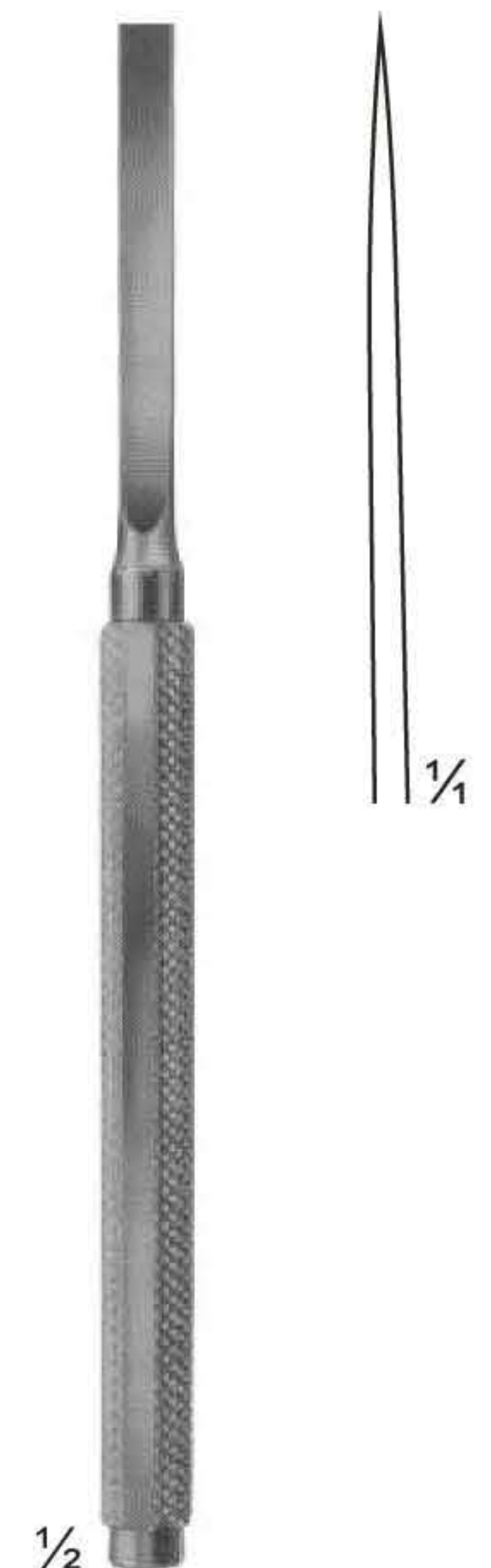

UG-1671  
Mannerfelt  
21-131A 4 mm  
21-132 6 mm  
21-133 8 mm  
155 mm

# Osteotomes Chisels and Gouges



1/2  
UG-1675  
Mannerfelt  
155 mm



1/2  
UG-1676  
Osteotome  
140 mm



1/2  
UG-1680  
Chisels  
140 mm



1/2  
UG-1682  
Gouges  
140 mm



1/2  
PARTSCH  
UG-1684  
Chisels  
140 mm



1/2  
PARTSCH  
UG-1686  
Chisels  
170 mm



1/2  
PARTSCH  
UG-1689  
Gouges  
140 mm



1/2  
PARTSCH  
UG-1691  
Gouges  
170 mm



1/2  
LUCAS  
UG-1693  
Chisels  
140 mm



1/2  
LUCAS  
UG-1694  
Gouges  
160 mm

# Osteotomes Chisels and Gouges



$\frac{1}{2}$   
ALEXANDER  
UG-1696  
Gouges  
170 mm



$\frac{1}{2}$   
LAMBOTTE  
UG-1699  
Osteotome  
125 mm



$\frac{1}{2}$   
COTTLE  
UG-1702  
Osteotome with depth  
markings  
180 mm



$\frac{1}{2}$   
COTTLE  
UG-1708  
Chisel-Osteotomes  
with depth markings  
180 mm



$\frac{1}{2}$   
COTTLE  
UG-1712  
Fishtail Chisel,  
with protected ends  
180 mm



$\frac{1}{2}$   
STILLE  
UG-1713  
Chisels  
205 mm



$\frac{1}{2}$   
STILLE  
UG-1718  
Gouges  
205 mm



$\frac{1}{2}$   
WALTER  
UG-1724  
Osteotomes  
gouges for taking  
grafts from the rib  
205 mm



$\frac{1}{2}$   
STILLE  
UG-UG-1725  
Osteotomes  
205 mm

# Osteotomes

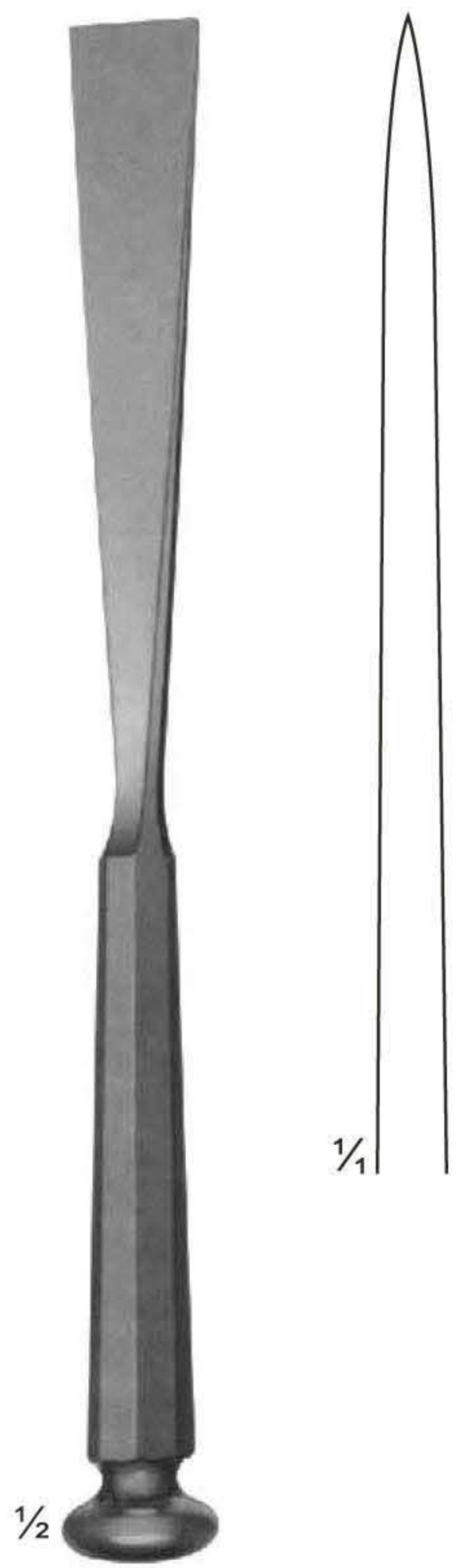

10 mm  
12 mm  
15 mm  
20 mm  
25 mm

STILLE  
UG-1727  
Osteotomes  
205 mm

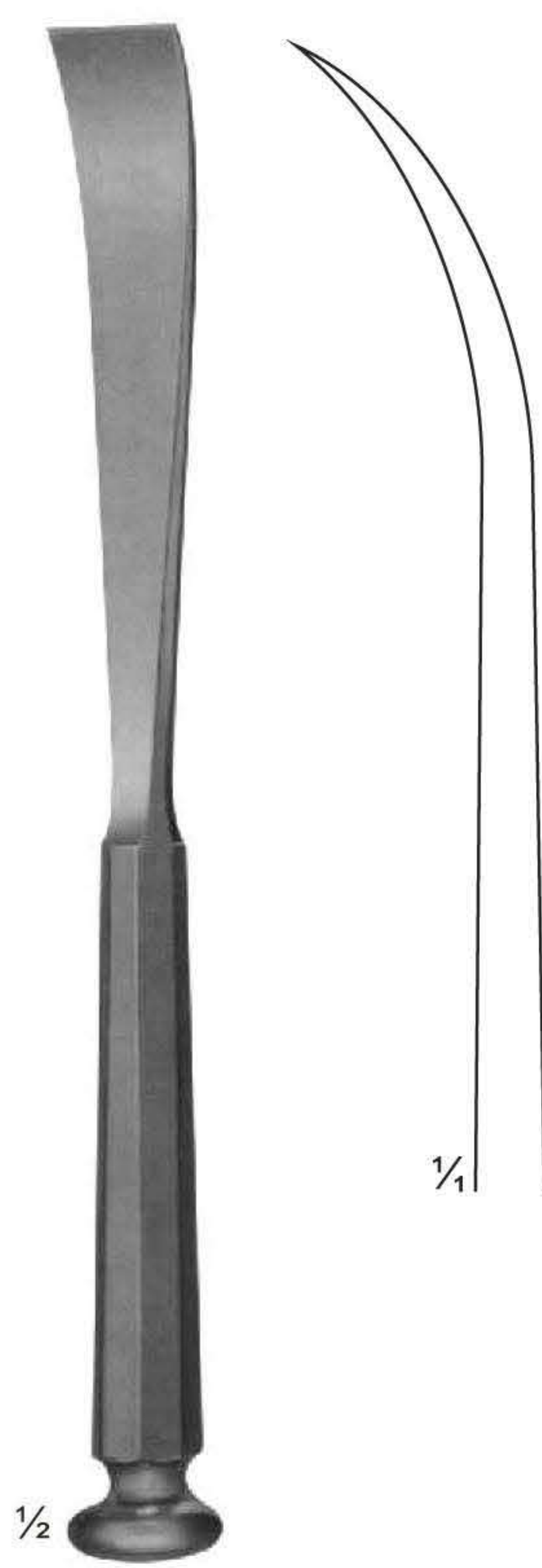

10 mm  
12 mm  
15 mm  
20 mm  
25 mm

STILLE  
UG-1730  
Osteotomes, curved  
205 mm



LAMBOTTE  
UG-1732  
Osteotomes  
245 mm



4 mm  
8 mm  
10 mm  
13 mm  
15 mm  
18 mm  
20 mm  
25 mm  
30 mm  
38 mm  
44 mm  
50 mm



LAMBOTTE  
UG-1734  
Osteotomes, curved  
245 mm

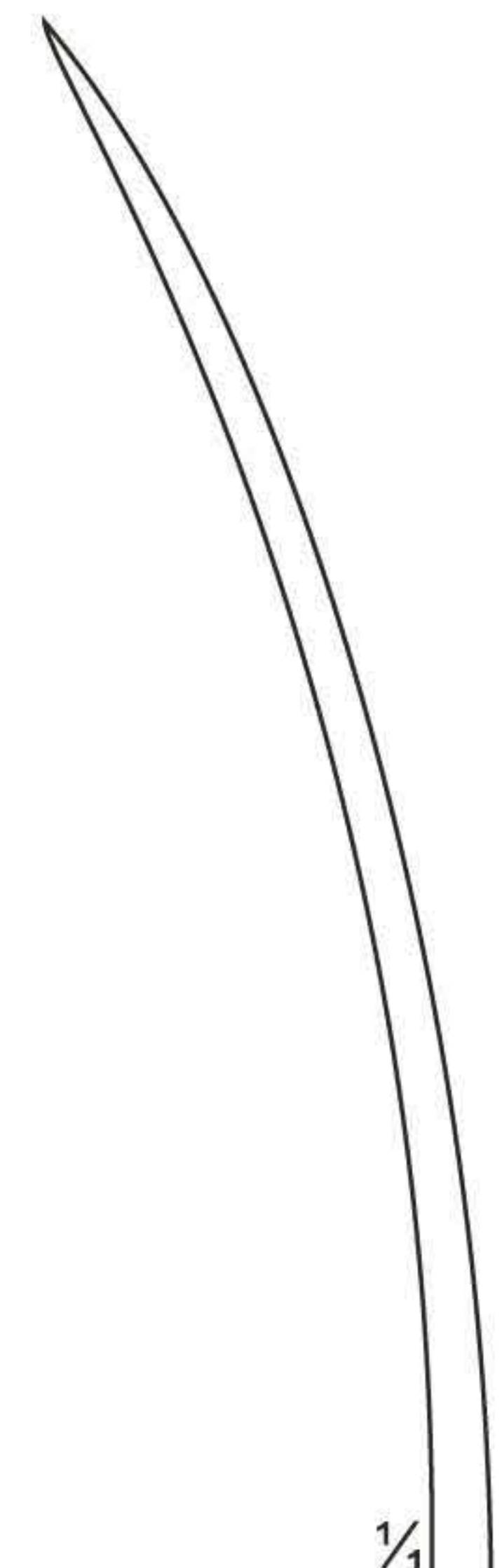

8 mm  
13 mm  
18 mm  
25 mm  
30 mm  
38 mm

# Osteotomes, Chisels and Gouges with HARTPRESS -handle



LEXER-MINI  
UG-1735  
Osteotomes  
180 mm



LEXER-MINI  
UG-1736  
Gouges  
180 mm



LEXER  
UG-1737  
Osteotomes  
220 mm



LEXER  
UG-1744  
Gouges  
220 mm



LEXER  
UG-1753  
Gouge for  
removing broken  
screws  
220 mm

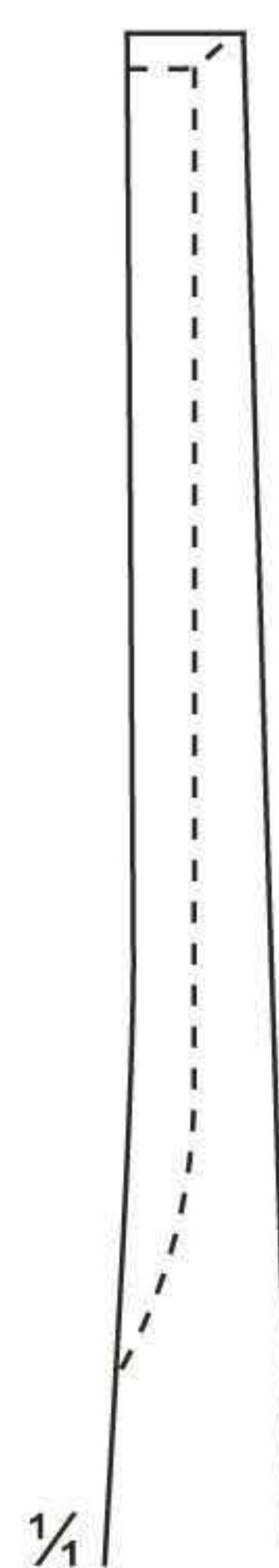

1/1



ZIELKE  
UG-1754  
Gouge for  
scoliosis-operations  
230 mm



## Osteotomes ,Chisels and Gouges with HARTPRESS -handle



1/2

LEXER  
UG-1756  
Osteotomes,  
angled  
275 mm



1/2

LEXER  
UG-1757  
Gouges,  
angled  
275 mm



1/2

21-268  
UG-1759  
245 mm



1/2

21-269  
UG-1762  
265 mm

# Reposition Forceps



**UG-1764**  
Reposition forceps,  
for small fragments  
135 mm

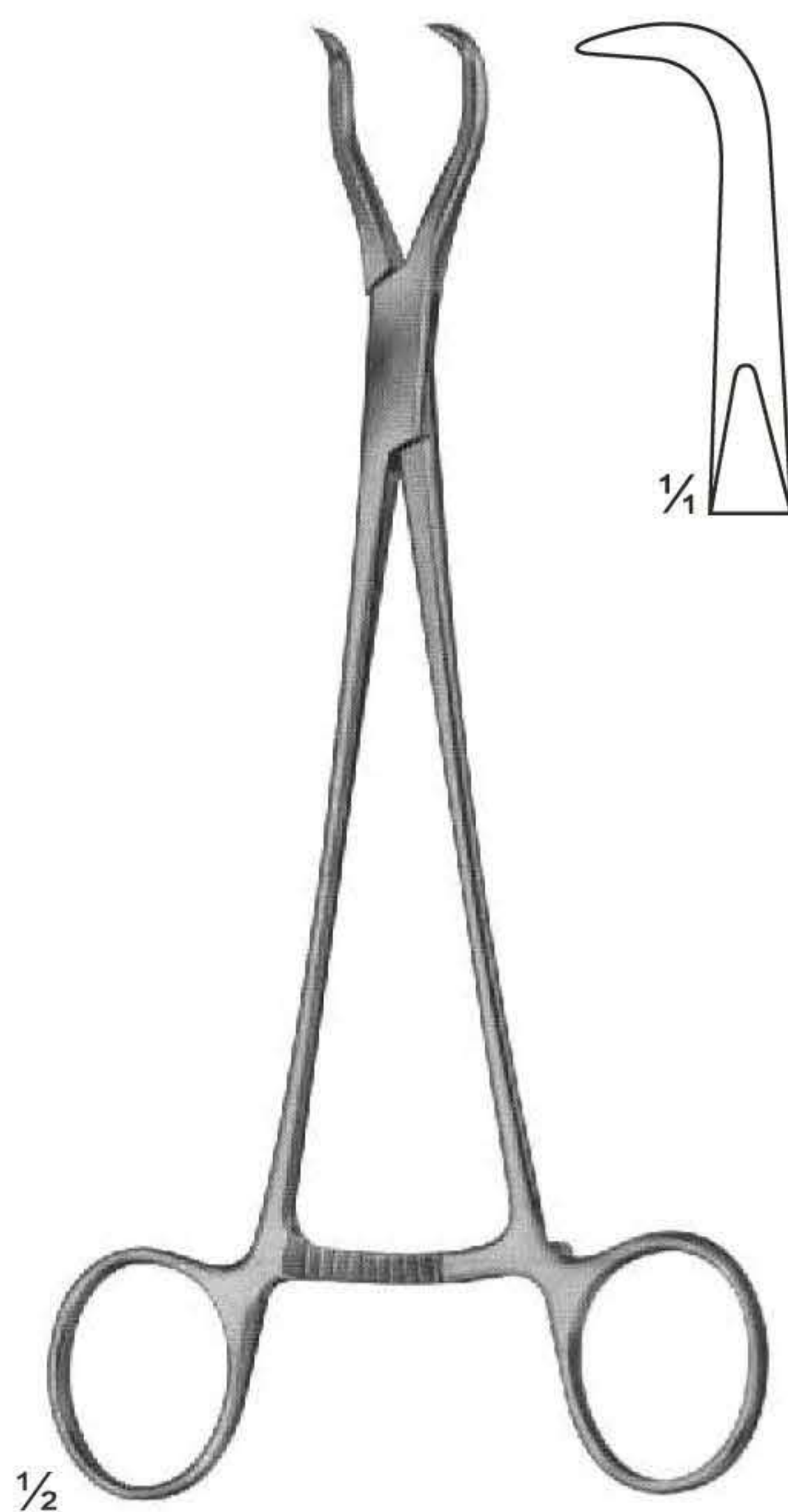

**HAASE**  
**UG-1765**  
Reposition forceps,  
for mandibular  
fractures  
165 mm

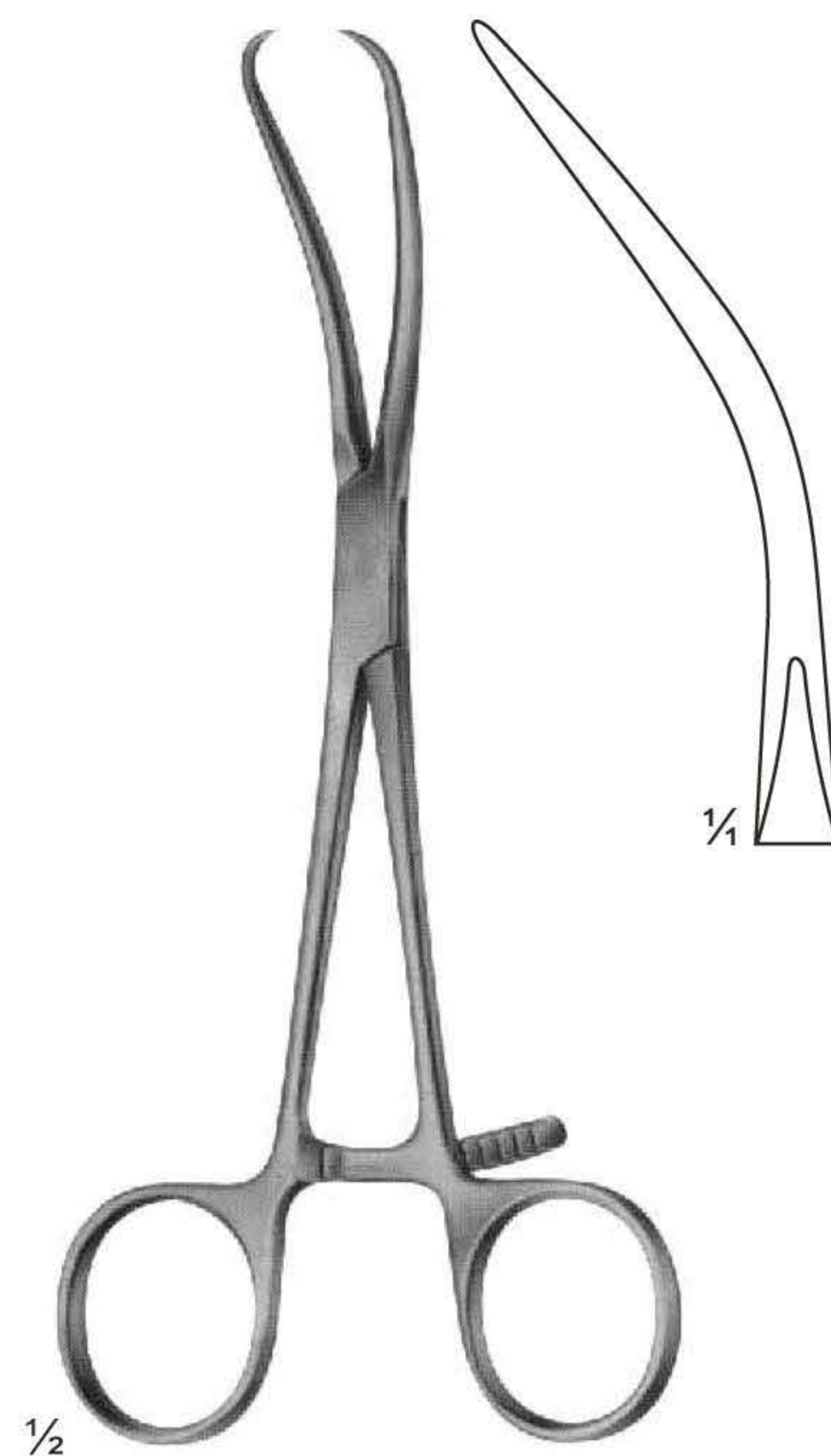

**REILL**  
**UG-1766**  
Reposition forceps,  
170 mm



**UG-1768**  
Reposition forceps  
205 mm

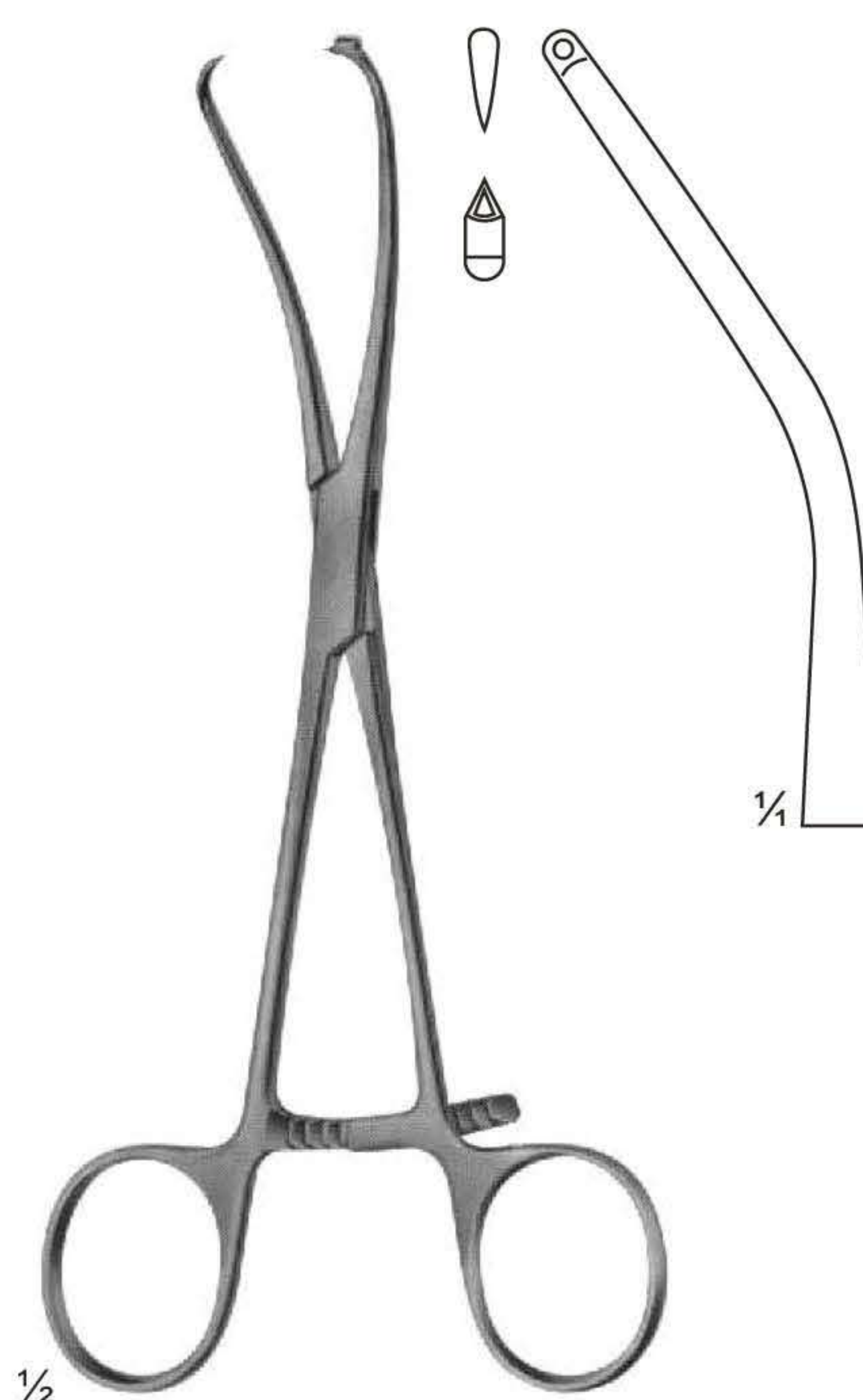

**MEYER**  
**UG-1769**  
Reposition forceps  
for fingers, with drill  
guide for KIRSCHNER  
wires up to daim.1.0 mm  
170 mm

# Reposition Forceps, Bone Holding Forceps



UG-1770  
Patella forceps  
185 mm



Forceps with  
ratchet fixation  
140 mm



UG-1771  
Forceps with  
thread fixation  
170 mm



UG-1773  
Forceps with  
thread fixation  
235 mm

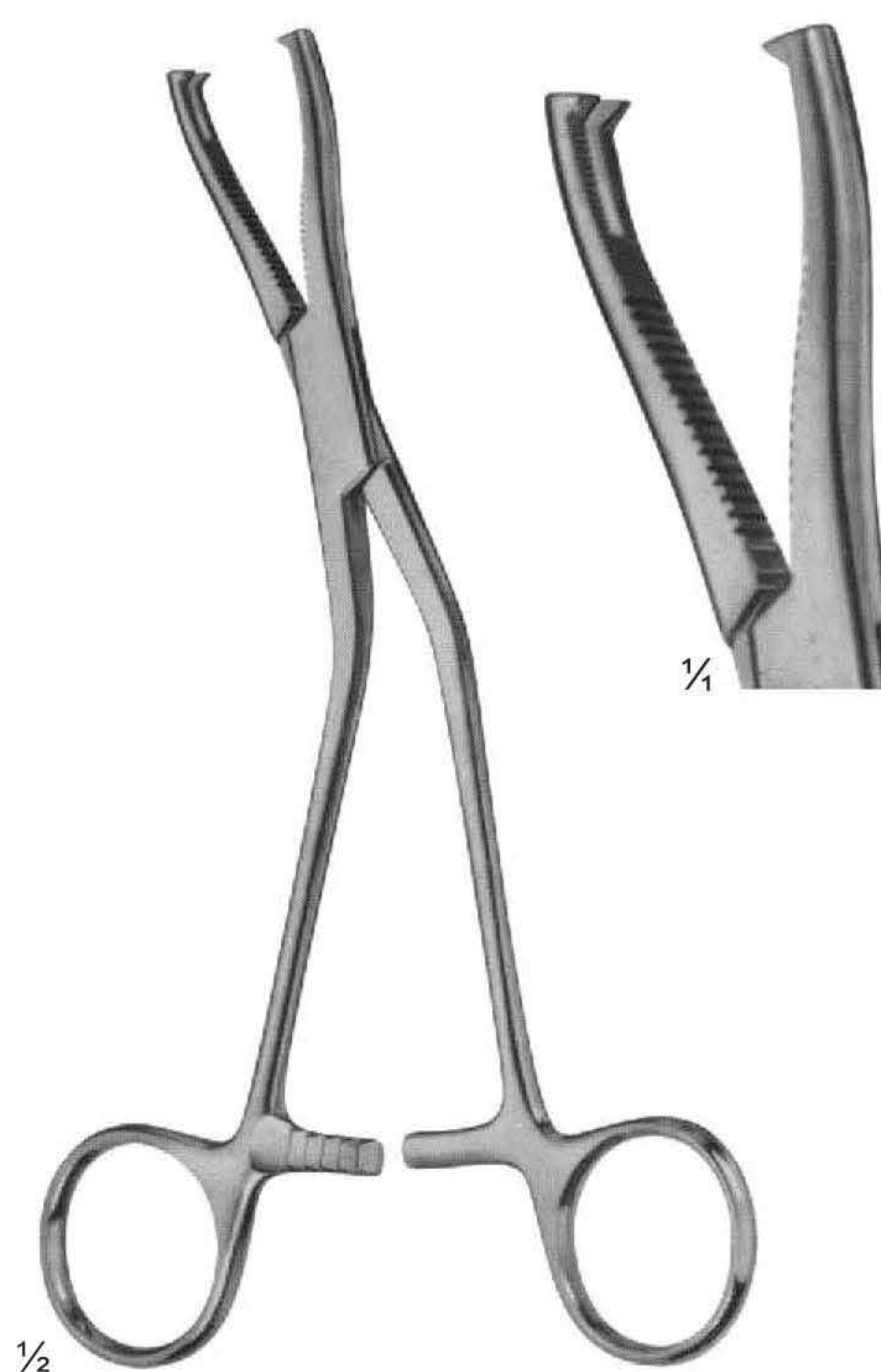

UG-1774  
DINGMANN  
185 mm

# Bone Holding Forceps



1/2

UG-1776  
Sequestrum  
forceps  
200 mm

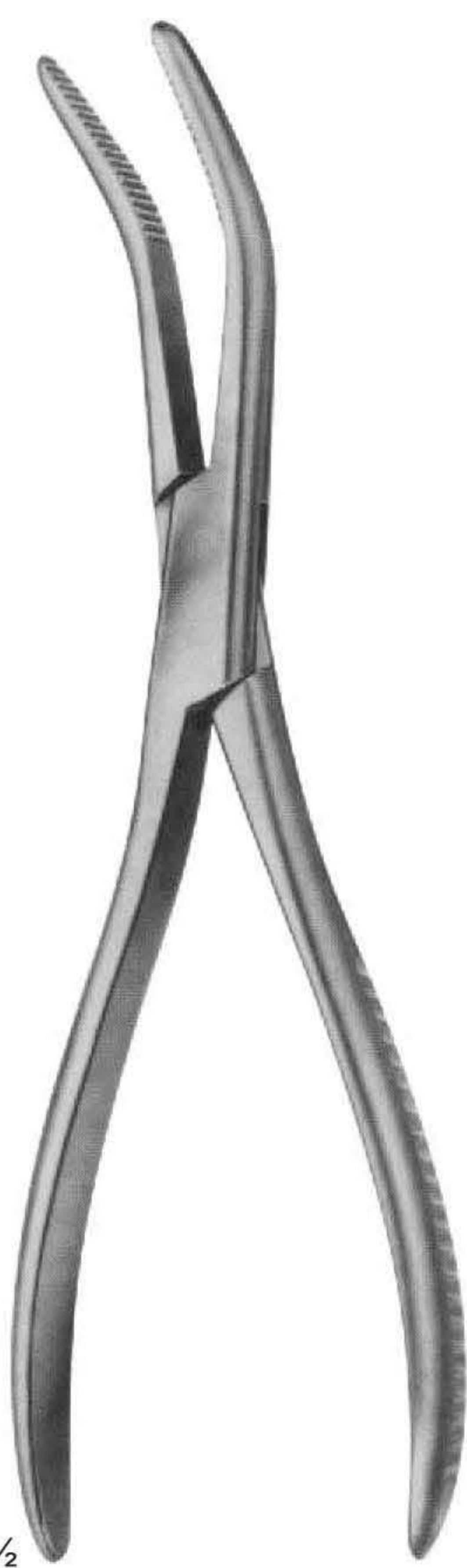

1/2

UG-1778  
VAN BUREN  
Sequestrum  
forceps  
225 mm

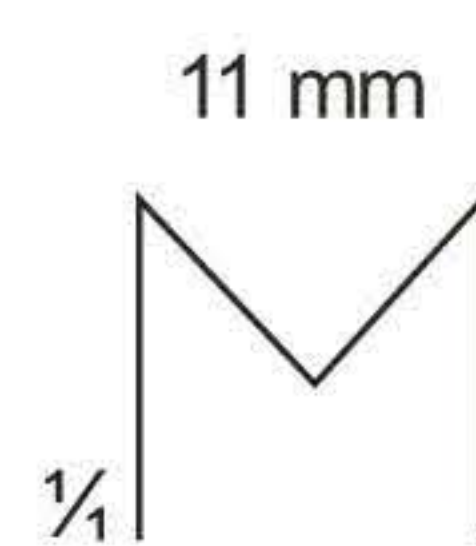

1/2

UG-1780  
LANGENBECK  
Sequestrum  
forceps  
205 mm

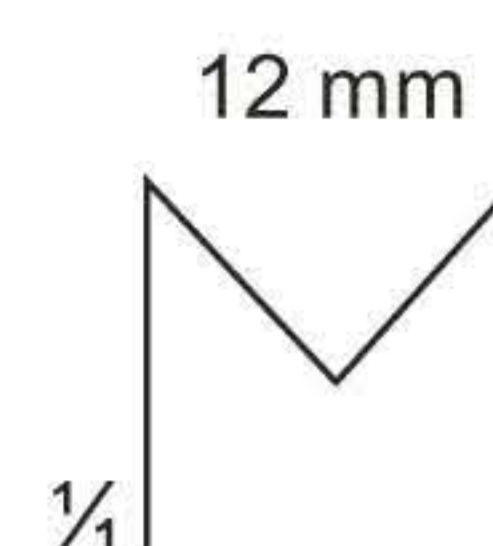

1/2

UG-1781  
FERGUSSON  
205 mm

# Bone Holding Forceps

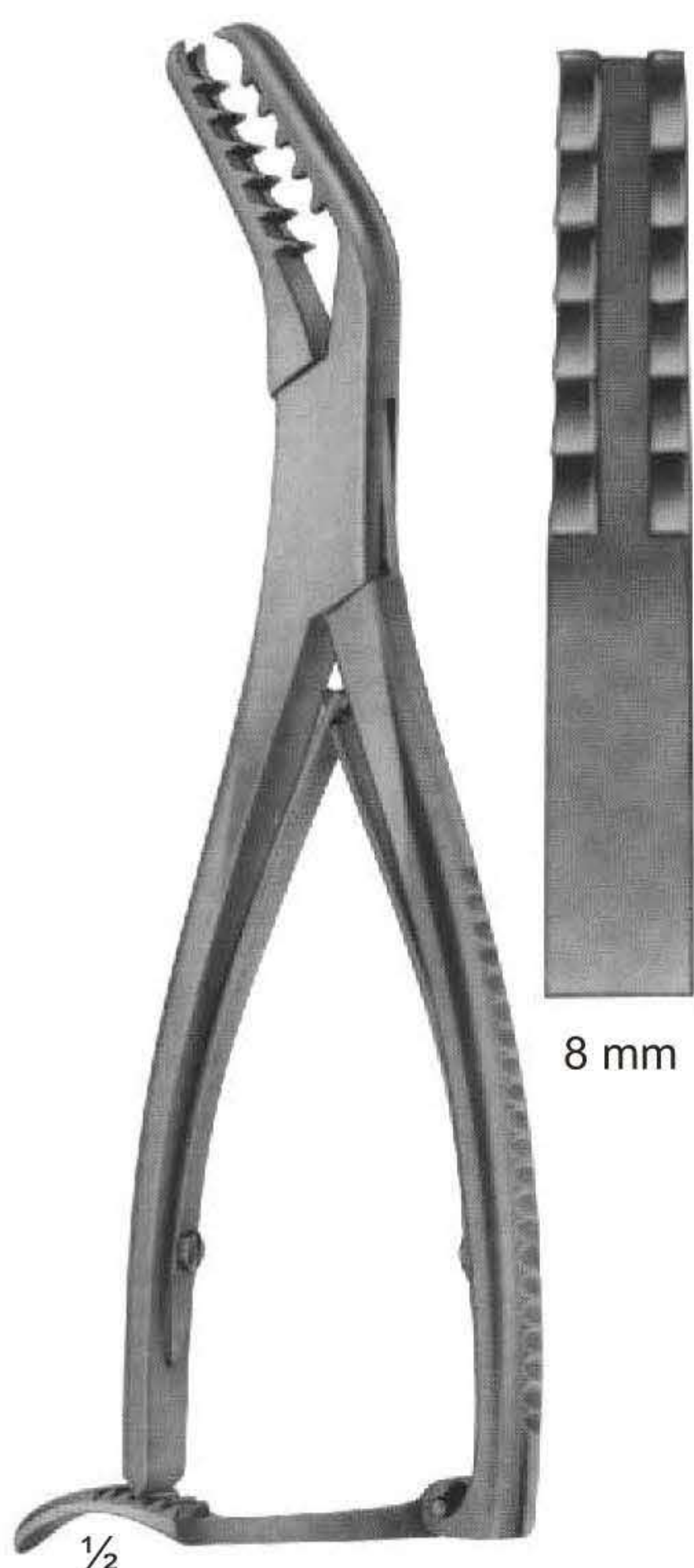
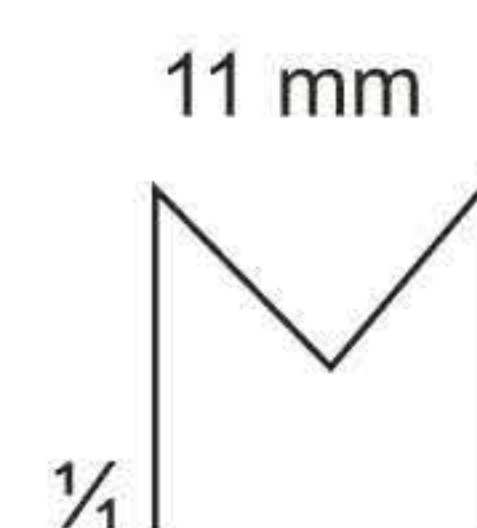
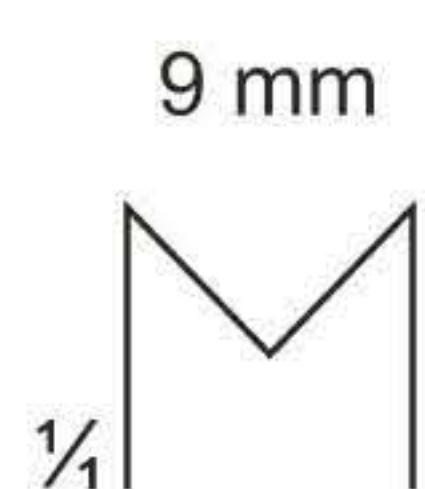
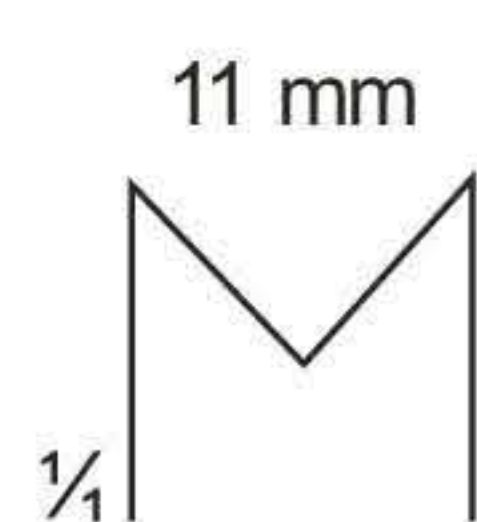
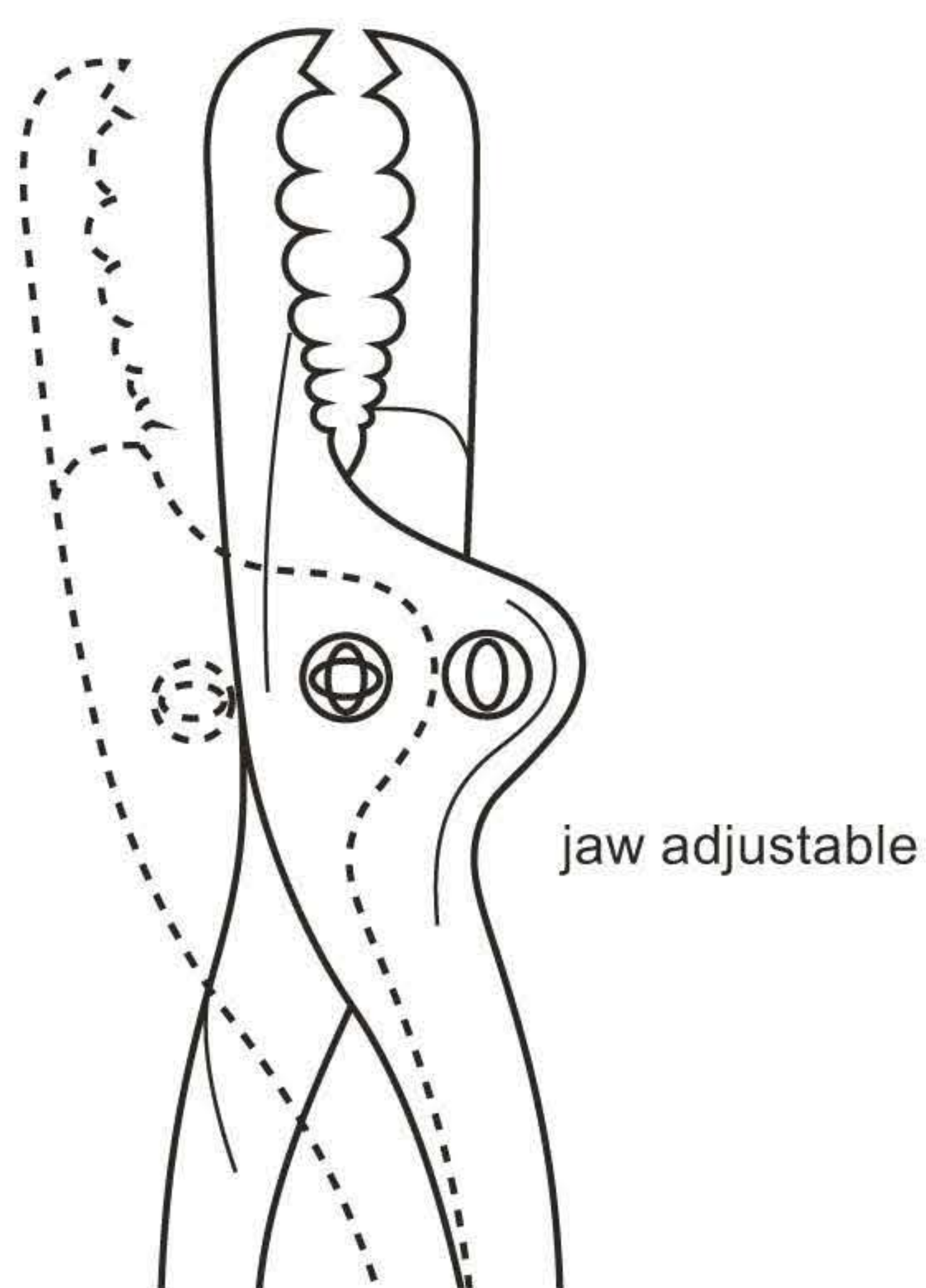

UG-1785  
SEMB  
190 mm



UG-1788  
FARABEUFF  
230 mm



UG-1790  
FARABEUFF  
255 mm



UG-1791  
FARABEUFF-LAMBOTTE  
255 mm

# Bone Holding Forceps



UG-1854  
KERN-LANE  
240 mm

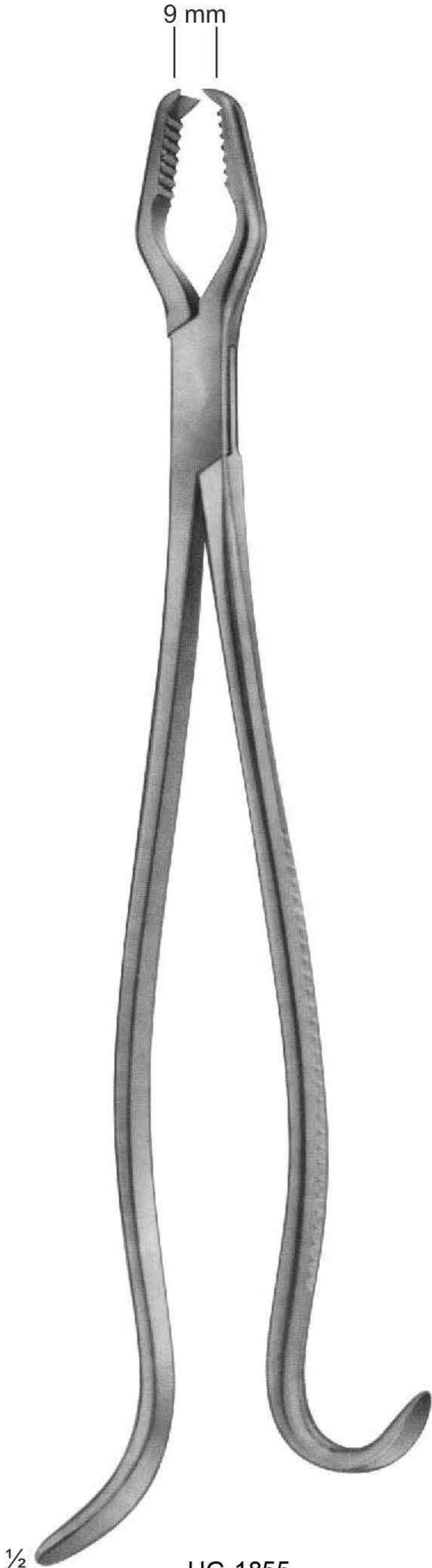

UG-1855  
LANE  
330 mm



UG-1856  
KERN-LANE  
240 mm

# Bone Holding Forceps



# Bone Holding Forceps



1/2

UG-1859

145 mm  
190 mm  
240 mm  
260 mm  
280 mm



1/2

UG-1860 255 mm  
VERBRUGGE 265 mm  
with lip joint 270 mm



1/2

UG-1861  
LAMBOTTE  
265 mm



# Bone Clamps

---



1/2  
UG-1862  
LOWMAN  
22-133 170 mm  
22-134 205 mm



1/2  
UG-1863  
LOWMAN-GERSTER  
210 mm



1/2  
UG-1764  
LOWMAN-HOGLUND  
175 mm

# Synovectomy-Rongeurs, Bone Rongeurs



1/2

UG-1869  
Synovectomy rongeur  
width of jaws 1.2 mm  
130 mm



1/2

UG-1870  
Synovectomy rongeur  
width of jaws 2.0 mm  
130 mm



1/2

UG-1872  
STELLBRINK  
Synovectomy rongeur  
175 mm



1/2

UG-1873  
STELLBRINK  
Synovectomy rongeur  
170 mm



1/2

UG-1874  
LURE-FRIEDMANN  
145 mm



1/2

UG-1875  
140 mm

# Bone Rongeurs



UG-1876  
LURE  
150 mm

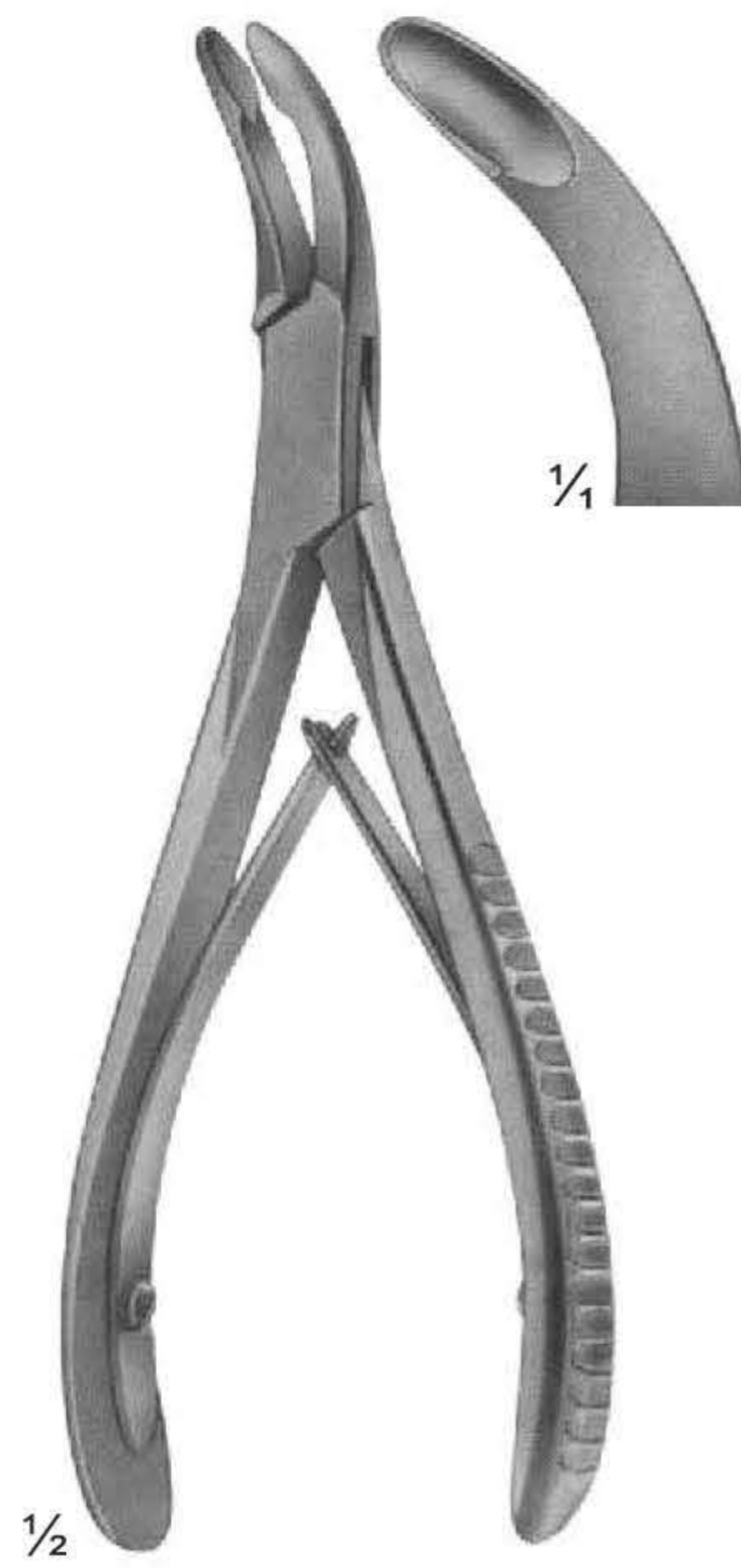

UG-1877  
LURE  
155 mm

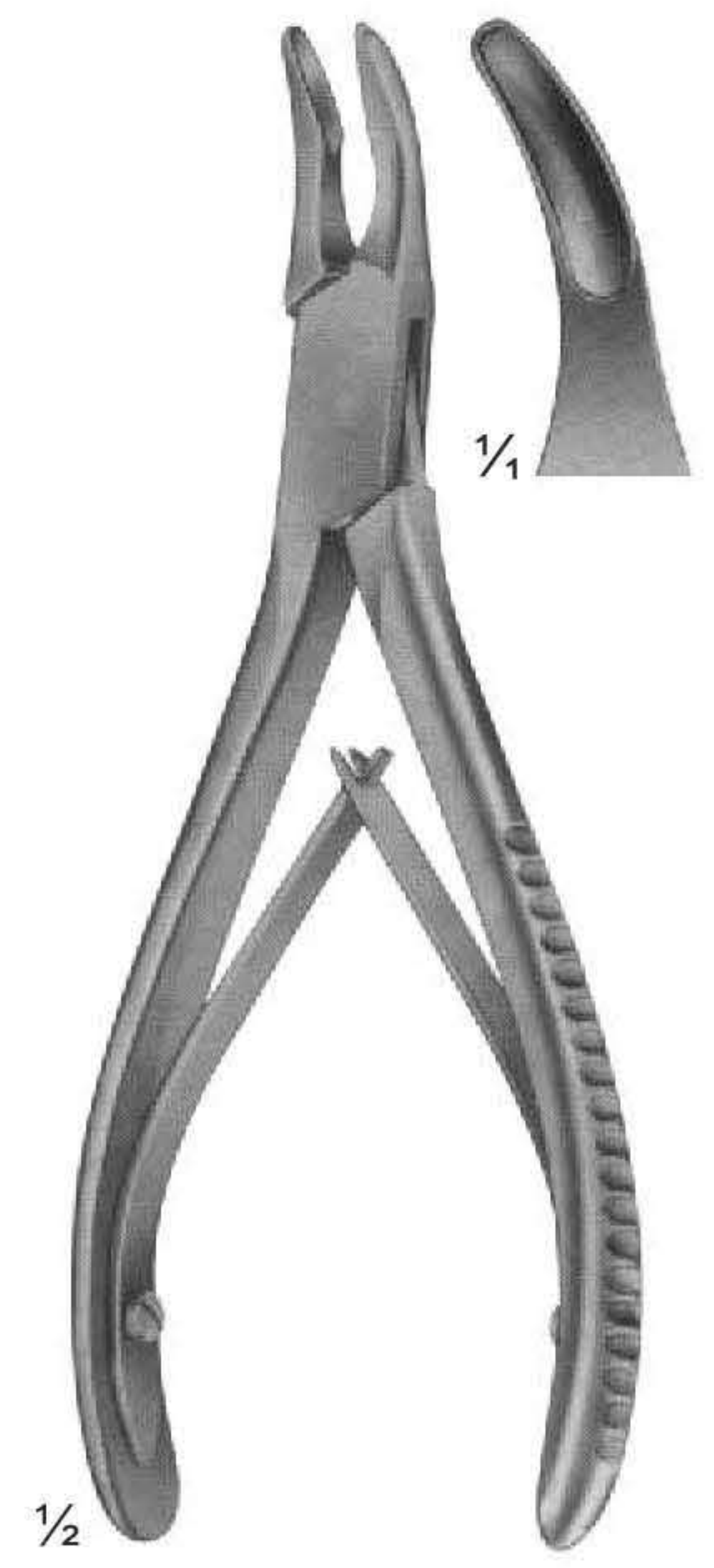

UG-1878  
BLUMENTHAL  
155 mm

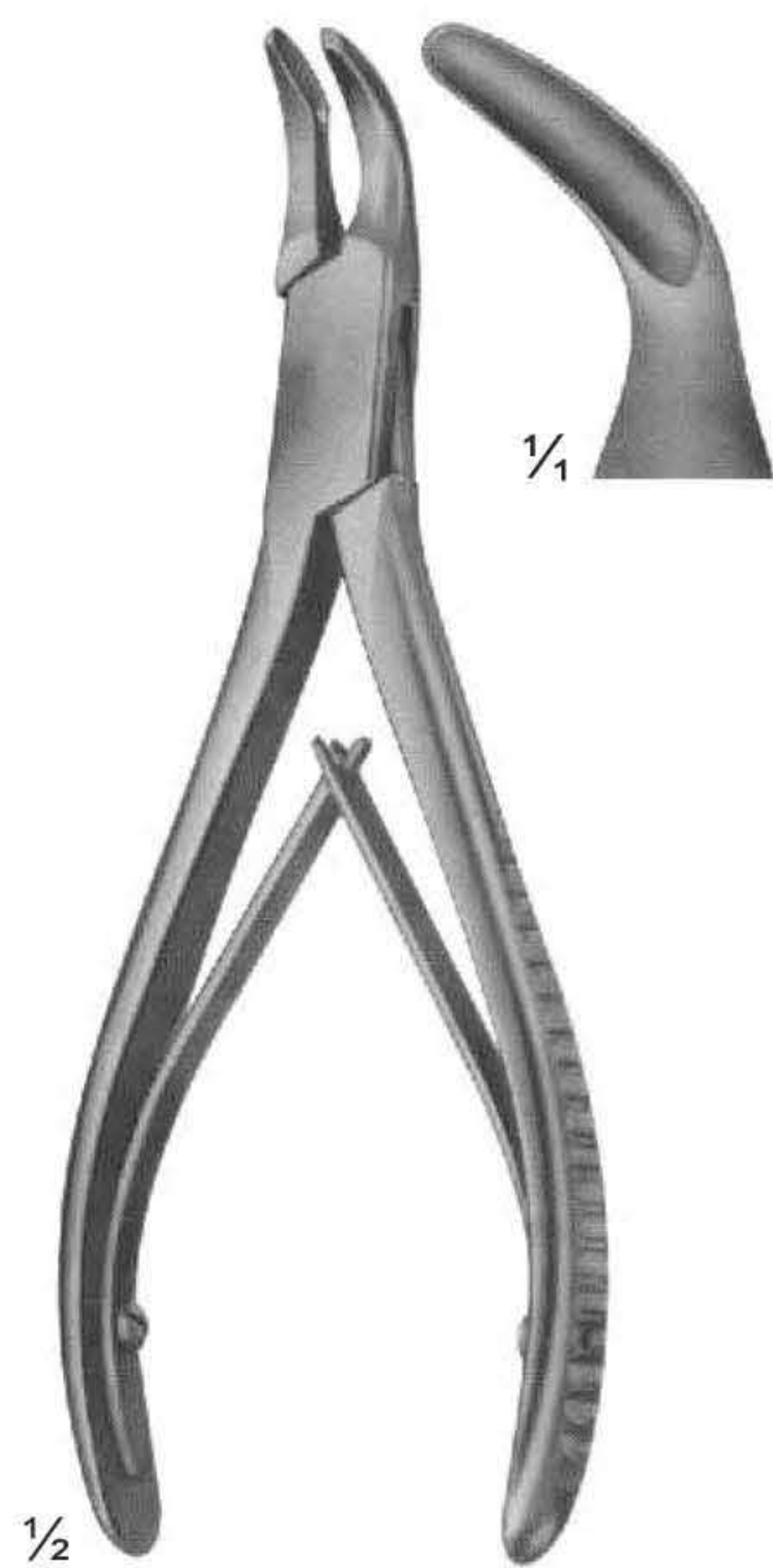

UG-1879  
BLUMENTHAL  
150 mm



UG-1881  
JANSEN  
175 mm

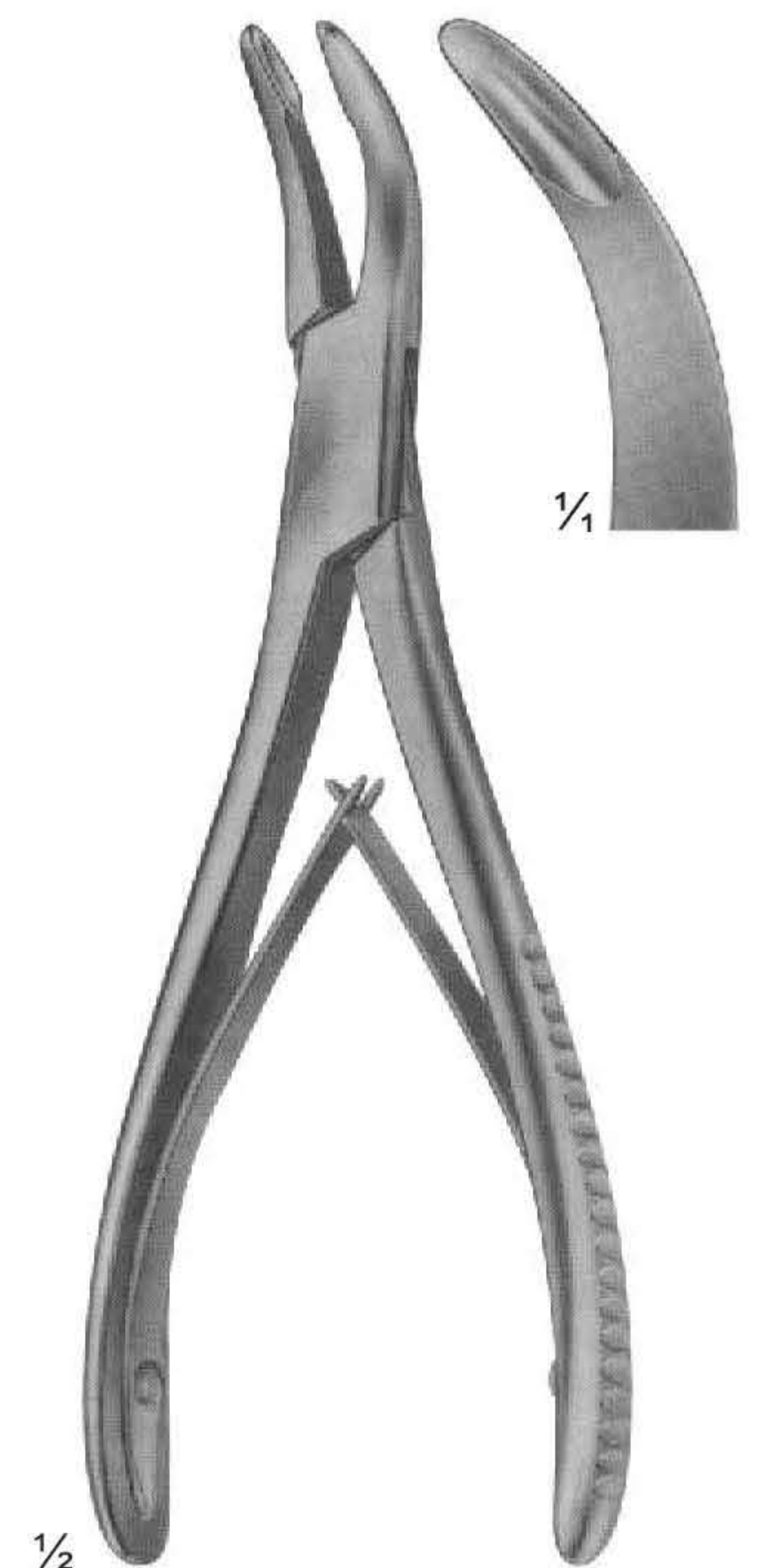

UG-1882  
BANE-HARTMANN  
175 mm

# Bone Rongeurs

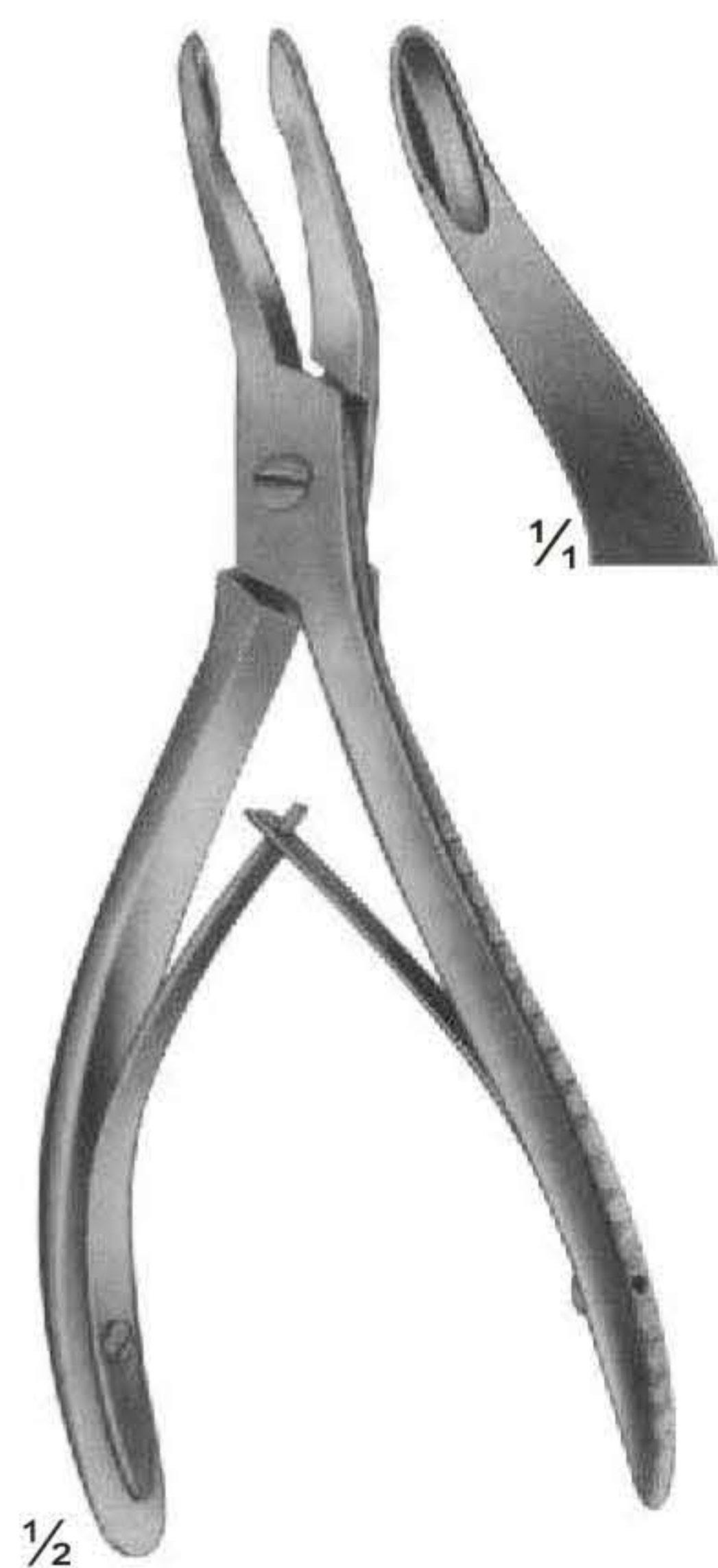

UG-1884  
ALEXANDER  
140 mm

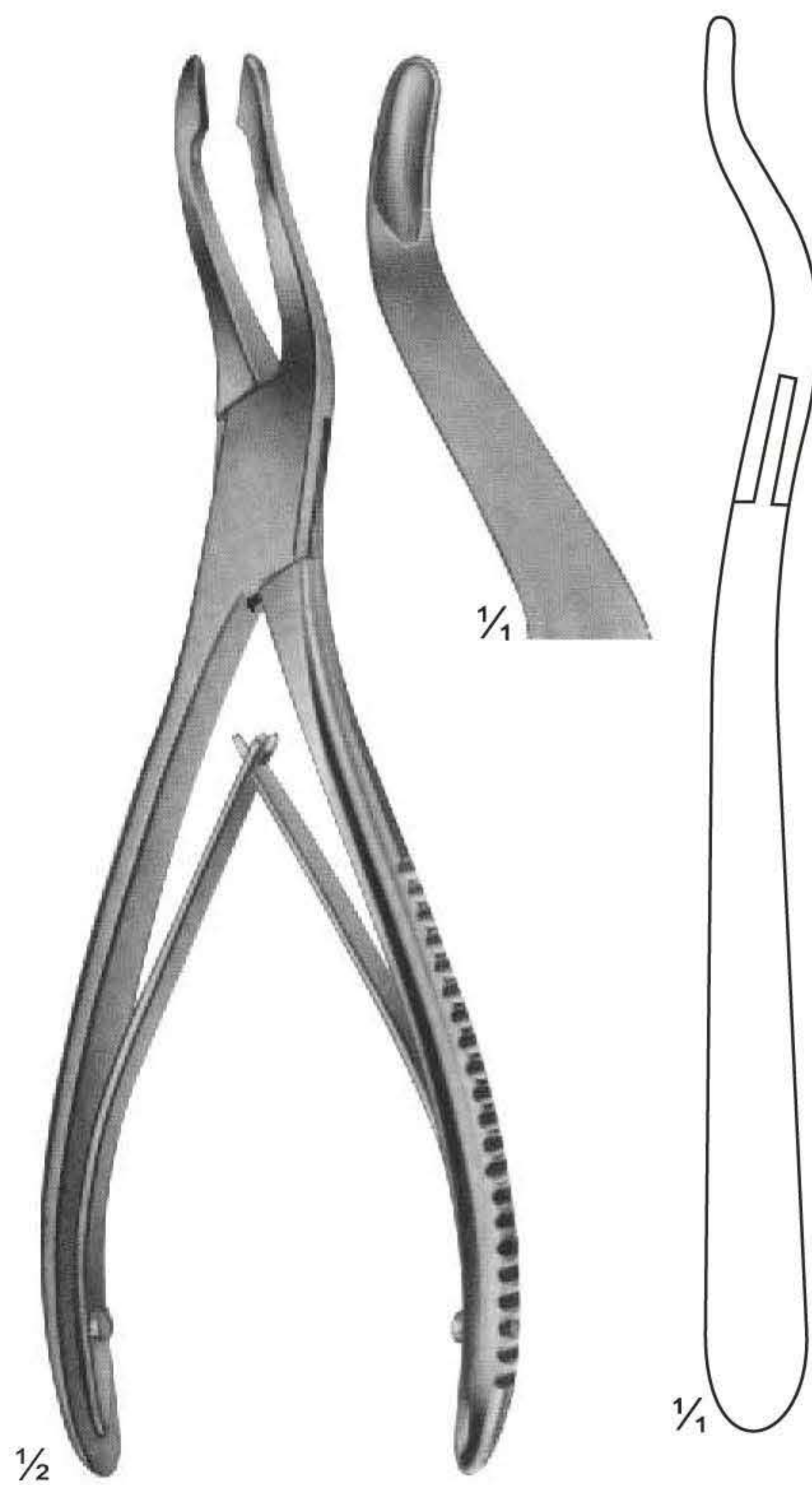

UG-1885  
JANSEN  
190 mm



UG-1887  
LEMPERT  
200 mm

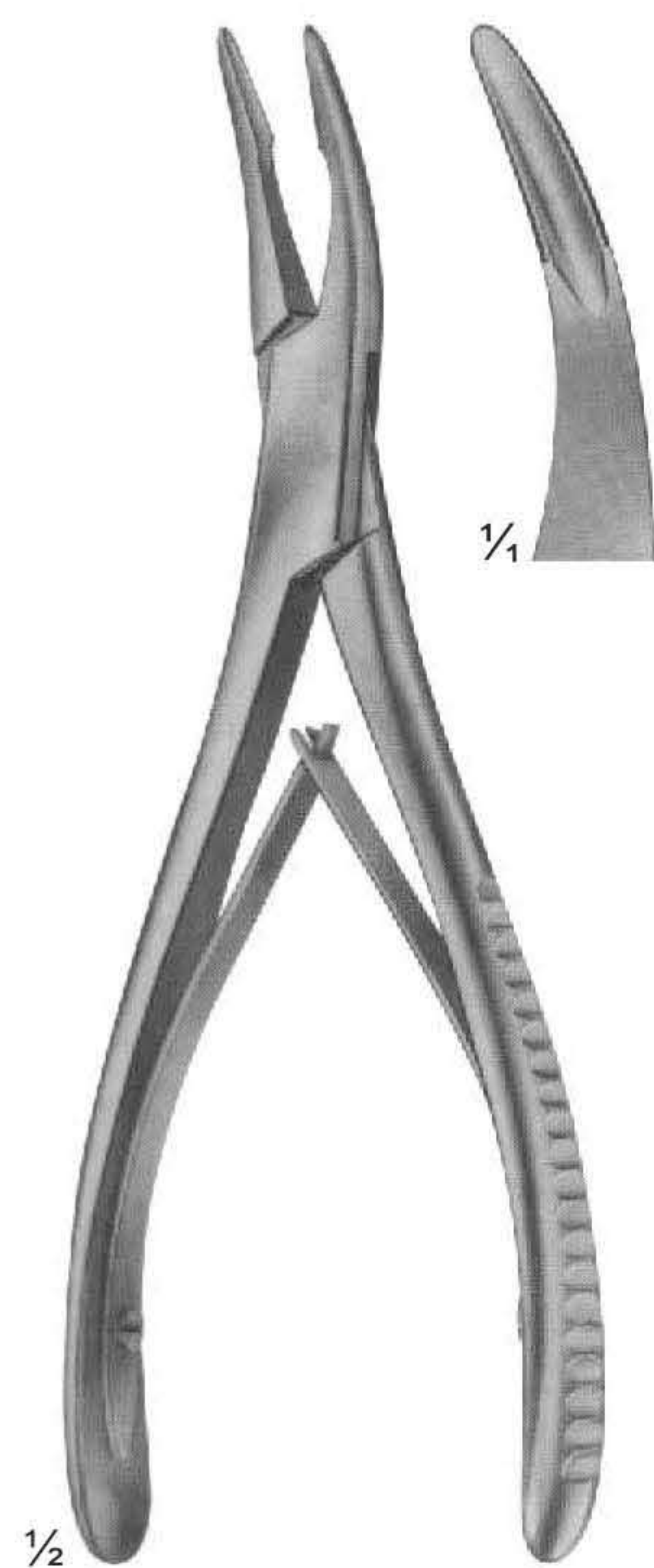

UG-1890  
BEYER  
180 mm

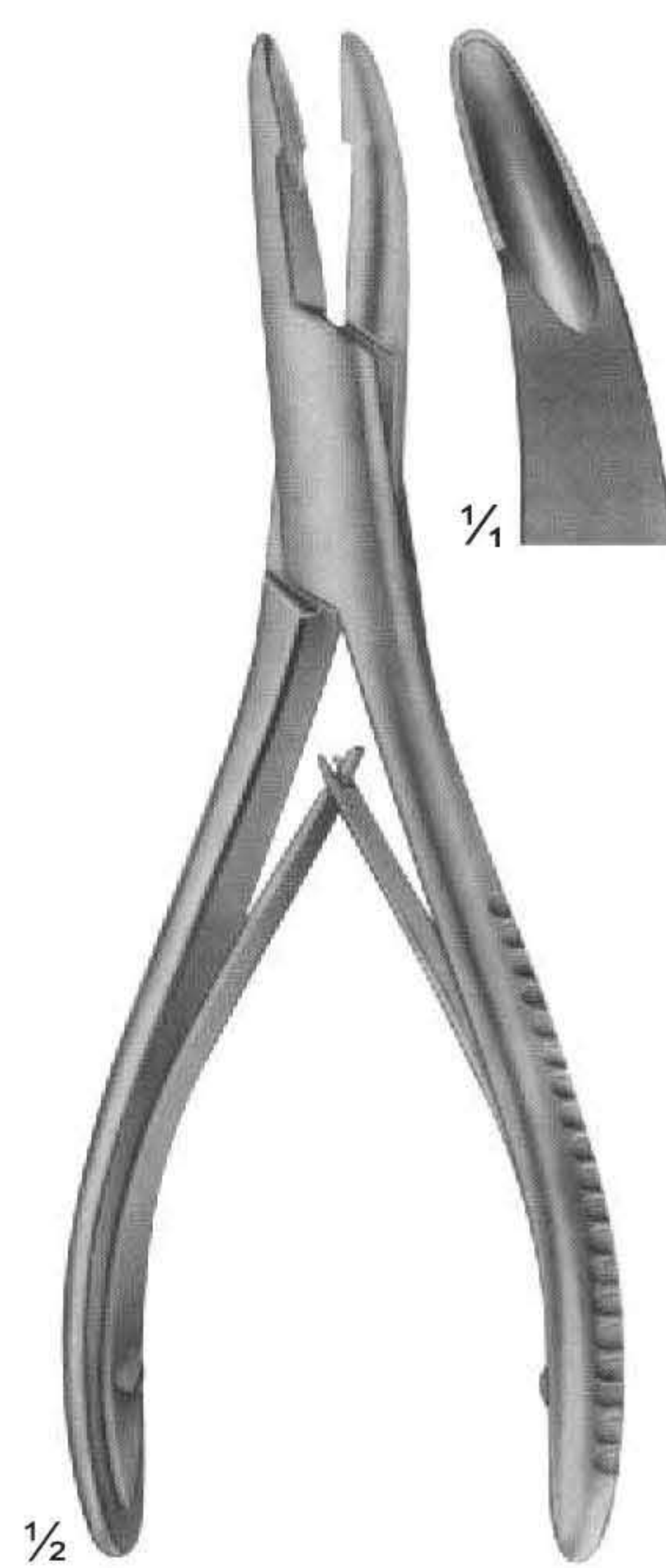

UG-1892  
MEAD  
165 mm

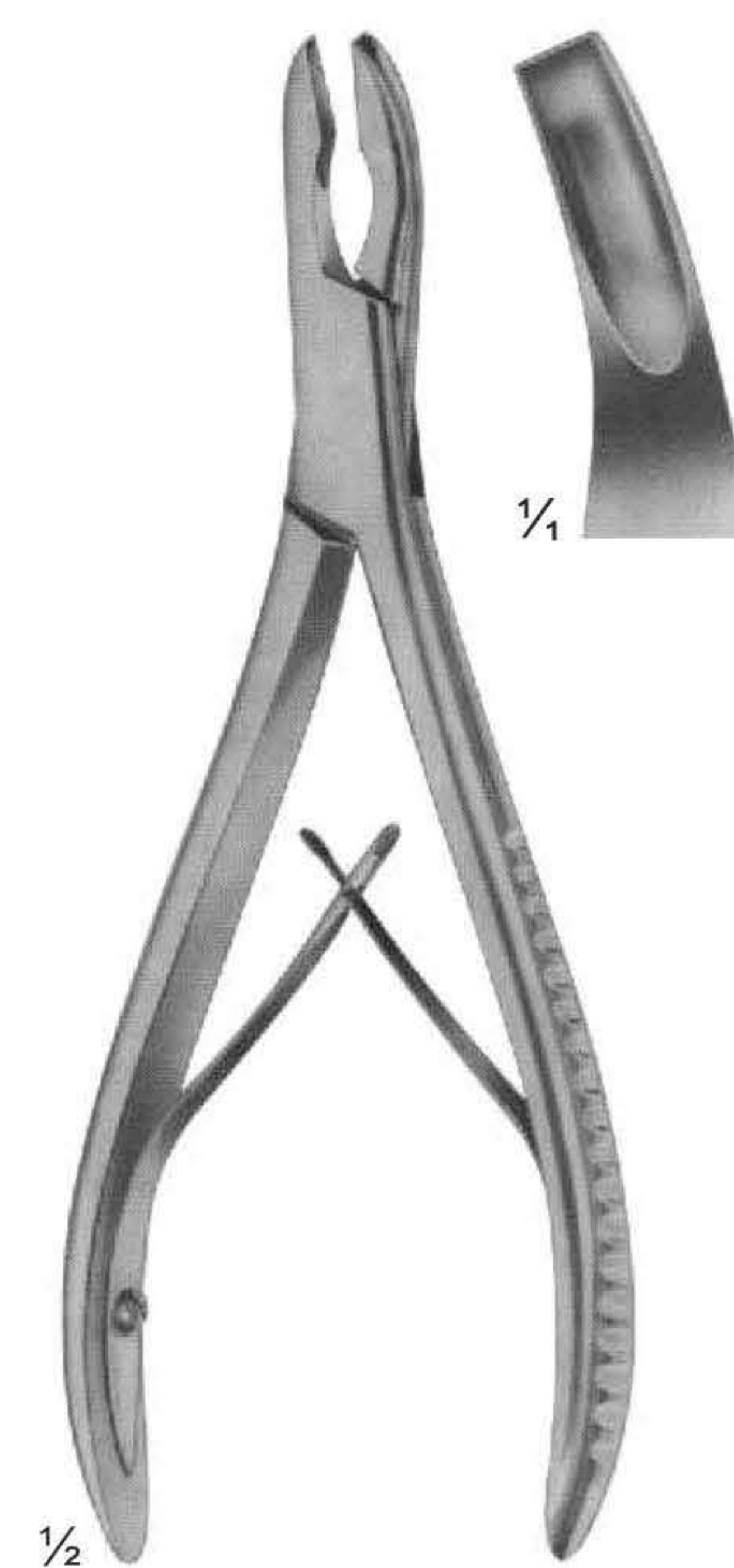

UG-1893  
MEAD  
165 mm

# Bone Rongeurs

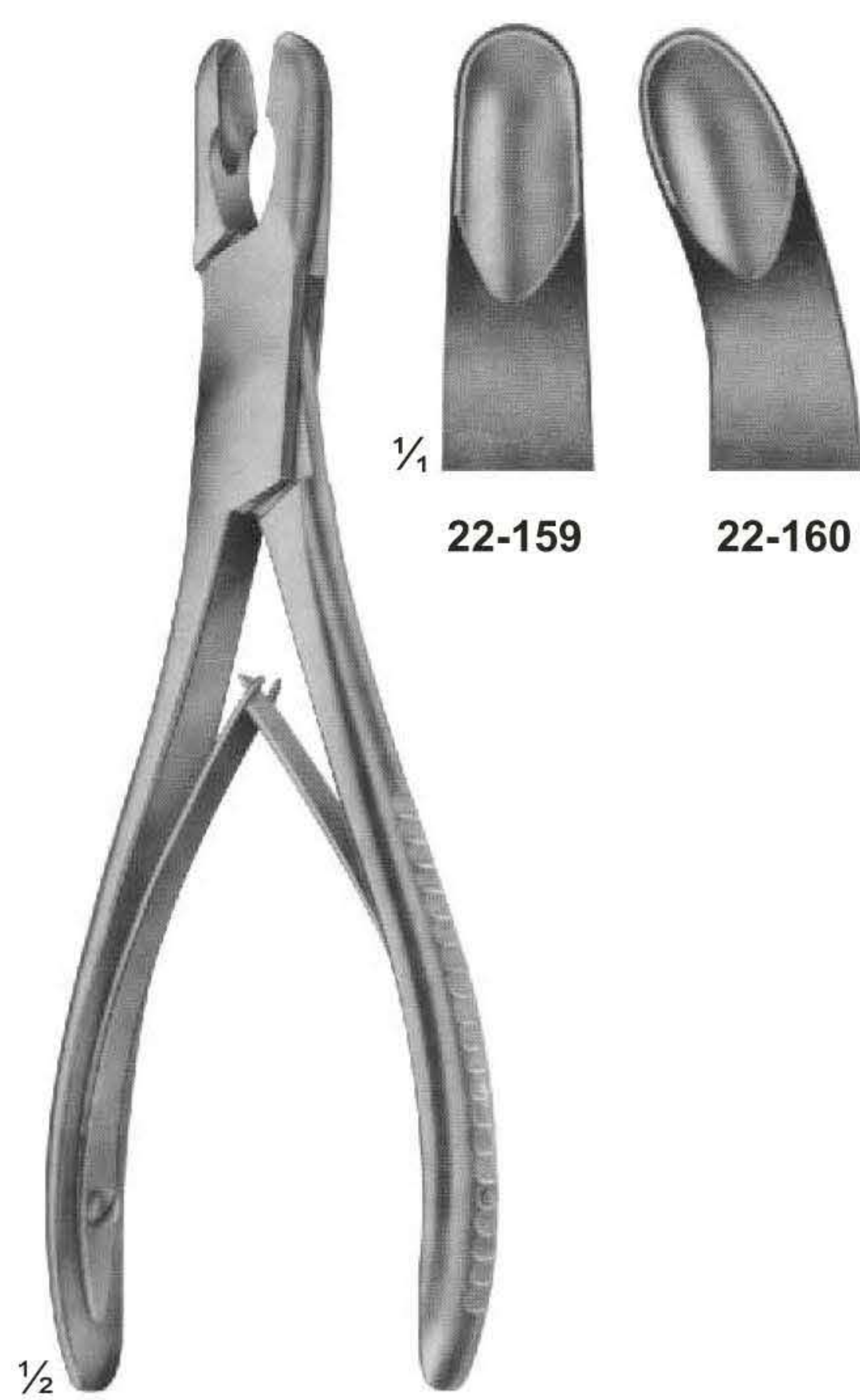

**22-159 - 160**  
LURE  
175 mm

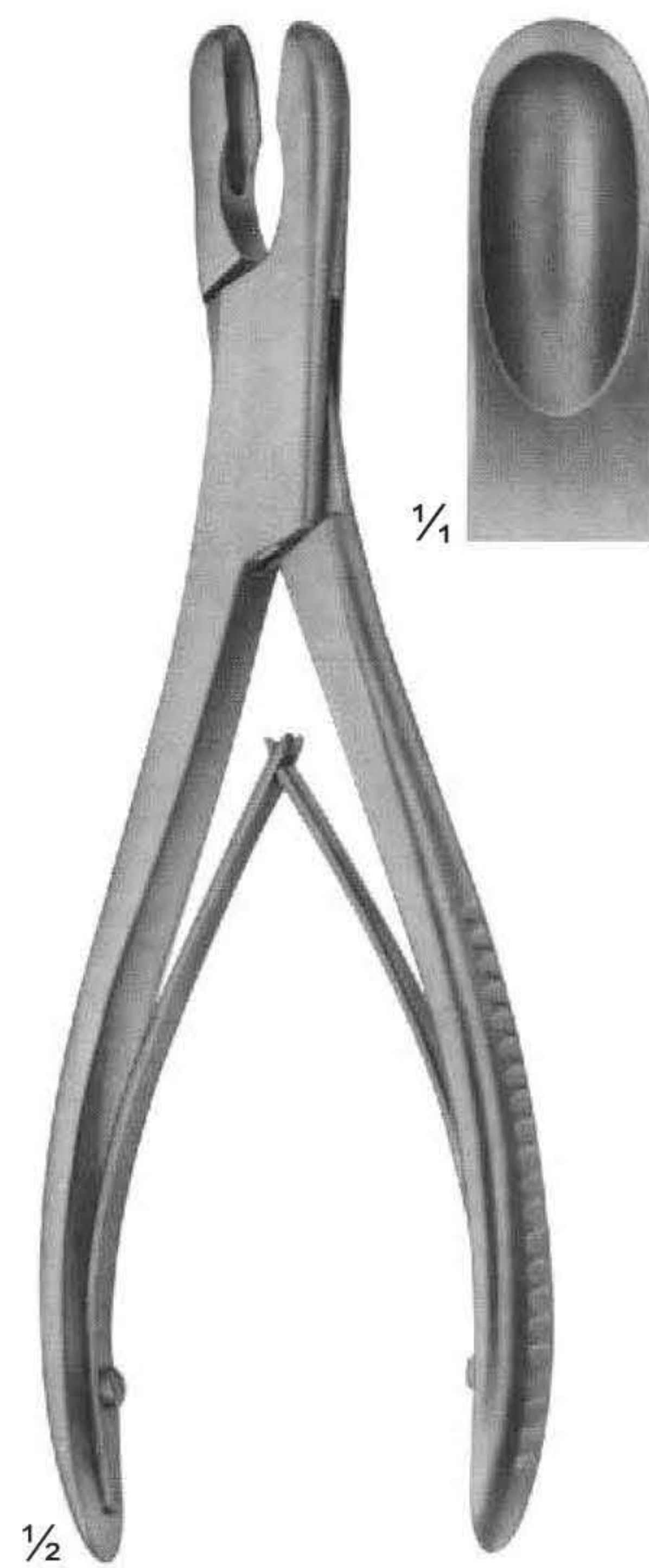

**UG-1904**  
LURE  
180 mm

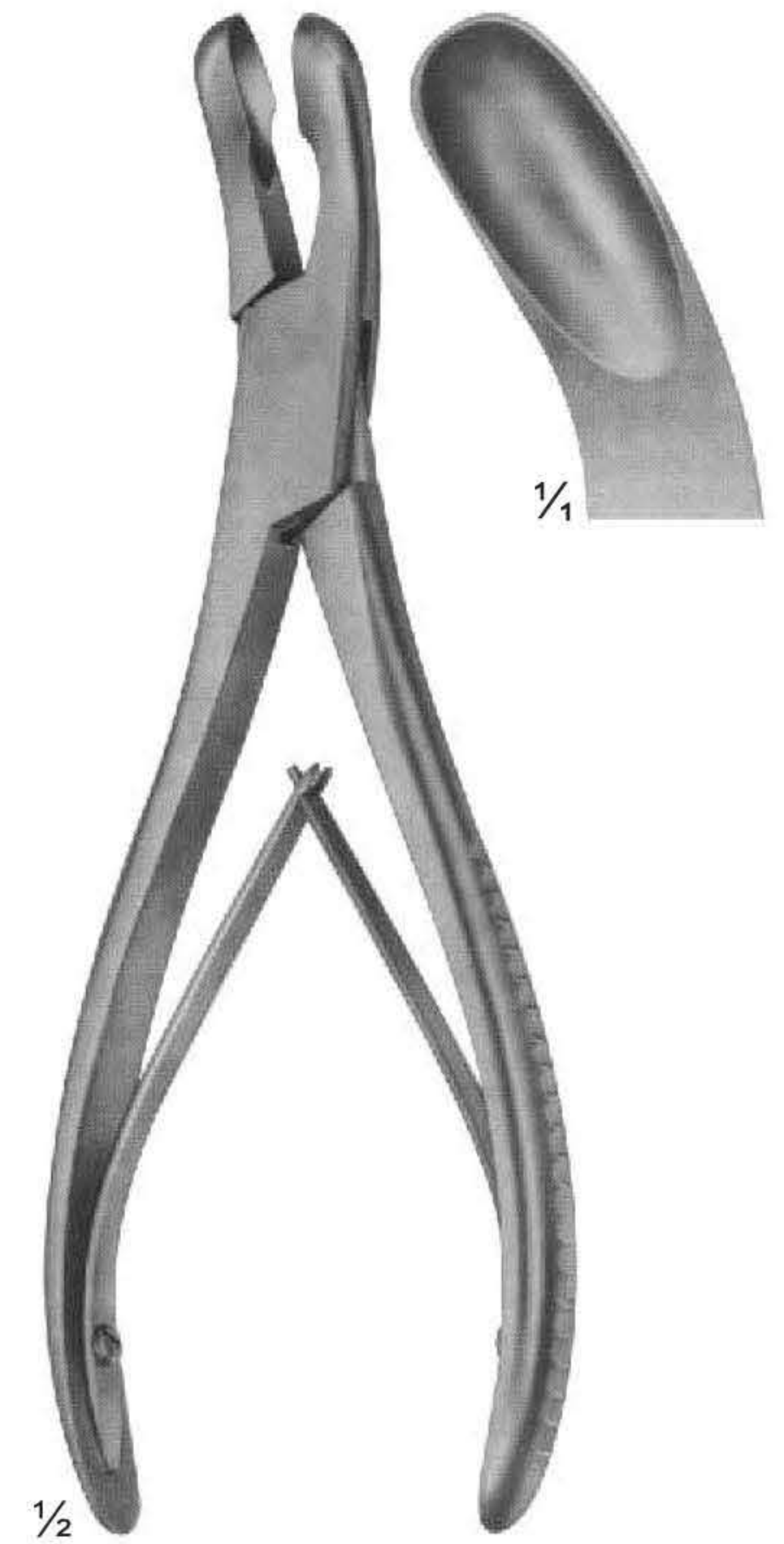

**UG-1906**  
LURE  
180 mm

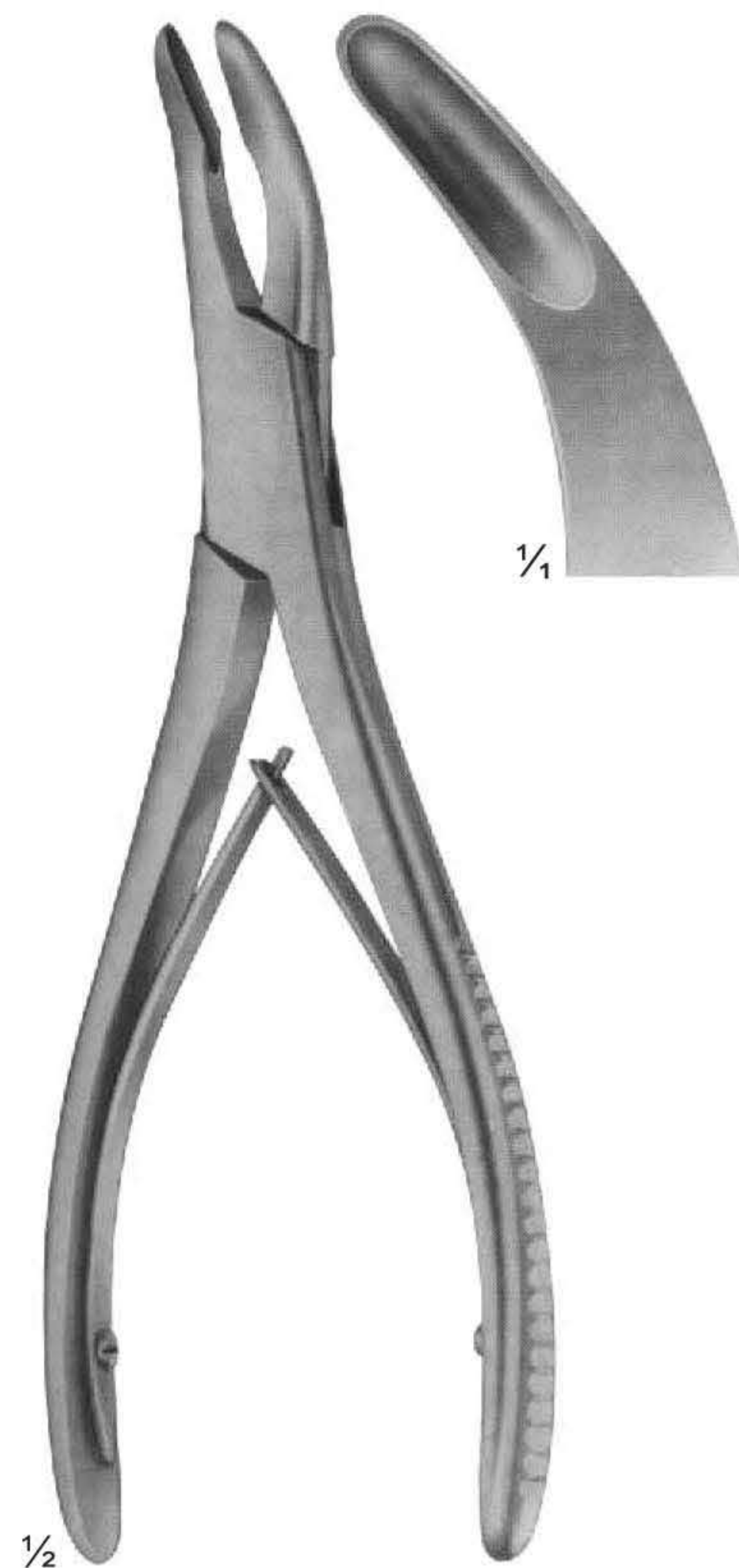

**UG-1907**  
OLIVECRONA  
205 mm



**UG-1908**  
BOHLER  
155 mm

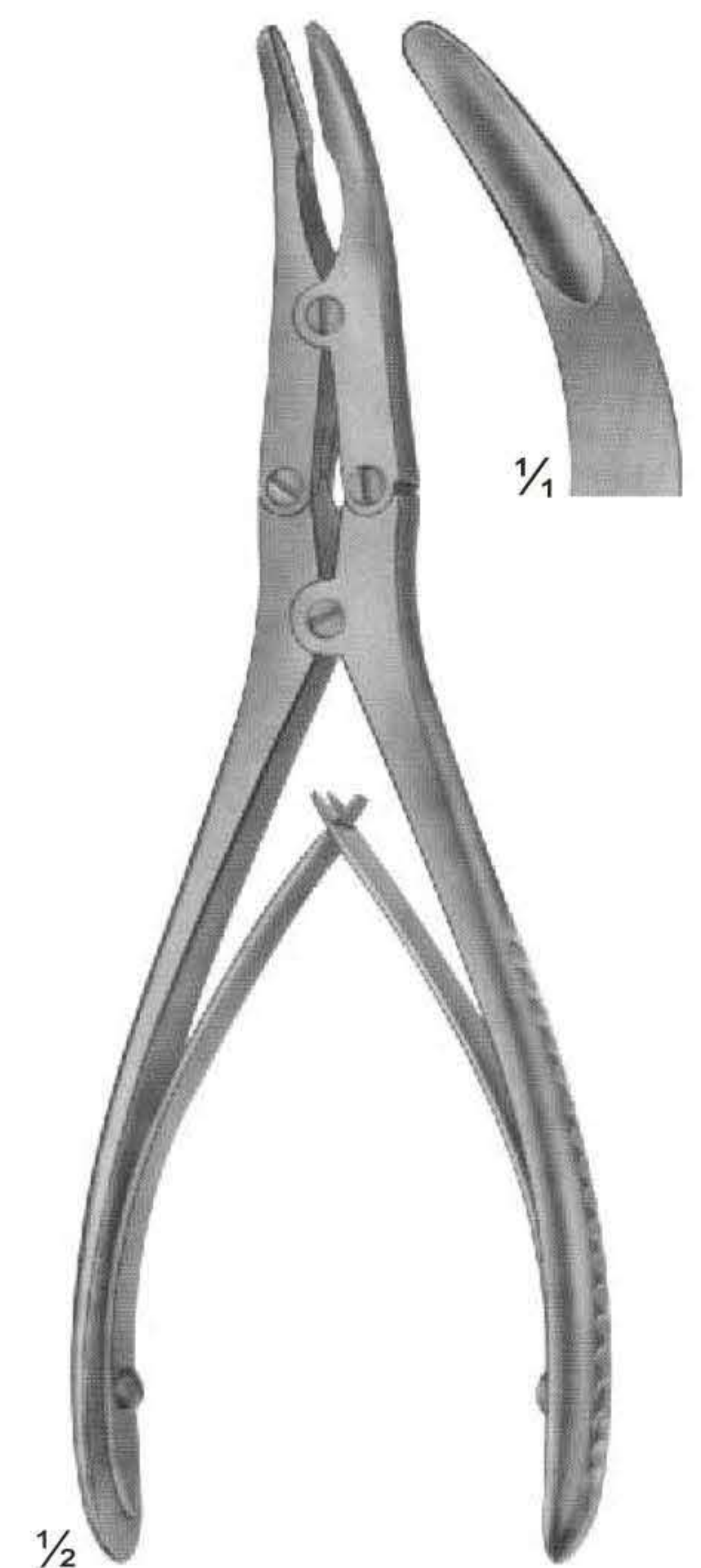

**UG-1909**  
MARQUARTD  
200 mm

# Bone Rongeurs

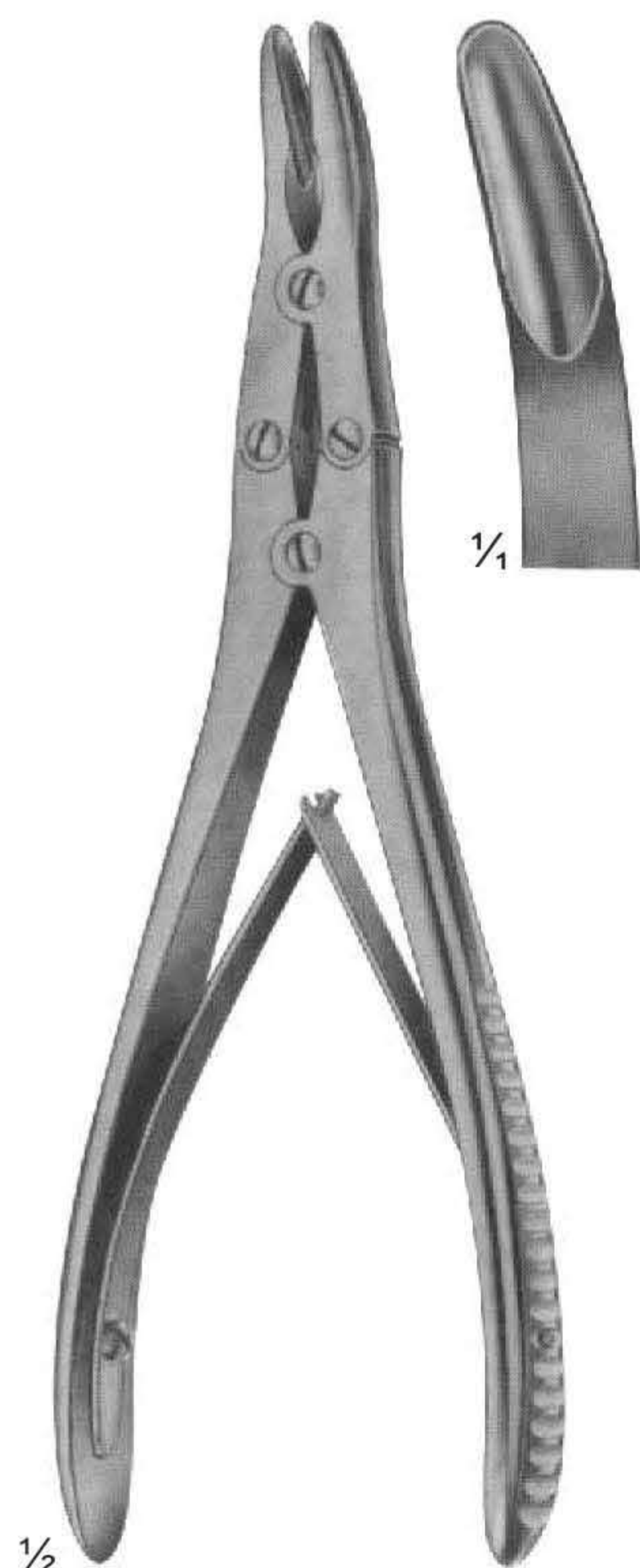

UG-1913  
RUSKIN  
190 mm



UG-1915  
ROTTGEN-RUSKIN  
240 mm

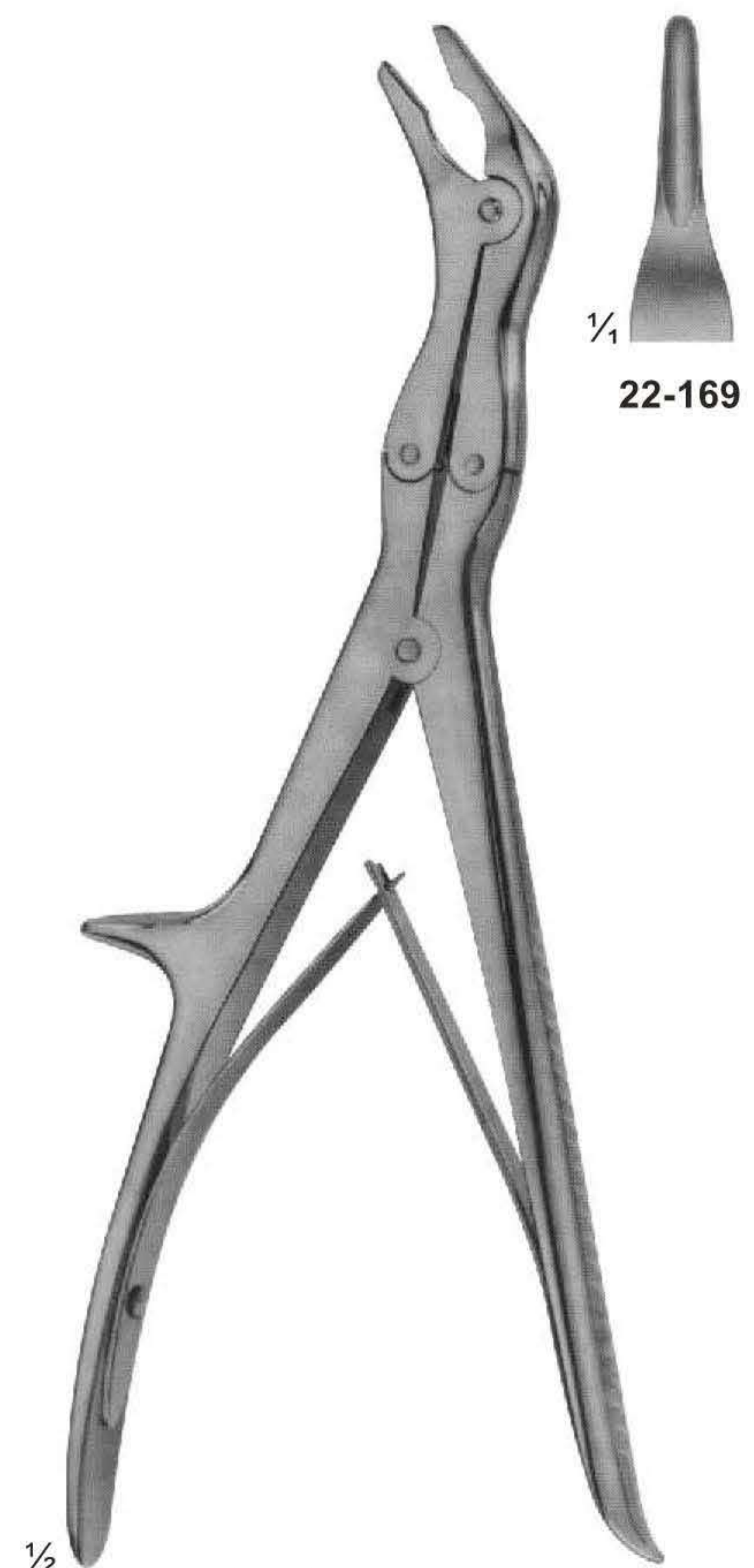

UG-1916  
22-169 - 170  
ECHLIN  
230 mm

# Bone Rongeurs



UG-1918  
STILLE  
235 mm



UG-1919  
LEKSELL-STILLE  
240mm



UG-1920  
STILLE-RUSKIN  
240mm

# Bone Rongeurs

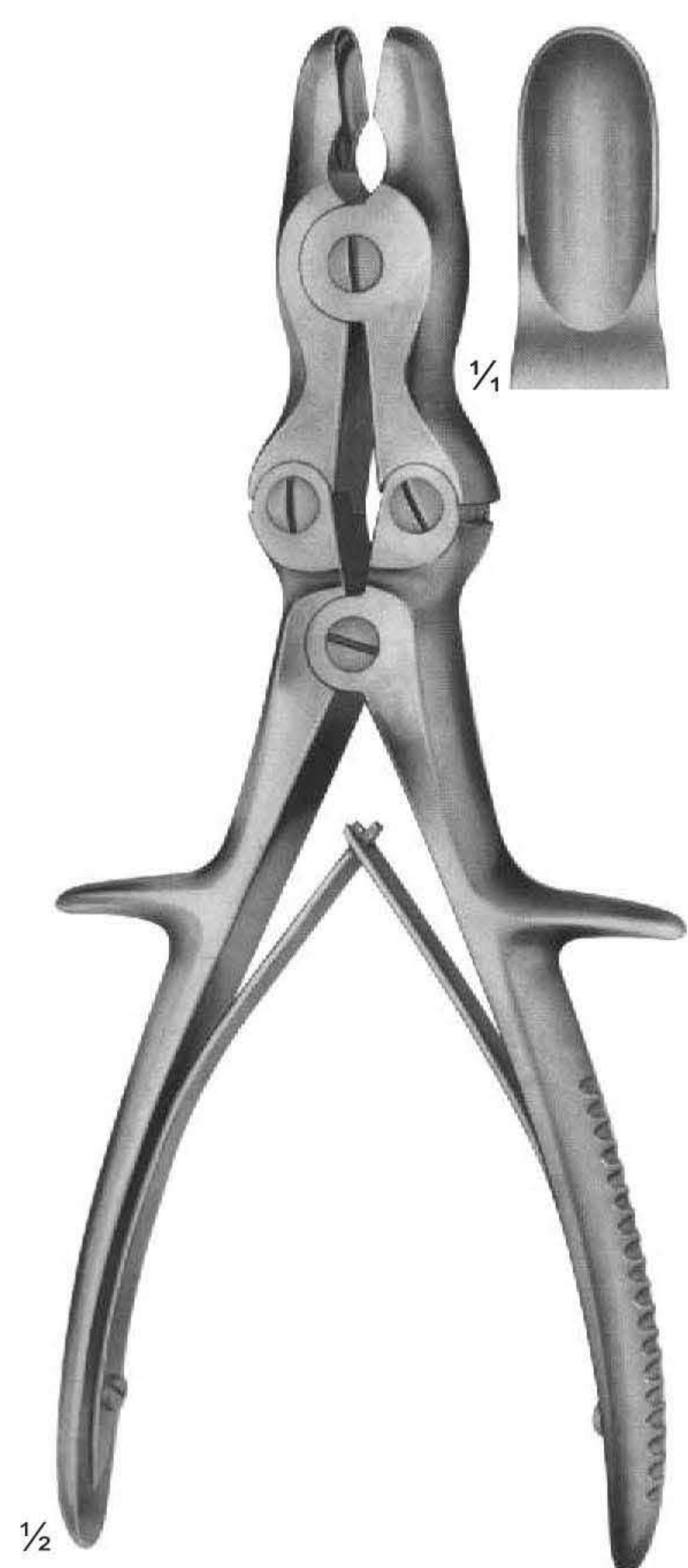

UG-1921  
LURE-STILLE  
225 mm



UG-1922  
LURE-STILLE  
225 mm



# Bone Cutting Forceps



UG-1925  
STAMM  
150 mm

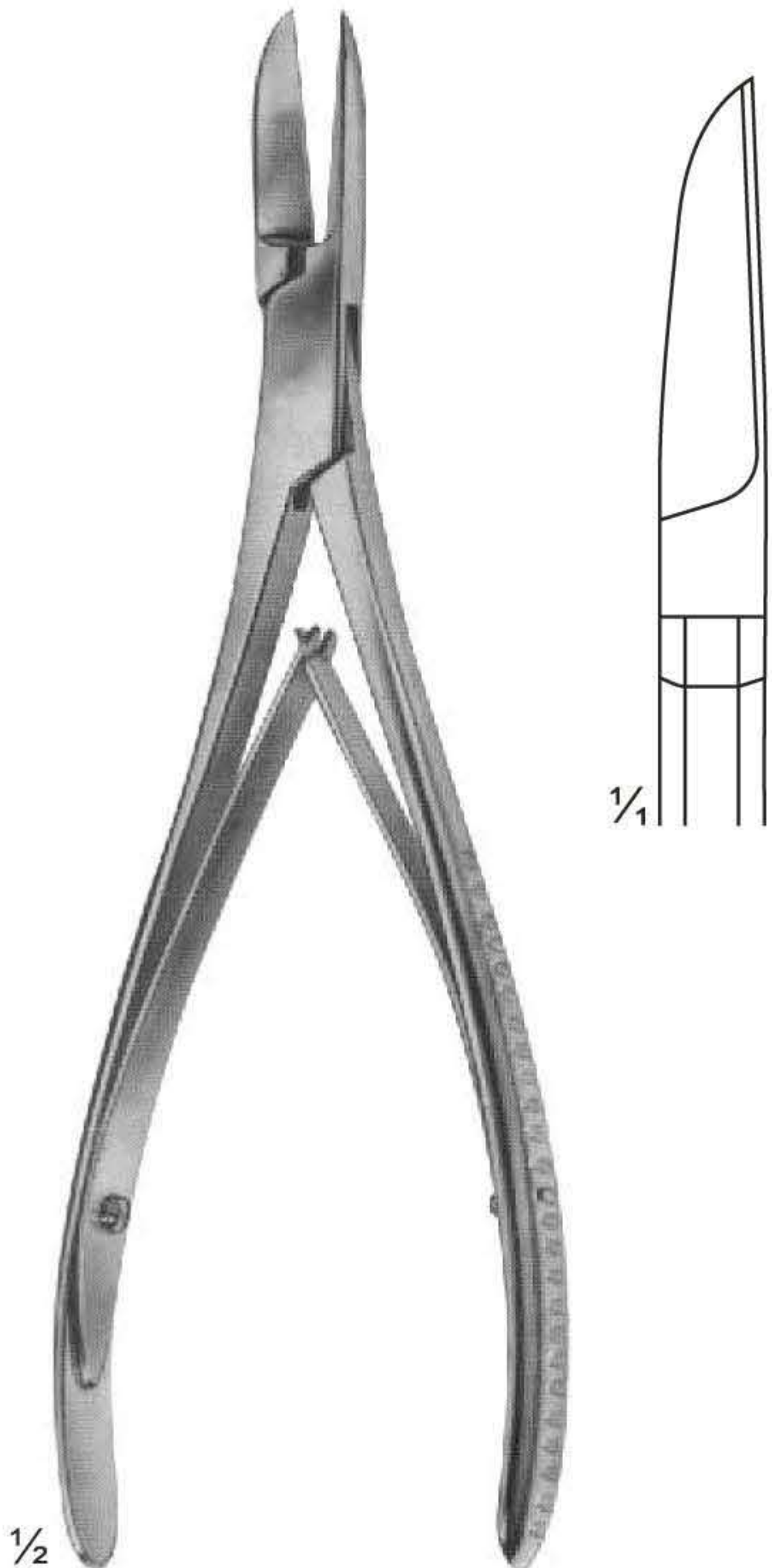

UG-1926  
KAZANJIAN  
185 mm



UG-1927  
LISTON

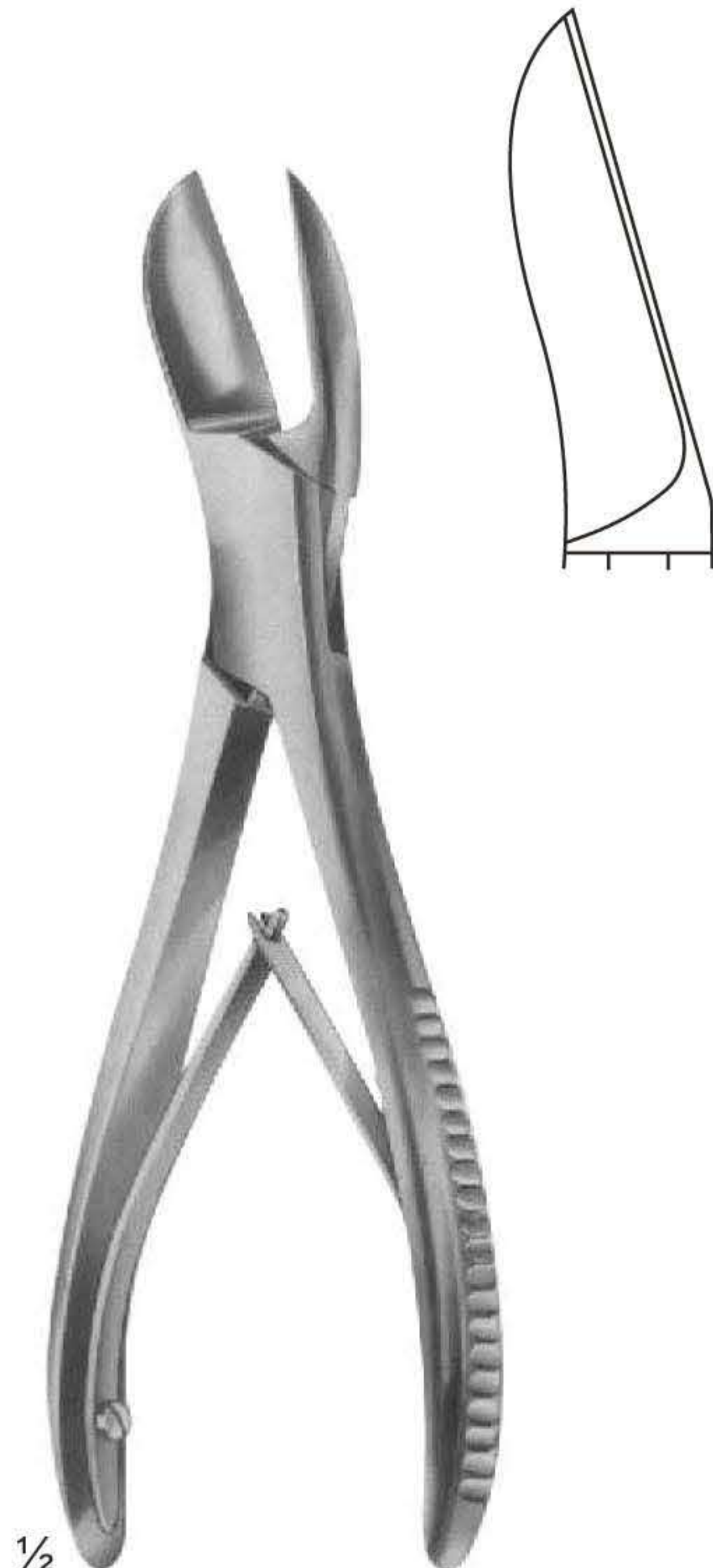

UG-1930  
LISTON

# Bone Cutting Forceps

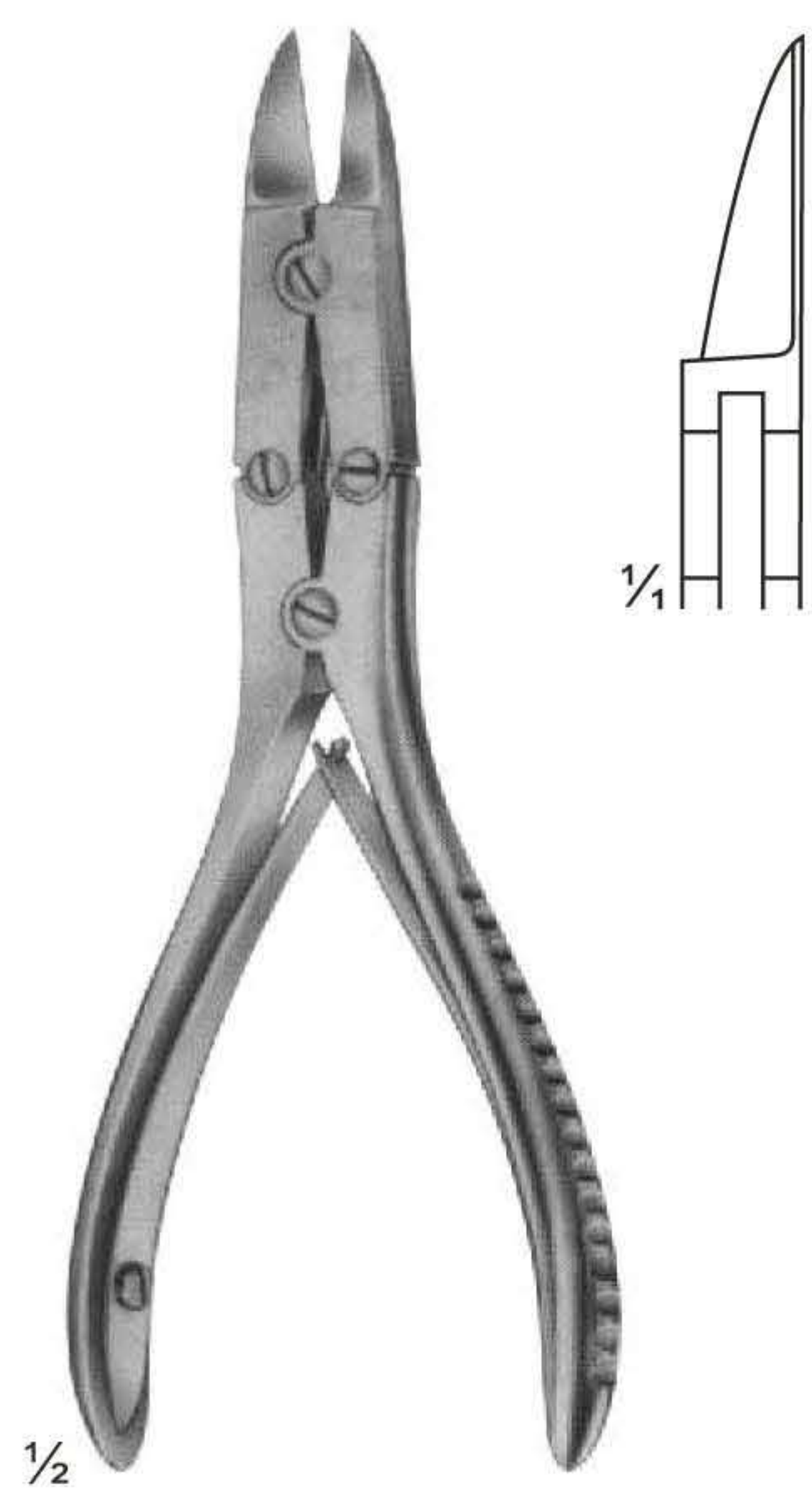

UG-1931  
BOHLER  
145 mm

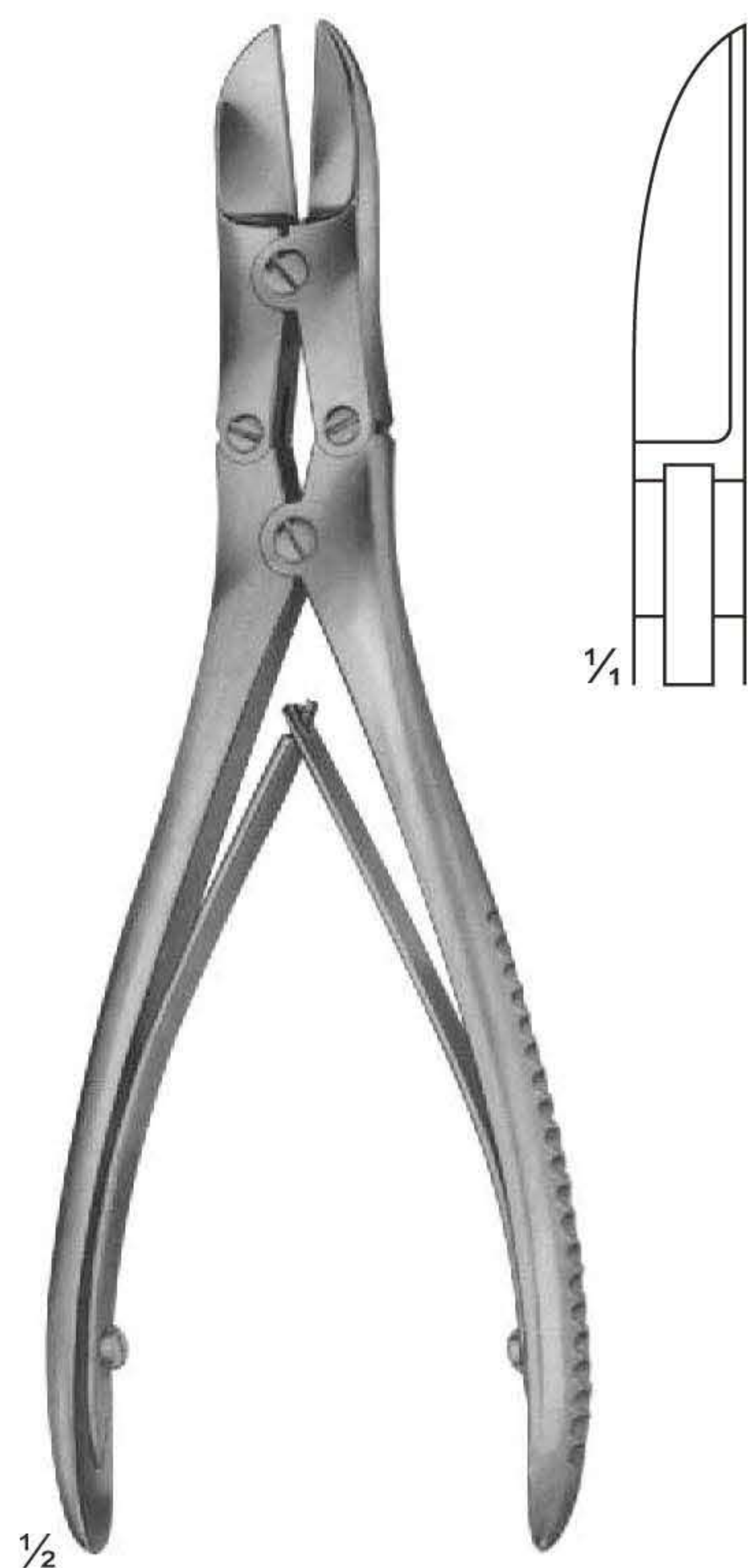

UG-1932  
RUSKIN-LISTON  
190 mm

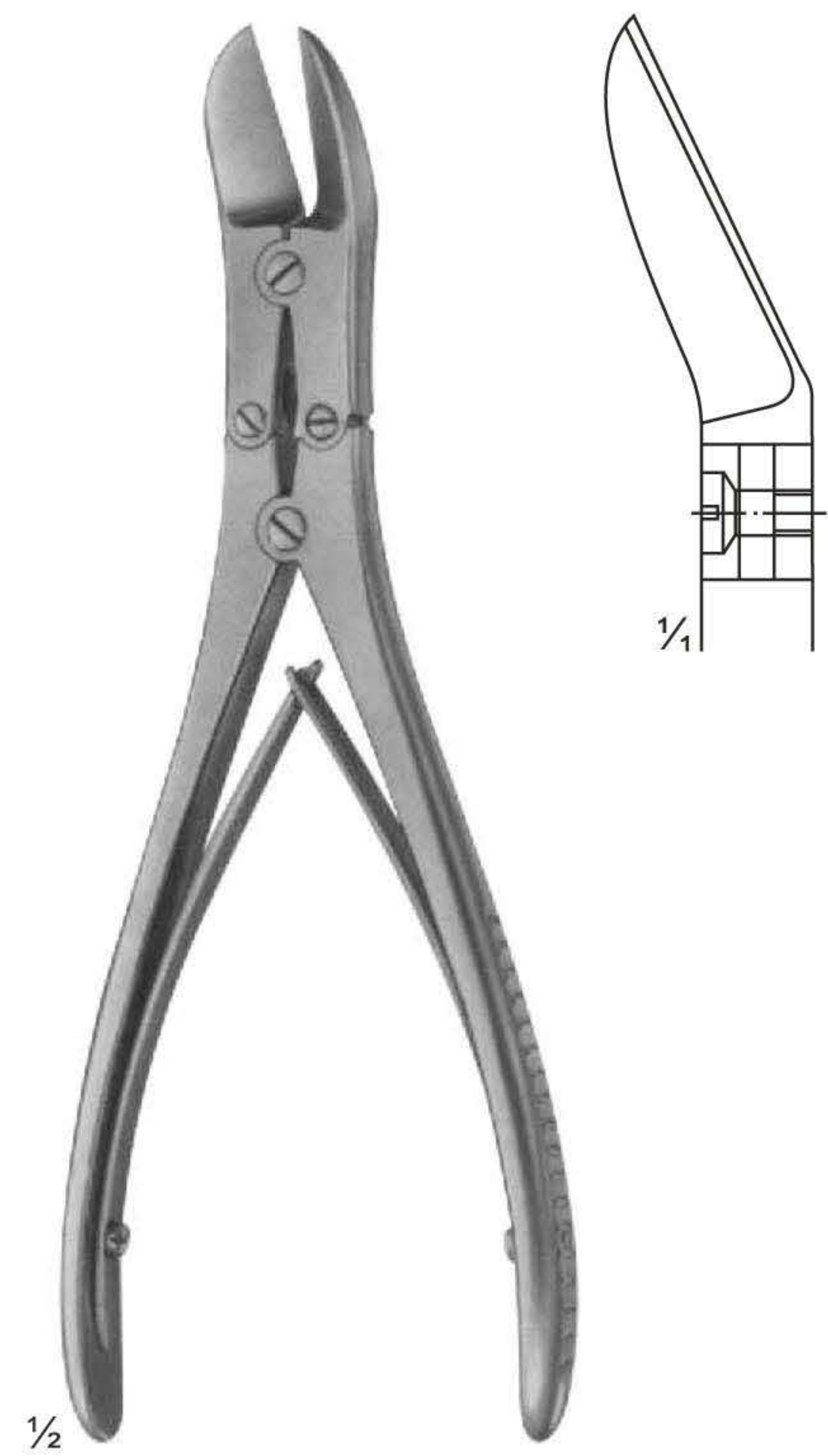

UG-1933  
RUSKIN-LISTON  
190 mm

# Bone Cutting Forceps

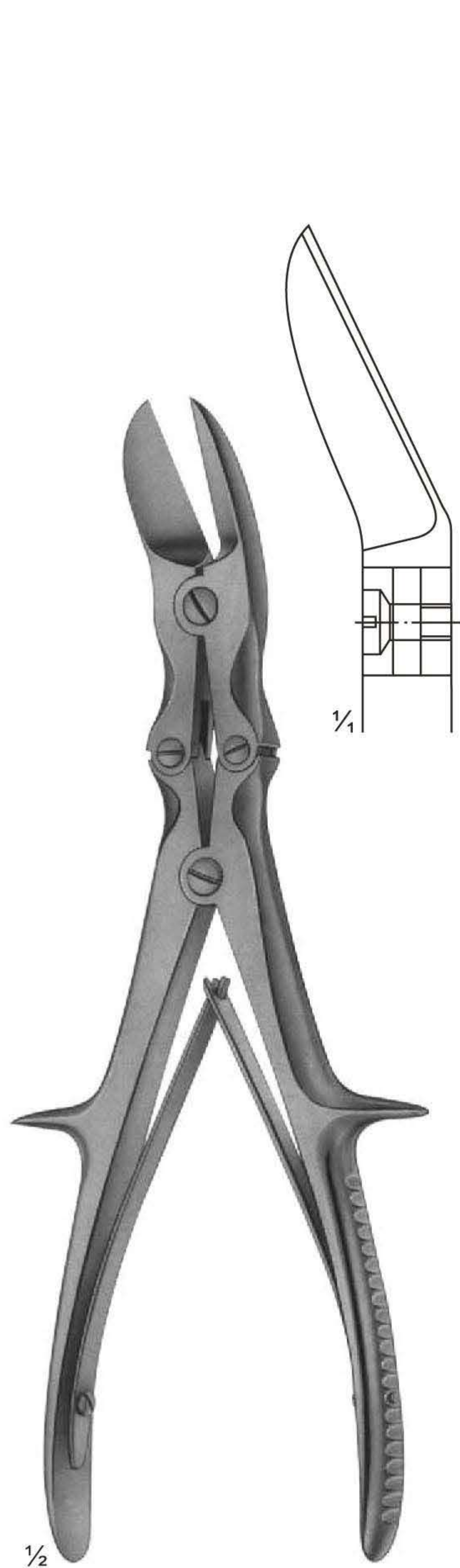

UG-1934  
LISTON  
curved on flat  
240 mm

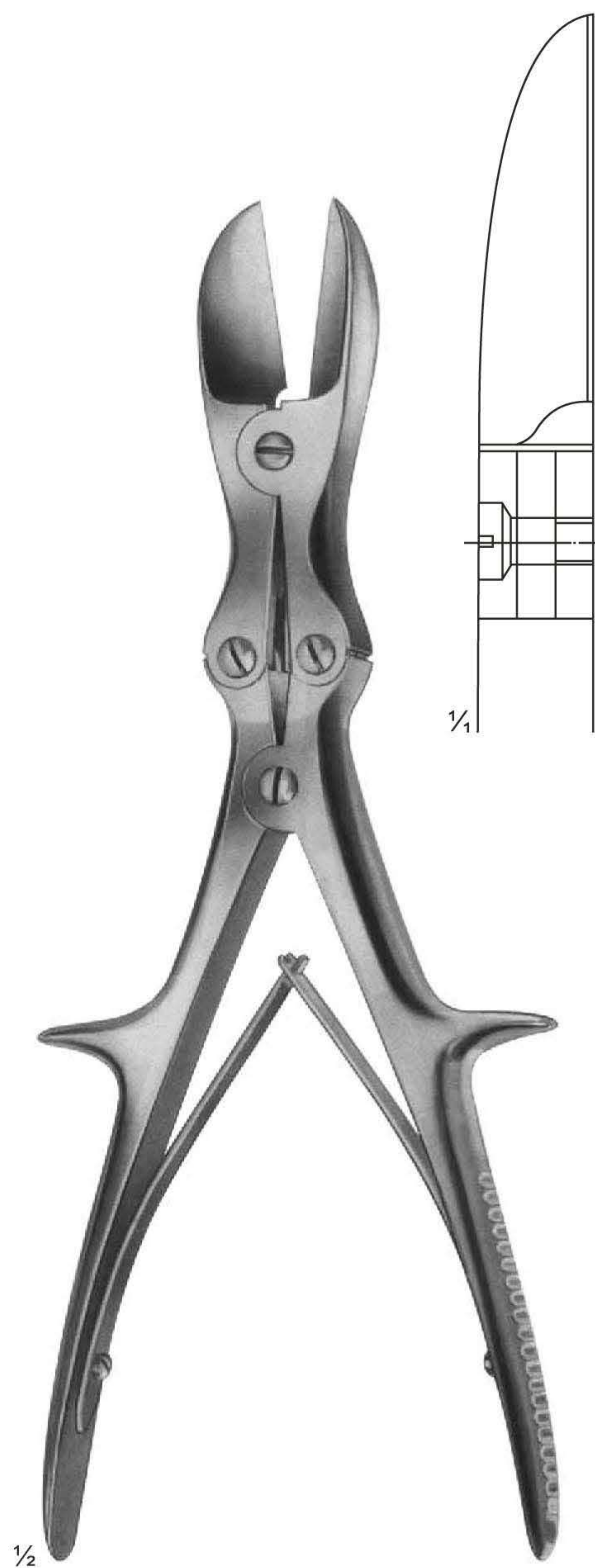

UG-1936  
LISTON  
straight  
280 mm

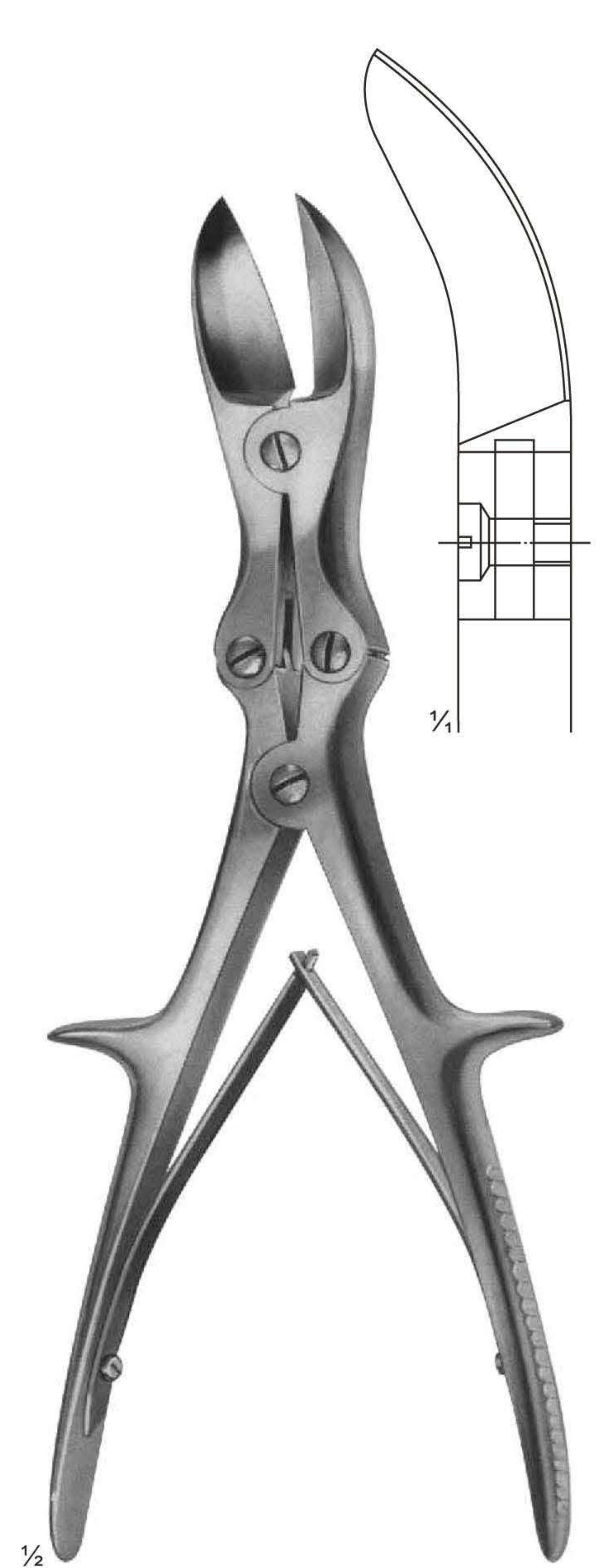

UG-1937  
LISTON  
curved on flat  
280 mm

# Bone Cutting Forceps

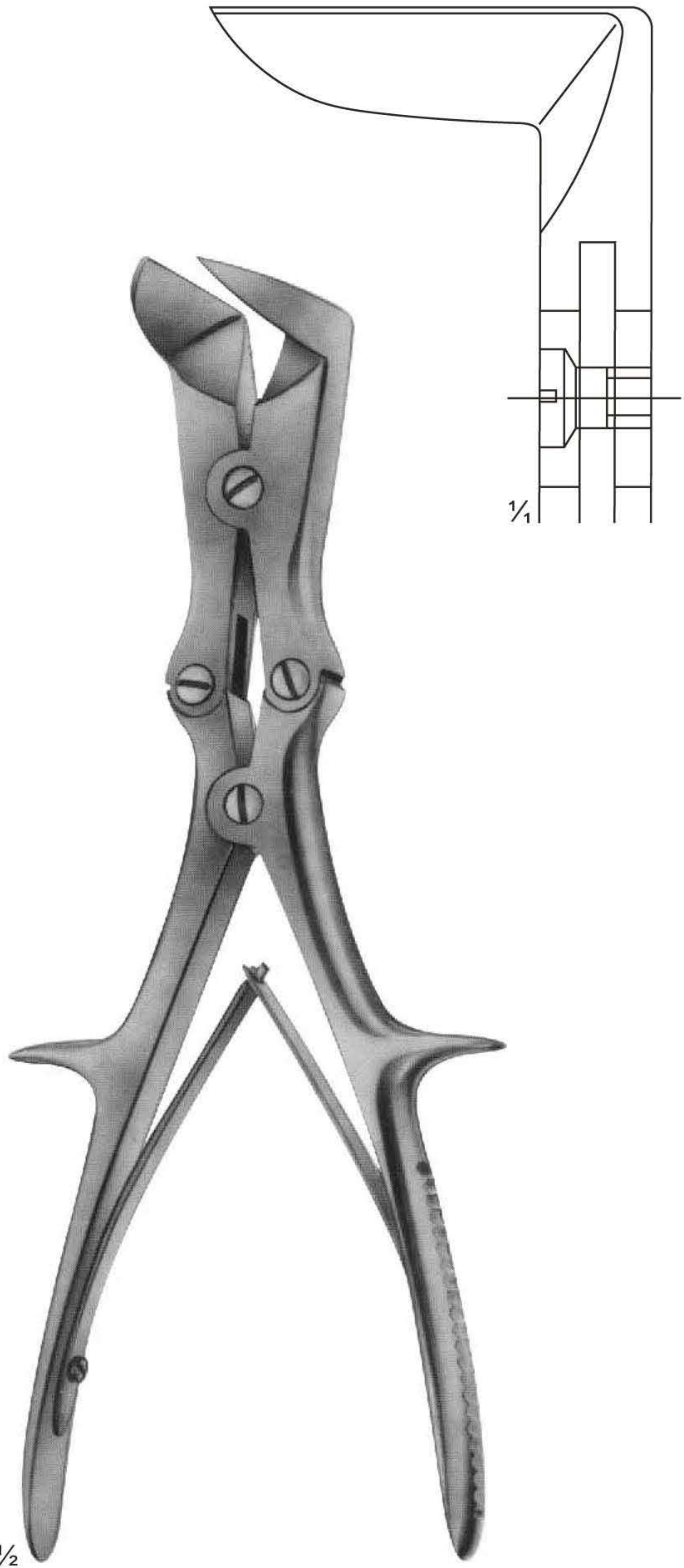

UG-1939  
LISTON-STILLE  
265 mm

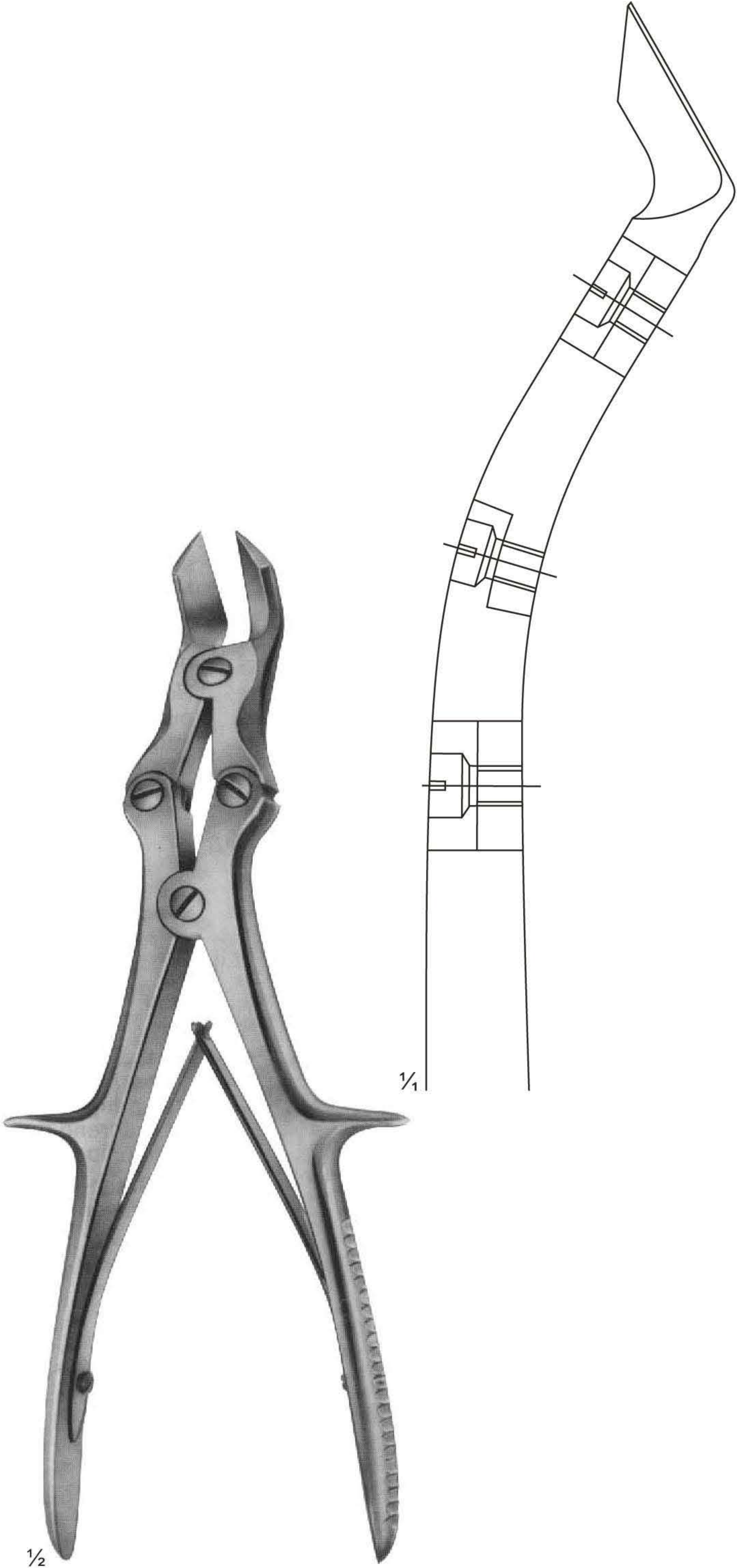

UG-1940  
LISTON-KEY-HORSLEY  
(TUDOR EDWARDS)  
255 mm

# Meniscus-and Cartilage Forceps

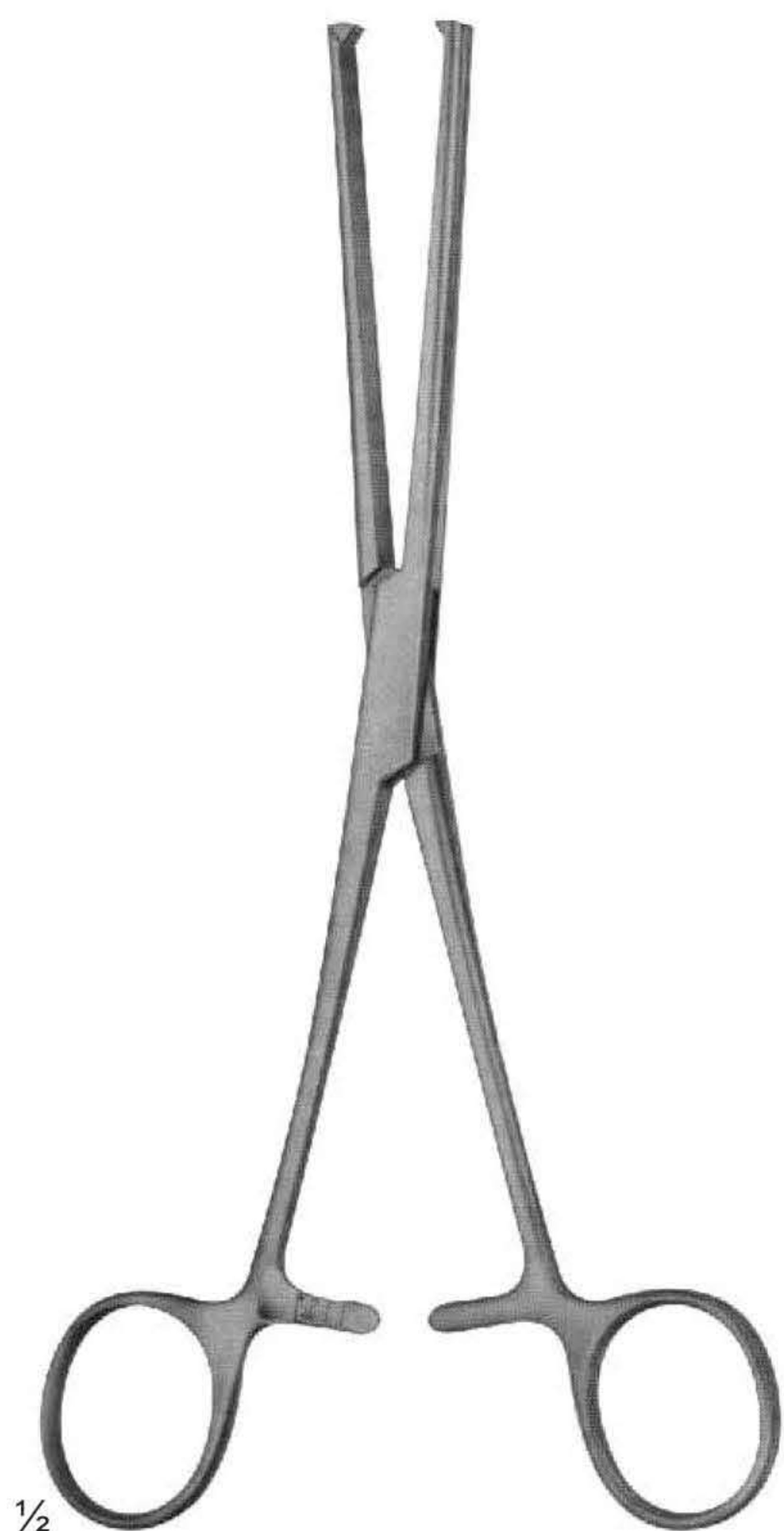

UG-1941  
BIRCHER  
200 mm



UG-1942  
BIRCHER  
200 mm

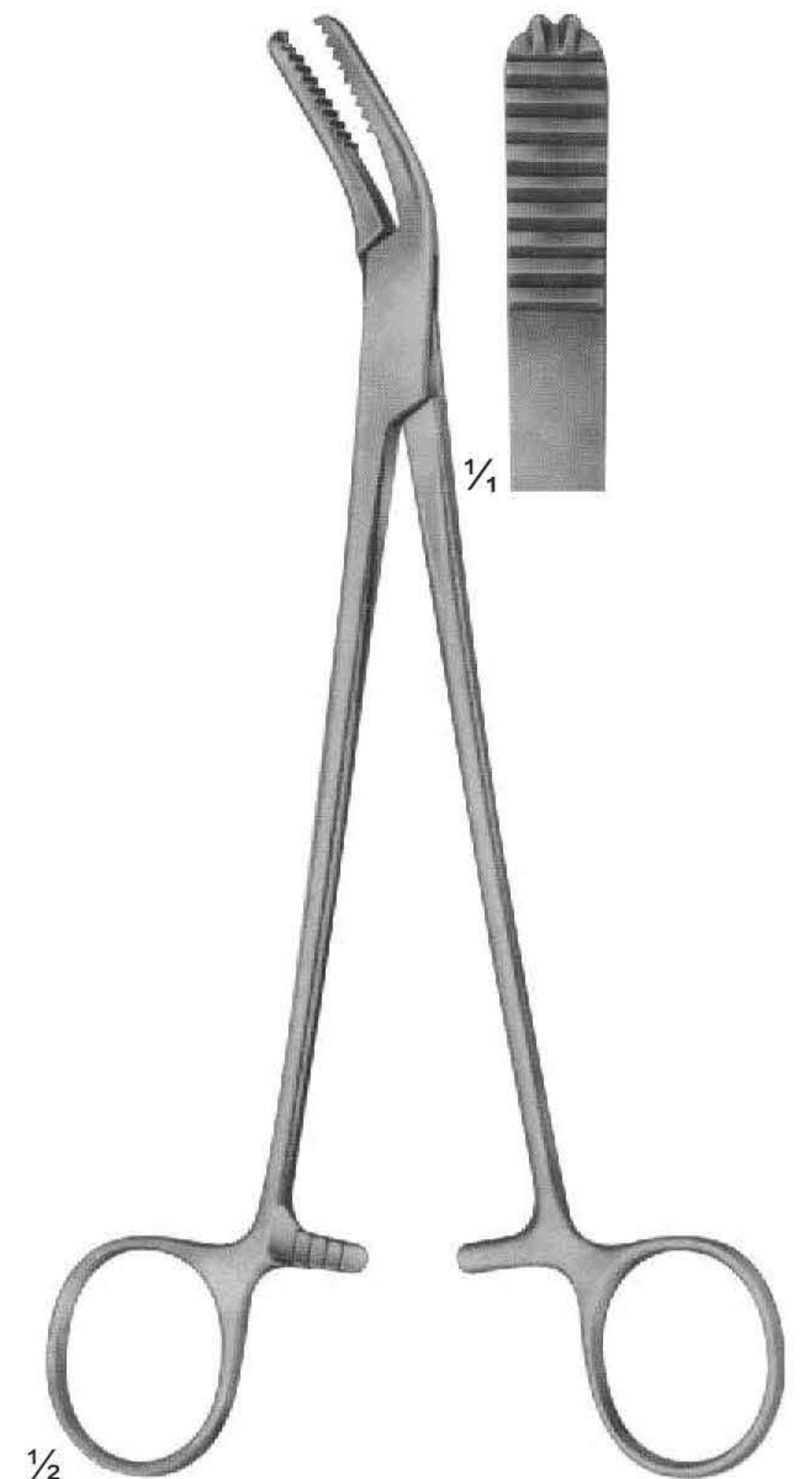

UG-1943  
WELLER  
200 mm

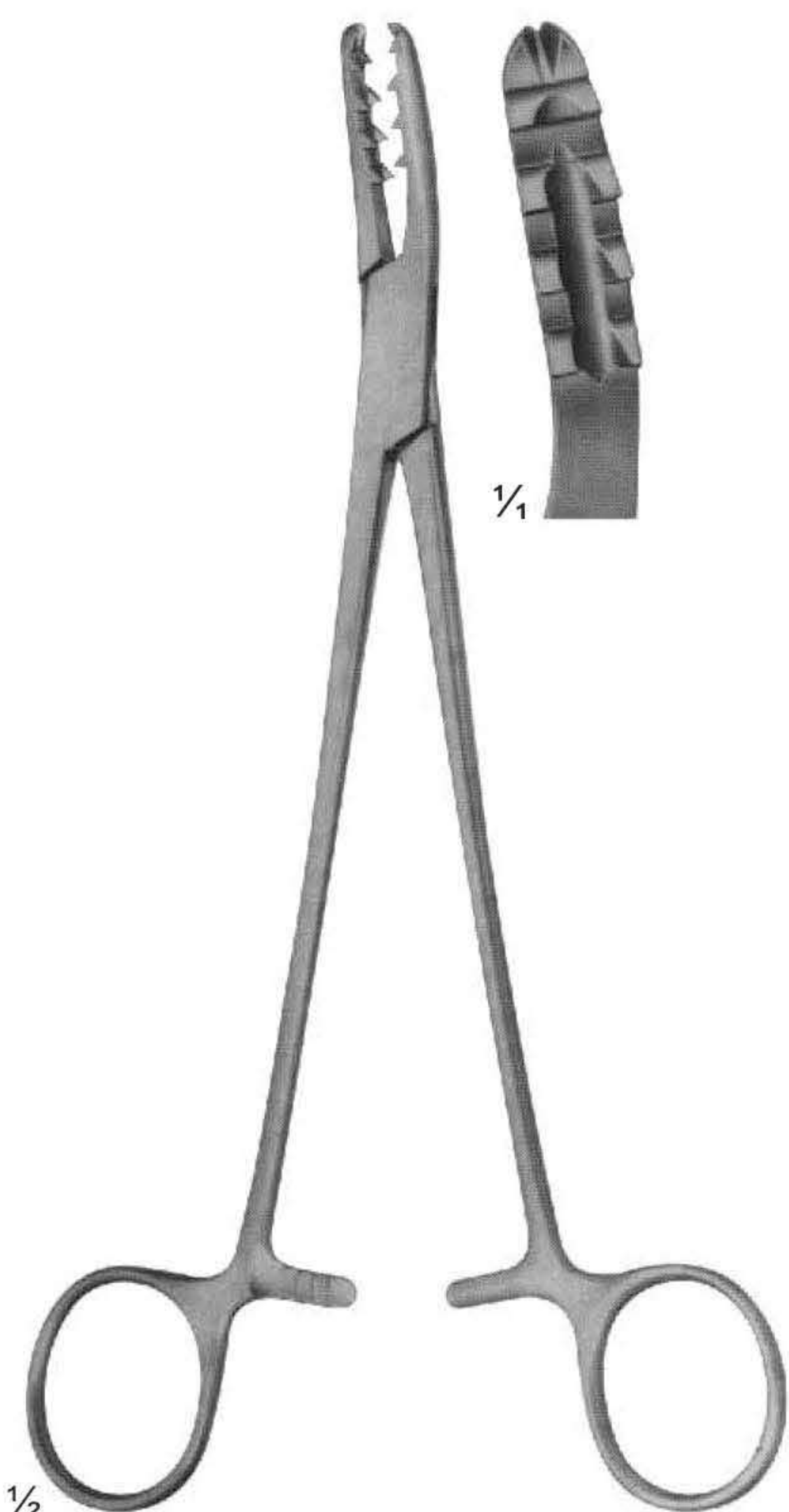

UG-1945  
BIRCHER-GANSKE  
200 mm

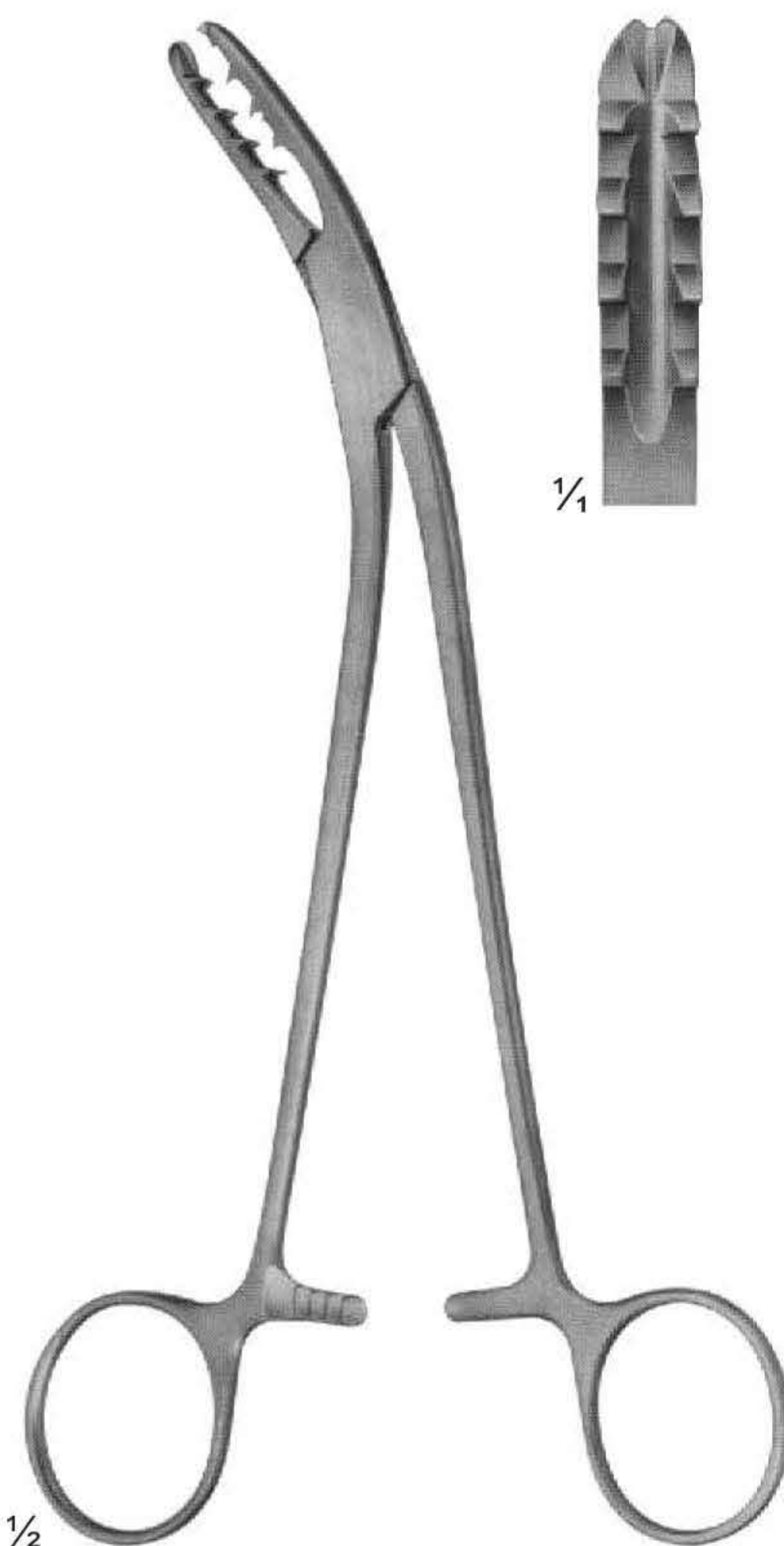

UG-1946  
BIRCHER-GANSKE  
200 mm



UG-1949  
MARTIN  
205 mm

# Meniscus Knives

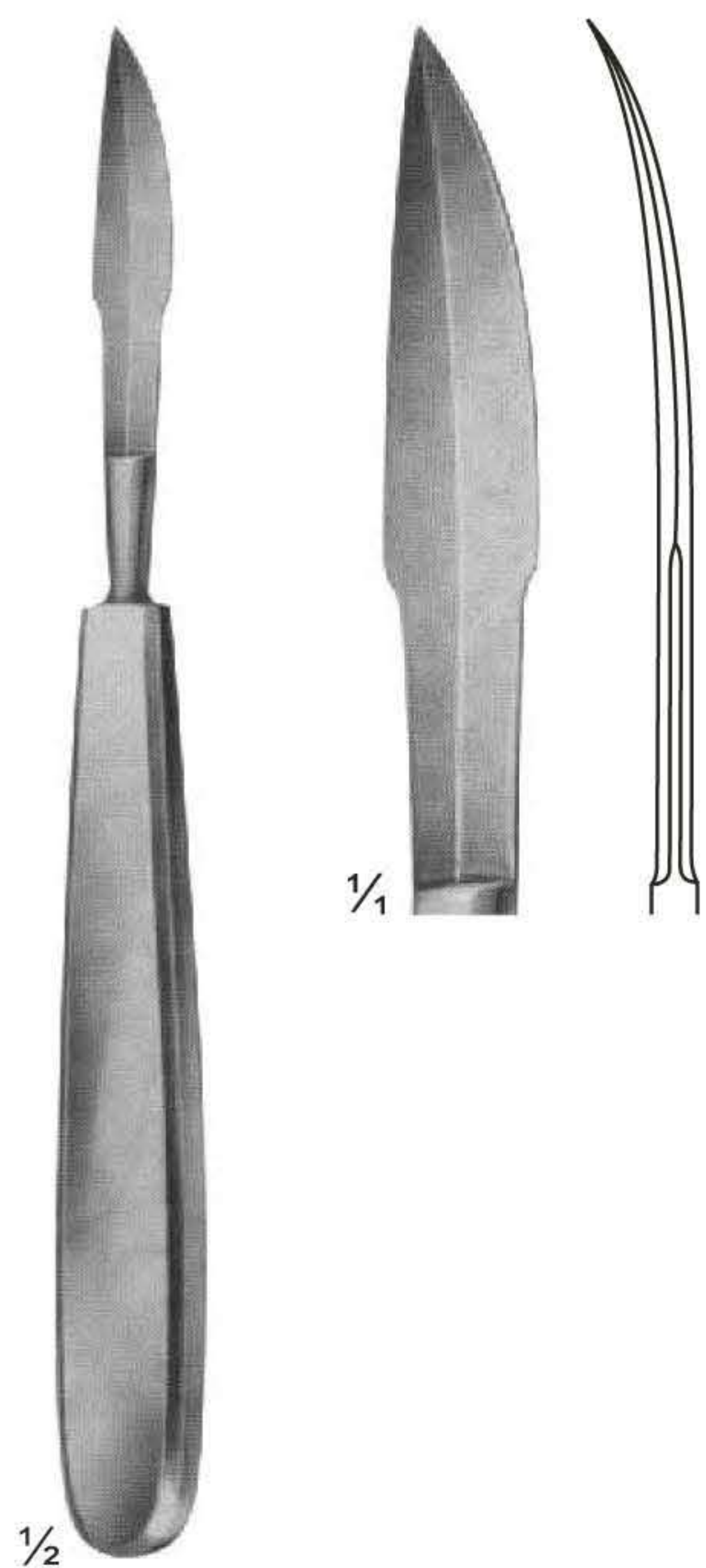

UG-1951  
170 mm

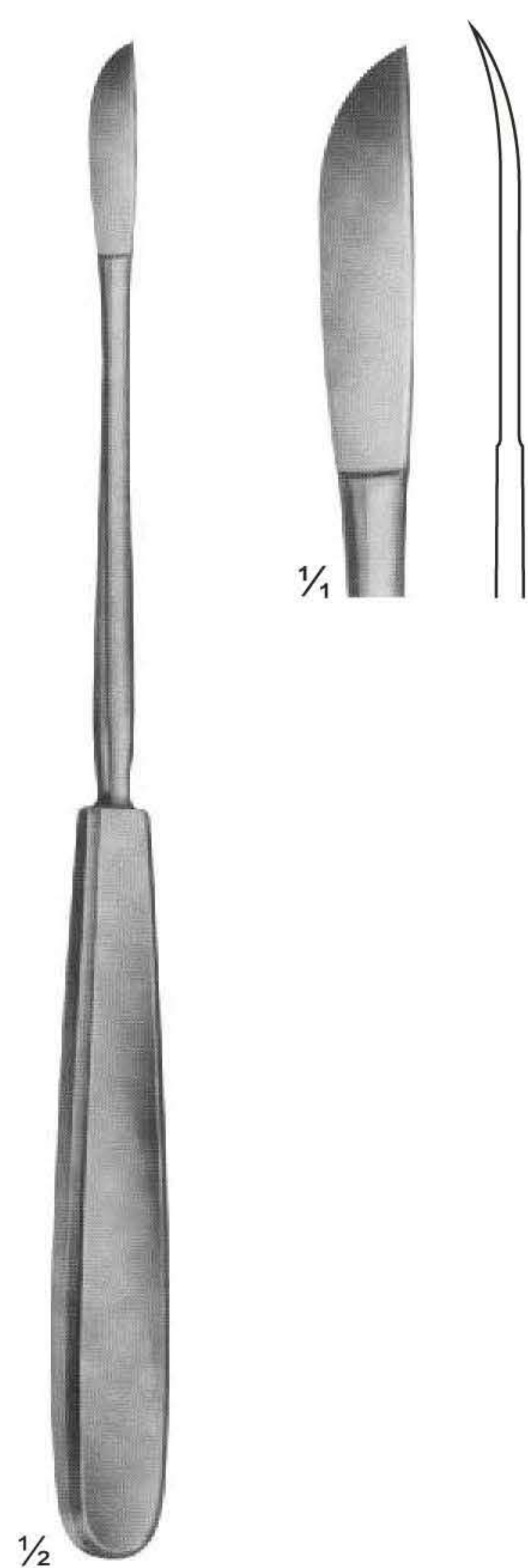

UG-1952  
NEFF  
215 mm

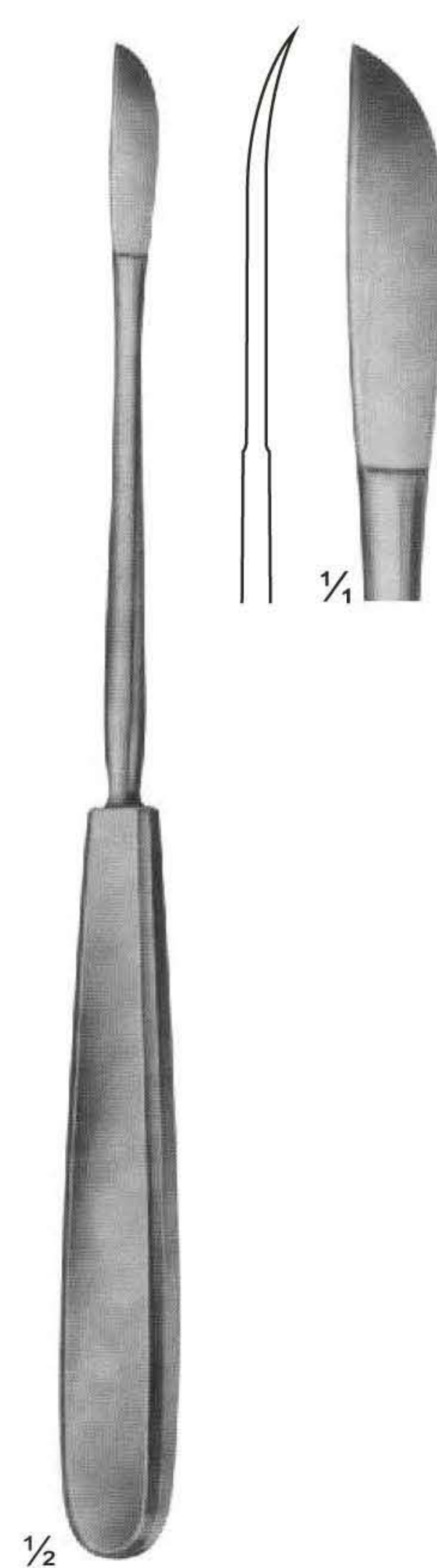

UG-1953  
NEFF  
215 mm

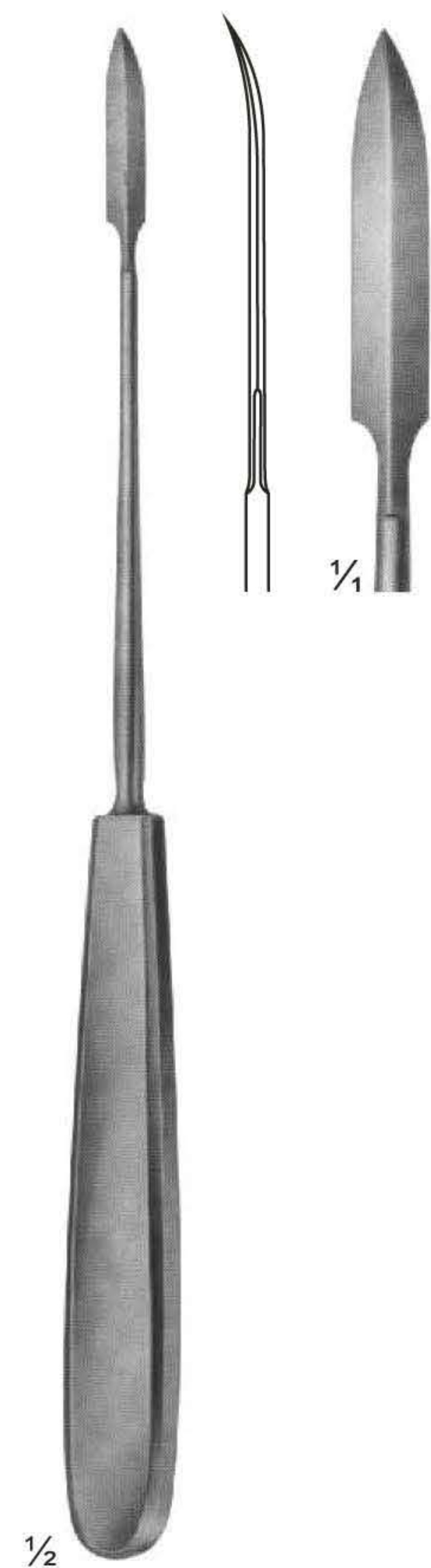

UG-1954  
WAGNER  
215 mm

# Meniscus Knives

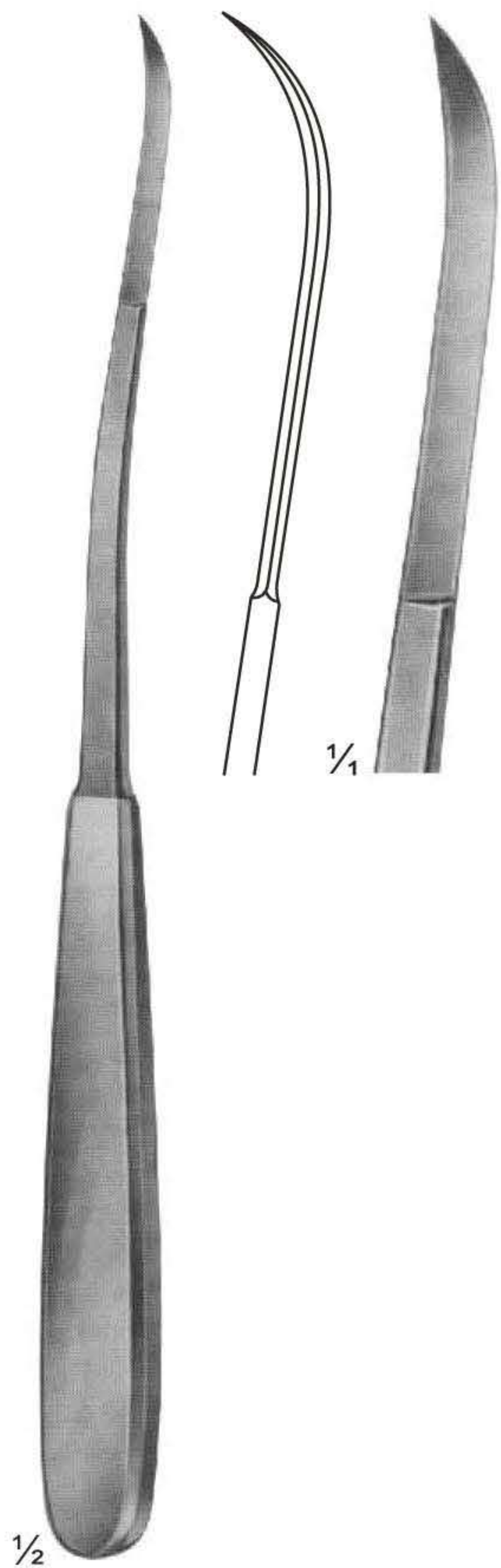

**UG-1956**  
SALENIUS  
220 mm

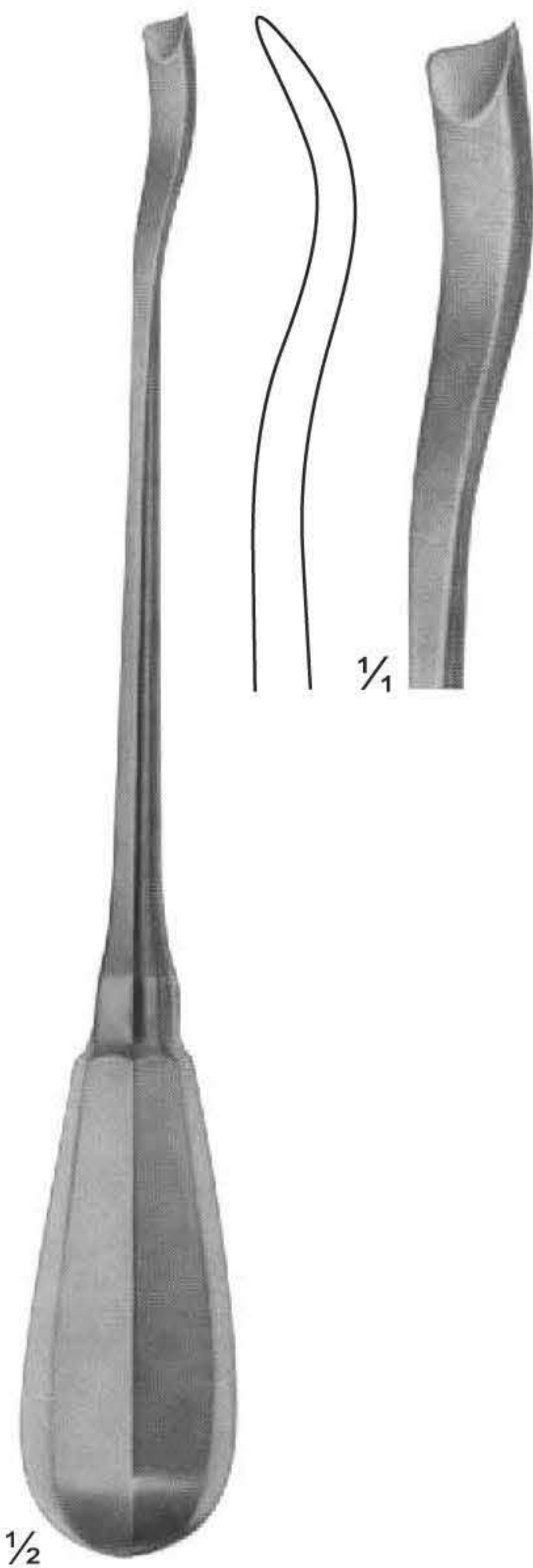

**UG-1957**  
CHNAD.MODELL  
200 mm

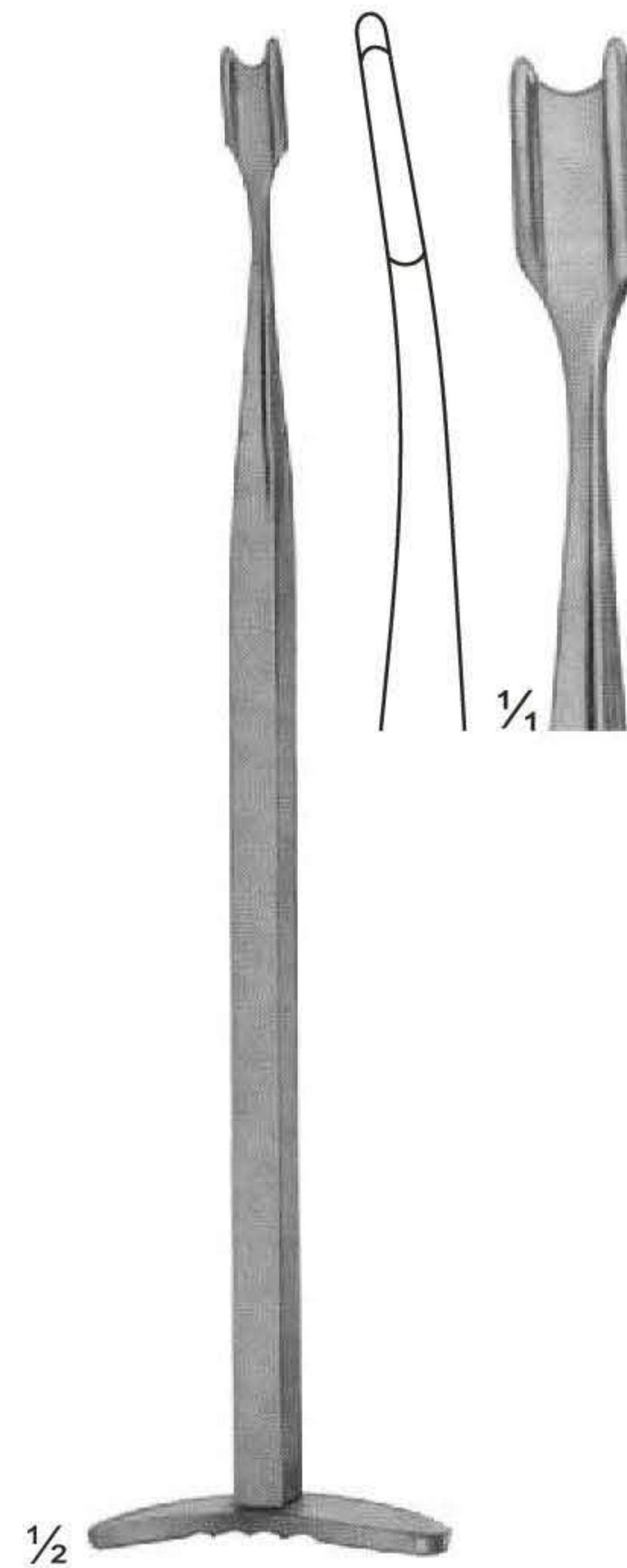

**UG-1959**  
SMILLIE  
170 mm

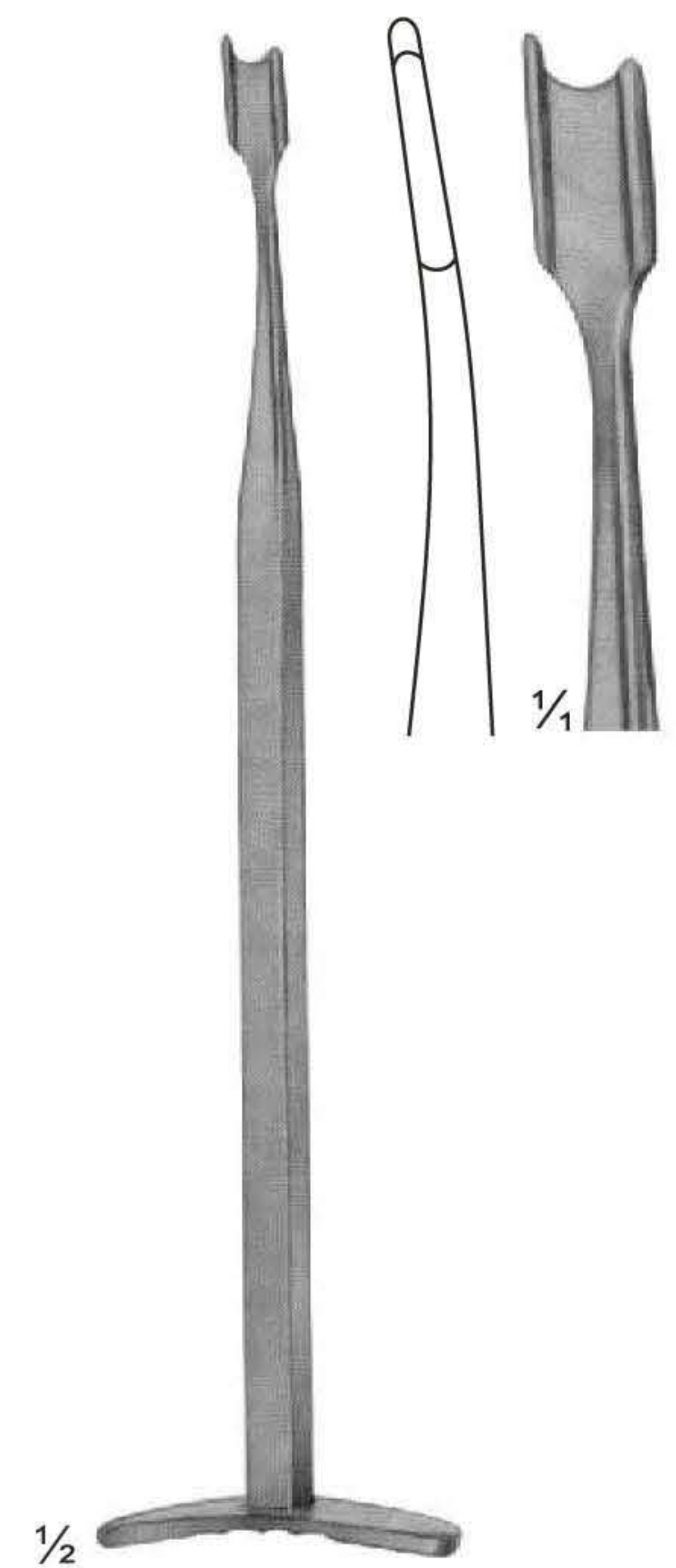

**UG-1960**  
SMILLIE  
170 mm

# Wire Extension

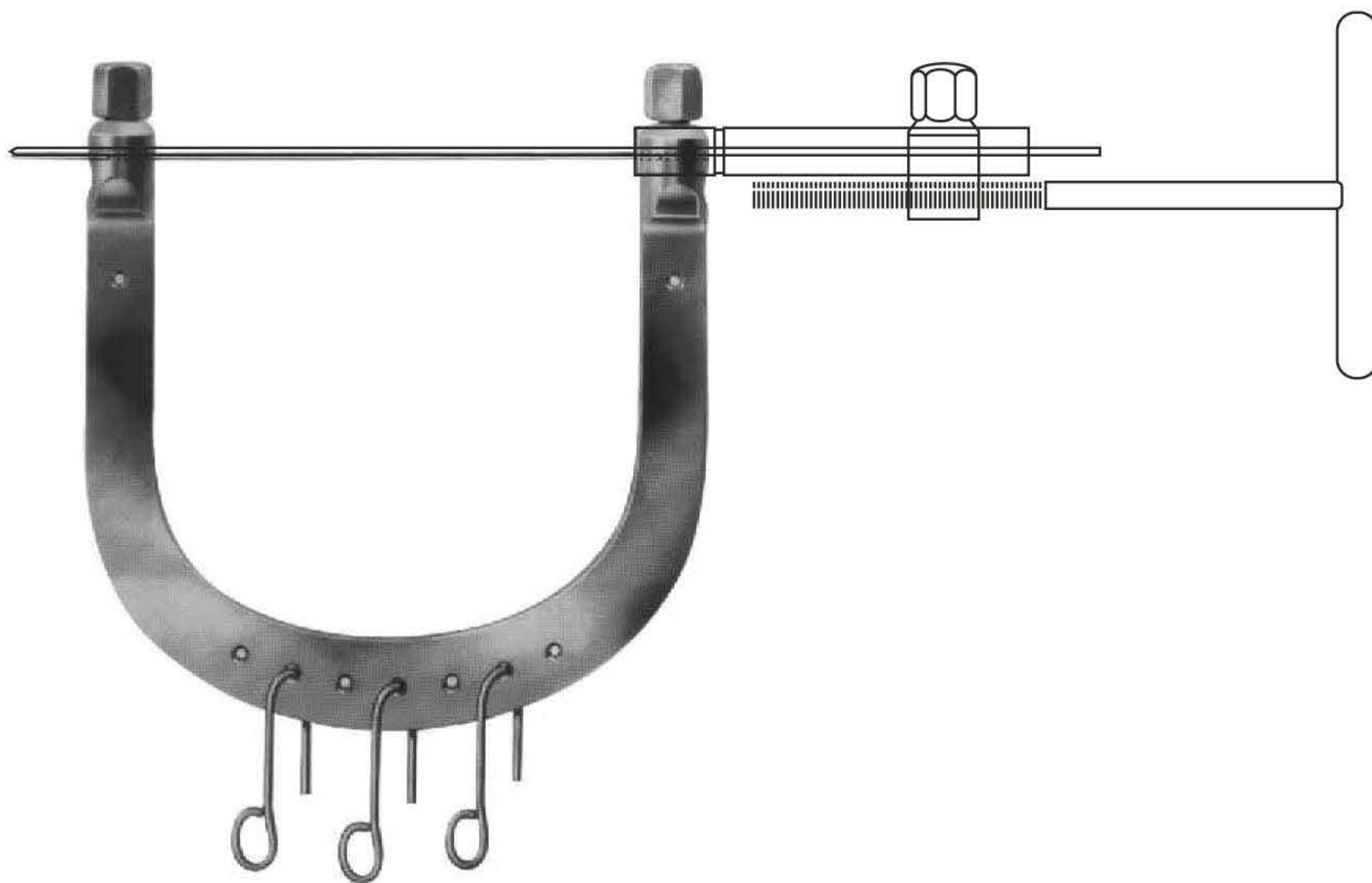

**UG-1738**  
KIRSCHNER  
Wire traction bows,  
to be used with  
KIRSCHNER-wires  
up to 2.5 mm diam.,  
With 3 hooks,  
stainless steel



**UG-1739**  
Wrench, double - ended,  
for wire traction bows



**UG-1740**  
Wire tightener, with  
clamping jaws



**UG-1741**  
Traction hook only,  
large size



**UG-1742**  
Traction hook only,  
small size



**UG-1743**  
Fixation clamp, to secure clamping  
jaws of stainless steel



# Wire Extension

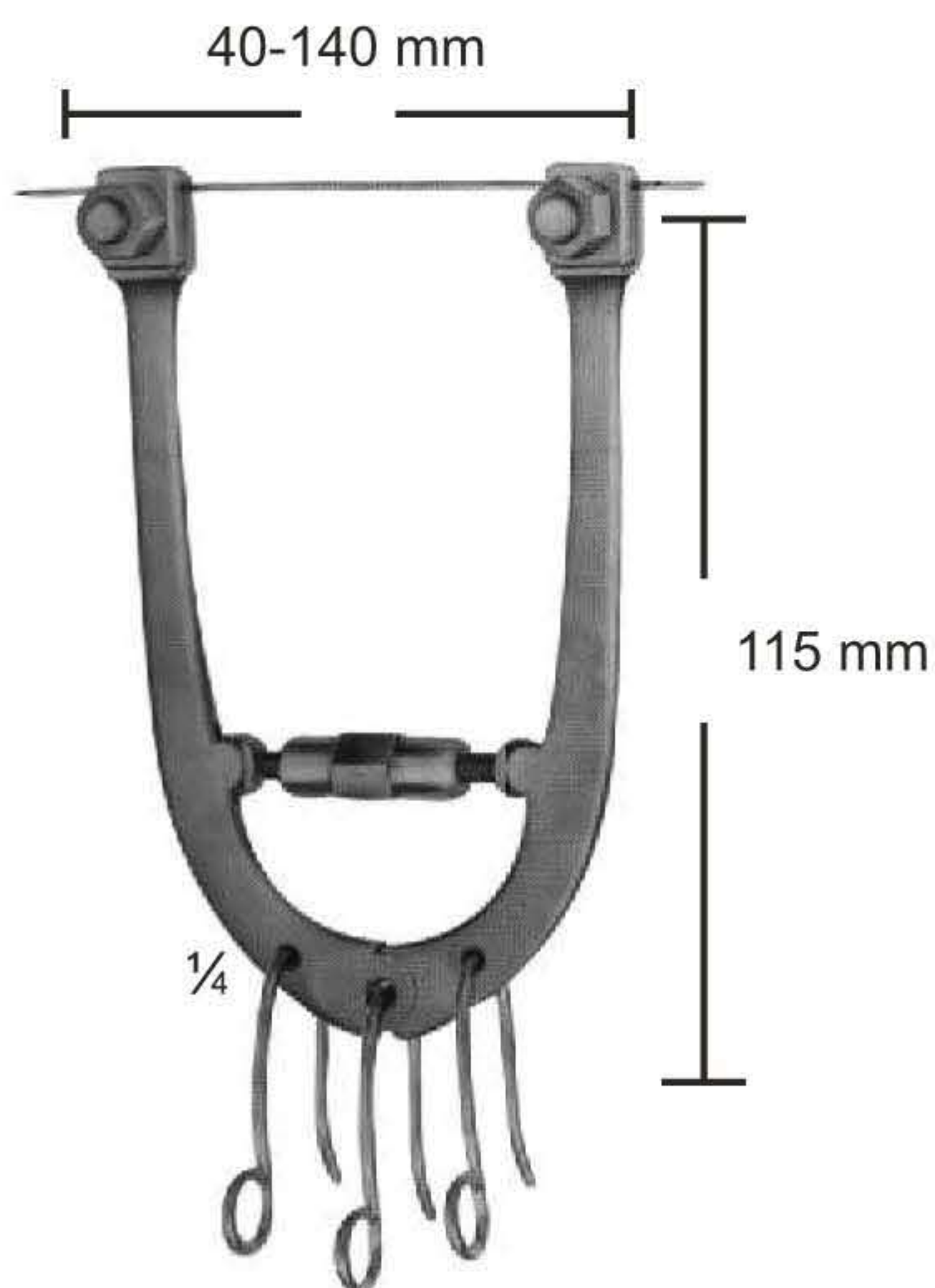

**UG-1745**  
Wire traction bow, adjustable,  
with 3 hooks, small size

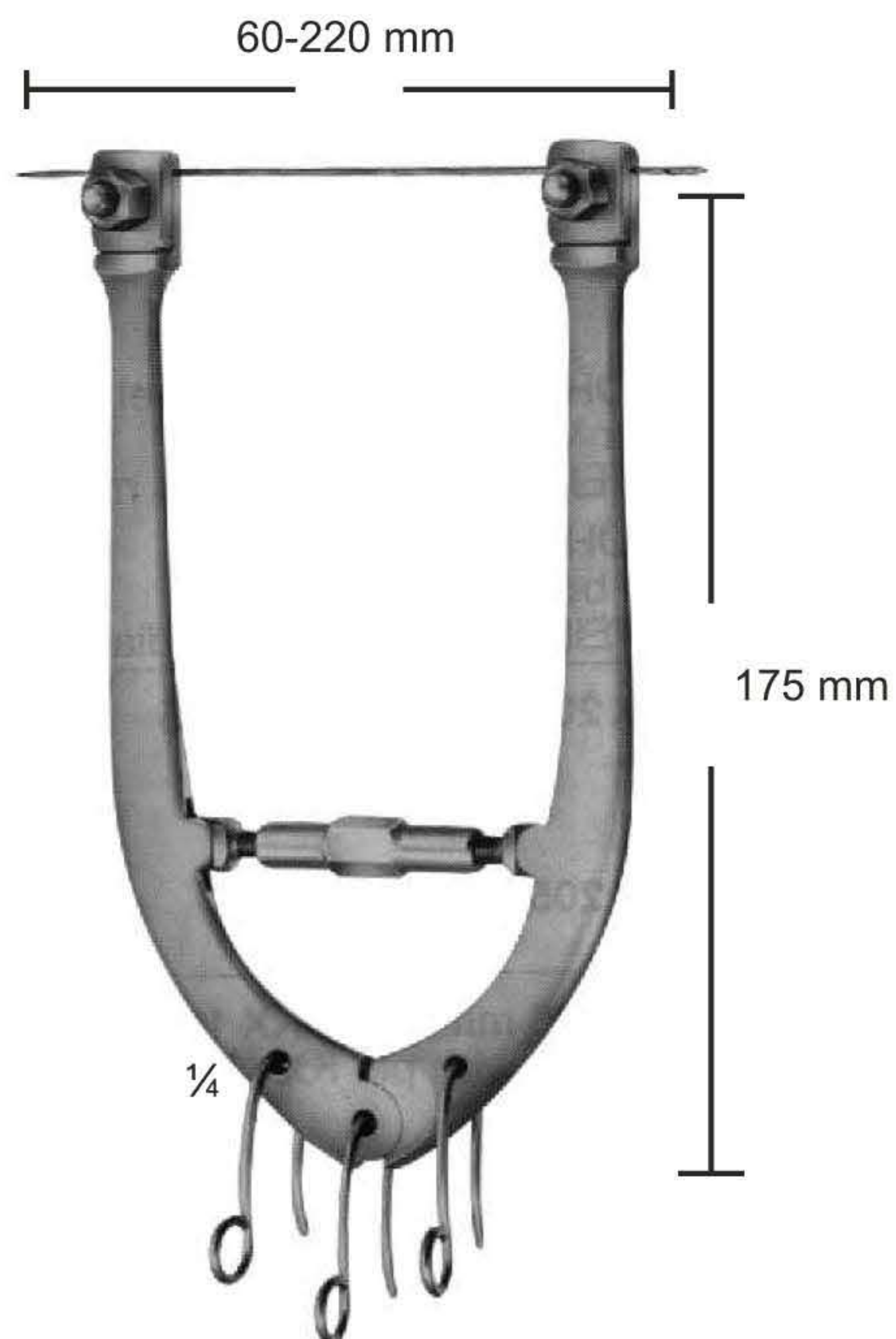

**UG-1746**  
Wire traction bow, adjustable,  
with 3 hooks, large size

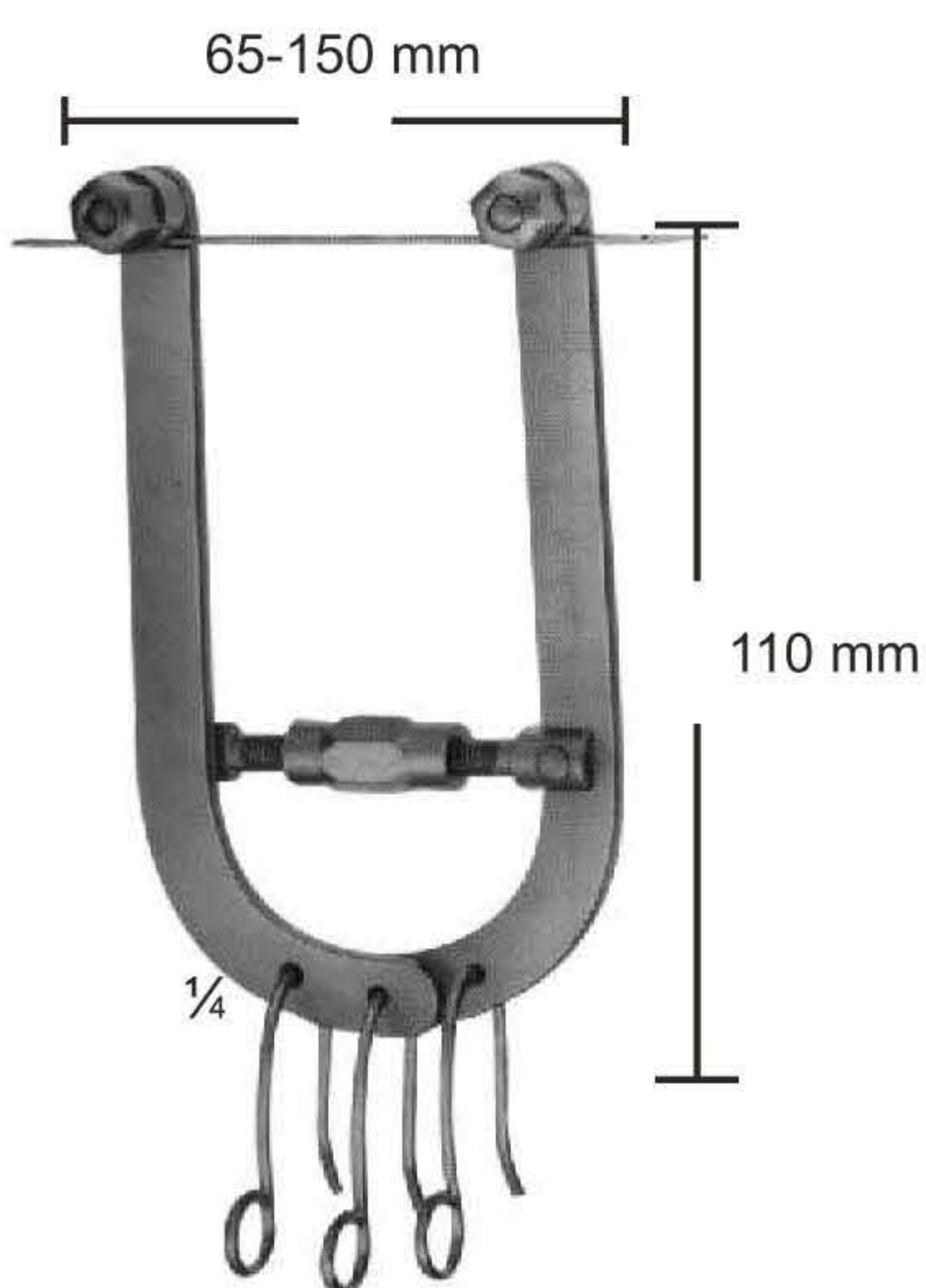

**UG-1747**  
Wire traction bow, adjustable,  
with 3 hooks, large size for  
elbow and calcaneus, for  
adolescents

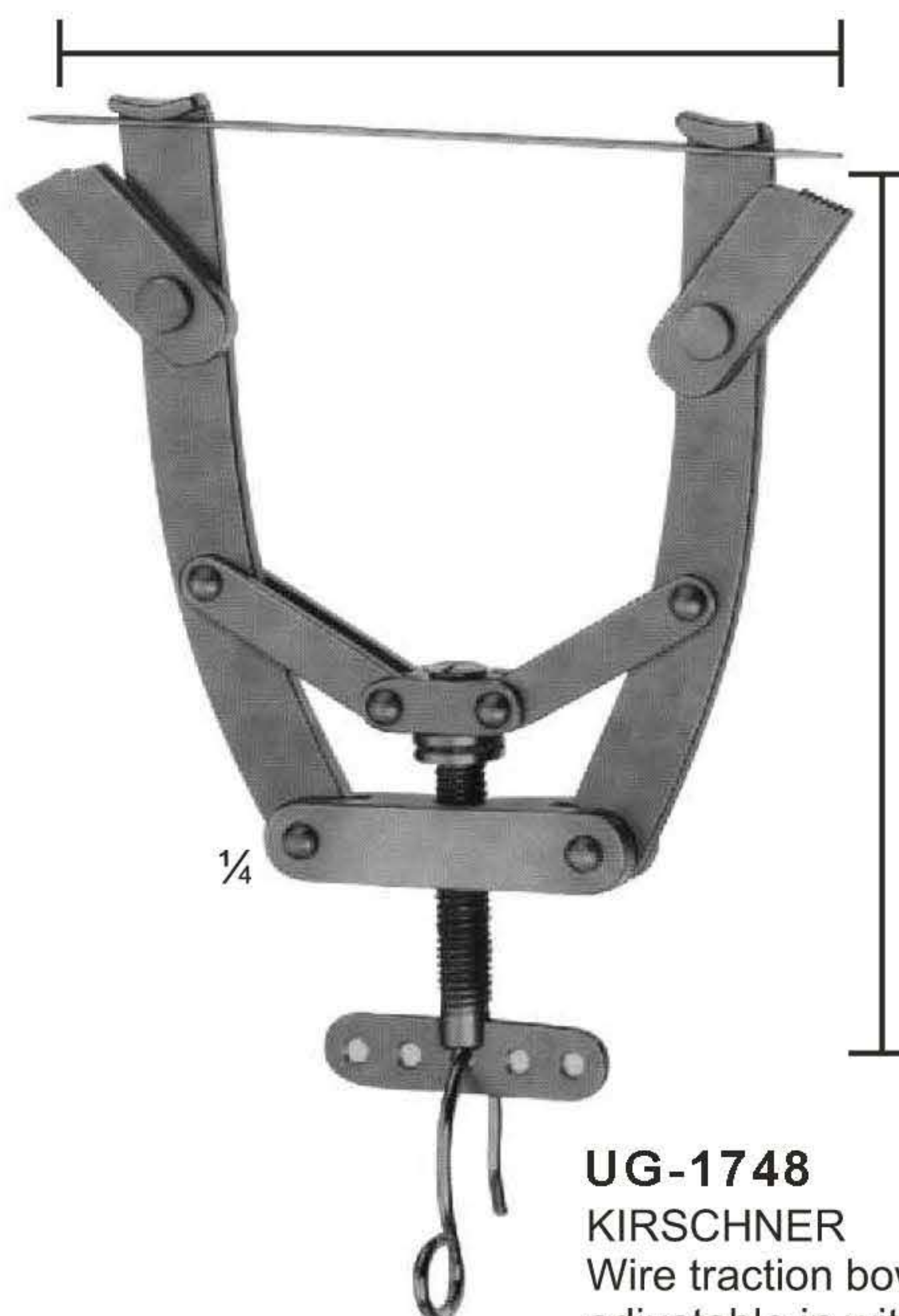

**UG-1748**  
KIRSCHNER  
Wire traction bow, modified  
adjustable in with width, holds wire  
securely, with 1 hook



**UG-1749**  
Fixation disc, slotted



**UG-1751**  
Fixation disc, slotted



**UG-1750**  
idem, aluminum, transparent  
to X-rays



**UG-1752**  
Screw driver, for above  
fixations discs

# Traction Bows, Distractor

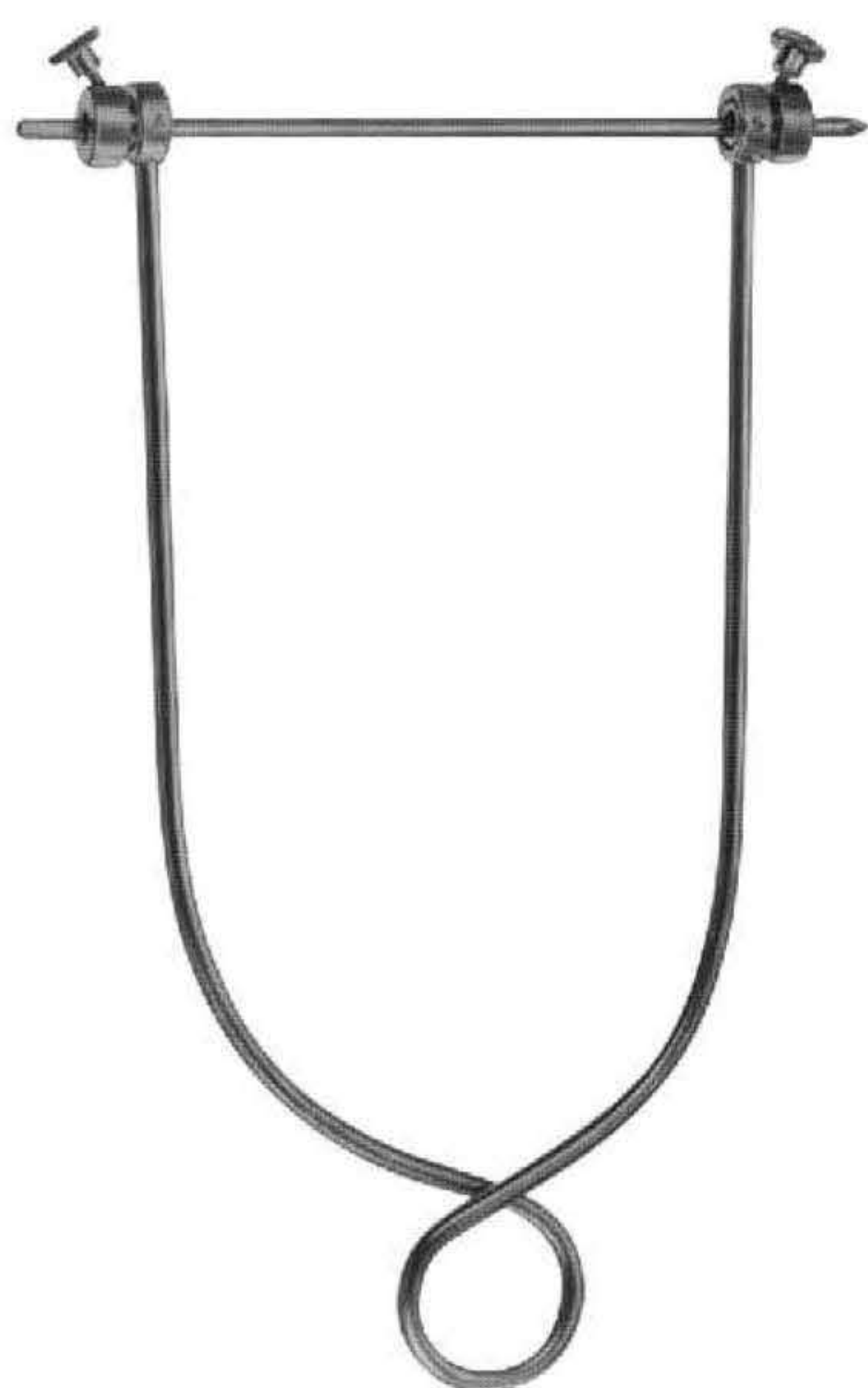

**UG-1755**  
Screw driver, for above  
fixations discs



**UG-1760**  
SCHWARZ  
Traction bow for fingers,  
to be used with KIRSCHNER-  
wire up to 1.6 mm diam.

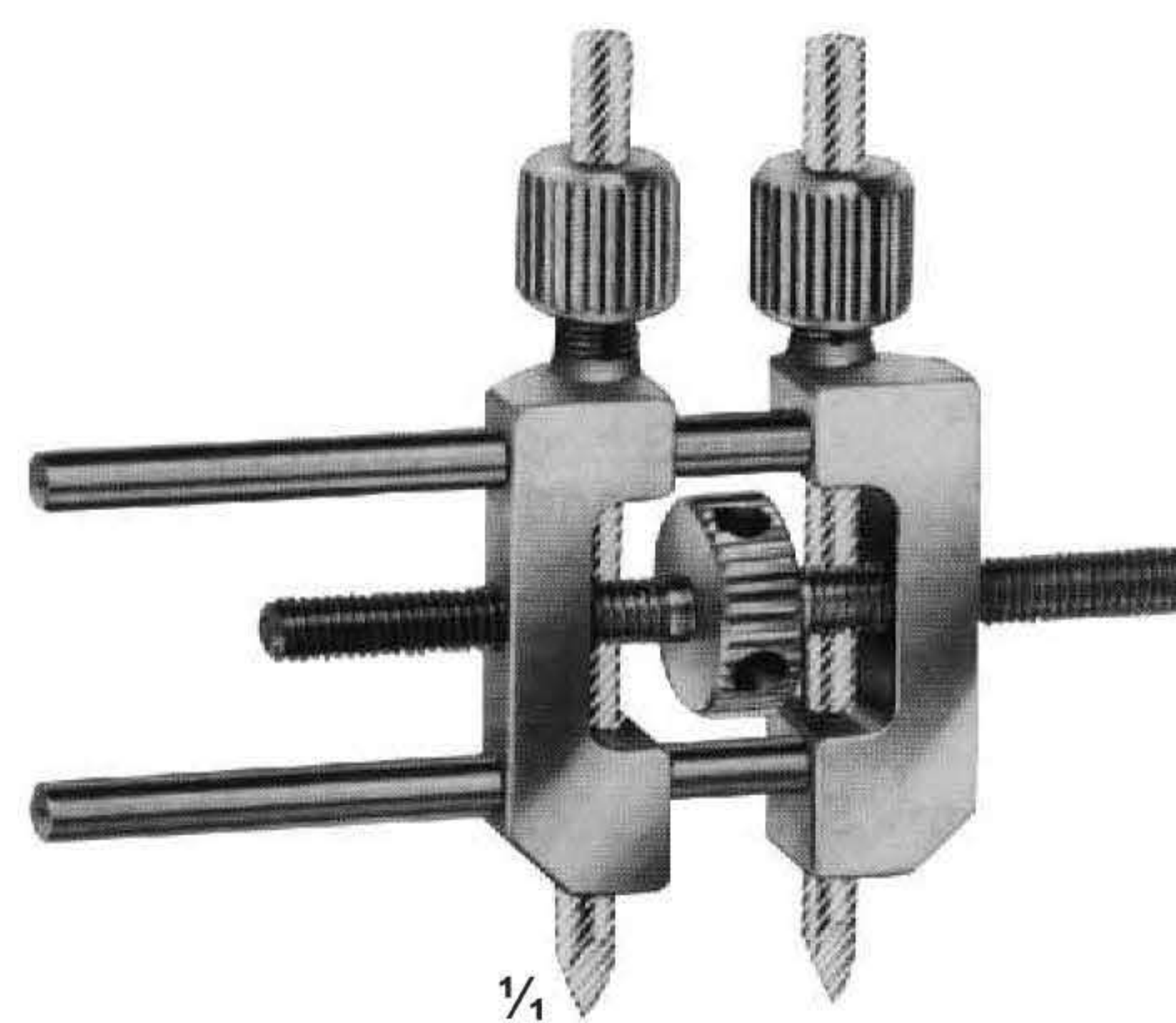

**UG-1761**  
Small distractor  
as a repositioning device for  
distraction and compression of small bones,  
for wires with 3.0 mm diam.

# STEINMANN Pins

---



**UG-1763**  
STEINMANN



$\frac{1}{4}$   
**UG-1775**  
Protection cap  
for 4,0 mm STEINMANN Pins



$\frac{1}{4}$   
**UG-1777**  
Protection cap  
for 5,0 mm STEINMANN Pins

# Drilling Chucks



1/2

**UG-1779**  
REILL  
Drilling chuck, cannulated, for shanks from 2.0 - 2.5 mm diam 115 mm

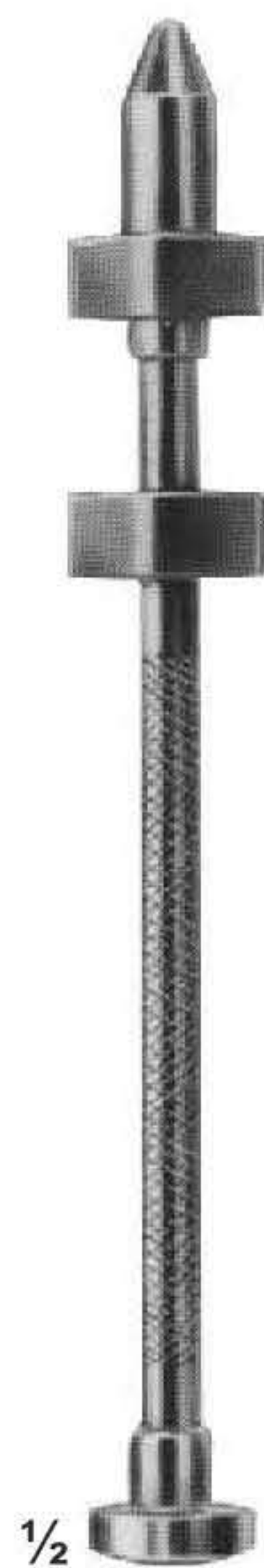

1/2

**UG-1782**  
Drilling chuck, cannulated, for shanks from 0.8 - 2.0 mm diam 150 mm



1/2

**UG-1783**  
Drilling chuck, cannulated, for shanks up to 4.5 mm diam with key 140 mm



1/2

**UG-1784**  
LOUTE  
Wire tightener, improved pattern, with movable tip, for wires up to 1.0 mm diam. 220 mm



1/2

**UG-1786**  
Drilling chuck, cannulated, for shanks up to 6.35 mm diam., To be tightened by hand 100 mm



1/2

**UG-1787**  
Drilling chuck, cannulated, for shanks up to 4.5 mm diam., And for triangular shaft width across flats 4.7 mm



1/2

**UG-1789**  
Drilling chuck, cannulated, for shanks up to 6.35 mm diam., With key 160 mm

# Cerclage Instruments

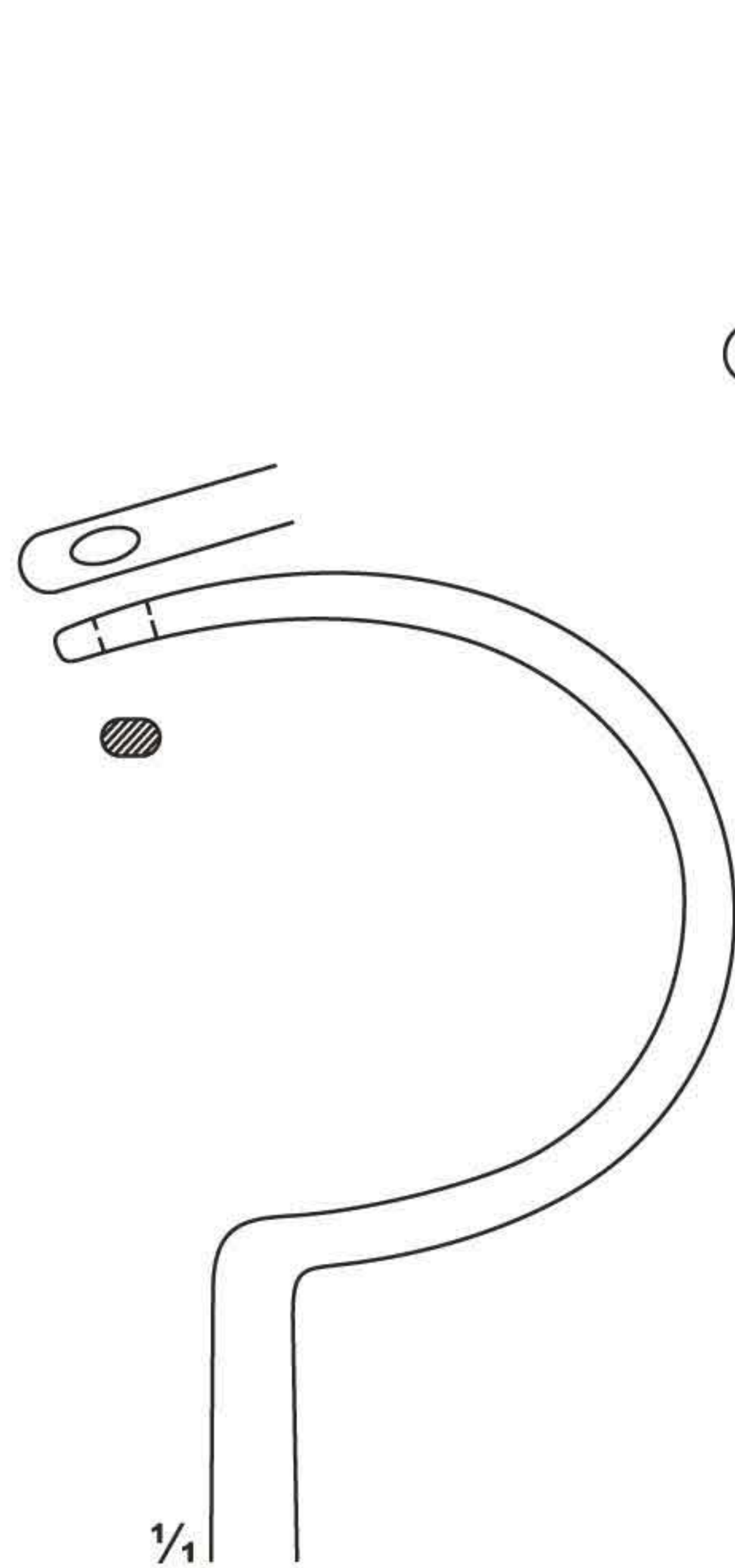

**UG-1794**  
275 mm

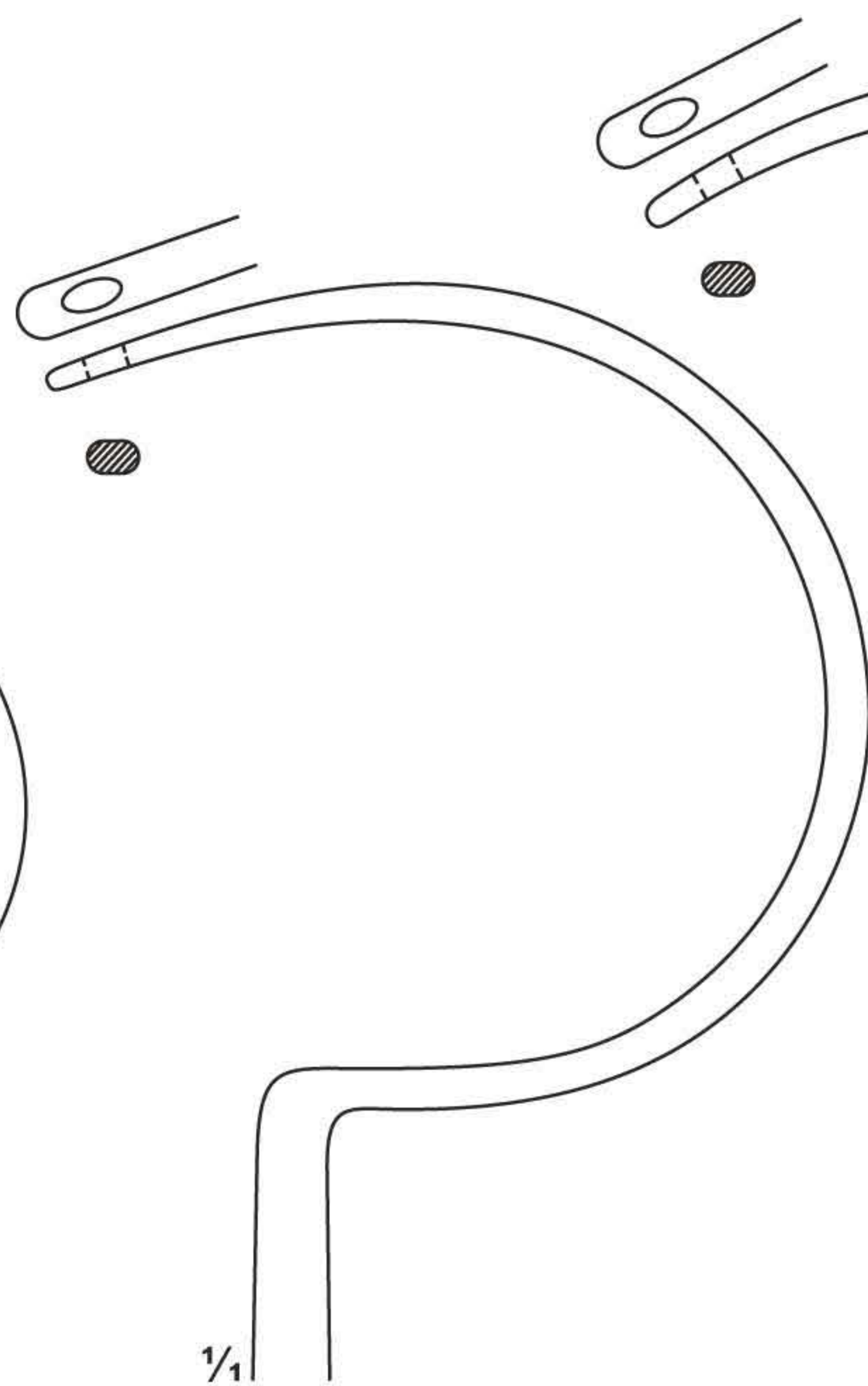

**UG-1797**  
285 mm

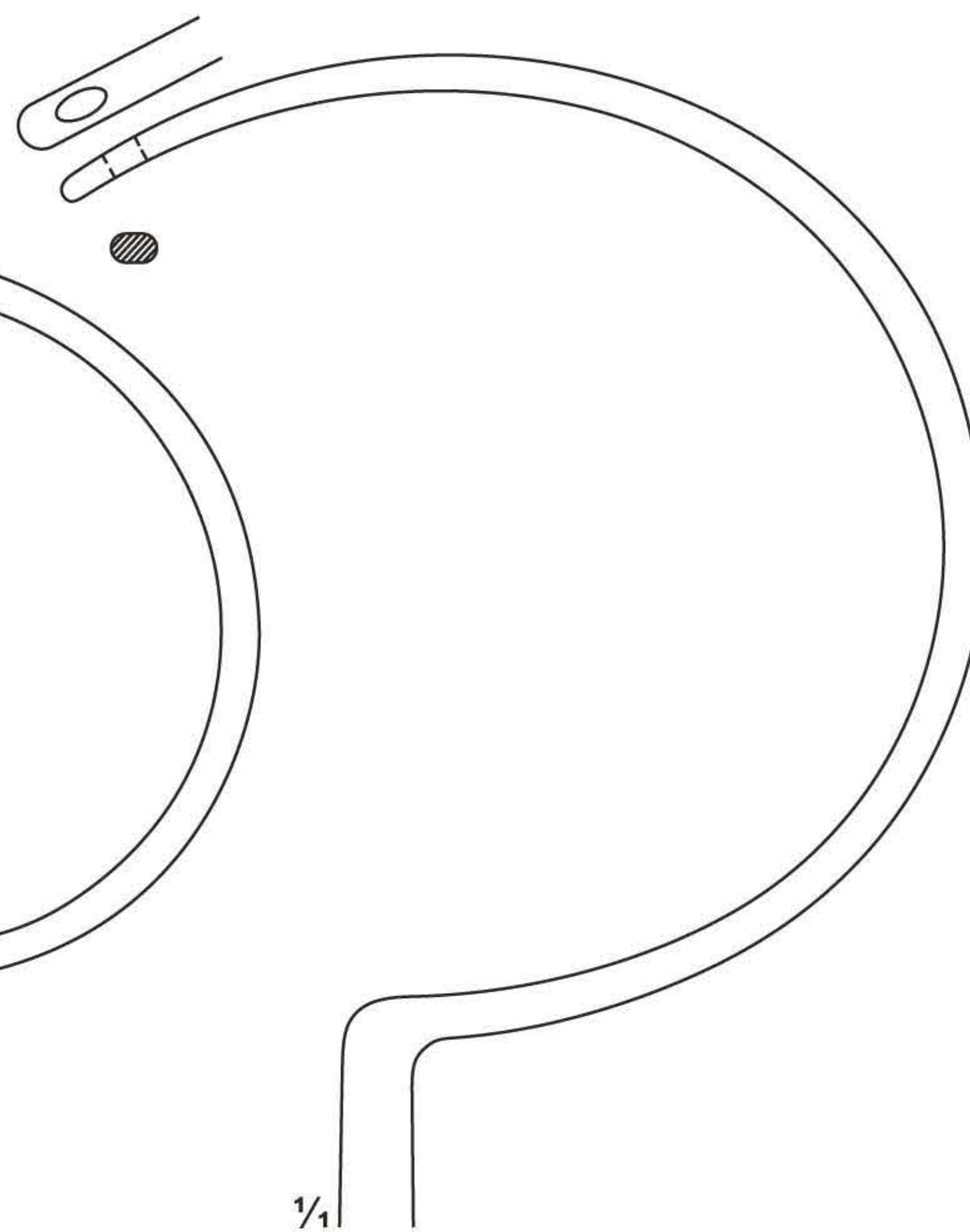

**UG-1799**  
305 mm



**UG-1792**  
DEMEL  
Wire guides

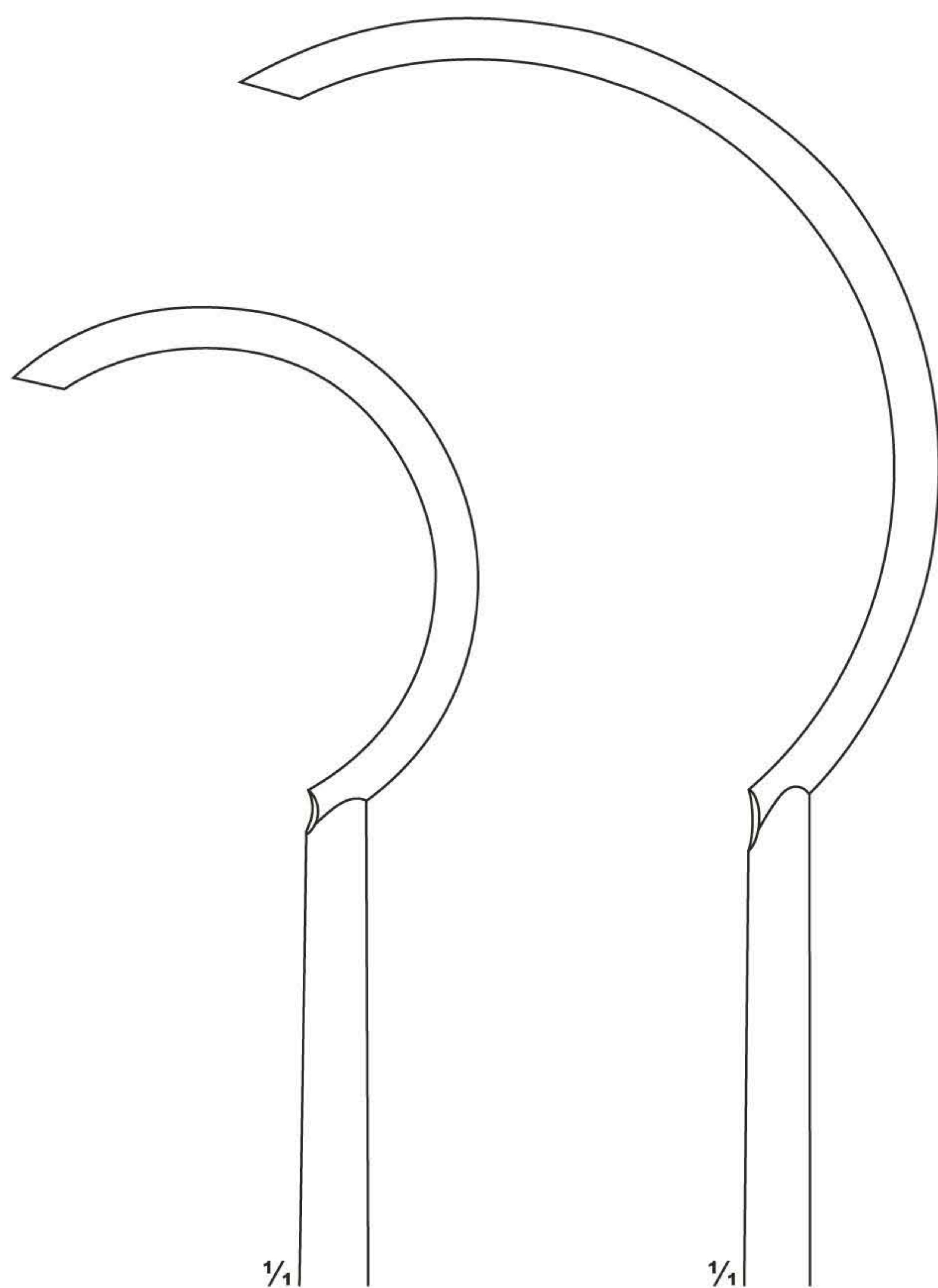

**UG-1800**  
240 mm

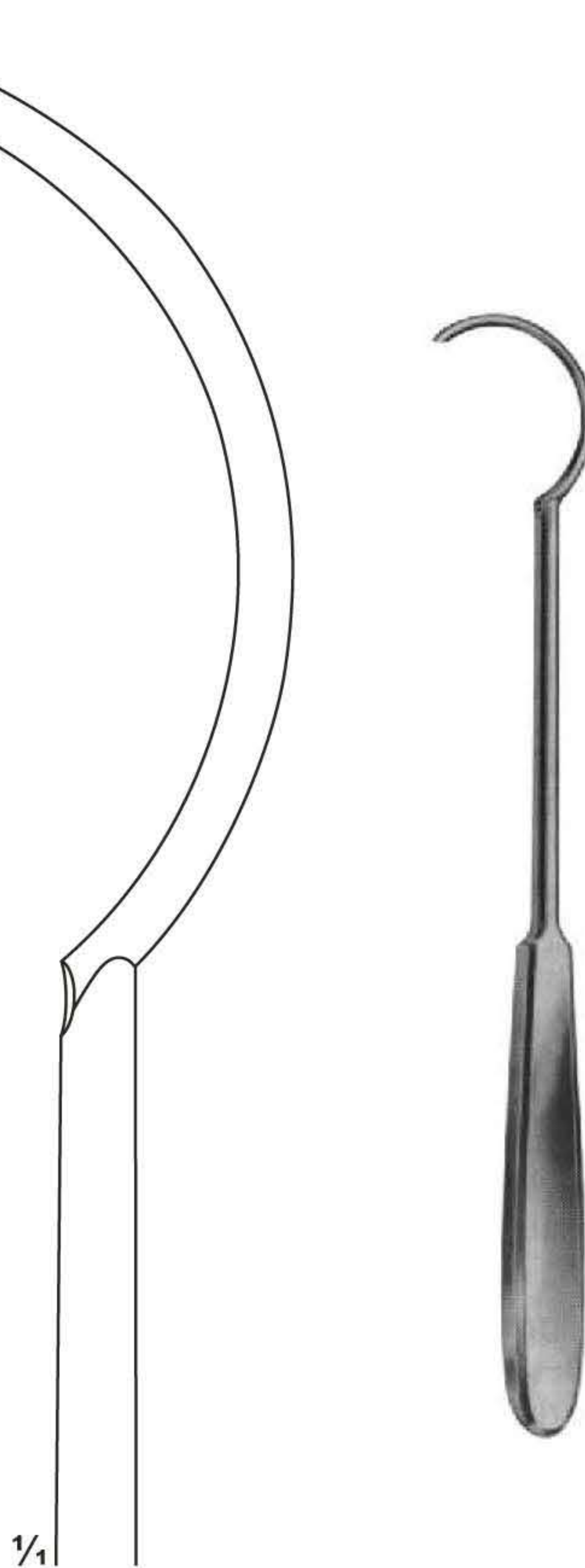

**UG-1801**  
270 mm

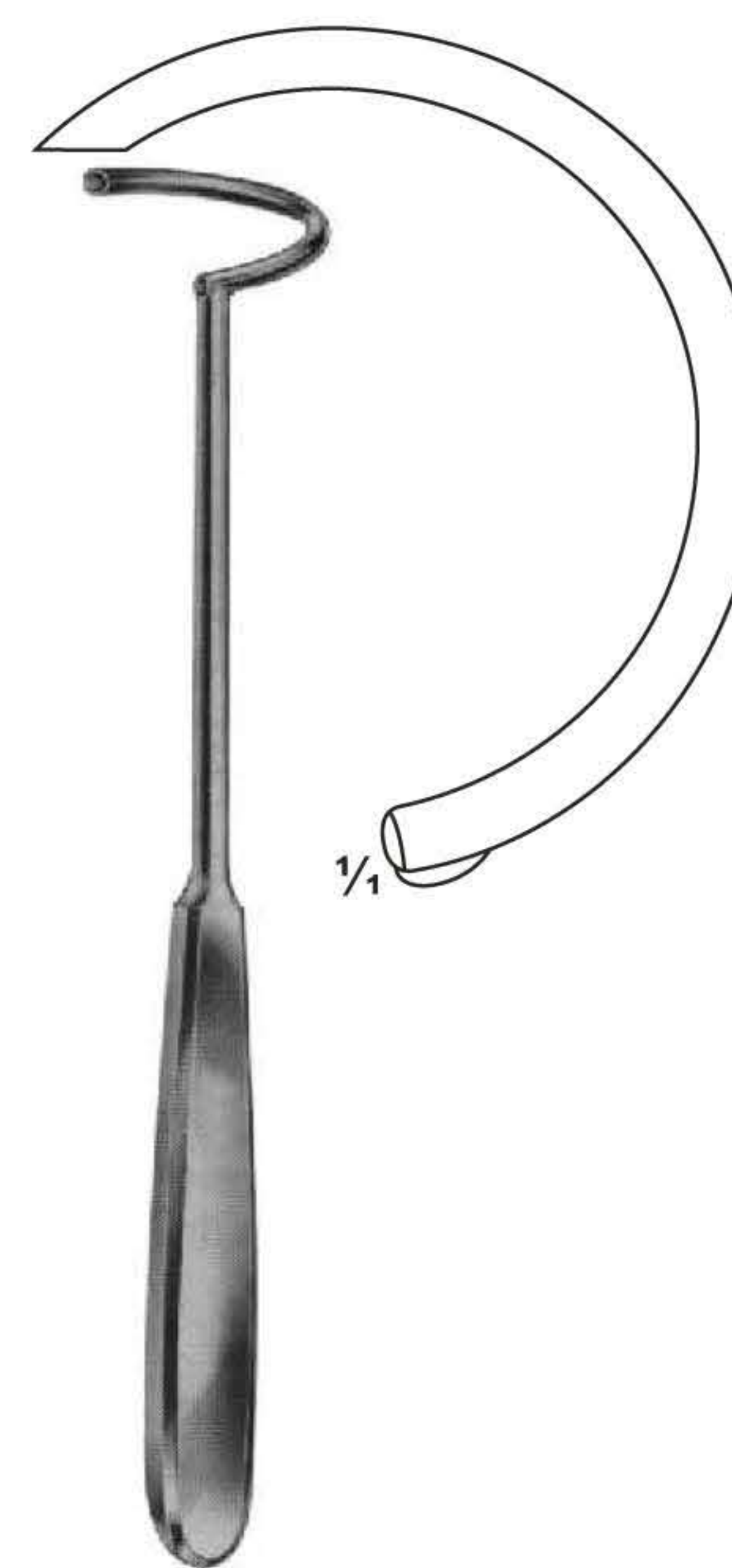

**UG-1802**  
225 mm

# JORDAN instruments for subcutaneous Tibia Cerclage



**UG-1805**  
JORDAN  
Wire tightener



**UG-1806**  
JORDAN  
Wire twister  
170 mm



**UG-1807**  
JORDAN  
Wire catcher  
180 mm



**UG-1808**  
JORDAN  
Probe, cannulated  
170 mm

# Wire Holding forceps, Wire Tightening Pliers, Flat-nosed Pliers

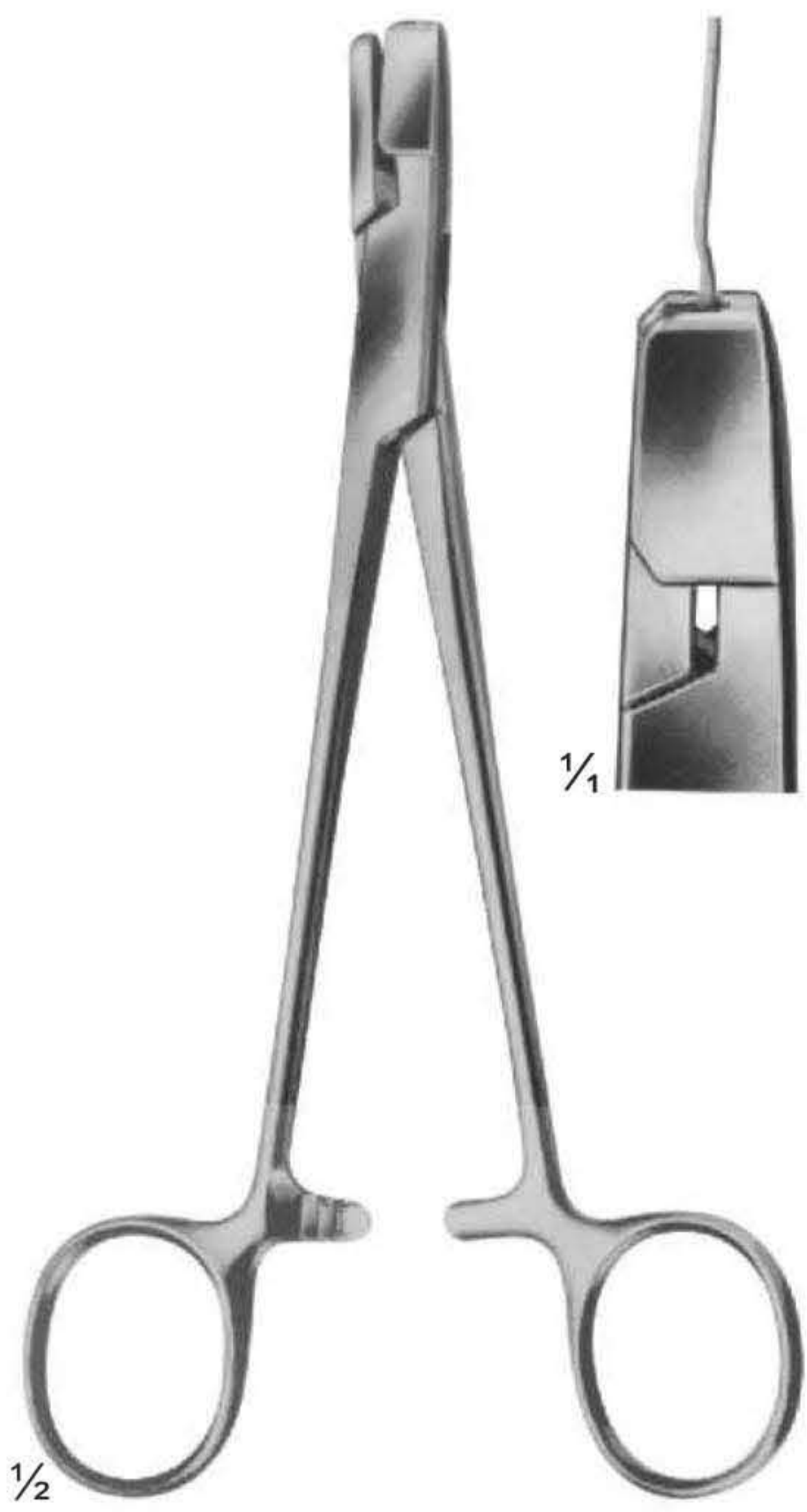

**UG-1809**  
DUROGRIP  
Holding forceps for cerclage  
wire, with lateral jaws to avoid  
wire slipping off  
170 mm



**UG-1810**  
DUROGRIP  
Wire, tightening pliers,  
Ligature pliers  
150 mm



**UG-1811**  
DUROGRIP  
Wire, tightening pliers,  
Ligature pliers  
150 mm



**UG-1812**  
with serrated jaws  
140 mm



**UG-1813**  
one jaws smooth,  
one jaws serrated  
140 mm



**UG-1814**  
with serrated jaws  
with longitudinal and  
transversal grooves  
170 mm



**UG-1815**  
190 mm

# Wire Holding forceps, Flat-nosed Pliers, Pliers for bending and cutting wires



1/2

**UG-1817**  
Extraction pliers  
for boring wires

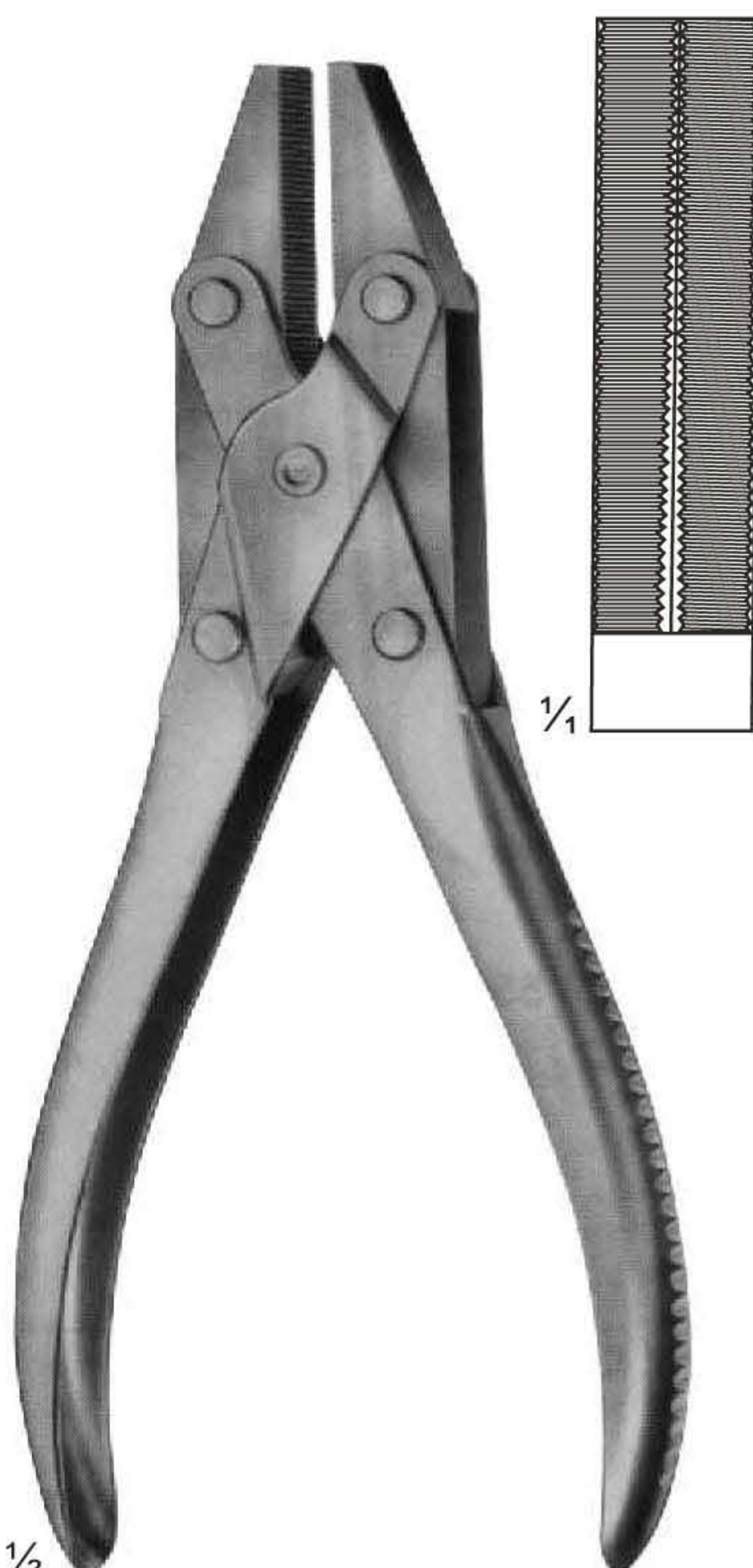

1/2

**UG-1818**  
Flat-nosed pliers,  
parallel  
185 mm

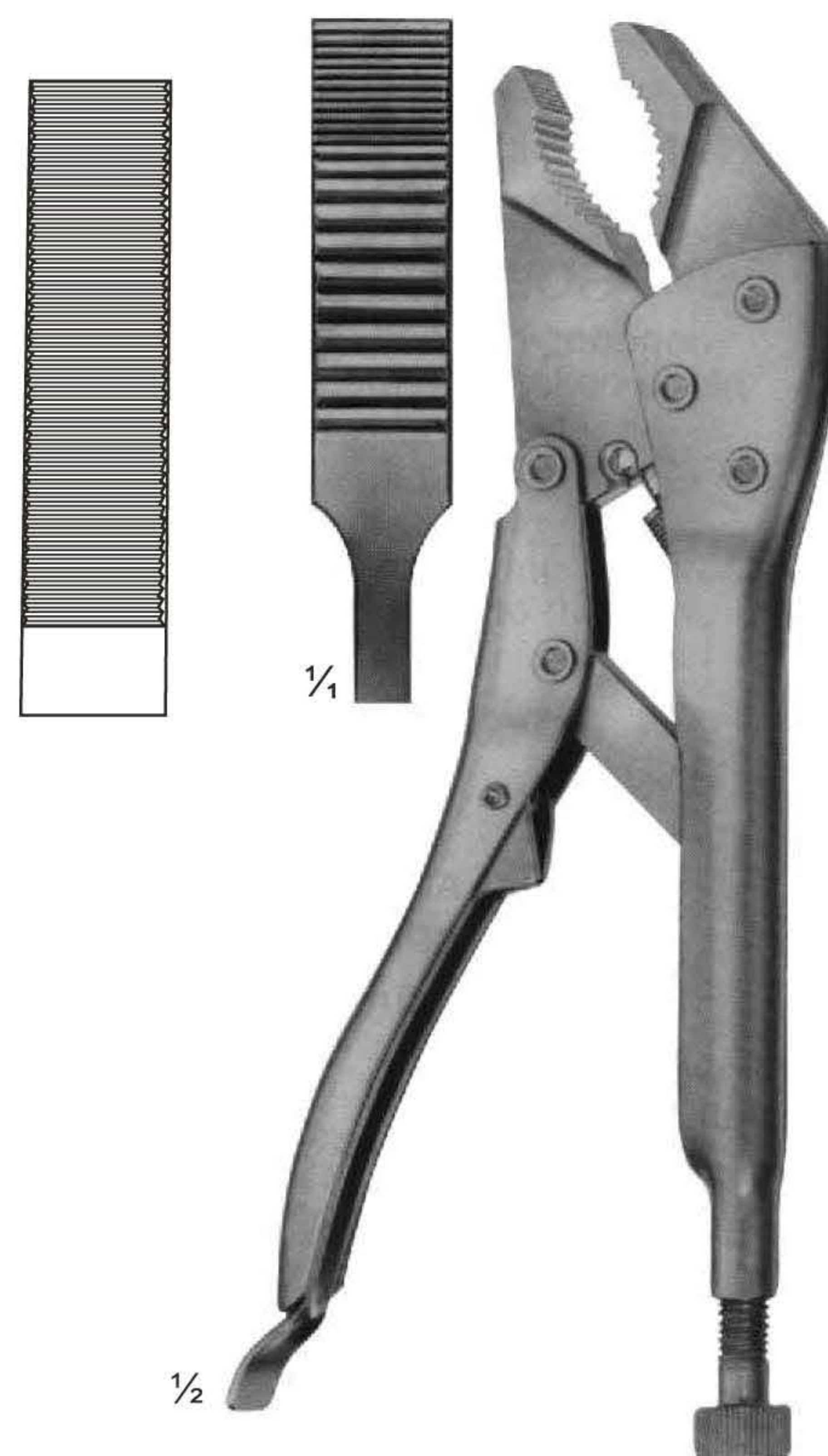

1/2

**UG-1819**  
Vise grip  
200 mm



1/2

**UG-1820**  
Round pliers  
180 mm

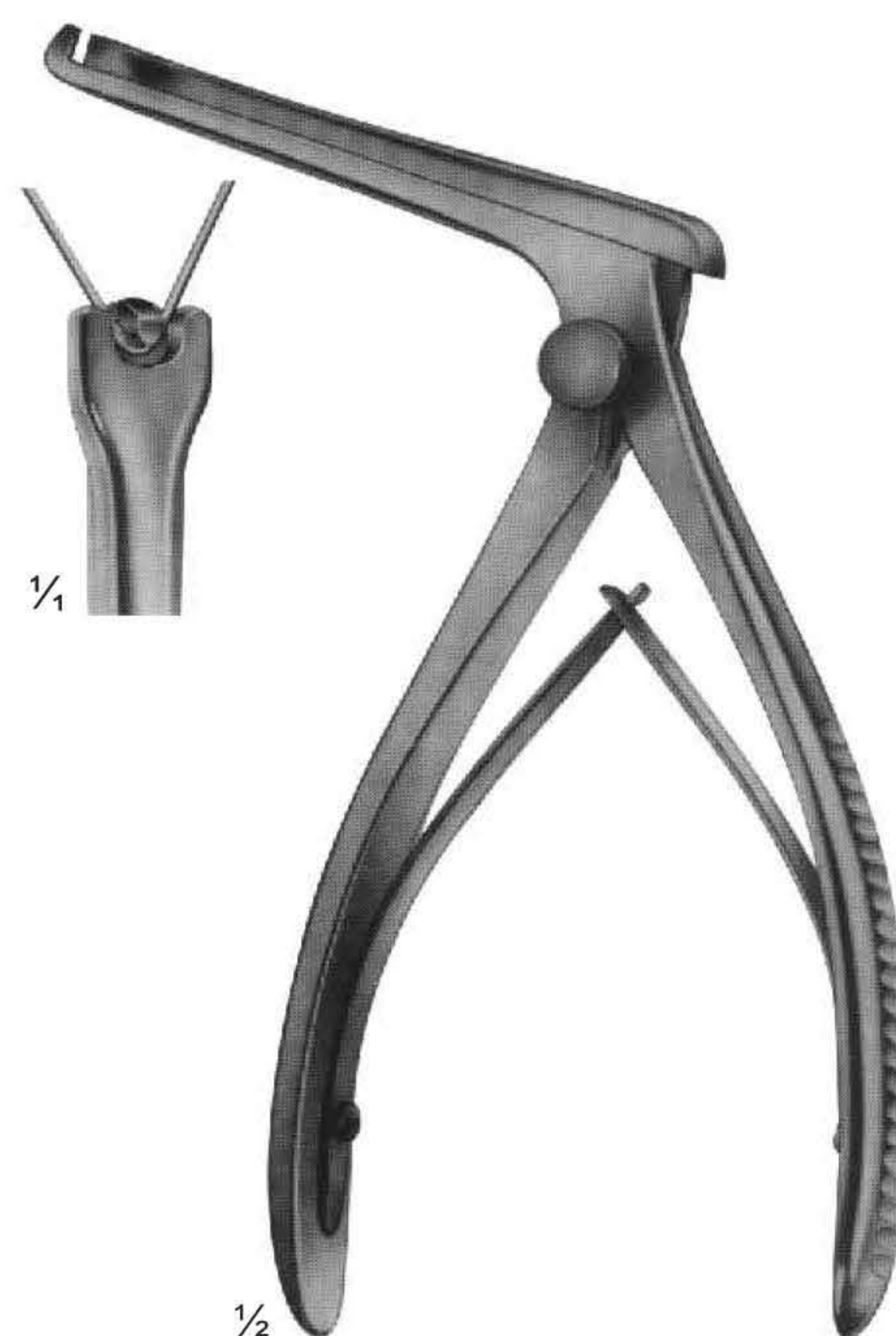

1/4

1/2

**UG-1821**  
Bending pliers  
for wires up to  
1.8 mm diam.



# Wire Cutters and wire Cutting Scissors



**UG-1823**  
ANGLE  
130 mm

for soft wire  
up to diam.  
for hard wire  
up to diam.

**UG-1825**  
DUROTIP  
ANGLE  
130 mm

0,5 mm 0,6 mm  
0,3 mm 0,4 mm

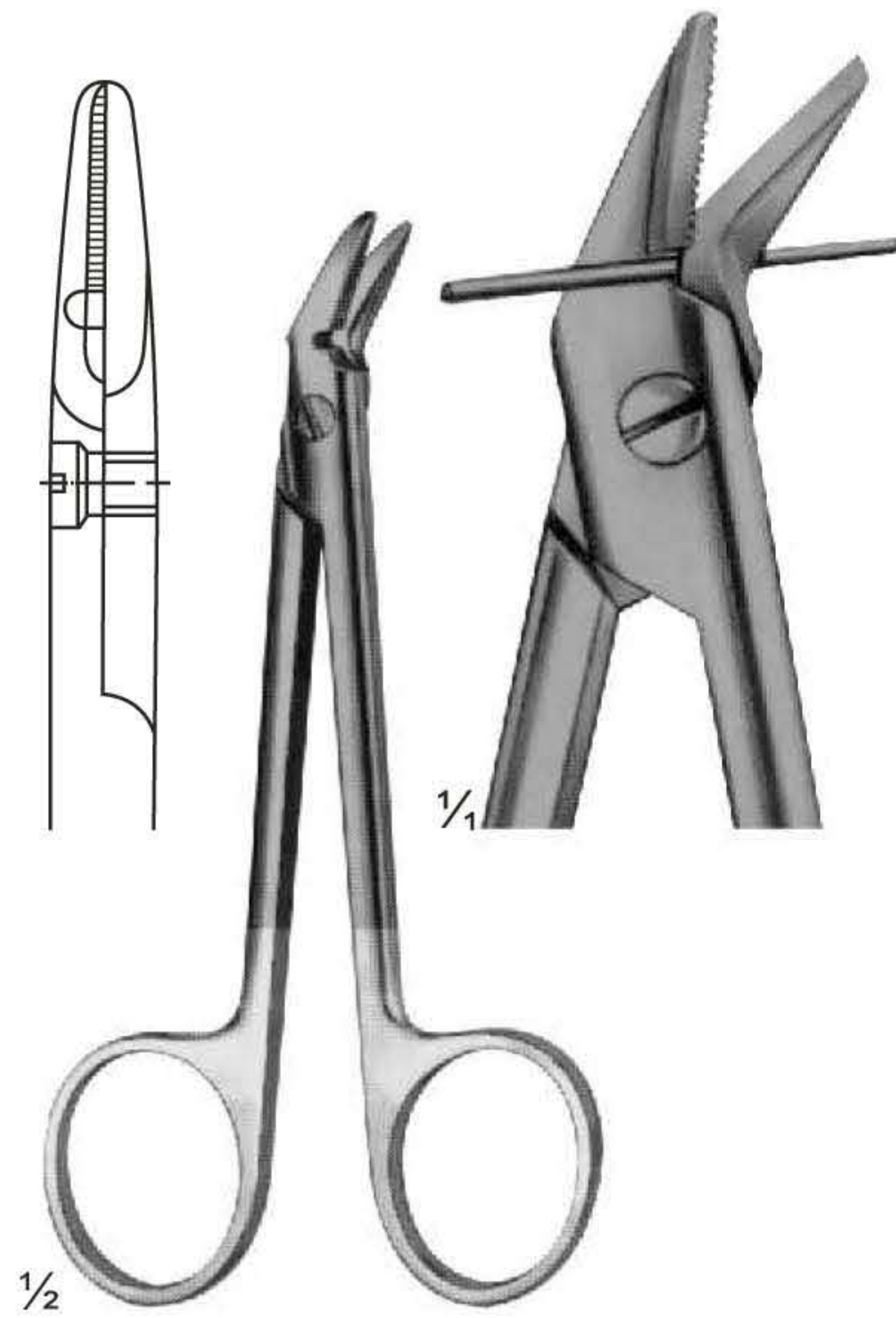

**UG-1826**  
120 mm

for soft wire  
up to diam.  
for hard wire  
up to diam.

**UG-1828**  
DUROTIP  
120 mm

1,2 mm 1,2 mm  
0,8 mm 0,8 mm

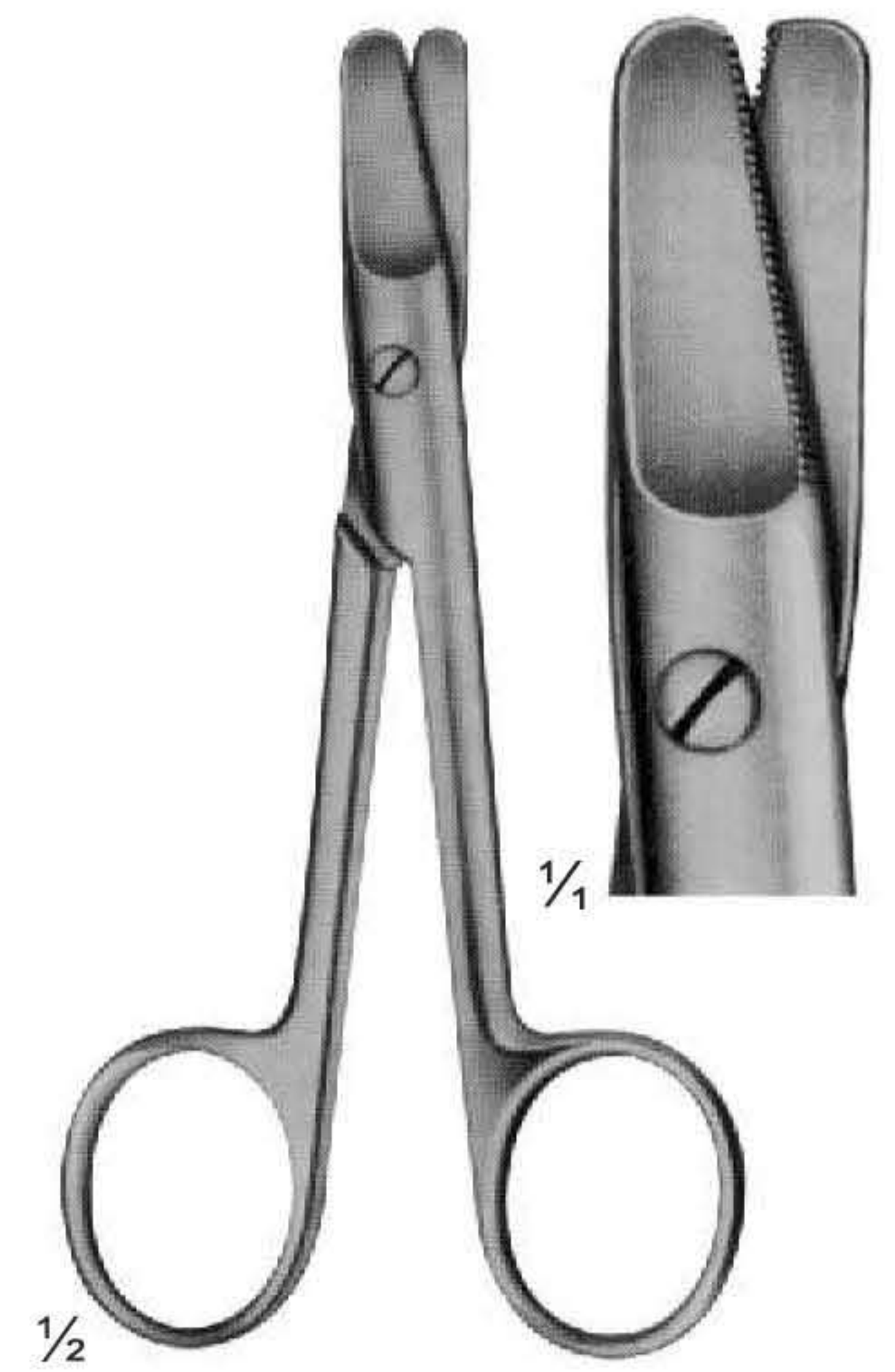

**UG-1829**  
HARVEY  
125 mm

0,4 mm  
0,3 mm

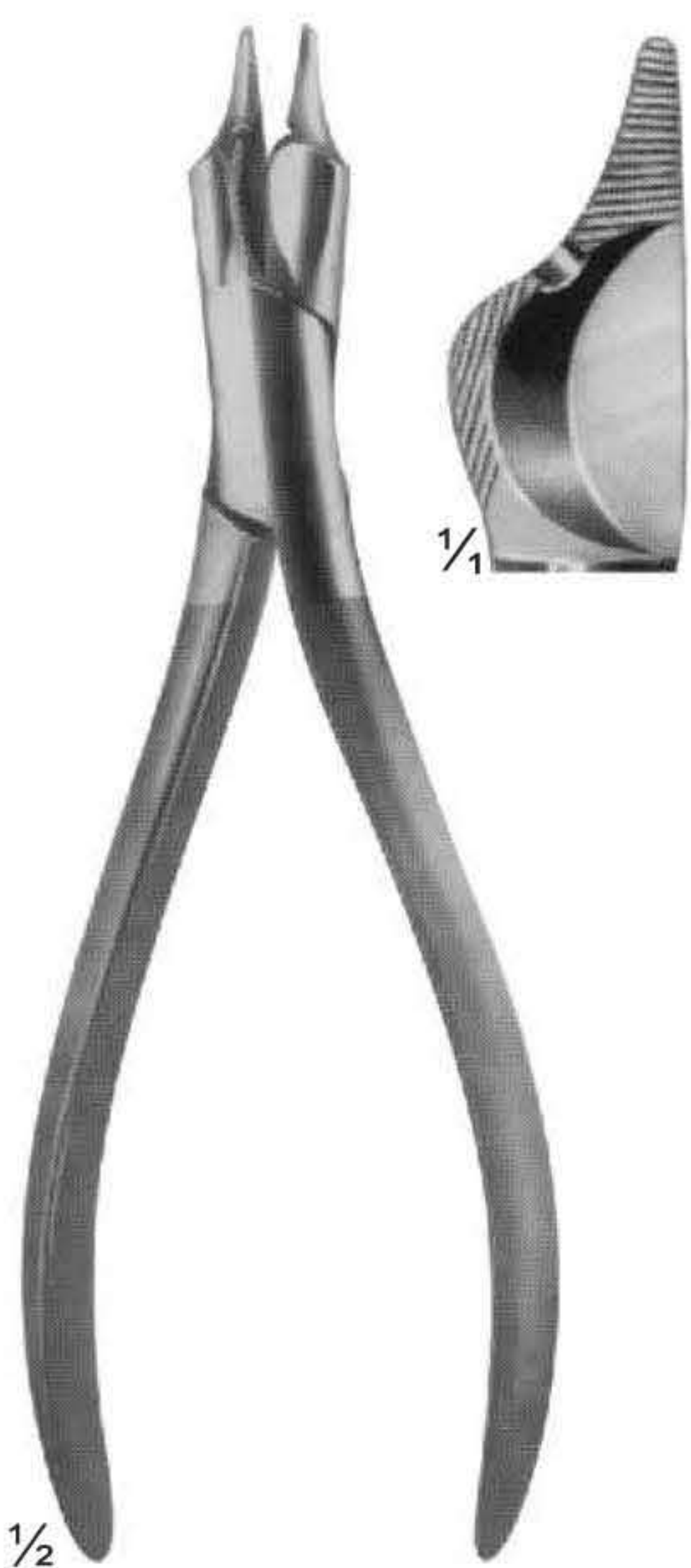

**UG-1830**  
150 mm

for soft wire  
up to diam.  
for hard wire  
up to diam.

1,5 mm  
1,0 mm



**UG-1831**  
160 mm

1,5 mm  
1,2 mm



**UG-1832**  
140 mm

1,5 mm  
1,0 mm

# Wire Cutting Pliers, Lateral Cutting Action

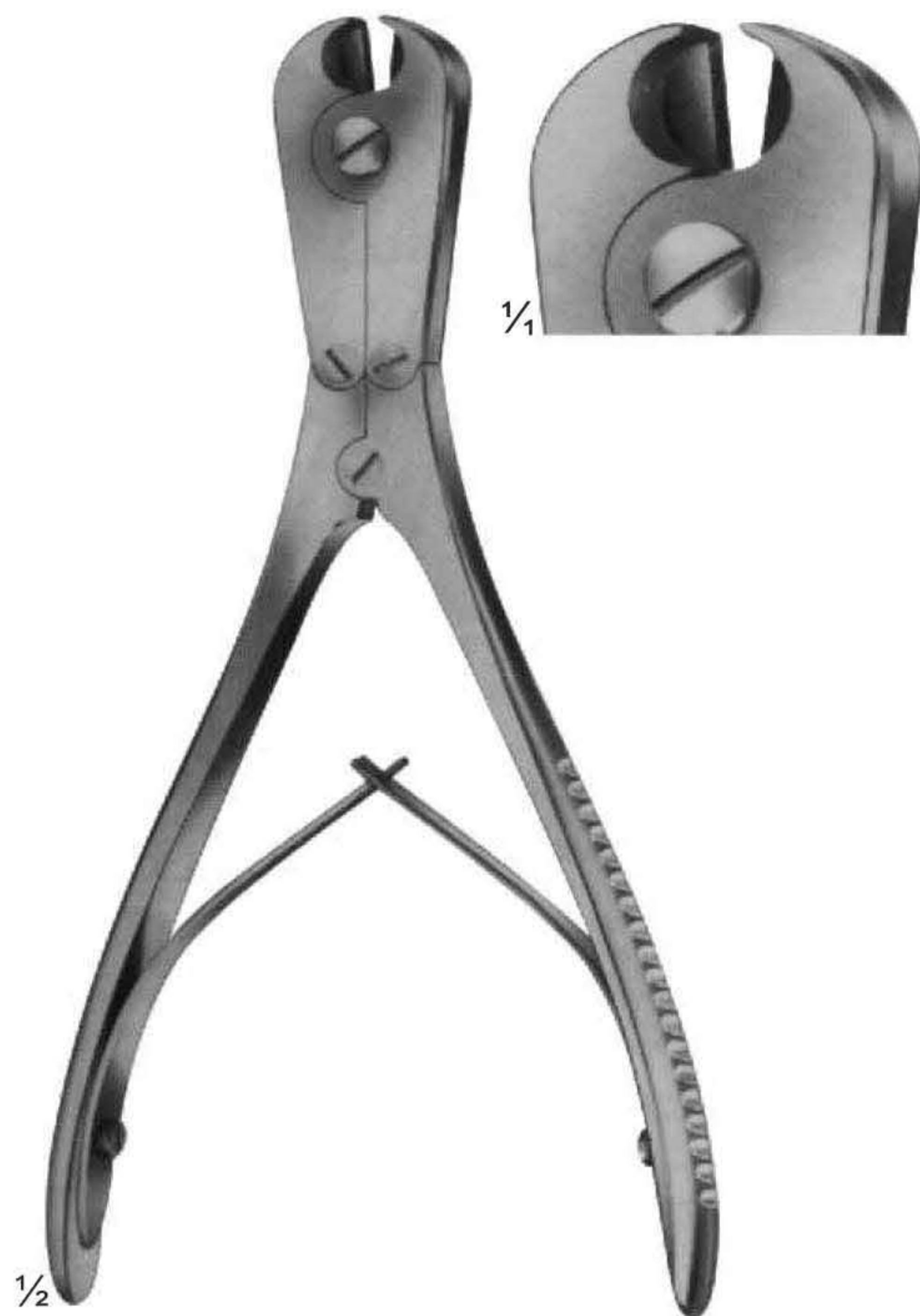

**UG-1833**  
180 mm

for soft wire  
up to diam. 2,0 mm  
For hard wire 1,5 mm  
up to diam  
specially hardened  
cutting edges, front  
and lateral cutting  
action



**UG-1834**  
REILL  
175 mm

for soft wire  
up to diam. 2,0 mm  
For hard wire 1,6 mm  
up to diam  
specially hardened  
cutting edges, for  
cutting off wires close  
to the bone



**UG-1835**  
235 mm

for soft wire  
up to diam. 3,0 mm  
For hard wire 2,2 mm  
up to diam

# Wire Cutting Pliers, Lateral and Front Cutting Action

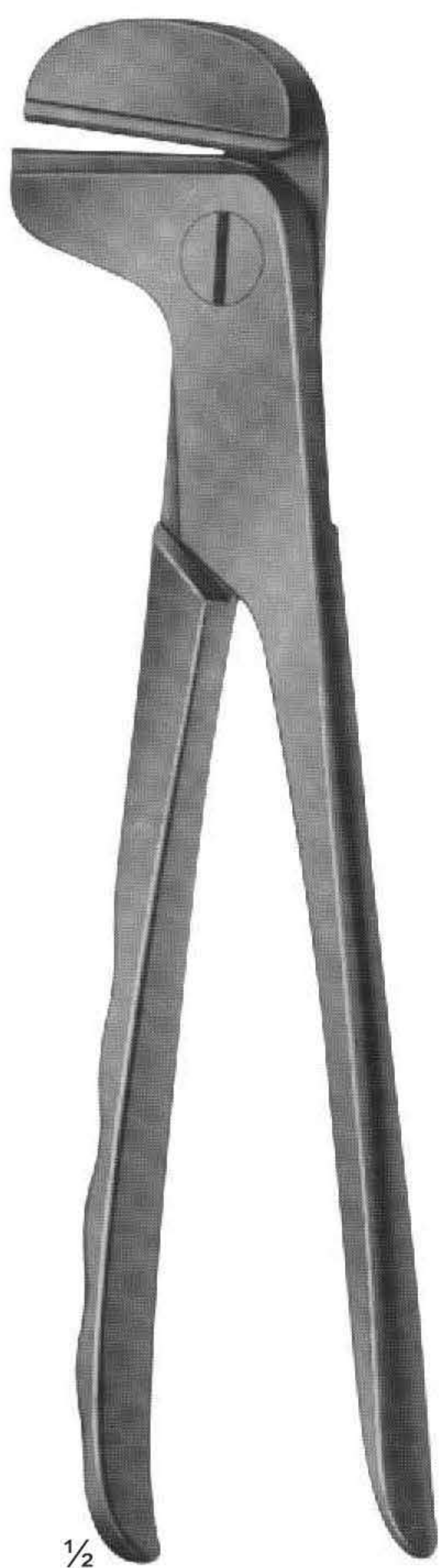

$\frac{1}{2}$   
**UG-1836**  
 240 mm

for soft wire  
 up to diam.  
 For hard wire  
 up to diam

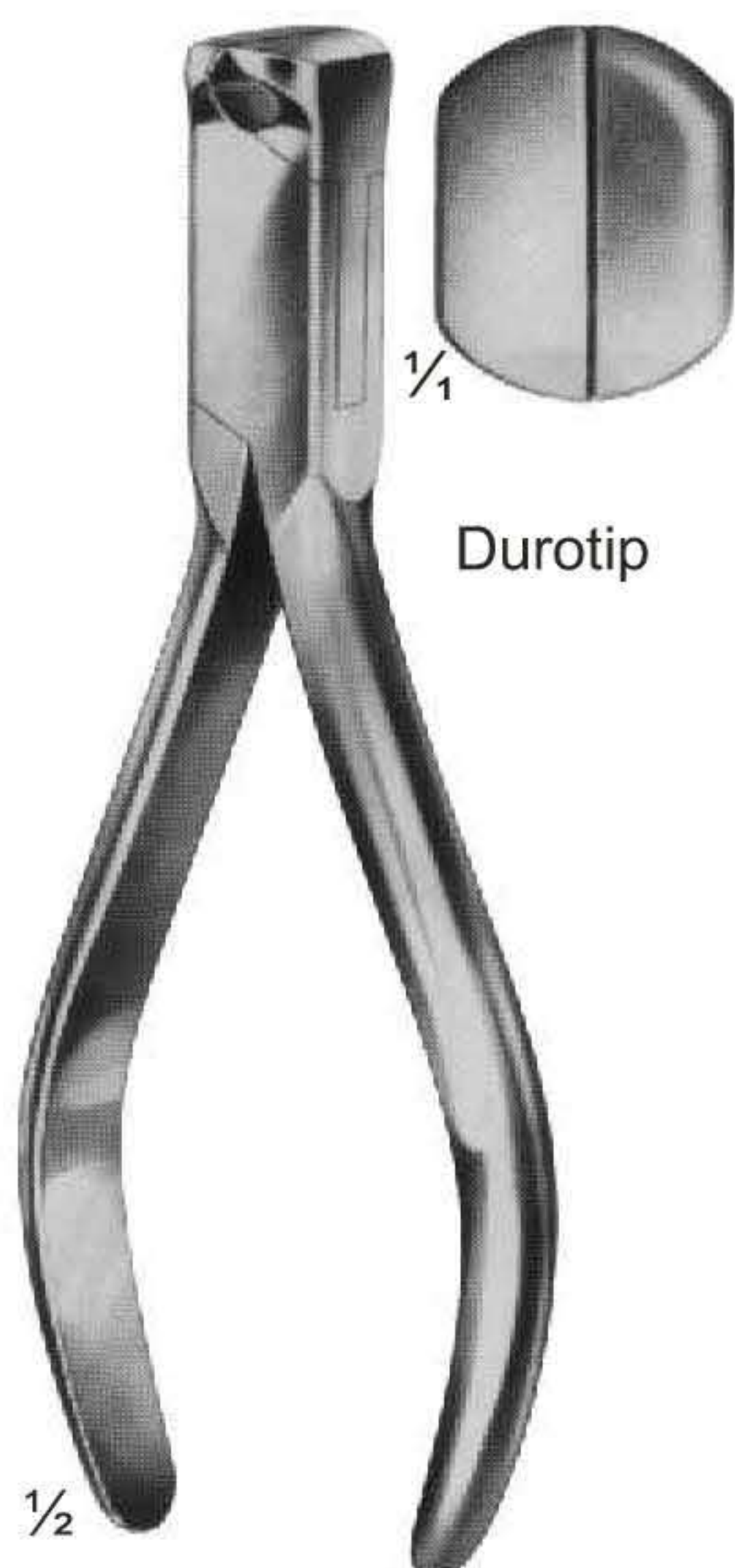

$\frac{1}{2}$   
**UG-1837**  
 140 mm

for soft wire  
 up to diam. 1,5 mm  
 For hard wire  
 up to diam 1,0 mm

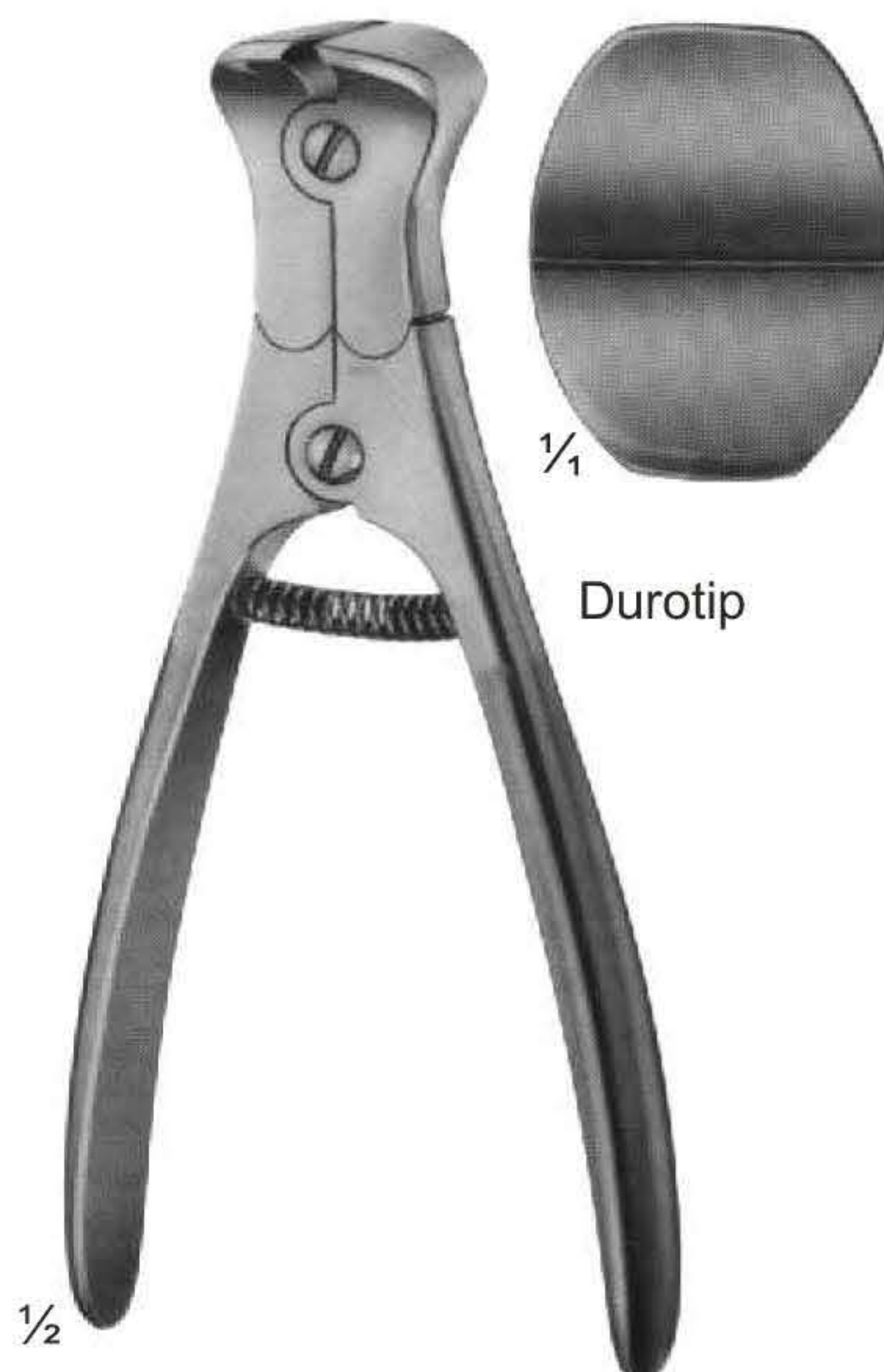

$\frac{1}{2}$   
**UG-1838**  
 145 mm

for soft wire  
 up to diam. 2,0 mm  
 For hard wire  
 up to diam 1,5 mm

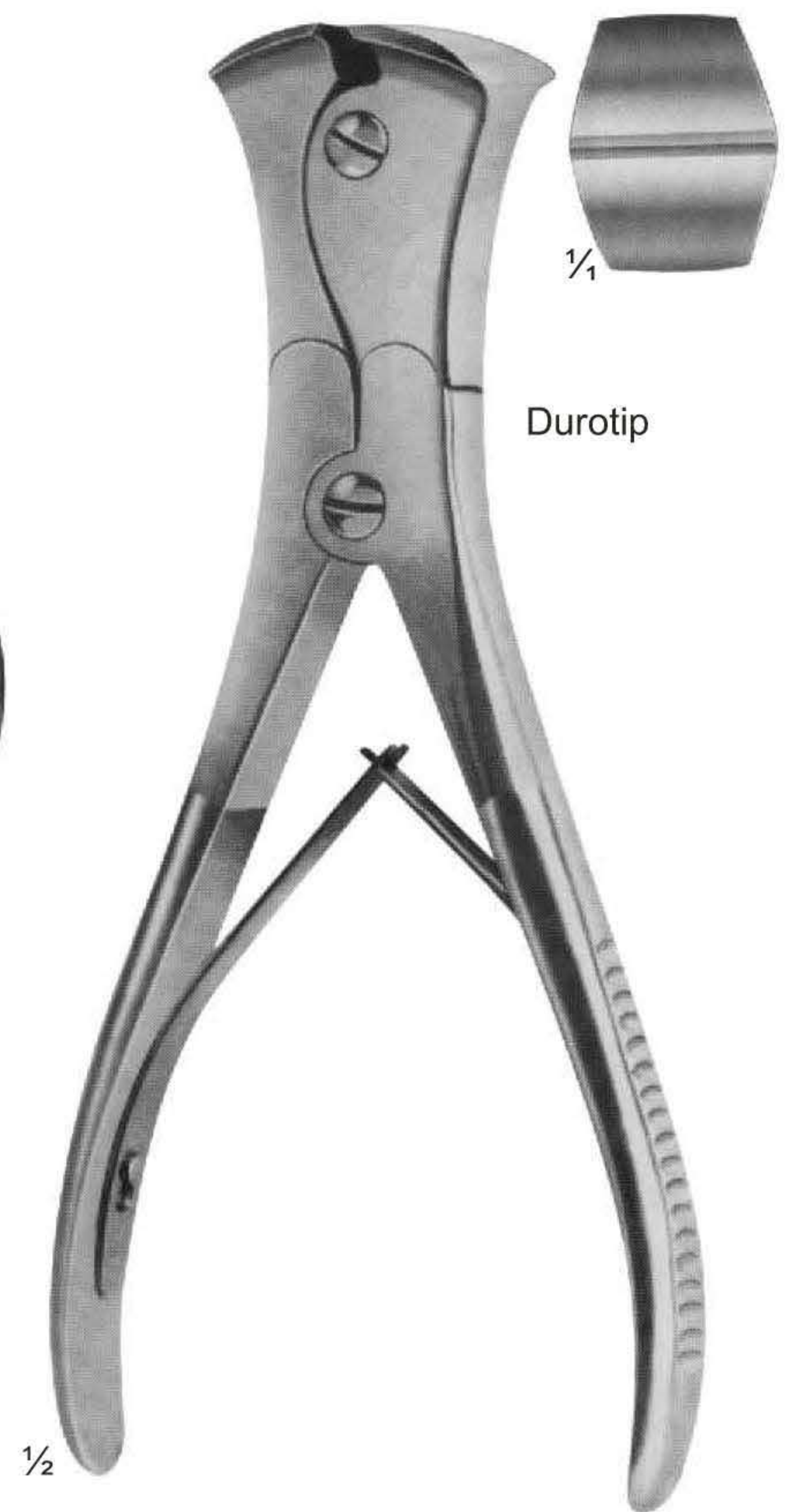

$\frac{1}{2}$   
**UG-1839**  
 220 mm

for soft wire  
 up to diam. 3,5 mm  
 For hard wire  
 up to diam 2,5 mm

# Wire Cutting Pliers



Cutter for cutting off  
KIRSCHNER wires,  
Tibia head screws,  
bolts, pins, up to 3 mm diam.

**UG-1840**  
320 mm

for soft wire up to diam. 3,0 mm  
For hard wire up to diam 3,0 mm



Durotip

**UG-1841**

Cutter for cutting off  
KIRSCHNER wires,  
Tibia head screws,  
bolts, pins, up to 6 mm diam.  
470 mm

# Finger Nail Instruments

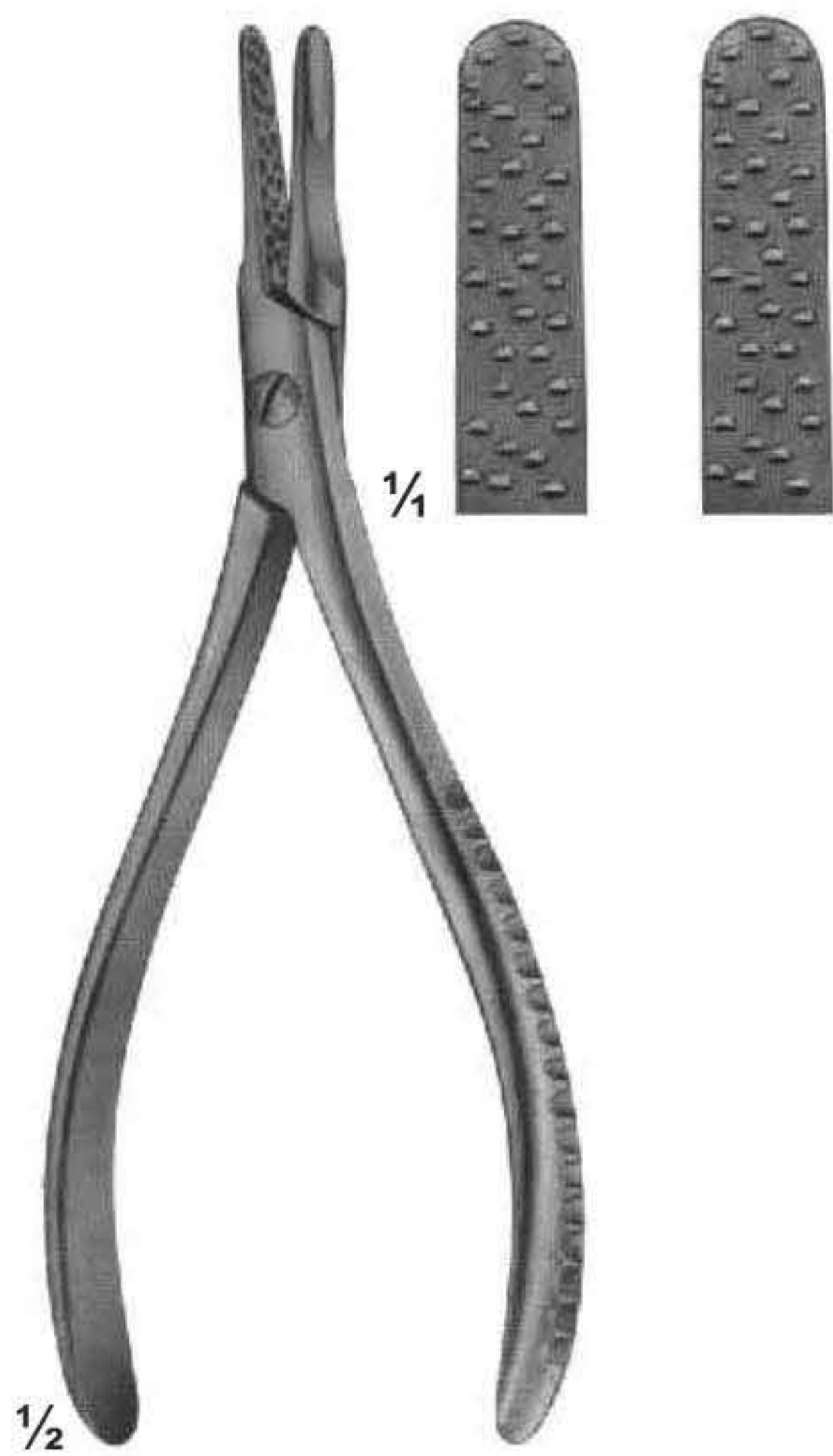

**UG-1846**  
Nail extracting  
forceps  
135 mm



**UG-1843**  
Nail extracting  
forceps  
145 mm



**UG-1846**  
Finger nail drill  
with 3 points

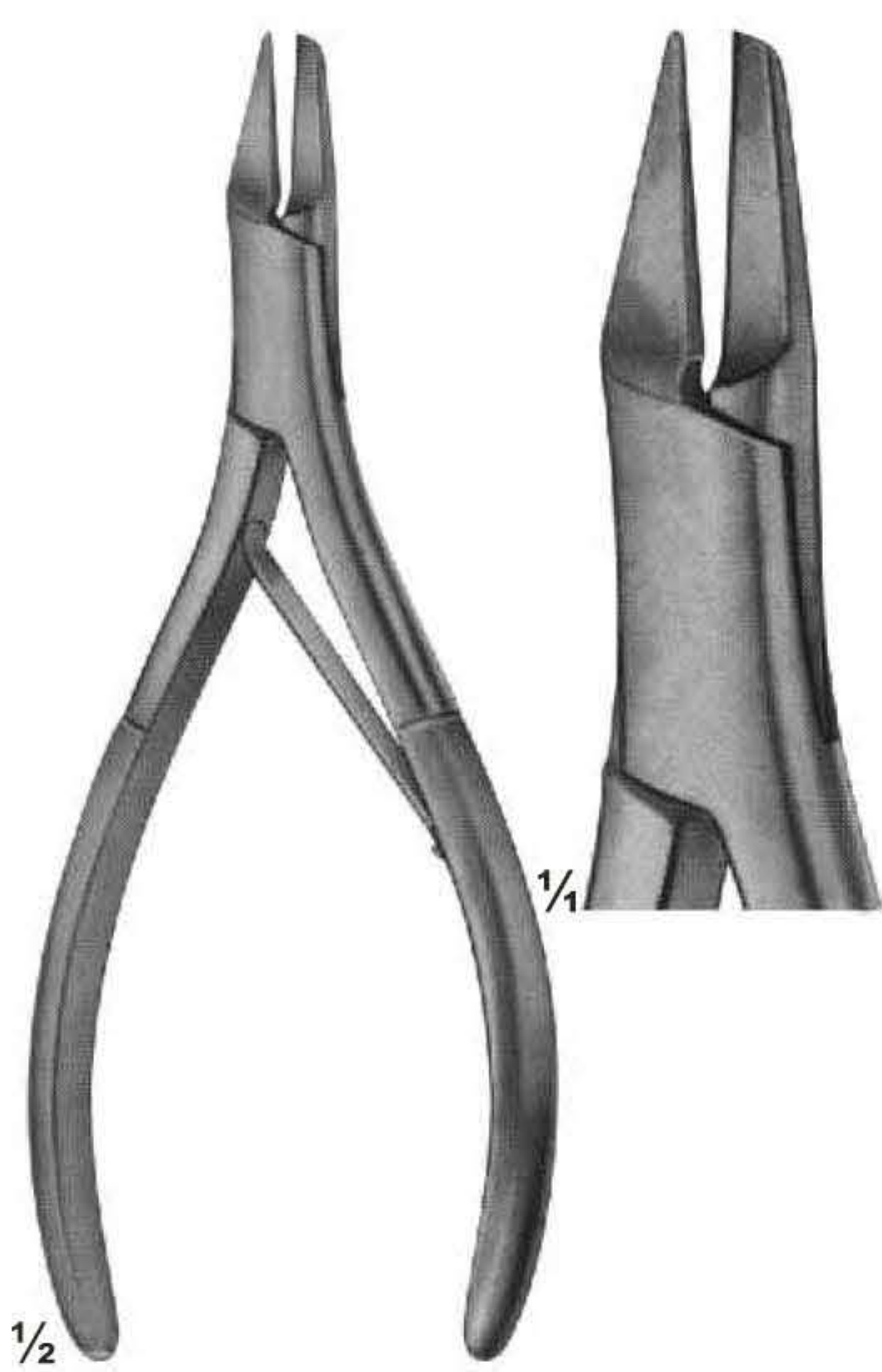

**UG-1845**  
Nail splitting  
forceps  
135 mm

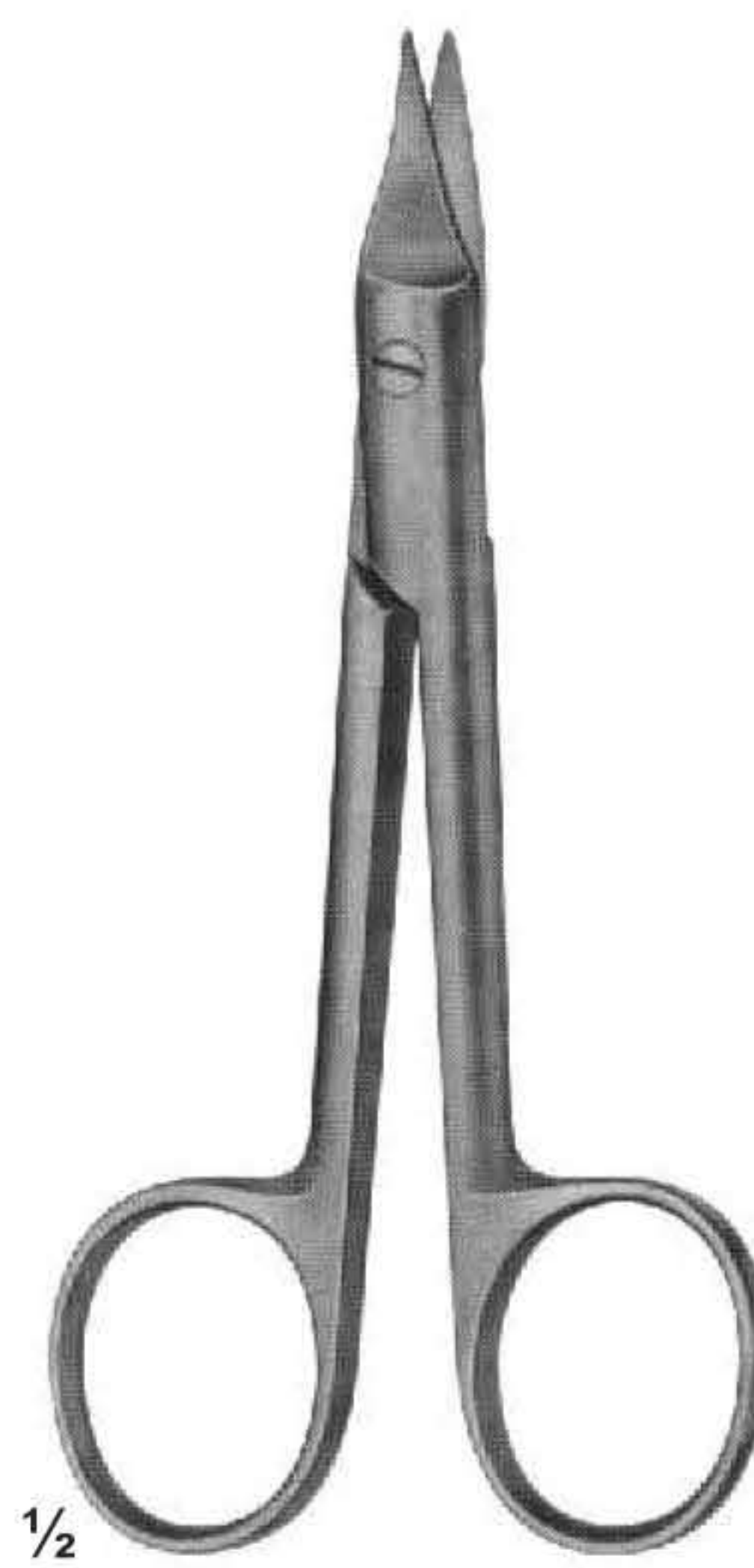

**UG-1846**  
SYSTRUNK  
Scissors, for splitting  
finger nails  
130 mm

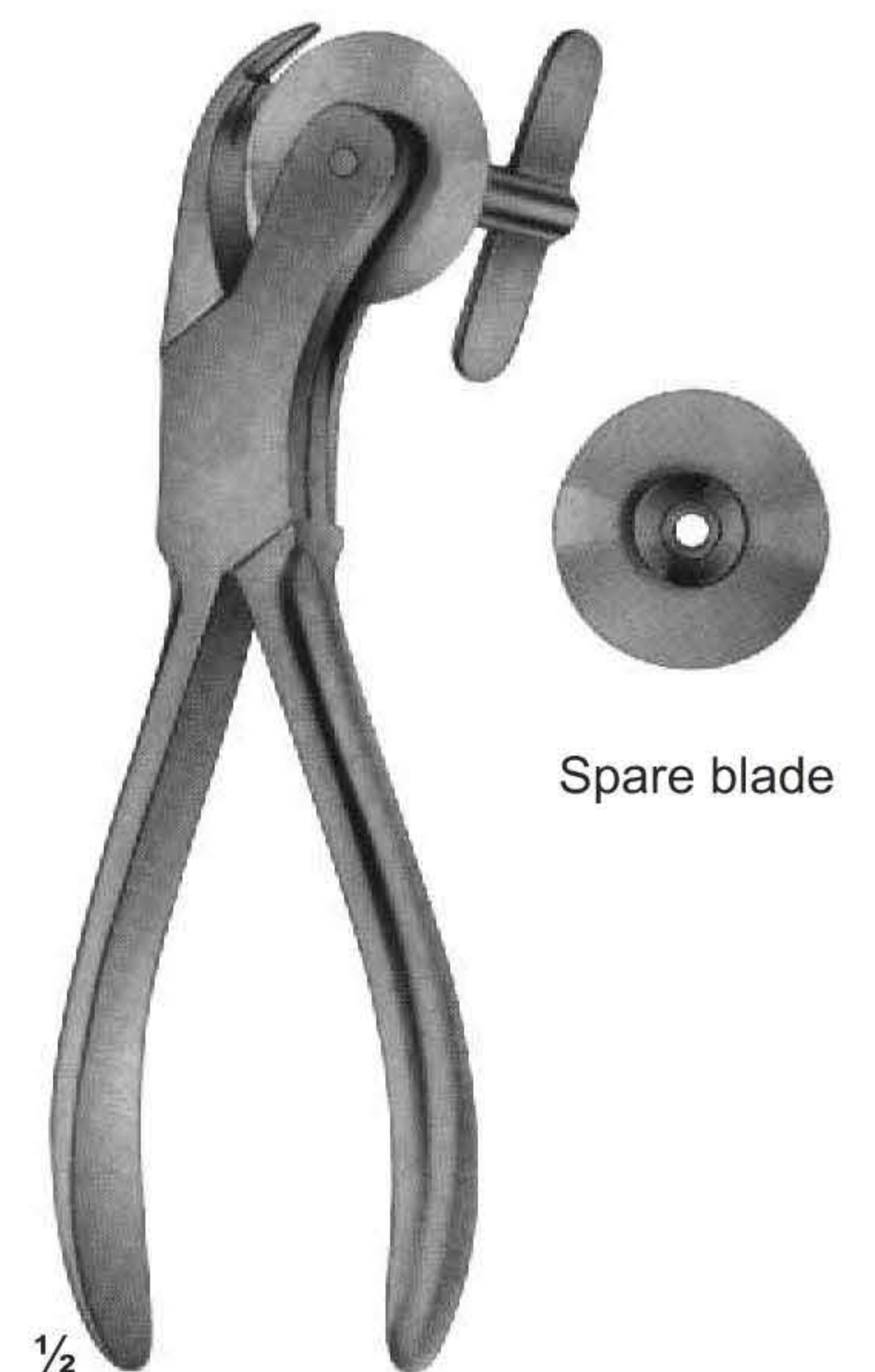

**UG-1847**  
Finger ring saw  
150 mm

# Plaster Instruments



with ebony handle

**UG-1865**  
HOPKINS  
200 mm



1/2

**UG-1866**  
ESMARCH  
180 mm



1/2

**UG-1867**  
ENGEL  
160 mm

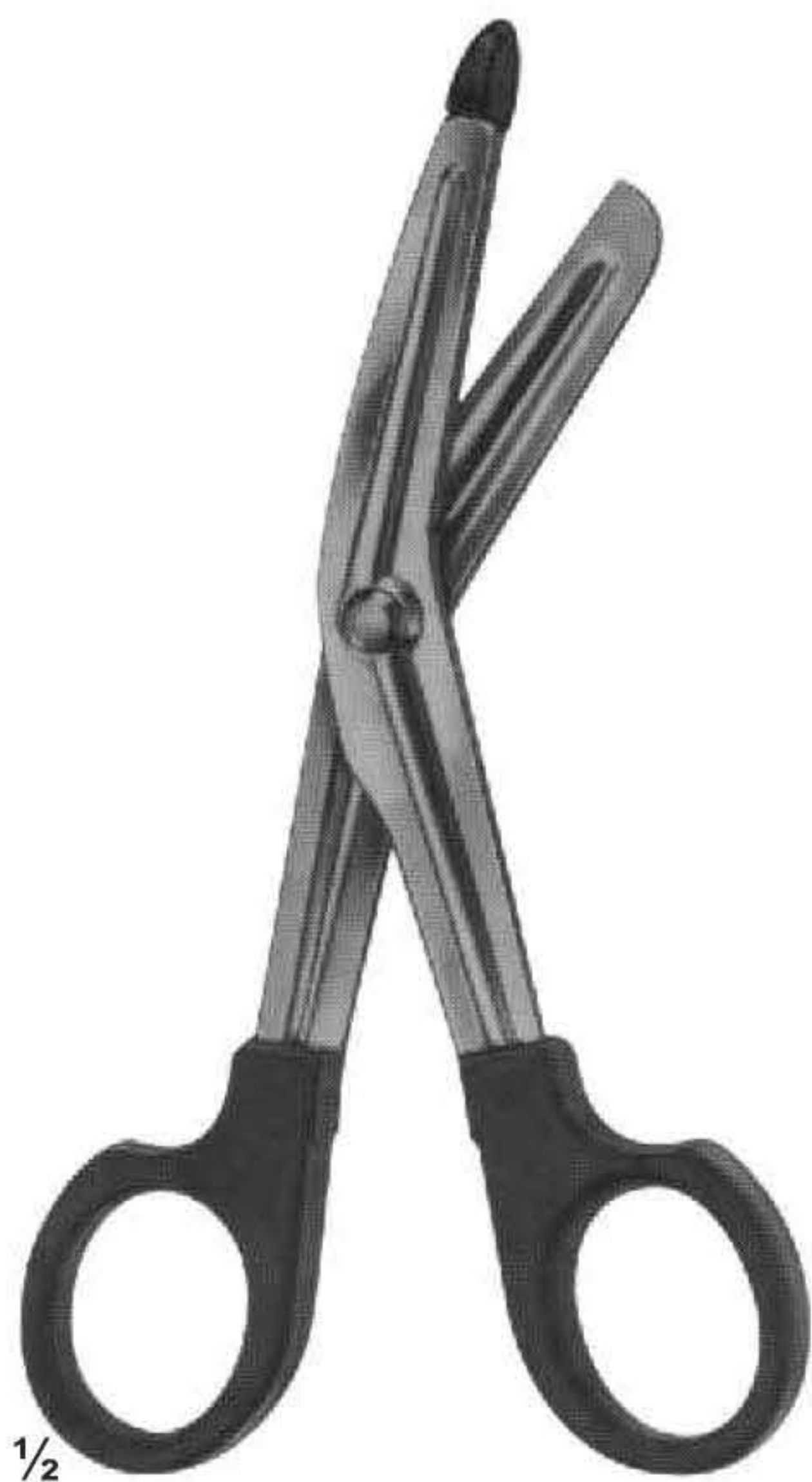

1/2

**UG-1868**



1/2

**UG-1871**

# Plaster Scissors

For small plaster dressings



**UG-1880**  
160 mm

1/2

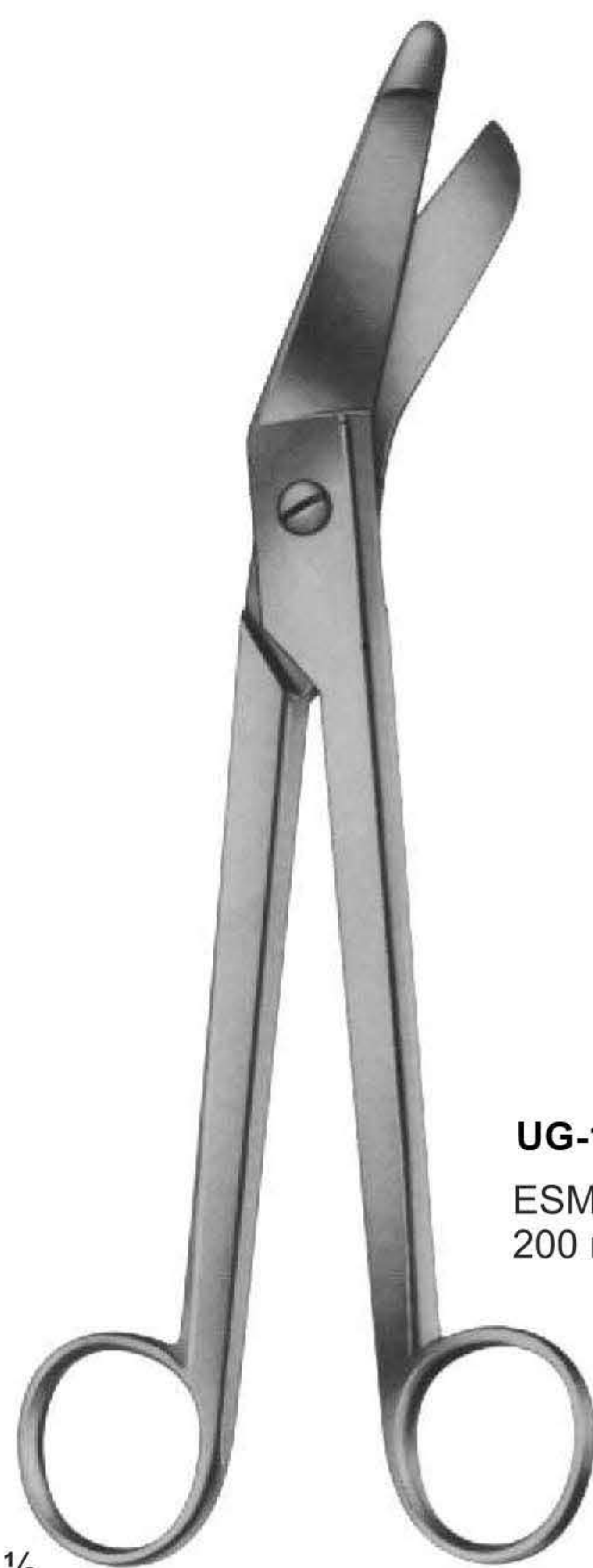

**UG-1883**  
ESMARCH  
200 mm 230 mm

1/2



**UG-1886**  
BERGMANN  
230 mm

1/2



**UG-1888**  
BRUNS  
235 mm

1/2



**UG-1889**  
235 mm

1/2

also to be used as  
bandage scissors



**UG-1891**  
SEUTIN  
230 mm

1/2

also to be used as  
bandage scissors

# Plaster Shears



**UG-1894**  
STILLE-AESULAP  
260 mm



**UG-1896**  
STILLE-AESULAP  
360 mm



# STILLE Plaster Shears

Blade with reinforced back



**UG-1898**  
STILLE  
230 mm

**UG-1899**  
Spare blade



**UG-1901**  
STILLE  
370 mm

**UG-1902**  
Spare blade



**UG-1904**  
STILLE  
240 mm

**UG-1905**  
Spare blade

# Plaster Spreader, Plaster Breakers



**UG-1910**  
HENING  
270 mm



**UG-1911**  
MOD.USA  
230 mm



**UG-1912**  
290 mm



with removable jaws



**UG-1914**  
WOLFF  
180 mm  
240 mm

# Vacuum Currettes for Aspiration Lipectomy, Suction Instruments

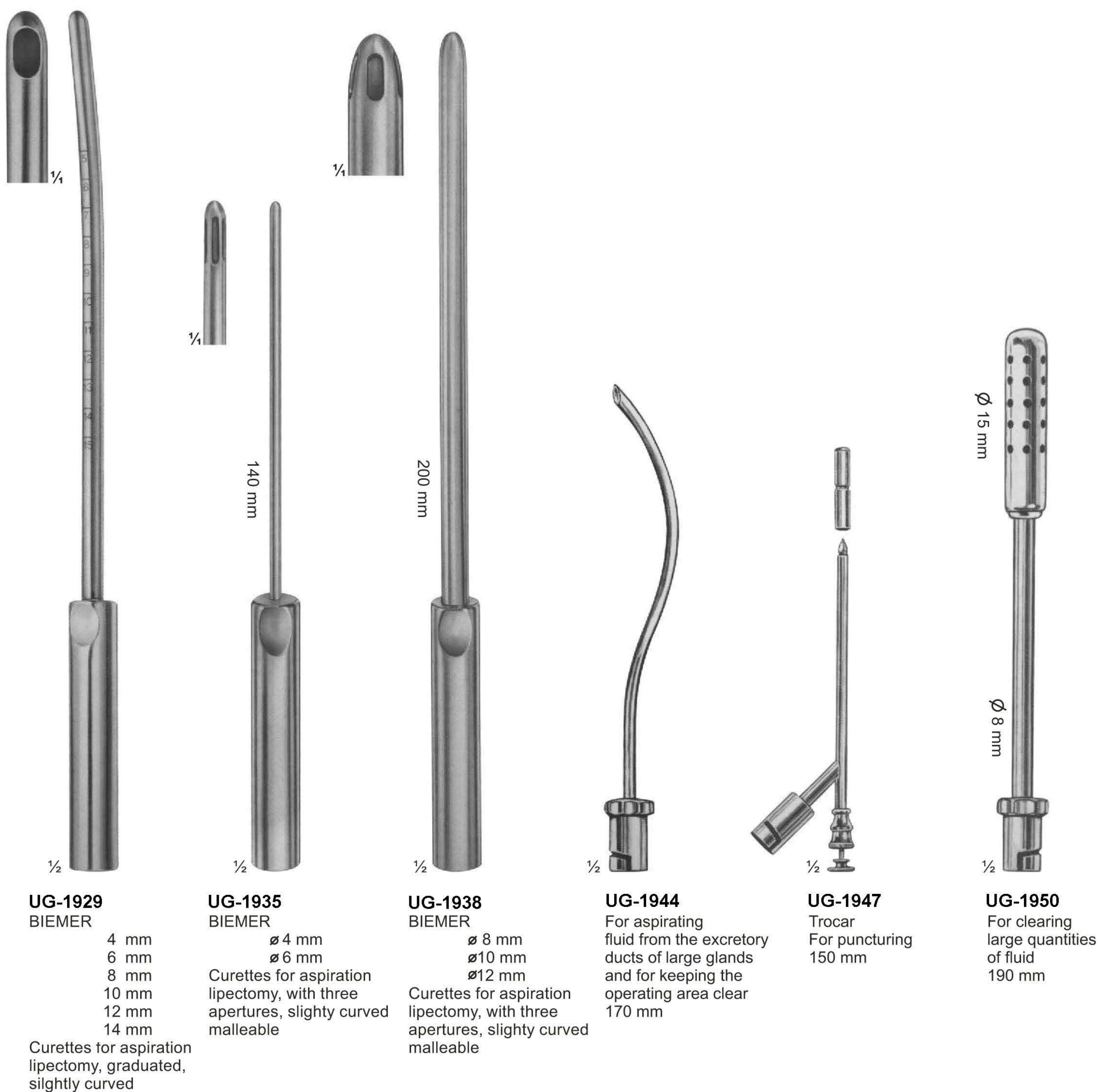

**UG-1929**  
BIEMER

4 mm  
6 mm  
8 mm  
10 mm  
12 mm  
14 mm

Curettes for aspiration lipectomy, graduated, slightly curved

**UG-1935**  
BIEMER

ø 4 mm  
ø 6 mm  
Curettes for aspiration lipectomy, with three apertures, slightly curved malleable

**UG-1938**  
BIEMER

ø 8 mm  
ø 10 mm  
ø 12 mm  
Curettes for aspiration lipectomy, with three apertures, slightly curved malleable

**UG-1944**

For aspirating fluid from the excretory ducts of large glands and for keeping the operating area clear  
170 mm

**UG-1947**

Trocar  
For puncturing  
150 mm

**UG-1950**

For clearing large quantities of fluid  
190 mm

# Suction Instruments



**UG-1955**  
Trocar  
For puncturing  
170 mm



**UG-1958**  
Hollow needle,  
sharp  
150 mm



**UG-1961**  
double curved  
For general  
surgery  
230 mm



**UG-1962**  
For tonsillectomy,  
oral and laryngeal  
operations  
190 mm



**UG-1963**  
For tonsillectomy,  
oral and laryngeal  
operations  
220 mm

# Suction Instruments

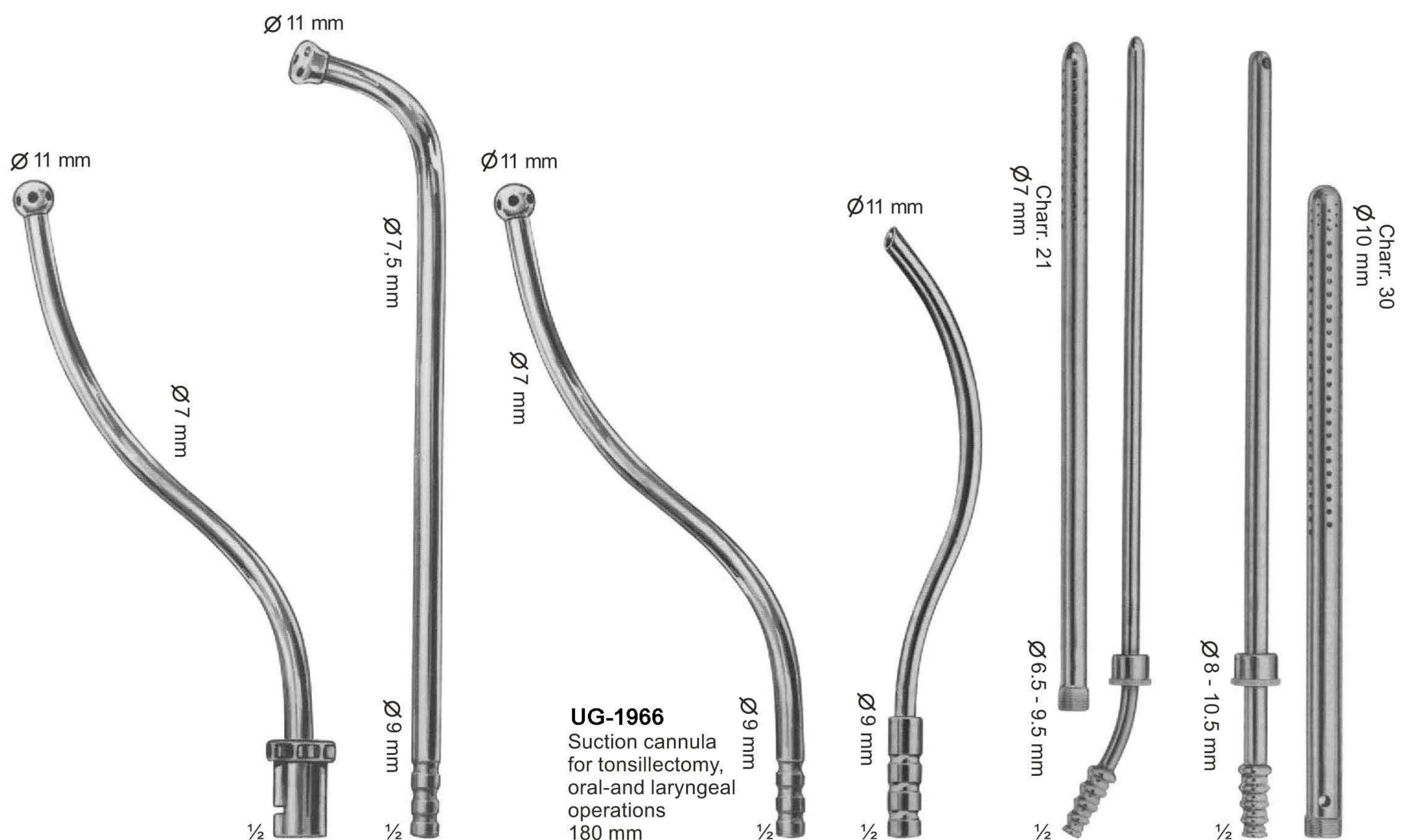

**UG-1964**  
For tonsillectomy,  
oral-and laryngeal  
operations  
180 mm

**UG-1965**  
Suction cannula  
for tonsillectomy,  
oral-and laryngeal  
operations  
220 mm

**UG-1966**  
Suction cannula  
for tonsillectomy,  
oral-and laryngeal  
operations  
180 mm

**UG-1967**  
S-shaped blunt cannula  
for aspirating fluid from  
the excretory ducts of  
large glands and for  
keeping the operations  
area clear  
170 mm

**UG-1968**  
POOL  
Suction cannula,  
with outer tube  
to be screwed of  
225 mm

**UG-1970**  
POOL  
Suction cannula,  
with outer tube  
to be screwed of  
225 mm

# Suction Instruments

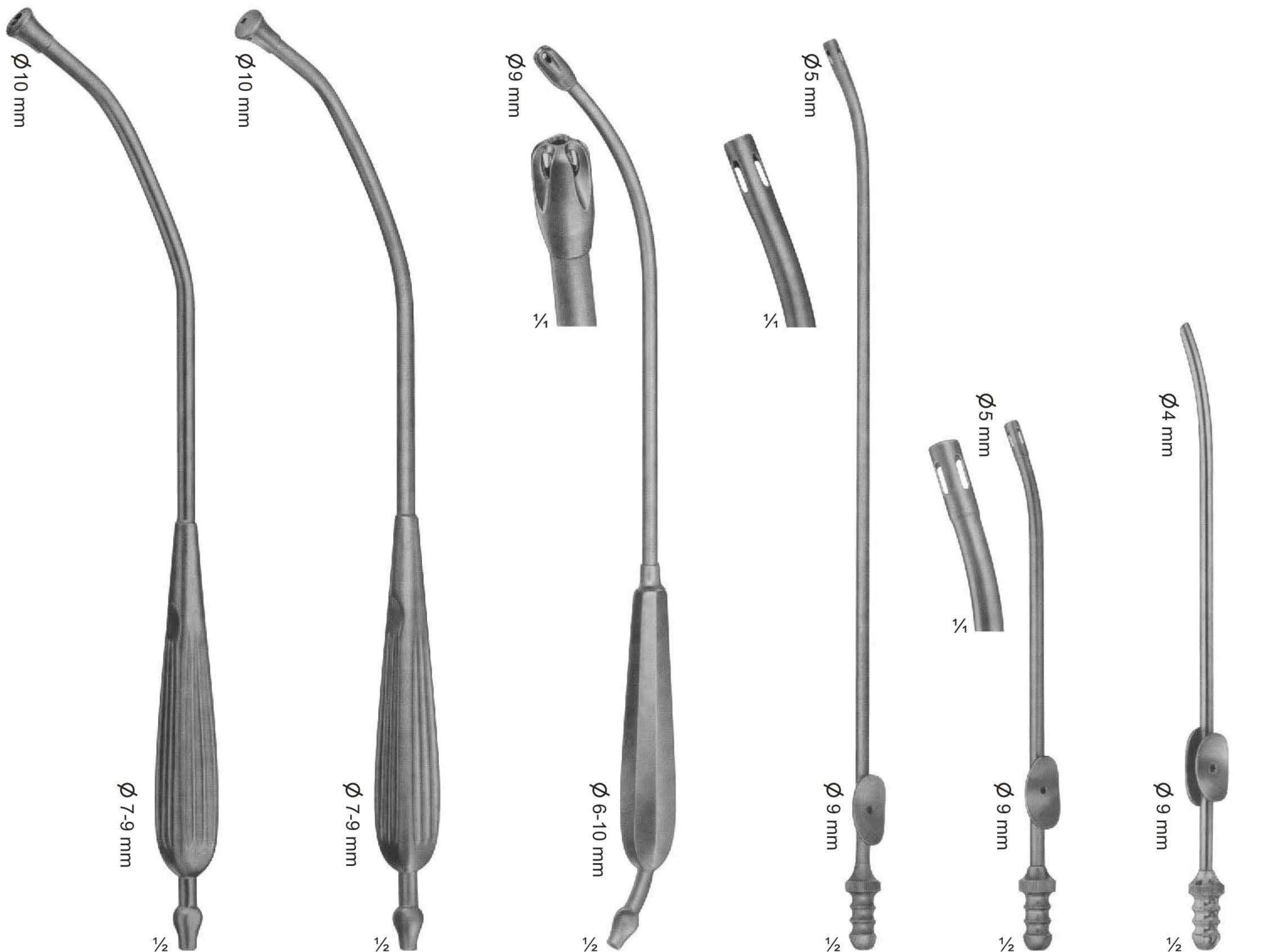

**UG-1971**  
YANKAUER  
with especially large  
central bore, 4,8 mm  
diam.  
285 mm

**UG-1972**  
YANKAUER  
with central bore,  
2,0 mm diam.  
285 mm

**UG-1973**  
DE-BAKEY  
with central bore,  
3,0 mm diam. with  
lateral slots  
275 mm

**UG-1975**  
DE-BAKEY  
with finger cut-off  
and stylet  
270 mm

**UG-1977**  
DE-BAKEY  
with finger cut-off  
and stylet  
160 mm

**UG-1976**  
with finger  
cut-off  
190 mm

# Suction Instruments



**UG-1984**  
PLESTER  
with finger cut-off and  
stylet, thumb piece  
parallel to curved, with  
LUER hub  
195 mm



**UG-1989**  
FERGUSSON  
with finger cut-off and  
stylet, thumb piece  
90° to curved, with  
LUER hub  
180 mm



**UG-1991** ∅ 4,0 mm  
FERGUSSON  
insulated, with finger cut-off  
and stylet, thumb piece 90°  
to curved, with LUER hub  
180 mm



**UG-1992** ∅ 3,0 mm  
∅ 5,0 mm  
FRAZIER  
insulated, with finger  
cut-off and stylet, thumb  
piece 90° to curved,  
with LUER hub  
180 mm

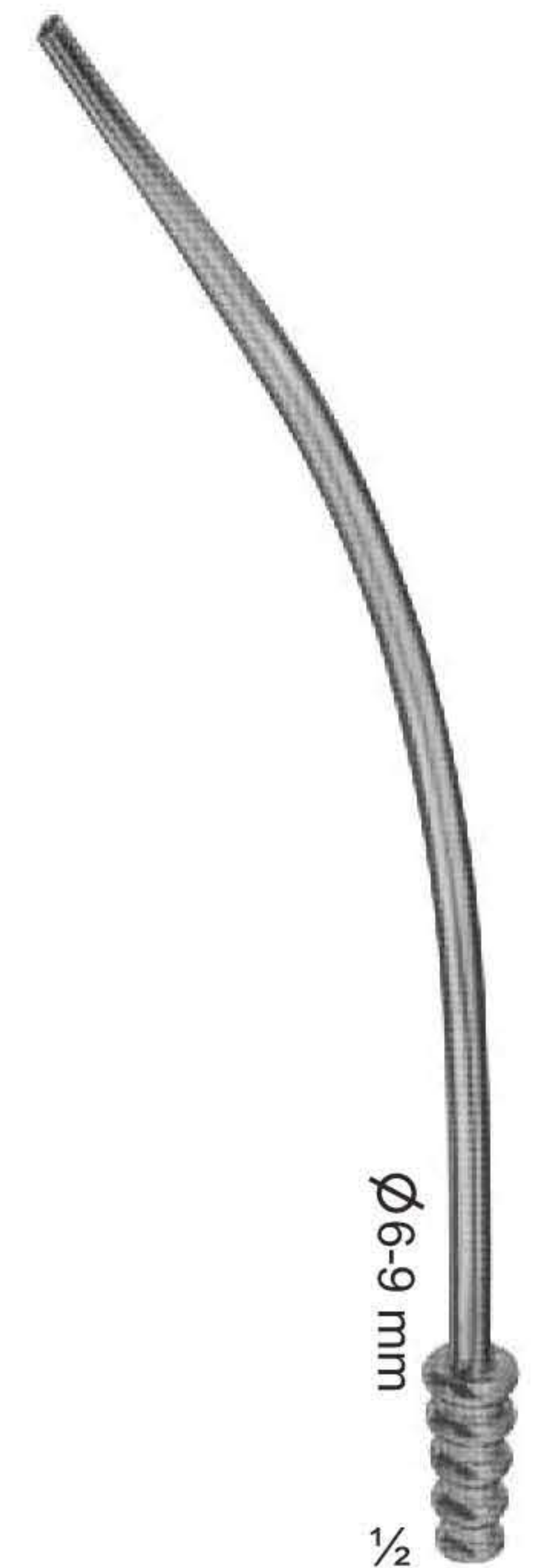

**UG-1994**  
5,0 mm diam., Tip  
6,5 mm wide, Nasal  
suction tube, with  
LUER hub  
180 mm



**UG-1995** ∅ 4,5 mm  
∅ 5,5 mm  
Nasal suction  
tubes  
175 mm



**UG-1999**  
GORNEY  
Suction dissector  
180 mm



4 mm wide  
**UG-20015** 15 mm wide  
Suction raspatories,  
sharp, bayonet-shaped,  
with stylet  
200 mm



**UG-2002**  
LOPEZ-REINKE  
Tonsil dissector with  
suction device  
235 mm

# Suction Instruments

**UG-2003**  
WULLSTEIN  
Suction tube, conical, silver, oliver  
with LUER hub  
160 mm

$\varnothing 1,75$  mm

$\varnothing 3$  mm  
 $\frac{1}{2}$   
 $\varnothing 8$  mm

**UG-2004**  
WULLSTEIN  
Suction tube, cylindrical, silver, with  
stylet with LUER hub  
160 mm

1,5 mm  
2,0 mm

$\frac{1}{2}$   
 $\varnothing 8$  mm

Usable length

YASARGIL usable length diam.		YASARGIL usable length diam.	
<b>UG-2005</b>	130 mm 1,5 mm	<b>UG-2013</b>	130 mm 2,5 mm
<b>UG-2006</b>	150 mm 1,5 mm	<b>UG-2014</b>	150 mm 2,5 mm
<b>UG-2007</b>	180 mm 1,5 mm	<b>UG-2015</b>	180 mm 2,5 mm
<b>UG-2008</b>	220 mm 1,5 mm	<b>UG-2016</b>	220 mm 2,5 mm
<b>UG-2009</b>	130 mm 2,0 mm	<b>UG-2017</b>	130 mm 3,5 mm
<b>UG-2010</b>	150 mm 2,0 mm	<b>UG-2018</b>	150 mm 3,5 mm
<b>UG-2011</b>	180 mm 2,0 mm	<b>UG-2019</b>	180 mm 3,5 mm
<b>UG-2012</b>	220 mm 2,0 mm	<b>UG-2020</b>	220 mm 3,5 mm
		<b>UG-2021</b>	180 mm 4,5 mm

$\varnothing 6,5-9$  mm  
with LUER hub

**UG-2022**  
LANDOLT  
150 MM  
diam  $\varnothing 3$  mm

8 mm / curved  
11mm / curved  
15mm / curved

$\frac{1}{2}$   
 $\frac{1}{2}$

$\varnothing 3.5$  mm

$\varnothing 2.0$  mm

**UG-2023** 500 mm  
**UG-2024** 350 mm  
with rubber tip,  
with LUER hub

$\varnothing 9$  mm  
 $\frac{1}{2}$

**UG-2025** 2,0 mm diam  
**UG-2026** 2,5 mm diam  
**UG-2027** 3,0 mm diam  
with finger cut-off,  
thumb piece  $90^\circ$  to  
curved, with LUER hub  
250 mm

$\varnothing 6-9$  mm  
 $\frac{1}{2}$



# Combined Suction and Irrigation Cannulae



**UG-1947**  
FINSTERER  
320 mm

Ø9-13 mm 1/2

Ø15 mm



Ø 2 mm

Ø 4,5 mm

**UG-1974**  
YASARGIL  
LURE-LOCK cone  
200 mm

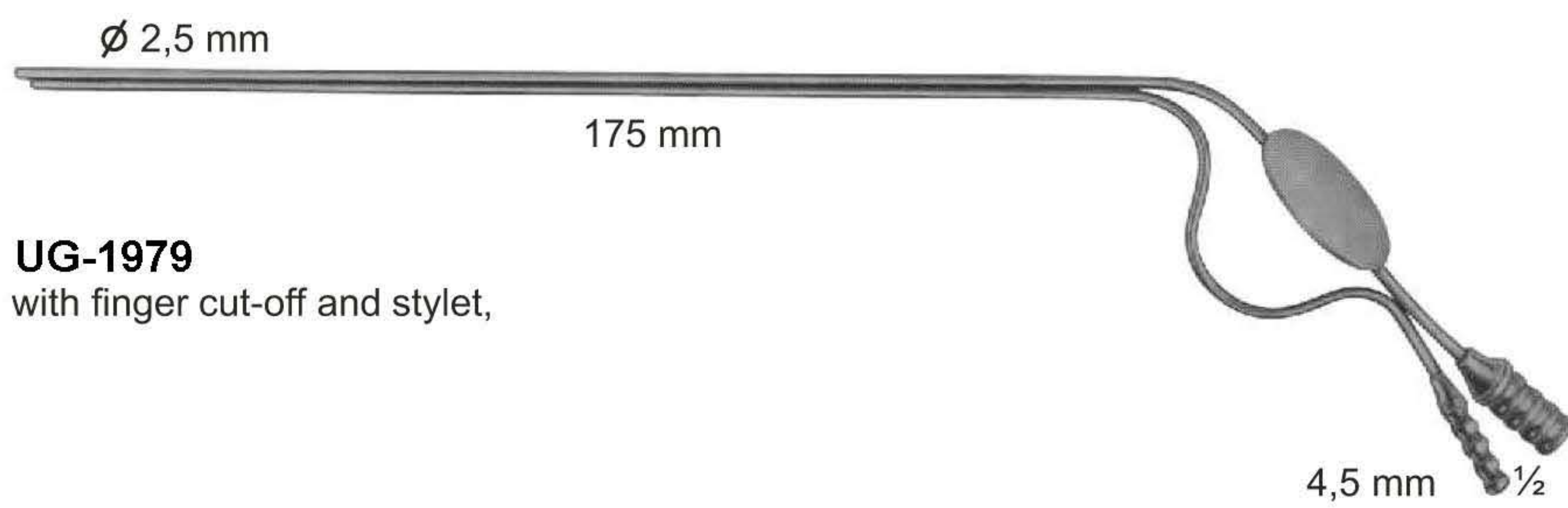

Ø 2,5 mm

175 mm

**UG-1979**  
with finger cut-off and stylet,

4,5 mm 1/2

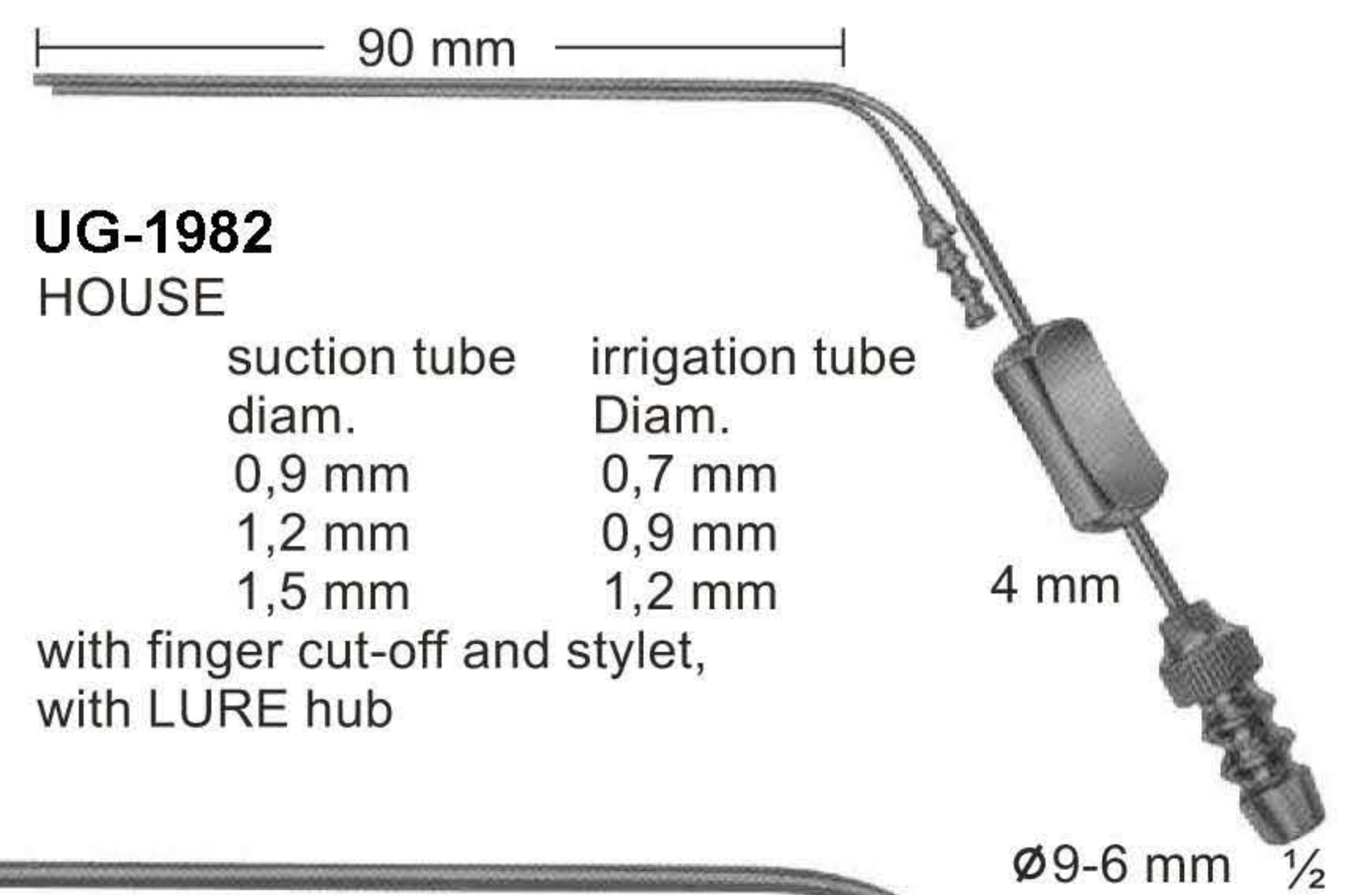

90 mm

**UG-1982**  
HOUSE

suction tube diam.	irrigation tube Diam.
0,9 mm	0,7 mm
1,2 mm	0,9 mm
1,5 mm	1,2 mm

with finger cut-off and stylet,  
with LURE hub

4 mm

Ø9-6 mm 1/2



**UG-1985**  
25-184 3,5 mm  
with LURE-LOCK cone

250 mm

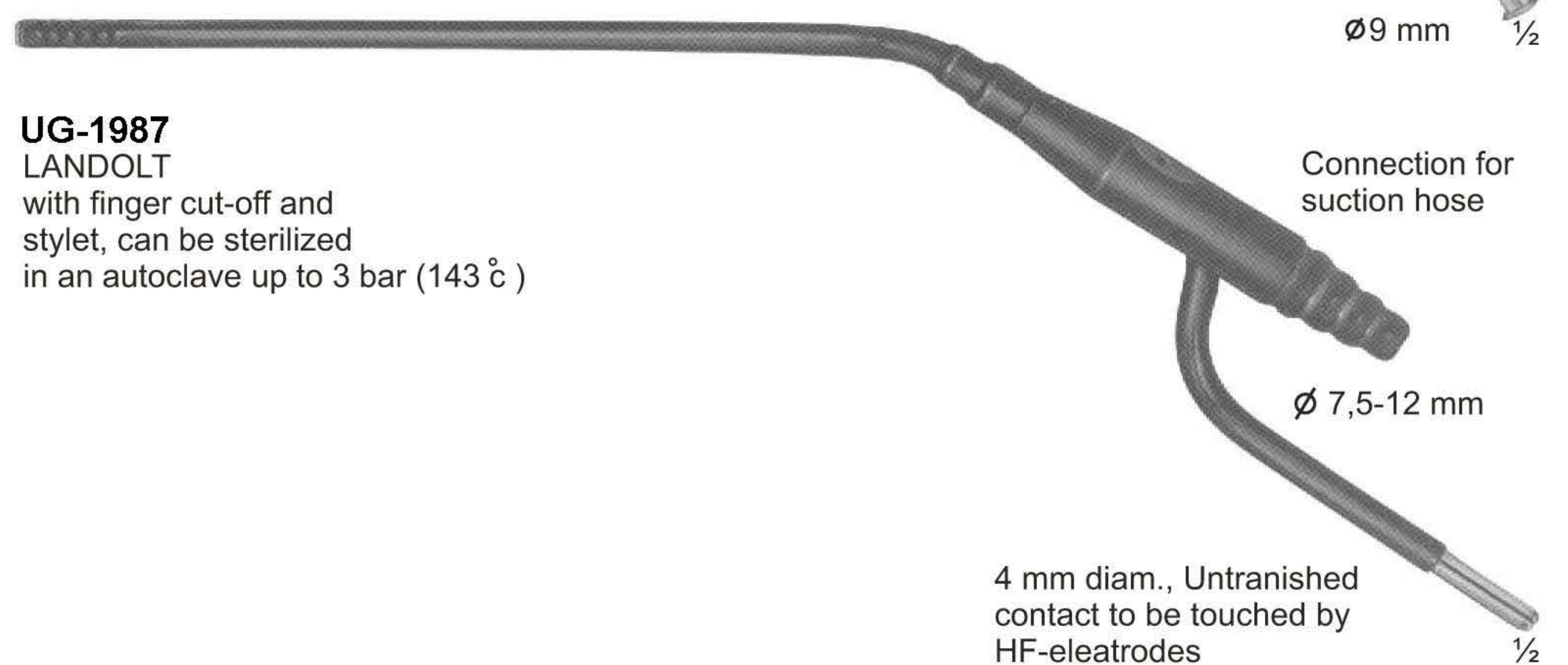

**UG-1987**  
LANDOLT  
with finger cut-off and stylet, can be sterilized in an autoclave up to 3 bar (143 °C)

Connection for suction hose

Ø 7,5-12 mm

4 mm diam., Untrashed contact to be touched by HF-electrodes

1/2

## Scissors with Tungsten Carbide Inserts



**UG-1990**  
Standard



**UG-1993**  
Standard



**UG-1996**  
Standard



**UG-1997**  
Standard



**UG-1998**  
Standard



**UG-2000**  
Standard

## Scissors with Tungsten Carbide Inserts



**UG-1969**  
Mayo-Lexer



**UG-1978**  
Mayo-Lexer



**UG-1981**  
Lexer



**UG-1983**  
Lexer



**UG-1986**  
Mayo-Stille



**UG-1988**  
Mayo-Stille

## Scissors with Tungsten Carbide Inserts



**UG-1853**  
Metzenbaum



**UG-1895**  
Metzenbaum



**UG-1900**  
Metzenbaum



**UG-1917**  
Metzenbaum-Fino



**UG-1928**  
Metzenbaum-Fino



**UG-1948**  
Metzenbaum-Fino

## Scissors with Tungsten Carbide Inserts



**UG-1827**  
Metzenbaum-Fino



**UG-1848**  
Metzenbaum-Fino



**UG-1849**  
Metzenbaum-Fino



**UG-1850**  
Metzenbaum



**UG-1851**  
Mayo



**UG-1852**  
Mayo

## Scissors with Tungsten Carbide Inserts



1/2

**UG-1816**  
Parametrium



1/2

**UG-1822**  
Mayo-Harrington



1/2

**UG-1824**  
Sims

# Scissors with Tungsten Carbide Inserts

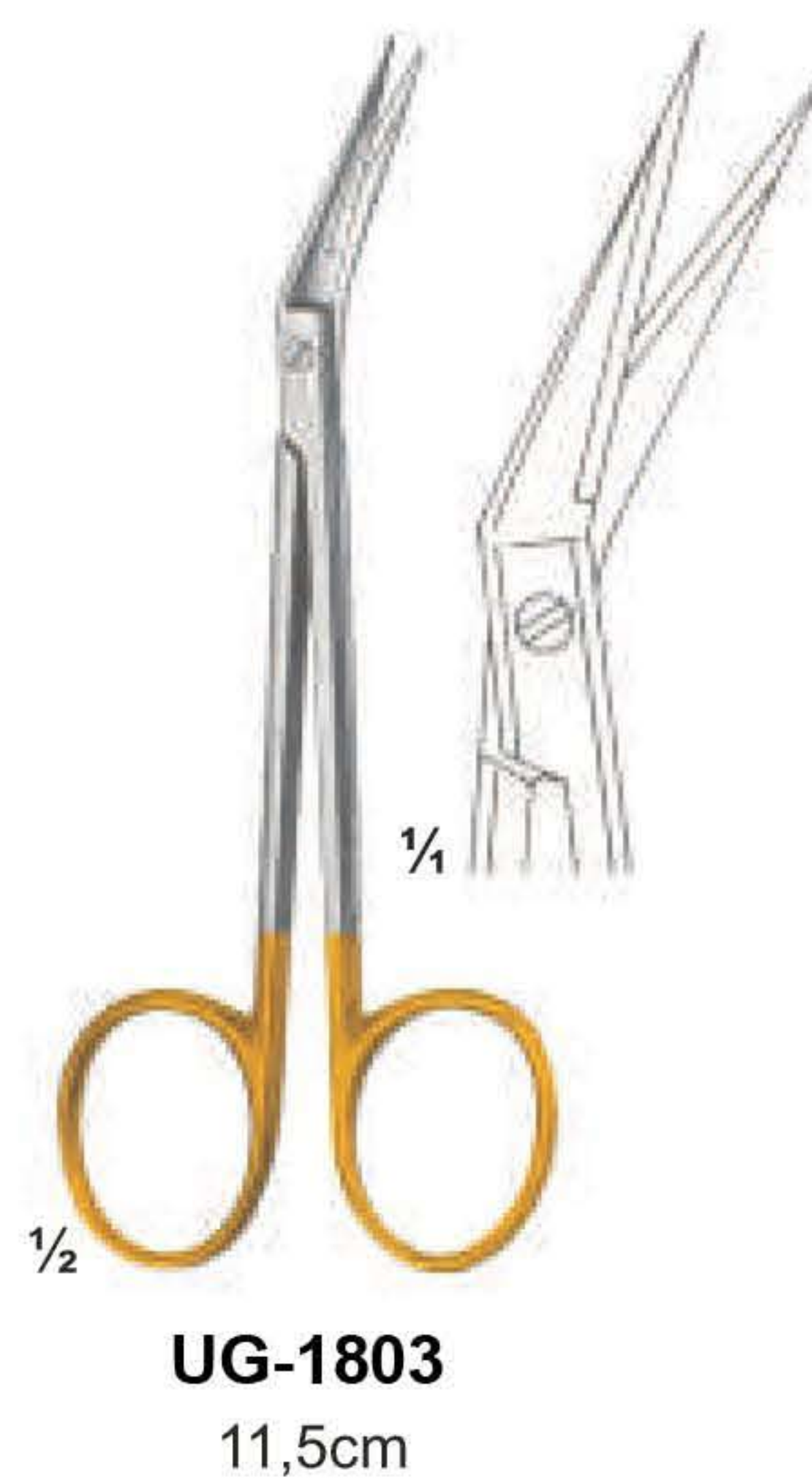
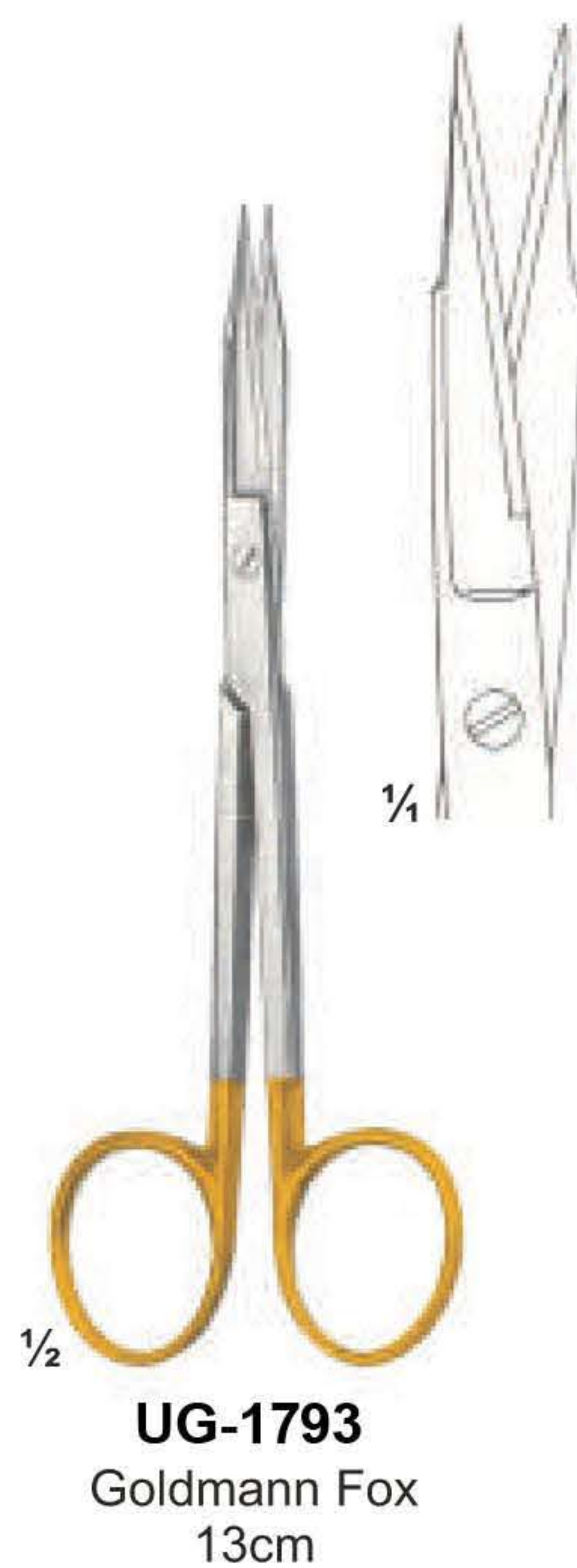

# Scissors & Dissecting Forceps with Tungsten Carbide Inserts

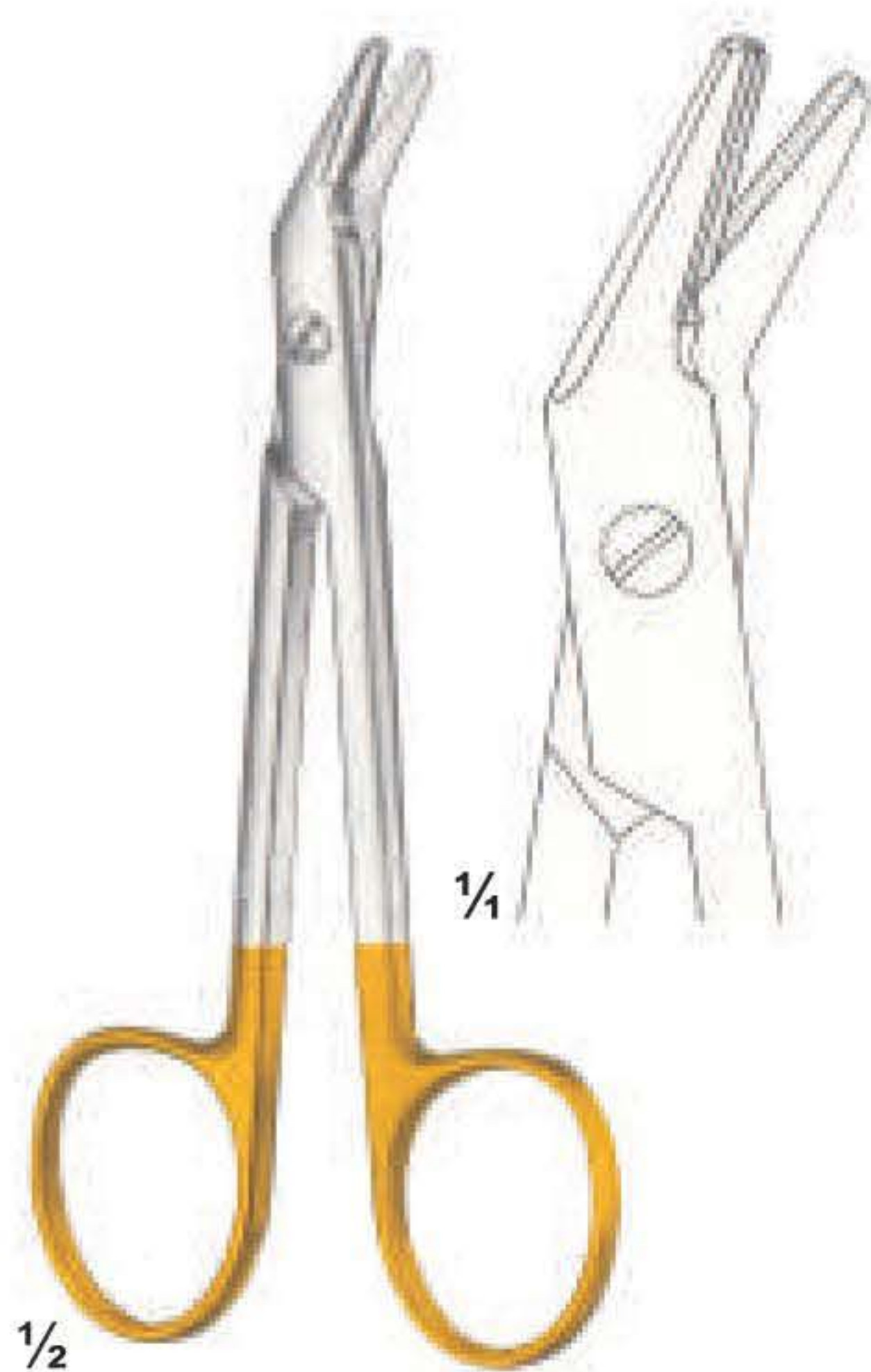

**UG-1709**  
Universal  
12cm



**UG-1711**  
Ligature Scissors  
1 Black & 1 Goldplated ring



**UG-1714**  
Adson



**UG-1717**  
Cushing  
17,5cm



**UG-1719**  
Cushing  
18cm



**UG-1721**  
Cushing-Taylor  
18cm



**UG-1722**  
Dissecting Forceps  
15cm



**UG-1723**  
Semken  
15cm



# Dissecting Forceps and Needle holders with Tungsten Carbide Inserts



$\frac{1}{2}$   
**UG-1687**  
Wangensteen



$\frac{1}{2}$   
**UG-1688**  
Potts-Smith



$\frac{1}{2}$   
**UG-1698**  
Oehler



$\frac{1}{2}$   
**UG-1701**  
Potts-Smith  
22cm



$\frac{1}{2}$   
**UG-1701**  
Hepp-Scheidle  
18cm

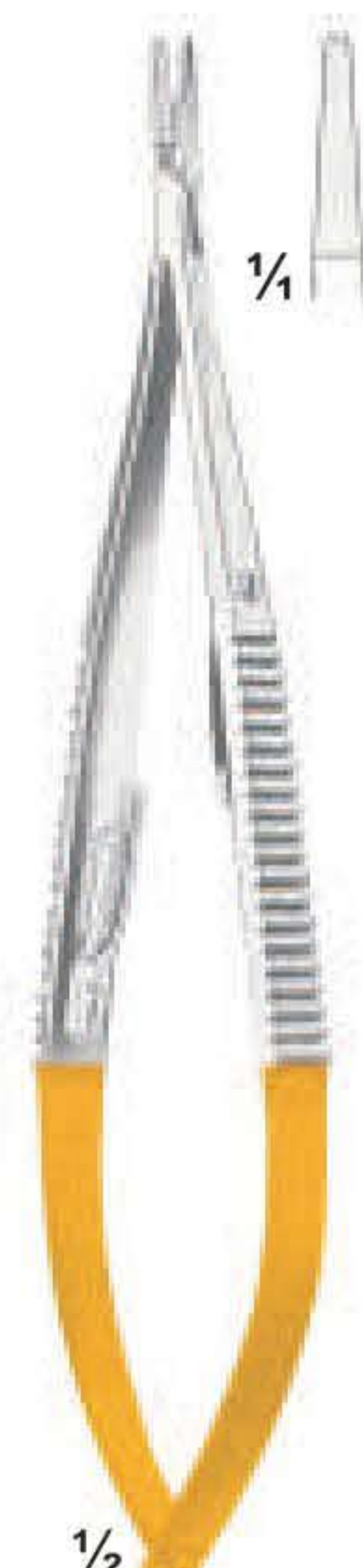

$\frac{1}{2}$   
**UG-1704**  
Castroviejo  
14cm



$\frac{1}{2}$   
**UG-1706**  
Castroviejo  
14cm



$\frac{1}{2}$   
**UG-1707**  
Arruga  
16cm

# Needle holders with Tungsten Carbide Inserts



**UG-1209**  
Arruga  
16cm



**UG-1212**  
Castroviejo  
13cm



**UG-1213**  
Hegar  
20cm 24cm



**UG-1219**  
Halsey  
13cm 15cm



**UG-1225**  
Mayo-Hegar  
16cm 18cm 20cm  
24cm 26cm 30cm



**UG-1316**  
De-Bakey  
18cm 20cm 23cm  
26cm 31cm 37cm



**UG-1317**  
Hegar-Vascular  
14cm 18cm  
20cm 23cm

# Needle holders with Tungsten Carbide Inserts



$\frac{1}{2}$  **UG-1133**  
Bozemann-Wertheim  
20cm 24cm 26cm



$\frac{1}{2}$  **UG-1137**  
Stratte  
22cm 23cm



$\frac{1}{2}$  **UG-1139**  
Ryder  
13cm 15cm 18cm  
20cm 23cm 26cm



$\frac{1}{2}$  **UG-1146**  
Ryder-Vascular  
13cm 15cm 18cm  
20cm 23cm 26cm



$\frac{1}{2}$  **UG-1195**  
Martin  
15cm 17cm 20cm



$\frac{1}{2}$  **UG-1201**  
Sarot  
18cm 20cm 26cm

# Needle holders with Tungsten Carbide Inserts



# Needle holders with Tungsten Carbide Inserts



$\frac{1}{2}$  **UG-1056**  
Mathieu-Ryder  
17cm  
20cm 24cm



$\frac{1}{2}$  **UG-1057**  
Lichtenberg  
20cm



$\frac{1}{2}$  **UG-1059**  
Langhals  
20cm 25cm



$\frac{1}{2}$  **UG-1062**  
Lichtenberg  
20cm 25cm



$\frac{1}{2}$  **UG-1064**  
Luehty-Beck  
20cm 25cm



$\frac{1}{2}$  **UG-1065**  
Luehty-Beck  
20cm 25cm



$\frac{1}{2}$  **UG-1066**  
Langebeck  
18cm  
20cm 23cm



$\frac{1}{2}$  **UG-1068**  
Langebeck-beck  
18cm  
20cm 23cm

# Hospital Wares



**UG-1032**  
Schimmelbusch

**UG-1032** Ø x H  
sizes in mm

80 x 80  
105 x 120  
140 x 140

160 x 120  
160 x 150  
190 x 150

190 x 190  
240 x 160  
240 x 240

290 x 160  
290 x 240  
340 x 160  
340 x 340

390 x 190  
390 x 290

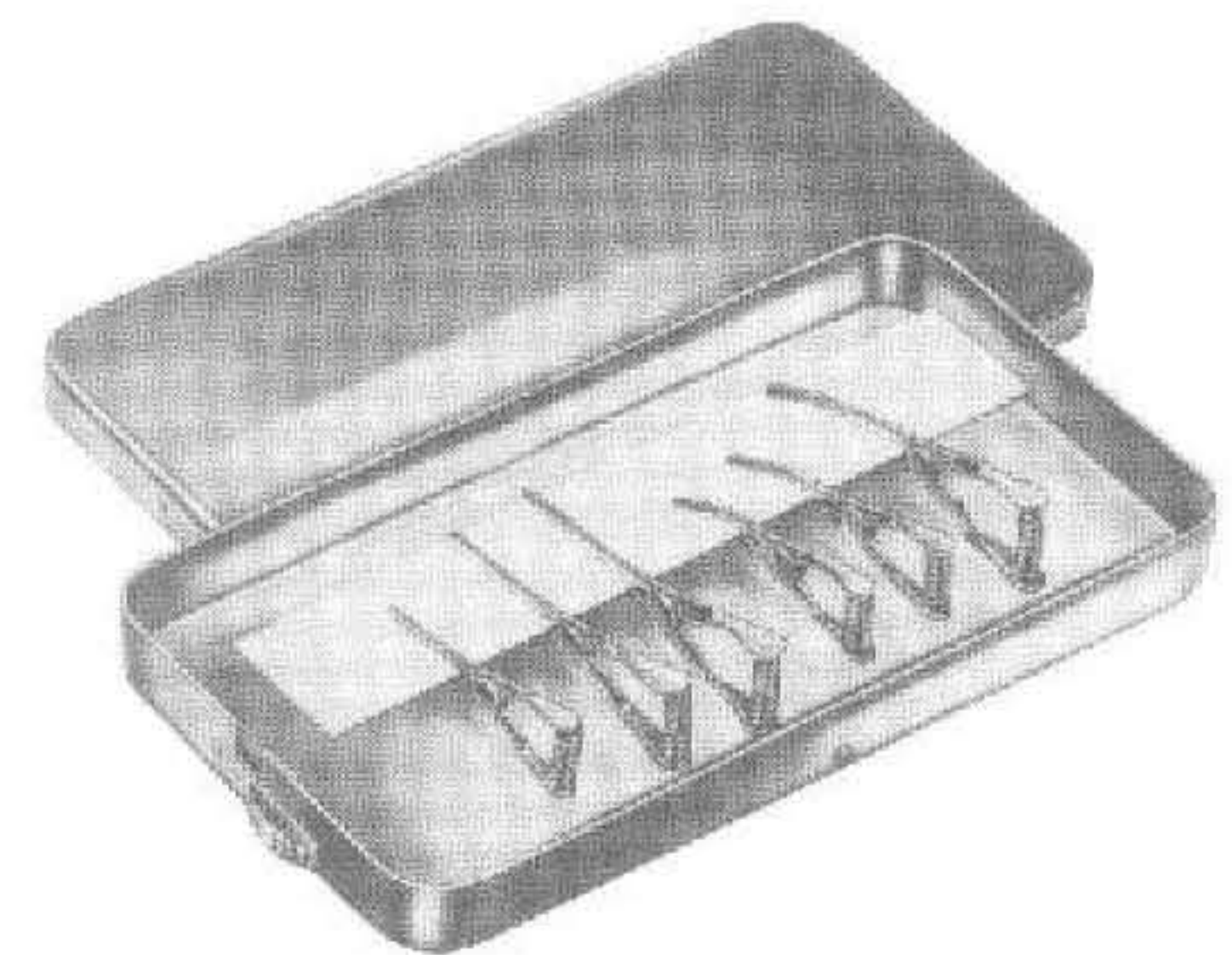

**UG-1046**

Box  
120 x 65 x 13mm  
(without Bulldog clamps,  
without silicone tape)



**UG-1047**

Box with support  
120 x 65 x 13 mm  
(ohne Bulldogklemmen)



**UG-1048**

Box with support for  
needle electrodes,  
without instruments

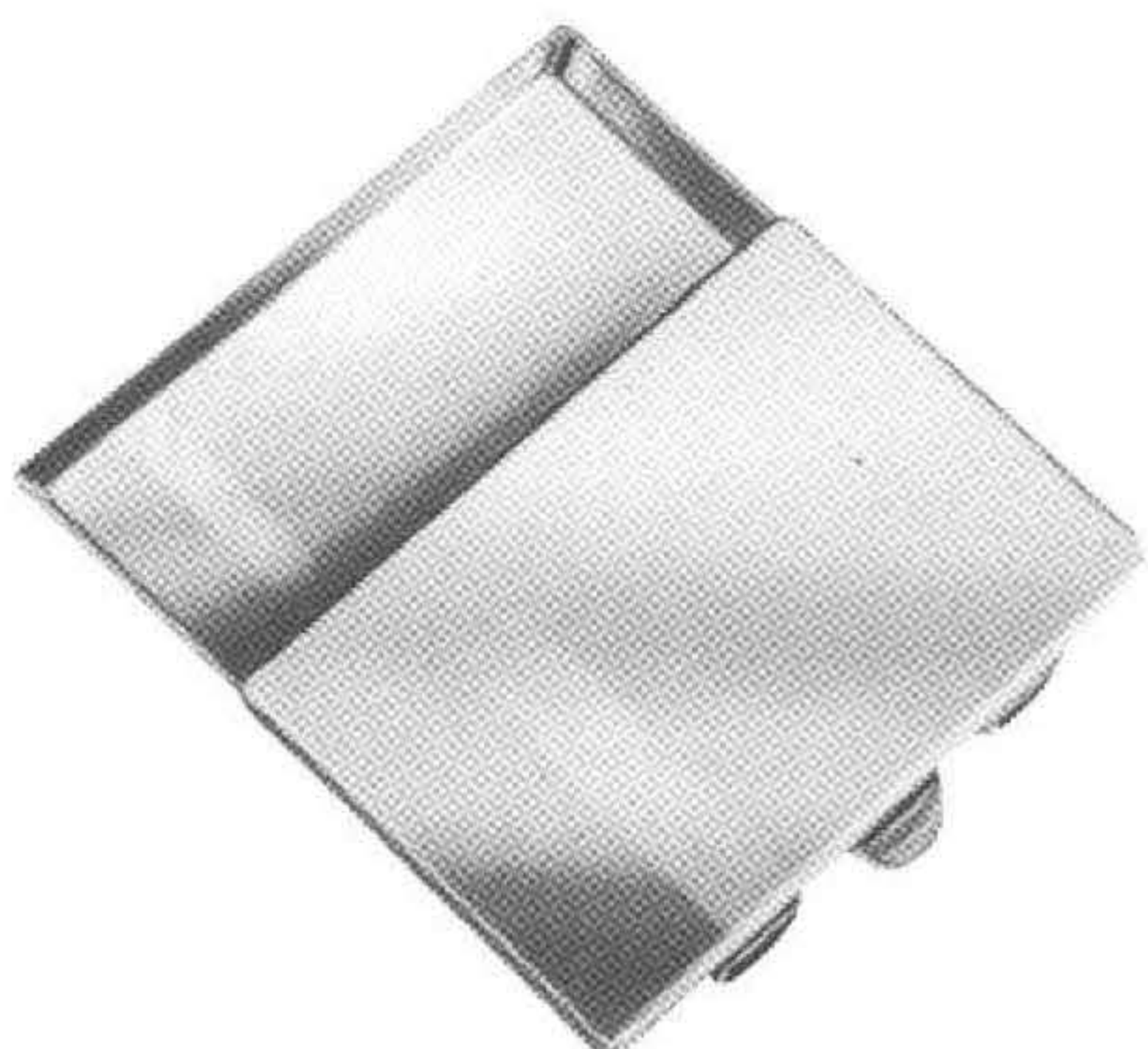

**UG-1049**

50 x 25 x 4,5 mm

65 x 42 x 8 mm

75 x 25 x 4,5 mm

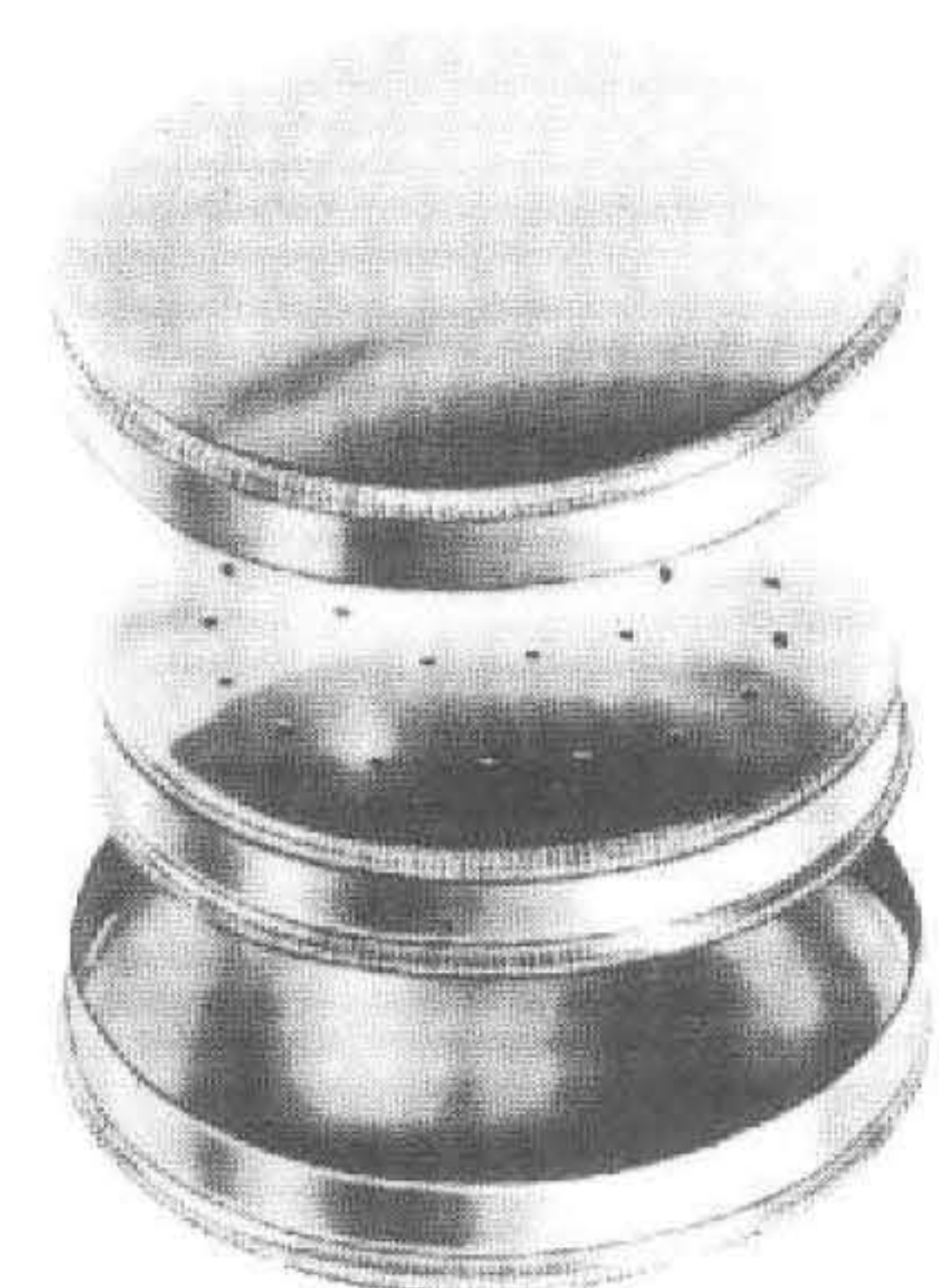

**UG-1050**

Ø 65mm x 15mm

# Hospital Wares

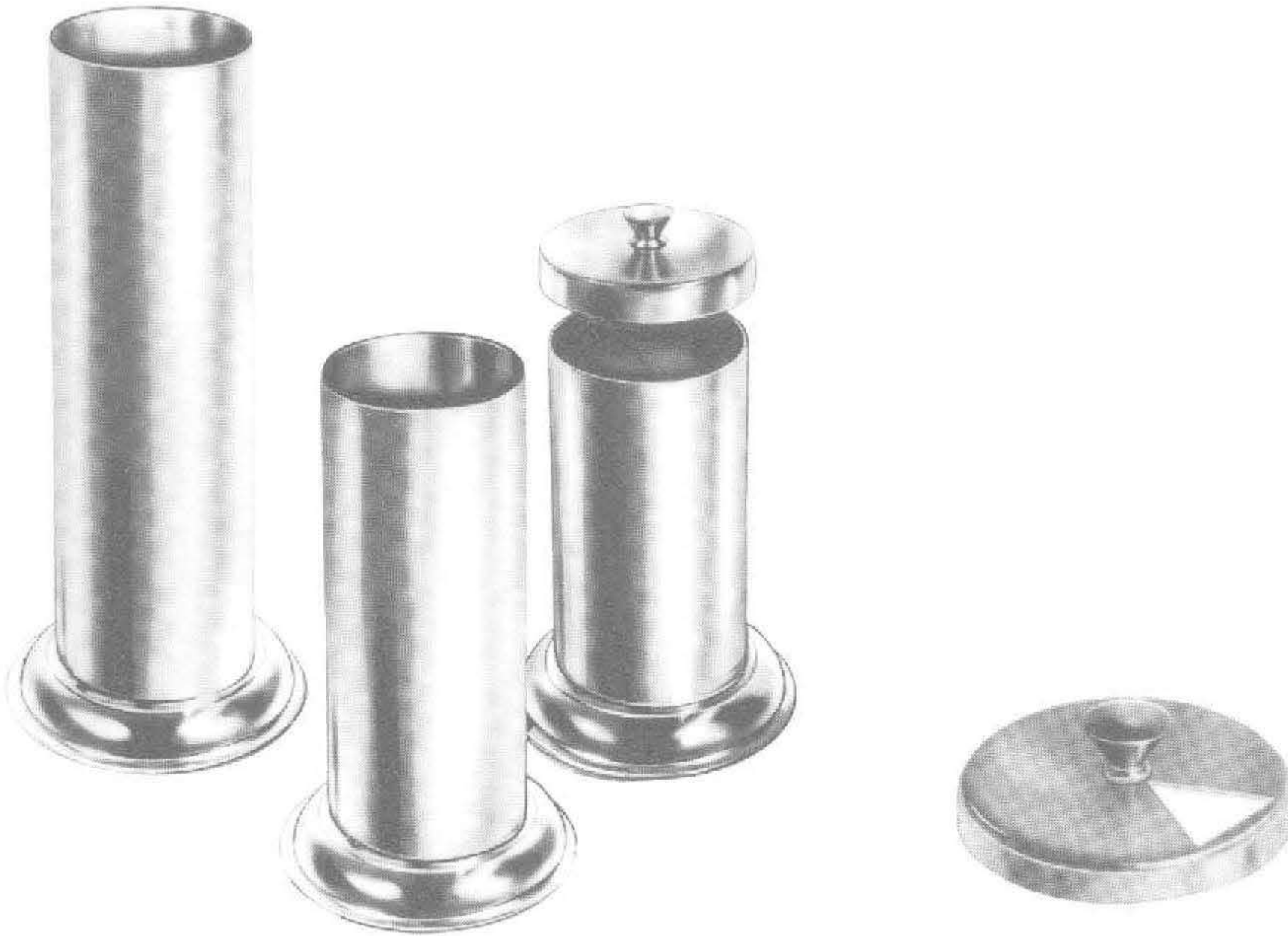

**UG-992**

$\varnothing$ x H
30 x 90 mm
50 x 100 mm
50 x 130 mm
50 x 175 mm
75 x 100 mm
75 x 130 mm
75 x 175 mm
100 x 175 mm
100 x 200 mm



**UG-1024**

165 x 85 x 35 mm
200 x 100 x 35 mm
200 x 100 x 50 mm
230 x 130 x 50 mm
260 x 150 x 50 mm
270 x 235 x 50 mm
300 x 200 x 50 mm
325 x 275 x 50 mm



**UG-1029**

205 x 105 x 35 mm

## Forceps Jars

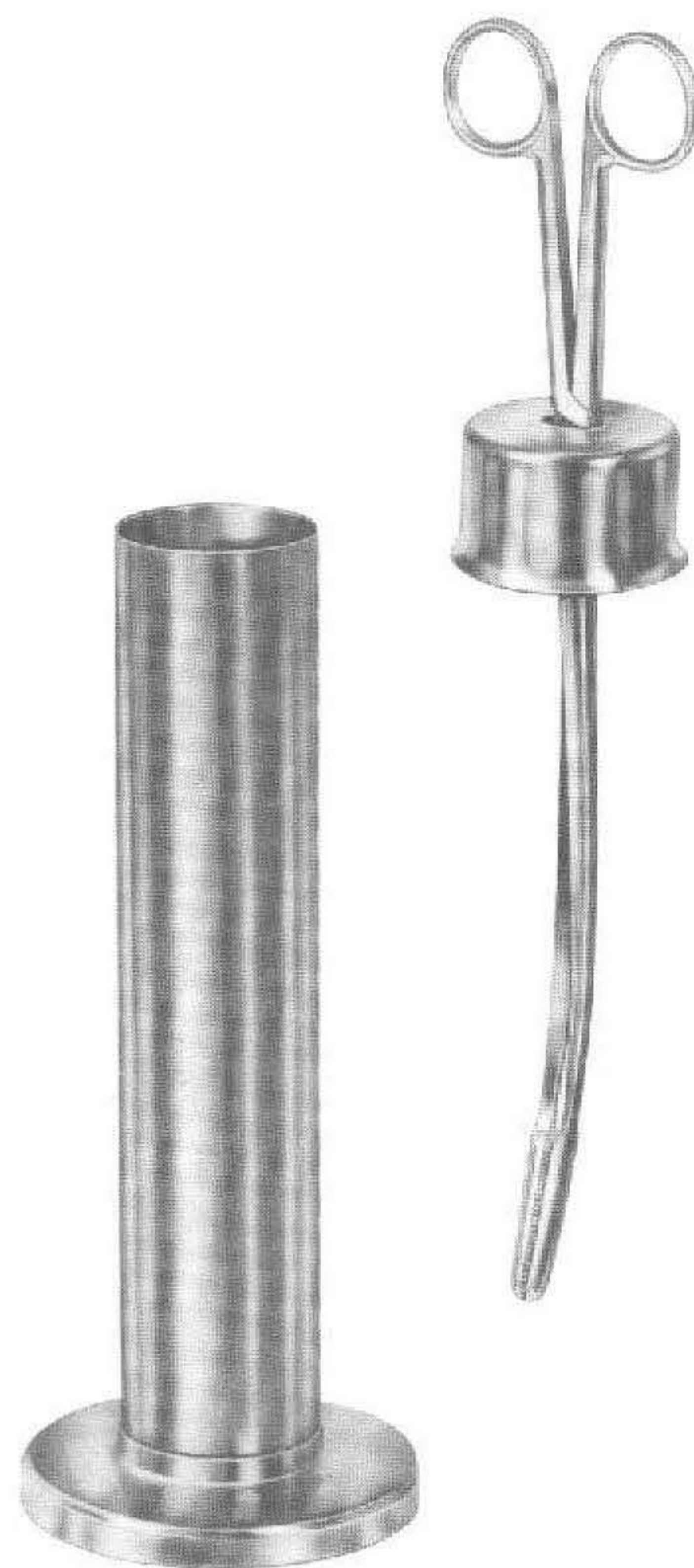
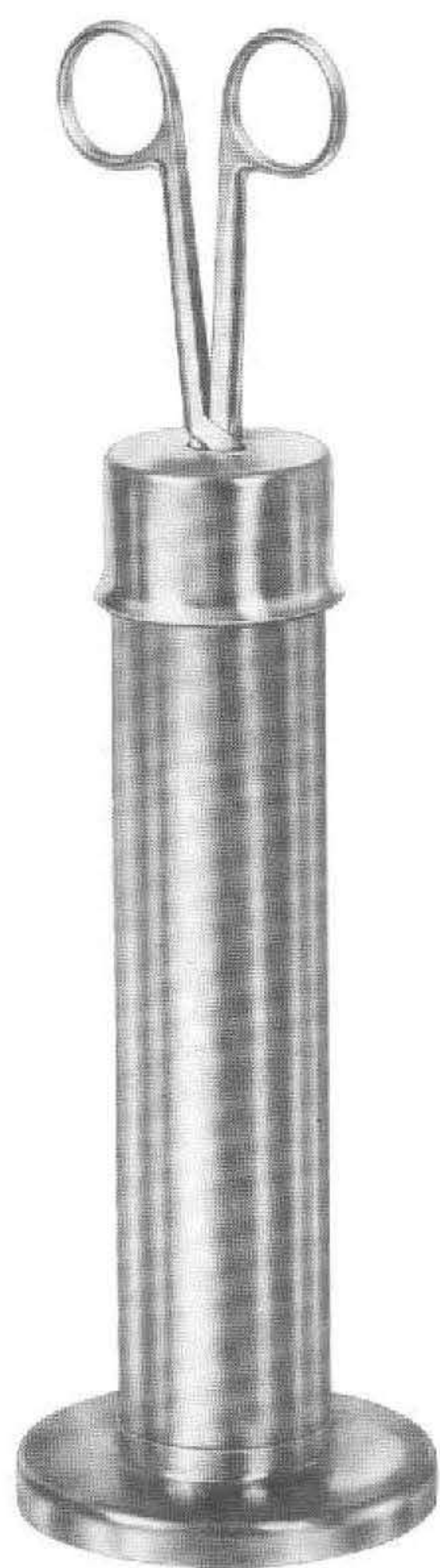

**UG-961**

Martin Sterilizing Forceps  
consisting of:  
1 Sterilizing Forceps, curved, 25 cm,  
without ratchet, with lid for jar  
1 jar with bottom plate (anti-tilt)  
ditto, with 32 cm long Sterilizing Forceps



# Round Metal Boxes and Medicine Cups

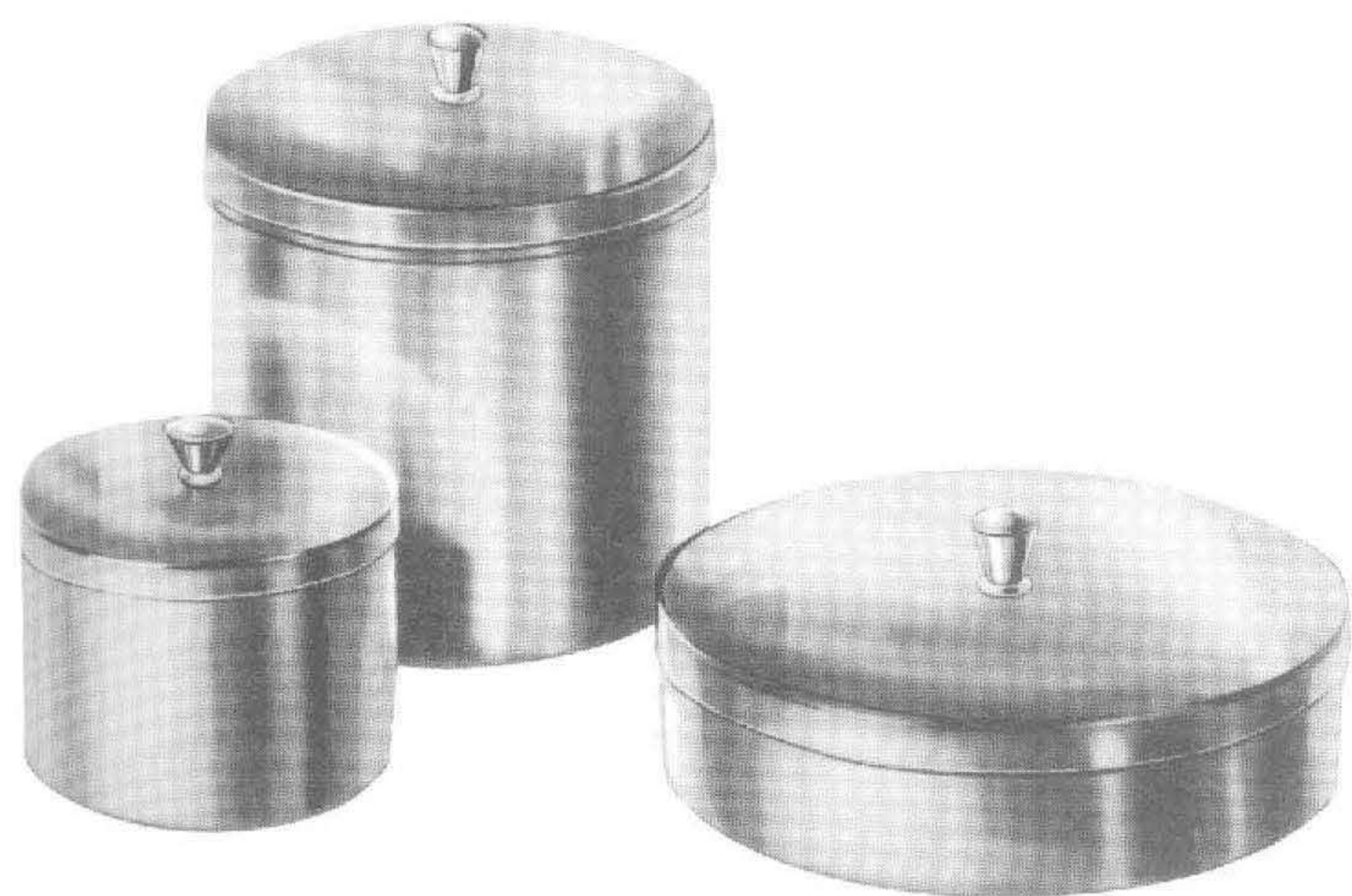

**UG-939**

Ø x H  
 75 x 60 mm  
 75 x 75 mm  
 100 x 60 mm  
 100 x 100 mm  
 125 x 80 mm  
 125 x 125 mm  
 150 x 150 mm

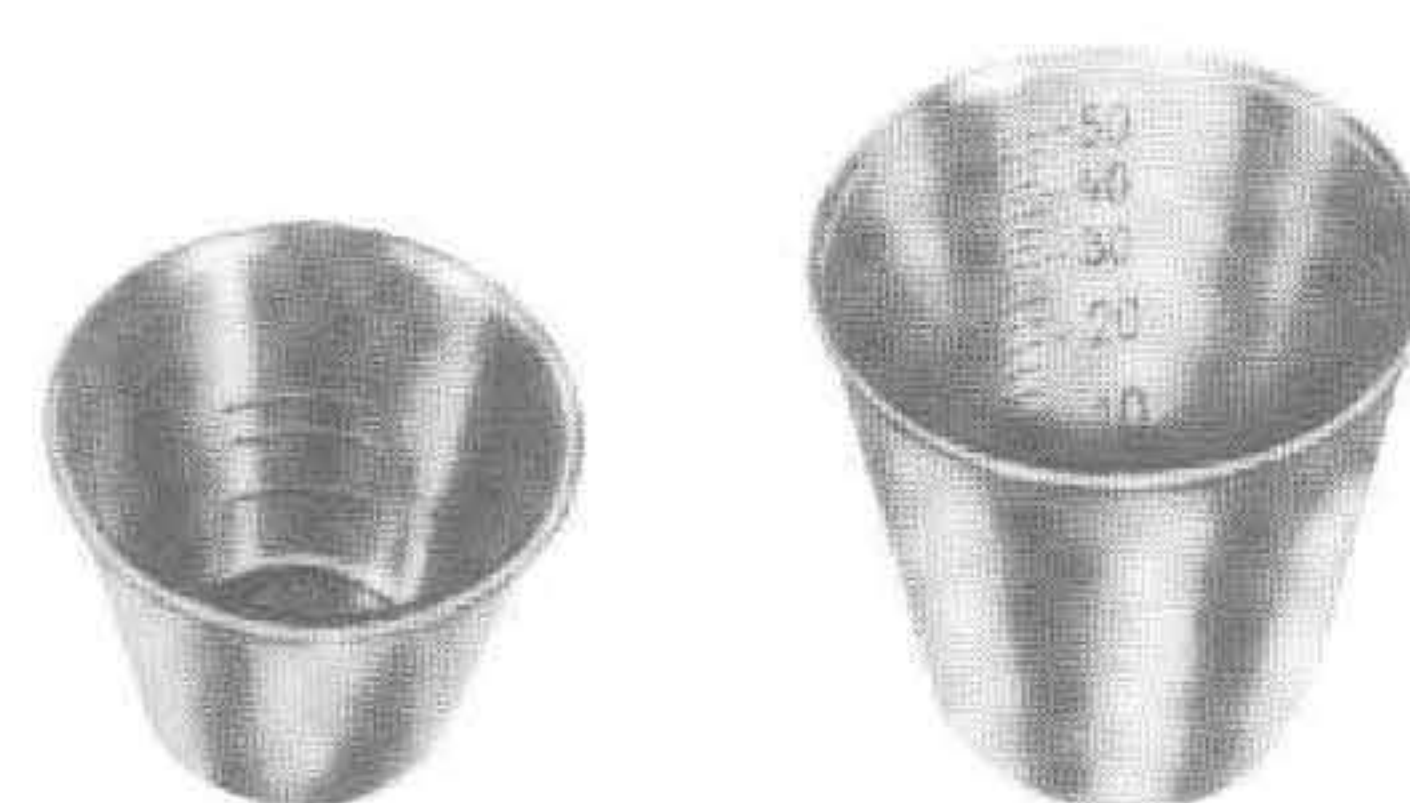

**UG-944**  
25 cc

**UG-945**  
50 cc



**UG-946**  
20 cc  
Medicine Spoon



**UG-947**  
Ø75 x 12 mm  
Tablet Tray



**UG-949**  
Ø90 x 90 mm  
Metal Cup



**UG-950**  
Ø75 x 80 mm  
Sputum Cup

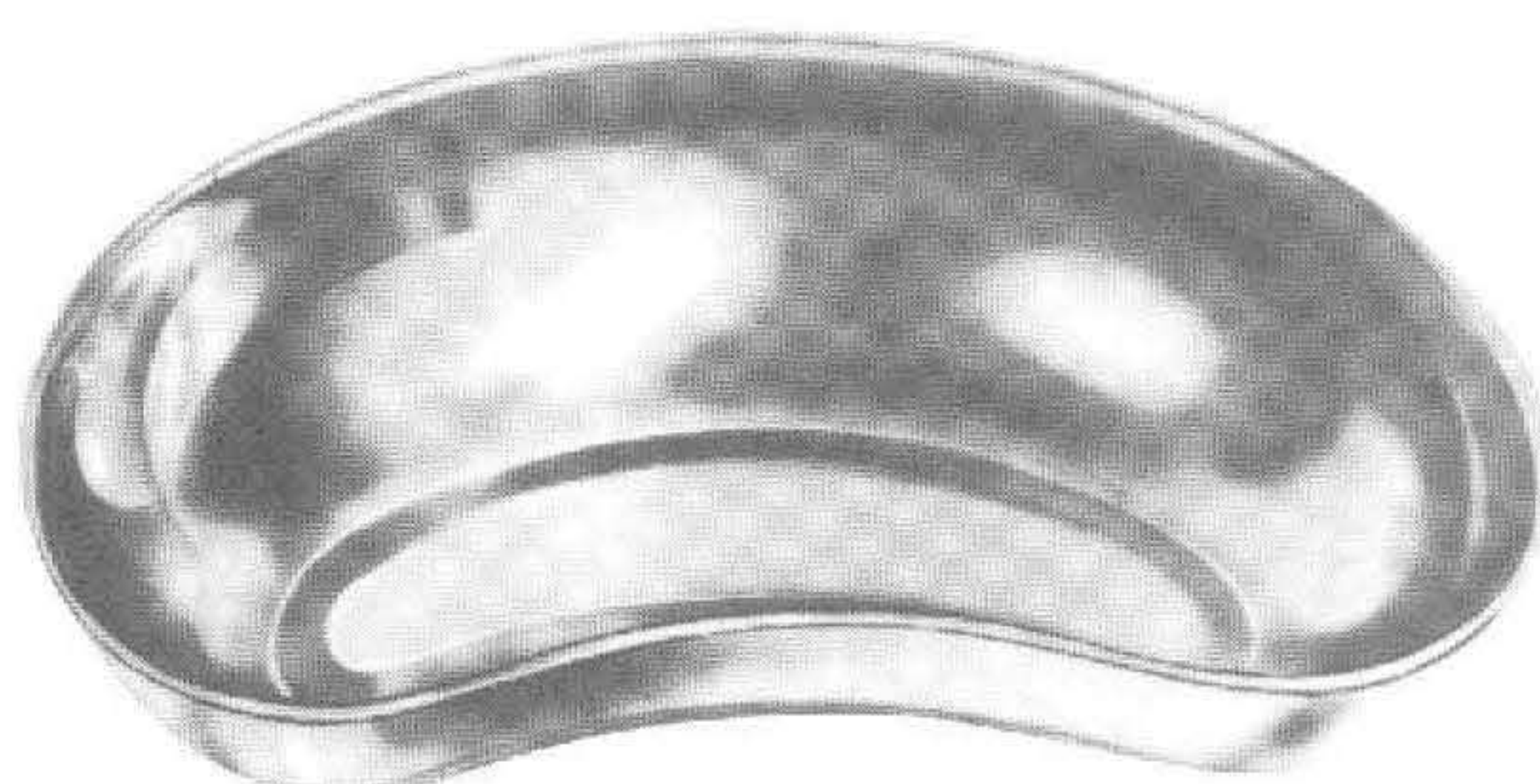

**Kidney Dish**

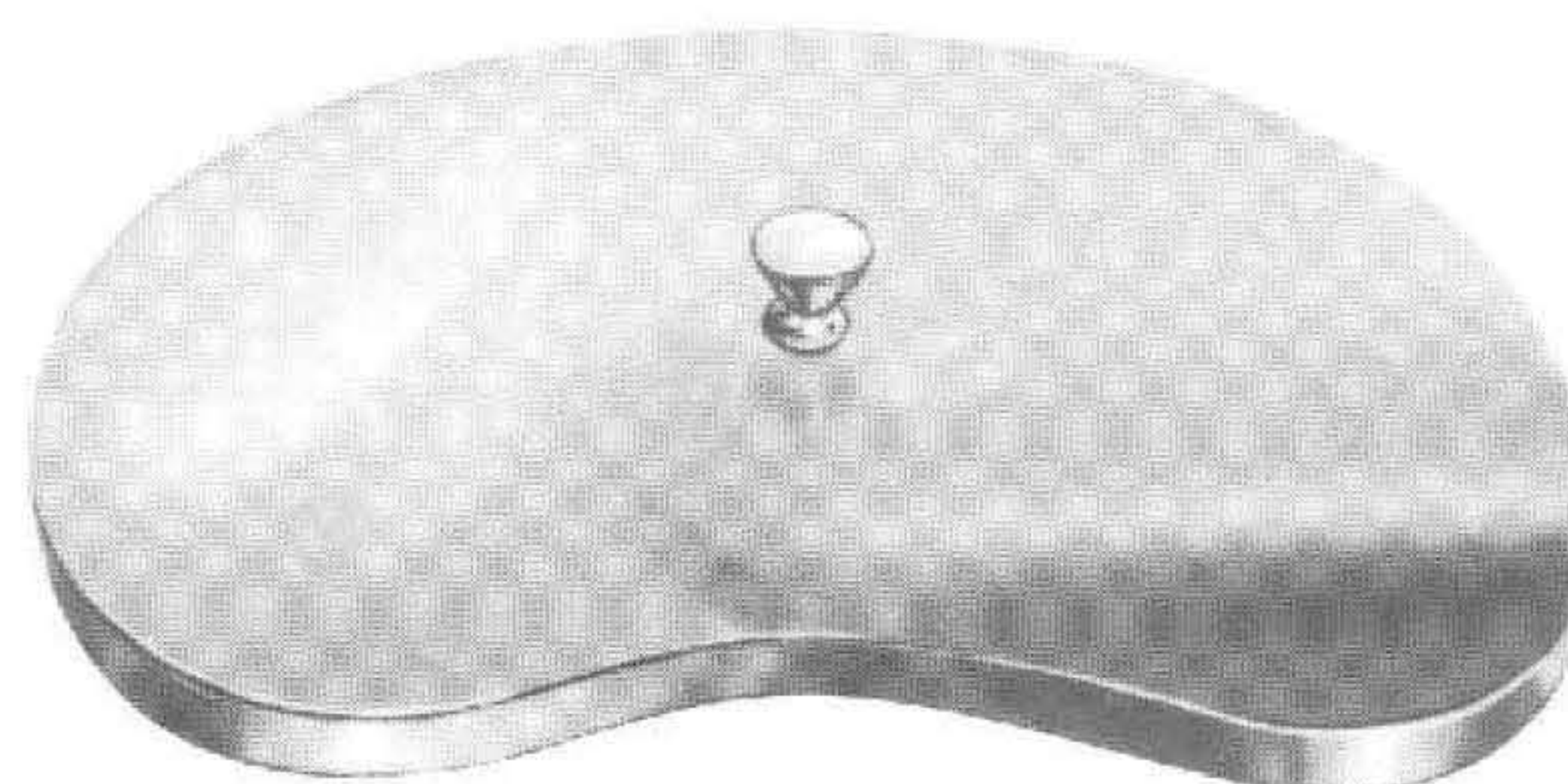

**UG-952**

170 x 100 x 35 mm  
 250 x 140 x 40 mm  
 275 x 150 x 45 mm

# Hospital Wares

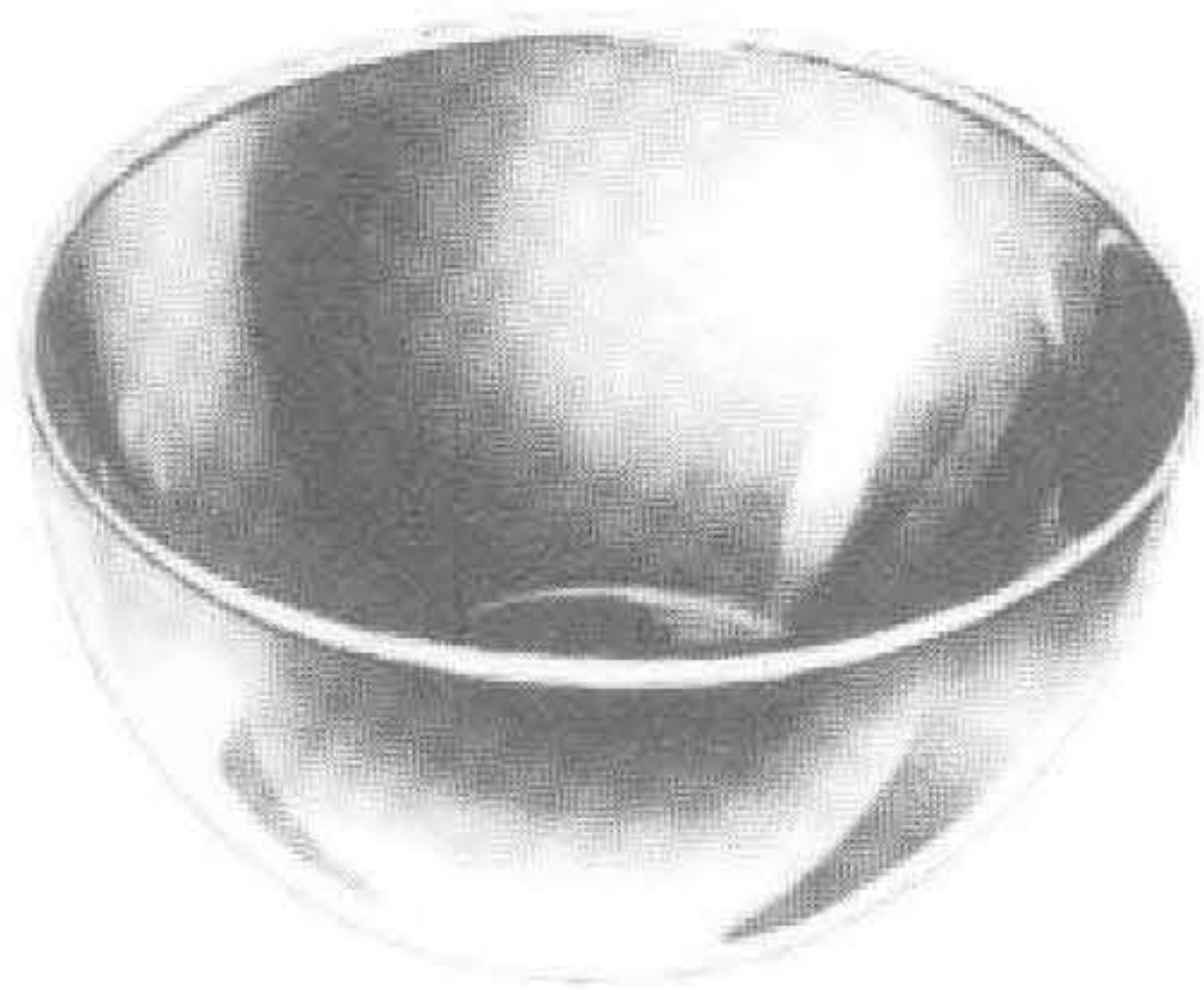

**UG-533**

Ø x H		
40 x 19	mm	0.05L
61 x 30	mm	0.07L
80 x 40	mm	0.14L
116 x 50	mm	0.35L
128 x 55	mm	0.45L
147 x 65	mm	0.70L
167 x 75	mm	1.10L
187 x 85	mm	1.60L

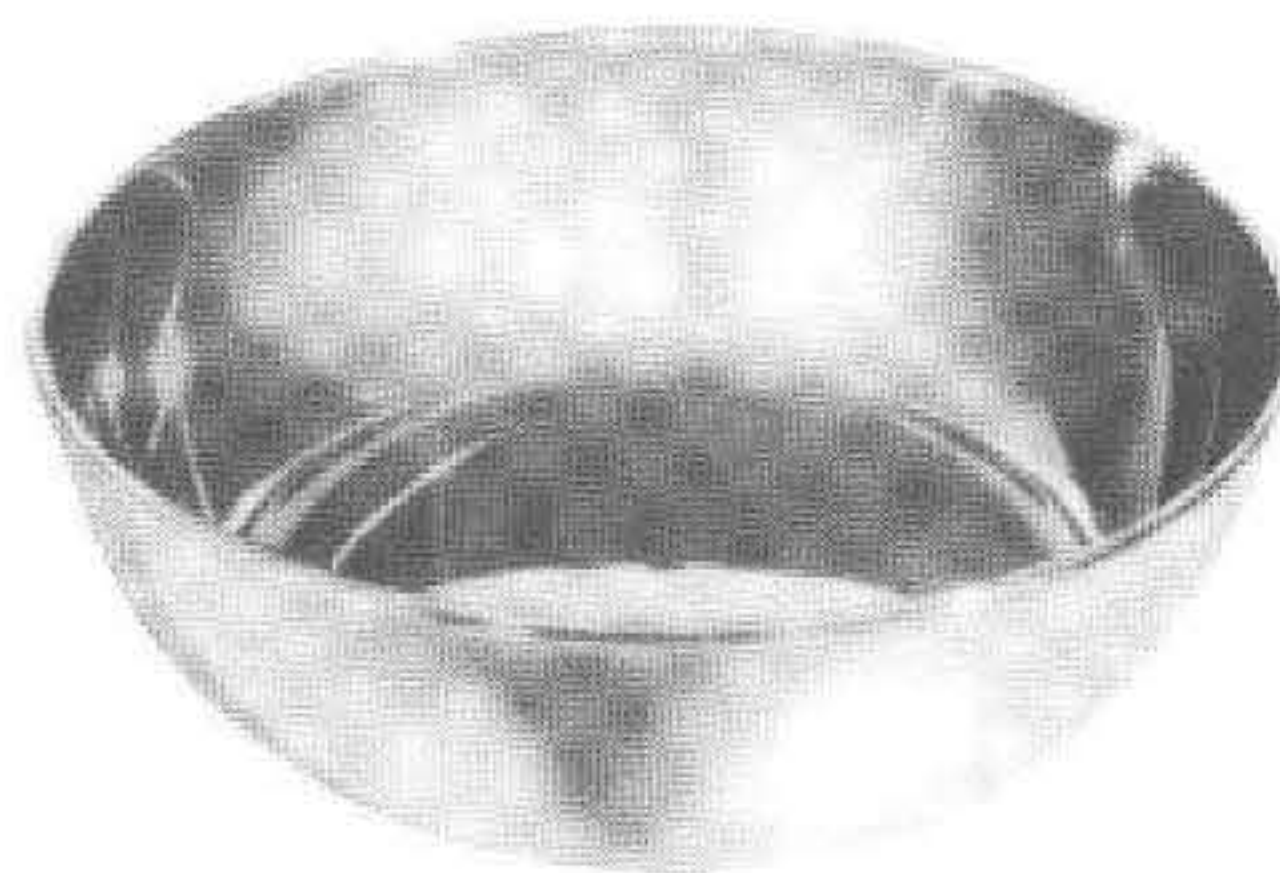

**UG-668**

116 x 35	mm	0.30L
128 x 38	mm	0.40L
147 x 40	mm	0.50L
157 x 45	mm	0.75L
187 x 45	mm	1.00L

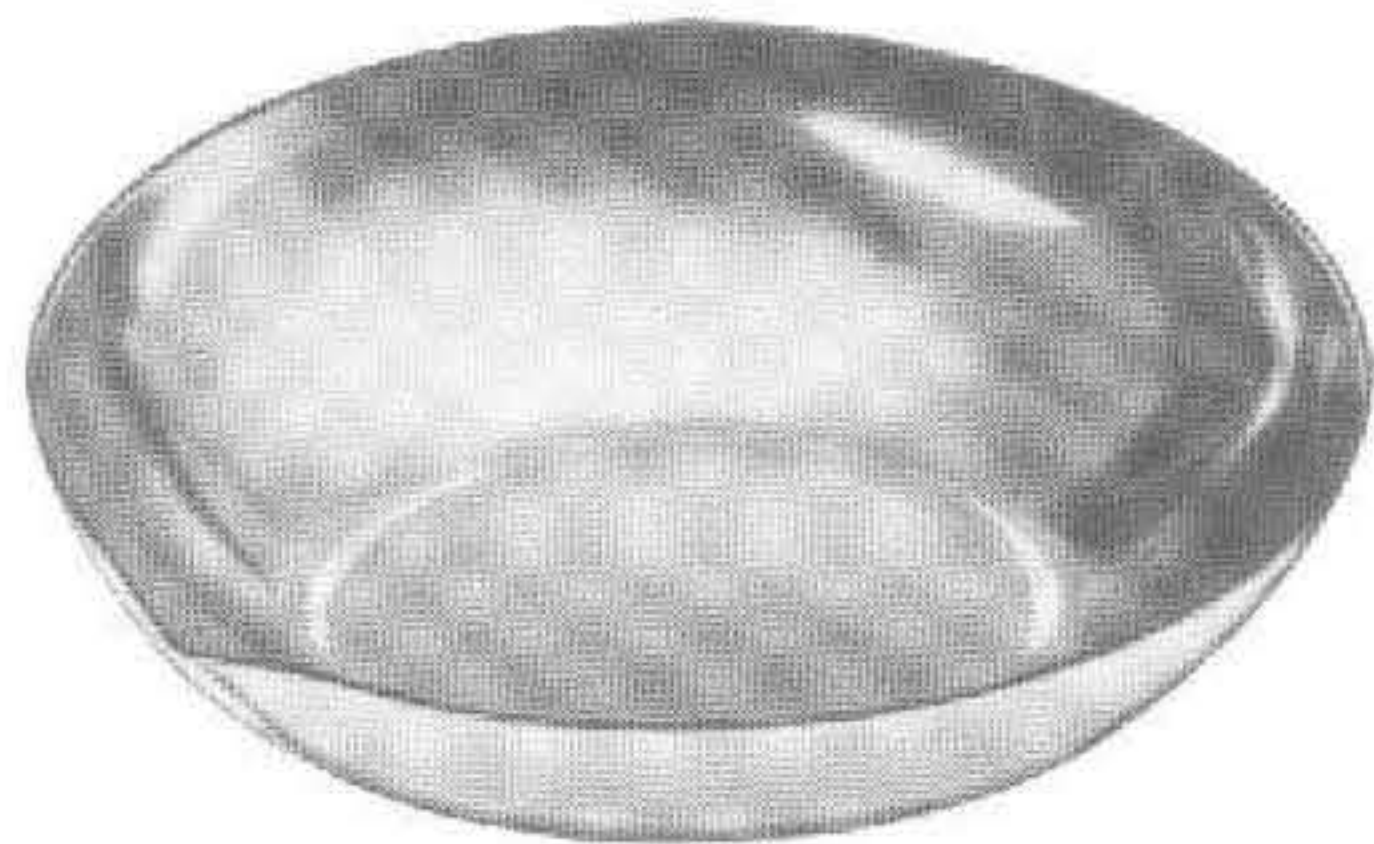

**UG-682**

Ø 110 x 28 mm 0.15L

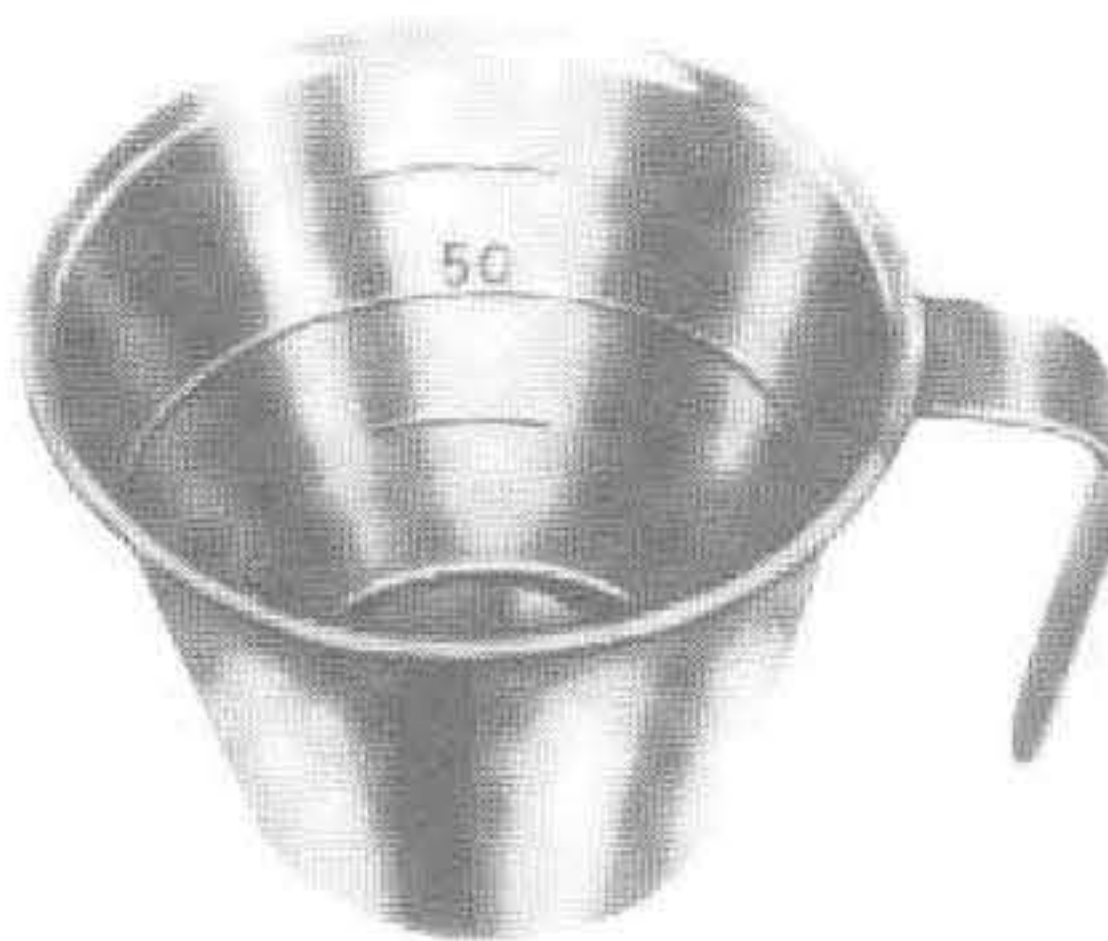

**UG-719**

100 cc 0.1L



**UG-934**

0,25L  
0,50L  
1,00L  
2,00L



**UG-935**

235 x 190 x 40 mm

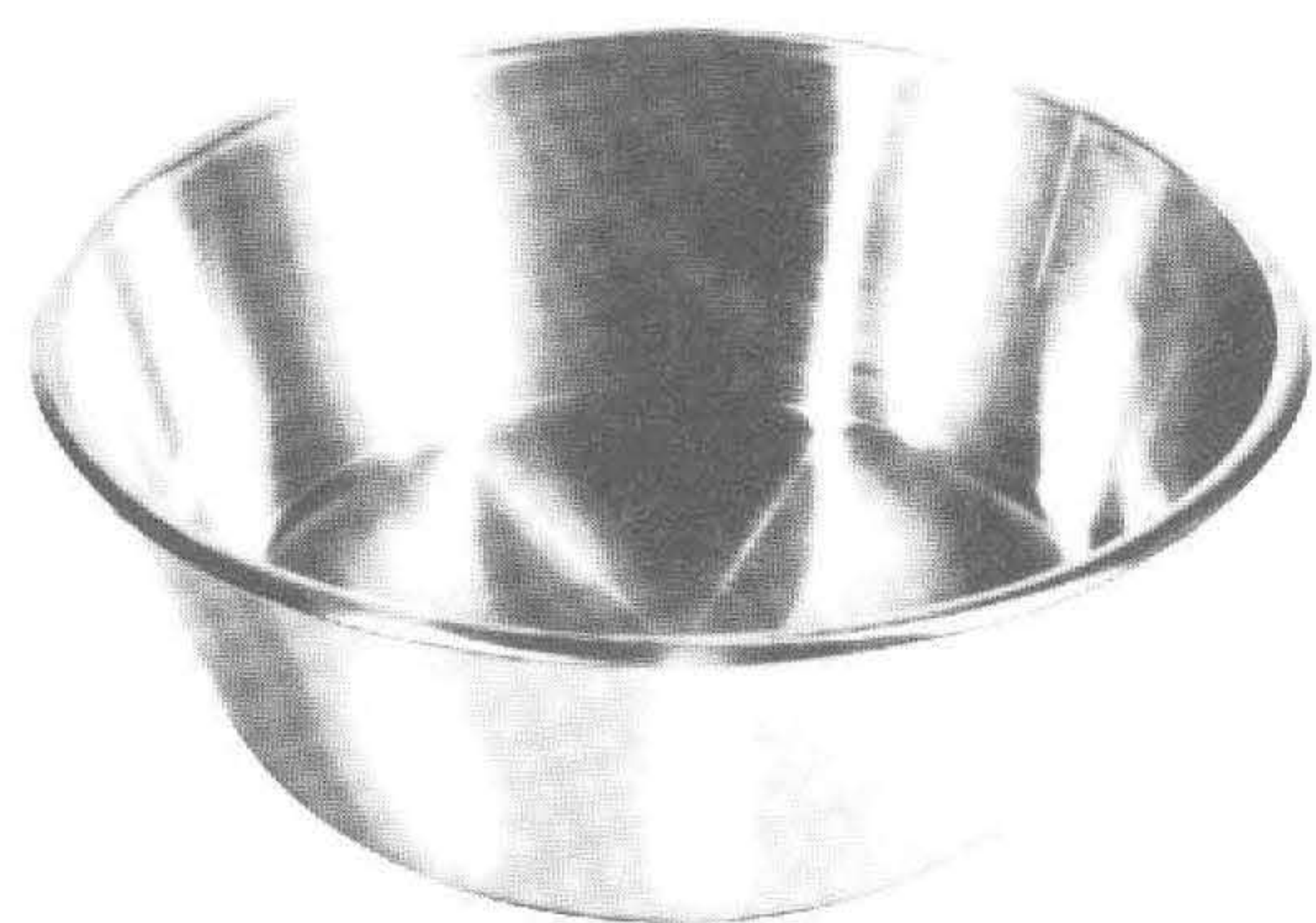

**UG-936**

Ø 220 x 70 mm

# Hospital Wares

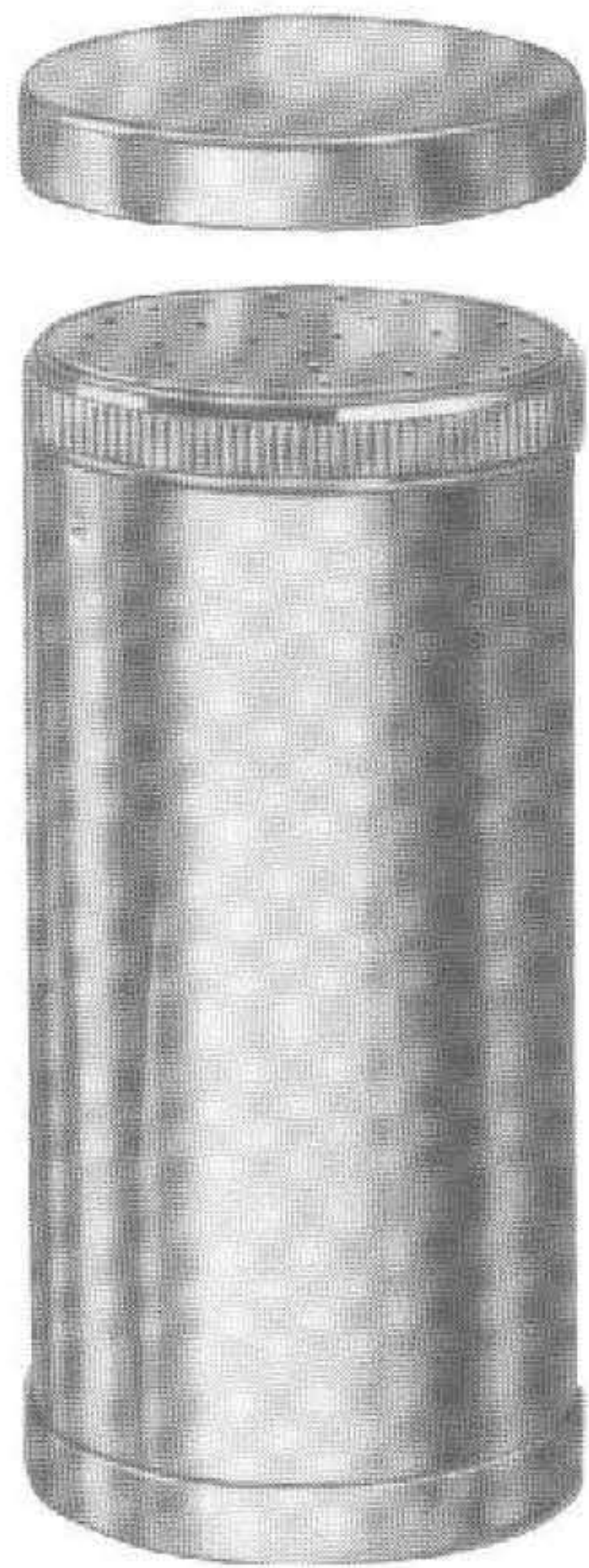

**UG-519**  
Ø 50 x 100 mm  
Powder Pot

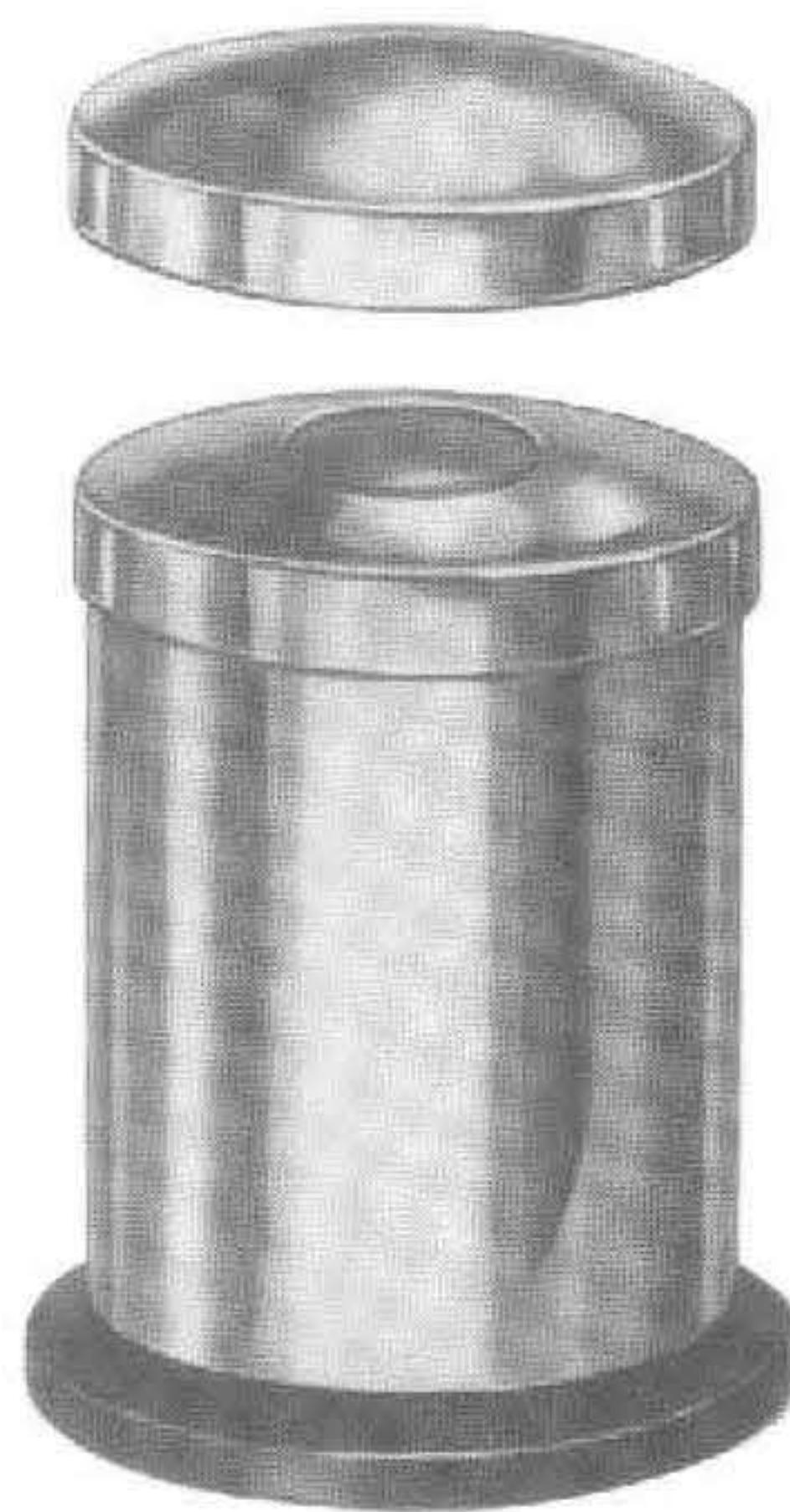

**UG-521**  
Ø 50 x 75 mm  
Methot With Lid



**UG-523**  
Ø 50 x 75 mm  
Methot Without Lid

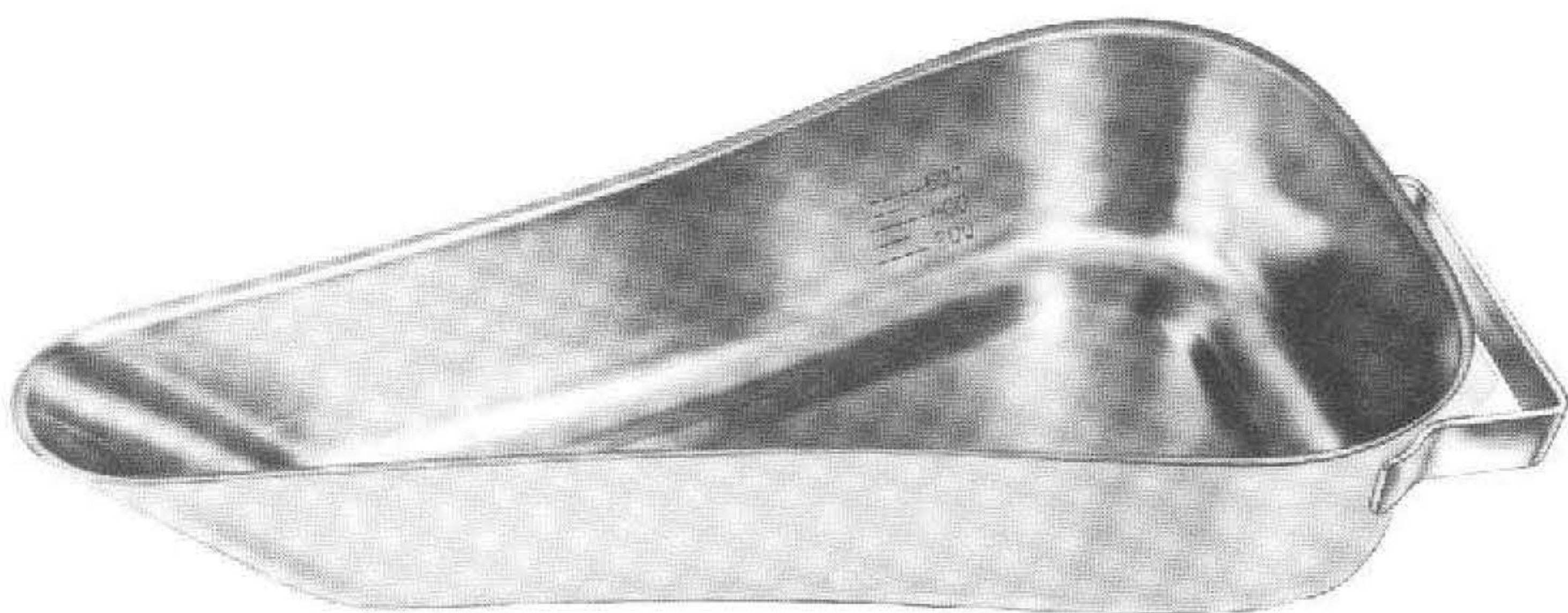

**UG-526**

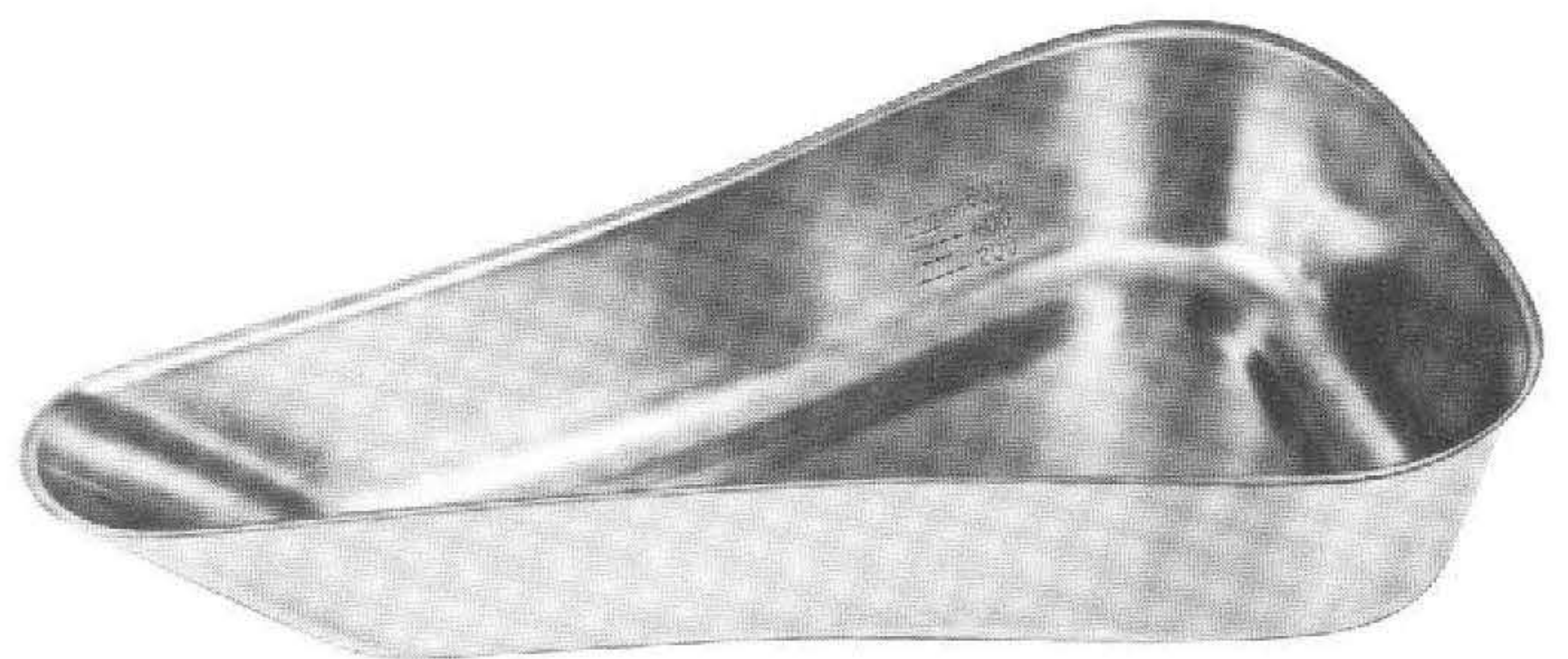

**UG-526**



**UG-530**

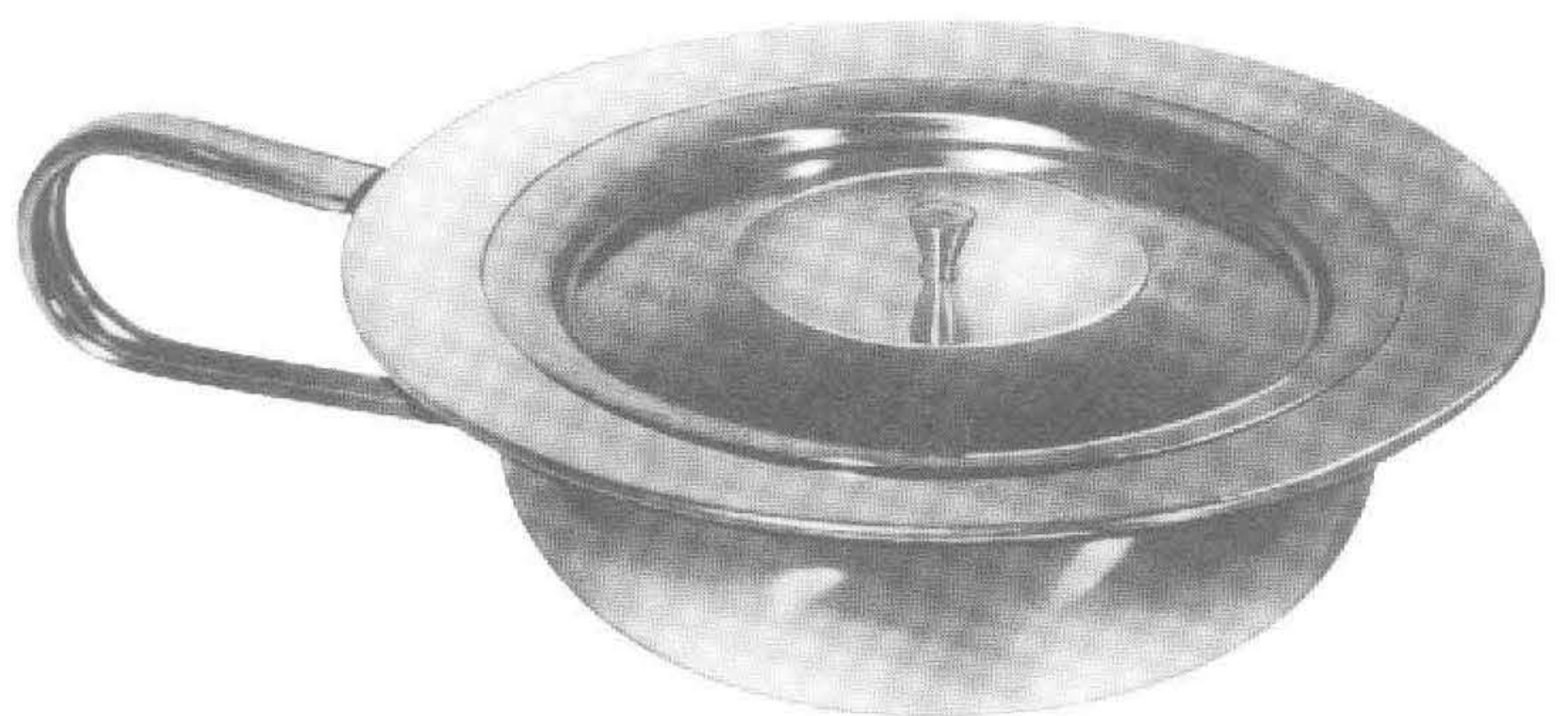

**UG-532**

Ø 235 mm  
Ø 310 mm

# Needle Cases



**UG-505**  
Sauerbruch  
210 x 125 x 17 mm



**UG-506**  
Sauerbruch  
210 x 125 x 17 mm



**UG-507**  
150 x 95 x 13 mm

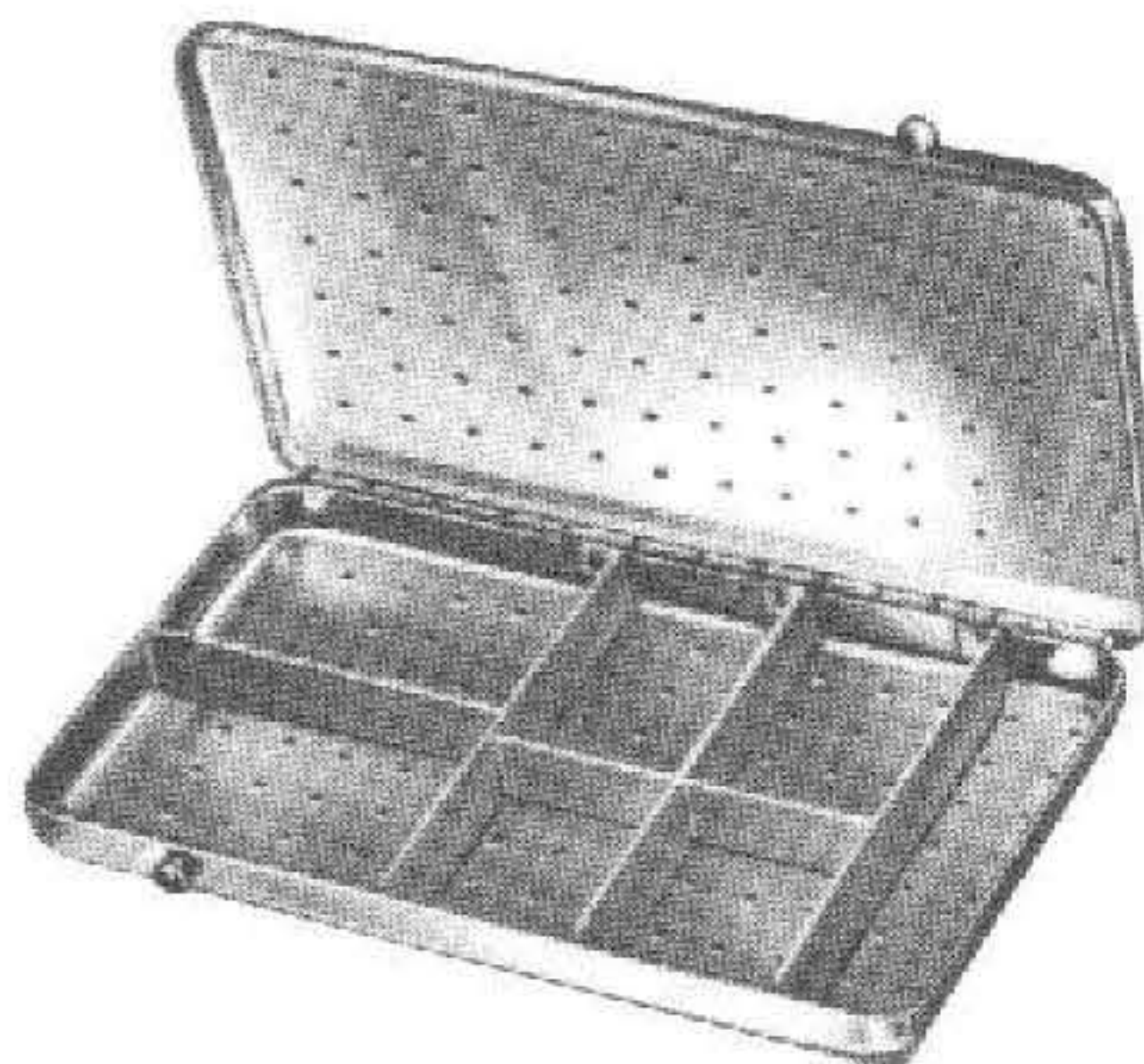

**UG-509**  
150 x 95 x 13 mm

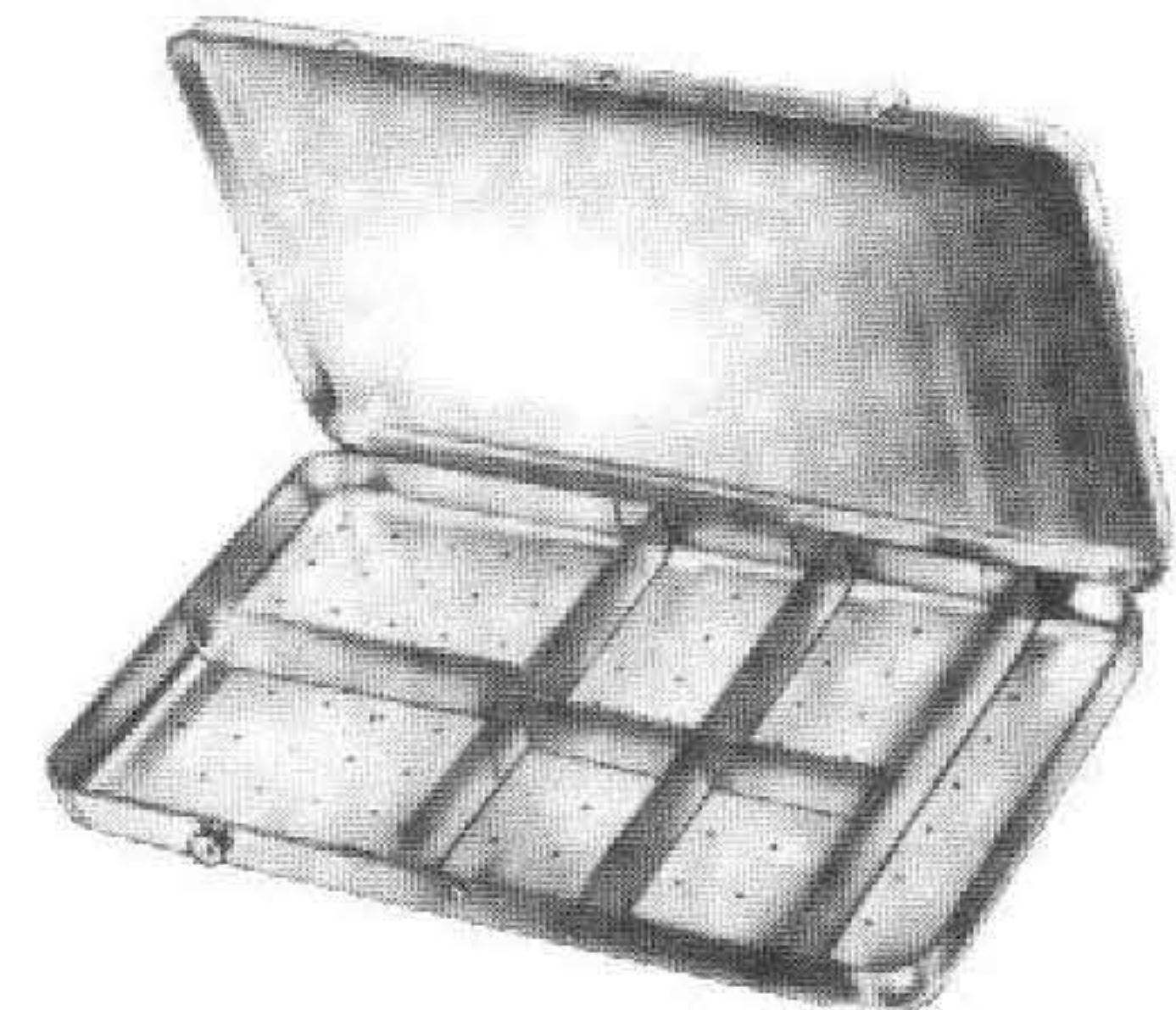

**UG-510**  
150 x 95 x 13 mm



**UG-511**  
150 x 95 x 13 mm



**UG-512**  
150 x 95 x 13 mm

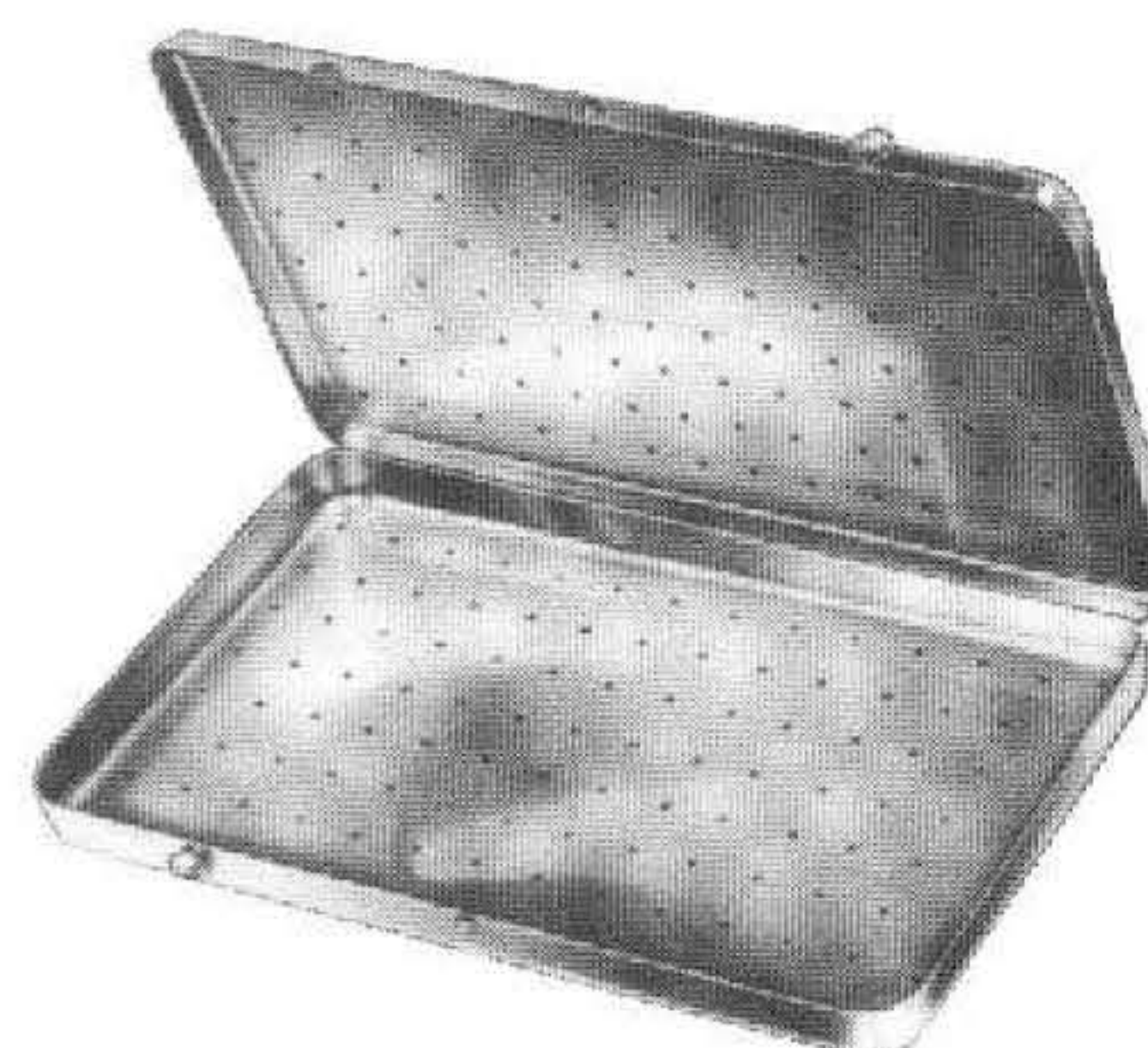

**UG-513**  
150 x 95 x 13 mm

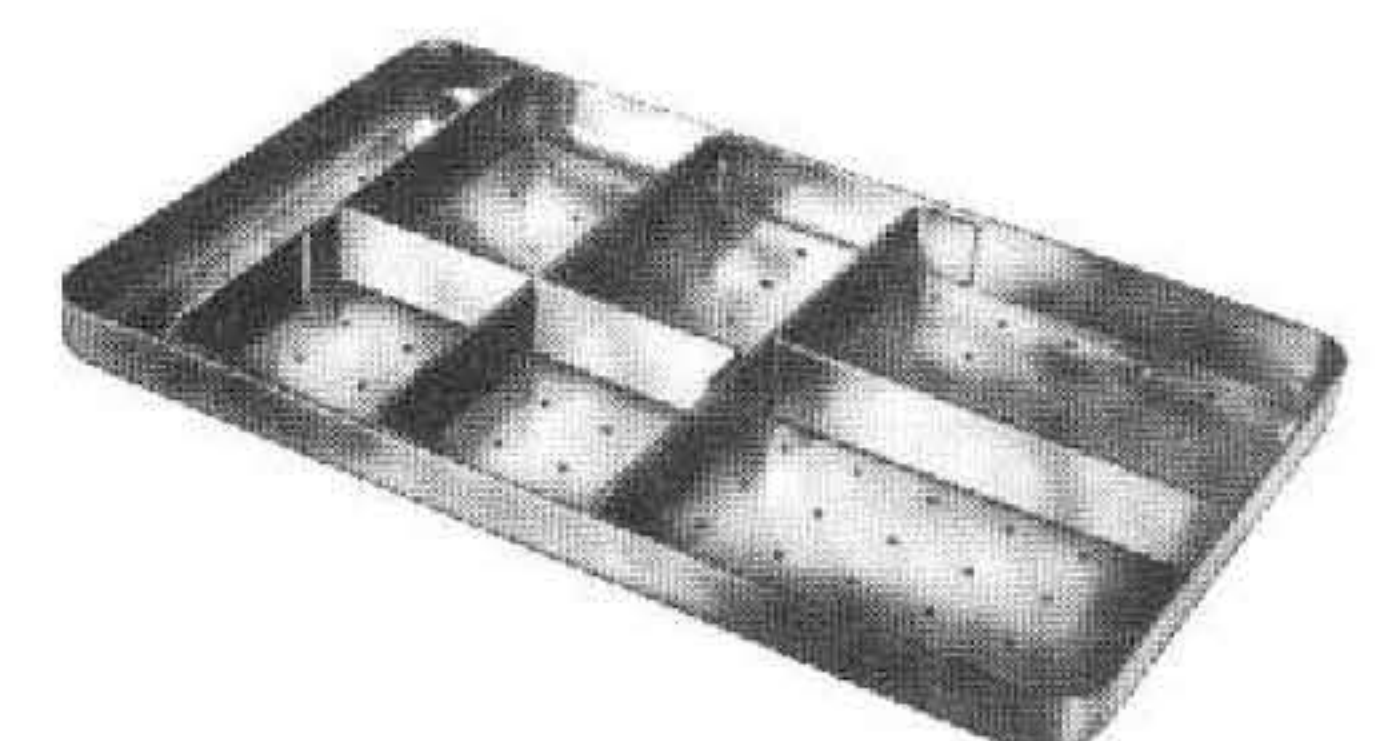

**UG-514**  
150 x 95 x 11 mm

## Storing Cases



**27-196**  
Deponette  
245 x 135 x 35mm

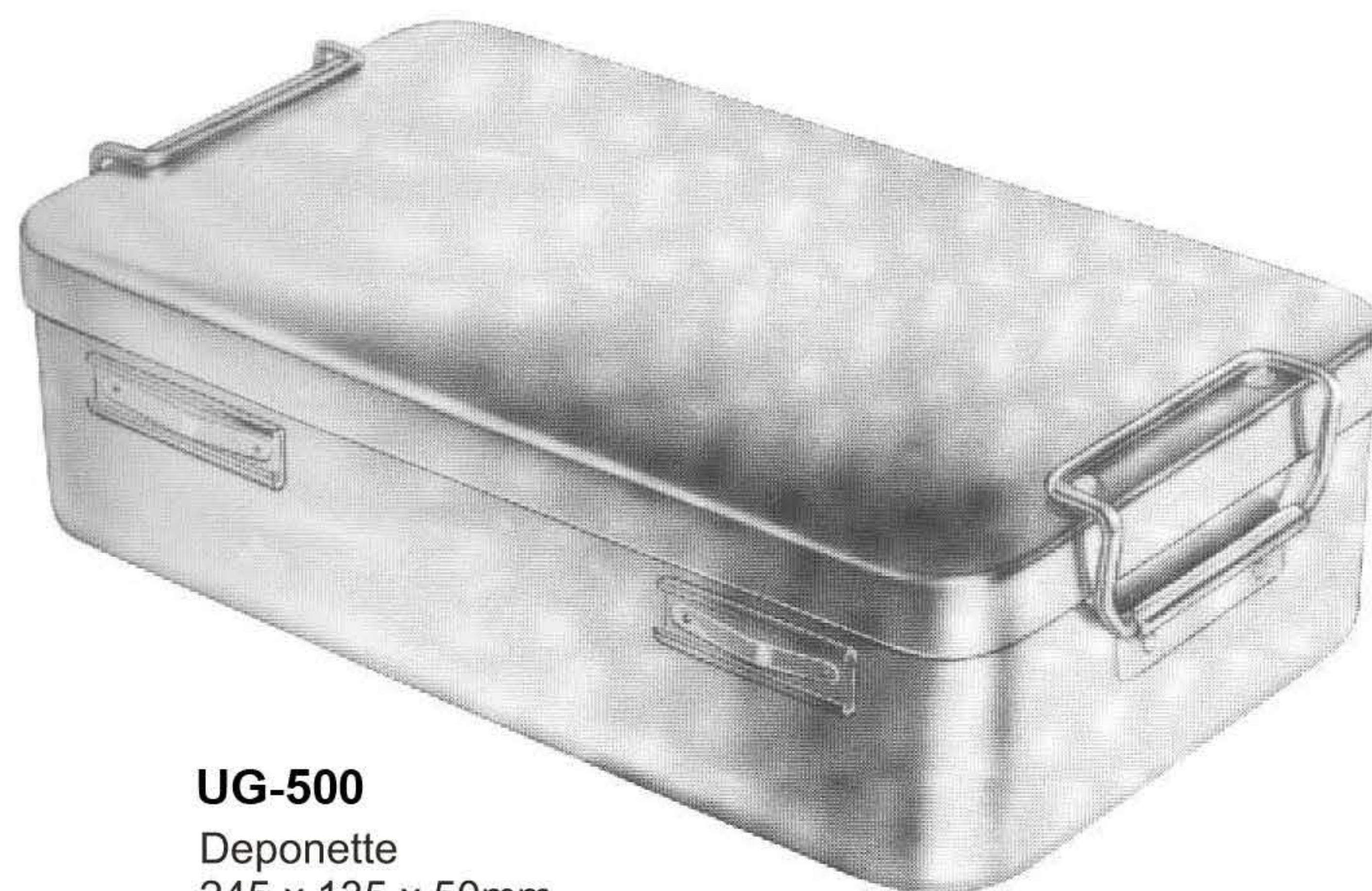

**UG-500**  
Deponette  
245 x 135 x 50mm



**UG-501**  
Deponette  
245 x 135 x 60mm

# Storing Cases

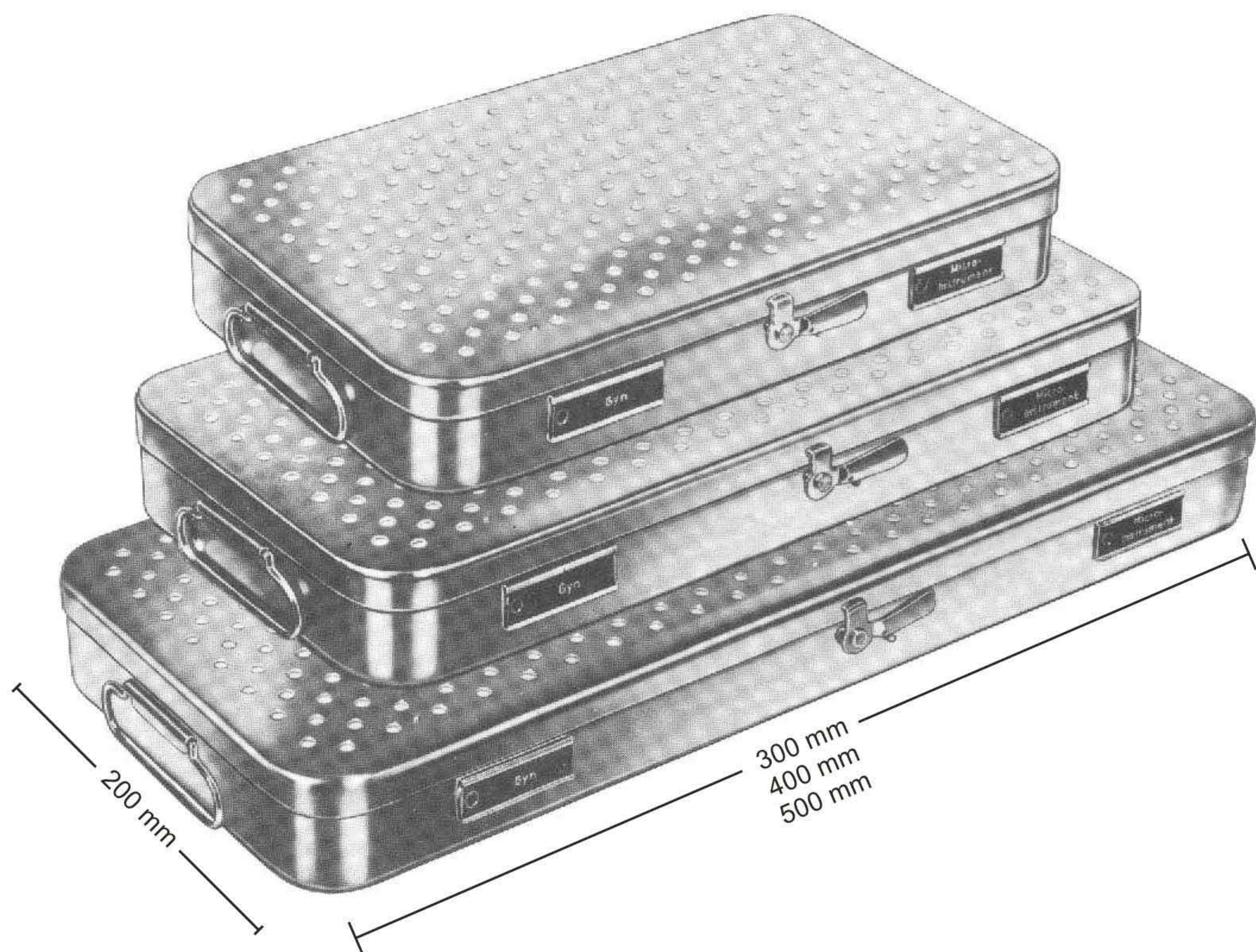

## UG-364

230 x 130 x 50 mm  
260 x 150 x 50 mm  
275 x 235 x 50 mm  
300 x 200 x 50 mm  
325 x 275 x 50 mm  
420 x 175 x 50 mm  
230 x 130 x 75 mm  
260 x 150 x 75 mm  
300 x 200 x 75 mm  
325 x 275 x 75 mm  
420 x 175 x 75 mm

## Sterilizing Baskets / Trays

---

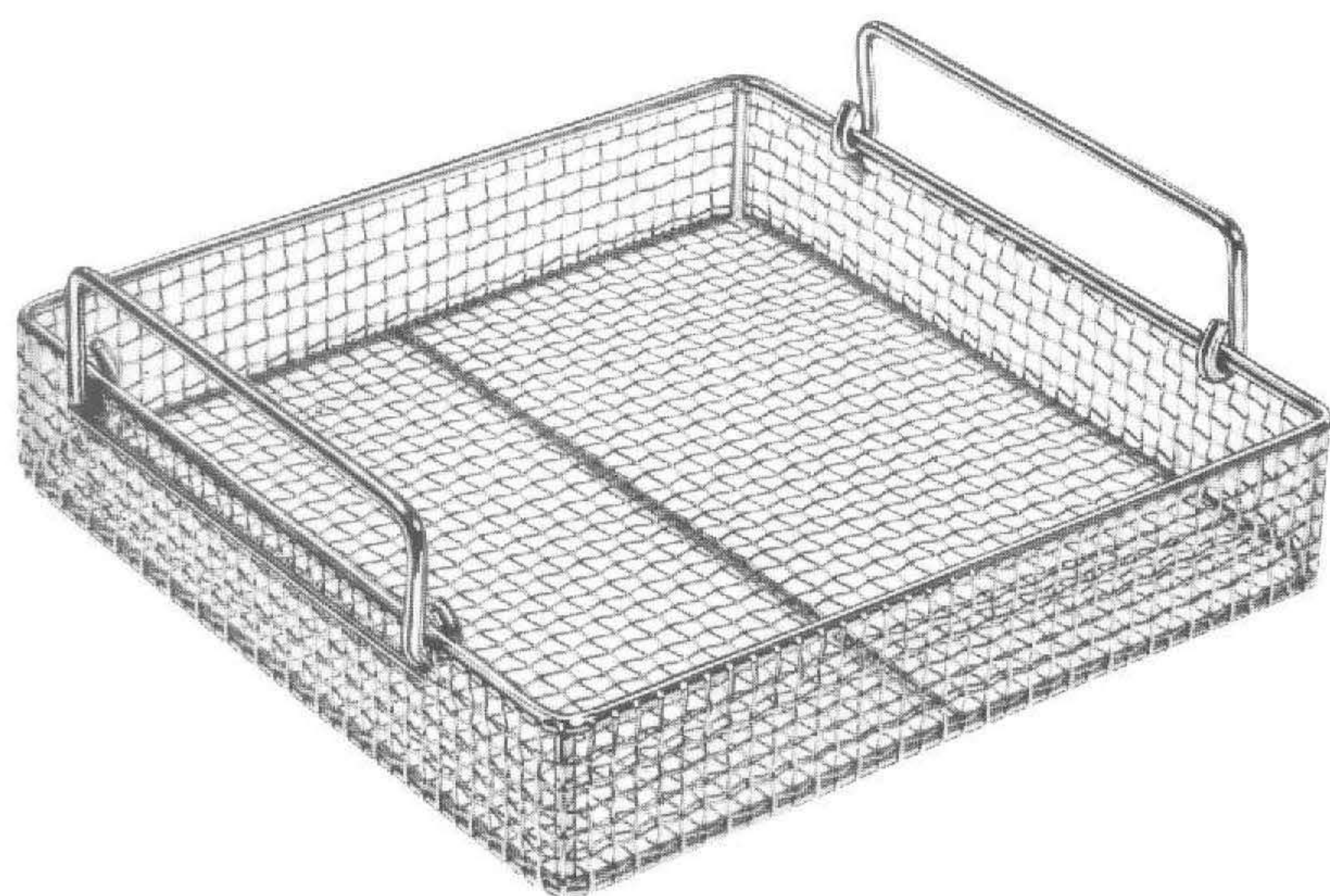

UG-349



UG-353

# Sterilizing Basket

---

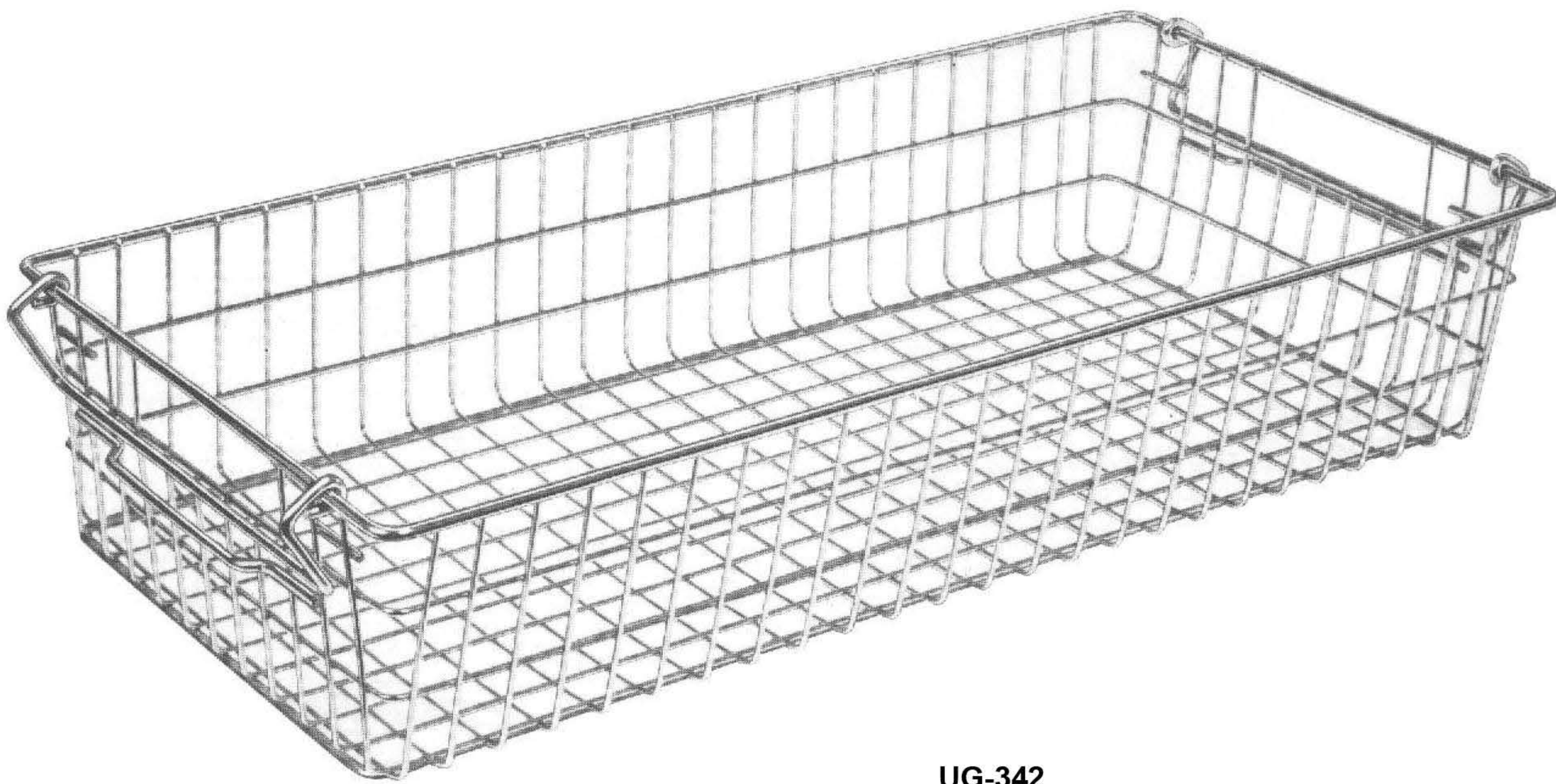

**UG-342**  
(60 x 30 x 15 cm)  
Nominal dimensions



# Sterilizing Basket

---

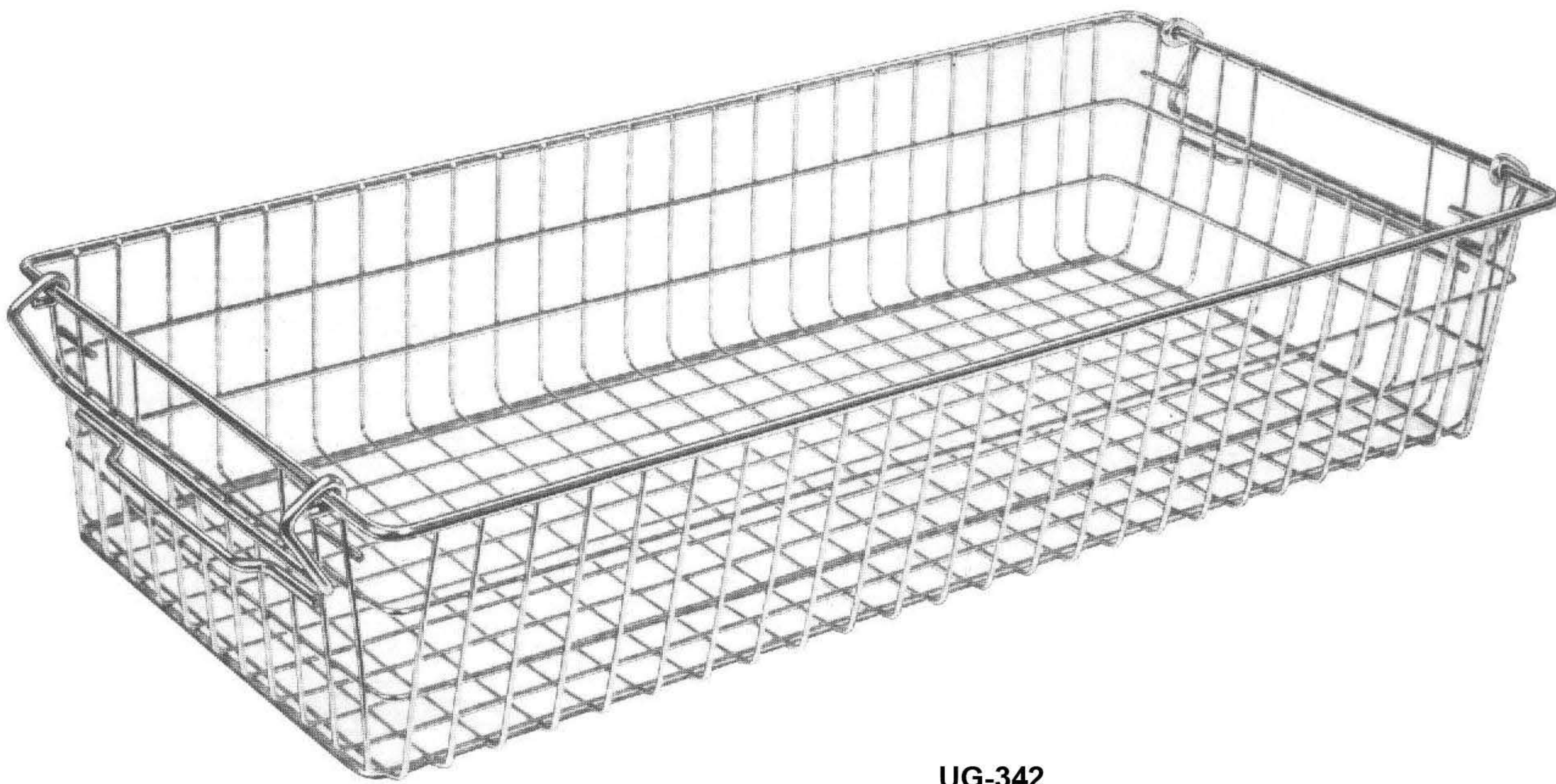

**UG-342**  
(60 x 30 x 15 cm)  
Nominal dimensions